

**The Islamic University-Gaza**  
**Deanery of Postgraduate Studies**  
**Faculty of Engineering**  
**Master of Architecture Program**



## **Studying the Microclimatic Effects of Trees on Thermal Performance of Residential Buildings in the Gaza Strip**

دراسة التأثير المناخي للأشجار على الأداء الحراري للمباني السكنية في قطاع غزة

**Prepared By**

**Shaima Jehad Hamdan ElHissi**

**Supervisor**

**Dr. Ahmed Salama Muhaisen**

**“A Thesis Submitted in Partial Fulfillment of the Requirements for the Degree of Master in Architectural Engineering, Faculty of Engineering, the Islamic University of Gaza-Palestine”**

**2012/1443**

## Abstract

A growing interest among architects and scientists to achieve energy-efficient buildings complies with increased energy demand and the international goals of creating environment-friendly buildings. The Gaza strip is one of the most growing population densities. Hence, as the population density increases rapidly, the populated built area increases too, resulting urban summer hotter and winter colder. The effects of urban heat islands, rising consumer standards through air-conditioning and electrical gadgets in buildings, and thus rising man-made CO<sub>2</sub> emissions contribute to environmental damage, public health threatening, and economic crisis. Furthermore, the Gaza Strip suffers from energy sources shortage and in the same time it faces the most serious electricity problem.

Accordingly, passive solar design techniques in modern buildings have been utilized to achieve thermal comfort by decreasing the dependence on fossil fuels as much as possible. One of the passive solar design methods is choosing suitable tree configurations near buildings. Urban trees play an important role in moderating urban climate and reducing energy demand by shading buildings in summer, thus reducing the need for energy intensive air conditioning, cooling the surrounding air through evapotranspiration and other benefits. The current study investigated the effect of trees shade on the thermal performance of residential buildings in the Gaza Strip and highlighted the best trees configurations. Accordingly, the best tree configurations (trees geometries, crown size, locations near building, and numbers) have been targeted to achieve thermal comfort in both summer and winter seasons. The analytical approach using computer simulation tools namely "DESIGNBUILDER and ECOTECH" were utilized to carry out the study.

The research concluded that choosing the optimum trees configuration depends on many factors including site orientation, building shape, soil type, tree shape and foliage, and the number and location of trees. It was found that the value of cooling loads reduction as a result of changing deciduous trees form can be ordered from the highest to the lowest as follow: vase tree, high trunk umbrella, rounded and oval. It was concluded also that shading the east side of building provides the maximum energy savings in summer and winter followed by west side and south side consequently. However, west side is the most important to shade because the need of tree shading afternoon is more important than that in the early morning. On the other side, the closer tree and larger to home, the more shade it provides. Besides that, it was observed that choosing the optimum trees number and locations can reduce annual energy consumption by about 10%-18%. The effect of trees on reducing energy loads increases as building orientations change from 0-North to 45-North. Also, North-South street orientation is more affected by trees shade in summer than other orientation, while East-West street orientation is more affected by trees shade in winter. Therefore, the research recommended choosing trees configurations according to scientific standards that comply with energy consumption reduction and environment conditions. It is important to take into consideration trees types, locations, maturity size, height and number when using trees.

## المخلص

تزايد اهتمام العلماء والمعماريين لتحقيق مباني موفرة للطاقة، بحيث تقلل من الاستهلاك المتزايد لها ، و تتوافق مع التطورات العالمية في خلق مباني صديقة للبيئة . قطاع غزة يعد من أكثر المناطق المتزايدة سكانيًا وبالتالي فإن تزايد الكثافات السكانية بشكل متسارع ، ينتج عنه تزايد في الكثافات البنائية، مسببة صيفا أشد حرارة وشتاء أشد برودة . حيث يساهم التأثير الحراري للجذر الحرارية والإستهلاك الكبير لأجهزة التكييف والأجهزة الكهربائية في المنازل، وارتفاع نسبة انبعاثات غاز ثاني أكسيد الكربون، في خراب البيئة، ويهدد صحة البشر، بالإضافة إلى تسببه بخلق أزمات اقتصادية، ومشاكل في الطاقة. بجانب ذلك يعاني قطاع غزة من نقص حاد في مصادر الطاقة، مما يجعلها من أكثر المناطق التي تواجه مشاكل خطيرة في توليد الكهرباء.

و تستخدم تقنيات التصميم الشمسي السلبي في المباني الحديثة لتحقيق الراحة الحرارية وتقليل الاعتماد على طاقة الوقود الأحفوري قدر الإمكان. أحد أهم هذه التقنيات هي الاختيار المناسب للأشجار بجانب المباني، حيث يلعب الشجر دورا مهما في تلطيف المناخ وتقليل الحاجة لطاقة أجهزة التكييف، عن طريق توفير الظلال في فصل الصيف، وتبريد البيئة المحيطة بما يقوم به من عمليات التبخر والنتح، وغير ذلك. ولذلك يركز هذا البحث على دراسة تأثير الأشجار على الأداء الحراري للمباني السكنية في قطاع غزة، بحيث تسلط الضوء على التكوينات الأفضل للشجر. ولذلك تسعى هذه الدراسة إلى إيجاد أفضل تكوين للأشجار شاملة شكل الشجرة وحجمها وموقعها وعددها بما يحقق أفضل راحة حرارية في فصل الشتاء والصيف. وبالتالي فإن الدراسة اعتمدت على المنهج التحليلي بالاستعانة ببرامج المحاكاة الحرارية DESIGNBUILDER و ECOTECT.

تبين من الدراسة أن اختيار أفضل تكوين للأشجار يعتمد على عدد من العوامل المتمثلة في توجيه الموقع، وشكل المبنى، وشكل الشجرة ونوعها وموضعها وعددها حول المبنى. حيث وجد أن التقليل في طاقة التبريد من الأعلى إلى الأقل كنتيجة لاختلاف شكل الأشجار المتساقطة الأوراق يبدأ بالأشجار التي تتشكل بشكل حرف ( V )، ومن ثم الأشجار المظلية، فالأشجار الدائرية والبيضاوية . كما استنتج من الدراسة أن تظليل الجهة الشرقية للمبنى يحقق أعلى نسبة في تقليل استهلاك الطاقة صيفا وشتاء ومن ثم الجهة الغربية والجنوبية، وعلى الرغم من ذلك فإن الواجهة الغربية هي الأكثر حاجة للتظليل في فصل الصيف بسبب الحاجة لتأثير الأشجار في فترة ما بعد الظهر أكثر من الصباح الباكر. تبين من الدراسة أيضا أنه كلما اقتربت الشجرة من المبنى أو كبر حجمها ، كلما كانت أقدر على توفير ظلال أكثر. ووجد أن تقليل ما يقرب من 10-18% من الاستهلاك السنوي للطاقة يتحقق عن طريق الاختيار الأمثل لعدد الأشجار وزراعتها بالاتجاه المناسب. كما استنتج أن تأثير الأشجار على حالات مختلفة من المباني يتغير كلما تغير توجيه المبنى وارتفاعه. كما بينت الدراسة أن توجيه الشارع شمال-جنوب هو أكثر الشوارع استجابة لتأثير الأشجار. لذلك يوصي هذا البحث مراعاة زراعة الأشجار الصحيحة في المكان الصحيح تبعاً لمعايير علمية تكفل تحقيق أفضل تقليل لأحمال الطاقة ولا تضر بالبيئة مع الأخذ بعين الاعتبار حالة المباني وتكوينات الشجر الأفضل لكل حالة.

## **Dedication**

I dedicate this work to my family who gave me continuous support along my educational period... Especially to my parents who instilled the importance of education in me and the determination to pursue my goals..... Whom I am forever grateful for their love and patience...the work is dedicated also, to my husband who I deeply love.

## **Acknowledgement**

In the first place.....My deep thanks to Allah.....His generosity and bountifulness, the bulk of the credit help me to complete this work.

I am grateful to my supervisor Dr. Ahmed Muhaisen for patiently listening and offering valuable advice throughout the research process. For his help and encouragement since I have started; for guidance and wisdom during this research; for keeping me focus while navigating through numerous obstacles.

Another big thank goes to Department of Architectural Engineering in Islamic university...I am eternally grateful for its teaching staff help, support, and encouragement.

I owe special thanks to engineering office in the Islamic university, to Eng. Mohammed Al-Hennawei who has graciously served me and offered valuable insight to this research.

## List of Contents

<b>Abstract</b> .....	I
<b>المخلص</b> .....	II
<b>Dedication</b> .....	III
<b>Acknowledgements</b> .....	IV
<b>List of Contents</b> .....	V
<b>List of Tables</b> .....	X
<b>List of Figures</b> .....	XII
<b>List of Abbreviations and Acronyms</b> .....	XXI
<b>Chapter 1: General</b> .....	1
1.1 Introduction.....	1
1.2 Problem Statement.....	2
1.3 Hypothesis.....	2
1.4 Importance of Study.....	3
1.5 Aims of Study.....	3
1.6 Methodology.....	3
1.7 Limits of Study.....	4
1.8 Sources of Study.....	5
1.9 Study Outline.....	5
1.10 Previous Studies.....	5
1.11 Conclusion.....	9
<b>Chapter 2: Global Environmental Challenges and Assessment of the Gaza Strip Situation</b> .....	<b>10</b>
2.1 Introduction.....	10
2.2 Definitions of Climate, Weather and Microclimate.....	10
2.3 Factors Influencing Urban Microclimate.....	11
2.3.1 Climate Change, Global Warming and Greenhouse Gas Effect.....	11

2.3.2 Urban Heat Island (UHI).....	12
2.3.3 Environment Pollution.....	14
2.4 Overview on The Gaza Strip Situation.....	16
2.4.1 Location and Topography.....	16
2.4.2 Population Density.....	17
2.4.3 General Characters of Urban Geometry in Gaza.....	17
2.4.4 Climate.....	18
2.4.5 Environment issues.....	20
2.5 Energy Consumption Trend in the Buildings.....	20
2.5.1 Resources of Energy Used in Buildings.....	21
2.5.2 Reasons and Consequences of Increasing Energy Consumption in Buildings.....	21
2.5.3 Energy Situation in the Gaza Strip.....	22
2.6 Reducing Energy Consumption and Achieving Human comfort in Buildings.....	24
2.6.1 Definitions.....	24
2.6.2 Factors Influencing Human Comfort Inside Buildings.....	25
2.7 Passive Solar Design.....	27
2.7.1 Definitions.....	28
2.7.2 Passive solar Design Types.....	28
2.7.3 Passive solar Design Techniques in Buildings.....	30
2.8 Conclusion.....	31
<b>Chapter 3: The Effect of Trees on Buildings Microclimate.....</b>	<b>32</b>
3.1 Introduction.....	32
3.2 Trees Identification.....	32
3.3 Benefits of Trees.....	33
3.3.1 Air Quality.....	34
3.3.2 Carbon Storage and Sequestration.....	34

3.3.3 Energy Conservation.....	35
3.3.4 Economic benefits.....	35
3.3.5 Water Conservation and Storm Water Management.....	36
3.3.6 Wildlife and Biodiversity Conservation.....	37
3.3.7 Noise Reduction.....	37
3.3.8 Human Health Conservation.....	37
3.4 Trees as Natural Microclimate Modifications.....	38
3.4.1 Solar Radiation Modification.....	38
3.4.2 Wind Modification.....	39
3.4.3 Temperature Modification.....	40
3.4.4 Humidity Modification.....	41
3.5 Tree Planting Considerations.....	41
3.5.1 Site Characteristics and Site Layout.....	41
3.5.2 Choose Desirable Trees Attributes.....	43
3.5.3 Diversity of Tree Species.....	47
3.6 Trees in the Gaza Strip.....	47
3.6.1 Assessment of Planting Trees in Buildings Complexes and Street of Gaza.....	47
3.6.2 The Most Common Planted Trees around Buildings Complexes and Streets of Gaza.....	49
3.7 Conclusion.....	51
<b>Chapter4: The Effect of Tree Shade on the Thermal Performance of Residential Buildings.....</b>	<b>52</b>
4.1 Introduction.....	52
4.2 Simulation Tools and Validity.....	52
4.2.1 DESIGNBUILDER.....	53
4.2.2 ECOTECT.....	54
4.3 General Parameters.....	54



4.3.1 Climatic Parameters.....	54
4.3.2 Building Parameters.....	54
4.3.3 Thermal Analysis Parameters.....	56
4.3.4 General Trees Configurations Parameters.....	57
4.4 The Effect of Trees Geometries on Energy Consumption.....	58
4.4.1 Parametric Investigation.....	58
4.4.2 Simulation Results.....	59
4.5 The Effect of Changing Distances and Locations of Planting Trees on Energy Consumption.....	70
4.5.1 Parametric Investigation.....	71
4.5.2 Simulation results.....	72
4.6 The Effect of Increasing Trees Crowns Size on Energy Consumption.....	82
4.6.1 Parametric Investigation.....	82
4.6.2 Simulation results.....	82
4.7 The Effect of Increasing Trees Number on Energy Consumption.....	85
4.7.1 Parametric Investigation.....	85
4.7.2 Simulation results.....	87
4.8 The Effect of Trees shade on Energy Consumption for Different Building Cases .....	92
4.8.1 Parametric Investigation.....	92
4.8.2 Simulation results.....	92
4.9 Conclusion.....	98
<b>Chapter 5: Microclimatic Effects of Street Trees.....</b>	<b>99</b>
5.1 Introduction.....	99
5.2 The Effect of Street Trees Crown Geometry on Energy Consumption.....	99
5.2.1 Parametric Investigation.....	100
5.2.2 Simulation Results.....	101
5.3 The Effect of Street Trees Size and Height on Energy Consumption.....	107

5.3.1 Parametric Investigation.....	107
5.3.2 Simulations Results.....	108
5.4 The Effect of potential Street Trees Lines Number on Energy Consumption.....	114
5.4.1 Parametric Investigation.....	114
5.4.2 Simulations Results.....	115
5.5 The Effect of Street Trees on Energy Consumption of Building for Different Street Orientations.....	120
5.5.1 Parametric Investigation.....	120
5.5.2 Simulations Results.....	121
5.6 Conclusions.....	123
<b>Chapter 6: Conclusions.....</b>	<b>125</b>
6.1 Recommendations.....	130
<b>References.....</b>	<b>132</b>
<b>Appendices.....</b>	<b>142</b>

## List of Tables

Table (3.1): Trees functions.....	44
Table (3.2): Trees species diversity in the Gaza Strip.....	49
Table (4.1): Simulation Tools Features.....	52
Table (4.2): Building elements and materials features in Gaza.....	55
Table (4.3): Thermal analysis parameters.....	56
Table (4.4): Tree Geometries Scenarios parameters.....	58
Table (4.5) Energy saving in summer for different deciduous trees types.....	69
Table (4.6) Energy consumption in winter for different deciduous trees types.....	69
Table (4.7) Annual energy saving for different deciduous trees types.....	70
Table (4.8): Changing single tree location with changing window locations.....	72
Table (4.9): The relationship between incident solar radiation angel and solar radiation percentage.....	78
Table (4.10) The effect of changing locations of single tree on east façade with different of single window on energy consumption.....	80
Table (4.11): Tree number parameter combination.....	86
Table (4.12): Trees number and its locations possibilities.....	87
Table (4.13): Energy saving by different number of vase tree on different locations.....	89
Table (4.14): Energy consumption by different number of vase tree on different locations.....	91
Table (4.15): The effect of increasing number of vase tree on total loads.....	91
Table (4.16): The effect of increasing number of vase tree on total loads reduction.....	91
Table (5.1): Street parameters case in the study.....	101
Table (5.2): Trees crown geometries parameters.....	101
Table (5.3): Trees locations parameters.....	101
Table (5.4): Multiple trees rows locations parameters.....	114
Table (5.5): Different street tree locations possibilities.....	115

Table (5.6) Energy saving percents in summer for multiple planting locations.....	118
Table (5.7) Solar gain reduction percents in summer for multiple planting locations.....	118
Table (5.8) Energy consumption percents in winter for multiple planting locations.....	119
Table (5.9) Annual energy loads (KWh).....	119
Table (5.10) Annual energy reduction.....	120
Table (5.11): Street orientations parameters.....	120

## List of Figures

Figure (2.1): The greenhouse effect.....	11
Figure (2.2): Thermal behavior of urban areas and rural surrounding.....	13
Figure (2.3): Sketch of a typical heat island profile illustrate summer temperatures in urban areas.....	13
Figure (2.4): Temperature of Japan cities-a case of urban heat island.....	14
Figure (2.5): Effects of pollution on human health.....	15
Figure (2.6): Global distribution of deaths from urban air pollution.....	16
Figure (2.7): The Gaza Strip plan.....	17
Figure (2.8): Street and parcels orientations in the Gaza Strip.....	18
Figure (2.9): Climate zones of the world according to Köppen classification.....	18
Figure (2.10): The annual average temperature (C°) in the Gaza Strip.....	19
Figure (2.11): The annual average relative humidity (%) in the Gaza Strip.....	19
Figure (2.12): The annual average wind speed (m/s) in the Gaza Strip.....	20
Figure (2.13): Primary energy consumption, CO2 emissions and world population from 1984 to 2004.....	20
Figure (2.14): U.S. energy types in buildings.....	21
Figure (2.15): The percentage of consuming imported Energy by sectors in 2005.....	22
Figure (2.16): The electricity load required for Gaza Strip until year 2010.....	23
Figure (2.17): Electricity consumption in Palestine territory (GWh) from 1994-2005.....	23
Figure (2.18): Energy Consumption in Residential Sector by Fuel (2001-2005)..	24
Figure (2.19): Factors influencing human comfort inside buildings.....	27
Figure (2.20): Psychometric chart.....	27
Figure (2.21): Tromb walls and sun space are an example of passive solar heating.....	29
Figure (2.22): Night ventilation is one type of passive solar cooling.....	29
Figure (3.1): Parts of tree.....	33

Figure (3.2): Benefits of trees.....	33
Figure (3.3): Sketch for trees functions in reducing CO2 directly and indirectly..	35
Figure (3.4): Deciduous trees behavior during summer and winter.....	35
Figure (3.5): Trees roots hold soil in place and increase water infiltration.....	37
Figure (3.6): Leaf absorption, reflection, and transmitted.....	38
Figure (3.7): Effect of group of trees on wind speed and wind direction.....	40
Figure (3.8): Evapo-transpiration process in plants.....	40
Figure (3.9): Relationship between trees size, distance, and power lines.....	43
Figure (3.10): Diversity of trees size (height and spread).....	44
Figure (3.11): Diversity of tree crowns and its shading forms.....	45
Figure (3.12): Tree roots extensions in the ground.....	45
Figure (3.13): Crowded urban clusters in Gaza.....	48
Figure (3.14): Planting street trees in Gaza.....	48
Figure (4.1): DESIGNBUILDER software interface.....	53
Figure (4.2): Original case of residential building.....	55
Figure (4.3): Trees configurations diagram.....	57
Figure (4.4): A: Total cooling loads (KWh) and B: energy saving percent for the effect of different tree geometries (first scenario).....	60
Figure (4.5): A: Total cooling loads (KWh) and B: energy saving percent for the effect of different tree geometries (first scenario) by ECOTECT.....	60
Figure (4.6): A: Incident solar radiation (KWh) and B: Incident solar radiation reduction percent for the effect of different tree geometries (first scenario).....	61
Figure (4.7): A: Surface gain (KWh) and B: surface gain reduction percent for the effect of different tree geometries (first scenario).....	61
Figure (4.8): Sun path diagram from ECOTECT.....	62
Figure (4.9): the effect of thermal mass of heavy building materials during day and night.....	62
Figure (4.10): Diagram illustrating thermal mass mechanism.....	62
Figure (4.11): Sun path during summer and winter.....	63

Figure (4.12): The effect of tree geometries on increasing energy consumption in winter, A: by DESIGNBUILDER and B: by ECOTECT.....	64
Figure (4.13) the comparison between the effect of evergreen tree and deciduous tree on blocking incident solar radiation in first scenario.....	64
Figure (4.14): A: Total cooling loads (KWh) and B: energy saving percent for the effect of different tree geometries (second scenario).....	65
Figure (4.15): A: trees forms in first scenario and B: trees forms in second scenario.....	65
Figure (4.16): A: Incident solar radiation (KWh) and B: Incident solar radiation reduction percent for the effect of different tree geometries (second scenario)....	66
Figure (4.17): A: Surface gain (KWh) and B: surface gain reduction percent for the effect of different tree geometries (second scenario).....	66
Figure (4.18): The effect of tree geometries on A: increasing energy consumption and B: increasing incident solar radiation reduction percents in winter.....	67
Figure (4.19): A: Total cooling loads (KWh) and B: Energy saving percent for the effect of different tree geometries (third scenario).....	67
Figure (4.20): A: Incident solar radiation (KWh) and B: Incident solar radiation reduction percent for the effect of different tree geometries (third scenario).....	68
Figure (4.21): A: Surface gain (KWh) and B: surface gain reduction percent for the effect of different tree geometries (third scenario).....	68
Figure (4.22): The effect of tree geometries on A: increasing energy consumption and B: increasing incident solar radiation reduction percents in winter.....	69
Figure (4.23): Increasing tree distances parameters combination.....	71
Figure (4.24): Changing a single tree location on each façade alone.....	71
Figure (4.25): The effect of increased distances of vase tree on A: cooling loads, B: energy saving in summer.....	72
Figure (4.26): The effect of increased distances of rounded tree on A: cooling loads, B: energy saving in summer.....	72
Figure (4.27): The effect of increased distances of umbrella tree on A: cooling loads, B: energy saving in summer.....	73
Figure (4.28): The effect of increased distances of one tree on A: cooling loads, B: energy saving in summer by ECOTECT.....	73

Figure (4.29): The effect of increased distances of vase tree on A: incident solar radiation, B: radiation reduction percents.....	74
Figure (4.30): The effect of increased distances of rounded tree on A: incident solar radiation, B: radiation reduction percents.....	74
Figure (4.31): The effect of increased distances of umbrella tree on A: incident solar radiation, B: radiation reduction percents.....	74
Figure (4.32): The effect of increased distances of vase tree on A: surface gain, B: gain reduction percents.....	74
Figure (4.33): The effect of increased distances of rounded tree on A: surface gain, B: gain reduction .....	75
Figure (4.34): The effect of increased distances of umbrella tree on A: surface gain, B: gain reduction .....	75
Figure (4.35): The effect of increased distances of vase tree on A: Energy consumption in winter, B: incident solar radiation reduction .....	76
Figure (4.36): The effect of increased distances of rounded tree on A: Energy consumption in winter, B: incident solar radiation reduction .....	76
Figure (4.37): The effect of increased distances of umbrella tree on A: Energy consumption in winter, B: incident solar radiation reduction .....	76
Figure (4.38): The effect of increased distances of rounded tree on energy consumption in winter by ECOTECT.....	76
Figure (4.39): Energy savings percents in summer and solar gain reduction percents (in east façade).....	77
Figure (4.40): Energy savings percents in summer and solar gain reduction percents (in west façade).....	77
Figure (4.41): Sun path during midday in summer.....	78
Figure (4.42): Energy savings percents in summer and solar gain reduction percents (in south façade).....	79
Figure (4.43): Energy consumption percents in winter for three building façades	79
Figure (4.44): Different locations of a single tree, center of window is shifted 4m to north from center of façade.....	80
Figure (4.45): Different positions of a single tree, center of window is shifted 3m to north from center of façade.....	80
Figure (4.46): Different positions of a single tree, center of window is shifted 2m to north from center of façade.....	80



Figure (4.47): Different positions of a single tree, center of window is shifted 1m to north from center of façade.....	80
Figure (4.48): Different positions of a single tree, Window is located on the center of façade.....	81
Figure (4.49): Different positions of a single tree, center of window is shifted 1m to south from center of façade.....	81
Figure (4.50): Different positions of a single tree, center of window is shifted 2m to south from center of façade.....	81
Figure (4.51): Different positions of a single tree, center of window is shifted 3m to south from center of façade.....	81
Figure (4.52): Different positions of a single tree, center of window is shifted 4m to south from center of façade.....	81
Figure (4.53): Increasing trees crowns size parameters.....	82
Figure (4.54): The effect of increasing crown size of vase tree on A: cooling loads, B: energy saving in summer.....	82
Figure (4.55): The effect of increasing crown size of rounded tree on A: cooling loads, B: energy saving in summer.....	83
Figure (4.56): The effect of increasing crown size of umbrella tree on A: cooling loads, B: energy saving in summer.....	83
Figure (4.57): The effect of increasing tree crown size on A: cooling loads, B: energy saving in summer by ECOTECH.....	83
Figure (4.58): The effect of increasing crown size of vase tree on A: incident solar radiation, B: radiation reduction percents.....	84
Figure (4.59): The effect of increasing crown size of rounded tree on A: incident solar radiation, B: radiation reduction percents.....	84
Figure (4.60): The effect of increasing crown size of umbrella tree on A: incident solar radiation, B: radiation reduction percents.....	84
Figure (4.61): The effect of increasing crown size of different tree type on energy consumption percents in winter.....	85
Figure (4.62): The effect of increasing crown size of on energy consumption percents in winter by ECOTECH.....	85
Figure (4.63): The effect of two trees locations possibilities on A: total cooling loads (KWh) and B: Energy savings percents in summer.....	87
Figure (4.64): The effect of two trees locations possibilities on A: total cooling loads (KWh) and B: Energy savings percents in summer by ECOTECH.....	88

Figure (4.65): The effect of two trees locations possibilities on A: incident solar radiation amount (KWh) and B: incident solar radiation reduction percents in summer.....	88
Figure (4.66): The effect of three trees locations possibilities on A: total cooling loads (KWh) and B: Energy savings percents in summer.....	88
Figure (4.67): The effect of three trees locations possibilities on A: incident solar radiation amount (KWh) and B: incident solar radiation reduction percents in summer.....	89
Figure (4.68): The effect of two trees locations possibilities on energy consumption on summer, A: DESIGNBUILDER and B: ECOTECH.....	90
Figure (4.69): The effect of A: three trees locations possibilities and B: four trees locations possibilities on energy consumption in winter.....	90
Figure (4.70): Building orientations parameters.....	92
Figure (4.71): Building heights parameters.....	92
Figure (4.72) the effect of changing building orientations on A: total cooling loads (KWh) and B: incident solar radiation (KWh).....	93
Figure (4.73): Tree effect on, A: energy saving and B: incident solar radiation reduction percents for different building orientations in summer.....	93
Figure (4.74): Tree effect on energy saving for different building orientations in summer by ECOTECH.....	94
Figure (4.75) the effect of changing building orientations on total heating loads (KWh).....	94
Figure (4.76): Tree effect on energy saving for different building orientations in summer by A: DESIGNBUILDER and B: ECOTECH.....	95
Figure (4.77): The effect of increasing building height on A: total cooling loads (KWh) and B: incident solar radiation (KWh).....	95
Figure (4.78): The tree effect on, A: energy saving and B: incident solar radiation reduction percents for different building heights in summer.....	96
Figure (4.79): The tree effect on energy saving for different building heights in summer by ECOTECH.....	96
Figure (4.80): The tree effect on energy saving for five building stories in summer.....	96

Figure (4.81): The effect of increasing building height on total heating loads....	97
Figure (4.82): The tree effect on energy consumption in winter for different building heights, A: DESIGNBUILDER and B: ECOTECH.....	97
Figure (4.83): The tree effect on energy consumption for five building stories in winter.....	97
Figure (5.1): The Location of trees row on the street.....	100
Figure (5.2): A: Total cooling loads amount (KWh), B: Energy saving percents for different street trees shape (first scenario).....	102
Figure (5.3): A: Solar gain amount (KWh), B: Solar gain reduction percents for different street trees shape (first scenario).....	103
Figure (5.4): A: Total heating loads increasing percents, B: Solar gain reduction percents as effect of different street trees shape (first scenario).....	103
Figure (5.5): A: CO2 emissions reduction in summer, B: CO2 emissions increasing in winter, for different street trees shape (first scenario).....	104
Figure (5.6): A: Total cooling loads amount (KWh), B: Energy saving percents for different street trees shape (second scenario).....	105
Figure (5.7): A: Solar gain amount (KWh), B: Solar gain reduction percents for different street trees shape (second scenario).....	105
Figure (5.8): A: Total heating loads increasing percents, B: Solar gain reduction percents for different street trees shape (second scenario).....	106
Figure (5.9): A: CO2 emissions reduction in summer, B: CO2 emissions increasing in winter, for different street trees shape (second scenario).....	106
Figure (5.10): Changing tree crown volume size with fixed trunk height.....	107
Figure (5.11): Changing tree trunk height with fixed crown volume size.....	107
Figure (5.12): A: Total cooling loads amount (KWh), B: Energy saving percents for different trees crown size located in (I-E).....	108
Figure (5.13): A: Total cooling loads amount (KWh), B: Energy saving percents for different trees crown size located in (NP-W).....	108
Figure (5.14): A: Total cooling loads amount (KWh), B: Energy saving percents for different trees crown size located in (SP-E).....	109
Figure (5.15): A: Solar gain amount (KWh), B: Solar gain reduction percents for different trees crown size located in (I-E).....	109

Figure (5.16): A: Solar gain amount (KWh), B: Solar gain reduction percents for different trees crown size located in (NP-W).....	109
Figure (5.17): A: Solar gain amount (KWh), B: Solar gain reduction percents for different trees crown size located in (SP-E).....	110
Figure (5.18): A: Total heating loads increasing percents, B: Solar gain reduction percents in winter for different trees crown size located in (I-E).....	110
Figure (5.19): A: Total heating loads increasing percents, B: Solar gain reduction percents in winter for different trees crown size located in (NP-W).....	110
Figure (5.20): A: Total heating loads increasing percents, B: Solar gain reduction percents in winter for different trees crown size located in (SP-E).....	111
Figure (5.21): A: CO2 emissions reduction percents in summer, B: CO2 emissions reduction percents in winter for different trees crown size located in (I-E).....	111
Figure (5.22): A: CO2 emissions reduction percents in summer, B: Solar gain reduction percents in winter for different trees crown size located in (NP-W)....	112
Figure (5.23): A: CO2 emissions reduction percents in summer, B: Solar gain reduction percents in winter for different trees crown size located in (SP-E).....	112
Figure (5.24): A: Total cooling loads amount (KWh), B: Energy saving percents for different trees trunk height.....	112
Figure (5.25): A: Solar gain amount (KWh), B: Solar gain reduction percents for different trees trunk height.....	113
Figure (5.26): A: Total heating loads increasing percents, B: Solar gain reduction percents in winter for different trees crown size located in (I-E).....	113
Figure (5.27): A: CO2 emissions reduction percents in summer, B: CO2 emissions reduction percents in winter for different trees crown size located in (I-E).....	114
Figure (5.28): A: Total cooling loads amount (KWh), B: Energy saving percents for multiple street trees planting locations.....	115
Figure (5.29): A: Solar gain amount (KWh), B: Solar gain reduction percents for multiple street trees planting locations in summer.....	116
Figure (5.30): A: Total heating loads increasing percents, B: Solar gain reduction percents for multiple street trees planting locations in summer.....	116
Figure (5.31): A: CO2 emissions reduction in summer, B: CO2 emissions increasing in winter, for multiple street trees planting locations in summer.....	117
Figure (5.32): The effect of planting trees for different locations possibilities on cooling loads reduction, A: Two pavements, B: Three pavements.....	118

Figure (5.33): The effect of multiple possibilities of planting trees in A: two pavements, B: Three pavements on solar gain reduction percents.....	118
Figure (5.34): The effect of multiple possibilities of planting trees in A: two pavements, B: Three pavements on energy consumption percents in winter.....	119
Figure (5.35) the effect of changing street orientations on A: total cooling loads (KWh) and B: solar gain (KWh).....	121
Figure (5.36) A: Energy saving and B: solar gain reduction percents as a result of street tree effect of different street orientations.....	121
Figure (5.37): A: Energy saving as a result of street tree effect of different street orientations.....	122
Figure (5.38) the effect of changing street orientations on total heating loads (KWh).....	122
Figure (5.39): A: Energy consumption and B: solar gain reduction percents as a result of street tree effect of different street orientations.....	123
Figure (5.40): A: Energy saving as a result of street tree effect of different street orientations.....	123

### List of Abbreviations

<b>LAD:</b>	Leaf Area Density
<b>LAI:</b>	Leaf Area Index
<b>T<sub>mrt</sub>:</b>	Radiant temperature
<b>CO:</b>	Carbon Oxide
<b>CO<sub>2</sub>:</b>	Carbon Dioxide
<b>O<sub>3</sub> :</b>	Ozone
<b>UHI:</b>	Urban Heat Island
<b>NO<sub>x</sub>:</b>	Nitrogen Oxide
<b>PVC:</b>	Polyvinyl chloride
<b>CIBSE:</b>	Chartered Institution of Building Services Engineers
<b>EIA:</b>	International Energy Agency
<b>IPCC:</b>	Intergovernmental Panel on Climate Change
<b>VOCs:</b>	Volatile Organic Compounds
<b>LPG:</b>	Liquefied Petroleum Gas
<b>EPA:</b>	Environment Protection Agency
<b>NREL:</b>	National Renewable Energy Laboratory
<b>WMO:</b>	World Metrological Organization
<b>WHO:</b>	World Health Organization
<b>WEA:</b>	Weather Data File used by ECOTECT
<b>EPW:</b>	Energy Plus Weather data
<b>TMY:</b>	Typical Metrological Year
<b>IWEC:</b>	International Weather for Energy Calculations
<b>CSV:</b>	Comma-Separated-Value
<b>PET:</b>	Physiologically Equivalent Temperature
<b>SPS:</b>	Shadow Patterns Simulator
<b>BLAST:</b>	Basic Local Alignment Search Tool
<b>DOE-2:</b>	Building Energy Use and Cost Analysis Software

### List of Acronyms

<b>I:</b>	Street Island
<b>I-C:</b>	On Island in front of building center
<b>I-E:</b>	On Island in front of east edge of building
<b>I-W:</b>	On Island in front of west edge of building
<b>NP:</b>	North Pavement
<b>NP-C:</b>	On North Pavement in front of building center
<b>NP-E:</b>	On North Pavement in front of east edge of building
<b>NP-W:</b>	On North Pavement in front of west edge of building
<b>SP:</b>	South Pavement
<b>SP-C:</b>	On South Pavement in front of building center
<b>SP-E:</b>	On South Pavement in front of east edge of building
<b>SP-W:</b>	On South Pavement in front of west edge of building
<b>E-W:</b>	East West axis
<b>N-S:</b>	North South axis
<b>NE-SW:</b>	Northeastern –Southwestern axis
<b>NW-SE:</b>	Northwestern-Southeastern axis
<b>EP:</b>	East Pavement
<b>WP:</b>	West Pavement
<b>NWP:</b>	Northwestern Pavement
<b>SEP:</b>	Southeastern Pavement
<b>NEP:</b>	Northeastern Pavement
<b>SWP:</b>	Southwestern Pavement

## Chapter 1: General

### 1.1 Introduction

A climate change induced by the emissions of green house gases is increasingly becoming the focus of the world. It is significant potential to affect the integrity of our ecosystems, health and human welfare, (Guan, 2009). A green house effect resulting from the increasing use of fossil fuels and deforestation together have raised atmospheric CO<sub>2</sub> concentration some 25% over the last 150 years and thus have caused global warming, (Akbari, 2002). Global warming is known as increasing in the average temperature of the earth near the surface air and the oceans. Since the mid-twentieth century, a global surface temperature increased  $0.74 \pm 0.18 \text{C}^\circ$  during the 100 years ended in 2005, (Trenberth et al., 2007). Also, increasing air temperature is closely connected with the increasing of the urban heat islands that increases through expansion of populated area. The heat island is small in daytime and increases rapidly after sunset and takes 3-5 h to reach the maximum. This is due to re-emission of absorbed heat by impervious surfaces after sunset, (Giridharan et al., 2005). The cities now are warmer than their suburban and rural surrounding and this traditionally has been coupled with the increased demand for the electricity, (Akbari et al., 1990).

The Gaza Strip as a part of the world with high population density suffers from climate changing. Hence, it affects the people inside their houses, and contributes to increase the energy consumption through air-conditioning and other cooling means. Furthermore, Gaza has limited energy sources and it faces the most serious electricity shortage. It depends on imported electricity and fossil fuels with high prices in the face of bad economic conditions of the Palestinians. Many families face energy bills two or three times higher than they were few years ago and many of Palestinians find themselves dealing with rolling blackouts by spending some of their salaries in alternative solutions. (Muhaisen, 2007)

The obvious solution to these energy and environment problems is following more natural passive solar design techniques that integrate with sustainable developments. Microclimates can be modified to enhance human comfort levels thereby using less energy. Through passive solar design, architects can use the warmth of the sun, cooling and warming of air currents, and shade to create microclimates that make indoor-outdoor more comfortable and usable year around. Both shade and allowing solar radiation into buildings will substantially lower the dependence on fossil fuels consumption through lowering required heating and cooling energy. Specifically, urban trees play important role to improve environmental quality, and physical and social health of communities.

Generally, urban vegetation can directly and indirectly affect local and regional air quality by altering the urban atmospheric environment. Trees and other green areas contribute to lower temperature 5-9 F ((-15)-(-12) C°), thus trees can reduce atmospheric carbon dioxide (CO<sub>2</sub>) in two ways: trees directly store CO<sub>2</sub> as woody and leafy biomass while they grow. Also, trees around buildings can reduce the demand for heating and air conditioning, thereby reducing emissions associated with electric power production, (McPherson et al., 2001). In more specific, Trees are an integral part of the urban ecosystem. They are one of the tools that can be used to shade our homes in summer and shelter us from harsh winter winds. The estimates indicate that trees shade

could reduce an air conditioning bills by up to 25%, thus proper tree placement near building is critical to achieve maximum building conservation benefits, (Minnesota Department of Commerce Energy Information Center, 2012). So, the current study investigated the effect of trees on the thermal performance of residential buildings in the Gaza Strip and to highlight the best trees configurations. Trees geometries, crown size, locations near building, and numbers were targeted to achieve thermal comfort in both summer and winter seasons. Also, different buildings and streets cases were simulated to study the effects of trees configurations on each case. A computerized simulation programs including DESIGNBUILDER and ECOTECH were used as an investigation tools for thermal performance. Total cooling and heating loads, incident solar radiation, solar gain and fabric gain are the main analytical indicators on the thermal behavior of buildings that used in this study.

## **1.2 Problem Statement**

According to the 2007 census of population density in the Gaza strip, the growing population increase by about 38.5% during the decade between the end of 1997 and 2007 with 3.8% as an average annual population growth, (Ajuni, 2010). Therefore, the rapidly increasing of population density leads to the increasing of populated built area and thus increasing temperature in urban area. Besides, it is widely known that increasing of human activities result in increasing CO<sub>2</sub> emissions and energy consumption.

Also, the heating, cooling and lightening of buildings, directly through burning of fossil fuels and indirectly through the use of electricity are the main source of CO<sub>2</sub> emissions, (Edwards, 2002). Air-conditioning has become increasingly used in the Gaza Strip to achieve thermal comfort levels inside buildings which alone is considered a big consumer of electricity and causes environmental problems. According to Ouda (2012), spreading of air conditioning systems in new buildings leads to annual increase of about 5.1% in conditioning, (Quda, 2012).

Also, the Gaza Strip has no available resources of electricity and fossil fuels, thus the most of electricity and fossil fuels are imported from “Israel” and Egypt with high prices, (Muhaisen, 2007). As the cost of electricity has increased in recent years, the amount of electricity usage for cooling and heating homes has become a significant expense to residents in this area.

Also, it is noticed that planting trees in the Gaza Strip doesn't take into consideration energy saving in buildings, especially with regard to the choosing the best trees configurations. Trees are planted in this area without paying attention to effects of climatic factors, especially the behavior of incident solar radiation on adjacent elements. This situation would increase energy consumption for heating and cooling. Thus, trees planting may not provide the required microclimatic benefits of buildings

## **1.3 Hypothesis**

More than 30 years ago since the sustainable development concept was firstly launched in the 1970s, there was a good understanding and establishment in literature that urban form, land use, presence of natural geographic structures, and urban/rural settings affect microclimate. Urban trees thermal behavior advantages are also, well



established and are considered as effective element to produce shadow. The current study assumes that:

- Microclimatic effect of trees contributes to improve internal thermal performance and thus reducing energy consumption of the residential environment in Gaza.
- The proper selection of trees types and locations of planting contribute to achieve thermal comfort and reduce energy consumption of the residential environment in Gaza effectively.

## **1.4 Importance of Study**

Studying the microclimatic effect of trees on thermal performance of buildings is very important because:

- There are lack of studies that examine the microclimate effects of trees on thermal performance of residential buildings in the Gaza Strip.
- The current study will use various simulation tools to help in measuring thermal comfort in relatively accurate manner and approximately close to actual performance.
- Energy consumption, temperature rising, and environmental pollution in the Gaza Strip have become more serious, which requires looking for natural methods to improve thermal performance of the houses with limited consumption of electricity.

## **1.5 Aims of Study**

The main aim of the current study is to investigate the effect of trees in creating proper external and internal microclimate conditions in residential buildings of Gaza and finding out the best possible configurations of trees to reduce consumed-energy for achieving thermal comfort. The sub objectives of study are to investigate the following:

- The global environment challenges and assessment of the Gaza Strip situation.
- The passive solar design solutions for environment problems and energy crisis.
- The urban trees modifications, benefits and characteristics.
- The criteria that identify tree configurations for potential planting.
- The effect of different trees configurations on energy consumption reduction of the residential buildings.
- The contribution of street trees in improving surrounding microclimate and reducing energy consumption.

## **1.6 Methodology**

In recent years, researchers around the world have made a large effort to measure the effect of trees shade on thermal performance and energy consumption. The following study endeavored to achieve valuable results through two stages: theoretical study was conducted depending on collecting data from related scientific papers, books, statistics, reports and interviews with specialists. The practical study was carried out using parametric approach. Therefore, Quantitative Data of trees and buildings was used in the second practical stage which depends mainly on thermal simulation tools. The main tool is DESIGNBUILDER model, which was used to study the effects of different

species, numbers and location of trees on the thermal performance of a single residential building. These results were validated by ECOTECT model. DESIGNBUILDER and ECOTECT dealt with tree as blocked element of solar radiation to provide shade.

The first study investigated the effect of trees on the thermal performance of a single building. Different trees configurations were considered in this case. Therefore, the result of simulation was analyzed to find out the impacts of shading on the thermal environments of buildings and the best trees configurations. The second study investigated the effect of street trees on the thermal performance of buildings and exterior environment.

DESIGNBUILDER is 3-D comprehensive interface built over the energy plus dynamic model that can simulate indoor thermal interactions, (Fahmy et al., 2009). It is a state-of-the-art software tool for checking building energy, carbon, lighting and comfort performance. It was developed to simplify the process of building simulation; DESIGNBUILDER allows comparing rapidly the function and performance of building designs. It can be used for simulations of many common HVAC types, naturally ventilated buildings, buildings with day lighting control, double facades, advanced solar shading strategies etc. It builds on the most popular features and capabilities of BLAST and DOE-2, (DesignBuilder Software Ltd, 2012).

ECOTECT is a comprehensive concept-to-detail sustainable building design tool. ECOTECT Analysis offers a wide range of simulation and building energy analysis functionality that can improve performance of existing buildings and new building designs. Online energy, water, and carbon-emission analysis capabilities integrate with tools that enable to visualize and simulate a building's performance within the context of its environment, (Autodesk Ecotect Analysis, 2012)

## **1.7 Limits of Study**

The Gaza Strip was selected to be the study area that located at 31.52° N latitude and 34.43°E longitude. The climatic condition of the Gaza Strip is affected by the Mediterranean climate, where winter is cool but short and summer is long, hot and humid, (Ministry of local government, 2004). Consequently, cooling energy needed during the summer is far greater than heating energy needed during the winter.

The current study considered for the effect of trees configurations including:

- Trees geometries include: vase, umbrella, rounded, oval, columnar, and conical.
- Trees locations near buildings include: distances, directions, and specific position.
- Trees crown size and height.
- Trees number around buildings and its locations possibilities.
- Other Tree configurations limitations including trees characteristics such as density, tree canopy, and leaves falling.

The intended buildings to be examined are common residential buildings in Gaza including villas (two floors) and five floors buildings with different orientations. Each floor is 3m height (the typical height of residential building in Gaza). Typical floor consist of one apartment with 7 people per family. The building also, is non-insulated and with simple and normal finishing. In other hand, the effect of street trees account for different street orientations.

## **1.8 Sources of Study**

The study information was classified into theoretical, field, and computer simulation tools that include:

- Published scientific papers, conference papers, worksheets, and guidelines books.
- Related Books.
- Reports and statistics from public and non-public associations.
- Scientific internet sites, universities, and research centers sites.
- Interview with specialists and experts in plants and trees science.

## **1.9 Study Outline**

The current study was displayed in six chapters. The first chapter was general introduction of the study that include overview, problem statement, hypothesis, objectives, methodology, limitations, source of information and literature reviews of similar studies.

Chapter 2 presented environmental challenges including climate change, global warming, greenhouse gas effect, urban heat islands, and environment pollution and their implication. Energy crisis in the world and the assessment of the Gaza Strip situation was described too. Also, it summarized passive solar design techniques as a solution for these problems.

Chapter 3 illustrated the trees identification, benefits, and microclimate modifications. It presented the strategies to plant right trees in the right place depending on site conditions, trees attributes and trees diversity. It listed the most planted trees in the Gaza Strip and their characteristics.

Chapter 4 investigated the effect of many trees configurations including trees geometries, locations, distances, size, and number on the thermal performance of single residential buildings in the Gaza Strip. Total cooling and heating loads, incident solar radiation, solar gain, and fabric gain in summer and winter are the main indicators on building thermal performance. Also, different building configurations were analyzed in term of one tree configuration effect.

Chapter 5 discussed the effect of street trees configurations on the buildings thermal performance and energy consumption for different street orientations.

Chapter 6 discussed deeply the results of study and gave some important recommendations accordingly.

## **1.10 Previous Studies**

Previous studies that have looked at the effect of shade trees on energy use fall into two categories: small-scale controlled experiments that examined the effect of trees on an individual house and large-scale simulation modeling. The most relevant studies are:

1. Mohamad Fahmy et al. (2009). Dual stage simulations to study the microclimatic effects of trees on thermal comfort in a residential building, Cairo-Egypt.

The researchers described an outdoor-indoor thermal investigation of a multifamily residential building during summer affected by trees in Cairo, Egypt. In this investigation, two kinds of trees were simulated by computer programs (15m high Ficus Elastica and 20m Yellow Poinciana) to measure the effect of trees on thermal comfort inside houses and compare it with a scenario without trees. The study found that the best indoor comfort levels were achieved using the 15m high Ficus Elastica trees in the urban site and specific type should be used for better outdoor-indoor performance . Results also indicate that raw weather data files which used without microclimate physical adjustments are not adequate for detailed comfort analysis and indoor-outdoor simulations should be coupled for better representing indoor climate.

2. Mohamad Fahmy et al. (2010). LAI based trees selection for mid latitude urban developments: A microclimatic study in Cairo, Egypt.

The researchers studied the best criteria in choosing the position and type of trees to be planted in urban areas in Cairo, Egypt in order to test the improvement of microclimate in two urban sites either for pedestrians or for indoor inhabitants without source data for its foliage characteristics. Two Egyptian trees; Ficus elastica, and Peltophorum pterocarpum were simulated by envi-met model in the sites with one having no trees, whilst the second is having Ficus-nitida trees, where envi-met plants data base was used as platform for a foliage modeling parameters (leaf area density) that were calculated using flat leave's trees LAI definition to produce maximum ground solid shade at peak time. Improvements for pedestrian comfort and ambient microclimate of the building were achieved by using F. elastica. About 40–50% interception of direct radiation, reductions in surfaces' fluxes around trees and in radiant temperature  $T_{mrt}$  in comparison to base cases gave prefer ability to F. elastica. The lack of soil water prevented evapo-transpiration to take place effectively and the reduced wind speeds concluded negligible air temperature differences from both base cases except slightly appeared with the F. elastica.

3. Hashem Akbari et al., (1997). Peak power and cooling energy saving of shade trees

The study outlined the effect of shade trees on the cooling costs of two similar houses in Sacramento, California. Field collecting data including, air-conditioning electricity use, indoor outdoor dry bulb temperatures and humidity, roof and surface temperatures, inside and outside wall temperatures, wind speed and direction and insulation were used at first. The results of trees shade effect at the two houses reduced seasonal cooling energy by 30%, average daily savings of 3.6 and 4.8 kWh/d and peak demand savings for the same houses were 0.6 and 0.8 kW. Previous results were compared with DOE-2.1E simulation program for the same houses. The simulation results underestimated the cooling energy savings and peak power reductions by as much as two fold.

4. Spangenberg et al., (2008). Simulation of the influence of vegetation on microclimate and thermal comfort in the city of Sao Paulo.

The researchers collected real microclimate measurements of the center of Sao Paulo (park, square and street canyon) to simulate the influence of vegetation on microclimate and thermal comfort in the city. The field measurements showed that

the park is cooler than the square and canyon with 2°C. These measurements were entered to Envi-met model to calculate thermal comfort in the city. The results showed that street trees in the canyon had a limited cooling effect on the air temperature, but led to a significant cooling of the street surface as well as a great reduction of the mean radiant temperature at pedestrian height. Although the trees lowered the wind speed up to 45% of the maximum values, the thermal comfort was improved considerably as the physiologically equivalent temperature (PET) was reduced by up to 12°C.

5. Simpson and McPherson, (1996). The potential of tree shade for reducing residential energy use in California.

The researchers use computer simulation tools to measure the effects of tree shade on residential air conditioning and heating energy use for a range of tree orientations, building insulation levels and climate zones in California. Shadow patterns simulator (SPS) program and micropas 4.01 was used in this simulation.

Main results indicate that tree shading home's west exposure produced the largest savings, next largest saving were for southwest and east locations. Three previous cases of tree planting reduced annual energy use for cooling 10% to 50% and peak electrical use up to 23%, cooling load reductions were always greater than increased heating loads associated with shade from south side trees in winter. Air-conditioning savings, both peak and annual, were larger in warmer climates and uninsulated buildings; percentage savings were larger in cooler climates and for more energy efficient buildings.

6. McPherson et al., (1988). Impacts of vegetation on residential heating and cooling.

They studied the impacts of vegetation on residential heating and cooling loads. Irradiance reductions from vegetation were modeled using SPS and MICROPAS, which simulates shade cast from plants on buildings. Four U.S.A cities-Madison, Salt Lake City, Tucson and Miami- with different climates were used as different case studies to evaluate the effects of irradiance and wind evaluation on the energy performance of 143 m<sup>2</sup> building in each of them. Results indicate that roof and west wall shading reduce cooling costs, whereas south and east wall shading reduce heating costs. Irradiance reductions increased annual heating costs in cold climates in Madison, and reduced cooling costs in hot climates in Miami. A 50% wind reduction was shown to lower annual heating costs by 11% in Madison, and increased annual cooling costs by 15% in Miami.

7. Simpson, (2002). A simplified method to estimate the tree shade effects on residential energy use to be appropriate for neighborhood and larger scale.

The overall aim of Simpson in his study is to present a simplified method to estimate the tree shade effects on residential energy use to be appropriate for neighborhood and larger scale. The method depend basically on tabulated energy use changes for arrange of tree types and location around buildings combined with frequency of occurrence of trees at those location. 178 residences and their associated trees in Sacramento, California were used to test the method by comparison it with detailed simulation which approximately matched. The results from the study indicate that average change in energy use for each tree type not

totally depend on tree location, other factors such as size and type should take in account.

8. Geoffrey Donovan and David Butry, (2009). The value of shade: estimating the effect of urban trees on summertime electricity use.

This study investigated electricity use for 460 single family homes shaded by trees in Sacramento-California through large scale empirical analysis. Results show that there is significant variation among the 460 houses in the sample and trees shade significantly affected summertime electricity use, but that the magnitude of the effect depended on the tree's location whereas the west and south sides of a house reduce summertime electricity use, thus reduce carbon emissions from electricity generation, but trees on the north side of a house increase summertime electricity use.

9. Pandit and Laband, (2010). Energy savings from tree.

They developed a statistical model to estimate the electricity savings generated by trees shade in a suburban environment of large sample of residences in Auburn, Alabama. This empirical model links residential energy consumption during peak summer (winter) months to average energy consumption during non-summer/ non-winter months, behaviors of the occupants, and the extent, density, and timing of shade cast on the structures. Their estimates reveal that tree shade generally is associated with reduced (increased) electricity consumption in the summertime (wintertime). In summertime, energy savings are maximized by having dense shade. In wintertime, energy consumption increases as shade percentage in the morning, when outdoor temperatures are at their lowest, increases.

10. Pandit and Laband, (2010). A hedonic analysis to study the impact of tree shade on summertime residential energy consumption.

A statistical model was developed to produce specific estimates of the electricity savings generated by shade-producing trees in a suburban environment of Auburn, Alabama, USA. This empirical model links residential energy consumption to hedonic characteristics of the structures, characteristics/behaviors of the occupants, and the extent and density of shade cast on the structures at different times of the day. For a typical residences / family in the study sample, results indicate that monetary savings from shade during the summer month are sizable compared with house with no shade and differ according to the shading density on the house.

Obviously, it is noticed from previous studies that the significance of trees configurations were expressed about by the magnitude of reducing energy consumption in summer and increasing it in winter. the most of these studies investigated the effect of tree types or locations on reducing energy loads in both seasons. Also, the most of them used computer simulations tools to estimate tree effect on cooling and heating loads reduction. Some of these studies presented a simplified method to estimate the trees effect on residential energy use, while few of them use field collecting data methods. The main results concentrated on the energy reduction as a result of changing tree type or location. For the most of studies, building west side is the ideal location of planting tree in the purpose of

energy saving followed by south west and east location. On the other hand, other studies recommended taking into account size and typing of tree that have more influence on energy saving than tree location.

## **1.11 Conclusion**

This chapter concentrated specifically on displaying thermal discomfort problems inside and outside built environment as a result of climate change and energy crisis. The importance of these problems increases with the increasing of population and buildings density and environment pollutions. Trees and vegetation areas are the subject of this study that are considered the most appropriate solution for increasing energy consumption and environment pollution in the urban areas. The study assumes that there are significant effects of trees on the thermal performance of the buildings in the Gaza Strip. So, by DESIGNBUILDER and ECOTECH tools, the study was carried out to find out the accuracy of this assumption.

On the other hand, the chapter presented related studies that dealt with trees shade effect. Each study had its own methods and parametric tools that differ according to the study objectives. It was concluded there are lack of studies that utilized DESIGNBUILDER model and the Gaza Strip climate. Also, the most of these studies handled the effect of trees species and locations on the residential buildings energy use. Distances, numbers, size and even street trees were rarely investigated in term of internal thermal comfort and energy consumption.

## **Chapter 2: Global Environmental Challenges and Assessment of the Gaza Strip Situation**

### **2.1 Introduction**

Development patterns of the last 50 years have had both positive and negative impacts on communities across the worldwide. After Industrial revolution in 19<sup>th</sup> century, the life of people changed, as well as the level of life in cities improved with regard to health, education, economic and other aspects of life. Most notably, average income and population began to exhibit unprecedented sustained growth. The population density increased as a result of health care improvement and increasing migration from rural to urban to attain better life. Consequently, the built-up areas, impermeable surfaces, massive buildings, cars, machines, and pollutants increased too, which contributed to reducing landscape and vegetation areas.

In this chapter, a review of many factors that influence urban microclimate and energy consumption problems have been discussed. Results of climate change such as temperature differential, ice thawing, solar and precipitation variations, urban heat island, and pollution is the man-made contribution in urban context that are important in creating and generating the ambiance of microclimate, thus energy demand. Therefore, climate-responsive building that meets increasing energy demand and microclimate problems has been discussed too. As the buildings face the particular challenge, investigations have been conducted on climate oriented building design to achieve thermal comfort and reduce both embodied and operational energy consumption. The passive solar design strategies become more efficient to create comfort ambiances without great consumption of energy.

### **2.2 Definitions of Climate, Weather and Microclimate**

Urban climatology has been a growing field of research over the last few decades, (Fahmy et al., 2009). It could affect human health and activities, animals and many types of ecosystems in the world. The interesting of people in weather and climate increases day by day. Their understanding of climate change over the years increases too. The world metrological organizations use data including measurements of temperature, precipitation, wind, humidity, and atmospheric pressure as a description of weather and climate. These data are reported each day from standardized weather stations, (Shepherd, 2008).

The difference between weather and climate is just a time. Weather is the conditions of the atmosphere over a short period of time, and climate is how the atmosphere "behaves" over relatively long periods of time. For example climate change means changes in long-term averages of daily weather, (Shepherd, 2008). Also, Weather is basically the way the atmosphere is behaving, mainly with respect to its effects upon life and human activities. It consists of the short-term (minutes to months) changes in the atmosphere.

Basically, climate is described at three scales: the macro scale, with horizontal dimensions of hundreds of miles; the meso scale, with dimensions of metropolitan areas; and the micro scale, with dimensions of a few hundred feet or less horizontally and tens of feet vertically. Hence, the micro scale corresponds in size to city streets and small parks, (Heisler, 1977).



On other hand, microclimate describes the climate of specific place and the difference between it and surrounding area. It is the suite of climatic conditions in localized areas near the earth surface, (Chen et al., 1999 and Ministry of local government, 2004). Microclimate includes small area such as the climate of courtyard that is colder or warmer than the exposed field nearby. It also, includes large area such as several miles inland from a large body of waters that moderate temperatures, (Mazza, 2010).

## 2.3 Factors Influencing Urban Microclimate

As mentioned before, microclimate may refer to areas as small as a few square feet or as large as many square miles. Microclimates exist, for example, near bodies of water which may cool the local atmosphere, or in heavily urban areas where brick, concrete, and asphalt absorb the sun's energy, heat up, and reradiate that heat to the ambient air resulting urban heat island phenomena. The affected factors of local microclimate are all natural phenomena and man-made induced consequences.

### 2.3.1 Climate Change, Global Warming and Greenhouse Gas Effect

A wide range of climate change scenarios and their potential implications for the built environment have been investigated all over the world. Climate change is the statistics of changes in weather over time, (Le Treut, 2007). Sea level rise, increase in storm activity, temperature rise, expansions of deserts, and increase in convective action are evidence of climate change and global warming, (Edward, 2002). The third assessment report of the Intergovernmental Panel on climate change (IPCC) predicts an increase in surface temperature of 1.4-5.8 C° on the period 1990-2100, thus increase in climate variability and extreme events, (Frank, 2005). 50% of global warming is caused by burning of fossil fuels in support of the use of buildings. Therefore cities are responsible for 75%-80% of all man-made CO<sub>2</sub> emissions and it is the main source of global warming, (Edward, 2002).

To understand global warming, solar behavior and its relationship with earth must be realized. Roughly one-third of the solar energy that reaches to the top of earth's atmosphere is reflected directly back to space. The remaining two-third is absorbed by the surface by the atmosphere. Hence to balance the absorbed incoming energy, the earth must radiate the same amount of energy back to space. But, because the earth is much colder than the sun, it radiates at much longer wavelengths, primarily in the infrared part of the spectrum (see figure (2.1)). Much of this thermal radiation that emitted by the land and ocean is absorbed by the atmosphere, including clouds, and then reradiated back to Earth. This is called the greenhouse effect, (Le Treut, 2007).

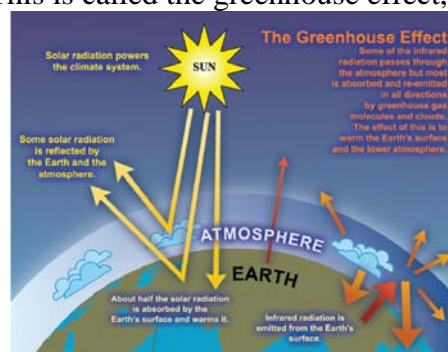


Figure (2.1): The greenhouse effect, (Le Treut, 2007).

Simply, the term "global warming" means heating of earth planet. The glass walls in a greenhouse reduce airflow and increase the temperature of the air inside. Analogously, the earth's greenhouse effect warms the surface of the planet. Water vapor is the most important greenhouse gas, and carbon dioxide (CO<sub>2</sub>) is the second-most important one. Methane, nitrous oxide, ozone and several other gases present in the atmosphere in small amounts also contribute to the greenhouse effect, (Le Treut, 2007 and Edward, 2002).

Many countries are aiming to use cleaner and less polluting technologies that aid in mitigation microclimate and could result in substantial reductions in CO<sub>2</sub> emissions. Policies include targets for emissions reductions, increased use of renewable energy, and increased energy efficiency through using most natural tools such as vegetation and trees.

### **2.3.2 Urban Heat Island (UHI)**

Urban heat island (UHI) is a phenomenon that have been noted and named over 100 years by meteorologists. The larger the city is, the more intense the summer heat island effect is. However urban heat island effects are still local, and have not biased the large-scale trends, (Trenberth, 2007). It is the phenomenon that happens exactly in urban spaces, especially in summer. Surfaces including concrete and asphalt store incoming solar energy thus convert it to thermal energy and release it again to atmosphere at night contributing to raise air temperature, (City of boulders office, 2009). It depends on urban features such as urban textures, street pattern and orientation.

- **Thermal Behavior of UHI**

UHI is significant potential because it influences most of the major cities around the world and contributes to discomfort, thus increased air conditioning loads, (Kolokotroni and Giridharan, 2008). As population density increases rapidly, built-up areas increases too included concrete and asphalt. Concrete and asphalt, have significantly thermal bulk properties including heat capacity and thermal conductivity that make solar absorption easy and time lag to release heat again is long, (Oke, 1982, Akbari et al., 1992). They act as a giant reservoir of heat energy and concrete alone can hold roughly 2,000 times as much heat as an equivalent volume of air, (Lee, 1993).

Theoretically, convective winds of heat were generated within the urban surfaces layers directly as result of surfaces heating. However, air temperature perturbation within the UHI is generally minimal or nonexistent during the day, though the surface temperatures can reach extremely high levels. This is because time lag of these surfaces is relatively long, (Camilloni, and Barros, 1997). At night, the atmospheric convection begins to decrease and the urban surfaces layers begin to stabilize. This traps urban air near the surface, and keeping surface air warm, forming the nighttime warmer air temperatures within the UHI, (Morris, 2006). Figure (2.2) show the differences in net long wave radiation retained in and thermal admittance between urban and rural environment that are the functions of aspect ratio and surface albedo, (Giridharan et al., 2005).

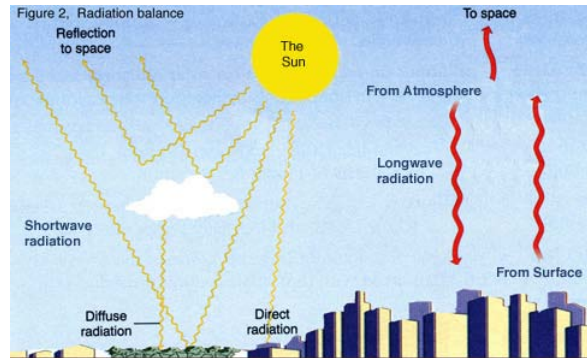


Figure (2.2): Thermal behavior of urban areas and rural surrounding (Sass, 2012)

As seen in the following figure (2.3), the sketch profile shows how parks and other vegetated sections within a downtown area may help to reduce heat islands. The temperature between two urban green areas and surrounded structural areas differ 7°C or more during summer, (Georgi and Dimitriou, 2010). Replacement of vegetation or soil by concrete or asphalt reduces the ability of landscape to conduct evapo-transpiration process. Instead, the solar energy delegated to the evaporation process is left to raise air temperature, (Misni and Allan, 2010). This causes a change in the energy balance of the urban area, often leading to higher temperatures than surrounding rural areas, (Akbariet al., 1992, Kolokotroni and Giridharan, 2008).

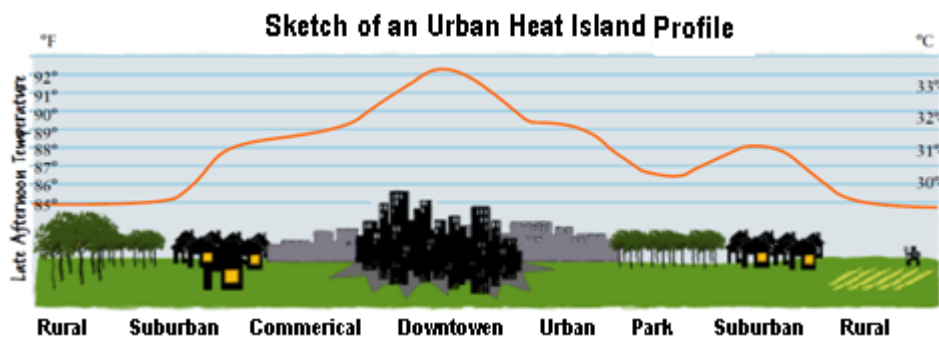


Figure (2.3): Sketch of a typical heat island profile illustrate summer temperatures in urban areas (City of boulders office, 2009)

• **Impacts on air quality and human health**

Increasing air temperature as a result of UHI effect causes air pollution. Secondary pollutants such as ozone affect air quality and environment, (Solecki et al., 2004). Local air pollution included particulates, volatile organics, and nitrogen oxides (NO<sub>x</sub>), which are precursors to ozone formation are already a problem in Mega cities, (Akbari, 2005).

High temperature cause environment pollution directly through forming harmful smog, as ozone precursors that combine photo-chemically to produce ground level ozone. It is also, indirectly responsible for increasing CO<sub>2</sub> emissions and greenhouse gases into the atmosphere through burning fossil fuels to supply the increased demand for energy to cool buildings during hot summer months, (city of boulders office, 2009). Ozone chemical gases and CO<sub>2</sub> together contribute to worsen air quality. Consequently, hot pavement and rooftop surfaces transfer their excess heat to storm water, which then drains into storm sewers and raises water temperatures as it is released into streams,

rivers, ponds, and lakes. Rapid temperature changes can be stressful to aquatic ecosystems, (Akbari et al., 1992).

Heat islands augment public health threat by directly increasing temperature that added stress on human physiology and indirectly raising ground-level ozone concentrations. Extreme heat and ozone cause pre-existing respiratory disease for the elderly, children, and individuals. Poor residents who live in homes with dark-colored roofs and no air conditioning may also be more vulnerable than the general population, (Shahmohamadi, 2011).

- **Impact on energy usage**

Impact of urban heat island (UHI) on energy usage depends on the climate of region. In cold region, it is considered beneficial because it raises temperature, thus lowers electricity bills that needed by heating utilities, (Akbari et al., 1992). In hot, humid, and tropical climate, increasing temperature and solar intensity lead to increase UHI normally in urban areas. It exacerbates cooling energy use through air conditioner and refrigeration, (Solecki et al., 2004, Hirano and Fujita, 2012). Peak urban electric demand rises by 2–4% for each 1C° rise in daily maximum temperature above a threshold of 15 C° to 20 C°. Thus, the additional air-conditioning use caused by this urban air temperature increase is responsible for 5–10% of urban peak electric demand, at a direct cost of several billion dollars annually, (Akbari and Taha, 2001).

Cities with high population such as U.S and Japan, peak utility use will increase 1.5 to 2 percent for every 1 F increase of temperature and that is significantly approved everywhere in the world, (Akbari et al., 1992). Figure (2.4) shows Japan cities, an example of an urban heat island. Normal temperatures of Tokyo go up more than those of the surrounding area.



Figure (2.4): Temperature of Japan cities-a case of urban heat island (Japan Metrological agency)

### 2.3.3 Environment Pollution

In recent years, urban quantity in the world increased greatly, urban population and urban land scale has also been expanded gradually. Thus environment pollution modifies microclimates and affect human comfort, health, welfare, and thereby energy usage. Pollution is the effect of contaminants on a natural environment that causes instability, disorder of brain, harm or discomfort to the ecosystem, (Gulati et al., 2010).

Environment pollution includes air pollution, water pollution, soil contamination, radioactive contamination, noise pollution, light pollution, visual pollution, and thermal

pollution. Air pollution comes from both natural and human-made sources. However, globally human-made pollutants from combustion, construction, mining, agriculture and warfare are increasingly significant in the air pollution equation, (UNEP, 1972 and Khan and Ghouri, 2011). Vehicle emissions, chemical plants, coal-fired power plants, oil refineries, petrochemical plants, nuclear waste disposal activity, incinerators, large livestock farms, PVC factories, metals production factories, plastics factories, and other heavy industry are main source of environment and air pollution, (Carson, 1962 and Beychok, 1967). Agricultural air pollution comes from contemporary practices which include clear felling and burning of natural vegetation as well as spraying of pesticides and herbicides as well, (Carson, 1962).

CO<sub>2</sub> emission is essentially an urban consequence but the level of emissions depends upon many factors such as climate, land use patterns, population density, and lifestyle. Larger population density, land patterns, and thus transportation level is, larger CO<sub>2</sub> emissions is too, (Edward, 2002). The second most significant greenhouse gas by volume is methane. Globally, there has been a 1% increase per year in methane emissions resulting from domestic waste, (Edward, 2002).

• **Impact on Human Health and Environment**

The emission of greenhouse gases leads to global warming which affects ecosystems in many ways. Nitrogen oxides, Sulfur dioxide, Carbon dioxide, and Smog can affect dangerously air, soil, and water. Soil can become infertile and unsuitable for plants. This will affect other organisms in the food web. Also, amount of sunlight received by plants to carry out photosynthesis can be reduced by smog which produces tropospheric ozone that damages plants. Acid rain lowers the (pH) value of soil and changes the species composition of ecosystems, (Khan and Ghouri, 2011).

Environment Pollution can kill many organisms including humans. Air pollution can cause respiratory disease, cardiovascular disease, throat inflammation, chest pain, and congestion. There is consistent evidence that exposure to indoor air pollution can lead to acute lower respiratory infections in children under five, and chronic obstructive pulmonary disease and lung cancer (where coal is used) in adults, (World Health Organization, 2000). Figure (2.5) show an overview of health effects of pollution.

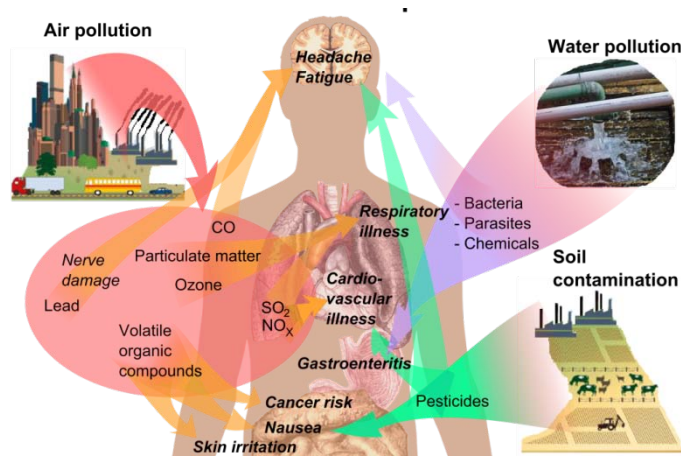


Figure (2.5): Effects of pollution on human health, (Theis and Tomkin, 2012)

Water pollution causes approximately 14,000 deaths per day, mostly due to contamination of drinking water by untreated sewage in developing countries, (Leahy,



2008). Soil contamination by pesticide that used in irrigation vegetations, can cause nausea, cardiovascular illness, and headache fatigue, (Khan and Ghouri, 2011). In the poorest countries, pollution is a major cause of death, illness, and long-term environmental damage, (Blacksmith Institute, 2007). The following figure (2.6) indicates that the developing countries have higher percent in death because of air pollution.

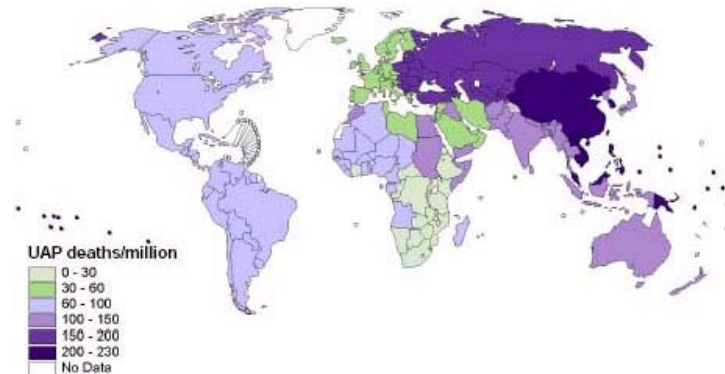


Figure (2.6): Global distribution of deaths from urban air pollution, (Sato, 2010)

- **Energy consumption**

Over 85% of the energy consumption in the world is from non-renewable supplies. Most developed nations are dependent on non-renewable energy sources such as fossil fuels (coal and oil) and nuclear power, (California University, 2009). As mentioned before, energy consumption included burning fossil fuels through buildings performance, and building construction is responsible for about a half of all energy use worldwide. Building practices, transportation, industry, and agriculture are responsible for major of pollution and CO<sub>2</sub> emission which is the biggest polluter in the world, (Edward, 2002).

As the consumption of non-renewable energy causes pollution, pollutions also contribute to rise temperature and lead people to endeavor comfort environment through heating, cooling, and lightening of buildings directly through burning of fossil fuels and indirectly through use of electricity which alone is responsible for CO<sub>2</sub>, the main greenhouse gas, (Edward, 2002).

## 2.4 Overview on the Gaza Strip Situation

The Gaza strip is a small area in the world that has special environment features and problems. This study summarizes these features and the environmental problems including location and topography, population density, climate, urban geometry and environmental issues.

### 2.4.1 Location and Topography

The Gaza Strip lies on the Eastern coast of the Mediterranean Sea, at 31, 25° N and 34, 20° E. As shown in figure (2.7) the Strip borders are: Egypt on the southwest with 11km long, occupied lands on the east and north, 51km long. It is about 40 kilometers long, and between 6 and 12 kilometers wide, with a total area of 360 square kilometers. The terrain roughly, is flat or rolling, with dunes near the coast. The height from sea level does not increase more than 50 m generally and in some areas 10m, (Ministry of local government, 2004).

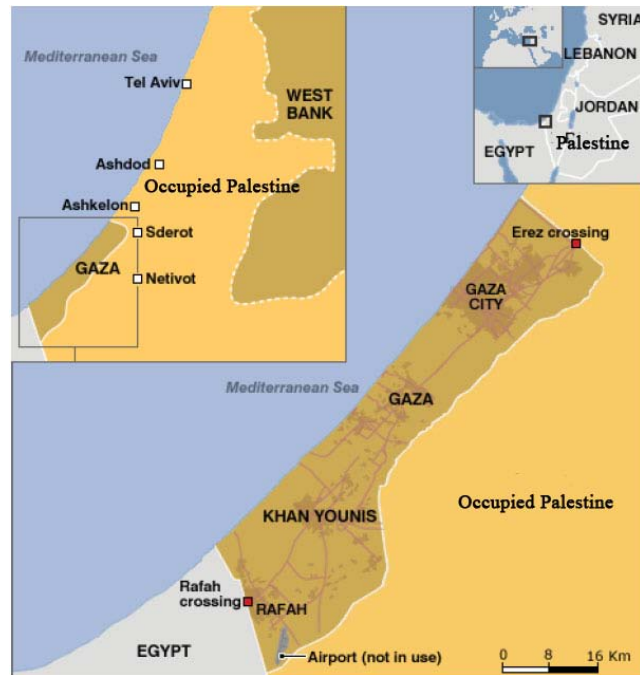


Figure (2.7): The Gaza Strip plan, (Droege, 2009) adapted by author

## 2.4.2 Population Density

The population of Gaza Strip as the end of 2007 census is about 1.8 million people, most of them descendants of refugees. One million of the population roughly was considered refugees, although the vast majority of them were actually born in the Gaza Strip, Population growth is 3.5 percent per year, (Palestinian Central Bureau of statistics, 2009). Therefore, the Gaza Strip is one of the highest densities in the world. According to the ministry of local government, the issued constructions permits by municipalities increased a double from year 2000 to year 2011. The municipality of Gaza alone issued 1400 permits in year 2000, this number increased to 3500 permits in year 2011, (Ministry of local government, 2012). As a result, buildings are in a compact urban setting. The residential building surfaces in Gaza, mostly built in concrete, have very high heat storage capacity especially due to low albedo level. After sunset, sensible heat flux from these do not drop rapidly due to high thermal capacity of the combined mass of buildings. This leads to warming of air and a rise in nocturnal UHI.

## 2.4.3 General Characters of Urban Geometry in Gaza

Gaza city is considered the main city in the Gaza Strip. It has the main view to the northern western direction where the Mediterranean Sea is the main mark of the region. The urban geometry complexes of Gaza are considered as dense in construction, high degree of impervious surfaces (asphalt, concrete, cement, and interlock), very low density of vegetation within the micro-environment, high heat storage capacity of construction material, and the geometry block can easily traps the radiation that create air stagnation. Generally, street takes parallel and perpendicular orientations to the sea coast. See figure (2.8). Thus, land plots and buildings take the same orientations. The main forms of buildings range between the square and rectangular as the rectangular shape is the most popular shape in parcels, (Abed, 2012).



Figure (2.8): Street and parcels orientations in the Gaza Strip, (open street map, 2012)

The urban fabric may have different characteristics from a small village than a city or a refugee camps, but all cities, villages, and refugee camps have common elements and components forming an urban fabric. Downtowns and neighborhoods are the two main types of development for urban areas; others may include educational institutions, industrial areas or individual buildings. Neighborhoods are primary residential areas, but also include commercial uses such as grocery stores, restaurants, and small offices. Neighborhoods have many types of buildings: detached houses, villas, and apartments. Landscape elements are less effective especially for those high buildings and for the absence of outdoor functions in apartment buildings and office building, (Hadid, 2002).

## 2.4.4 Climate

The Gaza Strip forms transitional zone between humid costly area and dry desert area. As shown in figure (2.9) and according to Köppen climate classification (the most widely used climate classification systems), The Gaza Strip has a moderate Mediterranean climate, with rainy, mild, short winters, unpredictable springs and autumns, and dry, warm, hot, long summer.

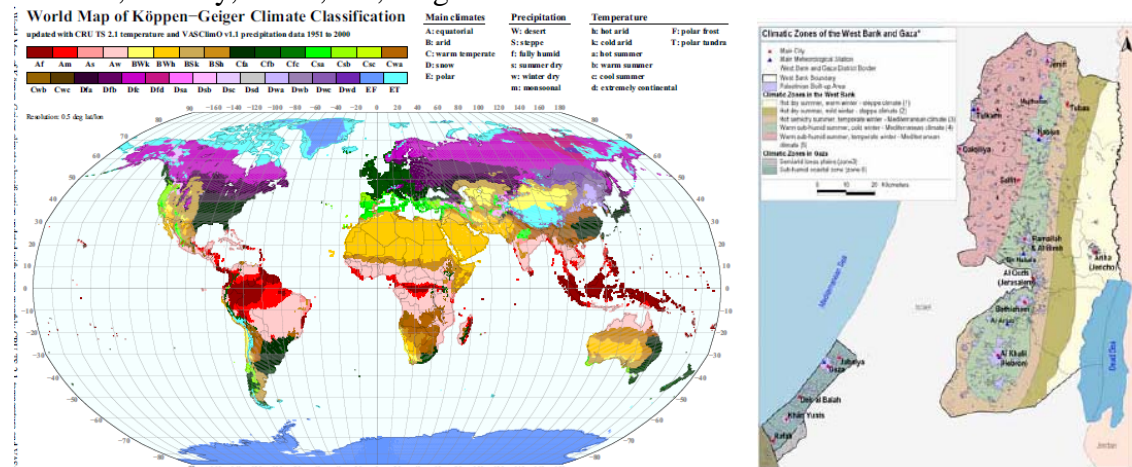


Figure (2.9): Climate zones of the world according to Köppen classification, (Kottek et al., 2006) and Palestine climatic zones, (Applied Research Institute, 2003)



For most parts of the year the Gaza Strip climate remains enjoyable. The Palestinian atmosphere is fresh and the air is unadulterated at the region. Main radiant temperature of the Gaza Strip ranges from 25C° in the summer season to 13C° in the winter season, see figure (2.10). Comfort level is measured in the Gaza Strip by mean air temperature that ranges from 15-20 C°, (Ministry of local government, 2004).

Rainfall in the Gaza Strip is very restricted which mostly occurs in the months of November through February. It varies from north (450 mm) to south (200 mm). Rain is the main source of water in Palestine as it provides the underground water reservoir.

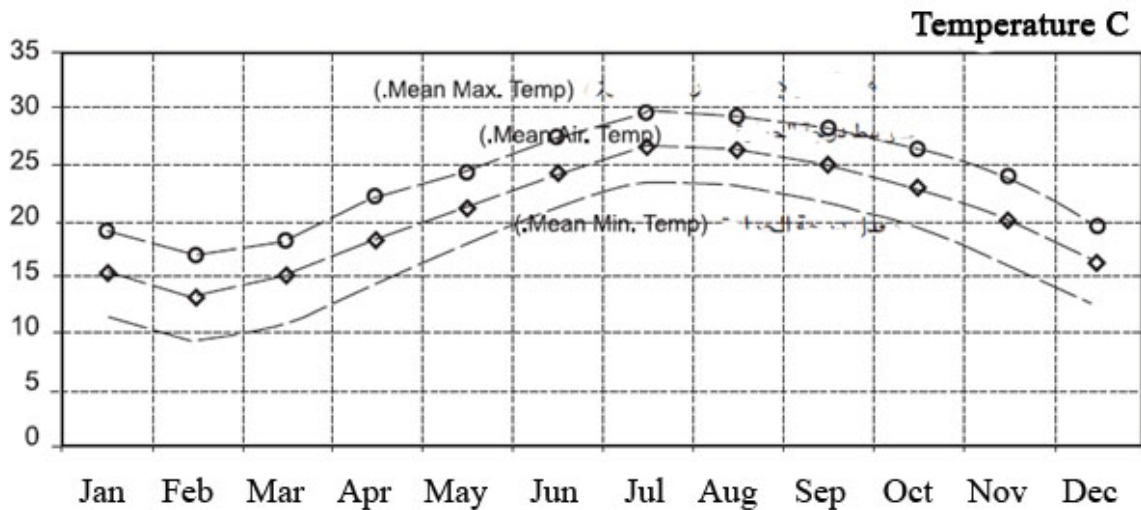


Figure (2.10): The annual average temperature (C°) in the Gaza Strip, (Ministry of local government, 2004) adapted by author

Also, as shown in figure (2.11), relative humidity ranges in the summer from 65% in day and 85% at night. It ranges in the winter from 60% in day and 80% at night, (Ministry of local government, 2004).

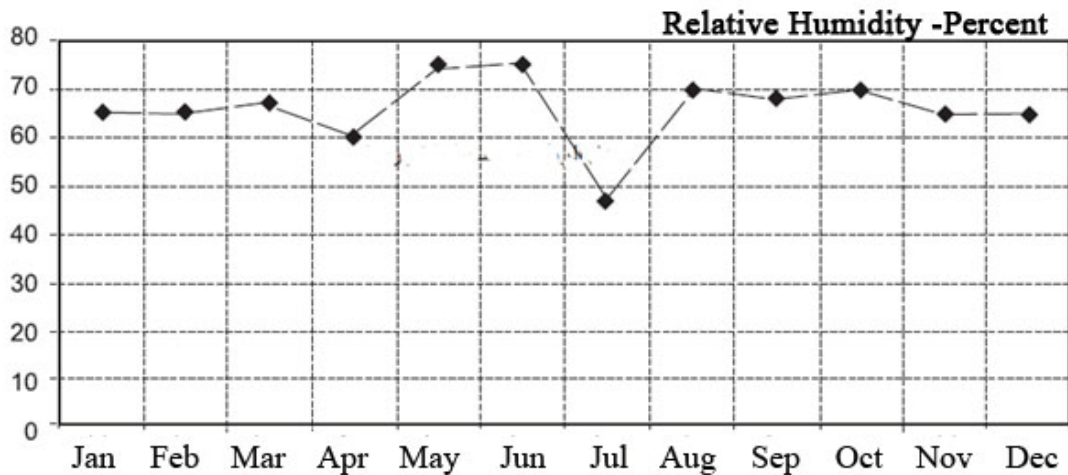


Figure (2.11): The annual average relative humidity (%) in the Gaza Strip, (Ministry of local government, 2004) adapted by author

Prevailing wind in the summer is northern western wind. Its speed ranges from 3.9 m/s in the afternoon and soon lowers in the night to half of daily speed. In the winter the direction of wind change to southern western and its speed reach in sometimes to 18 m/s, (Ministry of local government, 2004). Show figure (2.12)

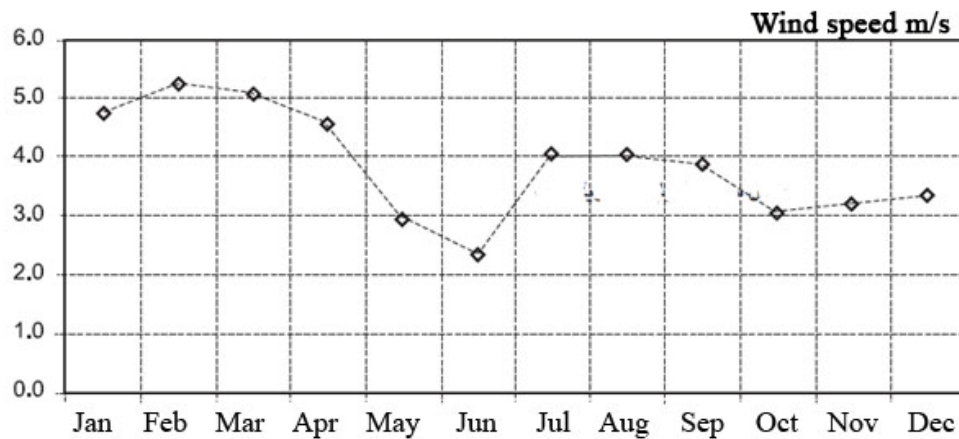


Figure (2.12): the annual average wind speed (m/s) in the Gaza Strip, (Ministry of local government, 2004) adapted by author

Solar radiation is large in summer, but in winter it less than one-third the amount of radiation in summer. It has approximately 2861 annual sunshine hours throughout the year. The daily average solar radiation on a horizontal surface is about 222 W/m<sup>2</sup> and this value varies during the day and the year, (Ministry of local government, 2004).

### 2.4.5 Environment issues

The main natural resources in the Gaza Strip are arable lands that forms about a third of the Strip, and recently natural gas was discovered, (Central Intelligence Agency, 2012). In other hand, atmospheric environment in the Gaza Strip doesn't have any follow ups, or studies that enable the researcher & planner to put a hand on its fact in a correct scientific way. Generally, environmental problems include desertification, salination of fresh water, sewage treatment, water-borne disease, soil degradation and depletion and contamination of underground water resources, (Central Intelligence Agency, 2012).

## 2.5 Energy Consumption Trend in the Buildings

Widely known, there is rapidly growing energy use over an urban context in the world. The International Energy Agency has gathered frightening data on energy consumption trends. As shown in figure (2.13), during the last two decades (1984–2004) primary energy has grown by 49% and CO<sub>2</sub> emissions by 43%, with an average annual increase of 2% and 1.8% respectively and the energy growing trend will continue, (Pe´rez-Lombard et al., 2008).

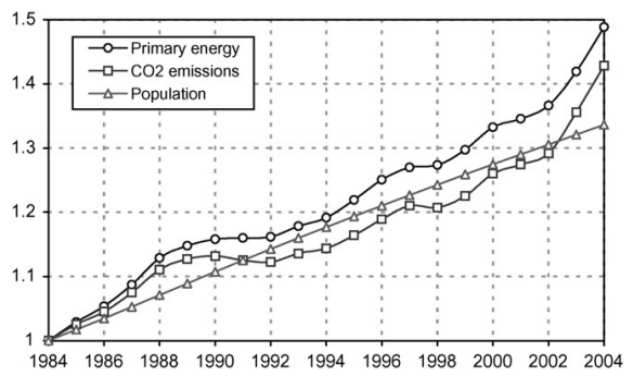


Figure (2.13): Primary energy consumption, CO<sub>2</sub> emissions and world population from 1984 to 2004, (Pe´rez-Lombard et al., 2008)

Energy consumption in buildings is usually divided to three main sectors: industry, transport, and other. “Other” term include agriculture, services, and residential sectors. Growth in population, enhancement of building services and comfort levels, together with the rise in time spent inside buildings, have raised building energy consumption to the levels of transport and industry.

In the residential sector, small apartments need less energy as there is less conditioned and also less occupation than large one. The amount and type of energy used in residential buildings are mainly related to weather, architectural design, energy systems and economic level of the occupants. In USA, dwellings consume 22% of the total energy use, compared with 26% in the EU. The UK consumption is 28%, and the Spanish 15% mainly due to a more severe climate and building type. The EIA (International Energy Agency) predict that consumption attributed to dwellings and the non-domestic sectors will be 67% and 33% respectively (approximately) in 2030, (Pe´rez-Lombard et al., 2008).

### 2.5.1 Resources of Energy Used in Buildings

Renewable and non-renewable are the main resources of energy. Non-renewable resources include fossil fuels, minerals, and other. Renewable resources include energy from the sun, wind, geothermal and the biological and biogeochemical cycles (such as the water and energy hydrological and carbon cycle), (Omer, 2008). Homes and buildings use energy to heat and cool, light, and operate appliances and office machines. The main source of this energy is electricity, fossil fuels, natural gas, and nuclear power in developed country. The heating or cooling of a space to maintain thermal comfort is a highly energy intensive process accounting for as much as 60–70% of total energy use in non-industrial buildings, (Omer, 2008).

The following figure (2.14) shows that 41% of U.S. primary energy was consumed by the buildings sector, compared to 30% by the industrial sector and 29% by the transportation sector. Of the energy sources used by the U.S. buildings sector, 75% came from fossil fuels, 16% from nuclear generation, and 9% from renewable energy, (D&R International, Ltd., 2012).

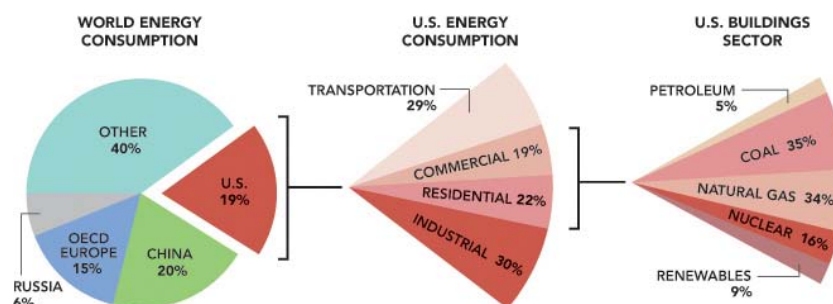


Figure (2.14): U.S. energy types in buildings, (D&R International, Ltd., 2012)

### 2.5.2 Reasons and Consequences of Increasing Energy Consumption in the Buildings

Globalization, improvement of living conditions in emerging regions and the development of communication networks, promote developed nations’ life style are the main reasons of raising energy needs. Thus, the rise of domestic electricity consumption is due to a constant population growth and increases incomes and comfort requirements

(linked to the possession of appliances and lighting). The demand of services (health, education, culture, leisure, etc.), industry, and agriculture increase too, thus the energy consumption, (Pe´rez-Lombard et al., 2008).

Consequences of increasing energy consumption that are obtained from the analysis of the trend of main world energy indicators between 1973 and 2004 are, (Pe´rez-Lombard et al., 2008):

- Primary energy consumption is growing at a higher rate than population, leading to the increase of its per capita value on 15.7% over the last 30 years,
- CO2 emissions have grown at a lower rate than energy consumption showing a 5% increase during this period,
- Electrical energy consumption has totally risen (over two and a half times) leading to a percentage increase in final energy consumption (18% in 2004).

### 2.5.3 Energy Situation in the Gaza Strip

The energy sector plays a significant role in improving the national economy and providing employment opportunities in Palestine. Generally, energy sources consist of the energy generated by petroleum and natural gas, electricity, and renewable energy (including solar power, wind power, and energy generated from burning wood, peat, etc.). With the exception of renewable energy, the Palestinian energy sector has special resources and in the same time inability to fully exploit available ones, causing it to largely depend on imported fossil fuels from Israel, (Abu-Hafeetha, 2009). The Gaza Strip is considered as one of the poorest countries in energy resources and consumption compared to developed countries. Beside unusual position for the Gaza Strip, energy demand increase as the increase of population, services, and welfare means.

Energy generated by gas and petroleum derivatives forms 51% of total consumption in the local market. A major portion of this energy is used as fuel by transportation, residential, and factories sectors. Large part of this fuel (benzene and diesel) is used by the Gaza Electricity Generation Plant for electricity production for previous sectors, (Palestinian national plan, 2011). Liquefied petroleum gas for cooking and heating gas is used largely in domestic sector because residential buildings form greater percentage of buildings in the Gaza strip, (ministry of local government, 2012). As shown in following diagram (2.15) Residential sector is the first sector that consumed the imported energy from 1996 to 2005 in total Palestine with roughly 64%, (Abu-Hafeetha, 2009). Residential buildings in the Gaza Strip are the largest consumer of energy that was estimated as 70% of the total amount energy consumed, (PENRA, 2012).

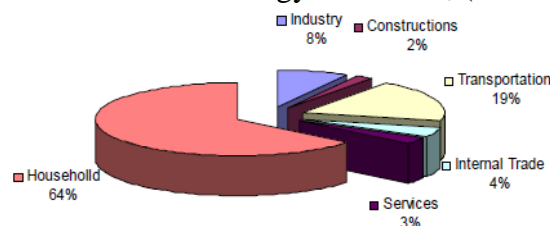


Figure (2.15): The percentage of consuming imported Energy by sectors in 2005, (Abu-Hafeetha, 2009)

**Electricity:** Gaza's power supply comes from three sources. It receives 17 MW from Egypt, 108 MW from Israel electrical company, and 55 MW generated by its own power plant (after bombing). This forms 180 MW or 75 % of its estimated demand of 240 MW. Israel electrical Company reduced its supply to Gaza by around 0.5 MW in 2008 and this increase the pressure on Palestinians, (Droege, 2009). Israel occupation currently supplies 2.2 million liters of fuels per week to electricity power plant. If supply is halted for two days, the power plant would run out and would have to cease operation, (Droege, 2009).

Electricity consumption for the Palestinians is considered to be the lowest in the region, electricity consumption per capita in 2006 was 675 kWh/year for Palestine compared to 5200kWh/year for Israel (8 times greater), (Yasin, 2008). The electricity consumption of Gaza Strip was increased by 80% during the period 1999 to 2005, (Abu-Hafeetha, 2009). The electricity demand increases by about 10-15 MW annually (10% average annual increasing rate) as a result of population growth and the expansion in the different sectors that need electricity, (Muhaisen, 2007). See figure (2.16)

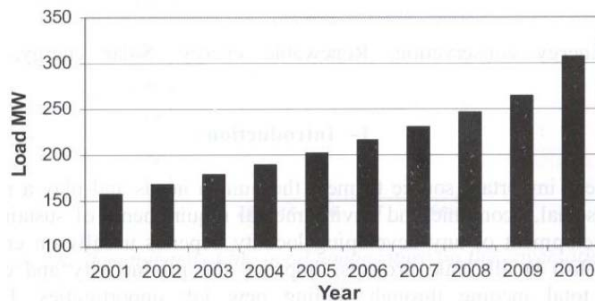


Figure (2.16): The electricity load required for Gaza Strip until year 2010, (Muhaisen, 2007)

Following figure (2.17) show the Average Consumption Per Capita of Electricity in the Palestine territory. Consumption electricity in the Gaza Strip increased from 500 GWh in 1994 to 1250 GWh in 2005, (Yasin, 2008).

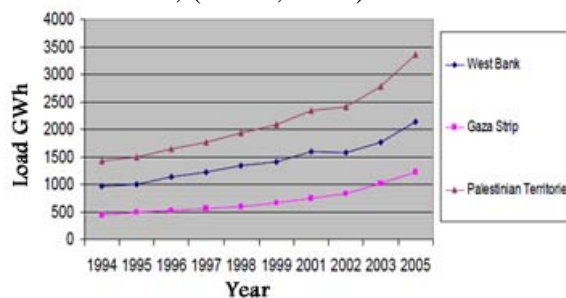


Figure (2.17): Electricity consumption in Palestine territory (GWh) from 1994-2005, (Yasin, 2008)

**Fossil fuels:** In 2000, liquefied petroleum gas (LPG) was discovered in the Palestinian Territories at large quantities. Two fields in the Mediterranean Sea were discovered in the cost of Gaza Strip. One of them is entirely within the regional waters while 67% of the second field is located in the Palestinian territory and 33% in areas controlled by Israel, (Abu-Hafeetha, 2009). This gas is not used by Palestinians because of occupation. Generally, petroleum products (gas, kerosene, gasoline, diesel, oil, and liquefied petroleum gas (LPG)) are imported from Israel or Egypt. As seen in the following diagram (2.18), using the much of it go to domestic activities or use as electricity that generated directly from electrical distribution company.



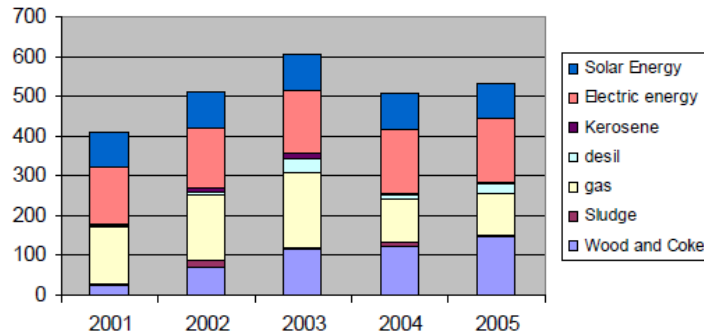


Figure (2.18): Energy Consumption in Residential Sector by Fuel (2001-2005), (Abu-Hafeetha, 2009)

Gaza shortage of electricity and the increase in consumption of it motivate the architects towards looking for alternatives that contribute to reduce the dependence on air conditioner that increases usage of electricity in the last years.

## 2.6 Reducing Energy Consumption and Achieving Human comfort in Buildings

The continuous changing by man-made activities and extraordinary natural phenomena alter climatic and lands patterns, and affect energy consumption. In February 2007, a report by the Intergovernmental Panel on Climate Change (IPCC), representing the work of 2,500 scientists, economists, and policymakers from more than 120 countries, said that humans have been the primary cause of global warming since 1950, (Le Treut et al., 2007). As a result, people is trying to tame all constrains to make urban context more comfort by increasing the load on air-conditioner, heating and cooling system. Most scientists and architects have been concerned with this change, thus needs and comfort of people.

In this context, integral concepts for buildings with both excellent indoor environment control and sustainable environmental impact are the best solution for energy and climate change. The major function of buildings is to provide an acceptable indoor environment, which allows occupants to carry out various activities. Hence, the purpose behind this energy consumption is to provide a variety of building services, which include weather protection, storage, communications, thermal comfort, facilities of daily living, aesthetics, work environment, etc. In this section, proposed strategies are connected to the three main energy-related building services: space conditioning (for thermal comfort), lighting (for visual comfort), and ventilation (for indoor air quality).

### 2.6.1 Definitions

Basically, the level of human comfort differs from space to other depending on occupants' behavior and outdoor climate. As well as, human thermal environment is made up by the complex interaction of air temperature, mean radiant temperature, air velocity and humidity, (Prek, 2006 and Hensen, 1991).

Studying building's interior comfort and energy demand needs studying the mean ambient air temperature ( $T_a$ ) that can be used to evaluate heat transfer from outside to inside buildings through walls by conduction.

**Thermal comfort** is generally defined as the condition of mind which expresses satisfaction with the thermal environment. Thermal comfort is strongly related to the thermal balance of the body, (Hensen, 1991). Human body continuously produces heat by its metabolic process and this heat differs according to the nature of activities (70W in sleep to over 700W in heavy work). This heat must be dissipated to the environment or else the body temperature will increase, (Szokolay, 2008). As well, dissatisfaction may be caused by the body through unwanted heating or cooling of a particular part of the body. The conditions of thermal comfort state that heat loss should equal to heat gain, deep body temperature is about 37 C° and skin temperature can vary between 31-34 C°, (Ministry of local government, 2004).

**Heat transfer** is energy in transition due to temperature differences. The body exchanges heat with its surroundings by conduction, convection, evaporation, and radiation. If heat is lost, one feels cool. In case of heat gain from surroundings, one feels hot and begins to perspire. Movement of air affects the rate of perspiration, which in turn affects body comfort, (Long & Sayma, 2009).

**Heat balance:** The steady-state model developed by Fanger assumes that the body is in thermal equilibrium with negligible heat storage while the rate of heat gain equals the rate of heat loss, (Prek, 2006).

That mean, if the gains are greater than the losses, the building will gradually heat up and need for cooling system. Similarly, if the losses are greater than gains, the building will gradually cool down and need for heating system. The gain related to internal gain including lighting, equipments, and people. Also, it occurs through ventilation, solar radiation, and conduction by building envelop. In other hand, loss occurs through infiltration and evaporation. All of these values are added to the sum of these multiplications, (Melo & Lamberts, 2009). If the building is designed to be in balance state, the need for energy reduces automatically.

## 2.6.2 Factors Influencing Human Comfort Inside Buildings

Many variables affect heat dissipation from body, thus thermal comfort. These variables include environmental factors, personal factors, and other contributing factors, (Szokolay, 2008). Basically, the comfortable temperature ranges from 19C° to 28C° to optimize indoor thermal comfort for people. This temperature range is appropriate for the sedentary or near sedentary physical activity levels that are typical of general office work, (Department of Labor, New Zealand, 2007).

As mentioned before, the Fanger Model is the most commonly used for typical buildings that rely solely on active mechanical system. It defines comfort in terms of air temperature and humidity because these parameters are easy to measure and control. It prescribes a relatively narrow range of acceptable levels which, in common practice, do not vary with outdoor conditions on a daily or yearly basis, (Mikler et al., 2008).

- **Environmental factors**

**Temperature:** Air temperature is very significant factor in achieving thermal comfort because it determines convective heat dissipation, (Szokolay, 2008). The comfortable temperature depends on clothing level and type of work. To make people feeling comfortable, temperatures may range in summer about 19-24 C° (16-21C° in

heavy work) and in winter range about 18-22 C° (16-19 C° in heavy work), (Department of Labor, New Zealand, 2007).

**Humidity:** refers to the amount of moisture in specific amount of air. High humidity restricts the evaporation from the skin and respiration, thus kerb the dissipation mechanism. Whilst low humidity leads to drying out mouth and throats, as well as skin causing discomfort, (Szokolay, 2008).

**Air movement** accelerates convection, increases evaporation from the skin, and reduces clothing surface resistance, thus producing psychological cooling effects. Subjective reaction to air movement are: less than 1 m/s is stuffy and greater than 1.5 m/s is annoying but in over heated condition, air velocities up to 2 m/s may be welcome, (Szokolay, 2008).

**Radiation** exchange depends on the temperature of surrounding surfaces, measured by the mean radiant temperature. In summer, the solution is no direct exposure to radiant heat source such as using shading devices. In winter, the solution is exposure directly to solar radiation, (Department of Labor, New Zealand, 2007).

- **Personal factors**

Several personal factors are relevant to thermal comfort, including one's general state of health. Physical fitness, along with some medication, affects one's ability to adapt to small variations in the surrounding temperature, and hence can affect one's thermal comfort. Thermal discomfort may not cause an immediate health and safety problem, but it will affect morale, and feelings of tiredness and irritability, this may lead to a lack of productivity, (Department of Labor, New Zealand, 2007).

**Metabolic rate (activity):** For most people, daily activity consists of a mixture of specific activities and/or a combination of work and rest periods. A weighted-average metabolic rate may be used, provided that the activities frequently alternate, i.e. several times per hour. The unit used to express the physical activity of humans is the met. Where 1 met = 58.2 W.m<sup>2</sup>. One met is an average metabolic rate for a person seated at rest. The average body surface area for adults is about 1.8 m<sup>2</sup>; therefore 1 met is equivalent to approximately 100 W of total heat emission, (CIBSE Guide A, 1999). See appendix B

**Clothing** is the most controllable factor that assists people to lose body heat when they are feeling warm, and to retain it when we are cold, (Department of Labor, New Zealand, 2007). Clothing level is measured in "col" value, 1 clo = 0.155 m<sup>2</sup>.KW<sup>-1</sup>, (CIBSE Guide A, 1999). During the summer months typical clothing ensembles have clothing insulation values ranging from 0.35 to 0.6 clo. During winter, people wear thicker, heavier ensembles, usually with more layers. A typical indoor winter ensemble would have an insulation value of 0.8 to 1.2 col, (CIBSE Guide A, 1999). See figure (2.19).



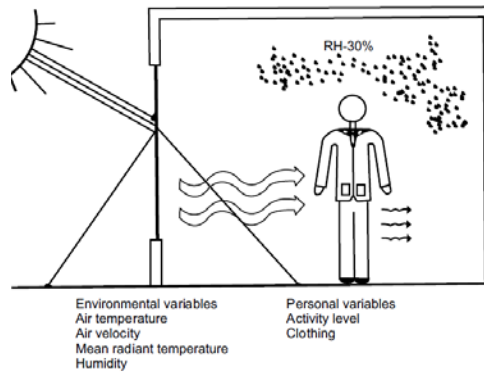


Figure (2.19): Factors influencing human comfort inside buildings, (Ministry of local government, 2004)

The relationship between air temperature and humidity is presented in graphical form called Psychrometric chart of human comfort which helps describing the climate data and human thermal comfort conditions. As shown in figure (2.20), psychrometric chart outlines the conditions at which most sedentary humans are comfortable; one envelope is for winter comfort and one for summer comfort. There is a difference because of the amount of clothing worn in the two different seasons. Any point located on the chart establishes the temperature (dry bulb) and the amount of water vapor in a unit quantity of air. If we were to select one temperature at which most humans would be comfortable year round, it would be around 74F (23C) , (Arizona State University, 2002).

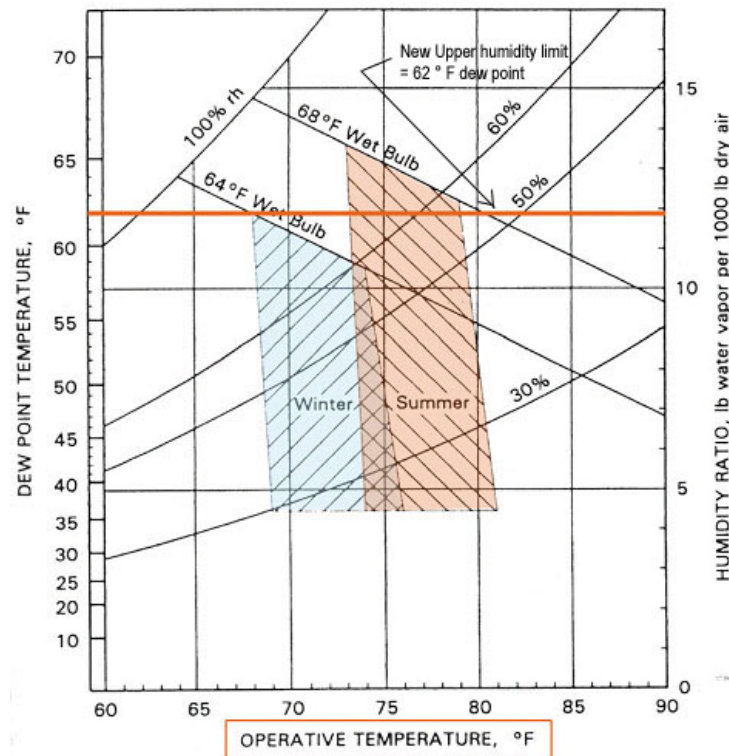


Figure (2.20): Psychrometric chart, (Arizona State University, 2002)

## 2.7 Passive Solar Design

Thermal comfort of people is affected by thermal performance of environment. Thus, people usage of spaces is affected by their perception of thermal conditions.

Therefore, finding the best passive solutions to the problems of building design in term of achieving comfort conditions and minimizing energy consumption related to the designer experience, building itself, and overall climate in the region. As well as, the effectiveness of passive strategies depends on the range of acceptable thermal comfort parameters set for the project.

As mentioned before, 50 % of energy consumption is used in construction all over the world. The most of it goes into heating, cooling, lightening, and into growing needs for devices such as refrigerators, heaters, computers, and others, (Edward, 2002). In this context, many solutions are discussed in trying to alter the building from consumed energy to non-consumed energy that called passive solar design techniques. The ultimate vision of passive design is to eliminate requirements for active mechanical systems and to maintain occupant comfort at all times.

### **2.7.1 Definitions**

Passive solar designs have three limitations: greater reliability, lower costs, and longer system lifetimes. It does not require mechanical heating or cooling systems. Homes that are passively designed take advantage of natural climate to maintain thermal comfort and reduce energy consumption, (Chiras, 2002).

Ochoa and Capeluto, (2008) defined passive design as "a series of architectural design strategies used by the designer to develop a building that can respond adequately to climatic requirements among other contextual necessities", (Ochoa and Capeluto, 2008).

While Raba, (2005) in his definition of passive building design, connected comfort conditions with minimizing energy consumption, the passive solar design according to Reba is "the utilization of the sun's energy together with the characteristics of a local climate and materials of the building, to directly maintain thermally comfortable conditions within built-environment, while minimizing the energy consumption", (Raba, 2005).

The utilization of passive techniques in modern buildings to achieve thermal comfort allows the possibility of decreasing the dependence on fossil energy as much as possible. Therefore, passive design is economical benefit because it does not depend on the imported fossil fuel. As well as it does not require transmission lines, pipe lines, or strip mines, they produce neither dangerous radioactive wastes nor polluted air and water. They can use renewable and recyclable materials, and they produce jobs, (Edward, 2002).

### **2.7.2 Passive solar Design Types**

Buildings as part of the environment infrastructure will need to withstand climatic change conditions for long time span. There has been a dynamic interaction between buildings system and climate includes a large number of difficult-to-predict variables, (Guan, 2009). A clear understanding of various design principles, methods and techniques of construction employed and used materials would be useful in buildings by judiciously adopting them even while using suitable modern materials and modern technology. Appropriate passive solar design should consider key building parameters

such as building orientation, building shape, facade glazing design, obstruction by surrounding buildings, vegetations, and other, (Morrissey et al., 2011).

There are two types of passive solar design:

- **Passive solar heating** use building design to harness solar radiation and capture the internal heat gains. Passive solar heating combines a well-insulated envelope with other elements that minimize energy losses and harness and store solar gains to offset the energy requirements of the supplemental mechanical heating and ventilation systems, (Mikler et al., 2008). Major strategies of it include:

- Southerly orientation of window areas.
- Deciduous trees to let sun get in spaces.
- Thermal mass for storing heat.
- Minimizing heat loss with insulation, draught sealing and advanced glazing.
- Using floor plan zoning to get heating to where it is most needed and keeping it there.
- Generation of heating potential by using many systems such as: Tromb wall system, solar chimney, roof pond, and sun space, (Reardon, 2010). See figure (2.21)

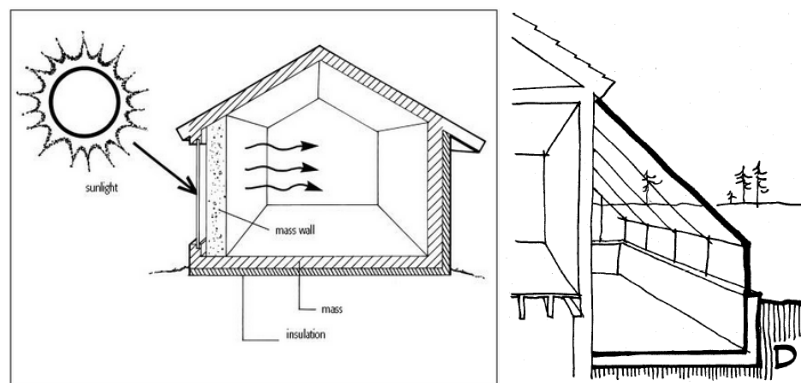


Figure (2.21): Tromb walls and sun space are an example of passive solar heating, (Chiras, 2002)

- **Passive solar cooling** strategies prevent the building from overheating by blocking solar gains and removing internal heat gains (e.g. using cooler outdoor air for ventilation, storing excess heat in thermal mass) , (Mikler et al., 2008). Major strategies of it include:

- Block heat from entering by natural and non-natural obstruction.
- Minimize heat generated.
- Ventilate to remove heat and move air. Show figure (2.22)

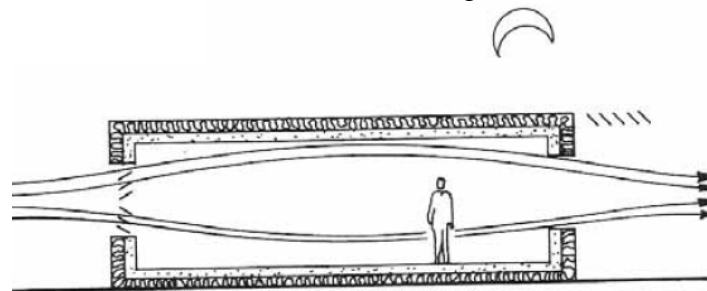


Figure (2.22): Night ventilation is one type of passive solar cooling, (Paipai, 2006)

### 2.7.3 Passive solar Design Techniques in Buildings

Generally, the following strategies are appropriate for the concept of passive solar design in buildings:

- **Site selection and orientation:** well positioned building on its site delivers significant lifestyle and environmental benefits. Correct orientation assists passive heating and cooling, resulting in improved comfort and decreased energy bills. In less moderate climates, appropriate orientation is a highly effective way to lower energy use and, it may be simple and inexpensive to accomplish when design at early stages, (Morrissey et al., 2011).
- **Building forms:** Buildings geometry is very important technique that can be designed to response to the microclimate needs and reduce building energy intensity. Many factors influence building shape to be sufficient energy building such as planning considerations, building type and use, feasibility and initial cost. For example, a compact building shape can reduce the building's energy intensity and reduce the need for active mechanical systems, (Mikler et al., 2008).
- **Building materials:** Interior and exterior materials have great impacts on the heat gain and loss, thus energy consumption. Therefore, a chosen best material depends on thickness, colors, thermal properties, and environmental effect.
- **Building insulation level:** Many factors intervene in choosing best insulation such as cost of insulation materials, orientation, building shape, functions, and insulation position. Buildings with different insulation levels and internal heat gains will have different temperatures, which need to be factored into the simplified degree-day method for the determination of insulation level, (Roaf et al., 2001).
- **Building glazing and openings:** Openings play a vital role by allowing natural ventilation and lights in the interior spaces and also, provide access to views. As it is the weakest elements in the buildings openings should be carefully placed on the south, north, east and west facades according to the desire and non-desire solar radiation. The passive solutions that make energy-efficiency windows include controlling the thermal characteristics of windows materials, (Mikler et al., 2008).
- **Natural ventilation:** the best way to cool a house with moving air without using mechanical power is to open windows and doors. Natural ventilation is the movement of room temperature air and between buildings, or even slightly warmer air across our skin causes a cooling sensation. This is because of the removal of body heat by convection currents and because of the evaporation of perspiration, (Anderson and wells, 2005).
- **Day lightening:** refers to the technique to bring natural light in a building, through openings. Natural light comes from the sky vault (it is called diffuse light), the sun (sunlight) and also reflections on the outdoor environment (outdoor reflected light), (Fontoynt et al., 2004). The contribution of natural day lightening in energy consumption and achieving comfort conditions is widely approved. In buildings, solar light may save more energy and money by reducing the need for artificial electric lighting, thus reducing electric light bills than it saves by reducing fuel bills, (Anderson and wells, 2005).

- **Building zoning:** Building functions with particular thermal requirements should be placed in areas of the building that can provide comfort conditions without mechanical intervention. For example, computer labs or other rooms that have large internal heat gains and thus require mostly cooling should be placed on north or east-facing facades to minimize energy use from mechanical cooling, (Mikler et al., 2008)
- **Shading devices:** The main function of shading devices (external or internal) is to block solar radiation. Shading requirements vary according to climate and house orientation. In climates where winter heating is required, shading devices should exclude summer sun but allow full winter sun to penetrate and vice-versa in the summer. This is most simply achieved on north facing walls. East and west facing windows require different shading solutions to north facing windows, (Mikler et al., 2008).
- **Landscape shading:** Proper landscaping can offer beauty as well as comfort and energy savings, both in winter and in summer. Concrete devices block solar radiation but absorb heat and transfer it to the building. Trees block solar radiation with cooling effects because the effect of evapo-transpiration.

Evergreens can greatly slow arctic winds and large deciduous trees appropriate to hot region that can provide shade and summer cooling. Most deciduous trees shed their leaves in the winter to let the warm sun in. Well-shaded and landscaped paving will often encourage people to walk or bicycle rather than ride in an energy-consuming car. Chapter 3 discussed with detailing the trees benefits and configurations.

## 2.8 Conclusion

In this chapter, environment and energy problems were discussed deeply to find out the best possible solutions. It illustrated that urban heat island and environment pollution are the main reasons for climate change. In the same time they were considered the main consequences of global warming phenomenon. Urban heat island (UHI) and Environment pollution is well-related and affected by each other. As urban heat island raises temperature and causes environment pollution, environment pollution also raises temperature and contributes to increase urban heat island effect. The situation of environment and energy demand in the Gaza Strip is also discussed in terms of environment and energy problems. The chapter outlined the responsive buildings strategies for climate and energy in term of thermal comfort and reducing energy consumption. Generally, human behavior and microclimate in urban spaces is the most important factors that lead the designer to the best techniques of passive solar design.

The chapter concluded that the best way to improve indoor air quality and reduce temperature is to understand human comfort requirements, thus the behavior of energy inside and outside the building. In hot and humid climate, passive solar design is the best solution for comfort achieving and in the same time the less in consuming energy, thus reducing fuels costs. It is important to understand these techniques and choose the best for climate and buildings. For this purpose, trees and vegetations will be discussed in the next chapter because they are considered one of the most passive solar strategies appropriate in hot and humid climate (Mediterranean climate).

## **Chapter 3: The Effect of Trees on Buildings Microclimate**

### **3.1 Introduction**

Many global environments concerns were discussed deeply in the previous chapter. Global warming, Greenhouse gas effect, urban heat island and environment pollution are the most important world issues in the present and future era. Therefore, many aspects of passive solar design strategies were outlined generally to develop efficient energy buildings. Those buildings strategies are responded properly to the climatic and environmental problems including urban heat islands and environment pollution.

Landscaping and trees configurations are one of the most effective natural passive design strategies. Choosing the best trees configurations requires understanding the trees benefits, trees diversity and the strategies to plant right trees in the right place. This chapter focuses on the benefits of trees that are considered the most important elements in urban context. Thus, the main trees microclimate modifications are discussed because of its importance for the outside and inside environment. Finally, the strategies of planting trees near the buildings and its configurations (species, numbers, and distances) are overviewed. They are targeted in the practical study which uses the climate and trees patterns in the Gaza Strip.

### **3.2 Trees Identification**

Trees are alive and eternal woody plant. They are an important component of the natural landscape because of their multi-benefits and important in agriculture because of their crops and fruits. Their wood is considered as primary energy source in many developing countries. As shown in figure (3.1) trees have three main parts: roots, trunk, and crown (branches and leaves), (Parish, 1948).

- Roots are anchoring the tree to the earth and are absorbing water and nutrients from the soil.
- Trunk has several layers and jobs: the outer bark that protects the tree from fire or insects and insulates it from extreme heat and cold, the phloem is the layer of cells that forms a pipeline to carry sugars from the leaves to the rest of the tree, the cambium is the growing part of the hunk that grow more slowly in the winter and this slower growth produces the tree's annual rings that help finding the age of a tree, the sapwood is the pipeline that carries water and nutrients from the roots up to the leaves, and finally, heartwood is dead wood in the centre of the tree that gives the tree its strength, (Parish, 1948).
- Needles or leaves make sugar from air and water. They do this by a chemical process called photosynthesis in which energy from the sun, carbon dioxide from the air, and water recombine to form sugars and oxygen. It includes stomata that are tiny holes that control the amount of air that enters and leaves the tree and chlorophyll is a chemical that makes leaves green. It is found inside the plant's cells where chloroplasts absorb the sun's energy for photosynthesis, (Parish, 1948).

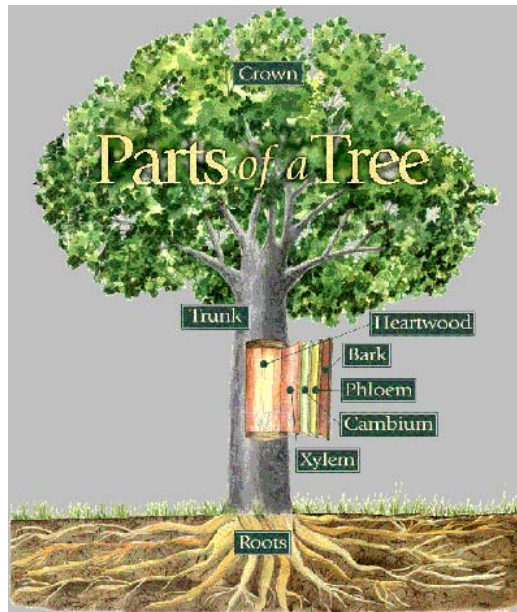


Figure (3.1): Parts of tree, (urban green, 2007)

### 3.3 Benefits of Trees

Trees provide multiple benefits for environment and human. Proper trees care and management programs are important to health, longevity, and sustainability of urban context. The care of trees is a wise investment today and future. Most trees and shrubs in cities are planted to provide beauty or shade. Woody plants also serve many other purposes, and it often is helpful to consider these other functions when selecting a tree or shrub for the landscape. Vegetations area and trees are the “lungs of the earth”, and work against climate change. There is a purifying and moderating role for trees and forests related to water that is more important now than ever. As shown in figure (3.2) these benefits are so familiar and are just some of the many benefits.

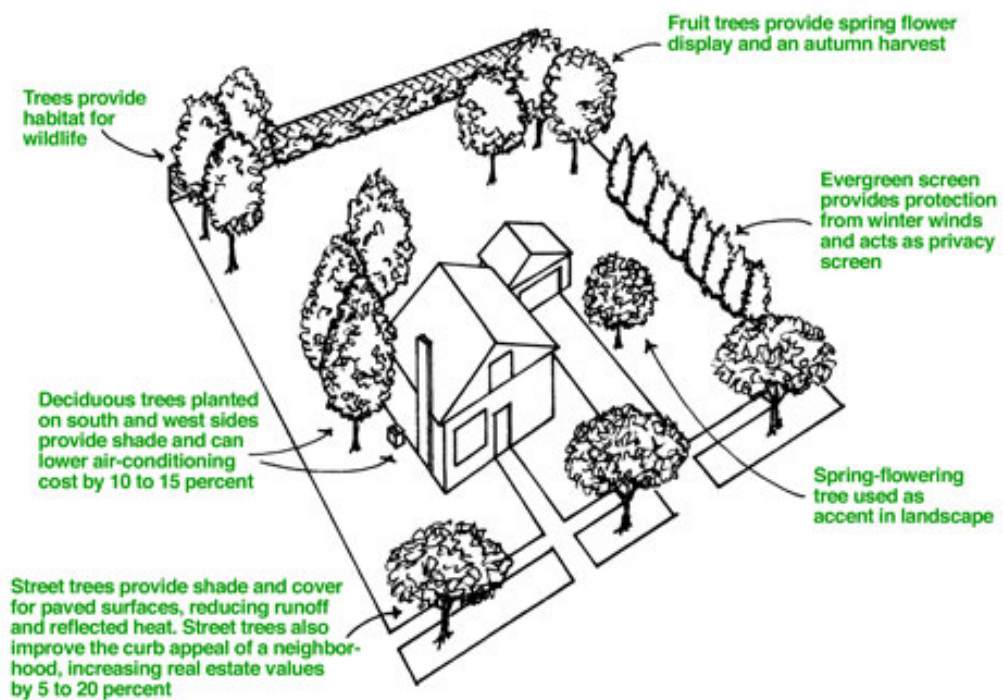


Figure (3.2): Benefits of trees, (International Society of Arboriculture, 2005)

### **3.3.1 Air Quality**

Poor air quality is a common problem in many urban areas and affects the health of people and environment as well. Air quality improvement increases with increased percent tree cover and decreased boundary layer heights. Urban vegetation and trees can directly and indirectly influence local and regional air quality by altering the atmosphere through, (McPherson et al., 2001):

- **Air pollution removal**

Trees can remove pollutants gas from air by uptake through leaf stomata and some gases are removed by the plant surface. Practically, gases diffuse inside the leaf into intercellular spaces. Then absorption by water films forms acid or react with the inner surface of leaves. Pollution removal by trees happen exactly when it intercept airborne particles. Factors that affect pollution removal by trees include the amount of healthy leaf surface area and soil, concentrations of local pollutants, and local meteorology, (Nowak and Dwyer, 2000).

Average improvement in air quality from trees during the in-leaf season among Boston and New York cities were 0.7% for particulate matter less than 10 microns (PM10); 0.3% for ozone (O<sub>3</sub>) and sulfur. Trees can reduce atmospheric CO<sub>2</sub> by directly storing carbon (C) from CO<sub>2</sub> as they grow. Large trees store approximately 3 metric tons of carbon or 1000 times more carbon than stored by small trees, (Nowak and Dwyer, 2000).

- **Biogenic volatile organic compounds (BVOC) emissions**

Some trees emit volatile organic compounds (VOCs) such as isoprene and monoterpenes into the atmosphere. These compounds are natural chemicals that create useful oils, resins, and other plant products and can attract pollinators or repelling predators that encourage the biodiversity.

Isoprene provides thermal protection to plants by helping prevent irreversible leaf damage at high temperatures. VOC emissions rates vary by species, air temperature, and other environmental factors. VOCs can forms ozone (O<sub>3</sub>) and carbon (CO) that depends on temperature mainly, because of that tree can lower air temperature. The denser the trees cover is, the lowers overall VOC emissions are and consequently ozone levels in urban areas, (Nowak and Dwyer, 2000).

### **3.3.2 Carbon Storage and Sequestration**

As shown in figure (3.3) trees can reduce atmospheric CO<sub>2</sub> directly by sequester carbon CO<sub>2</sub> from atmosphere and indirectly by create cooling effects through shading or temperature reduction, thus reduction the need for air conditioning thereby reducing the amount of CO<sub>2</sub> dumped into atmosphere, (Akbari et al., 1992).



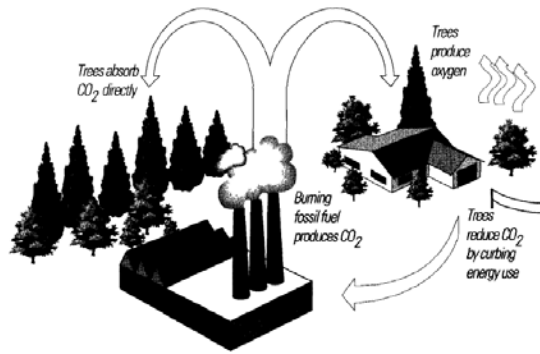


Figure (3.3): Sketch for trees functions in reducing CO<sub>2</sub> directly and indirectly, (Akbari et al., 1992)

### 3.3.3 Energy Conservation

Trees can reduce building heating and cooling energy needs. They save energy by cooling surrounding environment in the hotter months and act as windbreak during winter. Thus, less fossil fuel is burned to generate electricity for cooling and heating, (McPherson et al., 1988). Shading, windbreak, and evapo-transpiration are the main three methods to reduce energy use by trees. Shading helps to block solar radiation through windows, walls, and soil, thus reduce cooling needs. Trees shading is beneficial during the summer but not in the winter. As shown in figure (3.4) the best chosen of trees species such as deciduous trees help to block solar radiation in summer and let it in winter, therefore it is very important to reduce energy demand for both cooling and heating in summer and winter, (Akbari et al., 1992).

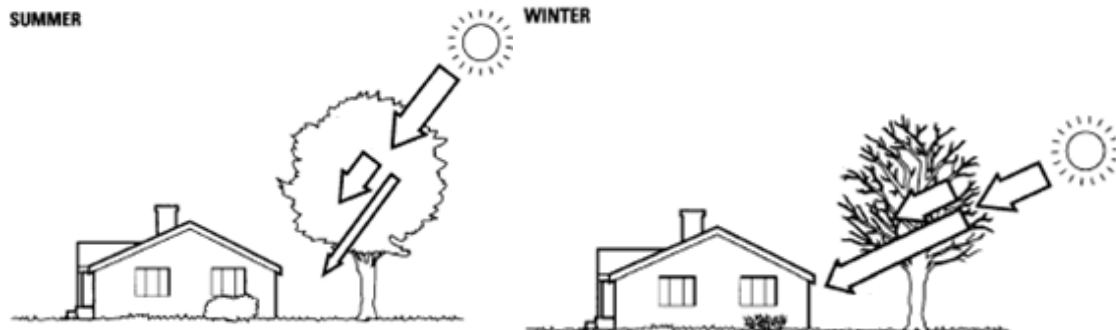


Figure (3.4): Deciduous trees behavior during summer and winter, (Akbari et al., 1992)

Trees also, play as wind barriers in windy regions by reducing wind speed. It can either decrease or increase both cooling and heating energy use, depending on local weather conditions, (Akbari et al., 1992). Beside the effect of shading and wind breaks on energy saving, trees give cooling effects through evapo-transpiration process. Water from roots is drawn up to the leaves where it evaporates. The conversion from water to gas absorbs huge amounts of heat, cooling hot city air, (Arborilogical Services Inc., 2012).

### 3.3.4 Economic benefits

Trees benefits can save money directly through reduction of electricity bills of air conditioner and indirectly through improvement human health, thus reduction in health care cost. According to national renewable energy laboratory, a well design landscape provides enough energy savings to return initial investment in less than 8 years.

Carefully positioned trees can save up to 25% of household energy consumption for heating and cooling, (National Renewable Energy Laboratory (NREL) and DOE, 1995). Also, according to Simpson and McPherson 1998, trees can save cooling energy cost by 1.9%-2.5% per residential tree, (Simpson and McPherson, 1998).

Trees in urban setting have a refreshing effect that releases the tensions of modern life. Evidence demonstrating the therapeutic value of natural settings has emerged in physiological and psychological studies. The cost of environmental stress in terms of work-days lost and medical care is likely to be substantially greater than the cost of providing and maintaining trees, parks, and urban forestry programs, (Arborilogical Services, Inc., 2012).

Private benefits of urban trees can include enhancement of real-estate values, the tree's wood value, and the cost value of gathering fruits from fruit trees, (Scott and Better, 2000). The sales value of real estate reflects the benefits when it includes vegetations. Houses with mature trees are preferred to comparable houses without mature trees, (Georgi and Dimitriou, 2010). A survey of sales of single-family homes in Atlanta indicated that landscaping with trees was associated with an increase in sales prices of 3.4 to 4.5%. Builders have estimated that homes on wooded lots sell on average for 7% more than equivalent houses on un-wooded lots, (Nowak and Dwyer, 2000).

In other hand, trees enhance community economic stability by attracting businesses and tourists, apartments and offices in wooded areas rent more quickly have higher occupancy rates and tenants stay longer and also, businesses leasing office space in wooded developments find their workers are more productive and absenteeism is reduced, (USAD forest service, 1990).

### **3.3.5 Water Conservation and Storm Water Management**

Trees and soil can play an important role in water management. By intercepting and slowing the flow of precipitation reaching the ground, trees can reduce the rate and volume of storm water runoff, flooding damage, storm water treatment costs, and other problems related to water quality, (Nowak and Dwyer, 2000).

Heavy rain runoff erosion and flooding are great problems in urban areas that include concrete, asphalt, and rooftop surfaces. These impervious surfaces accelerated soil erosion by forcing water to hit protected soil and forms deep channels, but trees can prevent that by obstruction the water and eliminate its speed, (Akbari et al., 1992)

Trees also, increases water quality, by reducing the pollution of the water runoff by as much as 80%. Healthy, vegetated stream buffer zones reduce the total suspended solids phosphorus, nitrogen and heavy metal transfer between urban areas and streams by 55% to 99%, (Arborilogical Services, Inc., 2012). As shown in figure (3.5) trees roots hold soil in place and increase water infiltration and increased ground water recharge that is significantly reduced by concrete paving, (USAD forest service, 1990).



Figure (3.5): Trees roots hold soil in place and increase water infiltration, (USAD forest service, 1990)

### 3.3.6 Wildlife and Biodiversity Conservation

Trees and associated plants create local ecosystems that provide habitat and food for birds and animals. They offer suitable mini-climates for other plants that would otherwise be absent from urban areas. Urban wildlife can serve as biological indicators of changes in the health of the environment and can provide economic benefit to individuals and society. Urban forests can act as reservoirs for endangered species. In addition, urbanites are increasingly preserving, cultivating, and restoring rare and native species and ecosystems. Consequently wild animals provide the animations that please visitors and this make the environmental awareness and concerns about quality of life, ecological benefits of the urban forest increase over time, (Akbari et al., 1992 and Nowak and Dwyer, 2000).

### 3.3.7 Noise Reduction

Field tests have shown that properly designed plantings of trees and shrubs can significantly reduce noise by absorbing it by ground and blocking it by leaves and stems. Trees and shrubs should be planted close to the noise source rather than the receptor area for maximum noise reduction, (Nowak and Dwyer, 2000). Vegetation also can mask sounds by generating its own noise with leaves movement and birds singing in the tree canopy. These sounds contribute to reduce the annoying noises because people are able to filter unwanted noise while concentrating on more desirable sounds. The effectiveness of perception noise by trees depend mainly on trees configurations, sound source, receiver, and climatic conditions, (Nowak and Dwyer, 2000).

### 3.3.8 Human Health Conservation

Trees can add natural character to cities and towns; provide it with colors, flowers, and beautiful shapes, forms and textures, soften the outline of masonry, metal and glass, and can be used architecturally to provide space definition and landscape continuity, thus improve human mood and emotion. Trees create feelings of relaxation and well-being, provide privacy and a sense of solitude and security, shorten post-operative hospital stays when patients are placed in rooms with a view of trees and open spaces, , (USAD forest service, 1990). Beside the psychological effects, trees can improve air

quality as for mentioned resulting in poisonous gases and pollution reduction, thus improve health of people and reduce multiple diseases.

### 3.4 Trees as Natural Microclimate Modifications

An urban architectural complex is formed by buildings and their surrounding elements such as trees, vegetation and roads. The microclimate of urban context is modified by components that are important in creating and generating the ambiance of microclimate. It defines the microclimate as the conditions of solar and terrestrial radiation, wind, air temperature, humidity, and precipitation in an outdoor space. Trees alone can affect the microclimate by modify four of these components. Georgi and Dimitriou listed the trees characteristics that affect the urban microclimate positively as follow, (Georgi and Dimitriou 2010):

- The high rate of solar radiation absorption;
- The low heat capacity and thermal conductivity compared to the materials of buildings and open pavements;
- The reduction of air temperature via transpiration;
- The decreased infrared radiation;
- The reduction of wind speed around the soil;
- The removal of dust and pollutants from the air;
- The noise reduction

With more details, solar, wind, temperature, and humidity are discussed as follow:

#### 3.4.1 Solar Radiation Modification

It is known very well that the radiation is a factor that can be modified by vegetation objects especially trees. Radiation can be defined as radiation from the sun (solar) or the radiation emitted by objects on earth (terrestrial), (Shahidan et al., 2010). Solar energy arrives on earth over a range of wavelengths: ultraviolet, visible and solar infrared. Ultraviolet wavelengths (10-8 m) are too short for our eyes to see and many of these photons are consumed by ozone in the stratosphere. Most of the solar energy that reaches to the earth is visible light and solar infrared. As see in the figure (3.6) the visible wavelengths or energy, which is commonly termed light (10-7 m), is absorbed by the leaves of plants for photosynthesis. But, solar infrared (10-5 m) is not used for plant photosynthesis and is rejected by leaves through reflection or transmission. Meanwhile solar infrared does not affect the human and buildings energy, (kotzen, 2003; Shahidan et al., 2010).

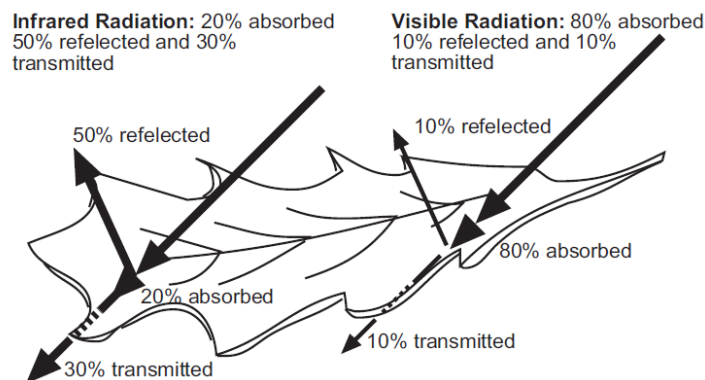


Figure (3.6): Leaf absorption, reflection, and transmitted, (kotzen, 2003)

On the other side, radiations emitted by objects on the earth depend on the factors of reflection, absorption, and transmission. This depends on the surface's reflectivity or albedo of the surface material. The albedo of the surface is the ratio of reflected radiation from the surface to incident radiation upon it. It depends on the frequency of the radiation, when quoted unqualified, it usually refers to some appropriate average across the spectrum of visible light. An object that has high albedo (near 1) is very bright; an object that has a low albedo (near 0) is dark. The Earth's albedo is about 0.37, and the Moon's albedo is about 0.12., (Taha, 1997; Shahidan et al., 2010).

The canopy of trees creates shade that is an important factor in the radiation exchange process of ground and wall surfaces. The shade indicates a reduction in downward energy flow, particularly of visible light and solar infrared. This shade is able to block and store heat from direct solar gain and hence reduce surface temperature, (kotzen, 2003; Shahidan et al., 2010). Therefore, shading by trees is significant in reducing the surface temperatures in urban built-up areas in hot, dry, and tropical climates.

### **3.4.2 Wind Modification**

Wind is a significant climatic factor that can be modified by trees. Handling with wind speed reduction is more difficult compared to open land wind speeds, especially with tree clusters and due to the urban wind profile, (Shahidan et al., 2010). Wind is extremely variable, both in the direction from which it flows and in its speed. Each region in the world has wind rose that illustrates the prevailing direction of the wind that cannot be ignored in building design. Wind rose is a diagram that graphically displays the percentage of time the wind is from each direction, (Brown and Gillespie, 1995).

Wind would carry away heat from people and buildings in a hot, humid tropical climate and strongly influences their energy budget, (Shahidan et al., 2010). The effectiveness of wind on human comfort depends on the speed of wind, the difference of temperature between person temperature and air temperature, and the level of clothing, (Brown and Gillespie, 1995). Wind increases the amount of water lost from a tree to the atmosphere. Thus, trees shade is able to modify solar radiation and terrestrial radiation from the ground, (Gilman and Sadowski, 2007). Direction and speed of wind is affected by trees, the larger and denser they are, the greater the effect. For example, deciduous trees have great effect on summer but no effect on winter as wind modification, but ever green trees in winter have significant effect on winter which is much more acceptable in other seasons, (Brown and Gillespie, 1995).

It is very significant to take into account the characteristics of wind when locating trees and determining its species in windy region, (Brown and Gillespie, 1995). The following figure (3.7) illustrates the effect of trees as group on the wind speed and directions.

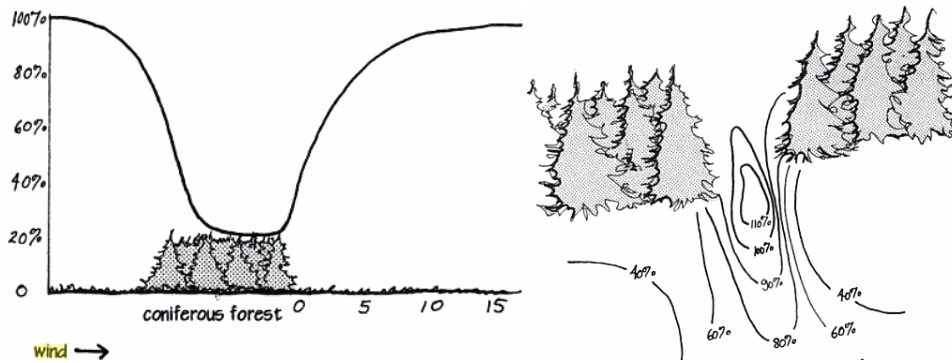


Figure (3.7): Effect of group of trees on wind speed and wind direction (Brown and Gillespie, 1995)

### 3.4.3 Temperature Modification

Air temperature is a measure of the average speed of the random motion of molecules that comprise a substance. In a tree microclimate, many studies consider mean radiant temperature an indication about pedestrian thermal comfort, thus inside buildings comfort. Fahmy, 2009 define mean radiant temperature  $T_{mrt}$  as "uniform temperature of an imaginary enclosure in which the radiant heat transfer from the human body equals the radiant heat transfer in the actual non-uniform enclosure", (Fahmy et al., 2009). Temperature is a physical property of matter that quantitatively expresses the common notions of hot and cold. Objects of low temperature are cold, while objects of high temperature are warm or hot, (Ritter, 2009).

Air temperature can be modified by trees as a result of blocking solar radiation and cooling the surrounded area by evapo-transpiration process, (Valsalakumari, 2008). Trees and vegetation absorb water through their roots and emit it through their leaves (transpiration) then the conversion of water from a liquid to a gas (evaporation), occurs from the trees and soil around vegetation, (Georgi and Dimitriou, 2010).

A tree leaves intercept, reflect, transmit, and absorb solar radiation. Figure (3.8) show the release of moisture into the atmosphere through leaves (transpiration), then the evaporation of water at the stomata into the air, causing cooling of the air through increasing latent heat and decreasing sensible heat within a tree environment, (Fahmy et al., 2009). A single tree may transpire 88 gallons of water per day. This is equivalent to five air conditioners with a capacity of 2500 Kcal/hr and run 20 hours a day, (Valsalakumari, 2008)

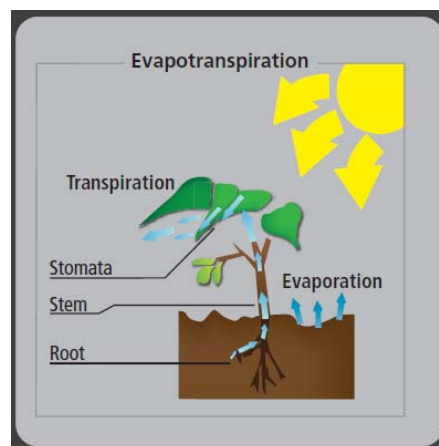


Figure (3.8): Evapo-transpiration process in plants, (Wong, 2008)

Trees can reduce surrounding air temperatures as much as 5°C and reduce air temperature under trees canopy as much as 14 °C cooler than air temperature above nearby black top. Wong, 2008 summarized main temperature reduction from evapotranspiration and shading resulting from various studies as follows, (Wong, 2008):

- Peak air temperatures in tree groves are 5°C cooler than over open terrain,
- Air temperatures over irrigated agricultural fields are 3°C cooler than air over bare ground,
- Suburban areas with mature trees that are 2 to 3°C cooler than new suburbs without trees,
- Temperatures over grass sports fields that are 1 to 2°C cooler than over bordering areas.

### **3.4.4 Humidity Modification**

Humidity is the amount of water vapor in the air. It commonly refers to relative humidity that expressed as a percentage of water in the weather. The humidity is affected by winds and by rainfall. Therefore humidity affects the energy budget and thereby influences temperatures in two major ways. First, directly during transpiration or evaporation, the latent heat is removed from surface liquid, and then cooling the earth's surface. Second, indirectly when water vapor acts as green lens in greenhouse that allows green light to pass through it but absorbs red light and that raise air temperature.

Trees play significant role in increasing atmospheric humidity. Trees raise atmospheric humidity in summer through transpiration that is the evaporation of water from the insides of leaves. Humidity is high under a forest canopy, the more foliage of tree; the greater is the amount of water added to the air, (Valsalakumari, 2008, Federer, 1976). Change of humidity by individual trees is insignificant enough that are not affect human comfort, (Federer, 1976). Humidity is quickly dissipated by air movement, but in any isolated area such as walled garden, the humidity will be sensible than surrounded area, (Brown and Gillespie, 1995). Generally, raising a humidity of the air is significant in hot, dry, and tropical climate.

## **3.5 Tree Planting Considerations**

Trees planting are a key element in urban landscape architectural design. McPherson, (2008) classified tree-planting strategies to three major categories: ensure survival rate and good physical growth, enhance aesthetics, and maximize environmental benefits, such as energy conservation and reduction of the urban heat island effect, (McPherson et al., 2008).

Building's microclimate may be more sunny, shady, windy, calm, rainy, moist or dry than average local conditions. As these factors help determine what plants may or may not grow in specific microclimate, they also help determine trees configuration including site preparations, desirable trees attributes, spacing between trees and buildings, and diversity between trees in specific site. This study focuses mainly on maximizing environmental benefits and minimizing energy use, so planting strategies relate directly with this purpose.

### **3.5.1 Site Characteristics and Site Layout**

First consideration is choosing trees sites in urban areas that depends mainly on many important factors include climate factors, soil characteristics, environmental conditions, planting space, site location, existing vegetation, aesthetics, land ownership and regulations, social influences, and maintenance requirements, (McPherson et al., 2008). The main important factors for trees planting to maximize energy savings and environment benefits include:

- **Sun exposure**

First point to be investigated in site and important for trees plantings are sun exposure hours that site receives in summer and winter. Sun exposure depends mainly on local climate and urban context including any obstructions or neighboring buildings. Scientifically, trees need direct sun with six hours at least to grow quickly and healthy. Most large trees grow best in full sun and some small trees grow best in site that receives shade for part of the day.

Even though the site might receive less than full sun because of shadow cast by near buildings, the trees must tolerate a high heat load during the sunny part of the day. Trees that grow in full sun and partial shade are best suited for such a site. This situation motivates to plant trees in sunny part of the site and help to limit alternatives of tree planting, (Gilman, 1997).

- **Slope exposure**

Topography is very important in choosing trees locations and orientations on the slopes. Transpiration and evaporation processes are enhanced on south and west directions thus cool the surrounded climate. In the same time, more difficult to maintain adequate soil moisture. The best solution for this problem is providing more irrigation to southern and western exposure vegetations to prevent desiccation, (Gilman, 1997).

- **Wind exposure**

Studying the exposure of site to the wind, its speed, and direction is very important to plant proper trees in proper place. Wind affect the amount of water lost from trees to atmosphere and this depend on trees type, local climate, and surrounded structures, (Gilman, 1997). The best way for eliminating water loss in windy site is proper site design and proper species selection. For example, trees are tolerant for drought is the best for such site. As well as to block wind close to ground, the best trees should have low crowns and dense foliage, (National Renewable Energy Laboratory (NREL), 1995).

- **Salt effects**

Definitely, airborne salt can affect trees through twigs, foliages, and roots after the deposition on the ground and leaches into the soil. Salt degree should be investigated in the site before plantings. On the regions that located on the coastlines with trees planted on one eighteenth mile of salt water coast lines, should possess some degree of tolerance to aerosol spray. Generally those trees deformed and grow poorly when exposed to salty air, (Gilman, 1997). Soil salts should be considered when planting trees. It is not a problem in rainy regions because it receives adequate precipitation to leach salts through the soil system. The most soil salts source is fertilizers that can be managed carefully to eliminate soil salts.



- **Infrastructure and power line**

Plantings trees should be as far as possible from power lines and drainage lines. Branches or roots should be calculated carefully for each tree and consider the distance between them and infrastructure lines. When branches reach wires, the utility company must trim them to ensure uninterrupted utility service. Unfortunately, this cost utility company and reduce foliage density, thus shading efficiency, (Gilman, 1997). Figure (3.9) illustrate the minimum distance between narrow canopy trees and power lines (40 feet) and only small trees should be planted beneath wires, (Gilman, 1997).

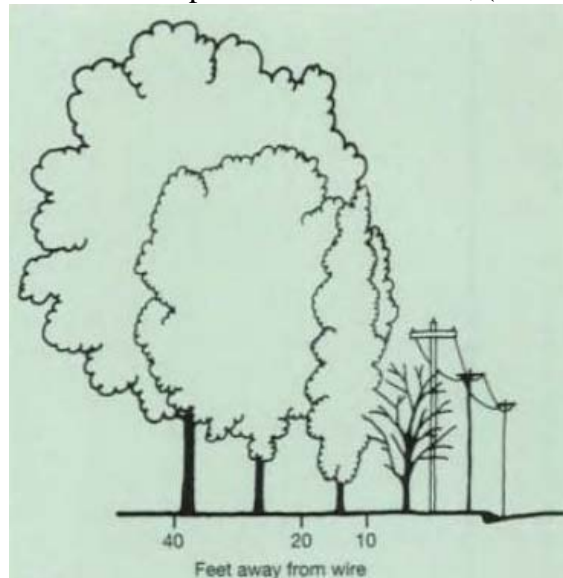


Figure (3.9): Relationship between trees size, distance, and power lines, (Gilman, 1997)

- **Soil characteristics and texture**

Soil characteristics including the pH of soil and texture are very important to plant best trees species. Soil (pH) governs the availability of soil microorganisms, (Gilman, 1997). PH scale range from 1 to 14, 7 are natural, below 7 are acid, and above 7 are alkaline. Most naturally soil have a pH of 5-8 and most valid for trees planting must have pH 6-6.5 because it provide the most favorable environment for nutrient availability. Few trees grow well in soils with a pH above 9 and many trees grow well in soils with a pH Between 4.8 to 7.2, (Gilman, 1997).

Soil texture is an indicator for soil attributes and deeply influences trees growth. Soil textures can be categorized to three main types: sand, silt, and clay. The ideal one for trees and vegetations is sandy loam soil because it drains faster than clay soil, (Gilman, 1997). Soil texture is important because it influence several other soil characteristics including structure, water holding capacity, and water, air, and nutrient availability.

### **3.5.2 Choose Desirable Trees Attributes**

Trees attributes include determining desirable trees functions, shape, aesthetics, and other growth attributes. Precisely, this study concentrates on trees that save energy, save money, and improve air quality by natural shading and evapo-transpiration process in summer, allowing solar radiation in winter, and photosynthesis process.

Buildings Thermal performance depends on trees foliage characteristics, as well as tree mature shape and botanical aspects included type of soil to be planted in, tree deciduousness, depth and radius of roots, capability of bearing site hazards and harsh climates. The following characteristics are the main important for achieving best thermal performance:

- **Function**

The first step to select a tree for any site is determining specific purpose of this tree. USDA Forest Service in their manual for urban forestry classified trees functions to the following, (Scufr, 2004):

• Provide shade	• Increase plant diversity
• Provide seasonal color, flowers, and fruit	• Reduce wind speed
• Serve as a landscape accent	• Increase community pride
• Increase property values	• Increase recreational opportunities
• Decrease energy costs	• Improve health and well-being
• Improve air quality	• Reduce noise levels
• Reduce storm-water runoff	• Reduce glare
• Decrease soil erosion	• Create buffer zone
• Improve water quality	• Provide screening
• Create wildlife habitat	• Provide privacy
• Assist with pedestrian and traffic flow	• Enhance architecture design

As shown in table (3.1), trees have multiple functions that are useful for people, buildings, environment beauty and community health and comfort. In the current study, providing shade is the main functions of trees that would be important for achieving human comfort and reducing energy consumption, thus reducing energy costs.

- **Mature size and Form**

The most appropriate form for particular site depends on the function of tree. Alive oak or sugar maple is more appropriate for shading and erosion control. A pyramidal tree with drooping branches such as pin oak is appropriate for wind obstruction, (Gilman, 1997).

Mature height, crown spread, trunk flare, and root space are important for pavements, structures, utility lines, and determining the solar benefits in both summer and winter. It would be best to select a small or medium-size tree for a site located under a utility line and place large tree to the south and west of the house for solar shading, (Scufr, 2004). These trees will cast cooling shadows in the summer and let the warm sun shine into the house in winter. In figure (3.10) illustrate diversity of trees size.

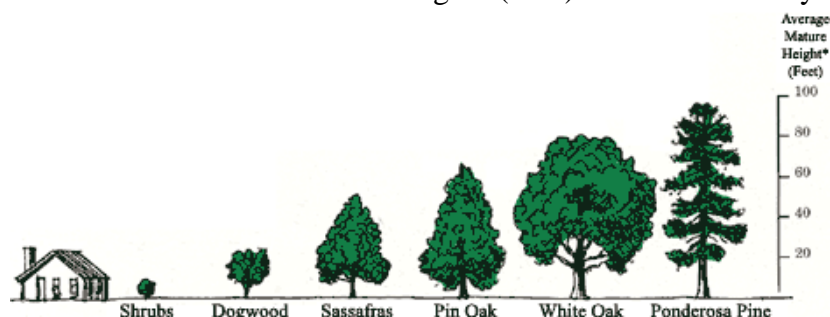


Figure (3.10): Diversity of trees size (height and spread), (Airhart and Zimmerman, 2003)

The shape of tree crowns varies with different species and varieties of trees. Selecting trees with specific crown forms is very important to cast proper shadow form and size on near buildings to obtain sizable energy saving. The following figure (3.11) show diversity of tree crowns that is classified as follows, (California Polytechnic State University & the Cal Poly Corporation, 2012):

- **Columnar:** erect and almost parallel, resembling a column.
- **Conical or Pyramidal:** oval at the base, elongated and tapering to a narrower width at the top.
- **Fan Palm:** fan shaped leaves with venation of the leaves extending like the ribs of a fan.
- **Oval:** appearing elliptical, resembling an egg.
- **Rounded:** ball-like or circular.
- **Umbrella:** branches extending outward and down, as an umbrella does.
- **Vase:** a narrow base, widening and arching outward towards the top.



Figure (3.11): Diversity of tree crowns and its shading forms, (The Arbor Day Foundation, 2012) and (Meerow and Black, 1993)

Height of trees means the height at maturity that is very important for solar reception. It can be classified to small tree (3.6m - 9m), medium tree (9m - 15m), and large tree (excess of 15m), (Kevin & Pat, 2009). As well as, total trees height should be classified to stem height without leaves and the crown height. There are trees with same height but different stem height, (Kevin & Pat, 2009) and this very important for solar reception in summer and winter because it relate with sun angle. As for mentioned deciduous tree is the best solution in winter and summer. Therefore evergreen trees with high stem can shade the building on summer and allow solar radiation to let into the building in winter. These trees with narrow and less dense crown such Pin tree has less shade effects than deciduous trees in summer. Consequently, high, wide-crowned trees with deciduous leaves are the best providers of shade, (Strother et al., 2012).

The amount of soil area for root growth is also required for successful growth to maturity. A limited root zone will have a negative effect on the survival of landscape trees. As shown in figure (3.12) root zones extend out from the trunk about 1.5 to 2.5 times the height of the tree, (Airhart and Zimmerman, 2003).

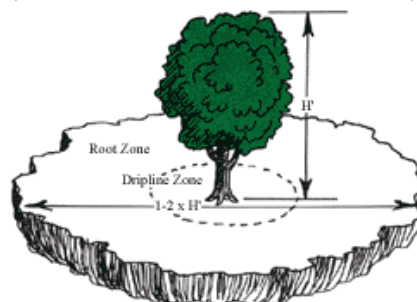


Figure (3.12): Tree roots extensions in the ground, (Airhart and Zimmerman, 2003)

Inadequate rooting space and heavily compacted soils can be an obstacle for expanding tree roots and limit water, nutrient uptake, and oxygen exchange necessary for successful plant growth. Common barriers to rooting space include sidewalks, roads, underground obstacles, soil compaction, and containers, (Vermont Urban & Community Forestry Program, 2001).

- **Longevity**

Limits of growth and life of trees are strangely diversified. Multiples of mature forms and perish in a few days or hours; while others, have survived the habitual period of their kind. Large maturing trees often live longer than small trees that affect the long-term benefits including cooling effects and energy savings, (Gilman, 1997).

Tree longevity varies from about 70 years to over 1000 years, depending upon the species. Short-lived species tend to be intolerant of shade and best located in un-forest areas such as aspens, paper birch, cherries, jack pine. Long-lived tree species such as sugar maple, basswood, beech, and white cedar provide more shade and employ more conservative survival strategies.

- **Canopy density**

Trees with dense canopies cast more shade and vice versa, (Gilman, 1997). Trees canopy density is expressed by Leaf Area Density (LAD) and Leaf Area Index (LAI) that are very important in studying trees' heat exchange with environment and achieving urban heat balance. Block radiation through flat leaves trees is significant for (LAI) because it dimensionless value of the total upper leaves area of a tree divided by the tree planting ground area, (Fahmy et al., 2010). Consequently, LAI for the same tree could vary from summer to winter according to its deciduousness and from age to another according to growth. In same context, LAD is important too, for the ability of trees' canopy on casting shadow, thus achieving thermal comfort. Theoretically, it is defined as "the total leaves area in the unit volume of a tree horizontal slice along the height of a tree". It gives an idea about vertical and horizontal leaves distribution, (Fahmy et al., 2010).

LAD and LAI are difficult to measure with accurate manner. Many studies measure it through field measurements or computer simulations. Mohammed Fahmy 2010 investigates the preferred LAI of tree to produce maximum shadow at peak hour in Cairo climate. Results show that a flat leaves tree if does not validate LAI of 1, the ground shading would not fulfill about 50% direct radiation interception and this value can be used as a reference for urban trees selection, (Fahmy et al., 2010).

- **Growth rate**

Growth is the biological phenomenon of increase in size with time. Growth involves the formation, differentiation and expansion of new cells, tissues or organs. Fast-growing trees provide their benefits quickly contrast to slow-growing trees, (Gilman, 1997). Slow growing species typically live longer than fast growing species. The factors affect trees growth rate include: initial spacing and treatment, silvicultural treatment, artificial thinning and pruning, site conditions (including nutrition), and climatic conditions, (Brack and wood, 1996). Long-term benefits of trees including shading and improving air quality require strong trees, even though growth rate.

### **3.5.3 Diversity of Tree Species**

Diversity of trees species is very important in any region of the world. Each region have seasonal climate between summer and winter, thus diversity of vegetations species. So, most professionals don't recommend arbitrary selection of several species on the same site in order to make trees useful in each summer and winter and avoid causal agent changes such as plants diseases, (Gilman, 1997). Native trees and shrubs resistant to drought and disease and appropriate to the site (especially soil) can reduce indirect energy inputs without large maintenance cost, (Parker, 1983). Georgi and Dimitriou confirm that suitable selection of the right species can enhance cooling through evapo-transpiration, thus reducing the temperature by up to 3.1°C in Greece, (Georgi and Dimitriou 2010).

A deciduous tree with high spreading crowns is more suitable for energy efficiency by blocking solar radiation in summer and vice versa in winter, especially if branches are pruned to maximize sun exposure, (Wong, 2008 and National Renewable Energy Laboratory (NREL), DOE, 1995). This strategy is helpful in Mediterranean climate when summer and winter are the dominant seasons in year, thus the energy consumption for cooling and heating is almost equal. In windy region with long winter and short summer, evergreen trees is helpful for overall energy efficiency. It can obstacle winter winds and reduce heating needs when planting it as far as enough from building and to allow solar radiation to get into building. It might be planted perpendicular to the main wind direction usually to the north or the northwest, (Wong, 2008).

## **3.6 Trees in the Gaza Strip**

The Gaza Strip is suitable region with moderate climate for planting many types of trees. Palestine has evergreen and deciduous, small and large, fruitful and fruitless, good shadier, and wind deflector trees. This diversity of species requires good understanding of trees species and its characteristics in Palestine and as well as in the Gaza Strip to plant it with good manner.

Beside trees ability to cast shade, different parts of useful trees are used by the Palestinians as direct food which includes: food cereals and pulses, root and tubers, oil, fruits and nuts, vegetables, herb, spices, drugs and medicinal plants. Other useful plants are used as raw material for industrial issues or as forages, fiber plants, and other miscellaneous purposes, (ARIJ, 1997).

### **3.6.1 Assessment of Planting Trees in Buildings Complexes and Street of Gaza**

According to Hadid (2002), several passive solar parameters in buildings of the Gaza Strip that achieve thermal comfort were discussed. Shading devices, landscaping, buildings orientations and others are examples of these parameters. However, building design in Palestine take into consideration the climate conditions, the way of employment these elements in reducing energy consumption is not considered. Planting trees in particular locations or choosing trees types doesn't take account for sun movement and solar radiation. Therefore, people tend to use air conditioning systems and mechanical ventilation to achieve comfort, thus increasing energy consumption.



Also, increasing population density plays significant role in this situation and increases the problems. As population density increases rapidly, the built up areas increase and vegetation areas decrease as well as. As shown in the following figure (3.13) Gaza consists of crowded urban geometry. Residential buildings form the highest percentage that considered the most building consumed energy in the region.

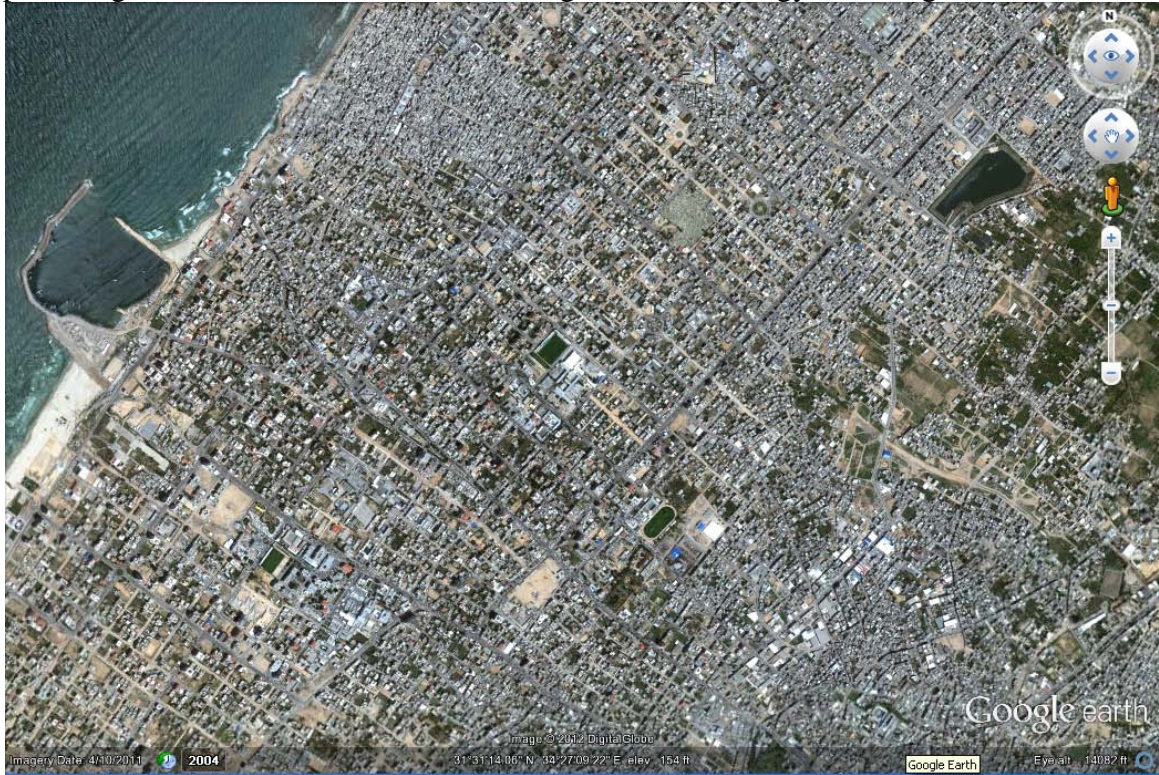


Figure (3.13): Crowded urban clusters in Gaza

on other hand, planting street trees situation is better than planting trees around residential complexes. As shown in a figure (3.14) planting streets trees depends on street width, pavements width and its importance. Generally, one of the most common features of highly desirable neighborhoods is the presence of large street trees that form a canopy over the road. Street trees are traditionally planted in a linear fashion along either side of the road. Also, trees can be planted in clusters along the side of the road, within median strips, or in islands located in cul-de-sacs or traffic circles. Each planting area has specific considerations for incorporating trees to ensure adequate space is provided and to address common concerns about visibility and conflicts with overhead wires or pavement, (Cappiella et al., 2006)















































Figure (3.14): Planting street trees in Gaza
































































### 3.6.2 The Most Popular Planted Trees Around Buildings Complexes and Streets of Gaza

Previous criteria of trees selection help to choose best tree and put it in the best location. The most important criteria in this study related to functions and geometries of tree. Basically, it concerns with configurations of the upper part of tree that include trunk height, branches distribution and the leaves shape and density. The longevity and foliage of trees is very important too, for both summer and winter.

















The following table (3.2) contains the most commonly planted types of trees in the Gaza strip and the most appropriate to plant around residential buildings, (ministry of local government, 2004) and (California Polytechnic State University& the Cal Poly Corporation, 2012) and( Engineering office of Islamic university, 2012):

**Table (3.2): Trees species diversity in the Gaza Strip**

Sceientific name	Common name	Form	Mature Height (m)	Crown Spread (m)	Planting Area	Tolerance to Shade	Fruits and Flowers	Foliage
Prunus amygdalus	almond trees		10	4	S			
Prunus armeniaca	apricot		10	4	S			
Prunus persica	peach		7	4	S			
Juglans regia	walnut		15	10	M			
Morus alba	white mulberry		15	10	M			
Psidium Guajava	Guava		6	10	M			
Ficus Carica	Edible Fig		7	10	M			
Citrus sinensis	orange		7	4	S			
Citrus Limon	lemon		7	4	S			
Oleo europaea	Olive		10	10	M			
Ceratonia siliqua	Carob		10	20	M			

Scientific name	Common name	Form	Mature Height (m)	Crown Spread (m)	Planting Area	Tolerance to Shade	Fruits and Flowers	Foliage
Phoenix Canariensis	Palm		20	8	M			
Schinus molle	Pepper Tree		15	20	M			
Ficus rubiginosa	Rusty-Leaf Fig		15	15	M			
Ficus benjamina	Weeping fig		7	6	S			
Ficus Elastica	Rubber Tree		7	6	S			
Ficus Microcarpa Var. Nitida	Indian Laurel		7	4	S			
Ficus auriculata	Roxburgh Fig		6	4	S			
Delonix Regia	Poinciana		10	6	S			
Jacaranda Mimosifolia	Jacaranda		15	10	M			
Lagerstroemia Indica	Crape myrtle		7	12	M			
Melia azedarach	Chinaberry		10	10	M			
Arbutus 'Marina'	Strawberry		10	10	M			
Ficus Sycamorus	Sycamor		15	10	L			
Malus sylvestris	apple		6	3	S			
Mangifera indica	mango		12	10	M			
Eucalyptus camaldulanis	Red Gum		30	15	L			
Cupressus sempervirens	Cypress		25	15	L			



Pinus hallepensis	Aleppo Pine		25	20	L			
Forms:  Vase,  Umbrella  Rounded  Oval  Conical  Columnar Tolerance to shade:  Dense in leaf  Moderate dense in leaf  Low dense in leaf Fruit and flowers:  Fruitful  Flowering Foliage:  Deciduous  Evergreen								

Generally, data in this table (3.2) is important in current study, especially geometry forms, height, spread, foliage, and shade that illustrate leaf area density. For more trees details, Appendix (A) illustrates more planted trees species in the Palestine and the Gaza Strip.

### 3.7 Conclusion

This chapter concentrated on two major trees issues. The First one is a review of trees identifications, its benefits, and its ability on altering microclimate elements included radiation, temperature, wind, and humidity. Indeed, almost every part of tree provides a beneficial function. The collective cooling of leaves alone either by shading or evapo-transpiration can have a great influence on energy use. The second issue related to the strategies of planting trees near building for the purpose of maximizing energy saving. Thus, for the purpose of practical study, the final trees planting depends on the configurations of trees that include: locations near building, types, size and numbers. Therefore, full scanning of planted trees in Palestine generally and in the Gaza Strip specifically was presented. This will help to determine the specific trees attributes that can be simulated in next phase. Planted trees in the Gaza Strip are almost miscellaneous because of the climate moderateness and the soil fitness of planting. All the trees have common and different attributes that include: form, height, canopy spread, foliage, and leaves density. This is considered as a great challenge to control with all attributes simultaneously in order to get the best results. So, the best method to determine best trees depends on the comparative between trees attributes, not the comparative between specific trees.

## **Chapter4: The Effect of Tree Shade on the Thermal Performance of the Residential Buildings**

### **4.1 Introduction**

Generally, the previous chapter outlined trees identifications, benefits, microclimate modifications, and the strategies to plant right tree in the right place. This step is very important for the analytical study because it determines the main contributing factor for cooling surrounding environment. Basically, trees configurations are the most significant factor that affect the received amount of solar radiation, thus indoor thermal conditions. It was found from previous studies that blocking solar radiation was the main tree function for the purpose of energy saving. Therefore, choosing proper trees configurations near buildings to benefit from trees shade effectively was the most common purpose of these studies. Hence, the green infrastructure is the infrastructure that increases in value over time if the right tree configurations are chosen.

In the current chapter, two simulation tools were used simultaneously. DESIGNBUILDER model was used primary and ECOTECH model was used as validation for some studies to check the accuracy of the effect of trees shade on building thermal performance results. Two sections were studied to find out optimum trees configurations. The first one was used to investigate extensively trees configurations near building facades. This section was divided into four main studies: different trees geometries, crown size, positions near façade including distances, and numbers. Each of these studies includes sub-studies that are important to create comprehensive view of trees configurations and correlate between main studies and their results. The second section was used to investigate generally different building cases with fixed single tree position. For different building orientations and height, the trees shading effect varies definitely and the studying in this case will be significant for each building alone.

### **4.2 Simulation Tools and Validity**

Energy simulation tools are increasingly used for the analysis of energy performance of the buildings and the thermal comfort of their occupants. Today, multiple tools are available and they differ in many ways; in their thermodynamic models, their graphical user interfaces, their purpose of use, their life-cycle applicability, and their ability to exchange data with other software applications.

Choosing simulations tools for any study depends on the objectives of this study. The current study used two popular simulations tools namely DESIGNBUILDER and ECOTECH. Each simulation tools has strong and weak features. Many advantages and disadvantages emerged in using the two tools that relate with shading devices and block elements. These features are listed as follow:

<b>Table (4.1): Simulation Tools Features</b>		
	<b>DESIGNBUILDER</b>	<b>ECOTECH</b>
<b>Advantages</b>	<ul style="list-style-type: none"> <li>• Using a state-of-the-art graphical user interface (GUI).</li> <li>• Using sophisticated CAD and 3D modeling tools.</li> <li>• High ability to deal with geometries, schedules, and construction types.</li> <li>• Easy to learn and use.</li> <li>• High sensitivity for little changes.</li> </ul>	<ul style="list-style-type: none"> <li>• Allows the user to "play" with design ideas at the conceptual stages.</li> <li>• High ability to deal with geometries, schedules, and construction types.</li> <li>• Ability to exchange data with CAD software.</li> <li>• Performance analysis is simple,</li> </ul>

	<ul style="list-style-type: none"> <li>Controlling easily with deciduous tree as shading device in both summer and winter.</li> <li>Respond to Shading Elements effectively.</li> </ul>	<p>accurate, most important, and visually responsive.</p> <p>Respond to Shading Elements effectively.</p> <p>System of templates and attribute are flexible to use.</p>
Disadvantages	<ul style="list-style-type: none"> <li>Limits to select and organize model objects.</li> <li>System of templates and attribute seemed both inflexible and unintuitive compared to Ecotect.</li> <li>Don't consider the evapo-transpiration of trees.</li> </ul>	<ul style="list-style-type: none"> <li>Don't consider the evapo-transpiration of trees.</li> <li>Inability to control with deciduous tree as shading device in winter.</li> <li>Low sensitivity for little changes.</li> <li>Take long time for simulation multi zones and elements projects.</li> </ul>

A short description is provided for each tool features and its importance to the study:

### 4.2.1 DESIGNBUILDER

DESIGNBUILDER is acknowledged as the most comprehensive interface to the 'state of the art' EnergyPlus building simulator, and is used widely by simulation experts and beginners alike. The software also provides access to an encyclopedic range of advanced building modeling options when exporting the model from DESIGNBUILDER to EnergyPlus for ASHRAE 90.1 compliance work and for evaluating LEED credits.

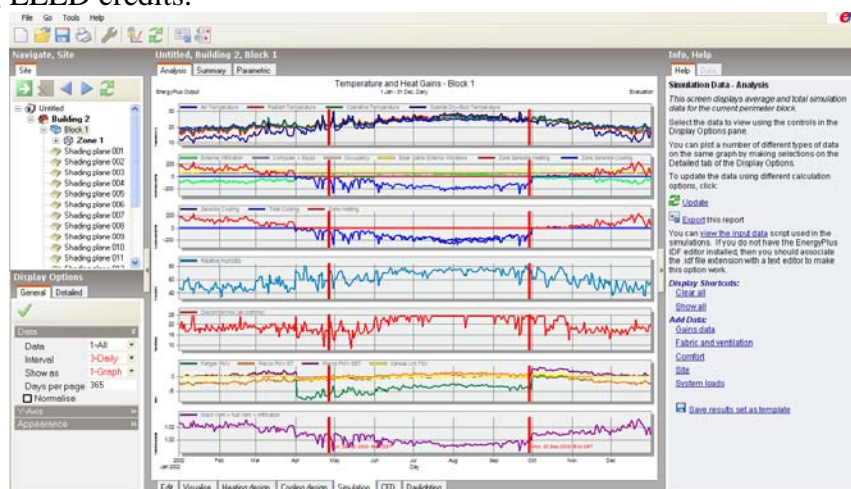


Figure (4.1): DESIGNBUILDER software interface

It provides a range of environmental performance data such as: energy consumption, internal comfort data and HVAC component sizes, see figure (4.1). Output is based on detailed sub-hourly simulation time steps using the EnergyPlus simulation engine. DESIGNBUILDER can be used for simulations of many common HVAC types, naturally ventilated buildings, buildings with day lighting control, double facades, advanced solar shading strategies etc. It builds on the most popular features and capabilities of BLAST (Basic Local Alignment Search Tools) and DOE-2 (Building Energy Use and Cost Analysis Software), but also includes many innovative simulation capabilities such as time steps of less than an hour, modular systems and plant integrated with heat balance-based zone simulation, multi-zone air flow, thermal comfort, and photovoltaic systems, (DesignBuilder Software Ltd, 2012) and (U.S. Department of Energy, 2011).

## **4.2.2 ECOTECT**

ECOTECT is one of the few tools in which performance analysis is simple, accurate and most important, visually responsive. It is a software package with a unique approach to conceptual building design. It couples an intuitive 3-D design interface with a comprehensive set of performance analysis functions and interactive information displays. ECOTECT has five main functions: modeling and visualization, working with energy plus, Import and export capabilities, building data storing, and offers a wide range of internal analysis functions. These provide almost instantaneous feedback on parameters such as sun penetration, potential solar gains, thermal performance, internal light levels, reverberation times and even fabric costs as you develop and refine the design, (Marsh, 2003). ECOTECT allows shaping and putting shading elements due the design requirements to get optimum solution easily.

## **4.3 General Parameters**

Interacting parameters in any thermal analysis are numerous. These parameters in the current study include climate, building configurations, and trees data. Building parameters and climatic data are assumed to be fixed terms to evaluate the effect of trees configurations on the buildings thermal performance.

### **4.3.1 Climatic Parameters**

The usage of climatic parameters in any simulation analysis is represented by climate weather data files for specific city. These files were arranged by World Metrological Organization region and country (WMO). The weather data file consists of group of location and climatic information included latitude, longitude, WMO station identifier, climate type, summer and winter dates for hot weeks and cold weeks, and other climatic parameters such as temperature, humidity, wind speed, and solar radiation, (U.S. Department of Energy , 2012).

Weather data file is available now in many formats that represent the type of analysis package and software. Weather data formats include Energy Plus data file (.EPW) that is used by DESIGNBUILDER software, ECOTECT weather data file (.WEA), Typical Meteorological Year (.TMY), International Weather for Energy Calculations format from ASHRAE (.IWEC), Comma-Separated-Value (CSV) files, ESP-r, DOE-2 and BLAST weather text format files that are used by Energy Plus, (U.S. Department of Energy , 2012).

Because of the unavailability of weather data file for the Gaza Strip in any formats, the climatic weather data file for El-Arish, Egypt is used. The effect of coastal climate of Mediterranean Sea for Gaza and El-Arish is similar and both of them are affected by the Sinai desert climate. El-Arish lies on the north of Egypt that lies on the Southern coast of the Mediterranean Sea, at 31.1 N° and 33, 80 E°.

### **4.3.2 Building Parameters**

Residential buildings in the Gaza Strip have different features in terms of areas, heights, types, and volume. Basically, the current study estimates the effect of trees configurations on a single building. Residential buildings are mainly divided into two parts: Separate houses and Apartments buildings. According to Hadid (2002) Separate

houses are commonly designed in Palestine and the Gaza Strip. According to the function of these houses, it is divided into two styles:

- **A single house:** is one of the popular styles for growing up families. The design and form of such houses are simple. These types of houses mainly build in two materials, either the concrete and stone for external walls, which are found in all cities and villages in West Bank, or the concrete and hollow blocks walls, which are mainly used in the coastal plain. The area of such a style is variable starting from 150 m<sup>2</sup> up to 300 m<sup>2</sup>.
- **Villa:** A villa house is a well-known style for rich families, different designs can be found for the different functions. This style is found in all cities and villages in the West Bank and the Gaza strip. The area of such a style is variable starting from 200 m<sup>2</sup> up to 500 m<sup>2</sup>. Villas material is mainly stone of external walls in West bank. In Gaza cities, some examples made from concrete and hollow blocks, with external plaster, (Hadid, 2002).

Hence, two floors villa (7m height) with square plan and 225 m<sup>2</sup> was used as building case in all trees configurations studies. See figure (4.2). In second section of this study, other cases with different orientations, forms, and height were studied specially to evaluate the effect of one tree on each of them.

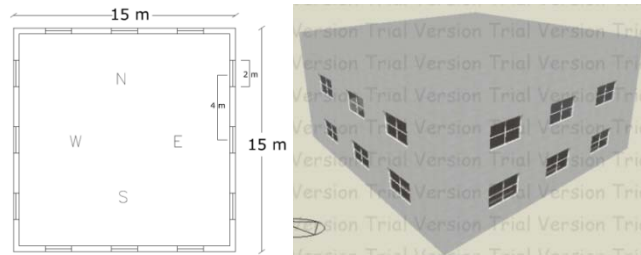
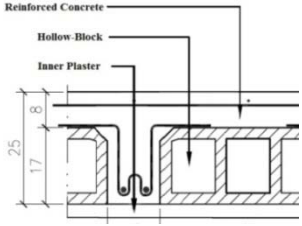
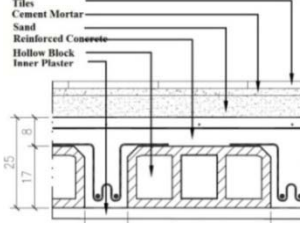


Figure (4.2): Original case of residential building

Table (4.2) shows building elements and materials features in Gaza. In addition, building has no shading devices, no special finishes, and no available thermal insulation. Besides, it is sited on flat homogeneous surface without adjacent buildings.

Table (4.2): Building elements and materials features in Gaza			
Elements	Materials and layers	U value (W/m <sup>2</sup> .K)	Figure
Flat roof	Three layers: inner plaster, 17 cm hollow block, and 8 cm reinforced concrete	2.18	
Typical Floor	Four layers: inner plaster, 17 cm hollow block, 8 cm reinforced concrete, and tiles finishes	2.18	

Elements	Materials and layers	U value (W/m <sup>2</sup> .K)	Figure
Ground floor	Two layers: 10 cm reinforced concrete, and tiles finishes	2.10	<p>The diagram shows a cross-section of a ground floor. From top to bottom, the layers are: Tiles, Cement Mortar, Sand, and Reinforced Concrete. Arrows point to each layer with its respective label.</p>
Exterior walls	Three layers: inner plaster, 20 cm hollow block, and outer plaster	2.25	<p>The diagram shows a cross-section of an exterior wall. From left to right, the layers are: Inner Plaster, Hollow Block, and Outer Plaster. Arrows indicate the 'In' and 'Out' directions.</p>
Windows	3mm single glass-aluminum frame	5.60	<p>Windows area is about 10-15% of walls area, (Neufert et al., 2000).</p> <p>One of Building Facades</p>

### 4.3.3 Thermal Analysis Parameters

For the purpose of thermal analysis by DESIGNBUILDER or ECOTECT, table (4.3) shows a group of essential parameters that must be filled in two models. For further details see appendix (B).

<b>Table (4.3): Thermal analysis parameters</b>	
Hours of operation	24 hours
Clothing level	0.4 col
Humidity	60%
Lightening level	300 Lux
Active system (HVAC system)	cooling and heating system
Comfort band	18° C to 26° C
Occupancy	7 persons
Activity	70 W/m <sup>2</sup>
Internal gain	11 W/m <sup>2</sup>
Latent gain	2 W/m <sup>2</sup> .
Infiltration rate	1.0 ach/h

### 4.3.4 General Trees Configurations Parameters

As an important part of studying technical potential of trees shade, the impact of individual tree on energy loads in typical residential buildings in Gaza was simulated for multiple trees configurations. As shown in the following figure (4.3), four mature trees configurations were analyzed: different crown forms, size, distances, and numbers. As well as trees locations near building sides is considered the second analytical variable in each study. Each configuration has its investigation parameters that would be explained later.

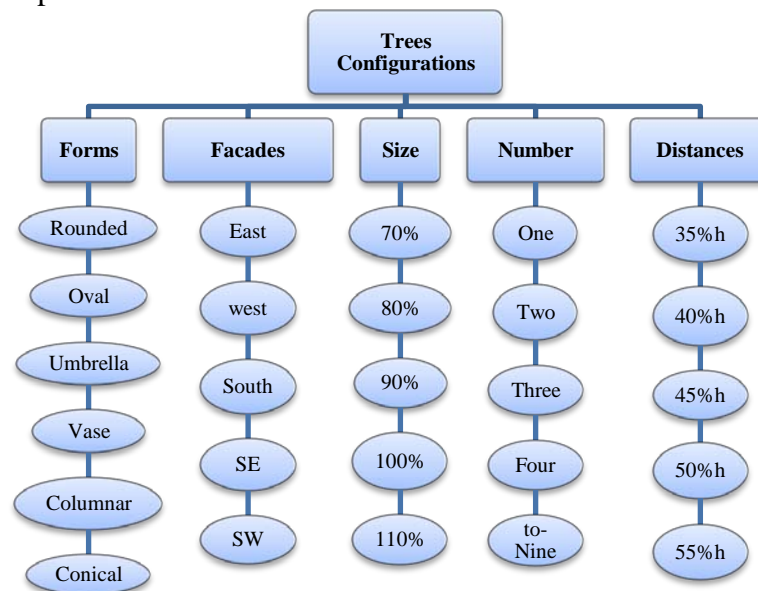


Figure (4.3): Trees configurations diagram

The main strategies for planting trees in temperate, hot climate for the purpose of achieving energy savings and thermal comfort are:

- Maximize shade during summer.
- Maximize warming effects of sun in winter.
- Funnel summer breezes towards the home.

Consequently, the previous diagram includes multiple prospects that are important to study the relation between energy consumption and trees configurations in summer and winter. Hence, the main principles for achieving study effectively are:

- Simulations were performed by DESIGNBUILDER software and the results were validated by ECOTECT software for some studies. Building without trees is considered the reference case for all simulation results calculations.
- Studying internal thermal comfort is carried out by studying thermal behavior of building elements. External building's elements are affected by changing out-door conditions with other influences elements such as trees and adjacent buildings.
- The correlation between trees and building is summarized in blocking incident solar radiation. This process is responsible totally for decreasing heat gain through fabric and glazing, thus reduction cooling loads in summer and increasing heating loads in winter.

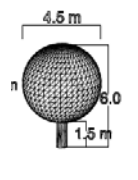
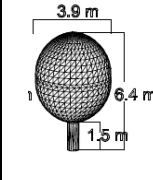
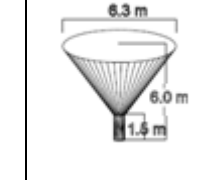
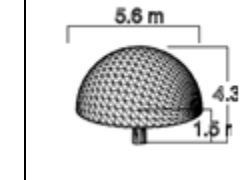
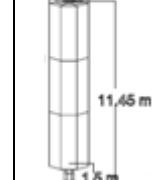
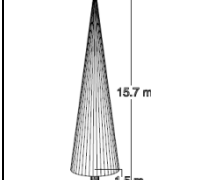
- Trees locations near building include east, west, south, southern eastern and southern western facades that exposed to solar radiation all years. North direction is excluded from study because it does not receive much solar radiation all year. It is considered the main direction for north and western northern breezes in summer.
- Cooling loads were conducted for evergreen and deciduous trees for the first study. In the rest of studies, cooling and heating loads were conducted for just deciduous trees. Trees shade has good effect in summer and vice versa in winter. Bare limbs and trunk of deciduous trees in winter block at least 30% of sunlight that would otherwise reach building interface, (Hildebrandt et al., 1995).
- Cooling loads and heating loads are good indicators on decreasing and increasing energy loads, thus human comfort. Accordingly, solutions were suggested to integrate trees functions in summer and winter.

#### 4.4 The Effect of Trees Geometries on Energy Consumption

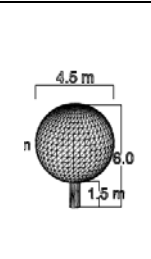
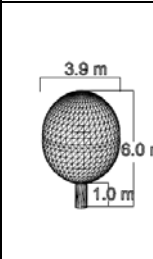
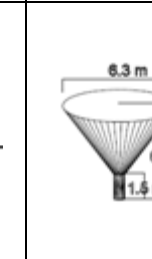
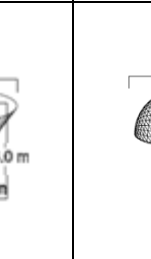
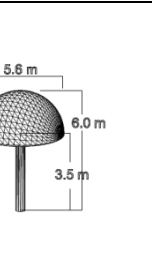
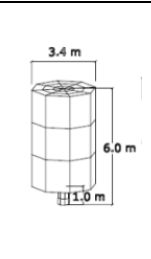
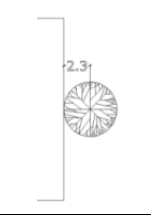
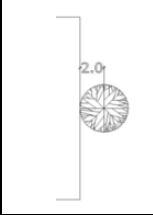
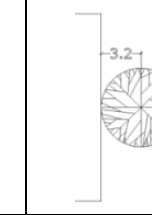
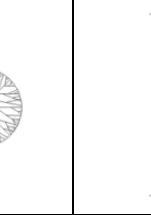
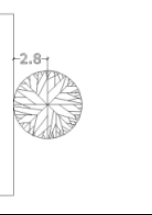
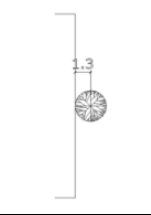
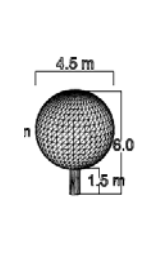
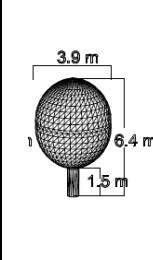
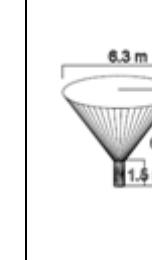
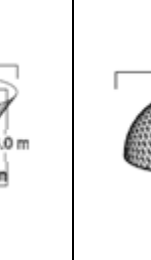
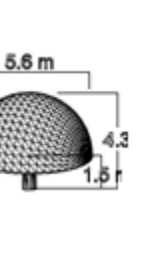
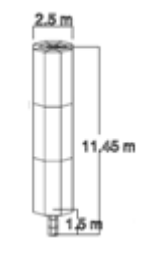
Tree geometries are the shape of tree foliage including leaves density, branches spreading, and trunk height. Rounded, oval, vase, umbrella, columnar, and conical are the common trees geometries that are founded in the Gaza strip. The current configuration studies the effect of different tree geometries shade on internal thermal comfort including energy consumption in both summer and winter. The study assumed that all trees are dense leaves trees.

##### 4.4.1 Parametric Investigation

Trees geometries have many dimensional variables that include: crown volume, trunk height, total height, and crown diameter. Study is divided into three scenarios in order to study all tree geometries cases for both natural growth trees and man-forming trees measurements. The volume of trees foliage is assumed to be fixed in all cases, thus the diameter differs from tree to another. The significant point from this assumption is getting the same amount of shade from all geometries. Therefore the trunk height and total height are considered the two main variables in first and second scenario. The third scenario is not related with tree geometries features, but it is related to the location near building facades. The first two scenarios have fixed distances between the center of tree trunk and facades, but third scenario is supposed to fix distance between edge of tree crown and building facades. Thus distances between the center of tree trunk and facade differ totally in each tree. The following table (4.4) illustrates the three scenarios parameters combination:

Table (4.4): Tree Geometries Scenarios parameters					
First scenario: 1.5 m tree trunk, 47.7 m <sup>3</sup> volume, different total height and 3 m far from building facades					
Rounded	Oval	Vase	Umbrella	Columnar	Conical
					



Second scenario: different trunk height, 47.7 m <sup>3</sup> volume, 6m total height and 3 m far from building facades					
Rounded	Oval	Vase	Umbrella	Columnar	Conical
					
Third scenario: 1.5 m tree trunk, 47.7 m <sup>3</sup> volume, different total height and different distances					
Rounded	Oval	Vase	Umbrella	Columnar	Conical
					
					

#### 4.4.2 Simulation Results

**1. First Scenario assumption:** 1.5 m trunk height, 47.7 m<sup>3</sup> crown volume, different total height and 3 m far from building facades.

**Cooling loads (KWh) and energy saving in summer:** the results indicated that vase tree has the lowest cooling loads value comparing with other types of trees. Thus it has the highest energy saving in summer. As shown in figure (4.4) the value of cooling loads reduction as a result of changing type of trees can be ordered from highest to lowest as follow: vase, conical, columnar, oval, rounded, and finally umbrella. Therefore, energy savings in summer decreased by about 2.57%, 1.94%, 2.06%, 1.47%, 1.50% and 1.35% for planting vase, conical, columnar, oval, rounded, and umbrella respectively in the east side of building. It was noticed that columnar and conical trees have almost the same value of energy saving in summer. Rounded and oval have also the same energy saving percentage while umbrella tree has the lowest energy saving. On the other hand, the results indicated that the east side is the most important façade to shade while the west side is the second important side to shade followed by south, southeastern and southwestern. Therefore, planting vase tree near building decreased saving percents by about 2.57%, 2.13%, 1.97%, 1.15%, and 0.75% respectively. The same trend was noticed for the rest of trees with lowest values.

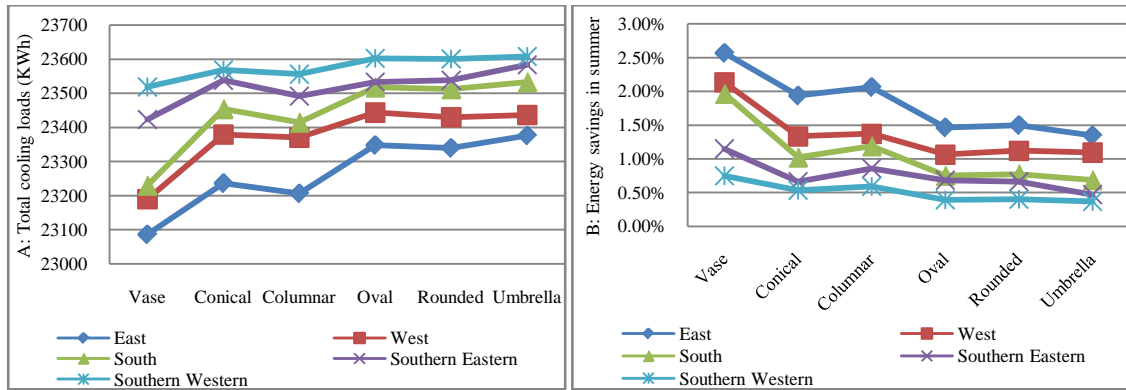


Figure (4.4): A: Total cooling loads (KWh) and B: energy saving percent for the effect of different tree geometries (first scenario)

It was observed in figure (4.5) that ECOTECT software had almost the same trend. The energy savings in summer decreased by about 2.87%, 1.62%, 1.71%, 1.17%, 1.04% and 0.84% for planting vase, conical, columnar, oval, rounded, and umbrella respectively in the east side of building. Also, planting vase tree near east, west, south, southeastern, and southwestern sides decreased saving percents by about 2.87%, 1.12%, 0.99%, 0.60%, and 0.28% respectively.

The slight discrepancy between the results of the two models can be referred to the different calculation techniques, calculation engines, and different weather data file formats. While ECOTECT uses CIBSE “admittance method” for calculating thermal loads, DESIGNBUILDER uses EnergyPlus that has been the subject of extensive validation through an ongoing US DOE development and support program.

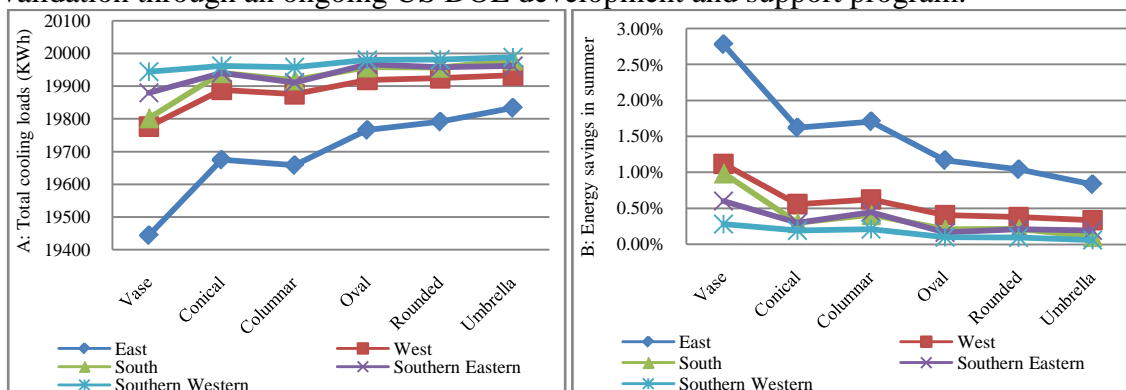


Figure (4.5): A: Total cooling loads (KWh) and B: energy saving percent for the effect of different tree geometries (first scenario) by ECOTECT

**Incident solar radiation and surface gain:** it is shown in figure (4.6) that blocking incident solar radiation on building façades is responsible totally for the particular energy saving for each tree. It illustrates a correlation between tree geometries and the percentage of blocking incident solar radiation. Therefore, incident solar radiation reduction percents in summer decreased by about 7.45%, 5.02%, 5.25%, 4.07%, 4.05% and 3.01% for planting vase, conical, columnar, oval, rounded, and umbrella respectively in the east side of building. Also, it was noticed the same trend for planting trees in other sides with lowest values. Columnar and conical trees have almost the same reduction percents in summer. Rounded and oval have also the same reduction percents while umbrella tree has the lowest reduction percents. On the other hand, the results indicated that planting trees on east side can block the highest solar radiation amount while the west side is the second in blocking solar radiation followed by south,

southeastern and southwestern. Therefore, planting vase tree near building decreased incident solar radiation reduction by about 7.45%, 5.74%, 4.94%, 2.83%, and 2.45% respectively. The same trend was noticed for the rest of trees with lowest values.

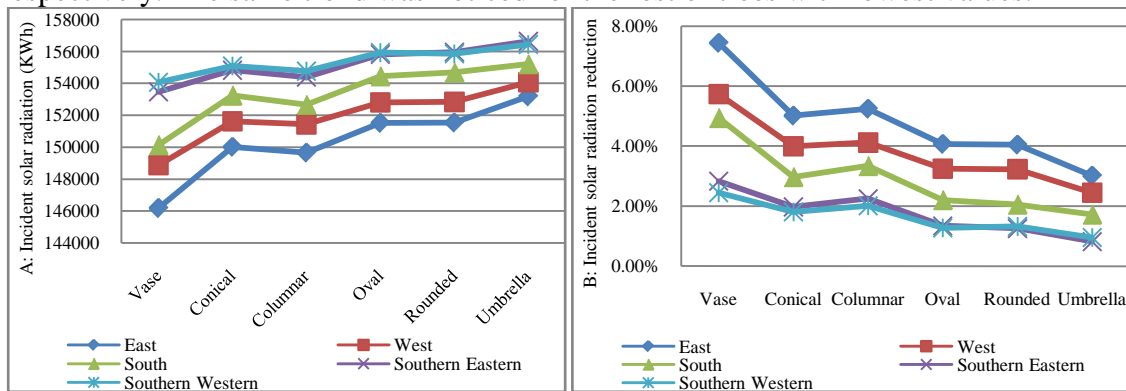


Figure (4.6): A: Incident solar radiation (KWh) and B: Incident solar radiation reduction percent for the effect of different tree geometries (first scenario)

Accordingly, the reduction in Insolation leads to the reduction in surface gain. Scientifically, heat transfer happens between building envelop and surrounding environment by conduction, convection, radiation, and evaporation. When solar radiation reach building envelop, the heat conduction through building elements (walls, roofs, ceilings, windows, and doors) happens directly. When a higher temperature zone get in contact with lower temperature zone, fast molecular movement is occurred from hot to cold, (Szokolay, 2008). Therefore, when tree blocks solar radiation, temperature is reduced directly and the transfer movement reduces as well. As shown in the figure (4.7) surface gain reduction percents in summer decreased by about 22.62%, 13.95%, 14.99%, 11.29%, 11.18% and 7.95% for planting vase, conical, columnar, oval, rounded, and umbrella respectively in the east side of building. On the other hand, planting vase tree on east, west, south, southeastern, and southwestern sides decreased surface gain reduction percents by about 22.62%, 14.44%, 10.27%, 5.25%, and 4.42% respectively. Blocking solar radiation and reduction heat transfer through building envelop reduces the internal convection currents, thus cooling loads in summer.

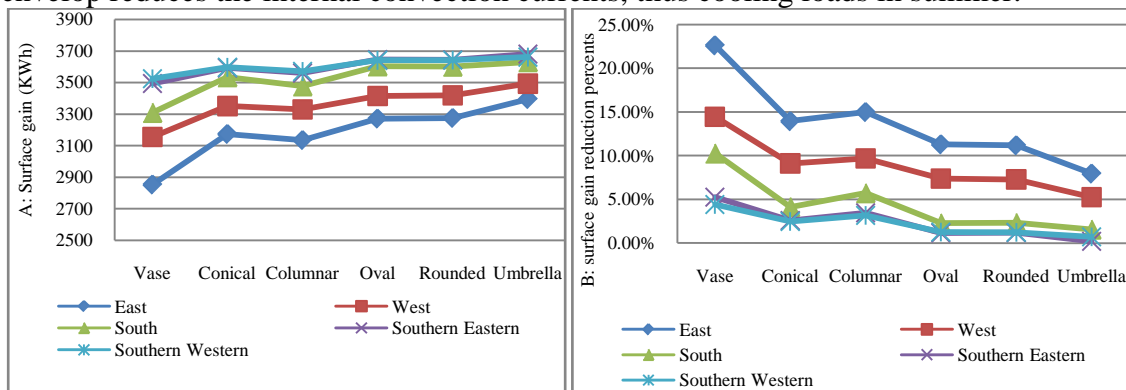


Figure (4.7): A: Surface gain (KWh) and B: surface gain reduction percent for the effect of different tree geometries (first scenario)

As mentioned before, east side is the most important to shade according to the previous study. The west side provides the next greatest benefits, followed directly by south side. But in fact, west side is the most important to shade and that can be explained as follow:

As shown in the following figure (4.8) in the mid of summer day, the sun shines on the east side of building in the morning, passes over the roof near midday, then shines on the west side in the afternoon. Air conditioner work hard during the afternoon when temperatures are the highest and incoming solar radiation is the greatest.

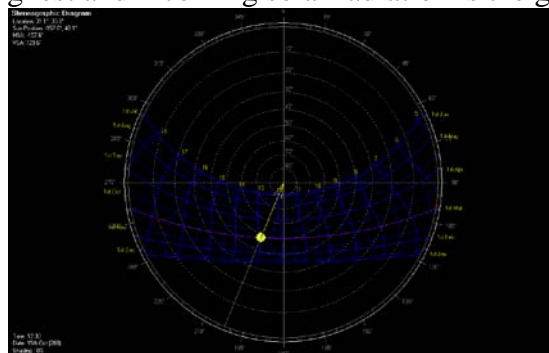


Figure (4.8): Sun path diagram from ECOTECT

Heat is transferred to the building by solar gain, fabric gain, ventilation and internal gain. Solar conduction play significant role in heating the building through opaque surfaces including walls and roofs or transparent surfaces such as windows through day. The materials of the most of opaque elements have an ability to store heat for hours and release it again afternoon. It is the ability of material in absorbing, holding, and gradually releasing heat. Heavy and dense building materials with high specific heat such as stone, concrete, brick, or adobe have high thermal mass, (Mikler et al., 2008). See figure (4.9)

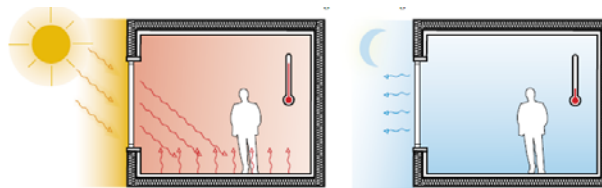


Figure (4.9): The effect of thermal mass of heavy building materials during day and night, (Mikler et al., 2008)

In the summer or hot regions, a thermally massive floor in a day can be cooled overnight with cooler outdoor air. In the morning the cool mass will absorb solar and other heat gains from the space, providing the sensation of coolness from the floor. This was shown to delay the onset of daily mechanical cooling and in some cases eliminate the peak cooling demand. As shown in figure (4.10) this delay is called thermal lag, (Roaf et al., 2001). Consequently, the ability of tree shade to reduce temperature in the morning is greater than its ability to reduce temperature afternoon. So, west side is the most important side to shade in order to eliminate temperature severity, thus eliminate air-conditioner working which is not commonly use in the morning.

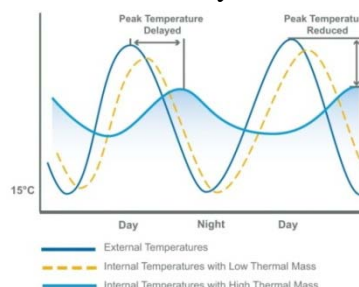


Figure (4.10): Diagram illustrating thermal mass mechanism, adapted from (Ministry of local government, 2004)

In the midday of summer, much of incident solar radiation is absorbed by roof, while much of it is absorbed by southern façade in winter, (Morrissey et al., 2011). This can be explained as the sun altitude angle is low in the midday of winter that ables south facade to capture desirable solar radiation making it ideal for passive solar heating, (Mikler et al., 2008). But during summer sun altitude angel is high enough that reduce incident solar radiation on southern façade, show figure (4.11). The amount of incident solar radiation on the building facade depends on the azimuth in the wall and the orientation angle of the building. Consequently, the impact of tree shade on both east and west side is greater than it on south side in summer and vice versa in winter.

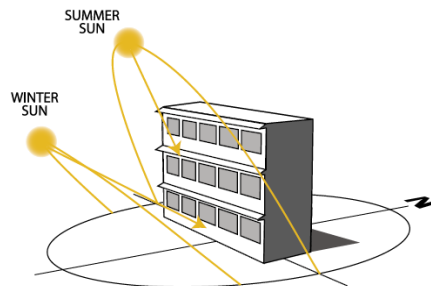


Figure (4.11): Sun path during summer and winter, (Mikler et al., 2008)

The southeastern and southwestern sides have the lowest energy savings because they are facing the edge of building where no windows. Windows are considered the highest heat conductor elements because of the great U-value. Solar gain and windows position will be discussed extensively later.

**Heating loads and energy consumption:** as mentioned before, heating loads were evaluated for just deciduous trees including vase, oval, rounded, and umbrella, while columnar and conical were excluded for the following reasons:

- The objective of this study is maximizing thermal comfort in both summer and winter. Shading of evergreen trees contributes to increase heating loads in winter. This is an indicator on deterioration thermal comfort conditions.
- Trees with deciduous foliage in the winter block at least 30% of incident solar radiation; therefore its impact on heating loads is less than the impact of evergreen trees, (Hildebrandt et al., 1995).

It can be seen in the following figure (4.12) that both results of DESIGNBUILDER and ECOTECH show that the vase tree increase heating loads in the winter more than other forms. Oval and rounded have almost the same impact, where the umbrella has the lowest impact. The results indicated that planting trees in south side decreased increasing energy consumption by about 2.36%, 1.66%, 1.64%, and 1.10 % for vase, rounded, oval and umbrella respectively. South side is the most façade that receive solar radiation in the winter and that was explained shortly before. And for the same reason, planting trees on the east or the west side has the lowest impact on increasing heating loads. On the other side, planting vase tree on southeastern and southwestern sides decreased increasing energy consumption by about 1.38% and 1.05% respectively. The same trend was observed in the rest of tree types with lowest values.

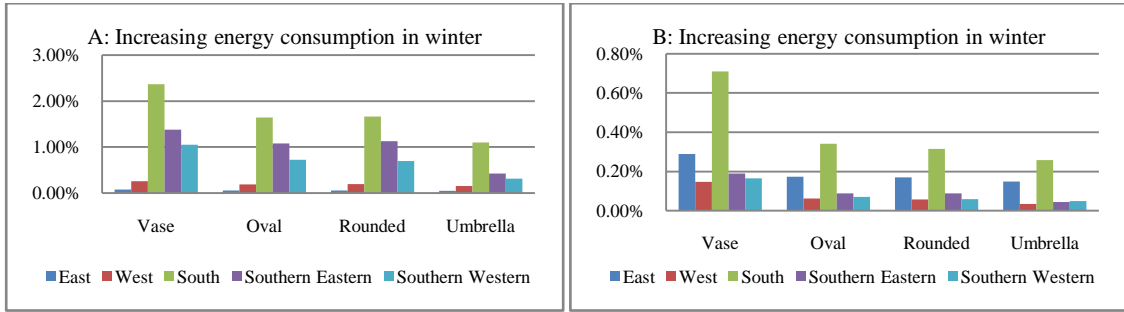


Figure (4.12): The effect of tree geometries on increasing energy consumption in winter, A: by DESIGNBUILDER and B: by ECOTECT

The same trend of the results was observed by ECOTECT with lowest values. Increasing energy consumption in winter decreased by about 0.71%, 0.34%, 0.31%, and 0.26% for planting vase, oval, rounded, and umbrella respectively in south side. There is a slight discrepancy between the two models. DESIGNBUILDER results indicate that planting tree on east and west sides has the lowest impact, while ECOTECT indicates that east, west, southeastern and southwestern have almost the same value with slight preference for east side. That can be referred to the different calculation algorithm.

Actually, increasing heating loads value in winter can be explained as that branches and limbs can block 30% of incident solar radiation. As shown in the figure (4.13) planting tree in south side has the highest blocking percents for all tree geometries. Consequently, planting deciduous tree decreased incident solar radiation reduction percents by about 8.31%, 4.83%, 4.72%, and 3.24% for vase, oval, rounded, and umbrella respectively. The comparison between the effect of evergreen and deciduous trees illustrates that falling foliage in winter helps in achieving thermal comfort by eliminating the increasing effect of tree shade. Planting evergreen trees decreased incident solar radiation reduction percents by about 11.87%, 6.90%, 6.74%, and 4.63% for vase, oval, rounded, and umbrella respectively. These percents are higher than deciduous trees reduction percents.

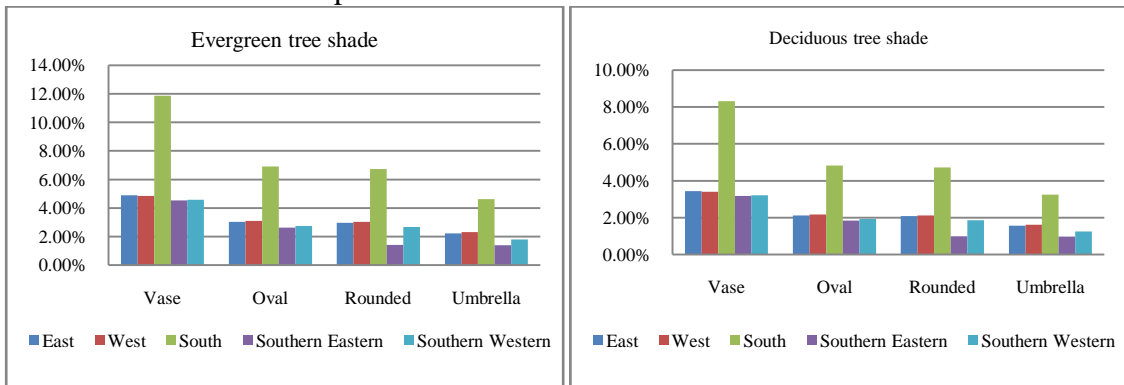


Figure (4.13) the comparison between the effect of evergreen tree and deciduous tree on blocking incident solar radiation in first scenario

**2. Second scenario assumption:** different trunk height, 47.7 m<sup>3</sup> crown volume, fixed total height and 3 m far from building facades.

**Cooling loads (KWh) and energy saving in summer:** the results indicated that vase tree has the lowest cooling loads value comparing with other types of trees. Thus it has the highest energy saving in summer in this scenario too. As shown in figure (4.14) the value of cooling loads reduction as a result of changing type of trees can be ordered



from highest to lowest as follow: vase, umbrella, columnar, rounded, oval, and finally conical. Therefore, energy savings in summer decreased by about 2.60%, 1.93%, 1.62%, 1.52%, 1.47% and 1.12% for planting vase, umbrella, columnar, rounded, oval, and conical respectively in the east side of building. It was observed that rounded and oval have also the same energy saving percent while conical tree has the lowest energy saving. On the other hand, the results indicated that the east side is the most important façade to shade while the west side is the second important side to shade followed by south, southeastern and southwestern. Thus, planting vase tree near building sides decreased saving percents by about 2.60%, 2.04%, 2.01%, 1.61%, and 0.76% respectively. The same trend was noticed for the rest of trees with lowest values.

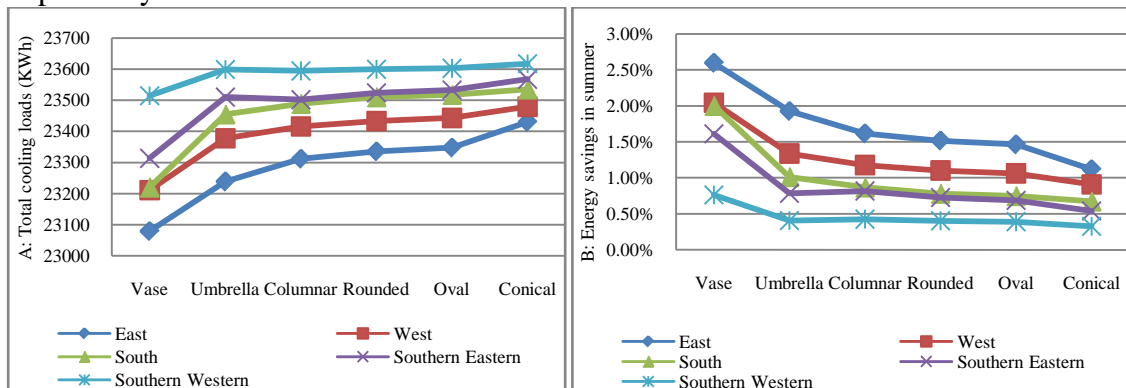


Figure (4.14): A: Total cooling loads (KWh) and B: energy saving percent for the effect of different tree geometries (second scenario)

The discrepancy of results between this assumption and the previous are in tree form arrangements from the highest to the lowest energy saving. That can be explained as that the tree crown height is in the same level for all tree forms because of the unity of the total height unlike previous case. For this reason, the geometry shade is distributed with the same manner on the façade for all trees, while it cannot be achieved in the first scenario. For example, umbrella in the first scenario have the lowest impact because its total height does not exceed one building floor, while it exceeds more than that in the second scenario making it the second highest energy saving. Show figure (4.15).

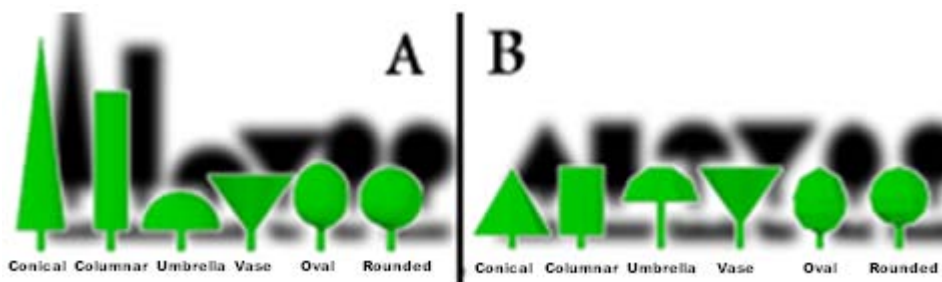


Figure (4.15): A: trees forms in first scenario and B: trees forms in second scenario

**Incident solar radiation and surface gain:** it was shown in figure (4.16) that blocking incident solar radiation on building façades is responsible totally for the particular energy saving for each tree. Therefore, incident solar radiation reduction percents in summer decreased by about 7.59%, 5.36%, 4.50%, 4.17%, 4.07% and 2.82% for planting vase, umbrella, columnar, rounded, oval, and conical respectively in the east side of building. Also, the same trend was noticed for planting trees in other sides with lowest values. Rounded and oval have also the same reduction percents while umbrella tree has the lowest reduction percents. On the other hand, the results indicate

that the planting trees on east side can block the highest solar radiation amount while the west side is the second in blocking solar radiation followed by south, southeastern and southwestern respectively. Therefore, planting vase tree near building decreased incident solar radiation reduction by about 7.59%, 5.84%, 5.07%, 2.91%, and 2.51% respectively. The same trend was noticed for the rest of trees with lowest values.

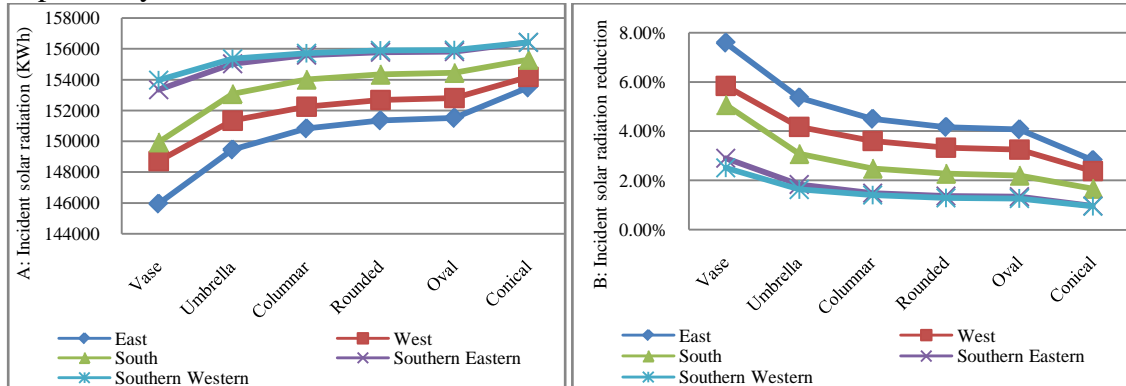


Figure (4.16): A: Incident solar radiation (KWh) and B: Incident solar radiation reduction percent for the effect of different tree geometries (second scenario)

Accordingly, the reduction in Incident solar radiation leads to the reduction in surface gain. As shown in the figure (4.17) surface gain reduction percents in summer decreased by about 23.07%, 15.57%, 12.47%, 11.61%, 11.29% and 7.08% for planting vase, umbrella, columnar, rounded, oval, and conical respectively in the east side of building. On the other hand, planting vase tree on east, west, south, southeastern, and southwestern sides decreased surface gain reduction percents by about 23.07%, 14.74%, 10.64%, 5.45%, and 4.59% respectively.

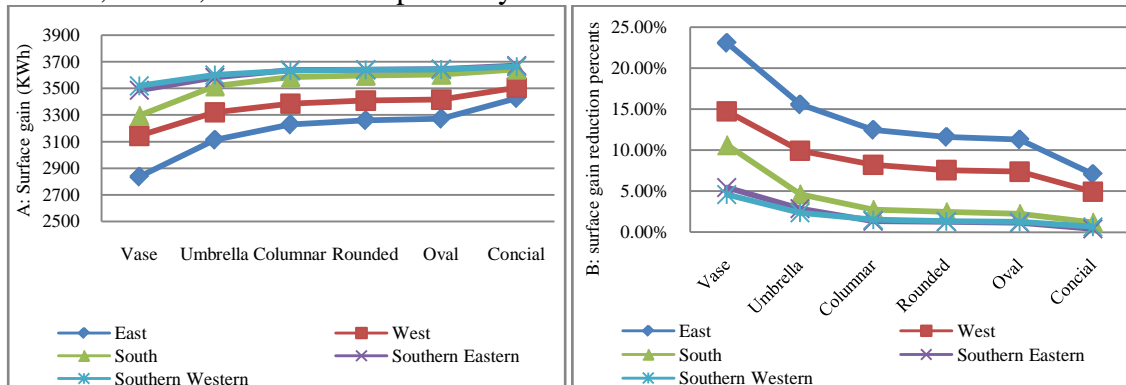


Figure (4.17): A: Surface gain (KWh) and B: surface gain reduction percent for the effect of different tree geometries (second scenario)

**Heating loads and energy consumption:** It can be seen in the following figure (4.18) that the vase tree increases heating loads in the winter more than other forms. The umbrella has the second highest impact while, oval and rounded have almost the same impact. The results indicated that planting trees in south side increased heating loads by about 2.32%, 1.64%, 1.73%, and 2.10 % for vase, rounded, oval and umbrella respectively. South side receives the greatest amount of solar radiation in the winter, while planting trees on east or west side has the lowest impact on increasing heating loads. On the other side, planting vase tree on southeastern and southwestern sides increased energy consumption by about 1.32% and 1.04% respectively. The same trend was observed in the rest of tree types with lowest values. Furthermore, increasing heating loads value in winter is happened because of blocking incident solar radiation. Planting tree in south side has the highest blocking percents for all tree geometries.



Consequently, planting deciduous tree decreased incident solar radiation reduction percents by about 8.44%, 4.83%, 1.83%, and 2.31% for vase, oval, rounded, and umbrella respectively.

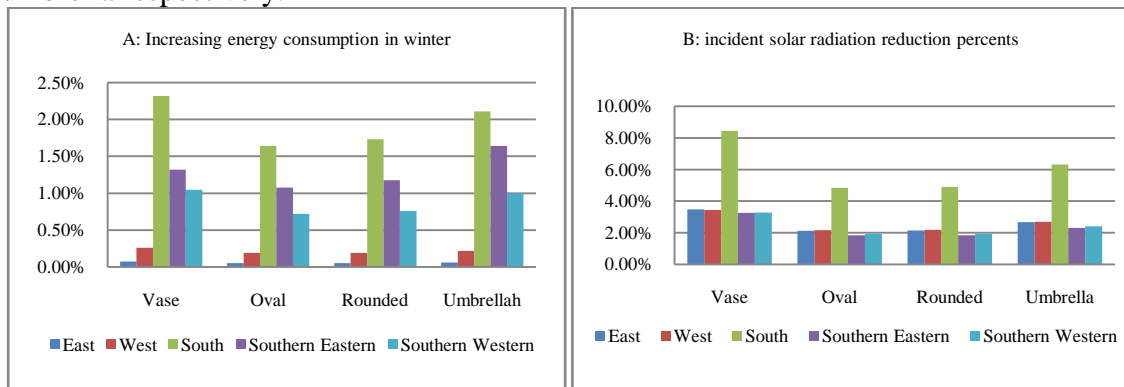


Figure (4.18): The effect of tree geometries on A: increasing energy consumption and B: increasing incident solar radiation reduction percents in winter

- **Third scenario assumption:** 1.5 m trunk height, 47.7 m<sup>3</sup> crown volume, fixed total height and different distances near building facades.

**Cooling loads (KWh) and energy saving in summer:** the results indicated that vase tree has the lowest cooling loads value comparing with other types of trees. Thus it has the highest energy saving in summer in this scenario too. As shown in figure (4.19) the value of cooling loads reduction as a result of changing type of trees can be ordered from highest to lowest as follow: vase, columnar, conical, oval, rounded, and finally umbrella. Therefore, energy savings in summer decreased by about 2.57%, 2.30%, 2.20%, 1.76%, 1.76% and 1.35% for planting vase, columnar, conical, rounded, oval, and umbrella respectively in the east side of building. It is observed that rounded and oval have also the same energy saving percents while umbrella tree has the lowest energy saving percent. On the other hand, the results indicate that the east side is the most important façade to shade while the west side is the second important side to shade followed by south, southeastern and southwestern. The same trend of values was noticed for this assumption also.

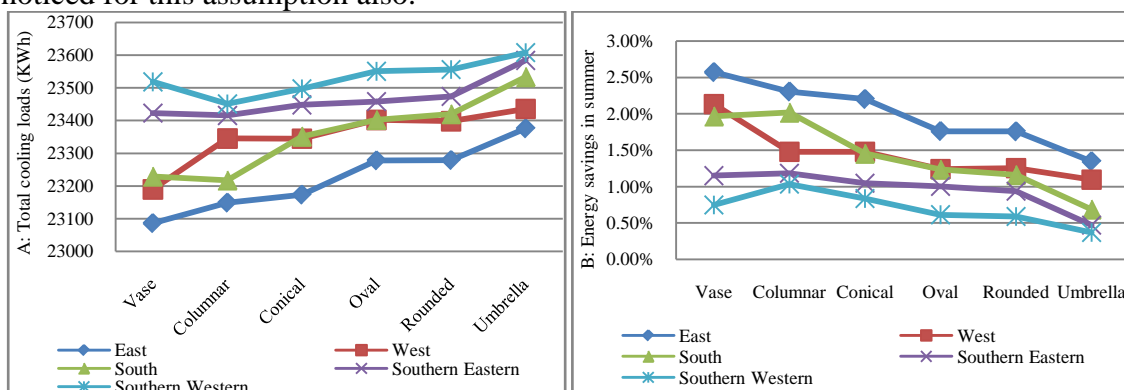


Figure (4.19): A: Total cooling loads (KWh) and B: Energy saving percent for the effect of different tree geometries (third scenario)

This assumption considered the same tree attributes of the first assumption. But, distance between the center of tree trunk and building side differ totally. It is fixed on 3 m far in the first scenario, while it changes according to crown diameter in the current scenario. Hence, the shade of all trees crowns is casted on building façade with similar manner. Therefore, it is observed in the previous figure (4.19) that there are slight leaps

between the effects of trees planting locations around building sides which did not exist in the first scenario. Figure (4.4) of first scenario had almost parallel lines of the effect of planting trees near building sides. It can be seen that east side is still the optimum while the west and south sides are almost identical for some trees types. On the other side, planting columnar tree on south side provide higher energy saving than planting it in the west side and vice versa for vase, rounded and umbrella. These leaps can be explained as each tree form has different side projection of shade form. This projection didn't appear in first and second scenario because of distance variation between tree crown and building side.

**Incident solar radiation and surface gain:** it is shown in figure (4.20) that incident solar radiation reduction percents in summer decreased by about 7.45%, 5.92%, 5.94%, 5.17%, 4.96% and 3.01% for planting vase, columnar, conical, oval, rounded, and umbrella respectively in the east side of building. Also, it is noticed the same trend for planting trees in other sides with lowest values. Columnar and conical have also the same reduction percents while umbrella tree has the lowest reduction percents. On the other hand, the results indicate that the planting trees on east side can block the highest solar radiation amount while the west and south side are the second in blocking solar radiation followed by southeastern and southwestern. Therefore, planting vase tree near building decreased incident solar radiation reduction by about 7.45%, 5.74%, 4.94%, 2.83%, and 2.45% respectively. The same trend was noticed for the rest of trees with lowest values.

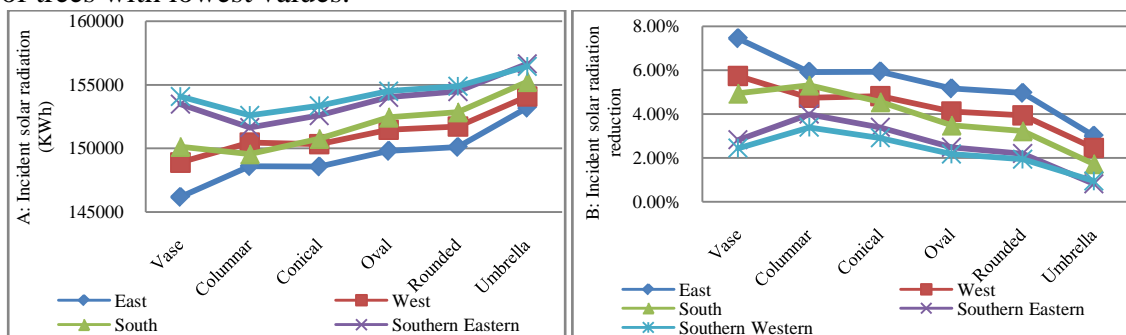


Figure (4.20): A: Incident solar radiation (KWh) and B: Incident solar radiation reduction percent for the effect of different tree geometries (third scenario)

It was observed in figure (4.21) that the surface gain reduction percents in summer decreased by about 22.62%, 16.41%, 16.36%, 14.56%, 13.98% and 7.59% for planting vase, columnar, conical, oval, rounded, and umbrella respectively in the east side of building. On the other hand, planting vase tree on east, west, south, southeastern, and southwestern sides decreased surface gain reduction percents by about 22.62%, 14.44%, 10.27%, 5.25%, and 4.42% respectively.

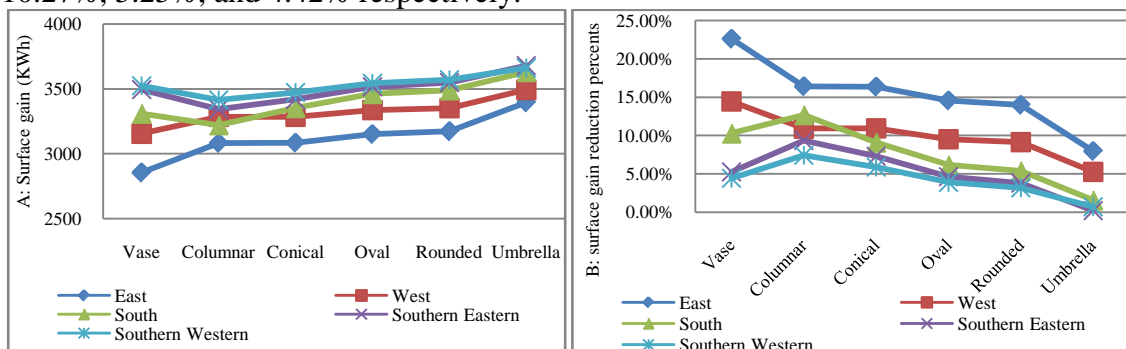


Figure (4.21): A: Surface gain (KWh) and B: surface gain reduction percent for the effect of different tree geometries (third scenario)

**Heating loads and energy consumption:** It can be seen in the following figure (4.22) that the vase tree increased heating loads in the winter more than other forms. The umbrella has the lowest impact while, oval and rounded have almost the same impact. The results indicated that planting trees in south side decreased the in increasing energy consumption by about 2.36%, 1.58%, 1.67%, and 1.09 % for vase, rounded, oval and umbrella respectively. South side is the most façade that receives solar radiation in the winter, while planting trees on east or west side has the lowest impact on increasing heating loads. On the other side, planting vase tree on southeastern and southwestern sides decreases the increasing in energy consumption by about 1.32% and 1.04% respectively. The same trend was observed in the rest of tree types with lowest values. Furthermore, increasing heating loads value in winter is happened because of blocking incident solar radiation. Planting tree in south side has the highest blocking percents for all tree geometries. Consequently, planting deciduous tree decreased incident solar radiation reduction percents by about 8.44%, 6.01%, 5.74%, and 6.31% for vase, oval, rounded, and umbrella respectively.

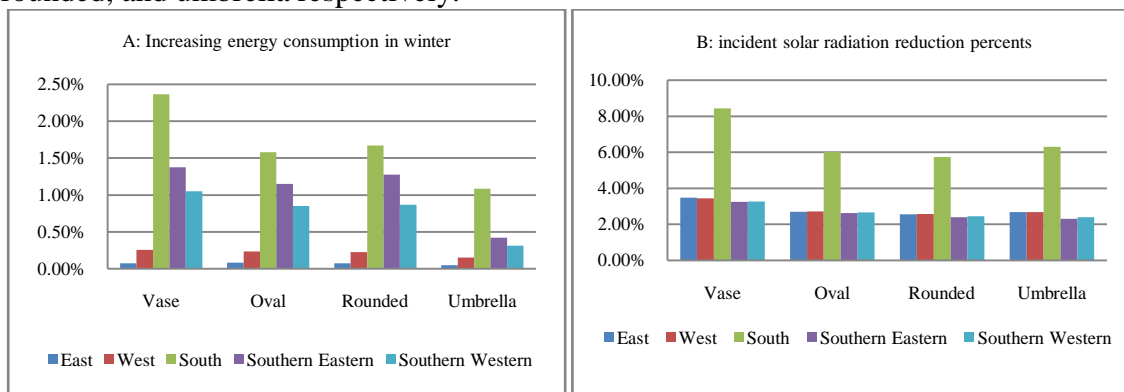


Figure (4.22): The effect of tree geometries on A: increasing energy consumption and B: increasing incident solar radiation reduction percents in winter

**Conclusion:** it was concluded from previous study that deciduous vase tree provides the highest heating loads in winter, thus the highest energy consumption. However, it is the most advisable shape to save energy in summer when planting it in east and west sides. Consequently, planting trees are more influential in east and west sides and vice versa for south side. As shown in table (4.5) and (4.6), planting vase tree in the east and the west for three scenarios provides the largest energy saving in summer. In winter, planting vase tree in the south for three scenarios has the largest energy consumption. On the other hand, planting umbrella tree in the east and the west provides the lowest energy saving in summer for the first and the third scenarios. In the second scenario, planting oval tree in the east and the west provides the lowest saving energy.

Table (4.5) Energy saving in summer for different deciduous trees types															
	First Scenario					Second Scenario					Third Scenario				
Building without trees consumed 23695.416 kWh															
Facades	East	West	South	SE	SW	East	West	South	SE	SW	East	West	South	SE	SW
Vase	2.57 %	2.13 %	1.97 %	1.15 %	0.75 %	2.60 %	2.04 %	2.01 %	1.61 %	0.76 %	2.57 %	2.13 %	1.97 %	1.15 %	0.75 %
Umbrella	1.35 %	1.09 %	0.69 %	0.47 %	0.37 %	1.93 %	1.34 %	1.01 %	0.78 %	0.41 %	1.35 %	1.09 %	0.69 %	0.47 %	0.37 %
Rounded	1.50 %	1.12 %	0.77 %	0.66 %	0.40 %	1.52 %	1.10 %	0.78 %	0.73 %	0.41 %	1.76 %	1.25 %	1.16 %	0.94 %	0.59 %
Oval	1.47 %	1.06 %	0.75 %	0.68 %	0.39 %	1.47 %	1.06 %	0.75 %	0.68 %	0.39 %	1.76 %	1.24 %	1.24 %	1.00 %	0.61 %

<b>Table (4.6) Energy consumption in winter for different deciduous trees types</b>															
	First Scenario					Second Scenario					Third Scenario				
<b>Building without trees consumed 4143.23KWh</b>															
Facades	East	West	South	SE	SW	East	West	South	SE	SW	East	West	South	SE	SW
Vase	0.07 %	0.26 %	2.36 %	1.38 %	1.05 %	0.08 %	0.26 %	2.32 %	1.32 %	1.04 %	0.07 %	0.26 %	2.36 %	1.38 %	1.05 %
Umbrella	0.05 %	0.15 %	1.10 %	0.42 %	0.31 %	0.06 %	0.22 %	2.11 %	1.64 %	1.00 %	0.05 %	0.15 %	1.09 %	0.42 %	0.31 %
Rounded	0.05 %	0.19 %	1.66 %	1.13 %	0.69 %	0.05 %	0.19 %	1.73 %	1.18 %	0.76 %	0.07 %	0.22 %	1.67 %	1.28 %	0.87 %
Oval	0.05 %	0.19 %	1.64 %	1.08 %	0.72 %	0.05 %	0.19 %	1.64 %	1.08 %	0.72 %	0.08 %	0.23 %	1.58 %	1.15 %	0.85 %

Generally, the energy saving in summer is higher than the energy consumption in winter. Thus table (4.7) illustrates the annual energy saving for planting different deciduous trees types. Vase tree has the largest annual energy saving.

<b>Table (4.7) Annual energy saving for different deciduous trees types</b>															
	First Scenario					Second Scenario					Third Scenario				
<b>Building without trees consumed 27838. KWh</b>															
facades	East	West	South	SE	SW	East	West	South	SE	SW	East	West	South	SE	SW
Vase	2.18 %	1.78 %	1.31 %	0.77 %	0.48 %	2.20 %	1.70 %	1.35 %	1.17 %	0.49 %	2.18 %	1.78 %	1.31 %	0.77 %	0.48 %
Umbrella	1.14 %	0.91 %	0.42 %	0.34 %	0.27 %	1.63 %	1.11 %	0.54 %	0.42 %	0.20 %	1.14 %	0.91 %	0.42 %	0.34 %	0.27 %
Rounded	1.27 %	0.93 %	0.41 %	0.40 %	0.24 %	1.28 %	0.91 %	0.41 %	0.44 %	0.23 %	1.49 %	1.03 %	0.73 %	0.60 %	0.37 %
Oval	1.24 %	0.88 %	0.39 %	0.42 %	0.23 %	1.24 %	0.88 %	0.39 %	0.42 %	0.23 %	1.49 %	1.02 %	0.81 %	0.68 %	0.39 %

#### 4.5 The Effect of Changing Distances and Locations of Trees on Energy Consumption

The current configuration is divided into three studies in order to evaluate the effect of increasing distances and locations of trees near building façade. The first one studies the effect of increasing distances between tree trunk center and building side on the internal thermal comfort in summer and winter. Vase, rounded, and high trunk umbrella were chosen to be simulated in this study for the following reasons:

- According to previous study, planting vase tree has the highest energy saving in summer. Planting rounded and oval trees have almost the same effect on energy savings. Also, planting high trunk umbrella has higher energy saving than short trunk umbrella. Besides that, most of trees that take umbrella form which grow horizontally and vertically are found in the Gaza Strip.
- On other side, all previous forms can be deciduous or evergreen trees, but most of columnar and conical are evergreen and large tree such as Cypress and Aleppo pin. Hence, they are excluded from study because they are not suitable for home planting and they block winter solar radiation. They are studied in previous case in term of comparing between all trees forms to find out the optimum one.

The second studies the effect of a single tree located on a single facade on thermal performance. Finally, the third studies the correlation between tree shade and solar gain through windows.

### 4.5.1 Parametric Investigation

**First study parameters:** figure (4.23) illustrates the increasing distances parameters. Hence, Increasing distances are expressed as a percentage of building height (H). The distance begins with 35% of building height (2.75m) and end with 60% of building height (4.5m).

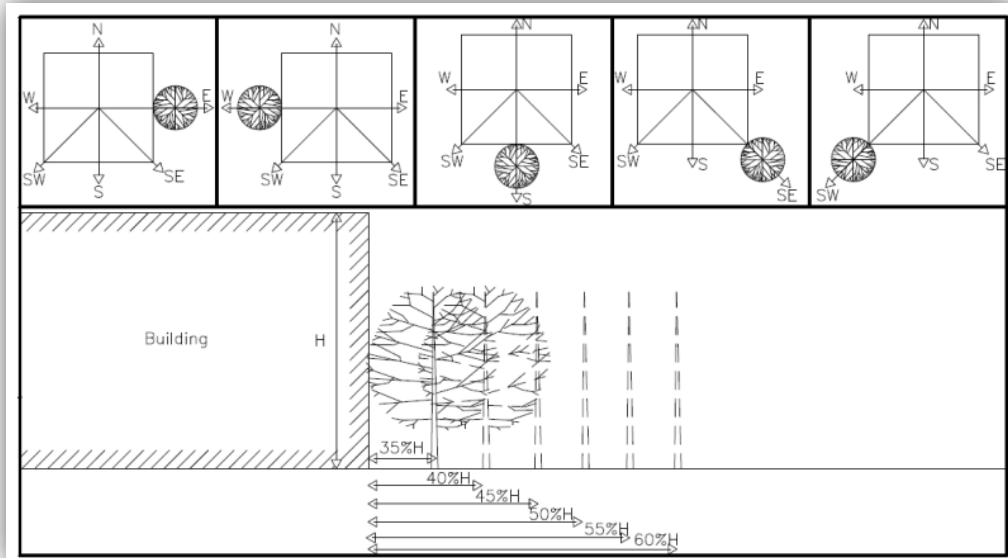
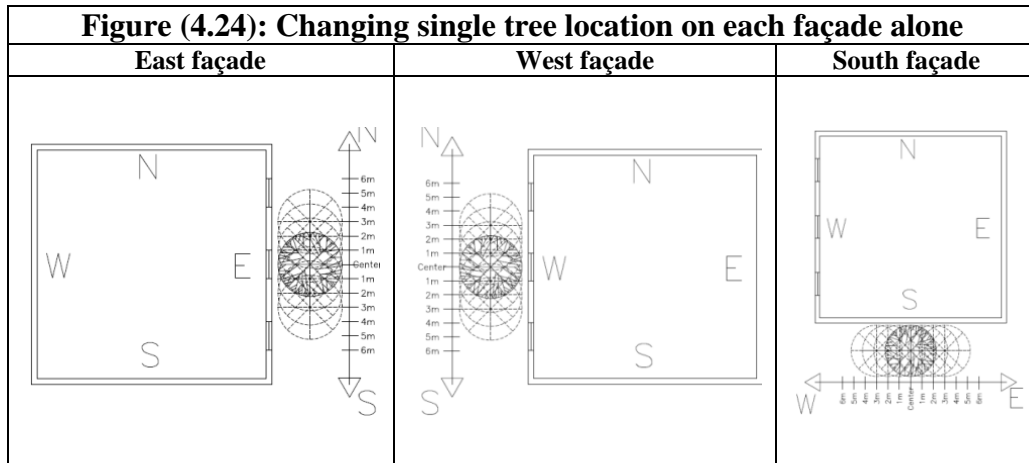


Figure (4.23): Increasing tree distances parameters combination

**Second study parameters:** Basically, all previous studies assumed that tree lie on the front of façade center. Figure (4.24) illustrates changing a single tree location on a single facade. Tree was shifted six distances to south (1S, 2S, 3S, 4S, 5S, and 6S) and six distances to north (1N, 2N, 3N, 4N, 5N, and 6N) from center of east and west facades. Also, tree was shifted on south façade to east (1E, 2E, 3E, 4E, 5E, 6E) and to west (1W, 2W, 3W, 4W, 5W, 6W). Where 1S mean 1m from center to south, 2N mean 2m from center to north and so on.



**Third study parameters:** Basically, all previous studies assumed that building façade had three windows with a homogenous distribution. Therefore, to study the correlation between tree shade and solar gain through windows, one window is simulated with one tree in east side. Table (4.8) illustrates changing a single tree location with changing window location parameters.

Table (4.8): Changing single tree location with changing window locations								
center of window is shifted 4m to north from center of façade	center of window is shifted 3m to north from center of façade	center of window is shifted 2m to north from center of façade	center of window is shifted 1m to north from center of façade	window is located on the center of façade	center of window is shifted 1m to south from center of façade	center of window is shifted 2m to south from center of façade	center of window is shifted 3m to south from center of façade	center of window is shifted 4m to south from center of façade

## 4.5.2 Simulation results

### 1. First study: increasing distances between tree trunk and building side

**Cooling loads (KWh) and energy saving in summer:** it was observed from the following figures (4.25), (4.26), and (4.27) that total cooling loads increased gradually as tree moved away from building side. Therefore, energy saving percents in summer increased as the tree becomes closer to the building side. Moving vase tree away from east side decreased energy saving percents by about 2.76%, 2.66%, 2.50%, 2.35%, 2.22%, and 2.13% for 35%H, 40%H, 45%H, 50%H, 55%H, and 60%H respectively. Also, moving umbrella tree away from east side decreased energy saving percents by about 2.16%, 2.01%, 1.88%, 1.75%, 1.63%, and 1.46% for previous distances respectively. The same trend was noticed for rounded tree with lowest values. So, moving it away from east side decreased energy saving percents by about 1.69%, 1.57%, 1.45%, 1.36%, 1.29%, and 1.16% for the same distances respectively.

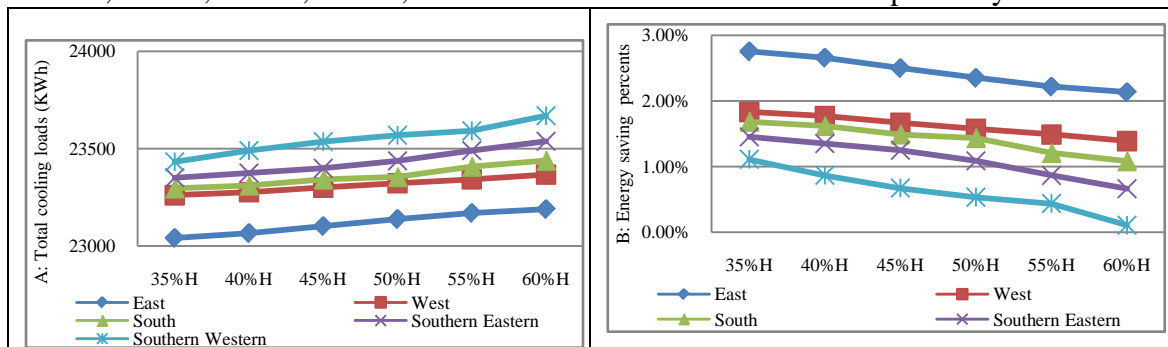


Figure (4.25): The effect of increased distances of vase tree on A: cooling loads, B: energy saving in summer

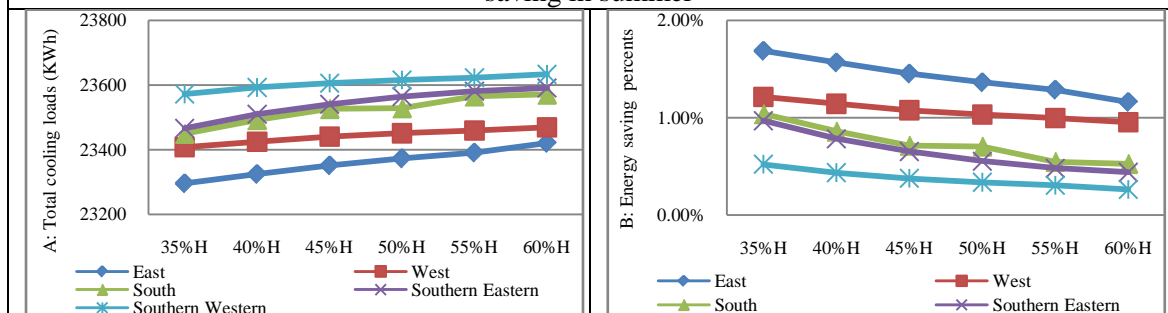


Figure (4.26): The effect of increased distances of rounded tree on A: cooling loads, B: energy saving in summer

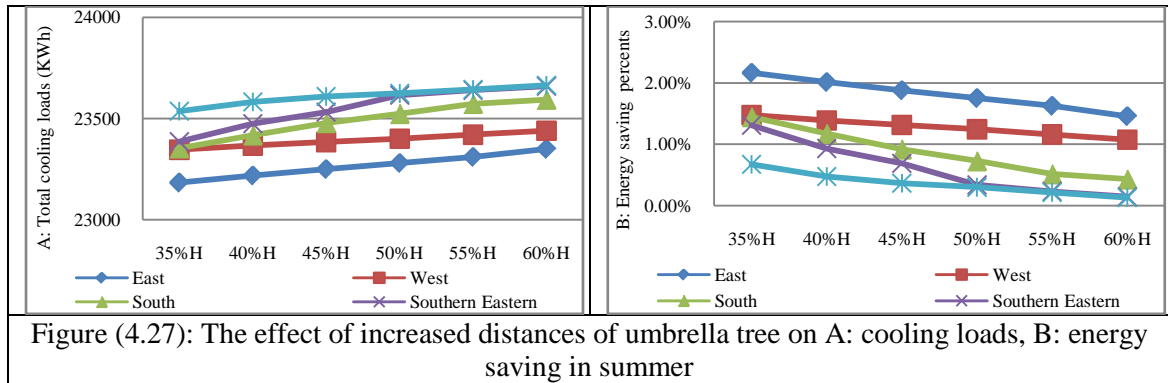


Figure (4.27): The effect of increased distances of umbrella tree on A: cooling loads, B: energy saving in summer

On the other hand, the results indicated that planting vase tree with 35%H far from east, west, south, southeastern and southwestern facades increased energy saving percents by about 2.76%, 1.83%, 1.68%, 1.45%, and 1.11% respectively. While planting umbrella tree with 35%H far from east, west, south, southern eastern and southern western facades increased energy saving percents by about 2.16%, 1.48%, 1.45%, 1.31%, and 0.67% respectively. Also, planting rounded tree with same distance far from east, west, south, southern eastern and southern western facades increased energy saving percents by about 1.69%, 1.21%, 1.04%, 0.97%, and 0.52% respectively.

Figure (4.28) illustrate the same trend by ECOTECT where simulations were performed for one tree. Moving tree away from east side decreased energy saving percents by about 1.39%, 1.14%, 0.98%, 0.90%, 0.85%, and 0.80% for 35%H, 40%H, 45%H, 50%H, 55%H, and 60%H respectively. Also, planting vase tree with 35%H far from east, west, south, southern eastern, and southern western sides decreased saving percents by about 1.39%, 0.50%, 0.35%, 0.23%, and 0.12% respectively.

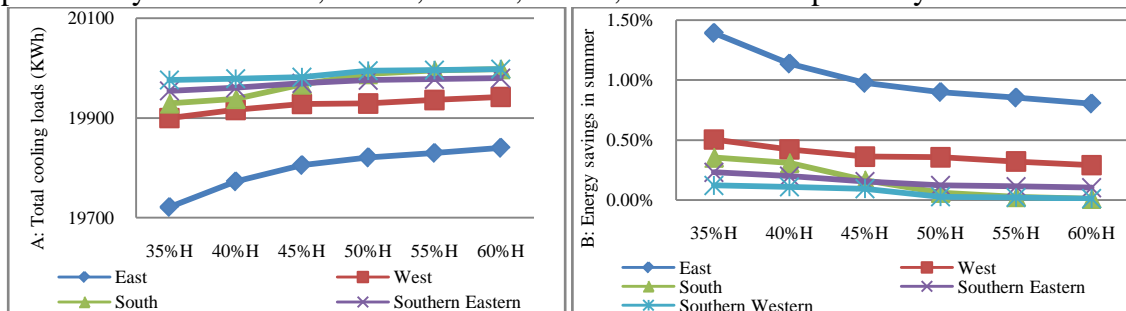


Figure (4.28): The effect of increased distances of one tree on A: cooling loads, B: energy saving in summer by ECOTECT

**Incident solar radiation and surface gain:** blocking incident solar radiation from building façades is responsible totally for the particular energy saving for each distance. As shown in figures (4.29), (4.30), and (4.31) the results indicated that the closer tree is to building side, the more shade it provides. Therefore, moving vase tree away from east side decreased incident solar radiation reduction percents by about 8.11%, 7.75%, 7.20%, 6.65%, 6.12%, and 5.68% for 35%H, 40%H, 45%H, 50%H, 55%H, and 60%H respectively. Also, it was noticed the same trend for planting trees in other sides with lowest values. In addition, moving umbrella tree away from east side decreased incident solar radiation reduction percents by about 6.25%, 5.68%, 5.14%, 4.66%, 4.0%, and 3.39% for previous distances respectively. Also, moving rounded tree away from east side decreased incident solar radiation reduction percents by about 4.70%, 4.27%, 3.87%, 3.52%, 3.21%, and 2.57% for the same distances.



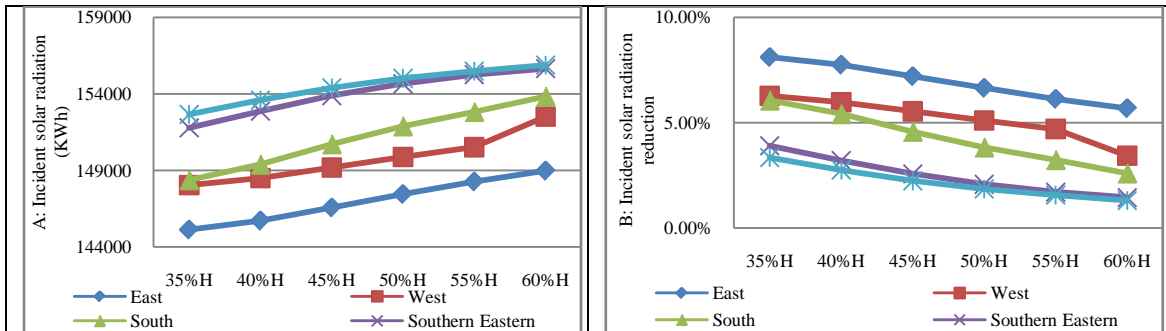


Figure (4.29): The effect of increased distances of vase tree on A: incident solar radiation, B: radiation reduction

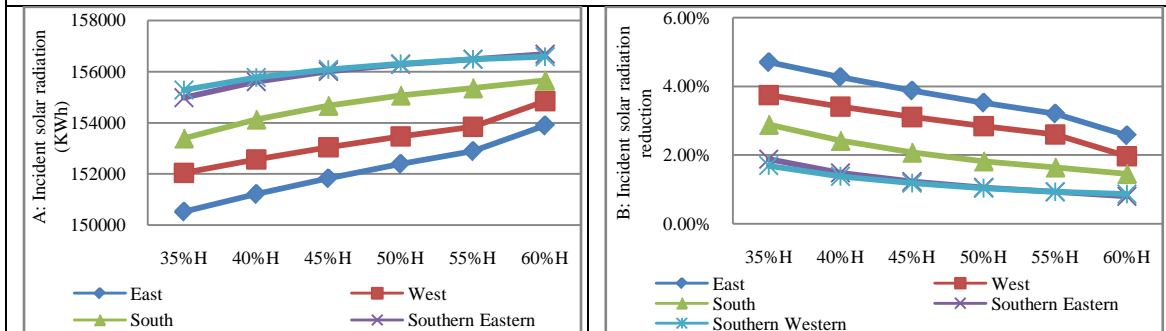


Figure (4.30): The effect of increased distances of rounded tree on A: incident solar radiation, B: radiation reduction

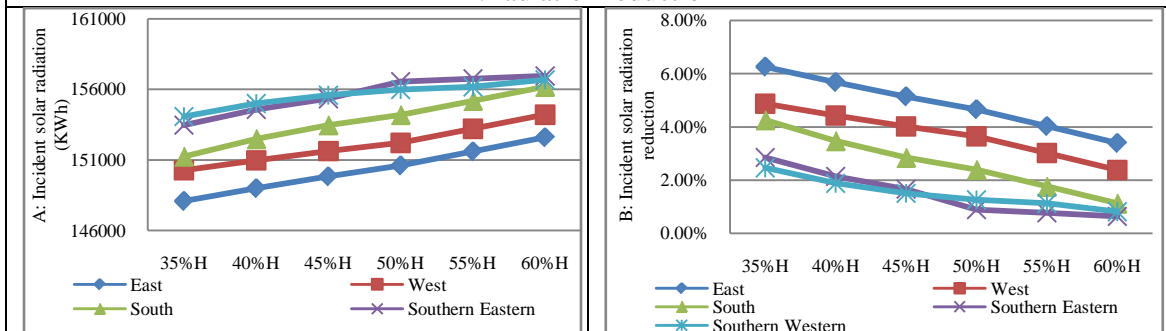


Figure (4.31): The effect of increased distances of umbrella tree on A: incident solar radiation, B: radiation reduction

Accordingly, the reduction in Incident solar radiation leads to the reduction in surface gain. As shown in the figures (4.32), (4.33), and (4.34) surface gain reduction percents in summer decreased by about 28.82%, 27.37%, 25.18%, 22.93%, 20.80% and 18.46% for moving vase tree away from east side by about 35%H, 40%H, 45%H, 50%H, 55%H, and 60%H respectively. It is noticed the same trend for the rest of tree types with lowest values.

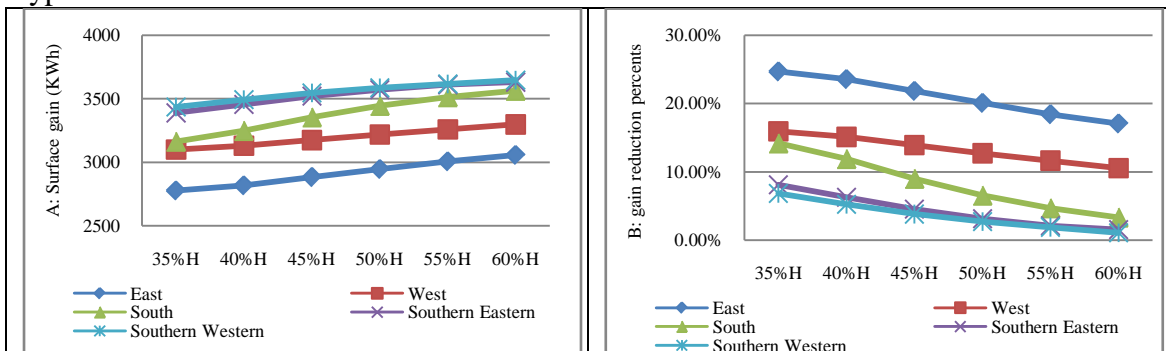


Figure (4.32): The effect of increased distances of vase tree on A: surface gain, B: gain reduction



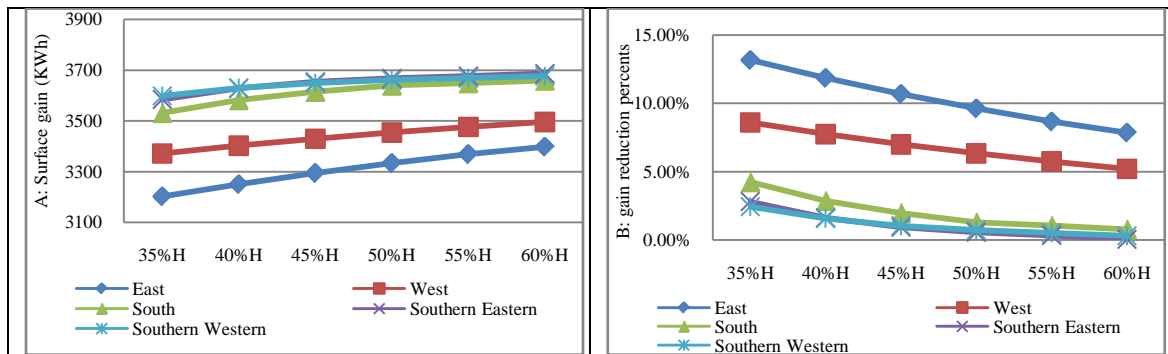


Figure (4.33): The effect of increased distances of rounded tree on A: surface gain, B: gain reduction

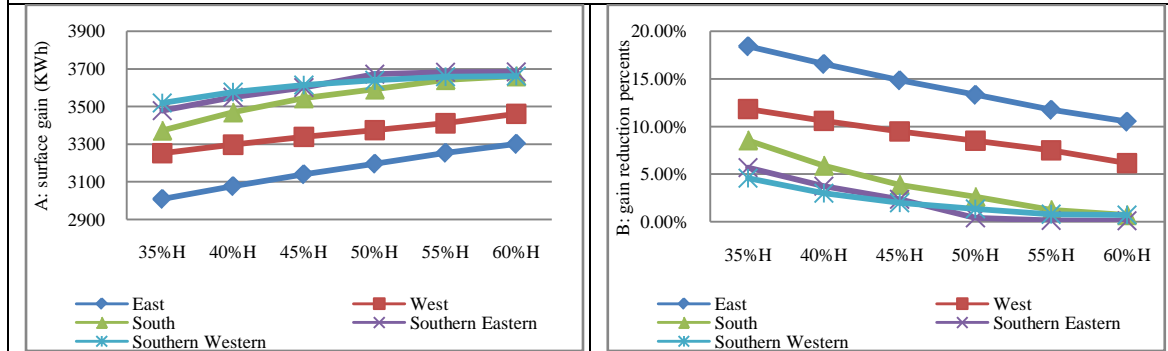


Figure (4.34): The effect of increased distances of umbrella tree on A: surface gain, B: gain reduction

**Heating loads and energy consumption:** It can be seen in the following figures (4.35), (4.36), and (4.37) that as tree is moved away from building side, energy consumption in winter decreased gradually. The effect of increasing distances on heating loads in winter is slighter comparing with its effect in summer. Therefore, moving vase tree away from south side decreased energy consumption percents in the winter by about 2.14%, 2.13%, 2.11%, 2.10%, 2.09%, and 2.07% for 35%H, 40%H, 45%H, 50%H, 55%H, and 60%H respectively. South side is façade that receive the greatest amount of solar radiation in the winter, while planting trees on east or west side has the lowest solar radiation. Therefore, incident solar radiation reduction percents in winter decreased by about 3.77%, 3.66%, 3.47%, 3.26%, and 3.04% for moving vase tree away from south side by about 35%H, 40%H, 45%H, 50%H, 55%H, and 60%H respectively.

It was noticed also that moving umbrella tree away by about 35%H, 40%H, 45%H, 50%H, 55%H, and 60%H from south side decreased energy consumption percents in the winter by about 2.18%, 2.14%, 2.13%, 2.01%, 1.94%, and 1.87% respectively. On the other side, incident solar radiation reduction percents in winter decreased by about 3.07%, 2.84%, 2.60%, 2.36%, and 2.15% for moving tree away from south side by about 35%H, 40%H, 45%H, 50%H, 55%H, and 60%H respectively. Also, moving rounded tree away by about 35%H, 40%H, 45%H, 50%H, 55%H, and 60%H from south side decreased energy consumption percents in the winter by about 1.68%, 1.67%, 1.64%, 1.60%, 1.53%, and 1.46% respectively. Also, incident solar radiation reduction percents in winter increased by about 2.34%, 2.14%, 1.93%, 1.73%, and 1.53% for moving tree away from south side by about 35%H, 40%H, 45%H, 50%H, 55%H, and 60%H respectively.

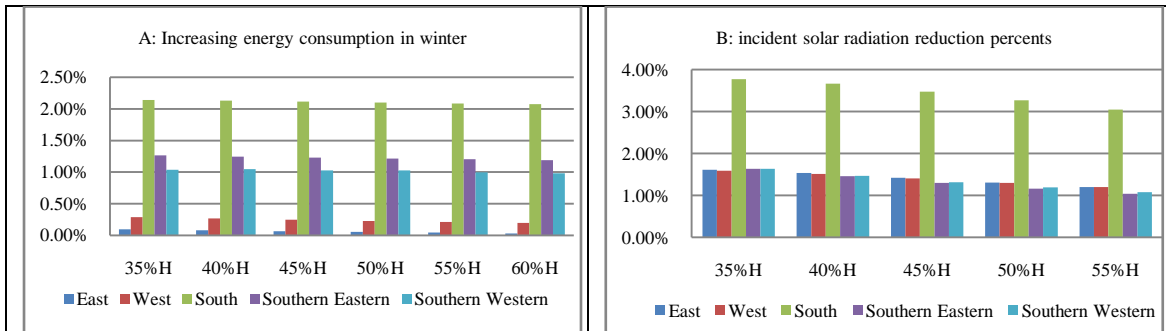


Figure (4.35): The effect of increased distances of vase tree on A: Energy consumption in winter, B: incident solar radiation reduction

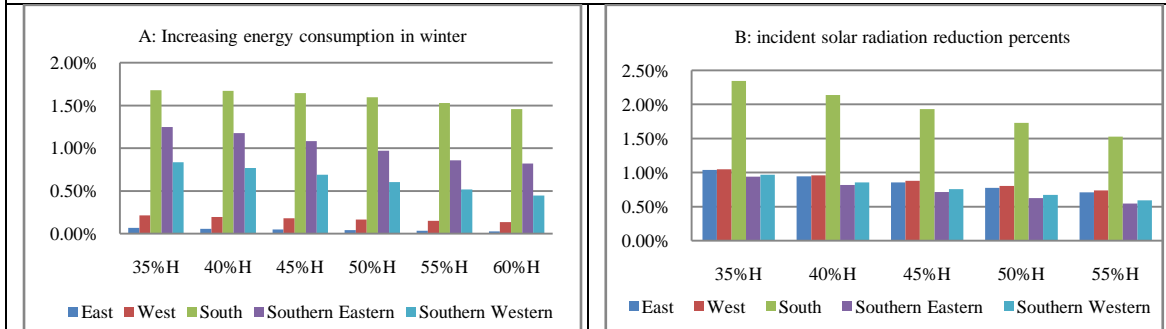


Figure (4.36): The effect of increased distances of rounded tree on A: Energy consumption in winter, B: incident solar radiation reduction

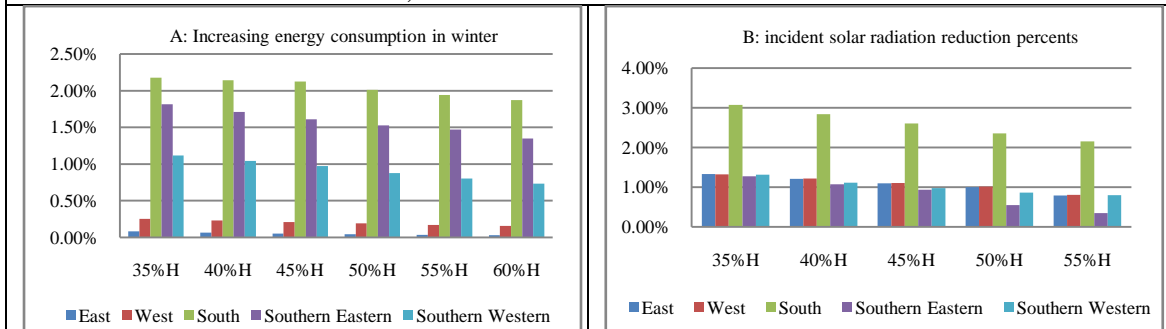


Figure (4.37): The effect of increased distances of umbrella tree on A: Energy consumption in winter, B: incident solar radiation reduction

Also, the same trend of the results was observed by ECOTECT with lowest values. Energy consumption decreased in winter by about 0.39%, 0.37%, 0.29%, 0.26%, 0.25%, and 0.24% for moving tree away from east side by about 35%H, 40%H, 45%H, 50%H, 55%H, and 60%H respectively. See figure (4.38)

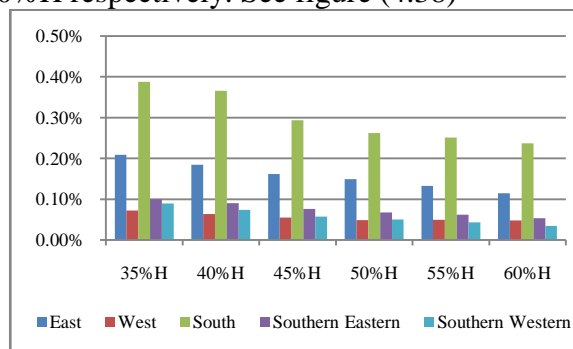


Figure (4.38): The effect of increased distances of rounded tree on energy consumption in winter by ECOTECT

**2. Second study:** The effect of different tree locations in front of a single façade on energy consumption and solar gain

**Total cooling loads and solar gain:** the results indicate that the total cooling loads and solar gain through windows decreased gradually as tree is shifted to south. It was observed in the figures (4.39) and (4.40) that shifting tree to north or to south in east or west facades has the same trend with different values. In eastern side of building, moving tree from furthest north (6N) to furthest south (6S) increased energy saving in summer by about 0.98%, 1.18%, 1.26%, 1.28%, 1.33%, 1.41%, 1.50%, 2.08%, 3.87%, 5.97%, 7.04%, 6.76%, and 4.58 respectively. Also in western side of building, moving tree from furthest north (6N) to furthest south (6S) increased energy saving in summer by about 0.65%, 0.78%, 0.85%, 0.87%, 0.92%, 1.00%, 1.12%, 1.62%, 3.00%, 4.58%, 5.39%, 5.10%, and 3.45 respectively.

Solar gain through windows has almost the same trend with different values. In eastern side of building, moving tree from furthest north (6N) to furthest south (6S) increased solar gain reduction percents in summer by about 0.27%, 0.47%, 0.61%, 0.65%, 0.87%, 1.26%, 1.73%, 3.71%, 9.49%, 16.32%, 19.75%, 18.83%, and 12.38 respectively. Also in western side of building, moving tree for same distances increased solar gain reduction percents in summer by about 0.28%, 0.47%, 0.61%, 0.65%, 0.87%, 1.26%, 1.79%, 3.34%, 7.29%, 11.92%, 14.36%, 13.62%, and 9.21 respectively.

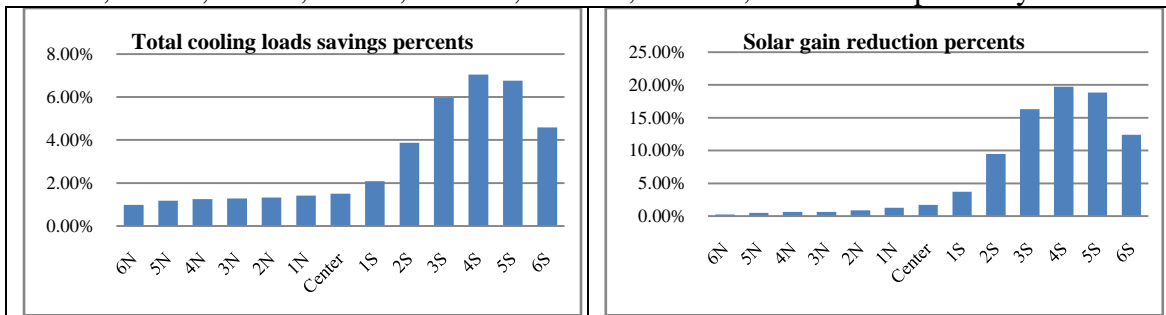


Figure (4.39): Energy savings percents in summer and solar gain reduction percents (in east façade)

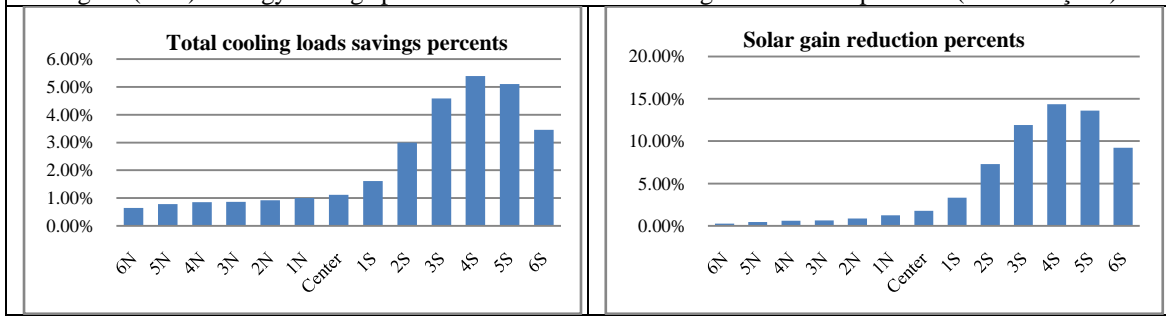


Figure (4.40): Energy savings percents in summer and solar gain reduction percents (in west façade)

The previous results can be analyzed and discussed in term of sun altitude angel through the day. As tree moves toward south, blocked Incident solar radiation becomes higher than it as tree moves toward north. When sun shines from east and begins to move to south, its radiation and intensity become greater gradually. However the effect of tree shade on south façade is low compared with east façade because of parallel sun rays to south in midday, the solar radiation intensity is the greatest in this period. As shown in figure (4.41), before reaching solar altitude angle to its perpendicularity on building roof, its radiation still effective on south of eastern façade. It can be seen in table (4.9) that the larger incident solar radiation angle on surface is, the lower solar radiation percentage on this surface is.

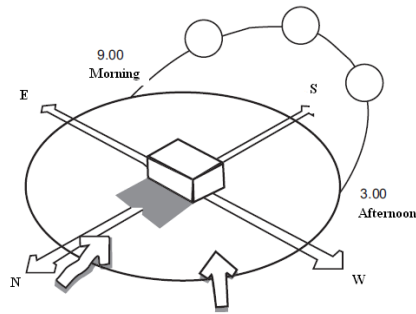


Figure (4.41): Sun path during midday in summer, (ministry of local government, 2004)  
(adapted by uthor)

**Table (4.9): The relationship between incident solar radiation angel and solar radiation percentage, (ministry of local government, 2004) (adapted by uthor)**

Incident solar radiation angel on surface	Solar radiation percentage
0°	100
5°	99.6
10°	98.5
15°	96.5
20°	94.0
25°	90.6
30°	86.6
35°	81.9
40°	76.6
45°	70.7
50°	64.3
55°	57.4
60°	50.0
65°	42.3
70°	34.2
75°	25.9
80°	17.4
85°	8.7
90°	0.0

It was noticed also from figures and percents that energy saving and solar gain reduction percents become the highest when moving tree 4m to south (4S), while it begin to reduce slightly in (5S) and (6S). This is explained as that tree on (4S) meet the window center that located on the southern edge of east facade. Hence, solar gain by windows is greater than gain by wall because U value for windows (5.6 W/m<sup>2</sup>.K) is greater than it for wall (2.15 W/m<sup>2</sup>.K). U value is a measure of heat loss in a building element such as a wall, floor or roof. It can also be defined to as an ‘overall heat transfer co-efficient’ and measures how well parts of building transfer heat. This means that the higher the U value is, the worse the thermal performance of the building envelope is. For these reasons, location of tree on (4S) is more affected than its location on (5S) and (6S).

On the other hand, moving tree on south façade as shown in figure (4.42) to east (1E, 2E, 3E, 4E, 5E, 6E) and to west (1W, 2W, 3W, 4W, 5W, 6W) has lower percents than moving tree on east and west facades. The results indicated that as tree moves to east, total energy savings and solar gain reduction percents increase gradually. Therefore, planting tree after 4 m from façade center to east (4E) provides the highest percent because it meets the center of window. As mentioned before, tree shade on east side has an ability to reduce energy consumption more than west side due to high heat gains by building envelop through day. Building elements become big thermal mass afternoon that make tree shade less effective on west façade. In southern side of building, moving tree from furthest west (6W) to furthest east (6E) increased energy

saving percents in summer by about 0.28%, 0.36%, 0.42%, 0.45%, 0.52%, 0.63%, 0.77%, 0.99%, 1.29%, 1.60%, 1.78%, 1.69%, and 1.36% respectively. Also, it increased solar gain reduction percents in summer by about 0.28%, 0.50%, 0.66%, 0.71%, 0.97%, 1.42%, 1.98%, 2.91%, 4.16%, 5.41%, 6.11%, 5.73%, and 4.52% respectively.

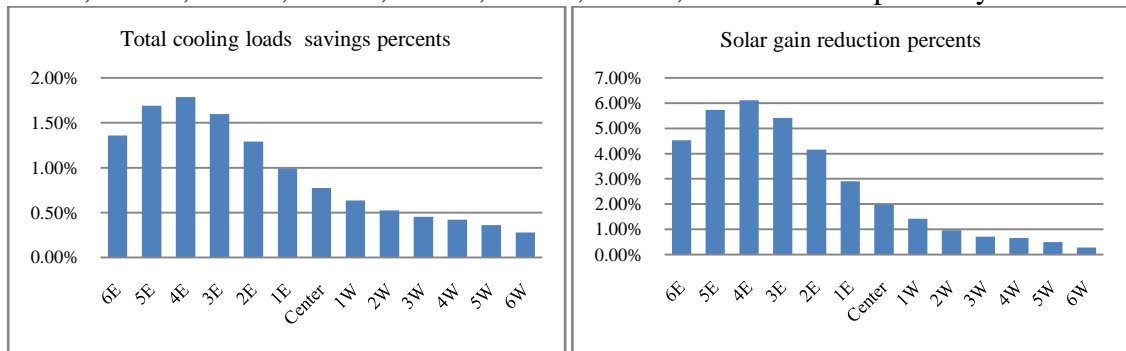


Figure (4.42): Energy savings percents in summer and solar gain reduction percents (in south façade)

Energy consumption percents in winter have the same trends. As shown in figure (4.43) planting tree on south side increases energy consumption more than planting it in east and west sides. As well as energy consumption increased gradually as tree moves to the east, where it increase in east and west as tree move to south. In southern side of building, moving tree from furthest west (6W) to furthest east (6E) increases energy consumption percents in winter by about 0.63%, 0.72%, 0.83%, 0.96%, 1.12%, 1.34%, 1.66%, 2.14%, 2.83%, 3.55%, 3.94%, 3.74%, and 3.06% respectively.

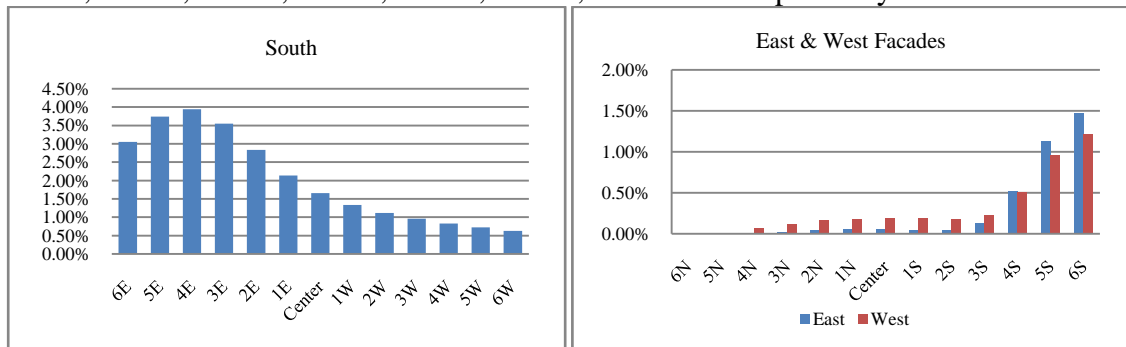


Figure (4.43): Energy consumption percents in winter for three building façades

This scenario demonstrated strongly the effect of solar gain through windows when tree location on single façade changes. It is found that tree shade is more effective when face the center of window or close to it. Next case will study deeply the effect of different tree location in the case of different locations of single window on total cooling loads and solar gain.

### 3. Third study: The effect of changing locations of a single tree in front of a single façade with different location of a single window on energy consumption

It is noticed obviously in the following figures in table (4.10) that as tree location face the center of window where it is positioned, total cooling loads savings and solar gain reduction percents become the highest. This result assures the fact that solar gain through window is greater than it by wall because of the high U value.

The effect of sun altitude angel, façade direction, and other factors that are discussed before are less important compared with solar gain that play the significant

role in increasing energy consumption inside building or vice versa. Total cooling loads savings trend follow the same trend of solar gain reduction. Consequently, the highest energy saving percent is 3.43% for all the cases, while the highest solar gain reduction percent is 19.66%.

**Table (4.10) The effect of changing locations of single tree on east façade with different of single window on energy consumption**

Figure (4.44): Different locations of a single tree, center of window is shifted 4m to north from center of façade

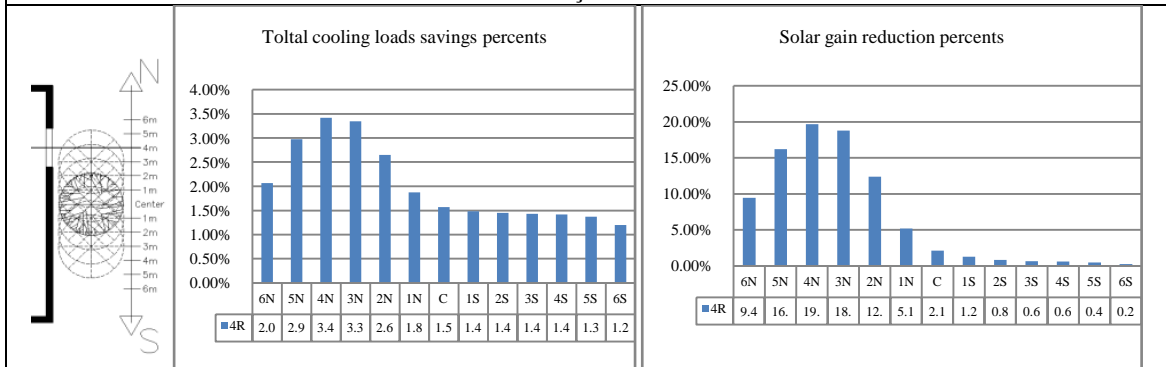


Figure (4.45): Different positions of a single tree, center of window is shifted 3m to north from center of façade

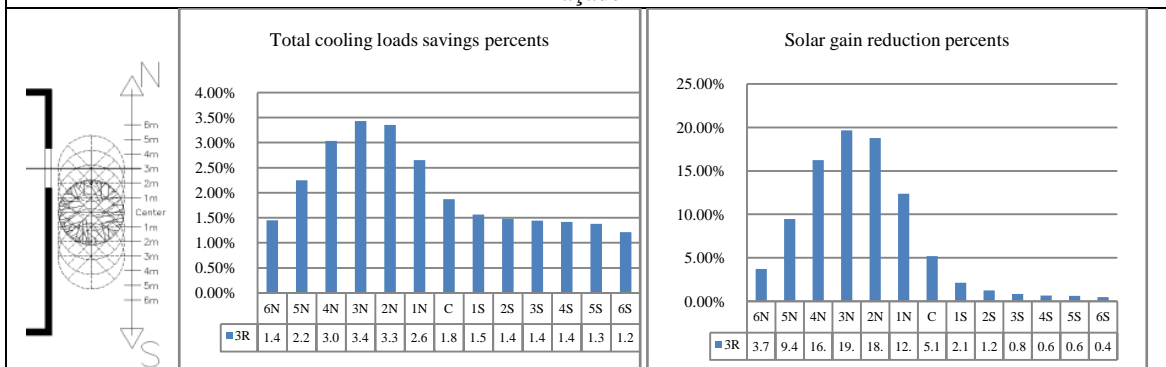


Figure (4.46): Different positions of a single tree, center of window is shifted 2m to north from center of façade

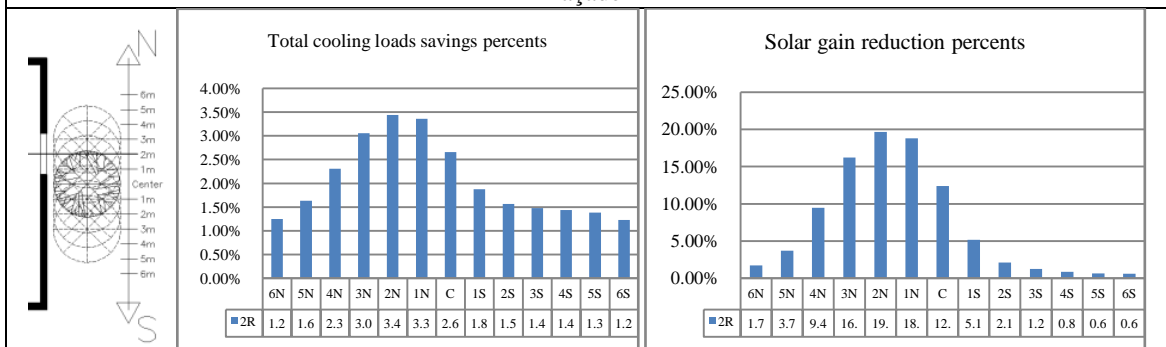


Figure (4.47): Different positions of a single tree, center of window is shifted 1m to north from center of façade

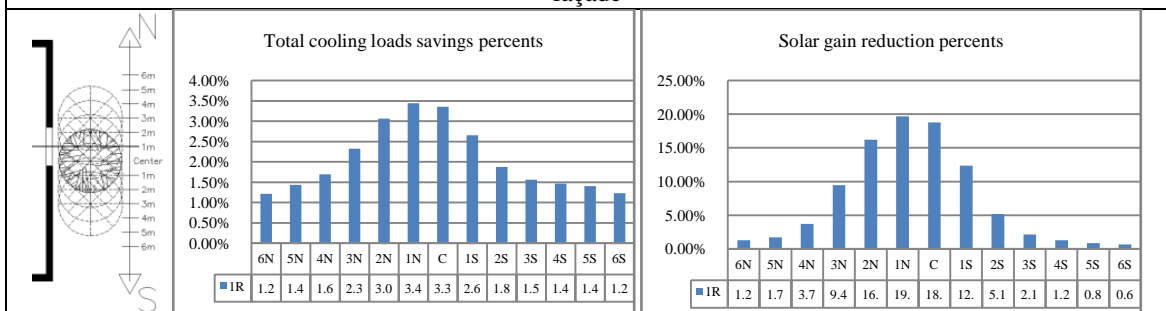


Figure (4.48): Different positions of a single tree, Window is located on the center of façade

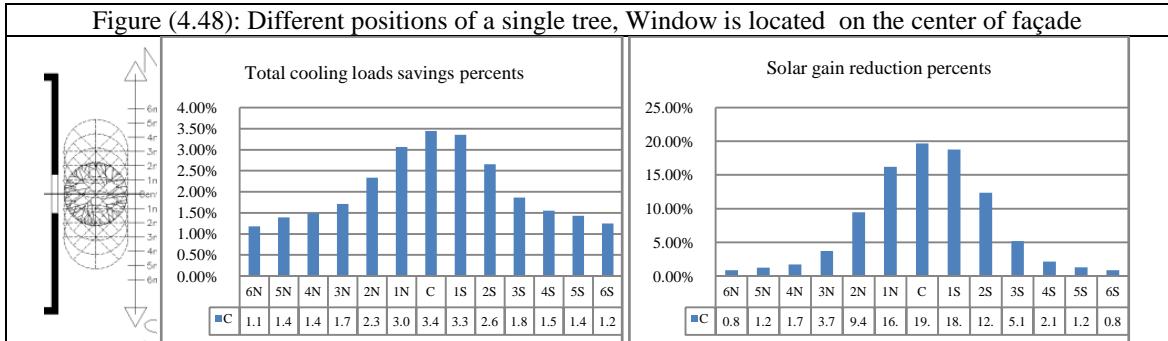


Figure (4.49): Different positions of a single tree, center of window is shifted 1m to south from center of façade

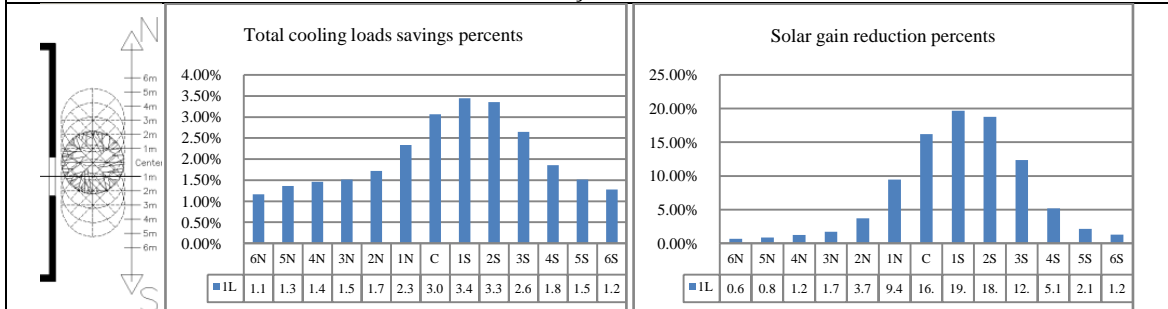


Figure (4.50): Different positions of a single tree, center of window is shifted 2m to south from center of façade

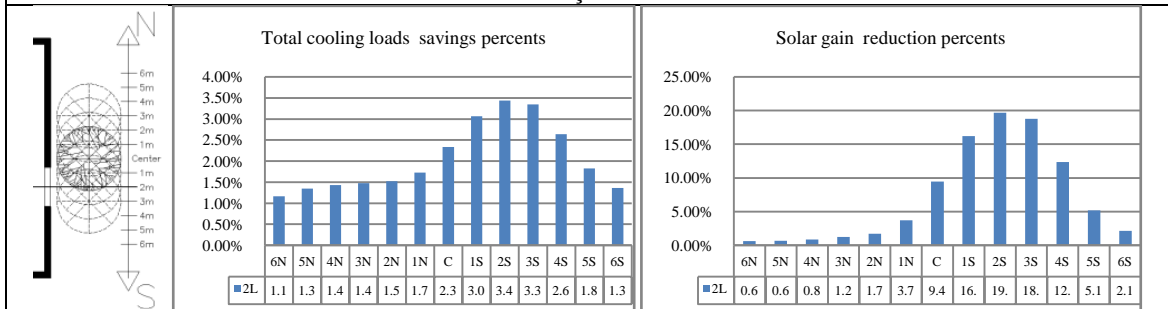


Figure (4.51): Different positions of single tree, center of window is shifted 3m to south from center of façade

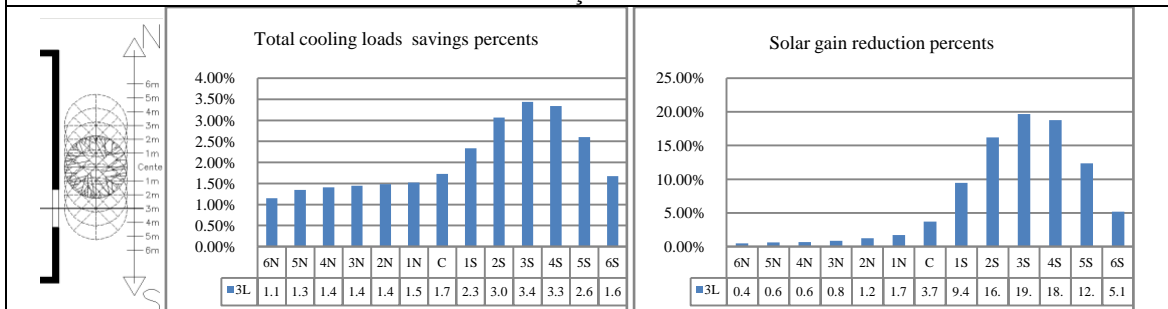
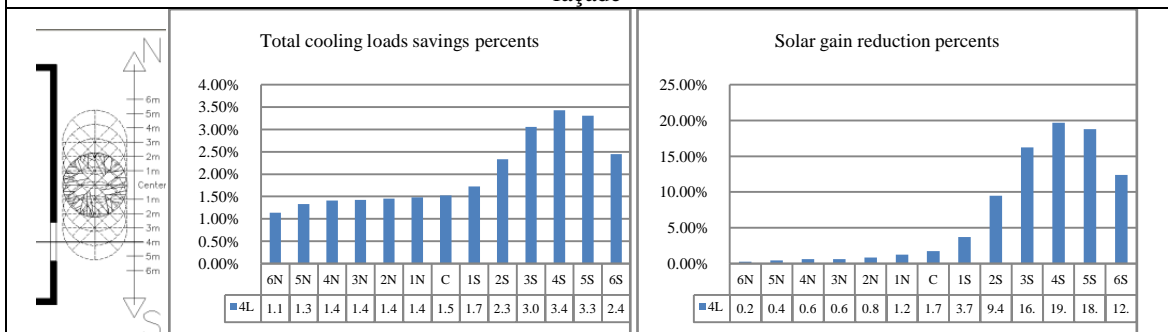


Figure (4.52): Different positions of a single tree, center of window is shifted 4m to south from center of façade





## 4.6 The Effect of Increasing Trees Crowns Size on Energy Consumption

The current configuration studies the effect of increasing tree crown size on internal thermal performance and energy consumption in both summer and winter. Vase, rounded, and high trunk umbrella were chosen to be simulated in this scenario. Distance between the center of tree trunk and building façade is 3m.

### 4.6.1 Parametric Investigation

The figure (4.53) illustrates crown size parameters. Actual size is the mature size of different planted trees types in Gaza. One hundred percent represent trees size as an average from all planted trees size that used in previous simulations. Other percent represent smaller or larger tree crown size.

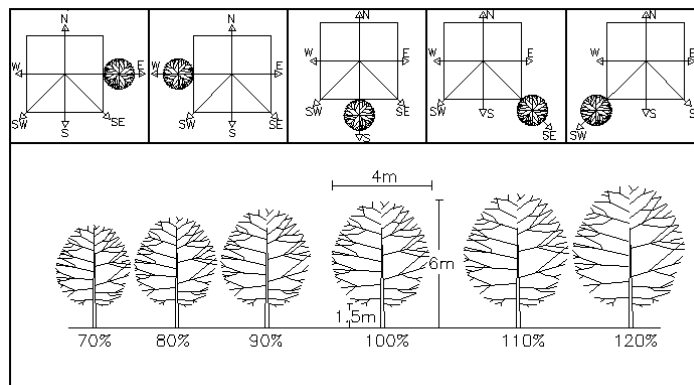


Figure (4.53): Increasing trees crowns size parameters

### 4.6.2 Simulation results

**Cooling loads (KWh) and energy saving in summer:** it was observed from the figures (4.54), (4.55), and (4.56) that total cooling loads increased gradually as tree crown size increased. Therefore, energy saving percents in summer increased as tree crown size increased. Hence, increasing crown size of vase tree by 70%, 80%, 90%, 100%, 110%, and 120%, increased energy saving percents by about 1.09%, 1.51%, 1.99%, 2.57%, 3.16%, and 3.78% respectively. Also, increasing crown size of umbrella tree for previous size increased energy saving percents by about 0.84%, 1.11%, 1.45%, 1.93%, 2.44%, and 2.86% respectively. The same trend was noticed for rounded tree with lowest values. Thus, increasing its crown size increased energy saving percents by about 0.65%, 0.87%, 1.14%, 1.50%, 1.82%, and 2.24% respectively.

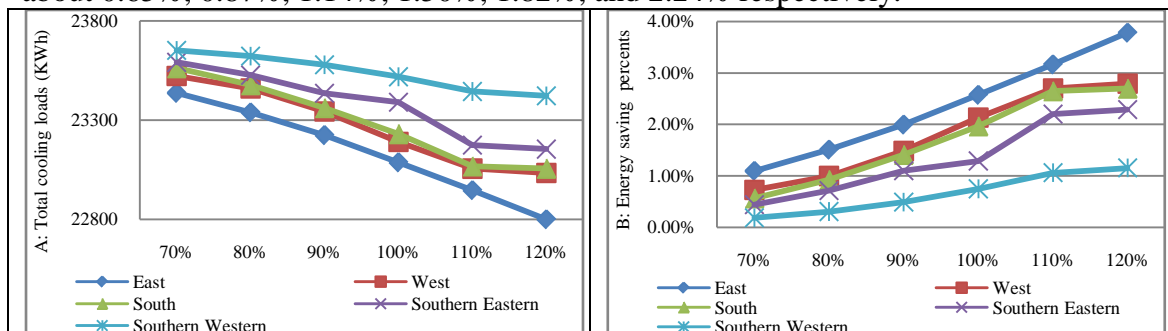


Figure (4.54): The effect of increasing crown size of vase tree on A: cooling loads, B: energy saving in summer



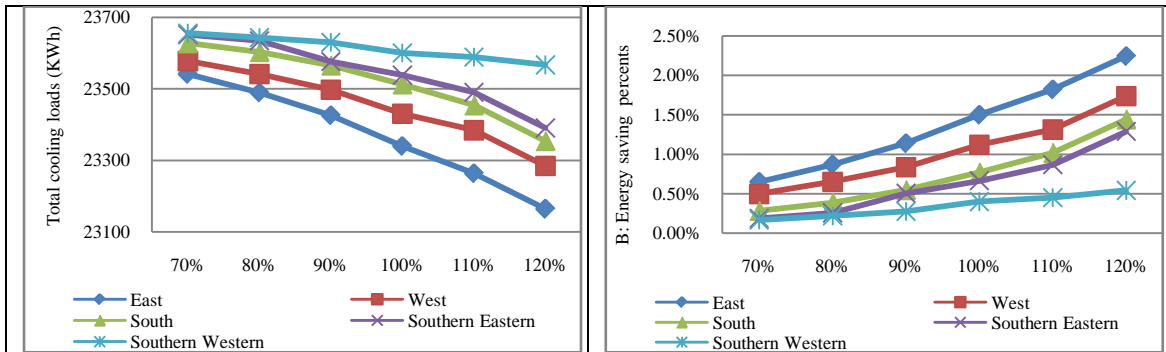


Figure (4.55): The effect of increasing crown size of rounded tree on A: cooling loads, B: energy saving in summer

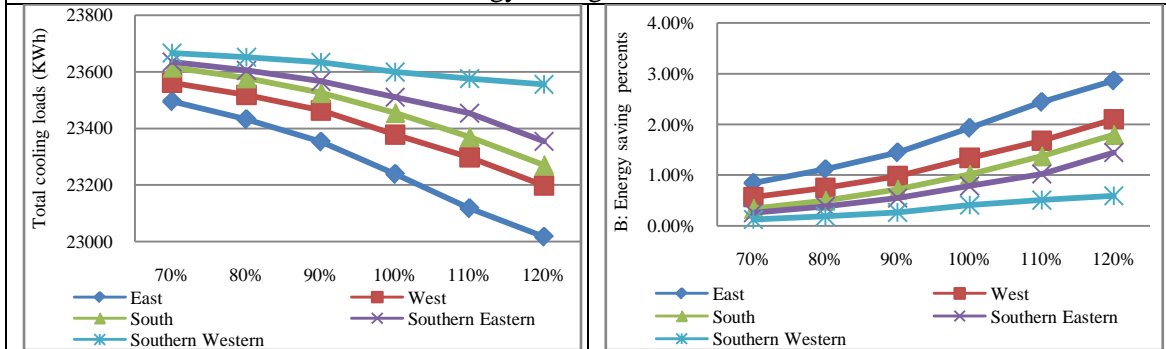


Figure (4.56): The effect of increasing crown size of umbrella tree on A: cooling loads, B: energy saving in summer

Figure (4.57) illustrates the same trend by ECOTECT. Increasing crown size by 70%, 80%, 90%, 100%, 110%, and 120% increased energy saving percents by about 0.57%, 0.70%, 0.81%, 1.04%, 1.92%, and 2.18% respectively. Also, planting 120% crown size in east, west, south, southern eastern, and southern western sides increased saving percents by about 2.18%, 0.93%, 0.58%, 0.50%, and 0.39% respectively.

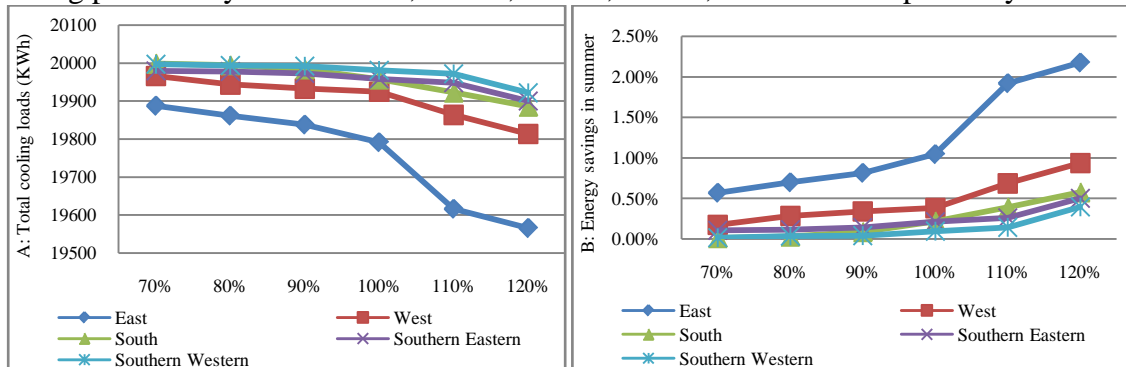


Figure (4.57): The effect of increasing tree crown size on A: cooling loads, B: energy saving in summer by ECOTECT

**Incident solar radiation:** As shown in figures (4.58), (4.59), and (4.60) that the bigger tree crown size is, the more shade it provides. As vase tree crown get larger, shade percents increased gradually about by 1.09%, 1.51%, 1.99%, 2.57%, 3.16%, 3.78% on east side. The same trend was noticed for the rest of building sides with lowest values. On the other hand, shade percents increased by increasing rounded tree size on east side by about 0.65%, 0.87%, 1.14%, 1.50%, 1.82%, and 2.24% respectively. Moreover, shade percents are increased by increasing umbrella tree size on east side by about 0.84%, 1.11%, 1.45%, 1.93%, 2.44%, 2.86% respectively.

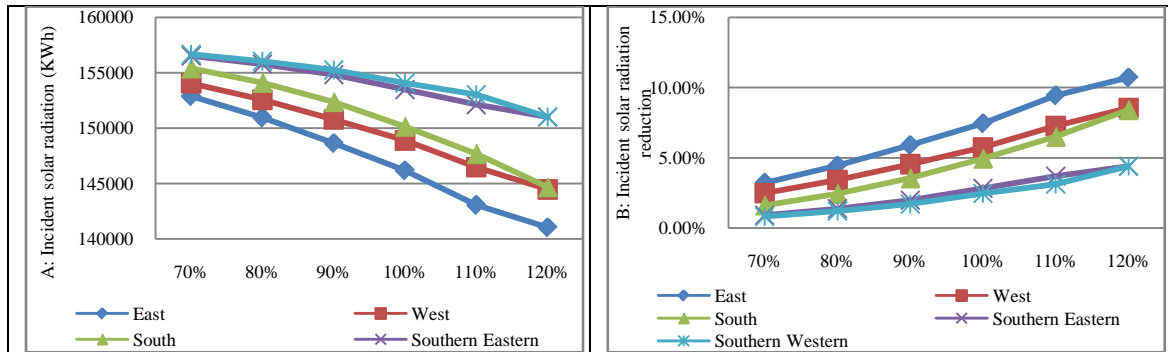


Figure (4.58): The effect of increasing crown size of vase tree on A: incident solar radiation, B: radiation reduction

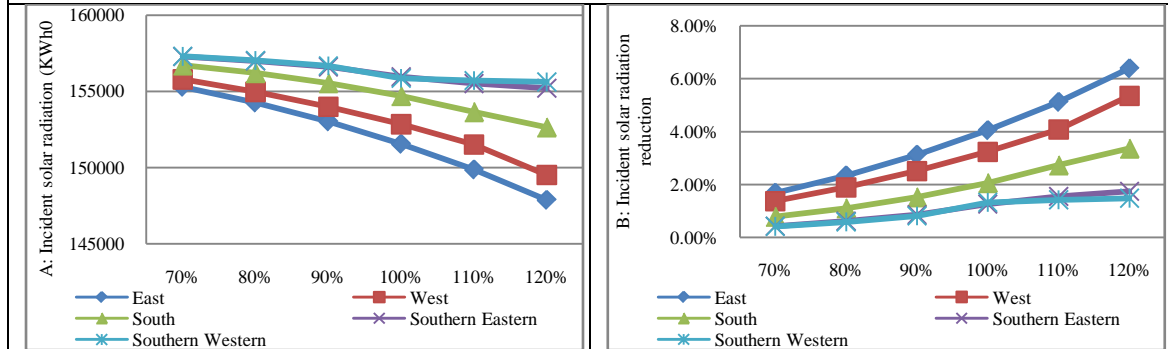


Figure (4.59): The effect of increasing crown size of rounded tree on A: incident solar radiation, B: radiation reduction

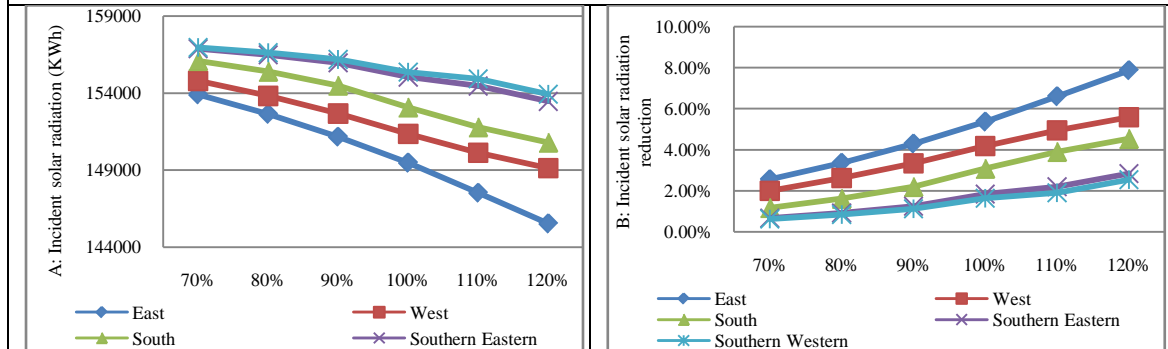


Figure (4.60): The effect of increasing crown size of umbrella tree on A: incident solar radiation, B: radiation reduction

**Heating loads and energy consumption:** It can be seen in the figure (4.61) that as tree crown is getting bigger, energy consumption in winter increased gradually. The effect of increasing crown size on heating loads in winter is slighter comparing with its effect in summer. Therefore, increasing crown size of vase tree by 70%, 80%, 90%, 100%, 110%, and 120% in south side, increased energy consumption percents by about 1.42%, 1.72%, 2.01%, 2.09%, 2.61%, and 2.92% respectively. South side receives the greatest amount of solar radiation in winter, while planting trees on east or west side has the lowest solar radiation. It was noticed also that increasing crown size of umbrella tree by 70%, 80%, 90%, 100%, 110%, and 120% in south side, increased energy consumption percents by about 1.21%, 1.49%, 1.78%, 2.00%, 2.46%, and 2.53% respectively. Also, increasing crown size of rounded tree by 70%, 80%, 90%, 100%, 110%, and 120% in south side, increased energy consumption percents by about 0.84%, 1.09%, 1.36%, 1.38%, 1.96%, and 2.38% respectively.

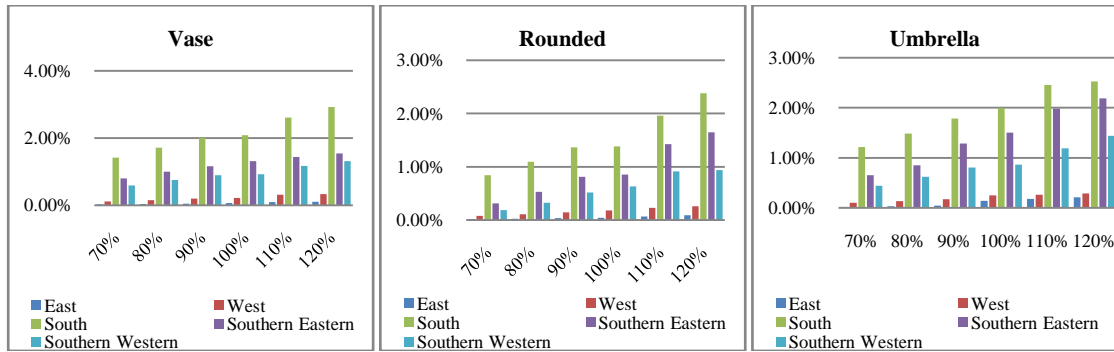


Figure (4.61): The effect of increasing crown size of different tree type on energy consumption percents in winter

Also, the same trend of the results was observed by ECOTECT with lowest values. In south side, energy consumption increased in winter by about 0.16%, 0.20%, 0.25%, 0.31%, 0.59%, and 0.94% for increasing tree crown size by 70%H, 80%H, 90%H, 100%H, 110%H, and 120%H respectively. See figure (4.62)

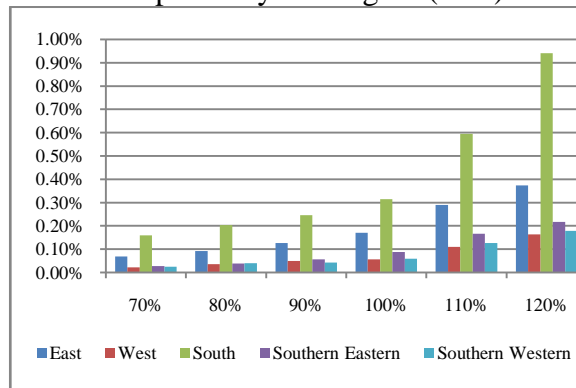


Figure (4.62): The effect of increasing crown size of on energy consumption percents in winter by ECOTECT

## 4.7 The Effect of Increasing Trees Number on Energy Consumption

It is widely known that increasing shading devices quantities leads to decreasing cooling loads in summer and increasing heating loads in winter. Tree as shading device plays significant role in achieving thermal comfort in summer and winter if right number of trees were planted in right place. The current configuration studies the effect of increasing number of tree on internal thermal comfort and energy consumption in both summer and winter. There are 64 simulated models that describe the possibilities of all trees numbers and locations. In this building case, the diameter of one tree crown was taken as 33% of building façade. Hence, 100% of building façade was taken by planting three trees on building façade. That mean, building need nine trees to reach to the optimum energy savings in summer. Nine trees is planted in three facades including east, west, and south while north façade is excluded. Therefore, the current configuration is divided into nine scenarios. Each one of them has group of tree number possibilities that correlate with tree locations in specific facade.

### 4.7.1 Parametric Investigation

The parametric investigation for this study includes nine parameter combinations. Each combination has a group of tree location possibilities. Table (4.11) illustrates the parametric combination for all scenarios.

<b>Table (4.11): Tree number parameter combination</b>		
Two trees	Six locations possibilities are simulated with two trees: two trees on east façade (2E), two trees on west façade (2W), two trees on south façade (2S), one east and one west (1E1W), one east and one south (1E1S), and one west and one south (1W1S)	
Three trees	Nine locations possibilities are simulated for three trees: three trees on east façade (3E), three trees on west façade (3W), three trees on south façade (3S), two east and one west (2E1W), two east and one south (2E1S), two west and one south (2W1S), two west and one east (2W1E), two south and one west (2S1W), and finally two south and one east (2S1E)	
Four trees	Twelve locations possibilities are simulated for four trees: 3E1W, 3E1S, 3W1E, 3W1S, 3S1E, 3S1W, 2W2E, 2E2S, 2W2S, 2E1W1S, 2W1E1S and finally 2S1E1W	
Five trees	Twelve locations possibilities are simulated for five trees: 3E2W, 3E2S, 3W2E, 3W2S, 3S2E, 3S2W, 2W2E1S, 2E2S1W, 2W2S1E, 3E1W1S, 3W1E1S and 3S1W1E	
Six trees	Ten locations possibilities are simulated for six trees: 3E3W, 3E3S, 3W3S, 2E2W2S, 3E2W1S, 3W2E1S, 3E2S1W, 3W2S1E, 3S2E1W and finally 3S2W1E	
Seven trees	Six locations possibilities are simulated for seven trees 3E3W1S, 3E3S1W, 3W3S1E, 3E2W2S, 3W2E2S, and finally 3S2W2E	
Eight trees	Three locations possibilities are simulated for eight trees: 3E3W2S, 3E3S2W, and 3W3S2E	
Nine trees	One possibility is simulated 3E3W3S	

The previous locations possibilities can be collected in one table that is considered as a final conclusion. As shown in table (4.12) the percentage values represent tree coverage of each building facade. That mean 0%=no trees, 33%=one tree, 66%=two trees, and 100%=three trees.

South	0%				33%				66%				100%			
East/ West	0%	33%	66%	100%	0%	33%	66%	100%	0%	33%	66%	100%	0%	33%	66%	100%
0%	with out trees	1W	2W	3W	1S	1W1 S	2W1 S	3W1 S	2S	1W2 S	2W2 S	3W2 S	3S	1W3 S	2W3 S	3W3 S
33%	1E	1E1 W	1E2 W	1E3 W	1E 1S	1E1 W1S	1E2 W1S	1E3 W1S	1E 2S	1E1 W2S	1E2 W2S	1E3 W2S	1E 3S	1E1 W3S	1E2 W3S	1E3 W3S
66%	2E	2E1 W	2E2 W	2E3 W	2E 1S	2E1 W1S	2E2 W1S	2E3 W1S	2E 2S	2E1 W2S	2E2 W2S	2E3 W2S	2E 3S	2E1 W3S	2E2 W3S	2E3 W3S
100%	3E	3E1 W	3E2 W	3E3 W	3E 1S	3E1 W1S	3E2 W1S	3E3 W1S	3E 2S	3E1 W2S	3E2 W2S	3E3 W2S	3E 3S	3E1 W3S	3E2 W3S	3E3 W3S

### 4.7.2 Simulation results

**Total cooling loads and incident solar radiation:** apparently, it can be noticed that with increasing trees number, the required loads in summer reduce. From previous studies energy saving for the effect of planting one vase tree on east side was 2.57%, while, planting two vase trees on east side (2E) save energy by about 9.57%. Besides that, two trees can be planted in six locations that mentioned in parameters combinations. As shown in figure (4.63) planting two trees near east side has the highest energy savings for vase, umbrella, and rounded trees. Hence, the value of cooling loads reduction as a result of changing two trees locations can be ordered from highest to lowest as follow: 2E, 1E1W, 1E1S, 2W, 1W1S, and finally 2S. Therefore, the effect of planting two vase trees on these locations saved energy by about 9.57%, 4.55%, 4.26%, 6.68%, 3.71%, and 4.65% respectively. The same trend was noticed for umbrella and rounded trees with lowest values.

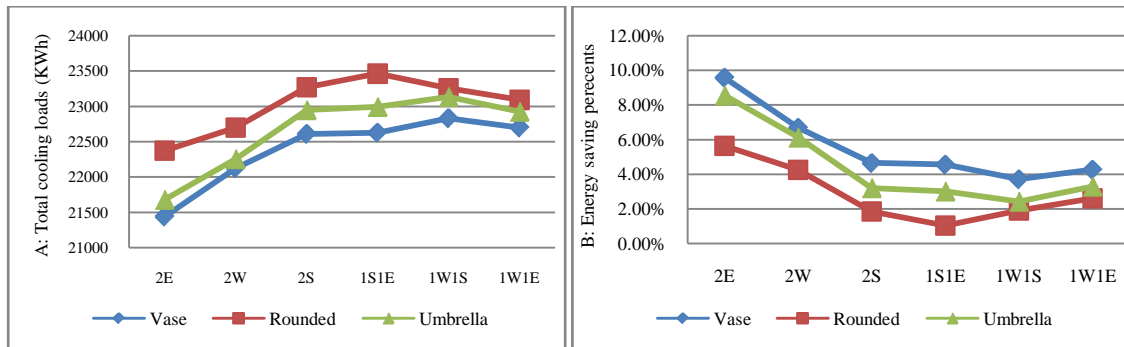


Figure (4.63): The effect of two trees locations possibilities on A: total cooling loads (KWh) and B: Energy savings percents in summer

The same trend of saving energy was observed by ECOTECT with slight difference. Figure (4.64) shows that planting two trees near east side has the highest energy savings for vase, umbrella, and rounded trees. Hence, the value of cooling loads reduction as a result of changing two trees locations can be ordered from highest to lowest as follow: 2E, 1E1W, 1E1S, 2W, 1W1S, and finally 2S. Therefore, the effect of planting two vase trees on these saved energy by about 4.88%, 3.83%, 3.78%, 2.16%, 2.22%, and 1.79% respectively. The same trend was noticed for umbrella and rounded trees with lowest values.

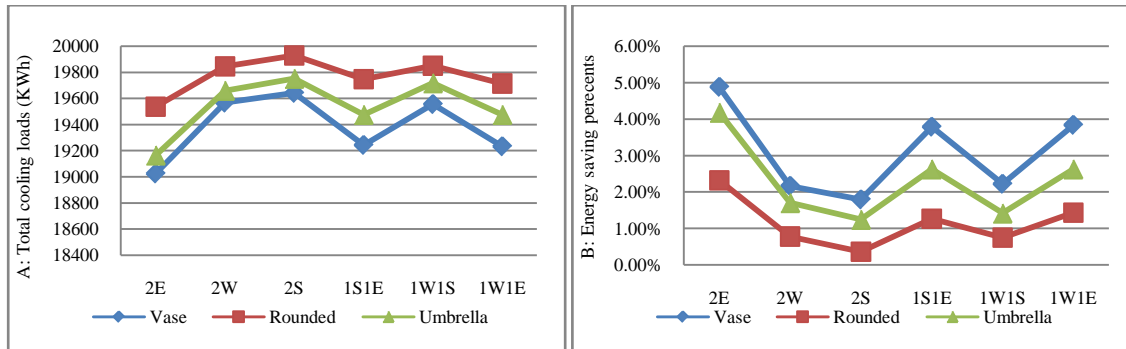


Figure (4.64): The effect of two trees locations possibilities on A: total cooling loads (KWh) and B: Energy savings percents in summer by ECOTECT

The results indicate also that planting two trees near east side has the lowest incident solar radiation amount for vase, umbrella, and rounded trees. Hence, the value of incident solar radiation reduction as a result of changing two trees locations has the same energy saving trend. Therefore, the effect of planting two vase trees on 2E, 1E1W, 1E1S, 2W, 1W1S, and 2S blocked incident solar radiation by about 14.14%, 13.19%, 12.27%, 10.86%, 10.56%, and 9.01% respectively. The same trend was noticed for umbrella and rounded trees with lowest values. Show figure (4.65)

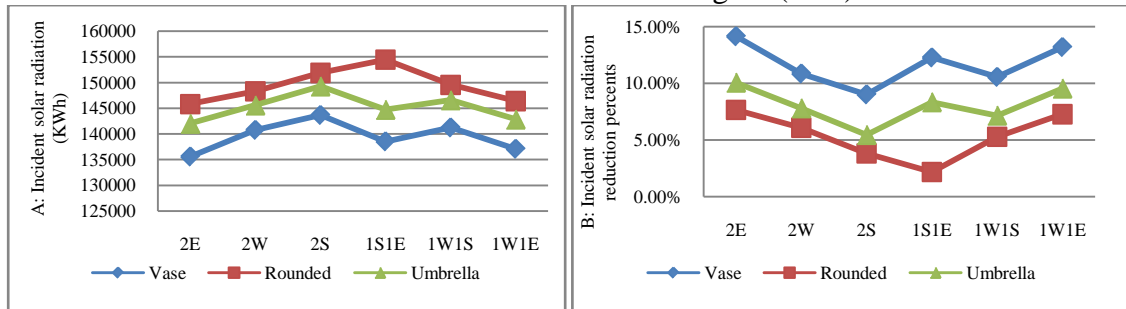


Figure (4.65): The effect of two trees locations possibilities on A: incident solar radiation amount (KWh) and B: incident solar radiation reduction percents in summer

Three trees locations possibilities appear in figure (4.66). Planting two trees near east side and one in the west has the highest energy savings for vase, umbrella, and rounded trees. Hence, the value of cooling loads reduction as a result of changing three trees locations can be ordered from highest to lowest as follow: 2E1W, 2E1S, 3E, 2W1E, 2W1S, 1E1W1S, 3W, 2S1E, 2S1W and finally 3S. Therefore, the effect of planting three vase trees on these locations saved energy by about 11.22%, 11.50%, 10.61%, 8.62%, 8.62%, 8.23%, 7.26%, 7.15, 6.32 and 5.76% respectively. The same trend was noticed for umbrella and rounded trees with lowest values.

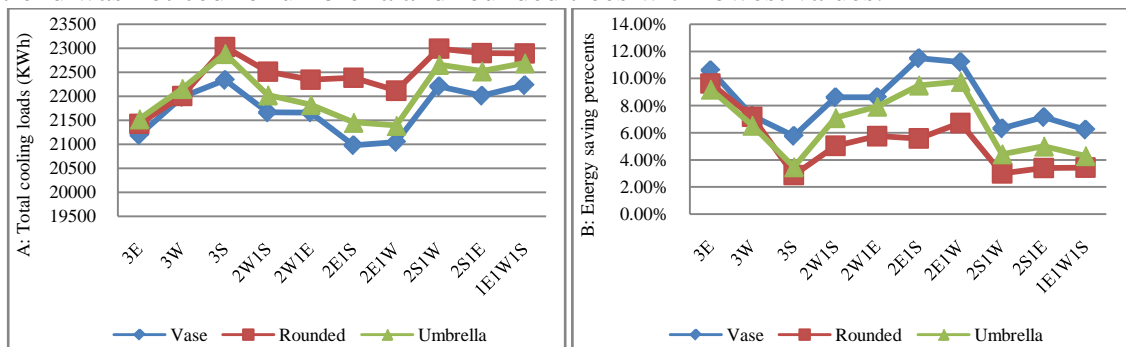


Figure (4.66): The effect of three trees locations possibilities on A: total cooling loads (KWh) and B: Energy savings percents in summer

The results indicated also that planting two trees near east side and one in the west have the lowest incident solar radiation amount for vase, umbrella, and rounded trees. Hence, the value of incident solar radiation reduction as a result of changing two trees locations has the same energy saving trend. Therefore, the effect of planting three vase trees on 2E1W, 2E1S, 3E, 2W1E, 2W1S, 1E1W1S, 3W, 2S1E, 2S1W and 3S blocked incident solar radiation by about 18.96%, 19.88%, 18.13%, 18.86%, 15.76%, 18.01%, 13.91%, 16.47%, 14.75 and 11.57% respectively. The same trend was noticed for umbrella and rounded trees with lowest values. See figure (4.67)

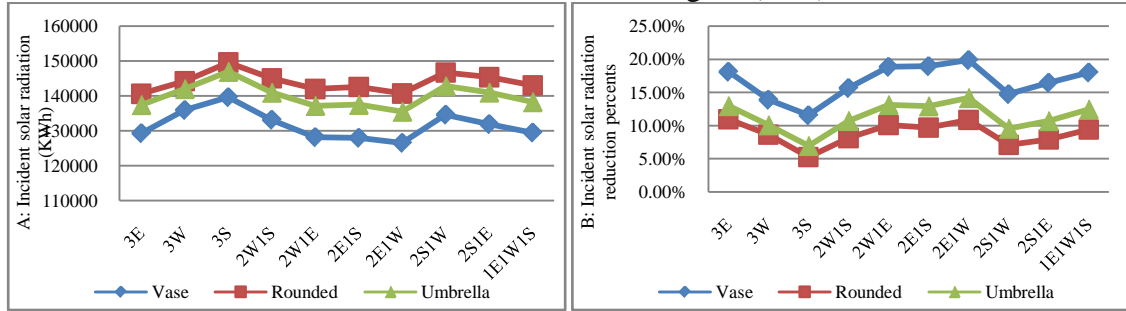


Figure (4.67): The effect of three trees locations possibilities on A: incident solar radiation amount (KWh) and B: incident solar radiation reduction percents in summer

The results of the rest of trees number and location possibilities appear in appendix C. As a result of increasing trees numbers around building, energy savings percents for all previous location possibilities were collected in one table. Each tree has its own values depending on its type. Therefore nine vase, umbrella and rounded trees saved energy by about 22.84%, 18.73% and 19.14%. See following table (4.13).

South	0%				33%				66%				100%			
East/ West	0%	33%	66%	100%	0%	33%	66%	100%	0%	33%	66%	100%	0%	33%	66%	100%
0%	0.00	2.13	6.68	7.26	1.97	3.71	8.62	9.18	4.65	6.32	11.26	11.72	5.76	7.48	12.25	12.81
33%	2.57	4.26	8.62	9.74	4.55	6.23	12.26	11.63	7.15	10.26	13.60	14.16	8.31	9.91	14.68	15.23
66%	9.57	11.22	15.93	16.50	11.50	14.66	17.84	18.39	14.11	15.66	20.30	21.27	15.12	16.73	21.35	21.89
100%	10.61	12.25	17.01	17.54	12.52	14.15	18.83	19.38	15.03	16.65	21.27	22.44	16.10	17.71	22.31	22.84

Generally, it was concluded that increasing planting trees number in east and west side has greater effect than it in south side. Hence, however planting three trees is more affected than two trees, planting two trees in east (2E) has greater effect than three trees on (1E2S or 1W2S) for example. This trend was observed for all number and its locations possibilities comparisons which make choosing trees locations is more important than increasing its number randomly. Therefore, from previous tables the effect of increasing planting vase trees on 3E3W3S, 3E3W2S, 3E3S2W, 2E3W3S, 2E2W3S, 2E3W2S, 3E2W2S, 2E2W2S, 3E3W1S, 3E2W1S, 2E3W1S, 2E2W1S, 3E1W3S, 3E3W, 3E2W, 2E1W3S, 3E1W2S, 2E3W, 3E3S, 2E2W, 2E1W2S, 1E3W3S, 2E3S and 3E2S saved cooling loads energy in summer by about 15%-23%.

**Total heating loads:** it can be noticed that with increasing trees number, the required loads in winter increase. From previous studies energy consumption for the effect of planting one vase tree on south side was 1.48%, while planting two vase trees on south side (2S) consume energy by about 4.86%. Besides, other locations possibilities have slight impact on energy consumption in winter. As shown in figure



(4.68) planting two trees near south side has the highest energy consumption for vase, umbrella, and rounded trees.

Apparently the same results trend was observed by ECOTECT with lowest values. Planting two trees near south side has the highest energy consumption for vase, umbrella, and rounded trees. Hence, planting two vase trees on south side (2S) consumed energy by about 1.14%. The same trend was observed for umbrella and rounded with lowest values.

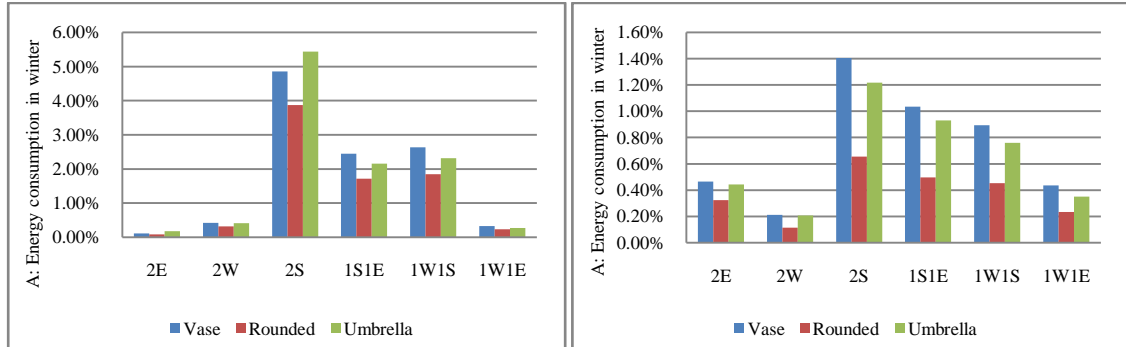


Figure (4.68): The effect of two trees locations possibilities on energy consumption on summer, A: DESIGNBUILDER and B: ECOTECT

As shown in figures (4.69) increasing total heating loads in winter, and energy consumption as a result of increasing trees number is less remarkable than decreasing total cooling loads in summer. Therefore planting nine vase trees around building, increased energy consumption in winter by about 9.47%. This percent is almost equal to energy saving in summer as a result of planting two vase trees on east side. Also, there is a slight increasing of energy consumption as trees number increase gradually. Hence, energy consumption in winter increased by about 8.52%, 8.25%, 8.11%, 7.18%, 6.97%, 6.70%, and 4.86% for planting eight trees on (3E3S2W), seven trees on (3E3S1W), six trees on (3W3S), five trees on (3S2W), four trees on (3S1W), three trees on (3S) and finally two trees on (2S) respectively. See more figures in Appendix C.

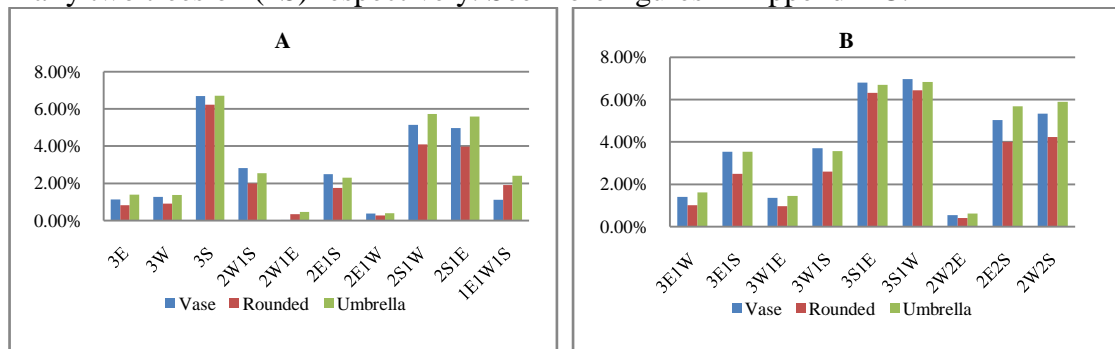


Figure (4.69): The effect of A: three trees locations possibilities and B: four trees locations possibilities on energy consumption in winter

It was observed also that increasing planted trees number in south side is responsible for the highest energy consumption in winter. However, planting three trees has greater effect than two trees, planting two trees in south (2S) has greater effect than planting three trees on (1E1W1S, 1S2E or 1S2W) for example. This trend was observed for all number and its location possibilities comparisons. As shown in table (4.14) the effect of increasing planting vase trees on 3E3W3S, 3E2W3S, 3E1W3S, 1E3W3S, 3E3S, 3E3W2S, 2E2W3S, 1E2W3S, 2W3S, 2E1W3S, 1E1W3S, 1W3S, 2E3S, 1E3S, 3S, 3E2W2S, 3E1W2S, 2E3W2S, 1E3W2S, 3W2S, 3E2S, 2E2W2S, 1E2W2S,



2E1W2S, 2W2S, 1W2S, 1E1W2S and 2E2S increasing heating loads energy in winter by about 5%-10%.

South	0%				33%				66%				100%			
East/West	0%	33%	66%	100%	0%	33%	66%	100%	0%	33%	66%	100%	0%	33%	66%	100%
0%	0.00	-0.65	0.43	1.27	1.48	2.63	2.82	3.71	4.86	5.15	5.33	6.25	6.70	6.97	7.18	8.11
33%	0.84	0.33	0.37	1.36	2.45	1.13	3.61	3.80	4.97	5.13	5.46	6.38	6.80	7.11	7.32	8.25
66%	0.11	0.03	0.55	1.41	2.50	3.57	2.97	3.86	5.04	5.34	5.54	6.47	6.90	7.20	7.41	8.36
100%	1.14	1.40	1.59	2.46	3.54	3.83	4.02	4.93	6.13	6.42	6.63	7.56	8.01	8.31	8.52	9.47

It was concluded that the increasing in energy reduction in summer is higher than the increasing in energy consumption in winter. With taking into consideration that the highest energy saving in summer is obtained when planting trees near east and west façade, while the highest energy consumption in winter is obtained when planting trees near south façade and vice versa. So, annual load was calculated to evaluate the trees energy efficiency all year. Hence, it was found that annual load during the year decreases for all trees number and its locations possibilities. The reduction values appear in table (4.15) that illustrates the correlation between the effect of increasing trees planting number and the original case of building. It is evident that the total load for original case equal 27888.6 KWh, while other values are less than it. Therefore, table (4.16) shows annual energy reduction percent. About 10%-18% of reduction in energy occurs when increasing trees number from four to nine as follow 3E3W3S, 3E3W2S, 3E2W3S, 2E3W3S, 2E3W2S, 2E2W3S, 3E2W2S, 2E2W2S, 3E3W1S, 2E3W1S, 3E2W1S, 2E2W1S, 3E3W, 3E2W, 2E3W, 2E2W, 3E1W2S, 2E1W2S, 3E3S, 2E1W1S, 2E3S, 3E2S, 1E3W3S, 3E1W1S, 2E2S, 1E2W3S, 1E3W2S, 1E2W2S, 3E1W, and 3E1S.

South	0%				33%				66%				100%			
East/West	0%	33%	66%	100%	0%	33%	66%	100%	0%	33%	66%	100%	0%	33%	66%	100%
0%	27888.6	27355.7	26322.4	26221.8	27485.1	27122.2	25966.7	25873.5	27000.5	26616.8	254.53.8	253.88	268.22.2	264.27.6	253.08	252.21.5
33%	27244.5	26891.8	25861.2	25638.3	26913.8	26459.9	25137.6	25295.4	26412.4	25681.6	249.04.9	248.17	262.23.5	258.59.6	247.37.7	246.53.4
66%	25624.1	25229.6	24134.4	24036.7	25269.4	24567	23786.8	23696	24764.7	24411.7	233.20.7	231.34.6	246.14	242.46.1	231.61	230.79.1
100%	25420.6	25042.8	23923.3	23836.4	25073.3	24699.8	23598.4	23510.6	24597.2	24228	231.42.3	229.09.9	244.36.9	240.69.4	229.89.3	229.10.6

South	0%				33%				66%				100%			
East/West	0%	33%	66%	100%	0%	33%	66%	100%	0%	33%	66%	100%	0%	33%	66%	100%
0%	0.00	1.91	5.62	5.98	1.45	2.75	6.89	7.23	3.18	4.56	8.73	8.97	3.82	5.24	9.25	9.56
33%	2.31	3.57	7.27	8.07	3.50	5.12	9.86	9.30	5.29	7.91	10.70	11.01	5.97	7.28	11.30	11.60
66%	8.12	9.53	13.46	13.81	9.39	11.91	14.71	15.03	11.20	12.47	16.38	17.05	11.74	13.06	16.95	17.25
100%	8.85	10.20	14.22	14.53	10.09	11.43	15.38	15.70	11.80	13.13	17.02	17.85	12.38	13.69	17.57	17.85

## 4.8 The Effect of Trees shade on Energy Consumption for Different Building Cases

Building configurations are important to study when trees configurations are fixed. Different building orientations and height represent many types of residential buildings that are designed according to site conditions and owner's interest. Hence, the effect of planting trees on different orientations varies totally depending on sun altitude angel and incident solar radiation. On other hand, the effect of planting trees near buildings with different heights varies depending on the floors number and its height above ground level.

### 4.8.1 Parametric Investigation

**First scenario assumption:** The current study assumes that a tree is planted in front of façade center. Tree locations change according to changing building orientation. As shown in figure (4.70) building orientations change from north to east in  $15^\circ$  steps. And because of original building case has square plan, changing its orientation consist of four orientations namely  $0^\circ\text{N}$ ,  $15^\circ\text{N}$ ,  $30^\circ\text{N}$ ,  $45^\circ\text{N}$ .

**Second scenario assumption:** this assumption evaluates the effect of a tree on total cooling and heating loads for different building heights as one zone. Building heights increases floor by floor as follow: 6m, 9m, 12m, 15m, and 18m. On other hand, the effect of trees will be evaluated for each storey alone. See figure (4.71)

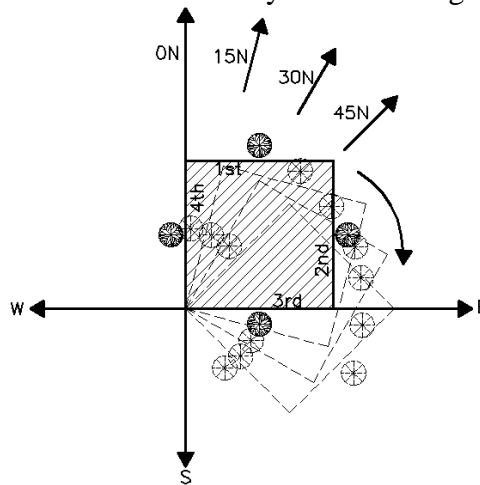


Figure (4.70): Building orientations parameters

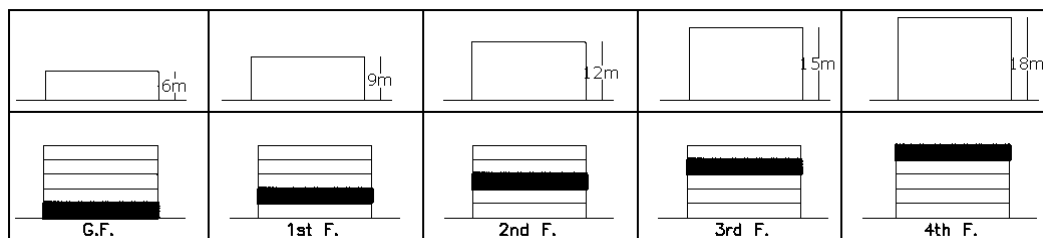


Figure (4.71): Building heights parameters

### 4.8.2 Simulation results

#### 1. First building case: Different orientations

**Total cooling loads and incident solar radiation:** before studying the effect of tree for different building orientations, simulations were conducted for each building

orientations without trees. As shown in figure (4.72) the results indicated that as building change orientation from (0N) to (45N), cooling loads (KWh) and incident solar radiation (KWh) increase gradually.

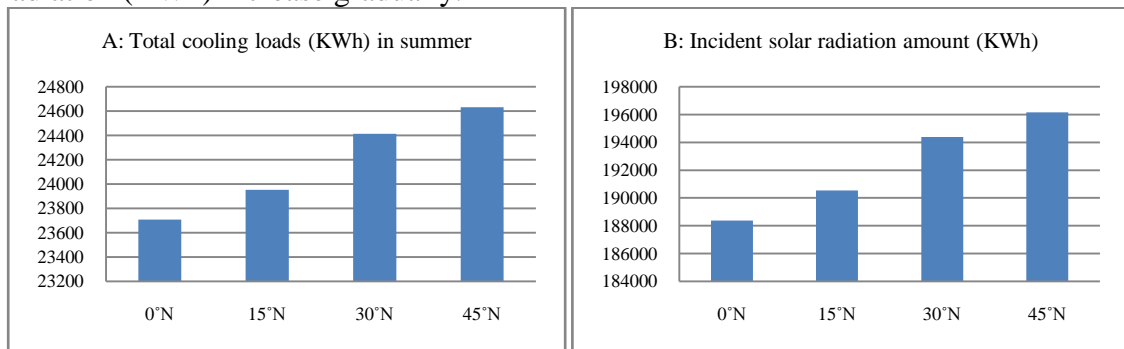


Figure (4.72) the effect of changing building orientations on A: total cooling loads (KWh) and B: incident solar radiation (KWh)

Hence, the effect of planting tree near building façade on energy saving and incident solar radiation reduction increases in summer. Figure (4.73) indicate the percentages of the reduction in cooling loads and solar radiation for each orientation. When building is located on East-West axis, planting trees near north side (1<sup>st</sup> façade) has almost slight effect on energy saving and incident solar radiation reduction that increase by about 0.59% and 1.45% respectively. This behavior of trees was explained in previous studies that concentrated on sun path all day in summer. Therefore the effect of planting trees on east (2<sup>nd</sup> façade) and west side (4<sup>th</sup> façade) has the highest energy saving and reduction percents followed by south façade (3<sup>rd</sup> façade). Changing the building orientations from (0N) to (45N) increases the effect of planting tree near 1<sup>st</sup> façade (north), 2<sup>nd</sup> façade (east), and 3<sup>rd</sup> façade (south) gradually, while decrease the effect of planting tree near 4<sup>th</sup> façade (west).

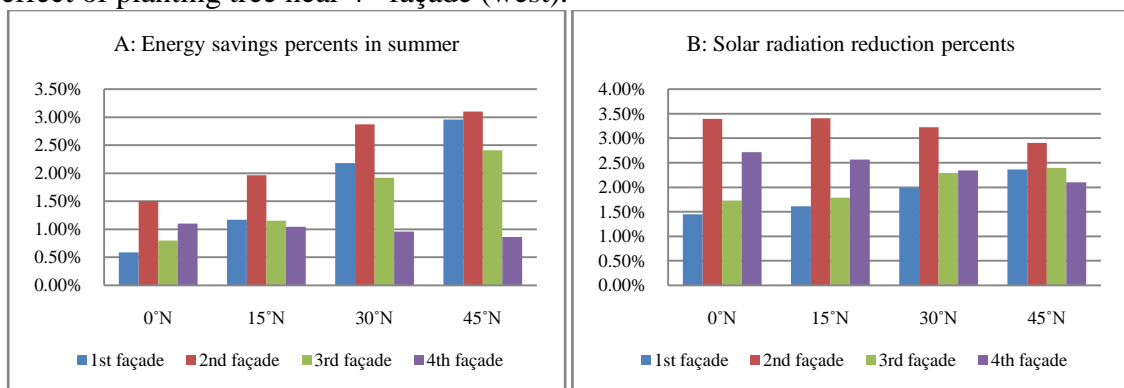


Figure (4.73): Tree effect on, A: energy saving and B: incident solar radiation reduction percents for different building orientations in summer

Basically when building is oriented from (0N) to (45N), energy saving in summer as a result of the effect of planting trees on 1<sup>st</sup> façade (North) increased by about 0.59%, 1.17%, 2.18%, and 2.96% respectively. Also, energy saving in summer as a result of the effect of planting trees on 2<sup>nd</sup> façade (East) increased by about 1.50%, 1.97%, 2.87%, and 3.10% respectively. Energy saving in summer as a result of the effect of planting trees on 3<sup>rd</sup> façade (south) increased by about 0.80%, 1.15%, 1.92%, and 2.41% respectively. While, energy saving in summer as a result of the effect of planting trees on 4<sup>th</sup> façade (west) decreased by about 1.10%, 1.05%, 0.96%, and 0.86% respectively. The same trend of incident solar radiation is observed for all façades.

These results can be explained as during sun movement all day, just three sides receive solar radiation in the case of (0N) orientation. Because of rising sun from east, passing on south side in midday and setting to west without passing on north side. Also, sun altitude angel plays significant role in these results especially when east facade gets southeastern and south facade get southwestern. Taking into consideration that solar radiation in midday reaches to the highest in south.

The same trend was observed in ECOTEECT results with lowest values. When building is oriented from (0N) to (45N), energy saving in summer as a result of the effect of planting trees on 1st façade (North) increased by about 0.00%, 0.14%, 0.33%, and 0.59% respectively. Moreover, energy saving in summer as a result of the effect of planting trees on 2nd façade (East) increases by about 1.04%, 1.05%, 1.06%, and 1.08% respectively. Also, energy saving in summer as a result of the effect of planting trees on 3rd façade (south) increased by about 0.15%, 0.19%, 0.31%, and 0.40% respectively. While, energy saving in summer as a result of the effect of planting trees on 4th façade (west) decreased by about 0.38%, 0.37%, 0.34%, and 0.22% respectively. See figure (4.74)

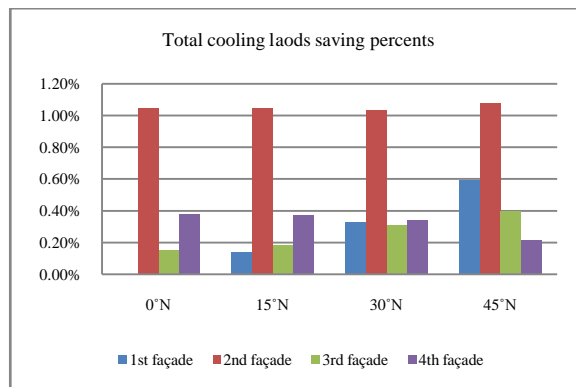


Figure (4.74): Tree effect on energy saving for different building orientations in summer by ECOTEECT

**Total heating loads:** it is evident from figure (4.75) that as building orientation changes from (0N) to (45N), total heating loads (KWh) increase gradually.

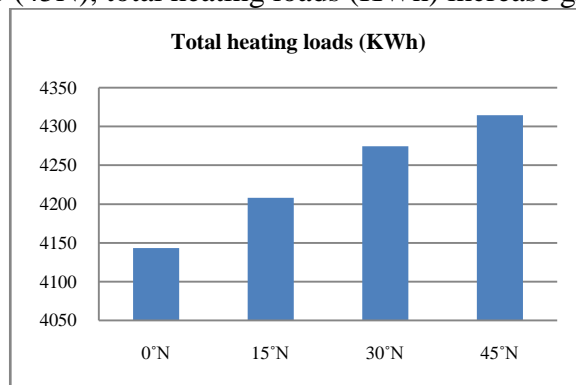


Figure (4.75) the effect of changing building orientations on total heating loads (KWh)

The simulation results by DESIGNBUILDER indicated that when building is oriented from (0N) to (45N), energy consumption in winter as a result of the effect of planting trees near 1st façade (North) was not remarkable. While, energy consumption in winter as a result of the effect of planting trees on 2<sup>nd</sup> façade (East) increased by about 0.10%, 0.14%, 0.24%, and 0.39% respectively. On the other hand, energy consumption in winter as a result of the effect of planting trees on 3<sup>rd</sup> façade (south)

decreased by about 1.93%, 1.37%, 0.82%, and 0.53% respectively. Also, energy consumption in winter as a result of the effect of planting trees on 4<sup>th</sup> façade (west) decreased by about 0.46%, 0.07%, 0.00%, and 0.00% respectively. The same trend was observed in ECOTECT results with lowest values. See figure (4.76)

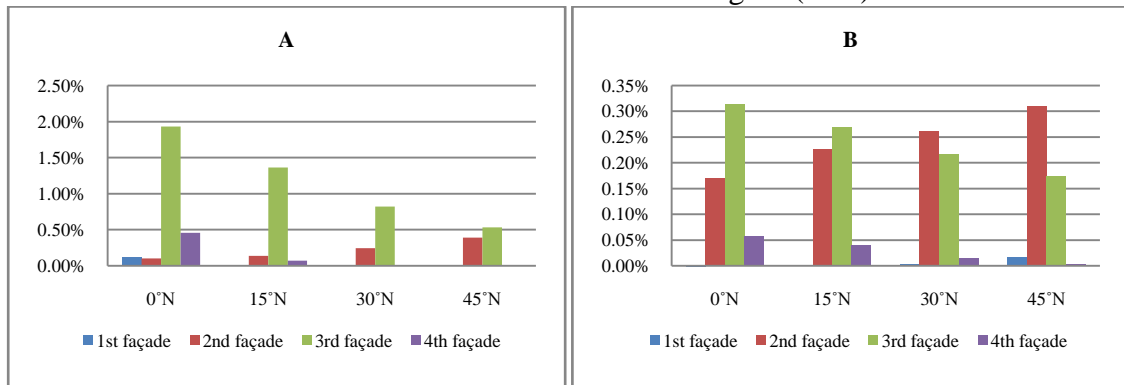


Figure (4.76): Tree effect on energy saving for different building orientations in summer by A: DESIGNBUILDER and B: ECOTECT

## 2. Second case scenario: Increasing building heights

**Total cooling loads and incident solar radiation:** before studying the effect of tree for different building heights, simulations were conducted for 6m, 9m, 12m, and 15m building heights without trees. In this case, building was simulated as one zone for each height. As shown in figure (4.77) the results indicated that as building height increased, cooling loads (KWh) and incident solar radiation (KWh) increases gradually. Take into consideration the increasing of internal space volume and façades area that exposed to solar radiation, thus increasing the consumption of energy in summer and winter.

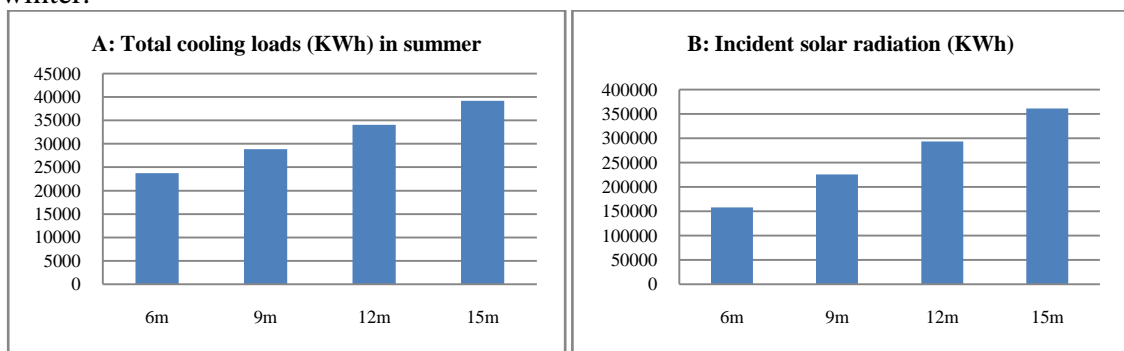


Figure (4.77): The effect of increasing building height on A: total cooling loads (KWh) and B: incident solar radiation (KWh)

Hence, the effect of planting tree near building façades on cooling loads and incident solar radiation decreased gradually in summer as building height increased. Figure (4.78) indicates the percentages of the reduction in cooling loads and solar radiation for each height. The effect of planting trees near east side on energy saving decreased by about 1.50%, 1.30%, 1.17% and 1.07% for increasing building heights as follow 6m, 9m, 12m, and 15m respectively. This trend in the reduction of cooling loads followed the same trend of reduction in incident solar radiation that decreases by about 4.05%, 2.82%, 2.16%, and 1.75% for increasing building heights respectively. The same trend was observed for the rest of building façades with lowest values.

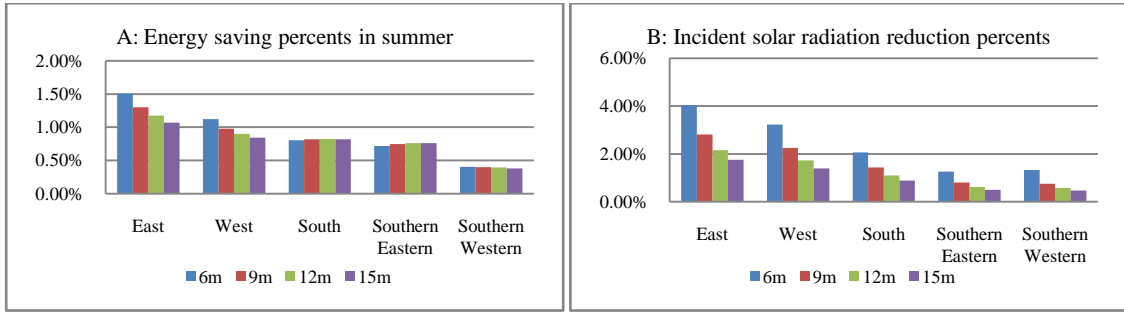


Figure (4.78): The tree effect on, A: energy saving and B: incident solar radiation reduction percents for different building heights in summer

By ECOTECT, The effect of planting trees near east side on energy saving decreased by about 1.04%, 0.79%, 0.71% and 0.70% for increasing building heights as follow 6m, 9m, 12m, and 15m respectively. The same trend was observed for the rest of building facades with lowest values. See figure (4.79)

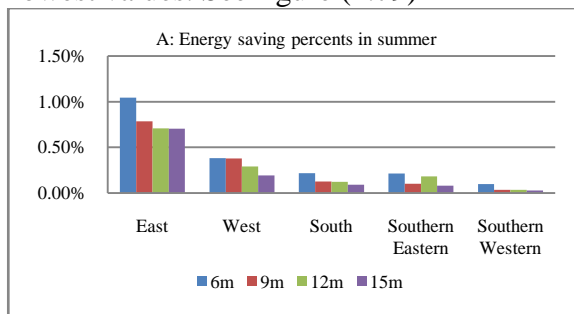


Figure (4.79): The tree effect on energy saving for different building heights in summer by ECOTECT

Mainly, studying the effect of tree for different building heights gives an indicator about energy consumption for building as one zone. In order to understand the effect of trees on energy consumption for each building floor, the simulations were conducted for five-storey building including ground floor, 1<sup>st</sup> floor, 2<sup>nd</sup> floor, 3<sup>rd</sup> floor, and 4<sup>th</sup> floor. Figure (4.80) shows that the effect of tree on decreasing energy loads for first stories are the highest. Consequently as building stories increase, the effect of tree is more remarkable on the first stories. Energy saving percents in summer as a result of planting tree on east side decreased gradually by about 2.05%, 0.57%, 0.13%, 0.03%, and 0% for G.F, 1<sup>st</sup> F., 2<sup>nd</sup> F., 3<sup>rd</sup> F, and 4<sup>th</sup> F. respectively. On the other hand, the amount of incident solar radiation on façades is the same for each floor. But the effect of tree shade on reducing incident solar radiation decreases as building floor highs above ground level because of the inability of tree shade to reach to the upper floors. Thus, incident solar radiation reduction percents in summer decreased gradually by about 6.51% and 0.68% for G.F and 1<sup>st</sup> F. respectively.

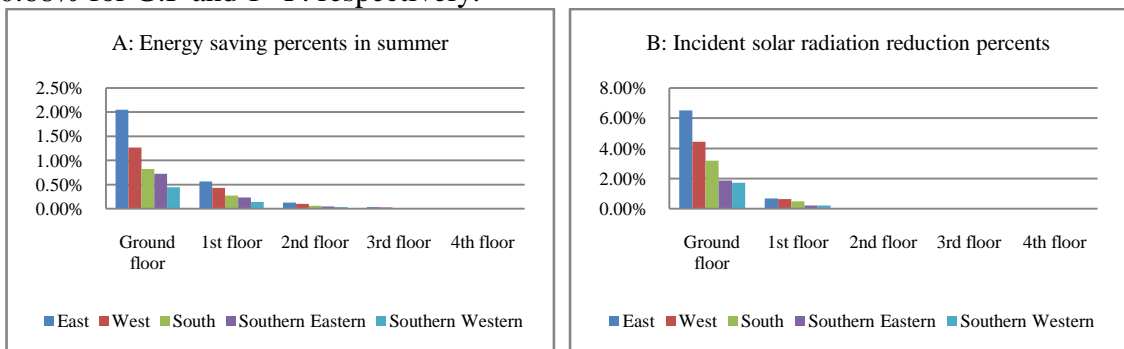


Figure (4.80): The tree effect on energy saving for five-storey building in summer

**Total heating loads:** As shown in figure (4.81) the results indicated that as building height increases, heating loads (KWh) increase gradually. Take into consideration the increasing of internal space volume and façades area that exposed to solar radiation, thus increasing the consumption of energy in summer and winter.

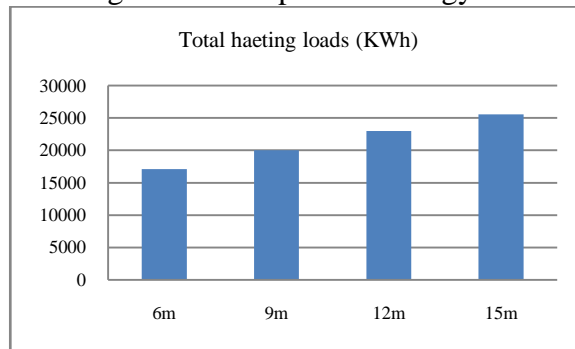


Figure (4.81): The effect of increasing building height on total heating loads

The effect of planting tree near building façades on increasing energy consumption in winter decreases gradually as building height increases. Figure (4.82) indicates the percentages of the reduction in heating loads for each height. Energy consumption in winter decreased as a result of the effect of planting trees near south side by about 1.66%, 1.33%, 1.15% and 1.04% for increasing building height as follow 6m, 9m, 12m, and 15m respectively. This trend in the reduction of heating loads was observed by ECOTECT results.

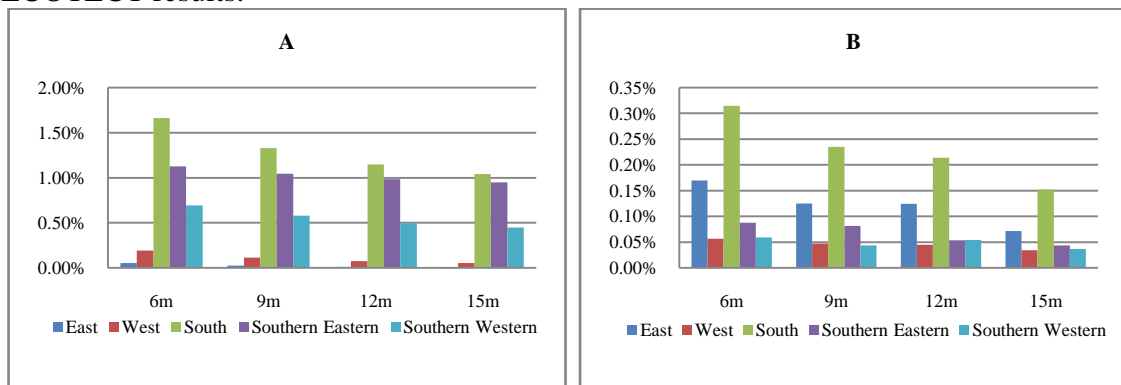


Figure (4.82): The tree effect on energy consumption in winter for different building heights, A: DESIGNBUILDER and B: ECOTECT

On the other side, energy consumption as a result of planting tree on south side decreased gradually by about 3.16%, 1.71%, 0.69%, 0.24%, and 0.06% for G.F, 1<sup>st</sup> F., 2<sup>nd</sup> F., 3<sup>rd</sup> F, and 4<sup>th</sup> F. respectively. Show figure (4.83)

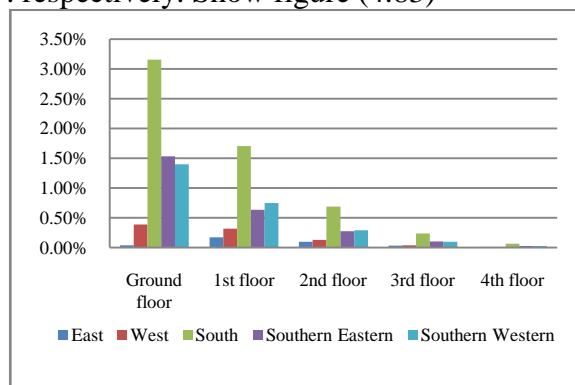


Figure (4.83): The tree effect on energy consumption for five building stories in winter

## 4.6 Conclusion

This chapter indicated that choosing the optimum trees configuration depends on many factors including site orientation, building shape, tree shape and foliage, and the number and location of trees. The effect of different trees configurations on total cooling loads in summer and total heating loads in winter were the main indicators of internal thermal comfort. Incident solar radiation, fabric gain, and solar gain are the main analysis factors for energy consumption behavior inside building. It was concluded that shading the east and west side of building achieves the maximum energy savings in summer and winter. Also, South direction is less important to shade because of the low impact of tree shade on building in summer and the need for solar radiation in winter from this side. On the other side, the closer the tree to home is the more shade it provides. It is preferable to keep tree 2-3m away from building to effectively shade windows and walls and in the same time avoid the conflicts of the roots with building foundation. It was observed that choosing the optimum trees number and location can reduce energy consumption in summer by about 10% - 20%. Total cooling and heating loads change as building configurations change. Thus, tree effect on each configuration differs considerably. Changing building orientation to (45N) is the most affected by tree shade, while the first floors of building have greater benefits than upper floors.



## **Chapter 5: Microclimatic Effects of Street Trees**

### **5.1 Introduction**

Planting trees near buildings is one of the important factors that play significant role in moderating microclimate, thus achieving human comfort. It can reduce air temperature by shading and evaporative cooling as well. Particularly the previous chapter concentrated on studying different trees configurations effects on the thermal performance of individual building. For individual buildings, solar angles and incident solar radiation are often important. Because the summer sun is low in the east and west for several hours each day, shade to protect east and especially west walls helps keeping buildings cool. The relative importance of these effects depends on the area, surface gain, and configuration of trees.

Actually, buildings are clustered with each others with specific configurations. Clustered buildings configurations patterns in the city are determined by stakeholders. They organize buildings in term of street width, spacing, plot areas and forms, and street orientations. Hence, tree configurations in urban patterns have great relations with the urban canopy that affects thermal behavior and comfort for the outdoor and indoor environment. Trees forms, locations, crown size, and vertical distribution of leaf area or height influence the transfer of cool air and pollutants along streets. Rare of the papers deal exclusively with street trees, but all mention street trees as an important and effective urban heat island mitigation strategy. The majority of scientific papers dealt with issues of temperature and humidity measurement such as Baris et al. (2009); Champiat (2009); and Rosenzweig et al. (2009), (Sarajevs, 2011). DESIGNBUILDER was used in this chapter, while results were not validated by ECOTECT because it takes long time for multi-zones model. This chapter was divided into two sections to provide full understanding of the effect of different street trees configurations.

The first section introduced a study of the trees configurations in terms of one street case. Therefore, it dealt with four trees configurations which are location on the street, forms, crown size, crown height, and trees rows number. Location of trees includes its positions on centralized island, or one of two side pavements. The second section studied the street and building configurations in terms of one tree case. Basically, it examined different street orientations and width. The study took into consideration four measurable parameters that describe thermal comfort for entire environment including cooling and heating loads, solar gain for both summer and winter and CO<sub>2</sub> emissions (Kg) from air conditioner. On other hand, planting trees in urban fabric take into consideration other factors such as visibility in the streets, infrastructure lines, soil type and PH degree, and buildings foundations. All these elements were supposed to integrate together in order to get the optimum trees configurations for each street configurations.

### **5.2 The Effect of Street Trees Crown Geometry on Energy Consumption**

Trees crown is the main factor that affects the outdoor microclimate, thus indoor comfort, (Meerow and black, 1993). This study focused on the effect of street trees crown geometry on the indoor thermal performance of buildings. Therefore, two main parameters were taken into consideration of this study. The First one is street parameters

including buildings form and height, side spacing, front spacing, street width, street orientation, and pavements width. Street case parameters are fixed in all trees configurations variables. The second parameter is trees crown geometry and their locations. As shown in figure (5.1) one tree was planted on the opposite of each building to form row of trees that located in the island or in one of the pavements.

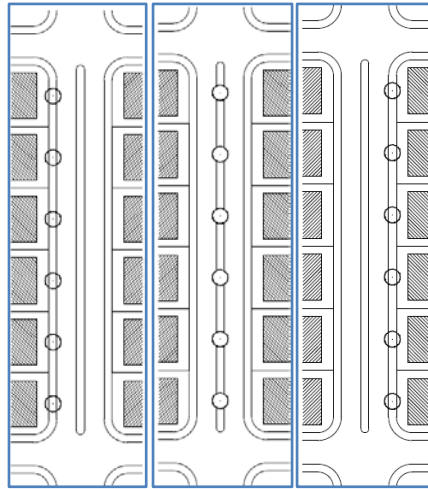
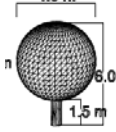
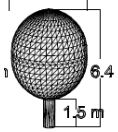
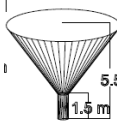
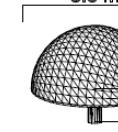
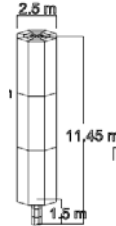
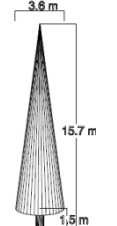
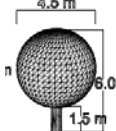
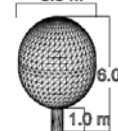
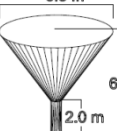
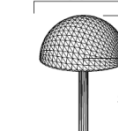
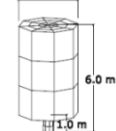



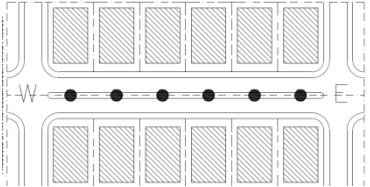
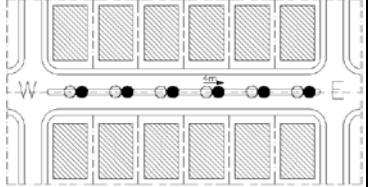
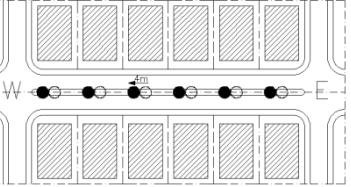
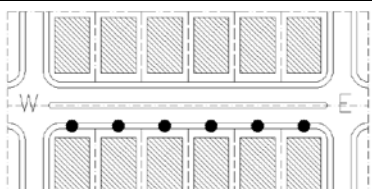
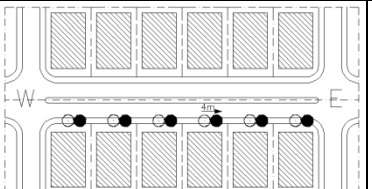
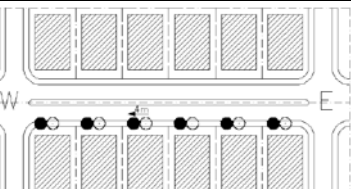
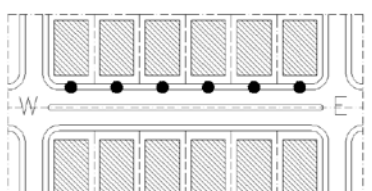
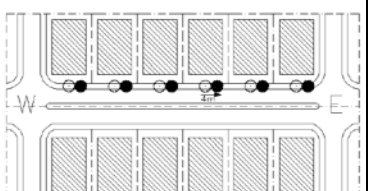
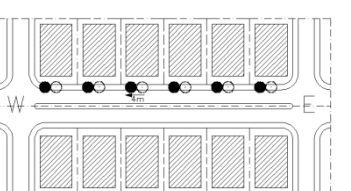
Figure (5.1): The Location of trees row on the street

### 5.2.1 Parametric Investigation

This study investigates the effects of different trees crown geometries and its locations on cooling, heating loads, solar gain and CO<sup>2</sup> emissions from air conditioner. Table (5.1), table (5.2), and table (5.3) show parameters combinations for street, trees geometries, and trees locations in street.

Table (5.1): Street parameters case in the study								
Buildings Number	Buildings Height (H)	Buildings Area (A)	Buildings Form	Street width (W)	Side spacing (S)	Front spacing (F)	Island width (I.W)	Pavements width (P.W)
12	7 m (two stories)	225 m <sup>2</sup>	rectangular	16 m	4 m	3 m	2 m	2 m

<b>Table (5.2): Trees crown geometries parameters</b>					
First scenario: different tree geometries positioned on 3 m between the center of tree trunk and building facades, 1.5 m tree trunk, 47.7 m <sup>3</sup> volume, and different total height					
Rounded	Oval	Vase	Umbrella	Columnar	Conical
					
Second scenario: different tree geometries positioned on 3 m between the center of tree trunk and building facades, different trunk height, 47.7 m <sup>3</sup> volume, and 6m total height					
Rounded	Oval	Vase	Umbrella	Columnar	Conical
					

<b>Table (5.3): Trees locations parameters</b>		
In the Island in front of the center of building (I-C)	In the Island shifted to the front of east edge of building (I-E)	In the Island shifted to the front of the west edge of building (I-E)
		
In the North Pavement in front of the center of building (NP-C)	In the North Pavement shifted to the front of east edge of building (NP-E)	In the North Pavement shifted to the front of west edge of building (NP-E)
		
In the South Pavement in front of the center of building (SP-C)	In the South Pavement shifted to the front of east edge of building (SP-E)	In the South Pavement shifted to the front of east edge of building (SP-E)
		

### 5.2.2 Simulation Results

Basically, simulation results gave an indicator about reducing outside temperature and inside bulb-temperature by reducing solar gain, thus energy consumption and air conditioner CO<sup>2</sup> emissions (Kg). In this study, simulations were performed using

DESIGNBUILDER for about one hundreds models that expressed two scenario of street trees crown geometry.

**a. First Scenario: Fixed Trunk Height and Foliage Volume with Different Total Height**

**Cooling loads and solar gain in summer:** the results indicated that the energy savings in summer for the simulated shapes increased by about 0.79%, 0.59%, 0.48%, 0.26%, 0.27%, and 0.17% for vase, columnar, conical, rounded, oval, and umbrella respectively. As shown in figure (5.2) total cooling loads amount (KWh) for vase shape is the lowest, thus the highest energy saving percents. Trees locations on south pavement have higher energy savings percents in summer than centralized island and north pavement. Changing trees locations from centralized island to north pavement and south pavement increased the reduction percents value of cooling loads consumption by about 0.23%, 0.36%, and 0.72% respectively for vase tree. The same trend can be noticed for the rest of shapes with less energy saving percents. Also, changing trees locations in the same pavement either in center of building (C), to the east (E) or to the west (W) has slight impact in affecting the percentages of decreasing cooling loads. In centralized island and south pavements, location of trees on the opposite of east edge of building (I-E, SP-E) has the maximum energy savings that increased by about 0.23% and 0.79% respectively. While the maximum energy saving for north pavement is on the opposite of west edge of building that increased by 0.37%.

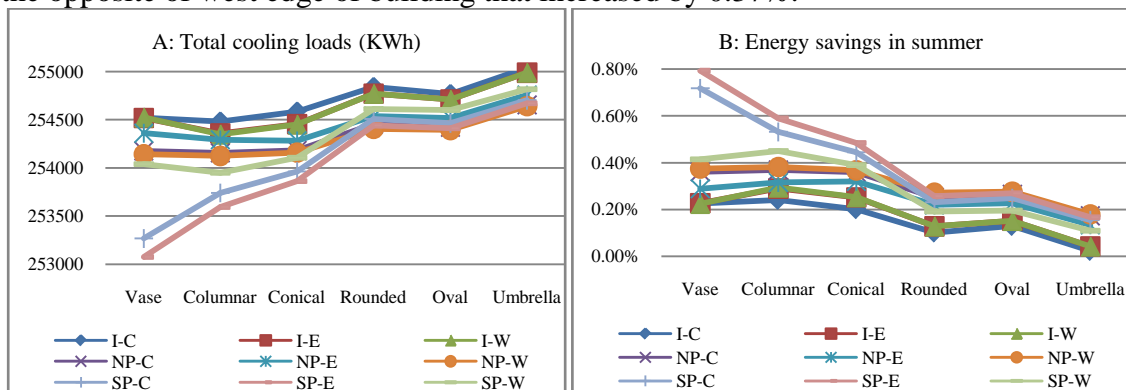


Figure (5.2): A: Total cooling loads amount (KWh), B: Energy saving percents for different street trees shape (first scenario)

It was explained before in the previous chapter that the south façades of building are more important to shade than north façades. Also, as tree is getting closer to building the energy saving percent is getting higher. These conclusions explained the priority of southern façade to shade in this street case that oriented to east-west axis. Actually, increasing energy saving percents in summer is affected by decreasing the potential of incident solar radiation on buildings' façades, thus solar gain by walls. It is observed in the following figure (5.3) that solar gain amount increased for vase, columnar, conical, rounded, oval and umbrella, thus solar gain reduction percents increased by about 2.81%, 1.95%, 1.69%, 1.21%, 1.24%, and 0.89% respectively. In the case of East-West Street, location of trees on south pavements reduces incident solar radiation and solar gain more than trees on north pavements. Also, shading amount from close trees is more than shading amount from far trees. Thus solar gain reduction percents for close trees are higher than it for far trees. Consequently, changing trees locations from centralized island to north pavement and south pavement increased the reduction percents value of solar gain by about 0.92%, 1.49%, and 2.40% respectively

for vase tree. However the slight effect of changing trees locations from center of building to the east edge or to west edge, the east edge of building has the highest reduction percents. Taking into consideration losing heat through night and gaining it through day that make building elements easy to respond to trees shade in early morning and vice versa in afternoon.

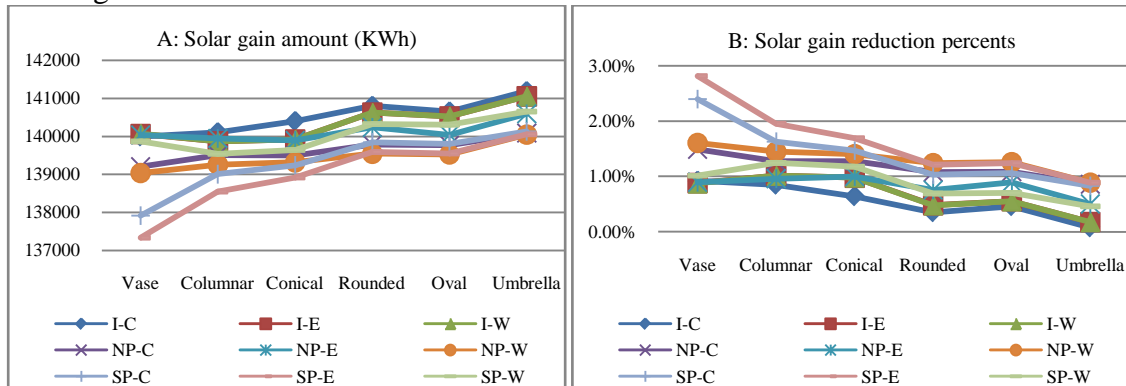


Figure (5.3): A: Solar gain amount (KWh), B: Solar gain reduction percents for different street trees shape (first scenario)

**Heating loads and solar gain in winter:** energy consumption percents increased by about 1.59%, 1.16%, 1.17%, 1.11%, 1.11%, and 0.50% for planting vase, columnnar, conical, rounded, oval, and umbrella respectively in south pavement. As shown in figure (5.4) energy consumption for planting vase tree is the highest. Trees locations on south pavement have higher heating increasing percents in winter than centralized island and north pavement. Location of trees on north pavement has almost no effect on heating loads. Changing trees locations from centralized island to north pavement and south pavement increased energy consumption percents by about 0.05%, 0.0%, and 1.41% respectively for planting vase tree. The same trend can be noticed for the rest of shapes with less heating increasing percents. Also, changing trees locations in the same pavement either in center of building (C), to the east (E) or to the west (W) has slight impact. In centralized island and south pavements, location of trees on the opposite of east edge of building (I-E, SP-E) has the maximum heating loads that increased by about 0.06% and 1.59% respectively.

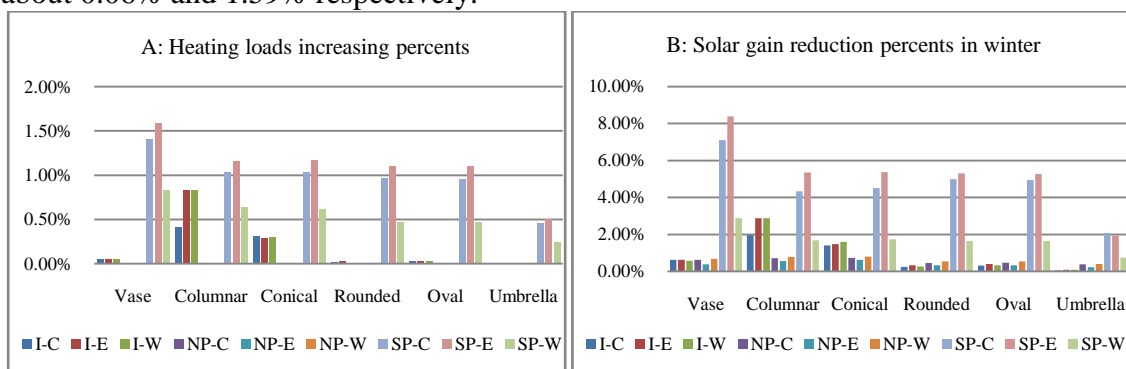


Figure (5.4): A: Total heating loads increasing percents, B: Solar gain reduction percents as effect of different street trees shape (first scenario)

It is observed that increasing energy consumption percents in winter is affected by decreasing the potential of incident solar radiation on buildings' facades, thus solar gain by walls. It is noticed in the previous figure (5.4) that solar gain reduction percents increased for vase, columnnar, conical, rounded, oval and umbrella by about 8.39%, 5.36%, 5.37%, 5.30%, 5.27%, and 1.94% respectively. In the case of East-West Street, location of trees on south pavements reduces incident solar radiation and solar gain

more than trees on north pavements. On the other hand, shading amount for close trees is more than far trees, thus solar gain reduction percents for close trees are higher than it for far trees. Consequently, changing trees locations from centralized island to north pavement and south pavement increased the reduction percents value of solar gain by about 0.62%, 0.60%, and 7.10% respectively for planting vase tree. Also, location of trees on the east edge of building has the highest reduction percents.

**CO2 emissions amount:** CO2 emissions from air conditioner depend mainly on cooling and heating loads consumption. As tree shade effect decrease cooling loads, CO2 emissions decrease too in summer and vice versa in winter. It is noticed from figure (5.5) that CO2 emissions percents decreased in summer by about 0.45%, 0.33%, 0.27%, 0.14%, 0.14%, and 0.09% for planting vase, columnar, conical, rounded, oval, and umbrella respectively in south pavement. While CO2 emissions increasing percents decreased in winter by about 0.59%, 0.43%, 0.43%, 0.41%, 0.41% and 0.19% for planting vase, columnar, conical, rounded, oval, and umbrella respectively in south pavement. The increasing percents in winter are higher than decreasing CO2 emissions percents in summer. This can be referred to the effect of tree on south façade in winter that is higher than it in summer with considering the high of altitude angel of south façade in summer and low of it in winter.

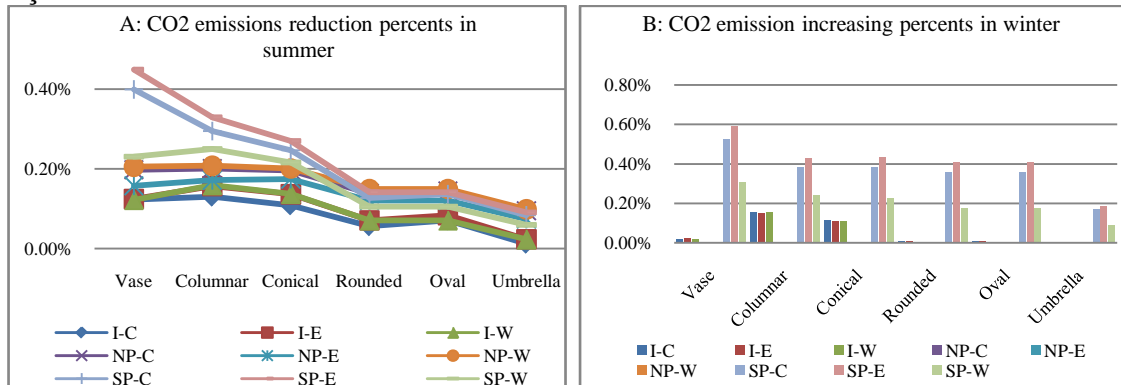


Figure (5.5): A: CO2 emissions reduction in summer, B: CO2 emissions increasing in winter, for different street trees shape (first scenario)

**b. Second Scenario: Fixed Total Height and Foliage Volume with Different Trunk Height**

**Cooling loads and solar gain in summer:** the results indicate that the energy savings in summer for the simulated shapes increase by about 0.75%, 0.40%, 0.33%, 0.27%, 0.27%, and 0.16% for planting vase, umbrella, columnar, oval, rounded, and conical respectively. As shown in figure (5.6) total cooling loads amount (KWh) for vase shape effect is the lowest, thus the highest energy saving percent is. Planting trees on south pavement provides higher energy savings percents in summer than centralized island and north pavement. Changing trees locations from centralized island to north pavement and south pavement increases energy saving percents by about 0.23%, 0.37%, and 0.43% respectively for planting vase tree. The same trend can be noticed for the rest of shapes with less energy saving percents. Also, changing trees location in the same pavement either in center of building (C), to the east (E) or to the west (W) provides slight impact on the decreasing cooling loads. In centralized island and south pavements, location of trees on the opposite of east edge of building (I-E, SP-E) has the maximum energy savings that increased by about 0.24% and 0.75% respectively. While



the maximum energy saving for north pavements trees is on the opposite of west edge of building that increased by 0.38%.

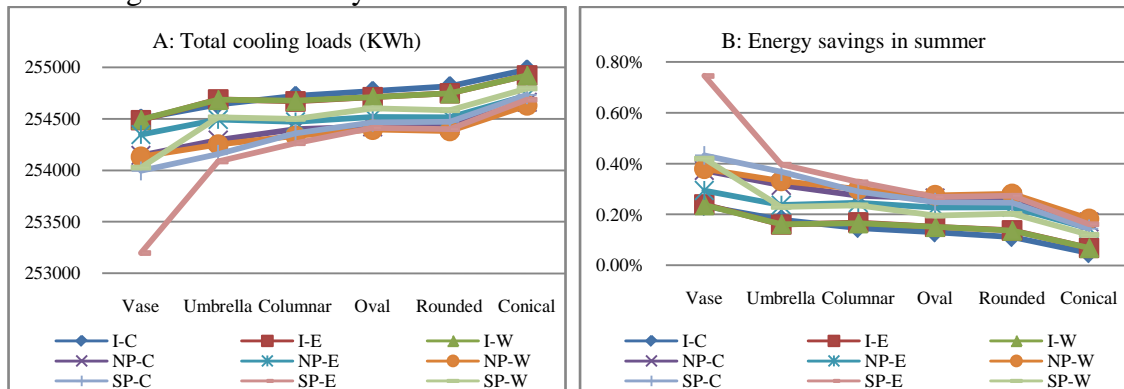


Figure (5.6): A: Total cooling loads amount (KWh), B: Energy saving percents for different street trees shape (second scenario)

As in the previous case, increasing energy saving percents in summer is affected by decreasing the potential of incident solar radiation on buildings' facades, thus solar gain by walls. It is observed in the following figure (5.7) that solar gain amount increased for vase, umbrella, columnar, oval, rounded, and conical, thus solar gain reduction percents decreased by about 2.45%, 1.72%, 1.41%, 1.24%, 1.26%, and 0.79% respectively. Also, changing trees locations from centralized island to north pavement and south pavement increases solar gain reduction percents by about 0.93%, 1.51%, and 1.59% respectively for planting vase tree.

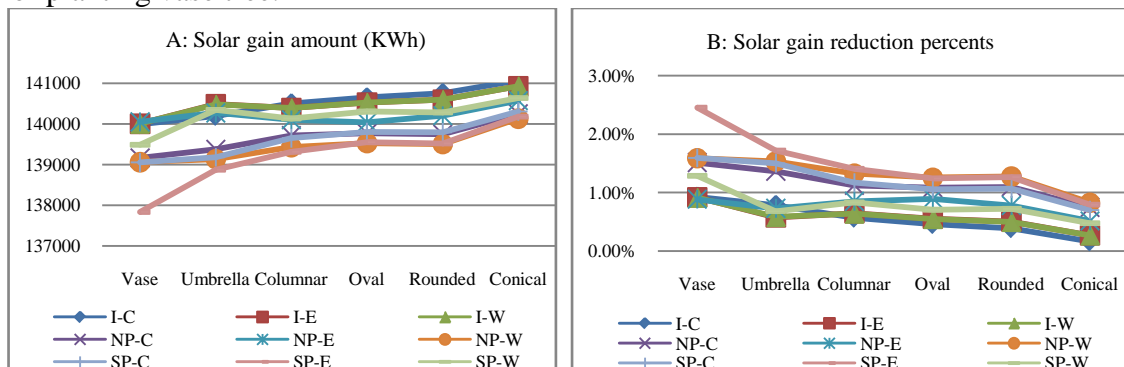


Figure (5.7): A: Solar gain amount (KWh), B: Solar gain reduction percents for different street trees shape (second scenario)

**Heating loads and solar gain in winter:** the results indicate that the energy consumption increased in winter for the simulated shapes. Energy consumption increased by about 1.41%, 1.45%, 1.09%, 1.11%, 1.15%, and 0.52% for vase, umbrella, columnar, oval, rounded, and conical respectively in south pavement. As shown in figure (5.8) energy consumption for planting vase shape is the highest. Planting trees on south pavement provides higher energy consumption in winter than centralized island and north pavement. While, planting trees on north pavement has almost no effect of heating loads. Changing trees locations from centralized island to north pavement and to south pavement increased energy consumption by about 0.05%, 0.0%, and 0.83% respectively for vase tree. The same trend can be noticed for the rest of shapes with less percents. Also, changing trees locations in the same pavement either in center of building (C), to the east (E) or to the west (W) provides slight impact on increasing heating loads. In centralized island and south pavements, location of trees on the opposite of east edge of building (I-E, SP-E) has the maximum heating loads that increased by about 0.06% and 1.41% respectively.

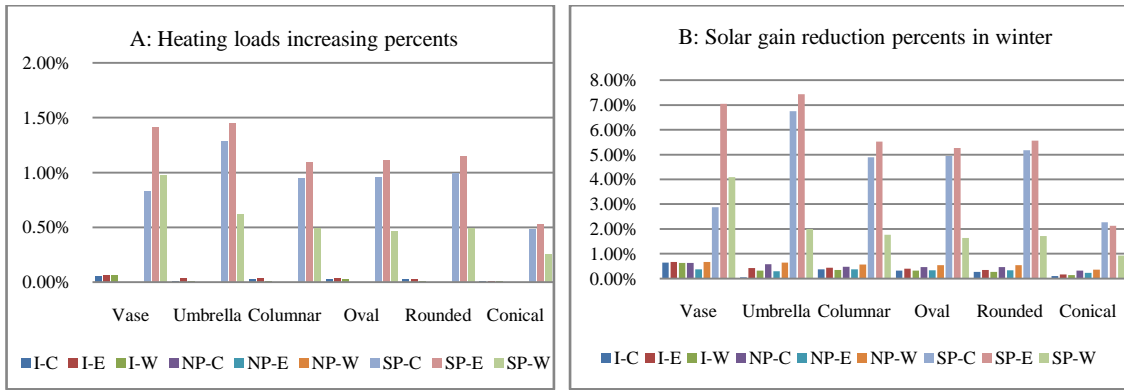


Figure (5.8): A: Total heating loads increasing percents, B: Solar gain reduction percents for different street trees shape (second scenario)

It is observed that increasing energy consumption percents in winter is affected by decreasing the potential of incident solar radiation on buildings' facades, thus solar gain by walls. It is noticed in the previous figure (5.4) that solar gain reduction percents increased for planting vase, umbrella, columnar, oval, rounded and conical by about 7.04%, 7.43%, 5.52%, 5.27%, 5.56%, and 2.13% respectively. Also, changing trees locations from centralized island to north pavement and south pavement increased the reduction percents of solar gain by about 0.65%, 0.64%, and 2.87% respectively for vase tree. Location of trees on the east edge of building has the highest reduction percents.

**CO2 emissions amount:** It is noticed from figure (5.9) that CO2 emissions percents decreased in summer by about 0.41%, 0.22%, 0.18%, 0.14%, 0.15%, and 0.09% for planting vase, umbrella, columnar, oval, rounded, and conical respectively in south pavement. While CO2 emissions increasing percents in winter decreased by about 0.59%, 0.43%, 0.43%, 0.41%, 0.41% and 0.19% for planting vase, columnar, conical, rounded, oval, and umbrella respectively in south pavement.

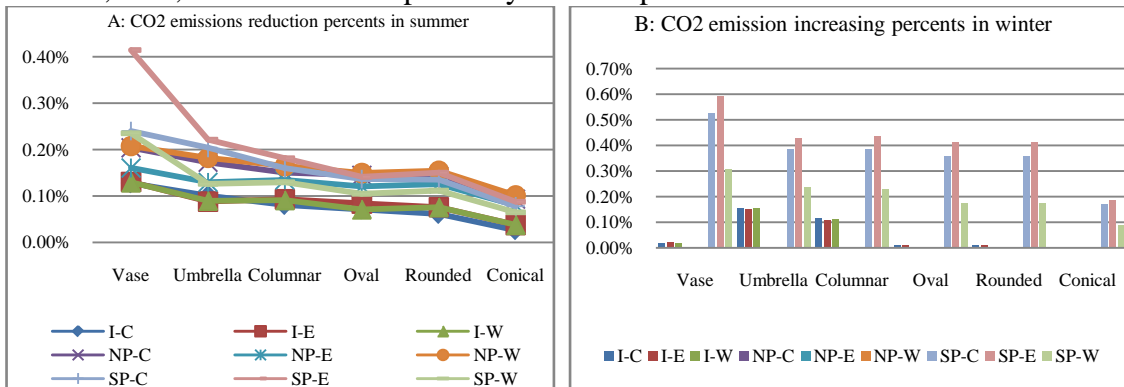


Figure (5.9): A: CO2 emissions reduction in summer, B: CO2 emissions increasing in winter, for different street trees shape (second scenario)

The discrepancy between the two scenarios is the trees form arrangement from the highest to the lowest. Obviously, umbrella provides the lowest energy saving percents of first scenario because of the low of crown shade. Also, columnar and conical shade covers great part of façade and roof. In the second scenario, the umbrella provides the second highest energy saving percents because its crown is higher, while conical and columnar shade doesn't cover roof. Vase, rounded, and oval parameters roughly do not changed in two scenarios, thus its effect don't change too.



### 5.3 The Effect of Street Trees Size and Height on Energy Consumption

One of the important features of trees configurations is crown size and tree height and the manner of growing either horizontal or vertical. Each tree in urban context takes many forms and occupies part of space somehow depending on its growing features. Many trees crown get bigger or spread horizontally year by year with remaining its trunk height. Other trees get taller without increasing its crown size. Also, a lot of trees get bigger and taller in the same time, therefore its foliage characteristics change. Some of trees can be formed to give geometric shapes for aesthetic purposes.

#### 5.3.1 Parametric Investigation

This study investigated the effect of trees size and height in street. Hence, two scenarios of trees were represented to show the effect of different crown size and different trunk height separately. Street parameters combination and trees locations are the same as in the previous study, where trees parameters combination changes as follow:

- Figure (5.10) shows the first scenario parameters of changing tree crown size with fixed trunk height.
- In the first scenario, four trees were simulated in three locations (I-E, NP-W, and SP-E). Vase tree consider the optimum solution in two previous scenarios of previous study, high trunk umbrella consider the second optimum solution in the second scenario of previous study, and rounded and columnar (oval and conical have same effect) are simulated too in order to get comprehensive view for all possible trees size.

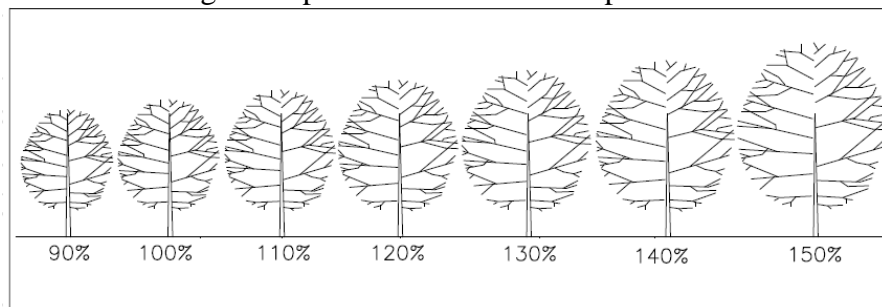


Figure (5.10): Changing tree crown volume size with fixed trunk height

- Figure (5.11) shows the second scenario parameters of changing tree trunk height with fixed crown volume size.
- In the second scenario, vase tree is simulated in three locations (I-E, NP-W, and SP-E).

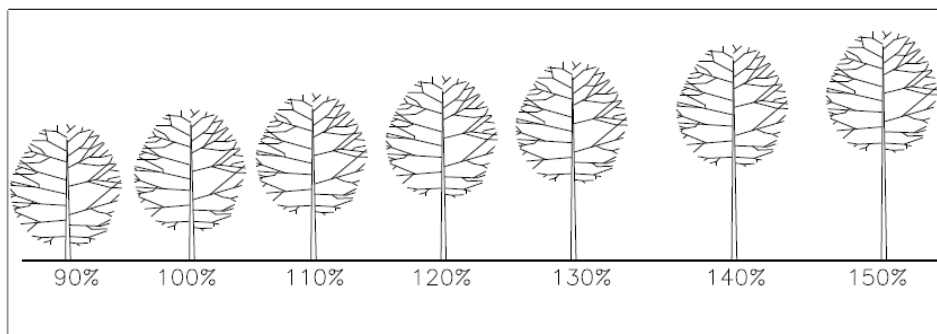


Figure (5.11): Changing tree trunk height with fixed crown volume size

### 5.3.2 Simulated Results

In this study, simulated results are classified according to the location of street trees. Three locations of trees are considered in current street case as follow: planting row of trees on centralized island and opposite to the east edge of building (I-E), planting row of trees on south pavement and opposite to the east edge of building (SP-E), and planting row of trees on north pavement and opposite to the west edge of building (NP-W). These locations were the optimum street trees planting solutions that concluded from the previous study.

#### a. First Scenario: Different trees crown volume size

**Cooling loads and solar gain in summer:** it is noticed in the following figures (5.12), (5.13), and (5.14) that as tree crown volume is getting bigger, total cooling loads amount (KWh) decrease. Therefore, energy saving percents for planting vase tree on south pavement increased by about 0.55%, 0.75%, 1.09%, 1.43%, 1.79%, 2.13%, and 2.48 as a result of increasing crown volume by about 90%, 100%, 110%, 120%, 130%, 140%, and 150% respectively. Basically, the shading amount of tree increases as tree volume increases and the potential of incident solar radiation on building façade decreases. Also, planting trees in the south pavement has the maximum impact that was discussed shortly before. Hence, energy saving percents increased by about 0.63%, 0.81%, and 2.48% for planting vase trees on centralized island, north pavement and south pavement respectively. The same trend can be noticed for the rest of shapes with less energy saving percents. On other hand, trees shape are ordered from vase tree, high trunk umbrella, columnnar, and rounded in terms of the highest energy saving in summer. Energy savings percents decreased by about 2.48%, 1.61%, 1.41%, and 1.10% for vase, umbrella, columnnar, and rounded respectively for 150% size and south pavement location. The same trend can be noticed for the rest of tree size and locations with less energy saving percents.

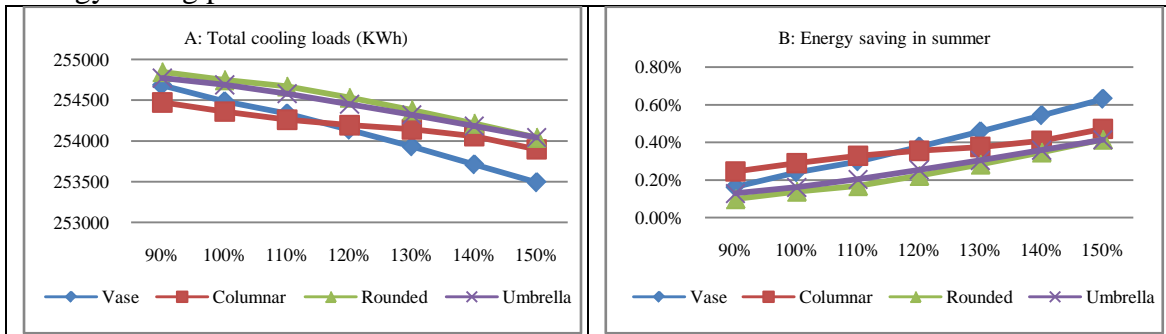


Figure (5.12): A: Total cooling loads amount (KWh), B: Energy saving percents for different trees crown size located in (I-E)

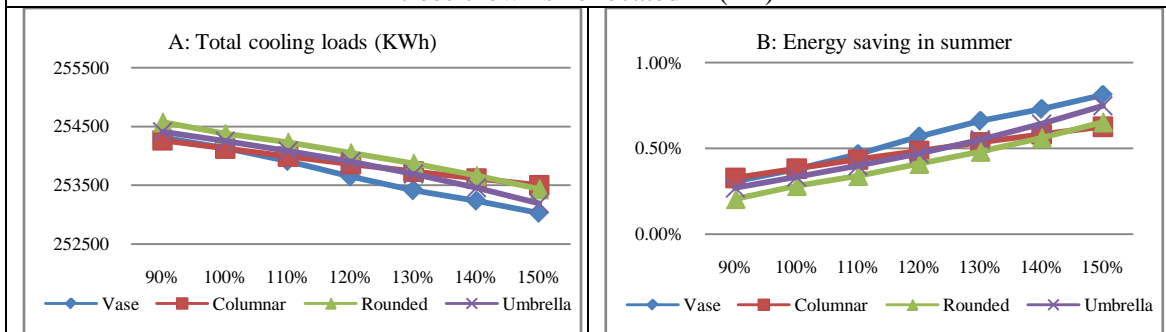
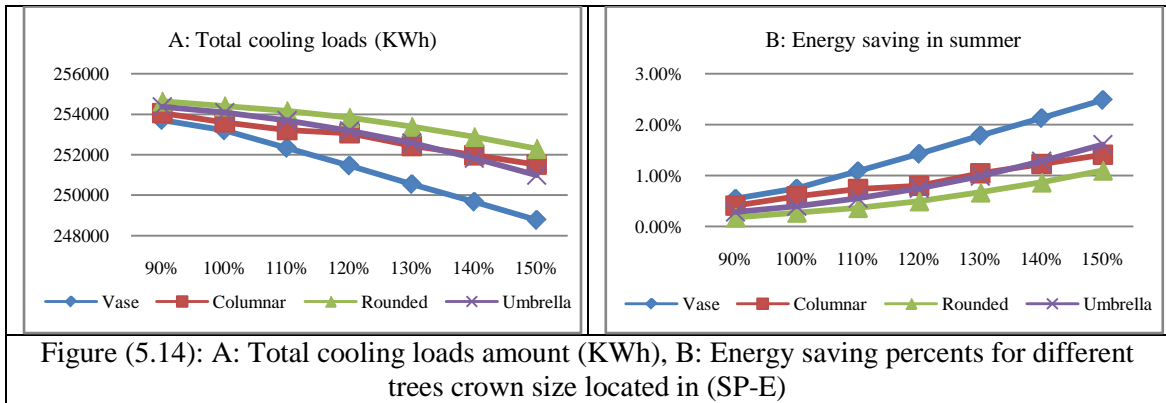
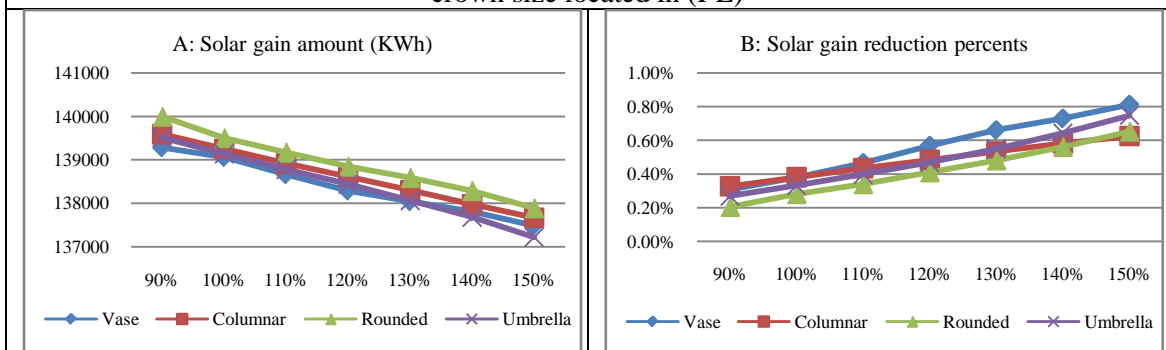
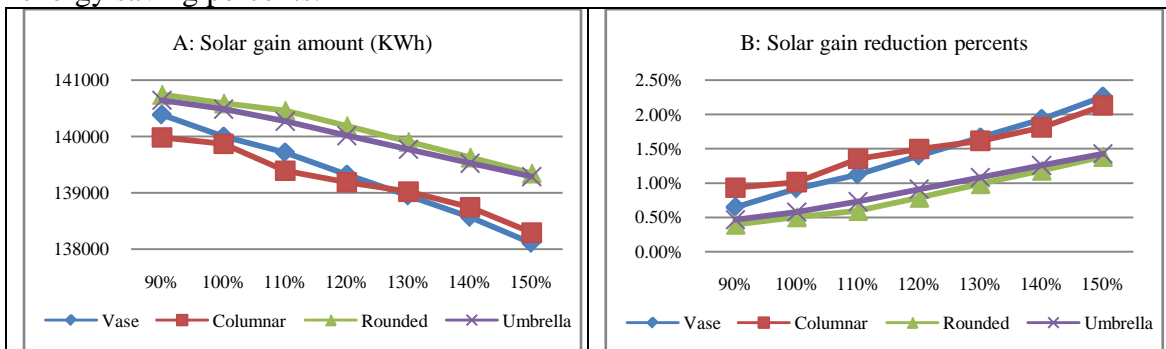
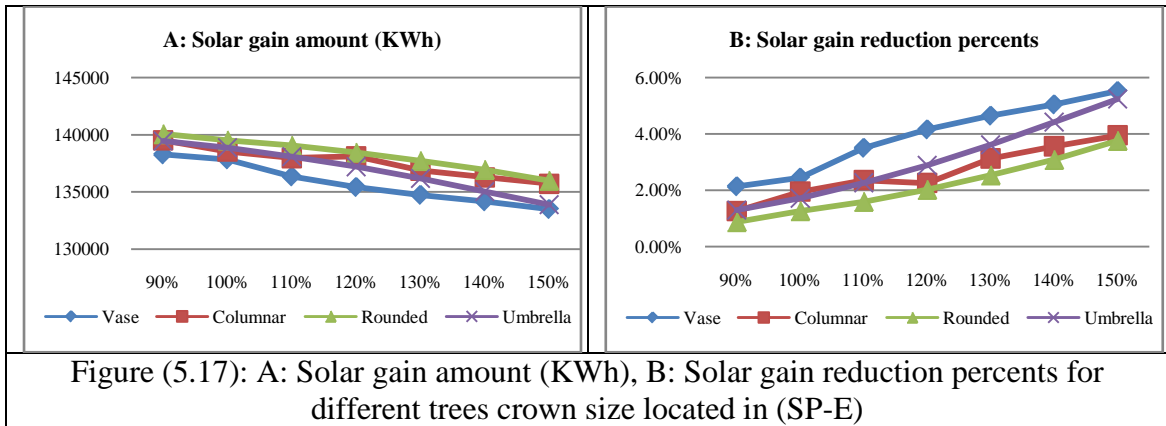


Figure (5.13): A: Total cooling loads amount (KWh), B: Energy saving percents for different trees crown size located in (NP-W)



In order to explain deeply the behavior of decreasing cooling loads, the potential of incident solar radiation on building façade and solar gain by windows was analyzed. It is observed in the following figures (5.15), (5.16), and (5.17) that the potential solar gain amount (KWh) decrease as tree crown volume increases. Thus, solar gain reduction percents increased by about 2.14%, 2.45%, 3.51%, 4.17%, 4.65%, 5.05%, and 5.53% as a result of increasing crown size by about 90%, 100%, 110%, 120%, 130%, 140%, and 150% respectively. Also, planting trees in the south pavement has the highest blocking values. Hence, solar gain reduction percents increased by about 2.26%, 2.71%, and 5.53% for planting vase trees on centralized island, north pavement and south pavement respectively. The same trend can be noticed for the rest of shapes with less solar gain reduction percents. On other hand, trees shape are ordered from vase tree, high trunk umbrella, columnnar, and rounded in terms of the highest solar gain reduction in summer. Solar gain reduction percents decreased by about 5.53%, 5.24%, 3.95%, and 3.76% for vase, umbrella, columnnar, and rounded respectively for 150% size and south pavement location. The same trend can be noticed for the rest of tree size and locations with less energy saving percents.





**Heating loads and solar gain in winter:** the results indicate that as tree crown volume is getting bigger, heating loads increase and planting trees in the south pavement has the maximum impact. Therefore, planting vase tree on south pavement increased energy consumption percents by about 1.38%, 1.41%, 1.79%, 1.98%, 2.18%, 2.37%, and 2.55 as a result of increasing crown size by about 90%, 100%, 110%, 120%, 130%, 140%, and 150% respectively. Hence, energy consumption percents increased by about 1.16%, 0.00%, and 2.55% for planting vase trees on centralized island, north pavement and south pavement respectively. Planting columnar tree on centralized island, north pavement or south pavement caused increasing energy consumption by about 1.10%, 0.32%, and 2.20% respectively. The same trend can be noticed for the rest of shapes with less energy consumption percents. On other hand, planting trees in south pavement are ordered as vase tree, columnar, high trunk umbrella, and rounded in terms of the highest energy consumption in summer. Energy consumption percents decreased by about 2.55%, 2.20%, 2.50%, and 2.18% for vase, columnar, umbrella, and rounded respectively for 150% size in south pavement. See figures (5.18), (5.19), and (5.20).

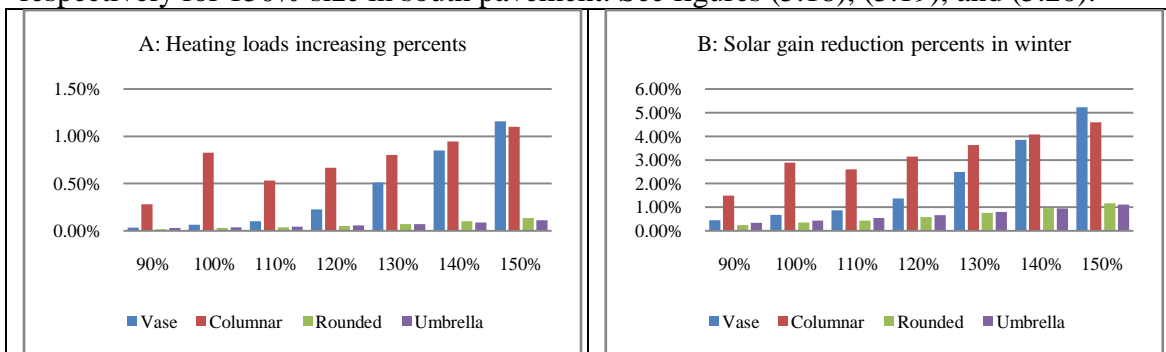


Figure (5.18): A: Total heating loads increasing percents, B: Solar gain reduction percents in winter for different trees crown size located in (I-E)

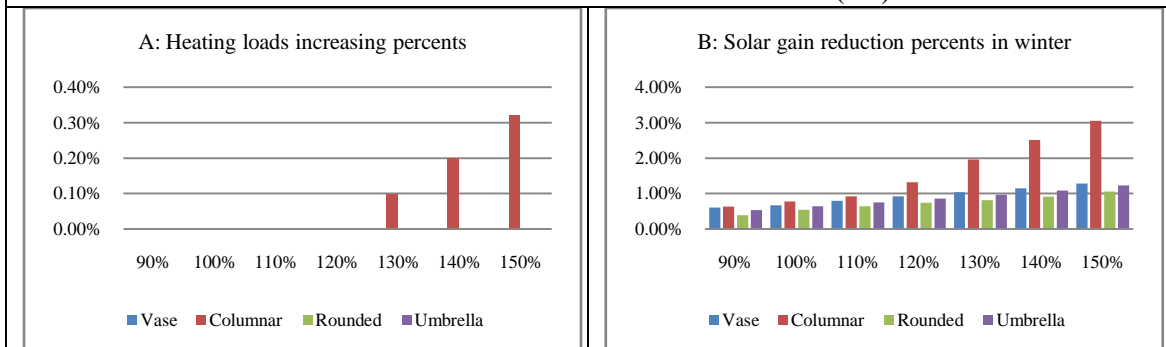


Figure (5.19): A: Total heating loads increasing percents, B: Solar gain reduction percents in winter for different trees crown size located in (NP-W)

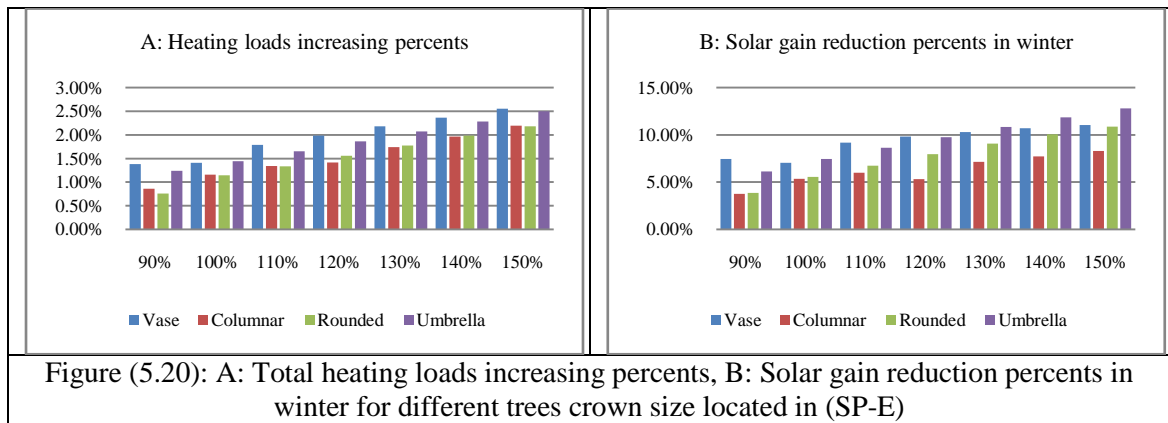


Figure (5.20): A: Total heating loads increasing percents, B: Solar gain reduction percents in winter for different trees crown size located in (SP-E)

To explain the behavior of increasing heating loads, the potential of incident solar radiation on building façade in winter and solar gain by windows was analyzed. It is observed in previous figures that the potential of solar gain amount decreases as tree crown volume increases. Thus, solar gain reduction percents increased by about 7.46%, 7.04%, 9.16%, 9.82%, 10.31%, 10.70%, and 11.04% as a result of increasing crown size by about 90%, 100%, 110%, 120%, 130%, 140%, and 150% respectively. Also, planting trees in the south pavement has the highest blocking values. Hence, solar gain reduction percents increased by about 5.22 %, 1.29%, and 11.04% for planting vase trees on centralized island, north pavement and south pavement respectively. On other hand, trees shapes are ordered as follow: vase tree, columnar, high trunk umbrella, and rounded in terms of the highest solar gain reduction in summer.

**CO2 emissions amount:** as a result of increasing heating loads in winter and decreasing cooling loads in summer, CO2 emissions from air conditioner increases in winter and decreases in summer. It is noticed from figures (5.21), (5.22), and (5.23) that CO2 emissions percents decreased in summer by about 1.39%, 0.90%, 0.79%, and 0.62% for planting vase, umbrella, columnar, and rounded respectively in south pavement. While CO2 emissions increasing percents decreased in winter by about 0.96%, 0.94%, 0.82%, and 0.81% for planting vase, umbrella, columnar, and rounded respectively in south pavement. In addition to that as tree size increase, CO2 emissions percents in summer decrease. Consequently, planting vase trees on south pavement increased CO2 emissions reduction percents in summer by about 0.31%, 0.45%, 0.61%, 0.80%, 1.00%, 1.19%, and 1.39% for size 90%, 100%, 110%, 120%, 130%, 140%, and 150% respectively. Also as tree size increases, CO2 emissions percents in winter increases. Hence, planting vase trees on south pavement decreased CO2 emissions increasing percents in winter by about 0.51%, 0.59%, 0.67%, 0.74%, 0.81%, 0.88%, and 0.96% for size 90%, 100%, 110%, 120%, 130%, 140%, and 150% respectively.

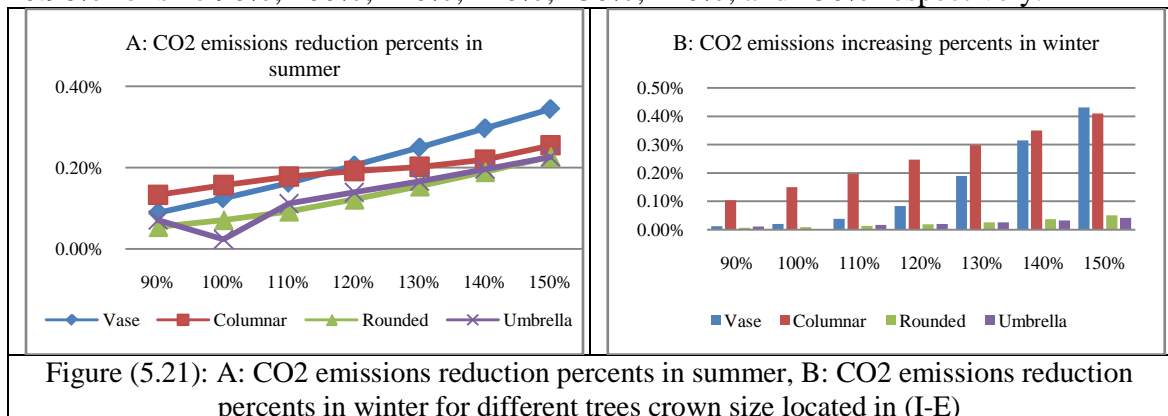


Figure (5.21): A: CO2 emissions reduction percents in summer, B: CO2 emissions increasing percents in winter for different trees crown size located in (I-E)

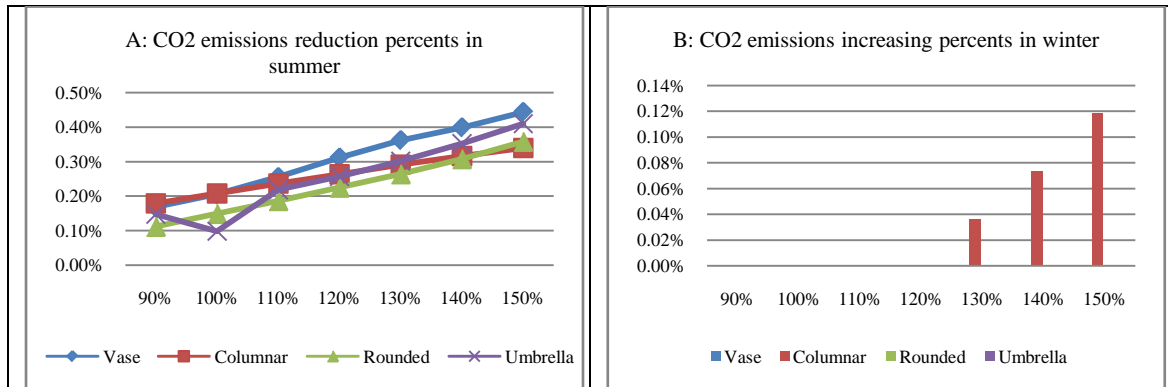


Figure (5.22): A: CO2 emissions reduction percents in summer, B: Solar gain reduction percents in winter for different trees crown size located in (NP-W)

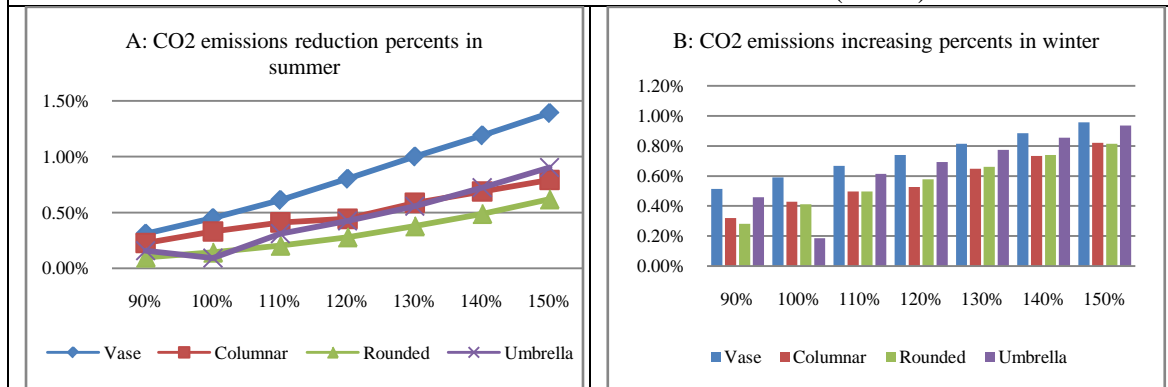


Figure (5.23): A: CO2 emissions reduction percents in summer, B: Solar gain reduction percents in winter for different trees crown size located in (SP-E)

**b. Second Scenario: Different trees trunk height**

**Cooling loads and solar gain in summer:** it is observed in figure (5.24) that as tree trunk height is getting taller, total cooling loads amount (KWh) decrease. Therefore, energy saving percents for planting vase tree on south pavement increased by about 0.70%, 0.75%, 0.75%, 0.77%, 0.79%, 0.81%, and 0.83 for increasing height by about 90%, 100%, 110%, 120%, 130%, 140%, and 150% respectively. Basically, the shading amount of tree increases as tree crown high from ground and the potential of incident solar radiation on building façade decreases. It is noticed also that planting trees in the south pavement has the maximum impact. Hence, energy saving percents increased by about 0.25%, 0.83%, and 0.83% for planting tall vase trees on centralized island, north pavement and south pavement respectively. The same trend can be noticed for the rest of heights with less energy saving percents.

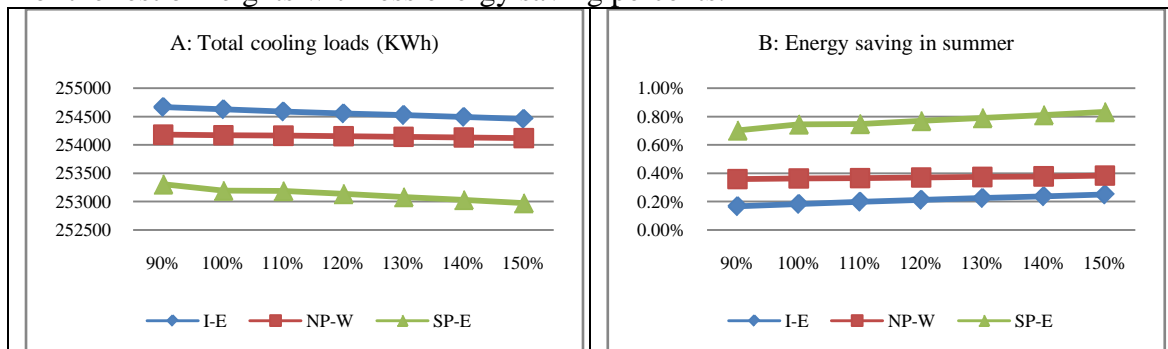


Figure (5.24): A: Total cooling loads amount (KWh), B: Energy saving percents for different trees trunk height

The behavior of decreasing cooling loads can be explained as decreasing the potential of incident solar radiation on building façade and solar gain by windows. It is observed in the following figure (5.25) that the potential solar gain amount (KWh) decreases as tree crown high from ground. Thus, solar gain reduction percents increased by about 2.72%, 2.74%, 2.78%, 2.80%, 2.81%, 2.82%, and 2.84% for increasing height by about 90%, 100%, 110%, 120%, 130%, 140%, and 150% respectively. Also, planting trees in the south pavement has the highest blocking values. Hence, solar gain reduction percents increased by about 0.96%, 1.57%, and 2.84% for planting tall vase trees on centralized island, north pavement and south pavement respectively. It can be concluded from previous results that the ability of tree shade to cover bigger area of particular façade or even roof increase by increasing trunk height.

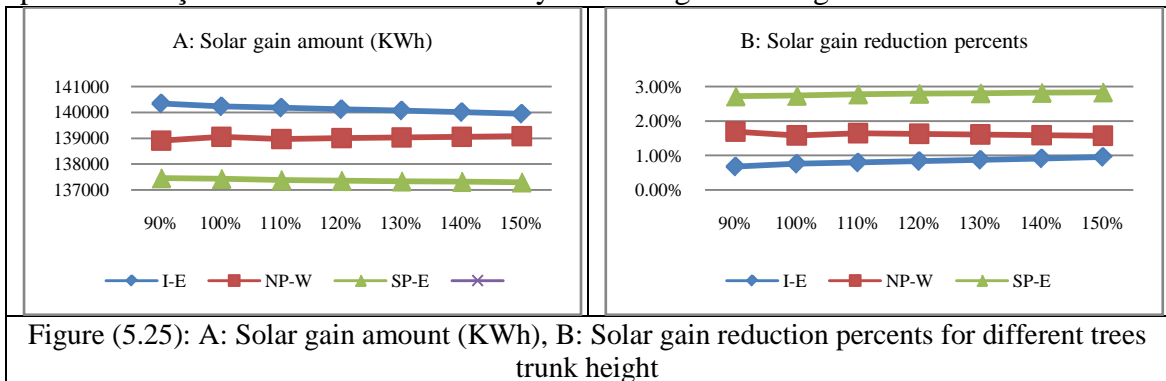


Figure (5.25): A: Solar gain amount (KWh), B: Solar gain reduction percents for different trees trunk height

**Heating loads and solar gain in winter:** the results indicate that the effect of increasing trunk height on increasing heating loads is very slight and is not observed. Planting vase tree on south pavement increases energy consumption percents by about 1.58%, 1.57%, 1.59%, 1.59%, 1.58%, 1.58%, and 1.57 for increasing height by about 90%, 100%, 110%, 120%, 130%, 140%, and 150% respectively. But, energy consumption percents increased by about 0.07%, 0.00%, and 1.57% for planting vase trees on centralized island, north pavement and south pavement respectively. Consequently, planting trees on south pavement has the highest energy consumption percents. See figures (5.26).

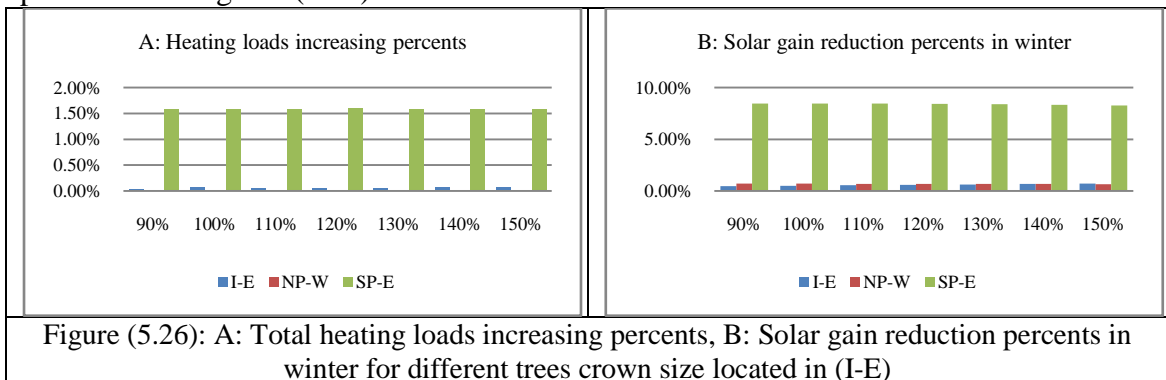


Figure (5.26): A: Total heating loads increasing percents, B: Solar gain reduction percents in winter for different trees crown size located in (I-E)

The potential of incident solar radiation on building façade in winter and solar gain by windows are also not observed for increasing trunk height. It is observed in previous figure that solar gain reduction percents increased by about 8.45%, 8.45%, 8.45%, 8.43%, 8.39%, 8.34%, and 8.27% for increasing height 90%, 100%, 110%, 120%, 130%, 140%, and 150% respectively. Also, solar gain reduction percents increased by about 0.71 %, 0.66%, and 8.27% for planting vase trees on centralized island, north pavement and south pavement respectively.



**CO2 emissions amount:** the results indicate that CO2 emissions from air conditioner increase slightly in winter and decrease with more remarkable in summer. It is noticed from figure (5.27) that CO2 emissions reductions percents increased in summer by about 0.40%, 0.41%, 0.42%, 0.44%, 0.45%, 0.46%, and 0.47% for increasing height 90%, 100%, 110%, 120%, 130%, 140%, and 150% respectively. While it increased in winter by about 1.36%, 1.37%, 1.37%, 1.37%, 1.37%, and 1.38% for increasing height 90%, 100%, 110%, 120%, 130%, 140%, and 150% respectively in south pavement that have the highest values.

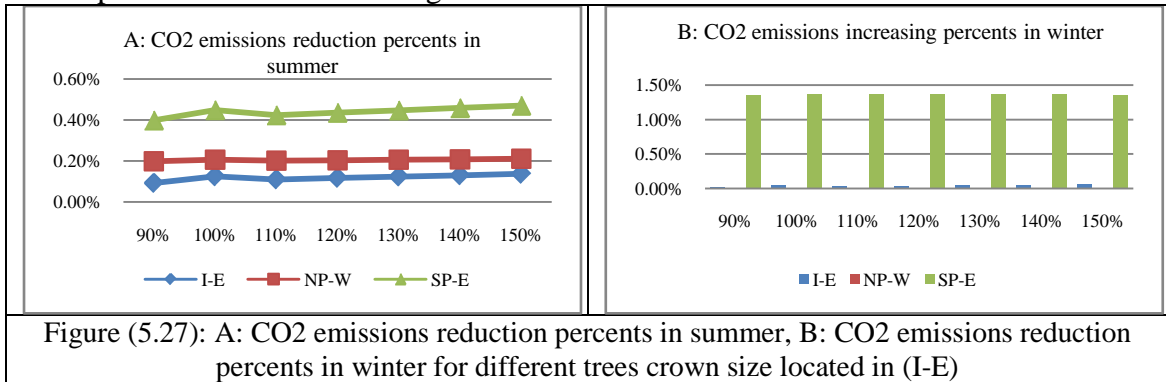


Figure (5.27): A: CO2 emissions reduction percents in summer, B: CO2 emissions reduction percents in winter for different trees crown size located in (I-E)

## 5.4 The Effect of potential Street Trees Lines Number on Energy Consumption

It is widely known that improving city microclimate related mainly with planting trees with right manner. Planting multiple trees rows in specific area is reflected positively on eliminating the bad effects of opaque surfaces, thus eliminating urban heat island phenomenon. Therefore, chosen trees rows locations in street need good study for street width and pavements width and number. Taking into consideration other factors such as safe movement for vehicles and people as well. As mentioned before, the impact of street trees reduced as trees moved away from building. Beside, planting trees in one pavement affect adjacent buildings more than far buildings. The current study investigates planting trees in two pavements, in one of them and centralized island, or in three locations together.

### 5.4.1 Parametric Investigation

This study investigated the effect of trees rows number and their locations in street. Hence, two scenarios of trees were represented to show the effect of different locations in detail. Street parameters are the same previous studies, where trees rows number and its locations change. Table (5.4) shows the first study parameters.

Table (5.4): Multiple trees rows locations parameters			
IC-SPC	IC-NPC	SPC-NPC	IC-SPC-NPC

For more details, studying the effect of multiple planting locations includes the locations of trees on the opposite of east and west edges of buildings in addition to building center. Table (5.5) show sixty four simulated models that describe different



street trees location possibilities. These possibilities are divided into to three categories: planting trees on one pavement, two pavement together, or three pavements.

**Table (5.5): Different street tree locations possibilities**

		0			I-C				I-E				I-W			
	0	NP C	NPE	NP W	0	NPC	NPE	NPW	0	NPC	NPE	NPW	0	NPC	NPE	NPW
0	0	NPC	NPE	NPW	IC	IC- NPC	IC- NPE	IC- NPW	IE	IE- NPC	IE- NPE	IE- NPW	IW	IW- NPC	IW- NPE	IW- NPW
SP C	S P C	NPC -SPC	NPE -SPC	NPW -SPC	IC- SP C	IC- NPC- SPC	IC- NPE- SPC	IC- NPW- SPC	IE- SP C	IE- NPC- SPC	IE- NPE- SPC	IE- NPW- SPC	IW- SPC	IW- NPC- SPC	IW- NPE- SPC	IW- NPW- SPC
SP E	S P E	NPC -SPE	NPE -SPE	NPW -SPE	IC- SPE	IC- NPC- SPE	IC- NPE- SPE	IC- NPW- SPE	IE- SP E	IE- NPC- SPE	IE- NPE- SPE	IE- NPW- SPE	IW- SPE	IW- NPC- SPE	IW- NPE- SPE	IW- NPW- SPE
SP W	S P W	NPC -SPW	NPE -SPW	NPW -SPW	IC- SP W	IC- NPC- SPW	IC- NPE- SPW	IC- NPW- SPW	IE- SP W	IE- NPC- SPW	IE- NPE- SPW	IE- NPW- SPW	IW- SP W	IW- NPC- SPW	IW- NPE- SPW	IW- NPW- SPW

I= Island, NP= North Pavement, SP= South Pavement, C= center of building, E= East edge of building, W= West edge of building

### 5.4.2 Simulation Results

In the current study, simulation is conducted for three trees types: vase, high trunk umbrella, and rounded in first scenario. The second scenario is considered as a detailed analysis for the first one. Hence, vase tree is used to study the sixty four location possibilities in order to get the optimum planting in the street.

#### a. First Scenario: Multiple trees rows locations

**Cooling loads and solar gain:** it is noticed from figure (5.28) that the impact of street trees increases as trees planting locations increase. Obviously, planting trees on the centralized island has the lowest impact. Take into consideration the ability of trees to cast shade on building façade from close or far distances with varying degrees. Hence, the most of trees shading is casted on ground when planted trees far enough from building. Whereas planting trees on two pavements and island has the highest impact. Planting vase trees rows in multiple locations increased the energy saving percents by about 0.23%, 0.36%, 0.72%, 0.54%, 0.90%, 1.08%, and 1.21% for IC, NPC, SPC, IC-NPC, IC-SPC, SPC-NPC, and IC-SPC-NPC respectively. It is obvious that planting trees in south pavement has the highest energy saving values. These values increase if trees planted in south side combined with planting it in other pavement. Also, planting trees in south pavement has higher energy saving percents than planting trees in north pavement and centralized island together. Beside that vase tree has the highest energy saving percents. They decreased by about 1.21%, 0.79%, and 0.57% for planting vase, umbrella, and rounded trees respectively in three pavements. The figure show slight discrepancy in the behavior of each tree type. This can explained due to the special features for each tree form.

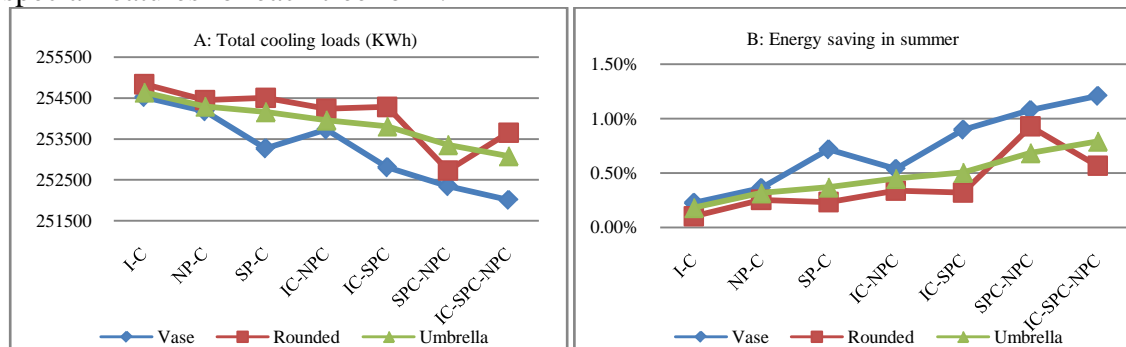


Figure (5.28): A: Total cooling loads amount (KWh), B: Energy saving percents for multiple street trees planting locations

The behavior of energy saving in summer follows the behavior of solar gain that has the same trend. It is evident from figure (5.29) that varying planting locations has an impact on solar gain by windows. Generally, increasing trees coverage reduces incident solar radiation, thus solar gain by building elements. Planting trees in south pavement has the highest impact that increased as it combined with planting trees in other side. Consequently, planting trees in multiple locations increased solar gain reduction percents by about 0.92%, 1.49%, 2.40%, 2.19%, 3.11%, 3.89%, and 4.38% for following locations: IC, NPC, SPC, IC-NPC, IC-SPC, SPC-NPC, and IC-SPC-NPC respectively. Also, vase tree has the highest reduction percents. Solar reduction percents decreased by about 4.38%, 3.23%, and 2.37% for planting vase, umbrella, and rounded trees respectively in three pavements.

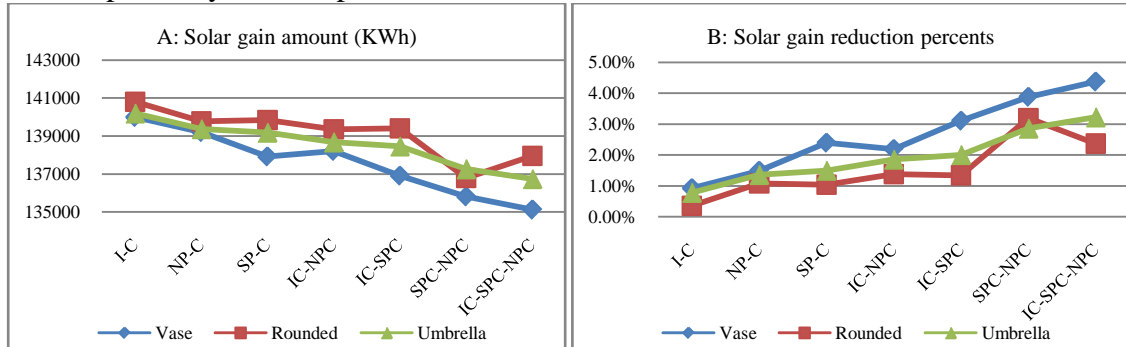


Figure (5.29): A: Solar gain amount (KWh), B: Solar gain reduction percents for multiple street trees planting locations in summer

**Heating loads and solar gain in winter:** the results indicate that the energy consumption increased in winter for planting trees in multiple locations. Total heating loads increasing percents increased by about 0.05%, 0.00%, 1.41%, 0.00%, 1.46%, 1.30%, and 1.36% for planting vase tree on IC, NPC, SPC, IC-NPC, IC-SPC, SPC-NPC, and IC-SPC-NPC respectively. As shown in figure (5.30) total heating loads increasing percents for planting tree in south pavement has the highest value that increase if it is combined with other location. So that planting trees on south pavement has higher heating increasing percents in summer than centralized island and north pavement. Planting trees on north pavement alone or combined with planting it in centralized island has almost no effect of heating loads. On other hand, vase tree has the highest energy consumption percents that are decreased by about 1.36%, 1.24%, and 0.92% for planting vase, umbrella, and rounded trees respectively in three pavements. The same trend can be noticed for the rest of shapes with less heating increasing percents.

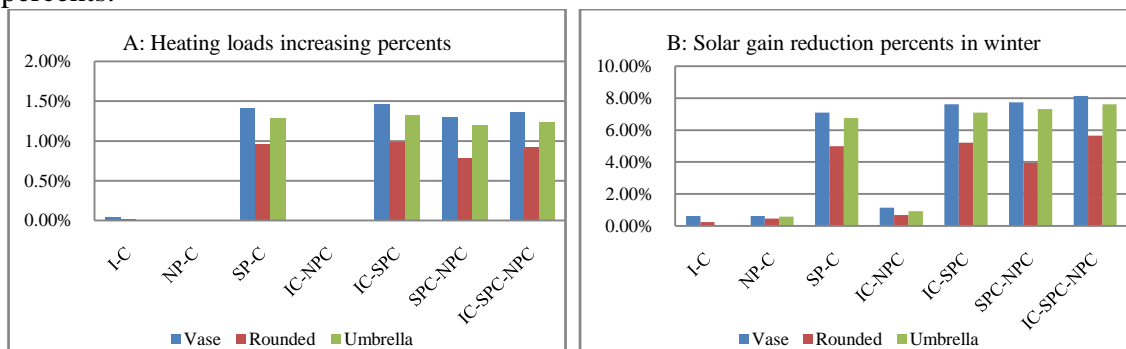


Figure (5.30): A: Total heating loads increasing percents, B: Solar gain reduction percents for multiple street trees planting locations in summer

It is observed that increasing energy consumption percents in winter is affected by decreasing the potential of incident solar radiation on buildings' facades, thus solar gain by windows. It is noticed in the previous figure (5.30) that solar gain reduction percents increased for planting vase tree on IC, NPC, SPC, IC-NPC, IC-SPC, SPC-NPC, and IC-SPC-NPC by about 0.62%, 0.62%, 7.10%, 1.15%, 7.61%, 7.73%, and 8.14% respectively. In the case of East-West Street, planting trees on south pavements reduces incident solar radiation and solar gain more than planting trees in north pavements. So that, planting trees on south pavement with planting it in other location reduces the solar gain more than other cases. Consequently, planting trees in three locations have the highest impact on reducing incident solar radiation, thus solar gain.

**CO2 emissions amount:** It is noticed from figure (5.31) that CO2 emissions percents follows the same trend of decreasing and increasing cooling and heating loads in summer and winter. It decreased in summer by about 0.12%, 0.20%, 0.40%, 0.29%, 0.50%, 0.60%, and 0.67% for planting vase tree on IC, NPC, SPC, IC-NPC, IC-SPC, SPC-NPC, and IC-SPC-NPC respectively. While it increased in winter by about 0.02%, 0.00%, 0.52%, 0.00%, 0.54%, 0.49%, and 0.51% for planting vase tree on IC, NPC, SPC, IC-NPC, IC-SPC, SPC-NPC, and IC-SPC-NPC respectively.

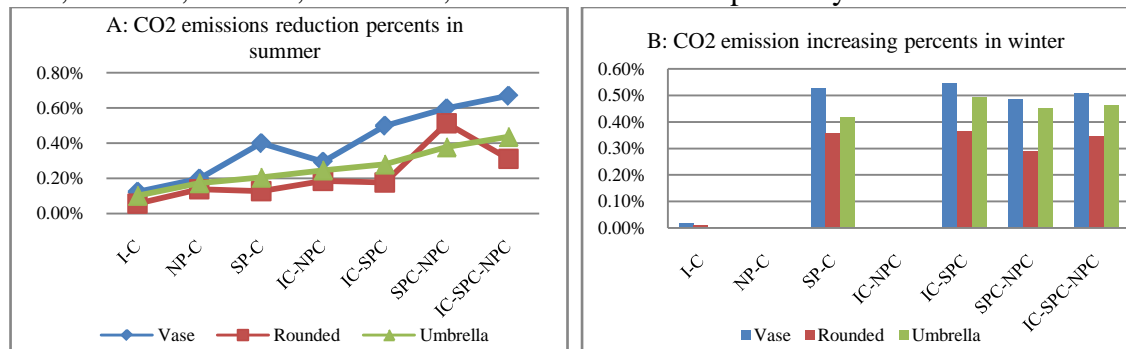


Figure (5.31): A: CO2 emissions reduction in summer, B: CO2 emissions increasing in winter, for multiple street trees planting locations in summer

### b. Second Scenario: Detail study for additional planting trees rows locations possibilities

It was analyzed previously the priority of planting trees in particular locations for the current street case. Planting trees in the south pavement (SP) has the highest energy savings compared with north pavement and centralized island. In addition to that, planting trees on north pavement (NP) has higher energy saving percents than centralized island (I) because of proximity of it from building façade. Moreover, planting trees in the opposite of east edge of building on south pavement (SPE) or centralized island (IE) has the optimum energy saving compared with the opposite of center (SPC, IC) or west edge of building (SPW, IW). Also, planting trees in the opposite of west edge of building on north pavement (NPW) has the highest energy saving percents compared with center of building or east edge (NPC, NPE). According to these results, figure (5.32) indicates the effect of planting row of trees on two pavements or three pavements. However the slight discrepancy between locations that shared with south pavement, planting trees in (SPE+ NPW) and (IE+NPW+SPE) has the highest energy saving. Consequently, energy savings percents increased by about 1.16% and 1.32% for previous locations respectively. Table (5.6) shows the energy saving percents in summer for multiple planting locations possibilities.

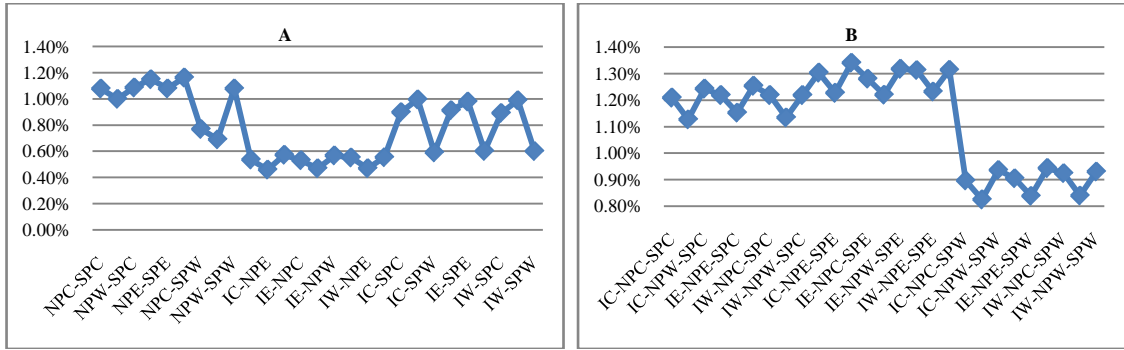


Figure (5.32): The effect of planting trees for different locations possibilities on cooling loads reduction, A: Two pavements, B: Three pavements

**Table (5.6) Energy saving percents in summer for multiple planting locations**

	0				I-C				I-E				I-W			
	0	NP-C	NP-E	NP-W	0	NP-C	NP-E	NP-W	0	NP-C	NP-E	NP-W	0	NP-C	NP-E	NP-W
<b>0</b>	0.00	0.36	0.29	0.37	0.23	0.54	0.46	0.57	0.23	0.53	0.47	0.57	0.22	0.55	0.47	0.56
<b>SP-C</b>	0.72	1.08	1.00	1.09	0.90	1.21	1.13	1.24	0.91	1.22	1.15	1.25	0.89	1.22	1.14	1.22
<b>SP-E</b>	0.79	1.15	1.08	1.16	1.00	1.30	1.23	1.34	0.98	1.28	1.22	1.32	0.99	1.31	1.23	1.32
<b>SP-W</b>	0.41	0.77	0.69	1.08	0.59	0.90	0.82	0.94	0.60	0.90	0.84	0.94	0.60	0.92	0.84	0.93

I= Island, NP= North Pavement, SP= South Pavement, C= center of building, E= East edge of building, W= West edge of building

Solar gain by windows is shown in figure (5.33) that takes the same trend of previous results. It is known that total cooling loads decrease as incident solar radiation decreases, thus solar gain. Therefore, planting trees in (SPE+ NPW) and (IE+NPW+SPE) has the highest solar gain reduction percents that increased by about 4.42% and 5.05% respectively. Table (5.7) shows solar gain reduction percents in summer for multiple planting locations possibilities.

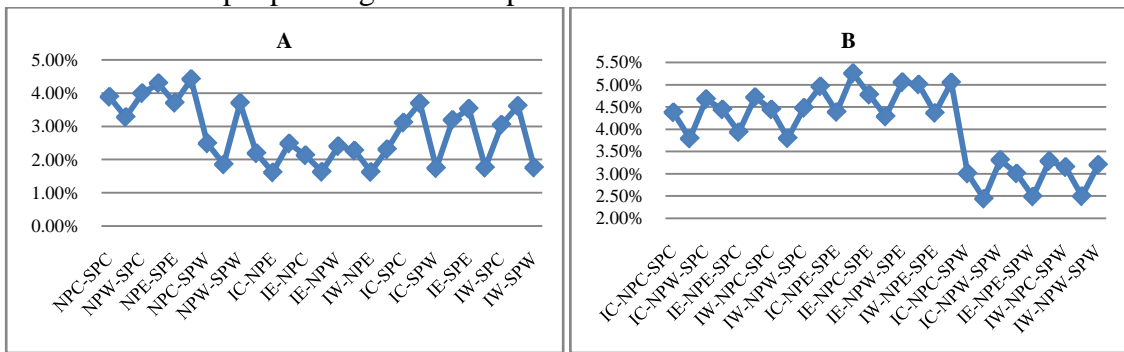


Figure (5.33): The effect of multiple possibilities of planting trees in A: two pavements, B: Three pavements on solar gain reduction percents

**Table (5.7) Solar gain reduction percents in summer for multiple planting locations**

	0				I-C				I-E				I-W			
	0	NP-C	NP-E	NP-W	0	NP-C	NP-E	NP-W	0	NP-C	NP-E	NP-W	0	NP-C	NP-E	NP-W
<b>0</b>	0.00	1.49	0.89	1.60	0.92	2.19	1.62	2.48	0.88	2.13	1.63	2.40	0.87	2.27	1.63	2.31
<b>SP-C</b>	2.40	3.89	3.28	4.00	3.11	4.38	3.79	4.67	3.19	4.44	3.94	4.72	3.05	4.44	3.80	4.48
<b>SP-E</b>	2.81	4.29	3.71	4.42	3.70	4.97	4.39	5.26	3.53	4.78	4.28	5.05	3.61	5.01	4.37	5.05
<b>SP-W</b>	1.01	2.49	1.86	3.71	1.74	3.00	2.44	3.30	1.76	3.00	2.49	3.28	1.76	3.15	2.49	3.20

I= Island, NP= North Pavement, SP= South Pavement, C= center of building, E= East edge of building, W= West edge of building

As shown in figure (5.34), planting trees in south pavement with planting it in other location has the highest energy consumption in winter. In contrast, planting trees on north pavement with planting it in centralized island has almost no effect. However the slight discrepancy between locations that shared with south pavement, planting trees in (SPE+ NPW) and (IE+NPW+SPE) has the highest energy consumption. Consequently, energy consumption percents increased by about 1.49% and 1.56% for previous locations respectively. Table (5.8) shows the energy consumption percents in winter for multiple planting locations possibilities.

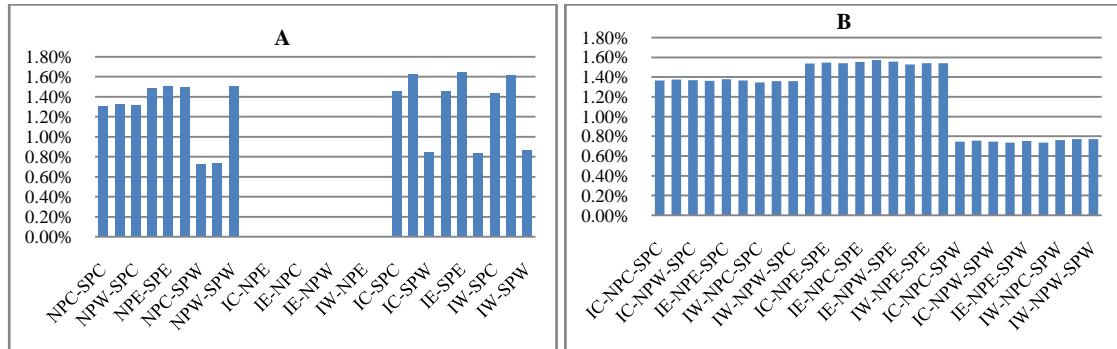


Figure (5.34): The effect of multiple possibilities of planting trees in A: two pavements, B: Three pavements on energy consumption percents in winter

Table (5.8) Energy consumption percents in winter for multiple planting locations																
	0				I-C				I-E				I-W			
	0	NP-C	NP-E	NP-W	0	NP-C	NP-E	NP-W	0	NP-C	NP-E	NP-W	0	NP-C	NP-E	NP-W
0	0.00%	-	-	-	0.01%	-	-	-	0.02%	-	-	-	0.01%	-	-	-
SP-C	0.43%	0.40%	0.40%	0.40%	0.44%	0.41%	0.42%	0.41%	0.44%	0.41%	0.42%	0.41%	0.44%	0.41%	0.41%	0.41%
SP-E	0.48%	0.45%	0.46%	0.45%	0.50%	0.47%	0.47%	0.47%	0.50%	0.47%	0.48%	0.47%	0.49%	0.46%	0.47%	0.47%
SP-W	0.25%	0.22%	0.22%	0.46%	0.26%	0.23%	0.23%	0.23%	0.25%	0.22%	0.23%	0.22%	0.26%	0.23%	0.24%	0.24%

I= Island, NP= North Pavement, SP= South Pavement, C= center of building, E= East edge of building, W= West edge of building

It is concluded that the increasing in energy reduction in summer is higher than the increasing in energy consumption in winter. So, annual energy loads were calculated to evaluate the trees energy efficiency all year. Hence, it is found that total loads all years decrease for all trees rows location possibilities. Annual energy loads appear in table (5.9) that illustrates the correlation between the effect of increasing trees rows numbers and the original case of street. It is evident that total load for original case equal 305914.0051 KWh, while other values are less than it. Therefore, table (5.10) shows annual load reduction percents all year.

Table (5.9) Annual energy loads (KWh)																
	0				I-C				I-E				I-W			
	0	NP-C	NP-E	NP-W	0	NP-C	NP-E	NP-W	0	NP-C	NP-E	NP-W	0	NP-C	NP-E	NP-W
0	308914.0051	307974	308161.5	307942.7	308345.6	307534.8	307732	307442.6	308343.5	307548.1	307708.6	307455.7	308349.4	307494.5	307704.9	307490.8
SP-C	307315.2402	306375.8	306578.9	306356	306862.3	306052.8	306261.4	305966.9	306823.4	306027.6	306198.2	305938.9	306877.7	306024.8	306240.6	306026.6
SP-E	307151.2813	306223.7	306406.3	306191	306643.3	305840.7	306037.3	305743.6	306688	305899.7	306057	305807.2	306661.2	305813.9	306021.4	305812
SP-W	307990.6271	307066.5	307270.3	306406.3	307546.9	306748.8	306935.9	306650.9	307517	306725.6	306899.3	306631.1	307527	306684.9	306902.3	306673.6

	0				I-C				I-E				I-W			
	0	NP-C	NP-E	NP-W	0	NP-C	NP-E	NP-W	0	NP-C	NP-E	NP-W	0	NP-C	NP-E	NP-W
0	0.0 0%	0.30 %	0.24 %	0.31 %	0.18 %	0.45 %	0.38 %	0.48 %	0.18 %	0.44 %	0.39 %	0.47 %	0.18 %	0.46 %	0.39 %	0.46%
SP-C	0.5 2%	0.82 %	0.76 %	0.83 %	0.66 %	0.93 %	0.86 %	0.95 %	0.68 %	0.93 %	0.88 %	0.96 %	0.66 %	0.94 %	0.87 %	0.93%
SP-E	0.5 7%	0.87 %	0.81 %	0.88 %	0.74 %	0.99 %	0.93 %	1.03 %	0.72 %	0.98 %	0.92 %	1.01 %	0.73 %	1.00 %	0.94 %	1.00%
SP-W	0.3 0%	0.60 %	0.53 %	0.81 %	0.44 %	0.70 %	0.64 %	0.73 %	0.45 %	0.71 %	0.65 %	0.74 %	0.45 %	0.72 %	0.65 %	0.73%

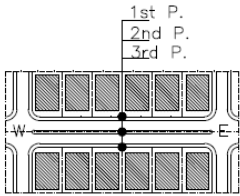
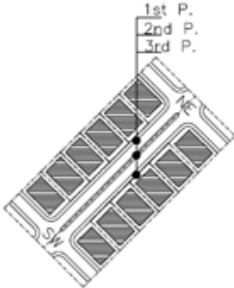
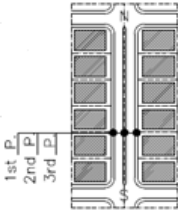
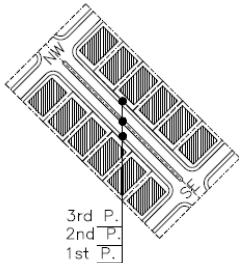
I= Island, NP= North Pavement, SP= South Pavement, C= center of building, E= East edge of building, W= West edge of building

## 5.5 The Effect of Street Trees on Energy Consumption of Building for Different Street Orientations

In urban context, street orientation changes as changing planning patterns from area to another or inside one pattern. Thus, buildings orientations change too with street orientations. Therefore, the effect of planting trees in each street orientation differs totally because front façade of buildings differs as well. East, west, south, and north are the main directions, in addition SE, NE, SW, and NW is secondary directions that are available for planting trees. The previous studies were conducted for E-W street orientation, where buildings have south front facades or north front facades. In the current study, four street orientations are simulated with trees rows to investigate the effect of them on energy consumption.

### 5.5.1 Parametric Investigation

The study investigate the effects of planting one type of tree on energy consumption of buildings for E-W, NE-SW, N-S, and NW-SE street orientations. Therefore, buildings front facades are south-north, northwestern-southeastern, east-west, and northeastern-southwestern respectively. To compare between those orientations, trees are planted on three pavements (1<sup>st</sup> (south SP), 2<sup>nd</sup> (Island I), and 3<sup>rd</sup> (north NP). See table (5.11)

E-W	NE-SW	N-S	NW-SE
			

### 5.5.2 Simulations Results

**Total cooling loads and solar gain:** before studying the effect of tree for different street orientations, simulations were conducted for each orientation without trees. As shown in figure (5.35) the results indicate that NE-SW street orientation has the highest

energy demand in summer. While E-W street orientation has the lowest energy demands in summer. When street is orientated NE-SW and NW-SE, the amount of incident solar radiation on the secondary facades is the highest. Also, N-S street orientation has higher energy demand than E-W orientation. So that received radiation from east and west façades is higher than south and north facades.

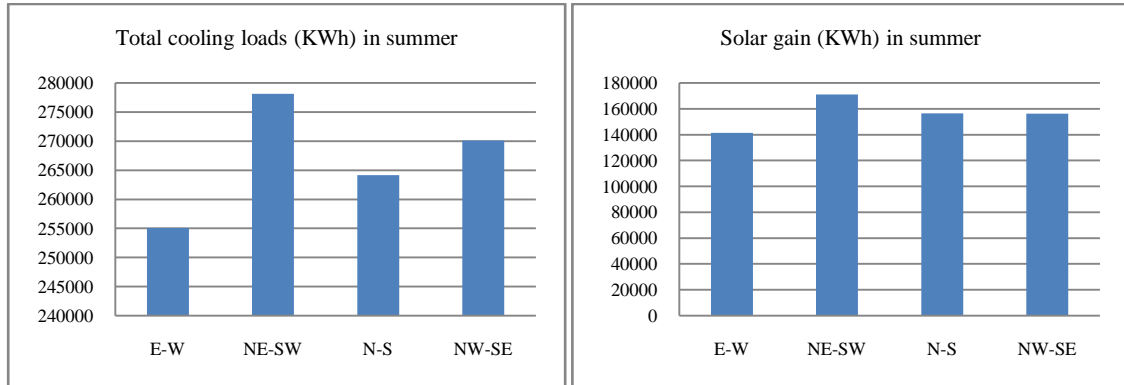


Figure (5.35) the effect of changing street orientations on A: total cooling loads (KWh) and B: solar gain (KWh)

Accordingly, the effect of trees on energy consumption of buildings for previous orientations has almost the same trend. As buildings receive much solar radiation, the effect of shading is high definitely. As shown in figure (5.36) N-S street orientation has the highest energy saving in summer. The reduction in solar gain as a result of shading the east and the west facades is the highest comparing with other orientations. Besides that, the effect of planting trees row on the east side (EP) is higher than planting it in west side (WP). The cooling loads reduction percents as a result of planting trees row in the first pavement (SP) increase by about 0.43%, 1.37%, 2.51%, and 1.52% for E-W, NE-SW, N-S and NW-SE street orientation respectively. The same trend is observed for second (I) and third pavement (NP) with lowest values.

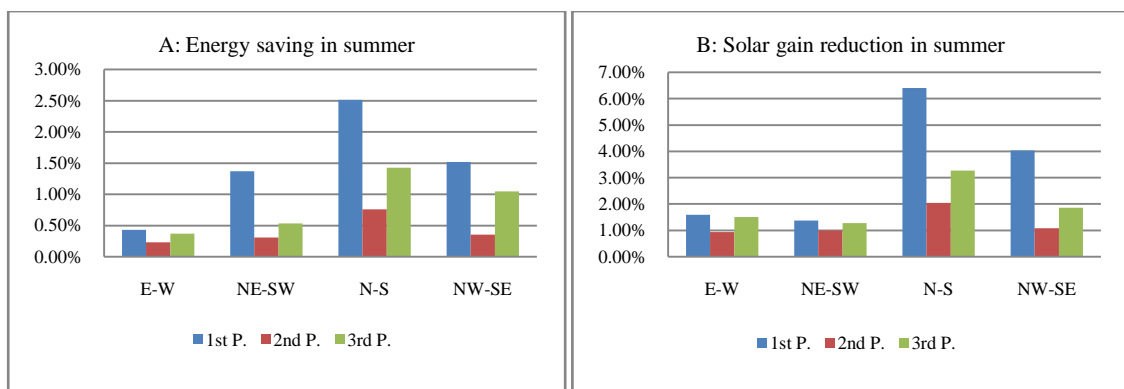


Figure (5.36) A: Energy saving and B: solar gain reduction percents as a result of street tree effect of different street orientations

For further analyses, figure (5.37) shows each street orientation as a single case with further locations of trees rows including center of building, to the right and to the left.

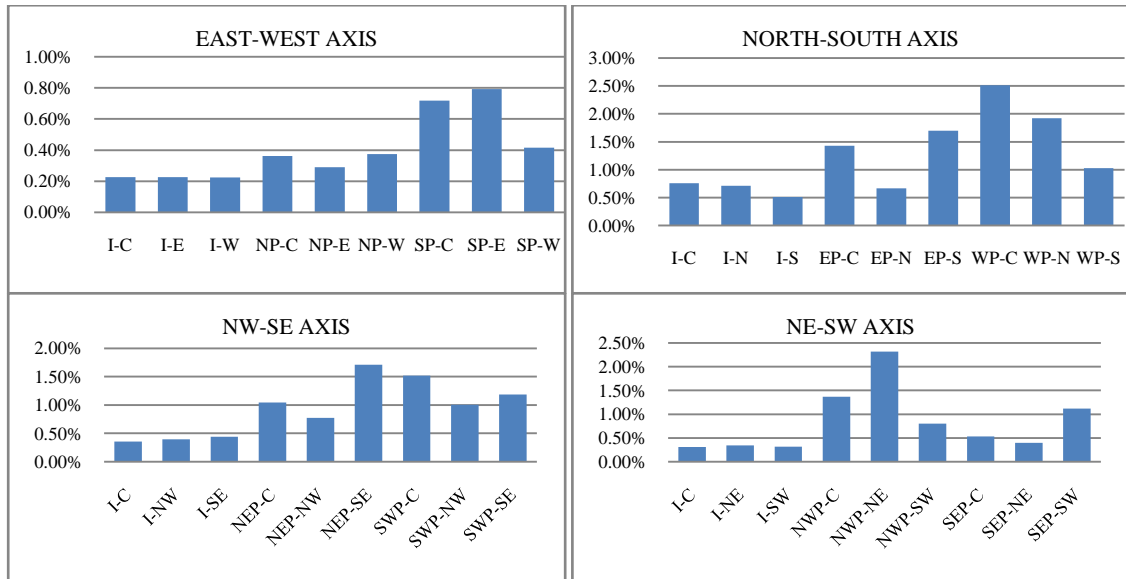


Figure (5.37): A: Energy saving as a result of street tree effect of different street orientations

Each street has own locations names that is cleared as follow:

- East-West axis: I=Island, NP=North Pavement, SP=South Pavement, E=East edge of building, W=West edge of building.
- North-South axis: I=Island, EP=East Pavement, WP=Western Pavement, N=North edge of building, S=South edge of building.
- NE-SW axis: I=Island, NWP=North West Pavement, SEP=South East Pavement, NE=North East edge of building, SW=South West edge of building.
- NW-SE axis: I=Island, NEP=North East Pavement, SWP=South West Pavement, NW=North West edge of building, SE=South East edge of building.

**Total heating loads and solar gain in winter:** as before, simulations were conducted for each orientation without trees to investigate energy consumption in winter. As shown in figure (5.38) the results indicate that E-W street orientation has the lowest energy demand, while NW-SE street orientation has the highest energy demands in winter. The sun altitude angel in winter is low enough in south direction that makes tree shade more effective than other direction.

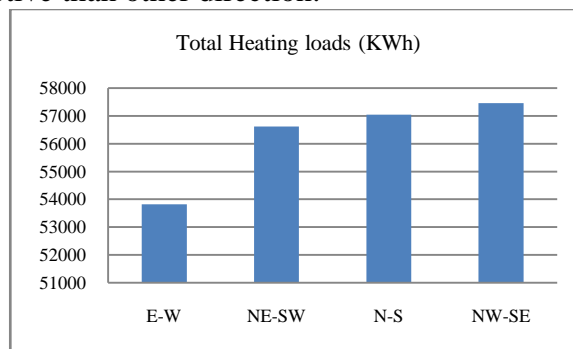


Figure (5.38) the effect of changing street orientations on total heating loads (KWh)

As shown in figure (5.39) E-W street orientation has the highest energy consumption in winter. The reduction in solar gain as a result of shading the south facade is the highest comparing with other orientations. The heating loads increasing percents as a result of planting trees row in the first pavement (SP) decreases by about 1.41%, 1.02%, 0.34%, and 0.26% for E-W, NE-SW, N-S and NW-SE street orientation



respectively. The same trend is observed for second (I) and third pavement (NP) with lowest values.

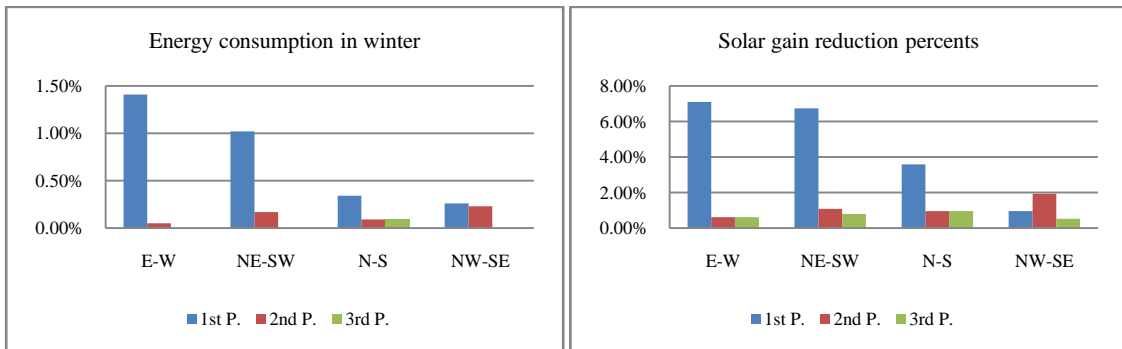


Figure (5.39): A: Energy consumption and B: solar gain reduction percents as a result of street tree effect of different street orientations

For further analyses, figure (5.40) shows each street orientation as a single case with further locations of trees rows including center of building, to the right and to the left.

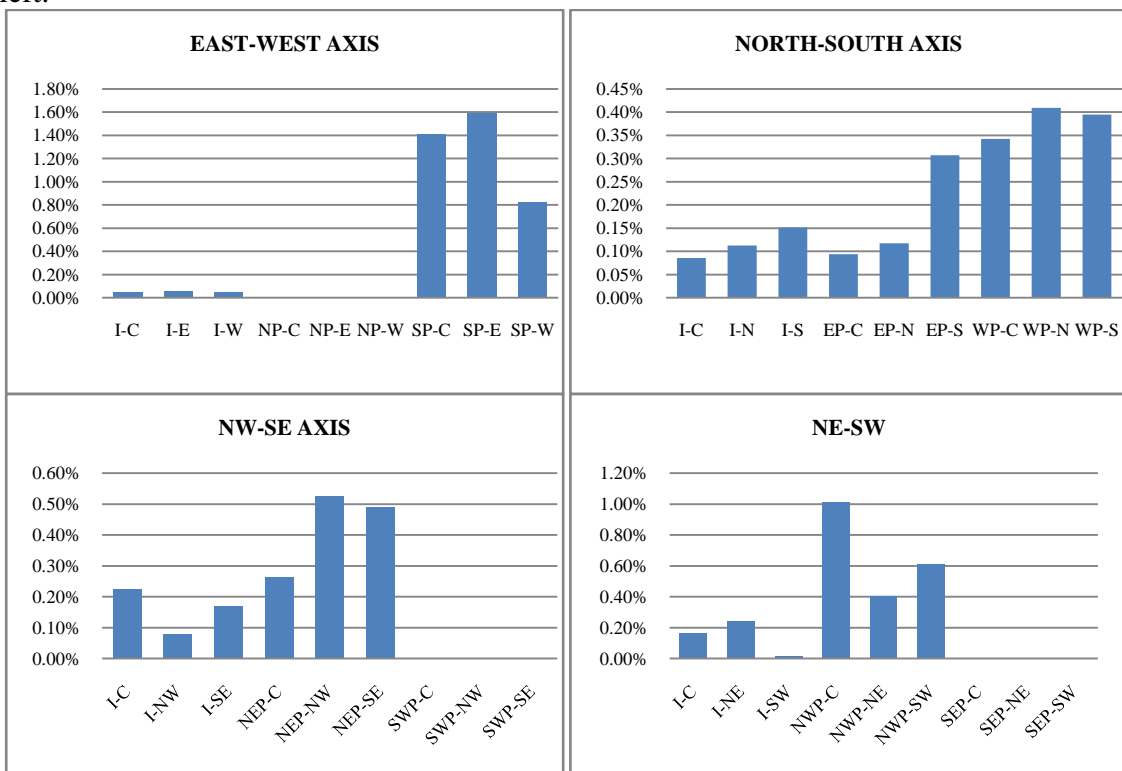


Figure (5.40): A: Energy saving as a result of street tree effect of different street orientations

## 5.6 Conclusions

This chapter concentrated on the effect of trees on street microclimate and surrounding environment. Street microclimate represents by the climatic conditions such as the amount of solar radiation and environment health conditions such as CO2 emissions. Therefore, three measurements were considered as main factors of thermal comfort: total cooling and heating loads, solar gain and CO2 emissions from air conditioner. Trees configurations including form, crown size, trunk height and row numbers are the main essential configurations that don't just affect energy consumption and surrounding microclimate, but they also affects the physical factors of street such as

visibility, safe movement for people and vehicles, infrastructure and aesthetic appearance. Also, the locations of trees rows in any street have mutual relations with adjacent buildings and street case that must be considered. It is concluded that vase and high trunk umbrella are the most trees types that are compatible with energy saving purpose and the physical needs of street. On other hand, each street orientation is affected by planting trees with different degrees. Street with north-south orientation is the most street affected by trees. Hence, east and west facades are the most important to shade. So, increasing planting trees in the north-south street can enhance the thermal performance of building, reduce energy demand, and thus reduce CO2 emissions.

## Chapter 6: Conclusions

The continuous change by man-made activities and extraordinary natural phenomena such as extinct plant and animal species, seasonal flooding and fire effects alter climatic and land patterns. Therefore, this challenge is related with climate change, global warming and unexpected phenomena such as urban heat island. Most cities planners and scientists have been concerned with this change, thus need and comfort of people. The lack of conventional energy and environment pollution is another challenge that related directly and indirectly with increasing CO<sub>2</sub> emissions from fossil fuels. Basically, the buildings are the big contributor of these problems, thus cooling in summer and heating in winter is the largest consumer of energy in the buildings. With taking into consideration the need of human to shelter from extreme heat and cold and to be healthy and comfortable. According to unusual conditions of the Gaza Strip, energy demand increases as the populations, services, and welfare means increase. Moreover, residential buildings in the Gaza Strip are the largest consumer of energy for the purpose of cooling, heating, lightening and others. The main problem is the shortage of energy sources in the Gaza Strip that makes the imported fossil fuels the main source of energy. And between political conditions and increasing energy consumption, the Gaza Strip suffers from lack of thermal comfort and healthy environment. So, many solar passive design strategies can be incorporated to help improving the thermal performance of buildings.

Planting trees is the most effective method of passive solar design for the purpose of energy saving. It is responsible for many benefits for surrounding environment. These benefits include shade, beauty, wind break, privacy, cleaner air, less noise, less glare and higher property values. But the key of the best benefits is to select right trees and plant it in the right place. The best chosen for trees configurations not only assures a lifetime of satisfaction, it is also keeping maintenance costs low. The role of trees in reducing energy consumption is integrated with trees requirements to thrive, its form, its size and its locations in the particular area. Planting trees near buildings for the purpose of achieving thermal comfort is associated with studying incident solar radiation and heat transfer between the building and the outdoor environment. Thus, measuring heat gain, solar gain, and total cooling and heating loads in summer and winter are the main factors that determine thermal comfort. The behavior of trees in summer and winter differs totally. Therefore, choosing trees types between deciduous and evergreen trees is very important. On the other hand, each area in the world has its own climatic conditions that are responsible for particular trees types planting. In the Mediterranean climate of the Gaza Strip, planting many types of trees is available. Also, the effect of trees shade on the buildings thermal performance is noticed strongly. Blocking incident solar radiation in particular façade is determined according to sun path and solar altitude angle all day and year. Hence, this study investigated the effect of many trees configurations possibilities on the residential building thermal performance in the Gaza Strip climate conditions. It studied the correlation between trees shade effect as a result of different trees configurations and energy consumption in terms of achieving thermal comfort and reducing energy consumption.

According to previous, the theoretical study concentrated on the energy and environment problems in the world and specific in the Gaza Strip. It highlighted the main factors influencing urban microclimate including climate change, global warming, greenhouse effect, urban heat island and environment pollution. The study assessed the whole situations in the Gaza Strip including populations, climate, energy and pollution.

Hence, it clarified the aspects of reducing energy consumption and achieving human comfort in buildings. Also, the study focused on one strategy of implementation passive solar design. Choosing right trees and planting it in the right place is considered the main solution for energy and pollution problems. It focused on its benefits, microclimate modification, and the strategies to plant it including choosing its desirable attributes. In addition, the study outlined the trees attributes in the Gaza Strip and classified them according to its form, foliage, leaf density, crown spread and mature height. The main results of theoretical study are:

- According to Intergovernmental panel report on climate change, earth surface temperature will be increased by about 1.4-5.8 C°.
- The buildings are responsible for 50% of global warming in term of burning fossil fuels. Also, cities are responsible for 70-80% of man-made CO<sub>2</sub> emissions that considered the main source of global warming.
- The temperature difference between urban green areas and surrounding structural areas is 7 C° or more during summer as a result of urban heat island effect.
- The urban heat island is considered the most notable phenomenon in urban areas in summer as a result of the ability of opaque surfaces to store incoming solar energy and release it again at night causing high air temperature.
- High temperature causes air pollution, thus threat people and environment health. It is directly and indirectly responsible for increasing CO<sub>2</sub> emissions and greenhouse gases into the atmosphere by forming harmful smog as ozone and burning fossil fuels to cool buildings through summer.
- In hot, humid and tropical climate, increasing temperature and solar intensity leads to increase UHI in urban areas, thus exacerbates energy use through air conditioner and refrigeration. Increasing air conditioners use is responsible for 5-10% of urban peak electric demand.
- Burning fossil fuels through building performance and construction is responsible for 50% of energy use worldwide. Non-renewable energy causes pollution and discomfort environment, thus lead people to achieve comfort through heating and cooling.
- During the last two decades (1984-2004), primary energy has grown by 49% and CO<sub>2</sub> emissions by 43% with an average annual increase of 2% and 1.8% respectively.
- The electricity consumption of the Gaza Strip was increased by 80% during the period 1999-2005 as a result of population growth and the expansion in different sectors that need electricity.
- Thermal comfort in the buildings environment can be achieved through incorporating passive solar design techniques in the early phase of design and construction, thus lead to reduce air temperature and energy consumption without increasing pollution and costs.

- Achieving passive solar design strategies in the buildings include: site and orientations selection, buildings forms, materials, glazing and opening that related with natural ventilation and lightening, shading devices and finally landscape shading.
- Trees have a great influence on blocking incident solar radiation, thus reducing overall heat transfer coefficient. Also, it can provide cooling effects through evapo-transpiration process.
- Trees provides many benefits including improving air quality, carbon storage and sequestrations, energy conservation by providing shading in summer, economic benefits, water conservation and storm water management, biodiversity conservation, noise reduction and human health conservation.
- Carefully positioned trees can save up to 25% of household energy consumption for heating and cooling. Trees can save cooling energy costs by 1.9%-2.5% per residential tree.
- Trees can affect microclimate by modification solar radiation, temperature, wind and humidity.
- Trees shade is able to block and store heat from direct solar gain, thus reducing surface temperature in built up areas in hot regions. As well as, large and dense trees can eliminate wind speed in winter in cold areas.
- Trees can reduce air temperature as much as 5C° and air temperature under trees can be reduced as much as 14C° cooler than air temperature above by intercepting solar radiation and releasing moisture into the atmosphere through leaves.
- The manner of planting trees is a significant factor in urban context with take into consideration ensuring survival rate and good physical growth, enhancing aesthetics and maximizing environment benefits including energy consumption and reduction of heat island effect.
- Planting trees is affected by site characteristics, trees attributes and its diversity. In this case the purpose of trees is very important for choosing tree types and its locations.
- Trees configurations including types, forms, size and height, numbers and locations need extensively study to achieve planting right tree in the right place for the purpose of energy saving in summer and winter.
- There are several trees types and parameters in the Gaza Strip that make it suitable region for responding effectively to trees energy benefits.

The energy and environment problems were the main motivation for parametrical study that were conducted using quantities analyses programs including DESIGNBUILDER and ECOTECT to investigate the effect of trees configurations on the buildings thermal performance. So, the study was divided into two sections: first one focused on the effect of trees on individual residential building to avoid the effect of adjacent buildings and the other studying the effect of trees in urban streets. Hence, first

part studied the effect of trees configuration including forms, size, distances, numbers and locations on energy consumption, thus human comfort. Investigation the effect of changing trees crown forms on thermal performance with different assumptions was the main purpose of the first study. The second study investigated the effect of increasing distances between tree and building on thermal performance. Changing trees locations a long single facade was also studied in terms of energy consumption and solar gain through windows. The third study focused on the effect of increasing tree size, while fourth study concentrated on the effect of increasing trees number and its locations possibilities on energy consumption in summer and winter. The last study in this section investigated the effect of one tree for different building configurations on building energy use and comfort.

The second section of the current study concerned with street trees planting. The role of trees was important to study for outside microclimate in addition to internal microclimate. The effect of changing trees crowns forms, size and height on energy consumption and environment pollution was the main subject of first part. The second part focused on the effect of trees rows number and locations possibilities. The effect of trees for changing street orientations was hold in the last part of study. The main results of practical study are:

- The ability of trees to block incident solar radiation by shading building facades depends upon trees geometries, trees size, trees locations near building, trees proximity to the building, and trees number and its locations.
- Incident solar radiation on particular façade depends on sun path and solar altitude angel all day and year.
- The effect of deciduous trees on reducing cooling loads in summer is higher than its effect on increasing heating loads in winter.
- The value of annual energy reduction as a result of the effect of deciduous trees is higher than the effect of evergreen trees.
- Deciduous trees with high spreading crowns are more suitable for energy efficiency in summer and vice versa in winter.
- The value of cooling loads reduction as a result of changing deciduous trees form can be ordered from the highest to the lowest as follow: vase tree, high trunk umbrella, rounded and oval.
- However planting tree in the east side of building provides the greatest energy efficiency in summer according to study, the west side is more important to shade than east side because of the need of trees shade afternoon more than early morning. As well as, south side of building provides the lowest energy efficiency in summer.
- The effect of planting trees in south side on energy consumption in winter is the highest comparing with east and west sides.
- Energy savings in summer increased by about 2.57%, 1.93%, 1.62% and 1.52% for planting vase, umbrella, oval, and rounded respectively in the east side of building.

- Energy consumption in winter increased by about 2.32%, 2.10%, 1.73% and 1.62% for planting vase, umbrella, oval, and rounded respectively in the south side of building.
- Energy saving values in summer increased as tree is getting close to the building side while energy consumption values increased in winter.
- The increasing energy saving values in summer as a result of changing distances on east and west sides is higher than the increasing energy consumption as a result of changing distances on south side.
- Planting trees on the southern edge of east and west sides of building provides the greatest energy saving in summer comparing to the center and northern edge of building. While planting it on the eastern edge of south side of building have greater energy saving than façade center and western edge.
- The reduction in cooling loads values increase as tree cast greater amount of shade on window than exterior walls. Hence, solar gain by windows is greater than it by wall.
- Energy saving values in summer increases as tree crown size is getting bigger while energy consumption values increases in winter.
- Increasing planting trees number in east and west side are more affected than it in south side.
- The reduction in cooling loads in summer increase by about 15%-23% for increasing trees number between three and eight trees in the best locations. While increasing in energy reduction in summer is higher than the increasing in energy consumption in winter.
- Annual energy reduction increase by about 10-18% for increasing trees number between three and eight trees.
- For changing building orientation from (0N) to (45N), energy saving in summer as a result of the effect of planting trees on building facade increase.
- For changing building orientation from (0N) to (45N), energy consumption in winter as a result of the effect of planting trees near building facades is not remarkable.
- As a result of increasing building height, the effect of tree on energy saving and consumption decrease in summer and winter respectively.
- The effect of tree shade on the lower floors of building is more remarkable than upper floors.
- The ability of trees to enhance street microclimate depends upon trees geometries, trees size, trees height, and trees rows number and its locations.
- Vase and high trunk umbrella are the most trees types that are compatible with energy saving purpose and the physical needs of street.

- As trees rows number increase in particular street, about 5-10% of energy saving in summer increase for surrounding buildings.
- Street with north-south orientation is the most street affected by trees comparing with other orientations.

## 6.1 Recommendations

After conducting the current study that focused on finding out the best trees configurations for the purpose of energy conservation, valuable recommendations were emerged to the municipalities, community, planners and engineers, which can be summarized as to:

- Reduce heat transfer between buildings and surrounding environment to achieve thermal balance by utilization passive solar design techniques.
- Design energy efficient buildings by utilization surrounding elements with good manner in term of climatic factors.
- Utilize the advantages and benefits of trees for the purpose of energy saving and thermal comfort.
- Understand the purpose of planting trees in any locations to choose right tree and plant it in right place with right number.
- Plant trees with high spreading crowns such as vase and high trunk umbrella near residential buildings for the purpose of energy saving in summer.
- For the purpose of achieving thermal comfort in summer and winter, deciduous trees are more recommended to plant than evergreen trees.
- The west and east side of building are more important to shade by trees than south, so it is recommended to plant trees near west and east sides for the purpose of energy saving in summer and winter.
- Choose tree size in maturity that suitable with building's volume and height to give sizable shade on its facades.
- Plant tree within 2m-3m far from building side to provide the largest amount of shade and avoid the conflicts with building foundations.
- Increase trees number if it is not affect other adjacent buildings and don't hinder views and lights.
- Shade air-conditioner to reduce energy use, but not close to allow air flow around unit.
- In the street, keep trees away from overhead power lines and don't plant directly above underground water and sewer lines.



- Plant trees row on south pavement of building for east-west street orientation, while it is recommended to plant trees rows on east and west pavements of building for north-south street orientation.
- Plant high spreading and large trees on the street to provide full shade and don't hinder vision and movement.
- Plant deciduous fruitful trees near residential buildings inside plot area, while it is preferable to plant deciduous fruitless shading trees in the street.
- Finally, Palm, Almond trees, Apricot, Peach, Walnut, White Mulberry, and Edible Fig are preferred to plant inside residential building plot, where Poinciana, Jacaranda, Palm, and Crape myrtle are preferred to plant in street pavements.

## References

- Abed H., 2012, effects of building form on the thermal performance of residential complexes in the Mediterranean climate of the Gaza Strip, master thesis, architecture program, Islamic University, Gaza
- Abu-Hafeetha M., 2009, Planning for Solar Energy as an Energy Option for Palestine, master program, An-Najah National University, Nablus, Palestine.
- Ajluni, S., UNRWA briefing paper, 2010, “West Bank and Gaza Strip population census of 2007”.
- Akbari, H., 2005, Energy Saving Potentials and Air Quality Benefits of Urban Heat Island Mitigation, Lawrence Berkeley National Laboratory, 510, P: 486-4287
- Akbari H., 2002, “Shade trees reduce building energy use and CO2 emissions from power plants”, Environmental Pollution, Vol. 116, P: 119–126.
- Akbari, H., Taha H., Pomerantz M., 2001, cool surfaces and shade trees to reduce energy use and improve air quality in urban areas, Solar Energy Vol. 70, No. 3, pp. 295–310.
- Akbari H., Kurn D.M., Bretz S.E., Hanford J.W., 1997, Peak power and cooling energy savings of shade trees, Energy and Buildings 25 (1997) 139-148.
- Akbari H., Davis S., Dorsano S., Huang J., & Winnett S., 1992, cooling our communities, guide book on tree planting and light color surfaces, U.S environmental protection agency, Washington D.C., Lawrence Berkeley laboratory.
- Akbari H., Rosenfeld A.H., and Taha H., 1990, “summer heat islands, urban trees and white surfaces”, Center of building science, University of California, Berkeley, ASHRAE Transactions 96, Vol. 1, P: 1381-1388.
- Anderson B. and Wells M., 2011, Passive Solar Energy -- The Homeowner's Guide to Natural Heating and Cooling, chapter 2, available at: <http://www.builditsolar.com/Projects/SolarHomes/PasSolEnergyBk/PSEbook.htm>, accessed in: June 4 2012.
- Applied Research Institute (ARIJ), September 2003, Climatic Zoning for Energy Efficient Buildings in the Palestinian Territories (the West Bank and Gaza), Technical Report.
- Arborillogical Services Inc., 2012, the benefits of trees, retrieved 13 June 2012 from: <http://www.arborillogical.com/tree-knowledge-articles-publications/benefits-of-trees/>.
- Airhart D.L., and Zimmerman G., 7 November 2003, the Right Tree for the Right Place, available at: [http://www.tlcfortrees.info/right\\_tree.htm](http://www.tlcfortrees.info/right_tree.htm), accessed in: 20 June 2012.
- Autodesk Ecotect Analysis, 2012, available at: <http://usa.autodesk.com/ecotect-analysis/>, accessed in: 13 November 2012.

Arizona State University, 2002, Visualizing Thermal Comfort, available at: [http://support.caed.asu.edu/radiant/01\\_thermalComfort/comfortC\\_01variables.htm](http://support.caed.asu.edu/radiant/01_thermalComfort/comfortC_01variables.htm), accessed in 6 January 2013.

Baris, M. E., Sahin, S. and Yazgan, M. E. (2009), the contribution of trees and green spaces to the urban climate: The case of Ankara, African Journal of Agricultural Research, Vol. 4, NO.9, P: 791-800.

Beychok M.R., 1967, Aqueous Wastes from Petroleum and Petrochemical Plants, First edition, John Wiley and Sons, USA.

Blacksmith Institute, September 2007, Report about: the world's worst polluted places, New York, available at: [www.blacksmithinstitute.org](http://www.blacksmithinstitute.org), accessed in: 13 June 2012

Brack C.L., and Wood G.B., 29 November 1996, Tree growth and increment, available at: [http://fennerschool-associated.anu.edu.au/mensuration/BrackandWood1998/T\\_GROWTH.HTM](http://fennerschool-associated.anu.edu.au/mensuration/BrackandWood1998/T_GROWTH.HTM), accessed in: 21 June 2012

Brown, R.D., Gillespie, T.J., 1995, Microclimate Landscape Design: Creating Thermal Comfort and Energy Efficiency, John Wiley & Sons, New York.

California Polytechnic State University, and the Cal Poly Corporation, 1995-2012, Select tree, available at: <http://selecttree.calpoly.edu/treedetail.lasso?rid=1299&-session=selectree:B03A413B111e002906HyX391DC68> accessed in: 10 July 2012

California University College Prep, Sep 25 2009, Non-renewable energy resources, available at: <http://cnx.org/content/m16730/latest/>, accessed in: May 11 2012.

Camilloni I., and Barros V., 1997, on the urban heat island effect dependence on temperature trends, Climatic Change, Vol. 37, No. 4: P 665–681.

Carson L.R., 1962, First Edition, Silent Spring, New York, USA

Central Intelligence Agency, April 11 2012, the world fact book: Gaza Strip, available at: <https://www.cia.gov/library/publications/the-world-factbook/geos/gz.html>, accessed in: May 12 2012.

Champiat, C. (2009), Heat island analysis to reduce the public health impact of heat waves, Environnement Risques & Sante, Vol. 8, NO.5, P: 399-411.

Chartered Institution of Building Services Engineers (CIBSE), 1999, Environmental design-CIBSE Guide (A), London.

Chen J., Saunders S., Crow T., Naiman R., Brosofske K., Mr.oz G., Brookshire B., and Franklin J., 1999, Microclimate in Forest Ecosystem and Landscape Ecology, BioScience Vol. 49, No. 4, P: 288-297.

Chiras D.D., 2002, the solar house passive cooling and heating, first edition, Chelsea green publishing company, Vermont, Canada, P. 10.

City of boulder office, 2009, calculating the value of Boulder's urban forest, technical report, available at: [bcn.boulder.co.us/basin/boulder/](http://bcn.boulder.co.us/basin/boulder/), access in 19 February 2012.

D&R International, Ltd., 2012, 2011 Buildings Energy Data Book, U.S., prepared under Pacific Northwest National Laboratory.

Department of Labor-New Zealand, January 2007, Health Bulletin - Physical Hazards Fact sheet - Thermal Comfort Project, available at: <http://www.osh.dol.govt.nz/publications/series/hb-21-thermalcomfort.html>, accessed in: 3 June 2012.

DesignBuilder Software Ltd, 2012, available at: <http://www.designbuilder.co.uk/content/view/43/64/>, accessed in: 19 August 2012.

Droege P., 2009, project S4G-solar for Gaza, institute of architecture and planning, Hochschule Liechtenstein, Germany.

Donovan G.H., Butry D.J., 2009, the value of shade: estimating the effect of urban trees on summertime electricity use, energy and building, Vol. 41, P: 662-668.

Edwards B., 2002, rough guide to sustainability, published by RIBA, London, P: 21-26.

Theis T. and Tomkin J., 29 Feb. 2012, U of I Open Source Textbook, Sustainability: A Comprehensive Foundation, available at: <http://cnx.org/content/col11325/1.36/>, access in 3 October 2012.

Frank T., 2005, climate change impacts on building heating and cooling energy demand in Switzerland, Energy and Buildings, Vol. 37, P: 1175-1185.

Fahmy M., sharples S., and yahiya M., 2010, LAI based trees selection for mid latitude urban developments: A microclimatic study in Cairo, Egypt, Building and Environment, Vol. 45, P: 345-357

Fahmy M., sharples S., and Eltrapolsi A., 2009, the dual stage simulations to study the microclimatic effects of trees on thermal comfort in a residential building, Cairo-Egypt, 11th international IBPSA conference, Glasgow-Scotland

Fontoynt M, Tsangrassoulis A., and Synnefa A., 2004, SynthLight Handbook Chapter 2: Day lighting, available at: <http://www.new-learn.info/packages/synthlight/handbook/doc/chapter2.pdf>, accessed in: June 7 2012.

Federer C.A., 1976, trees modify the urban microclimate, journal of arboriculture, Vol. 2, No. 7, P: 121-127.

PENRA (Palestinian Energy and Natural Resources Authority), 06-07-2012, interview with Eng Awni Naeim.

Georgi J.N. and Dimitriou D., 2010, the contribution of urban green spaces to the improvement of environment in cities: Case study of Chain, Greece, Building and Environment, Vol. 45, P: 1401-1414.

- Gilman E. F. and Sadowski L., 2007, Choosing Suitable Trees for Urban and Suburban Sites: Site Evaluation and Species Selection, Institute of Food and Agricultural Sciences, University of Florida, available at: <http://edis.ifas.ufl.edu/>, accessed in: May 5 2012.
- Giridharan R., Lau S., and Ganesan S., 2005, “Nocturnal heat island effect in urban residential developments of Hong Kong”, *Energy and Buildings*, Vol. 37, P: 964–971.
- Guana L., 2009, “preparation of future weather data to study the impact of climate change on buildings”, *Building and Environment*, Vol.44, P: 793-800.
- Gulati K., Banerjee B., BalaLall S., and Ray A., 2010, Effect of diesel exhaust, heavy metals and pesticides on various organ system: possible mechanism and strategies for prevention and treatment, *Indian Journal of experimental Biology*, Vol. 48, P: 710-721
- Hadid A., 2002, Architectural Styles Survey in Palestinian Territories, Establishing, Adoption, and Implementation of Energy Codes for Building
- Heisler G. M., 1977, trees modify metropolitan climate and noise, *journal of arboriculture*, Vol.3, No.11, P: 201-207.
- Hensen J. L.M., 1991, On the thermal interaction of building structure and heating and ventilating system, Technische University, Eindhoven, Germany.
- Hirano Y., Fujita T., 2012, Evaluation of the impact of the urban heat island on residential and commercial energy consumption in Tokyo, *Energy*, Vol. 37, P: 371-383.
- International Society of Arboriculture, 2005, Benefits of Trees, available at: [http://www.treesaregood.com/treecare/tree\\_benefits.aspx](http://www.treesaregood.com/treecare/tree_benefits.aspx), accessed in: May 8, 2012.
- Japan Metrological Agency, May 16, 2007, Available at: <http://www.data.jma.go.jp/>, accessed in: May 8, 2012.
- Kevin & Pat, 2009, Guide to size and type of trees to buy, Thornhayes Nursery, available at: <http://www.thornhayes-nursery.co.uk/terms.php> accessed in: 20 June 2012.
- Khan M.A, and Ghouri A.M., 2011, Environmental Pollution: Its Effects on Life and Its Remedies, *Journal of Arts, Science & Commerce*, Vol. 2, P: 276-285
- Kolokotroni M., and Giridharan R., 2008, urban heat island intensity in London: An investigation of the impact of physical characteristics on changes in outdoor air temperature during summer, *Solar Energy*, Vol. 82, P: 986–998.
- Kottek M, Grieser J., Beck C., Rudolf B., and Rubel F., 2006, World Map of the Köppen-Geiger climate classification updated, *Meteorologische Zeitschrift*, Vol. 15, No. 3, P: 259-263
- kotzen B., 2003, An investigation of shade under six different tree species of the Negev desert towards their potential use for enhancing micro-climatic conditions in landscape architectural development, *Journal of Arid Environments*, Vol. 55, P: 231–274.

Lee H. Y., 1993, An application of NOAA AVHRR thermal data to the study of urban heat islands, atmospheric Environment, Part B. Urban Atmosphere, Vol. 27, No. 1, P: 1–13.

Leahy S., Oct 23 2008, Worst Forms of Pollution Killing Millions, available at: IPS <http://ipsnews.net/news.asp?idnews=44415>, accessed in: May 9, 2012.

Le Treut H., Somerville R., Cubasch U., Ding Y., Mauritzen C., Mokssit A., Peterson T. and Prather M., 2007, Historical Overview of Climate Change, Contribution of Working Group I to the Fourth Assessment Report of the Intergovernmental Panel on Climate Change, Cambridge University Press, Cambridge, United Kingdom and New York, USA.

Long C., and Sayma N., 2009, heat transfer, published by Ventus Publishing ApS.

Marsh A., 2003, ECOTECT and EnergyPlus, Building Energy Simulation User News, Vol 24, No. 6, available at: <http://ecodesign.blogs.midilibre.com/list/documentation/1610506560.pdf>, accessed in: 19 September 2012.

Mazza C., August 10 2010, Microclimates, Cornell University, available at: [www.gardening.cornell.edu/weather/microcli.html](http://www.gardening.cornell.edu/weather/microcli.html), accessed in: May 1, 2012.

McPherson E.G., Xiao Q., Wu C., 2008, a method for locating potential tree-planting sites in urban areas: A case study of Los Angeles, USA, Urban Forestry & Urban Greening, Vol. 7, P: 65–76.

McPherson E. G., Simpson J. R., and Peper P. J., 2001, “Tree Guidelines for Inland Empire Communities”, Western Center for Urban Forest Research and Education, USDA Forest Service, Pacific Southwest Research Station, A Publication of the Local Government Commission.

McPherson E.G., Heisler G.M., and Herrington L.P., 1988, impacts of vegetation on residential heating and cooling, energy and buildings, Vol. 12, P: 41-51.

Melo A.P., and Lamberts R., 2009, envelope insulation and heat balance in commercial buildings, building simulation, Eleventh International IBPSA Conference Glasgow, Scotland

Meerow A.W. and R.J. Black, 1993, Envirosaping to Conserve Energy: a Guide to Microclimate Modification, University of Florida, USA

Michaels T. and Reed D., 2012, a comprehensive guide to growing vegetables, published by Tess Michaels & David Reed at Smashwords, Australia.

Mikler V., Bicol A., Labrie M., and Breisnes B., 2008, City of Vancouver-Passive Design Toolkit - Best Practices, available at: <http://vancouver.ca/sustainability/documents/PassiveDesignToolkit.pdf>, accessed in: June 3 2012.

Ministry of local government, 10-06-2012, interview with Eng. Subhi Skieaik.

Ministry of Local Government, 2004, Palestinian Guidelines for Energy Efficient, Bailasan company-Ramallah, Palestine

Minnesota Department of Commerce Energy Information Center, 2012 “save energy with tree”, Home energy Guide, Minnesota, available at: <http://www.docstoc.com/docs/37450717/Energy-Saving-Landscapes---Landscaping-503>, accessed in: June 3 2012.

Misni A., and Allan P., 2010, sustainable residential building issues in urban heat islands-the potential of albedo and vegetation, scientific student paper, Wellington, New Zealand

Muhaisen A., 2007, “the energy problem in Gaza Strip and its potential solution”, Energy and environment protection in sustainable development conference ICEEP, Palestine polytechnic university, Hebron, Palestine

Morris C.J.G., July 9 2006, Urban Heat Islands and Climate Change - Melbourne, Australia, University of Melbourne, available at: <http://www.earthsci.unimelb.edu.au/~jon/WWW/uhi-melb.html>, accessed in: May 8 2012.

Morrissey J., Moore T., and Horn R.E., 2011, Affordable passive solar design in a temperate climate: An experiment in residential building orientation, Renewable Energy, Vol. 36, P: 568-577.

Neufert E., Neufert P., Baiche B., and Walliman N., 2000, Neufert Architects' Data, Blackwell Publishing company, Third Edition, P 176.

National Renewable Energy Laboratory (NREL), and DOE National Laboratory, April 1995, landscaping for energy efficiency, retrieved 16 June 2012 from <http://www.nrel.gov/docs/legosti/old/16632.pdf>.

Nowak, D.J., 1995, “the effects of urban trees on air quality”, USDA Forest Service, Syracuse, NY.

Nowak D.J., Dwyer J.F., 2000, understanding the benefits and cost of urban forest ecosystem, hand book of urban and community forestry in north east, New York, kluwer academic, plenum publishers, P: 11-25.

Ochoa C.E., and Capeluto I.G., 2008, strategic decision-making for intelligent buildings: comparative impact of passive strategies and active features in a hot climate, building and environment, Vol. 43, P: 1829-1839.

Open street map, 2012, available at: <http://www.openstreetmap.org/>, accessed in: 13 October 2012

Oke T. R, 1982, the energetic basis of the urban heat island, Quarterly Journal of the Royal Meteorological Society, Vol.108, No. 455, P: 1–24

Omer A.M., 2008, Renewable building energy systems and passive human comfort solutions, Renewable and Sustainable Energy Reviews, Vol. 12, P: 1562–1587

Paipai A., 2006, Computational Assessment of Passive Cooling Methods in Buildings, MSc Program "Building Science & Technology", Vienna

Palestinians Central Bureau of Statistics, 2010-2011, Energy Use in Household, available at: <http://www.pcbs.gov.ps/site/706/default.aspx>, accessed in: May 12 2012.

Palestinian Central Bureau of Statistics, Nov. 2009, Brochure results of population- Population, Housing & Establishment Censuses, 2007, available at: <http://www.pcbs.gov.ps/DesktopDefault.aspx?tabID=3354&lang=en>, accessed in: May 12 2012.

Palestinian national plan, 2011, energy sector strategy, Report to Palestinian authority

Pandit R., and Laband D.N, 2010, energy savings from tree shade, Ecological Economics, Vol. 69, P: 1324–1329

Parker, J.H., 1983, The Effectiveness of Vegetation on Residential Cooling, Passive Solar Journal, Vol. 2, P: 123-132.

Parish R., 1948, learning to recognize trees of British Columbia, second edition, published by Canadian Forest Service, Canada, P: 6-7.

Pe´rez-Lombard L., Ortiz J., and Pout C., 2008, a review on buildings energy consumption information, Energy and Buildings, Vol. 40, P: 394-398

Prek M., 2006, Thermodynamical analysis of human thermal comfort, Energy, Vol. 31, P: 732–743.

Ouda M., 2012, a look at household energy consumption in Gaza Strip, Electrical & Computer Engineering Department, Islamic university, Palestine

Raba K., 2005, Development of energy-efficient passive solar building design in Nicosia Cyprus, Renewable Energy, Vol. 30, P: 937–956.

Reardon C., 2010, passive design, Australia's guide to environmentally sustainable homes, available at: <http://www.yourhome.gov.au/technical/fs46.html>, accessed in: June 4 2012.

Roaf S., Fentes M., and Thomas S., 2001, eco house: a design guide, first published, Architectural Press, Published by: A division of Reed Educational and Professional Publishing Ltd, Oxford.

Rosenzweig, C., Solecki, W. D., Parshall, I., Iynn, B., Cox, J., Goldberg, R., Hodges, S., Gaffin, S., Slosberg, R.B., Savio, P., Dunstan, F. and Watson, M., (2009), mitigating new York city's heat island integrating stakeholder perspectives and scientific evaluation, bulletin of the American meteorological society, Vol. 90, NO.9, P: 1297-1312.

Ritter, M., 2009, the Physical Environment: an Introduction to Physical Geography, available at: [http://www.uwsp.edu/geo/faculty/ritter/geog101/textbook/title\\_page.html](http://www.uwsp.edu/geo/faculty/ritter/geog101/textbook/title_page.html), accessed in: May 6, 2012.



Sato A., 2010, Impacts of Climate Policy on Urban Air Pollution: Implications for Policy Design for Integrating Air-quality Co-benefits, Master of Science in Technology and Policy, Massachusetts Institute of Technology.

Sarajevs V., 2011, health benefits of street trees, the research agency of the forestry commission.

Sass R. L., 2012, it's not cool to be hot in Houston, Rice University Houston, available at: <http://www.ruf.rice.edu/~sass/UHI.html>, accessed in: May 8 2012.

Scott J.L., and Betters D.R., 2000, economic analysis of urban tree replacement decisions, Journal of Arboriculture, Vol. 26, NO.2

Scufr&I, 2004, a manual for the State Forestry Agencies in the Southern Region-urban forestry, Unit: Site and Tree Selection, Publisher: USDA Forest Service and Southern Center for Urban Forest Research & Information, U.S.

Shahmohamadi P., Che-Ani A.I., Etessam I., Maulud K.N.A., and Tawil N.M., 2011, Healthy Environment: The Need to Mitigate Urban Heat Island Effects on Human Health, Procedia Engineering, Vol. 20, P: 61-70

Shahidan M., Shariff M., Jones P., Salleh E., Abdullah A., 2010, A comparison of Mesua ferrea L. and Hura crepitans L. for shade creation and radiation modification in improving thermal comfort, Landscape and Urban Planning, Vol. 97, P: 168–181.

Shepherd J. M., Shindell D., and Carroll C. M., August 4 2008, what's the Difference between Weather and Climate, available at: [http://www.nasa.gov/mission\\_pages/noaa-n/climate/climate\\_weather.html](http://www.nasa.gov/mission_pages/noaa-n/climate/climate_weather.html), accessed in: May 5, 2012.

Solecki W.D., Rosenzweig C., Pope G., Chopping M., Goldberg R., and Polissar A., 2004, Urban Heat Island and Climate Change: An Assessment of Interacting and Possible Adaptations in the Camden, New Jersey Region, Division of Science, Research and Technology, available at: <http://www.state.nj.us/dep/dsr/>, accessed in: May 5, 2012.

Strand R.K., Pedersen C.O., and Crawley D.B., 2001, modularization and simulation techniques for heat balance based energy and load calculation programs: the experience of the ASHRAE loads toolkit and energy plus, building simulation, Seventh International IBPSA Conference, Rio de Janeiro, Brazil.

Strother E.A.V., Ham D.L., and Gilland L, 2012, Urban Forest Management Plan Toolkit -South Carolina urban tree species guide, Urban Forests Council, and the Inland Urban Forest Council., retrieved 20 June 2012 from< <http://ufmptoolkit.com/resources-UFMT-choosing-trees.htm>>, California.

Simpson J.R., McPherson E.G., 1998, Simulation of tree shade impacts on residential energy use for space conditioning in Sacramento, Atmospheric Environment, Vol. 32, No. 1, P: 69–74.

Szokolay S., 2008, introduction to architectural science the basis of sustainable design, published by Elsevier Ltd. Science and technology, second edition, UK.

Taha, H., 1997. Urban climates and heat islands: albedo, evapotranspiration, and anthropogenic heat, *Energy and Buildings*, Vol. 25, NO. 2, P: 99–103.

The Arbor Day Foundation, 2012, choosing the right tree, available at: <http://www.arborday.org/trees/index-choosing.cfm>, accessed in: 21 June 2012.

Trenberth K.E., Jones P.D., Ambenje P., Bojariu R., Easterling D., Klein Tank A., Parker D., Rahimzadeh F., Renwick J.A., Rusticucci M., Soden B. and Zhai P., 2007, *Observations: Surface and Atmospheric Climate Change*, Contribution of Working Group I to the Fourth Assessment Report of the Intergovernmental Panel on Climate Change, Cambridge University Press, Cambridge, United Kingdom and New York, USA.

U.S. Department of Energy and U.S. government, 2012, Weather Data, available at: [http://apps1.eere.energy.gov/buildings/energyplus/weatherdata\\_about.cfm](http://apps1.eere.energy.gov/buildings/energyplus/weatherdata_about.cfm) accessed in: 19 July 2012.

United Nations Environment Program, 16 June 1972, Declaration of the United Nations Conference on the Human Environment, Stockholm, available at: <http://www.unep.org/Documents.Multilingual/Default.asp?documentid=97&articleid=1503>, accessed in: June 5, 2012

Cappiella K., Schueler T., and Wright T., 2006, *Urban Watershed Forestry Manual-Part 2: Conserving and Planting Trees at Development Sites*, United States Department of Agriculture, Forest Service, Northeastern Area.

Urban green, 28 October 2007, Parts of a tree, available at: <http://blocs.xtec.cat/seashell/2007/10/28/12/> accessed in: 27 June 2012.

USAD forest service, April 1990, Benefits of Urban Trees, available at: <http://www.state.sc.us/forest/urbben.htm> access in: 13 June 2012.

Valsalakumari P.K., Rajeevan P.K., Sudhadevi P.K., Geetha C.K., 2008, *flowering trees*, new India publishing agency, New Delhi, India.

Vermont Urban & Community Forestry Program, 2001, Vermont Tree Selection Guide, the Vermont Department of Forests, Parks & Recreation and Vermont University, USDA Forest Service, USA, available at: [www.vtcommunityforestry.org](http://www.vtcommunityforestry.org), accessed in: July 5, 2012

Wong E., 2008, reducing urban heat islands: compendium of strategies trees and vegetation, Environmental Protection Agency's Office of Atmospheric Programs (EPA)-Draft sheet, available at: <http://www.epa.gov/hiri/resources/pdf/TreesandVegCompendium.pdf> accessed in: 16 June 2012.

World Health Organization (WHO), 2000, Indoor air pollution, available at: [http://www.who.int/indoorair/health\\_impacts/disease/en/index.html](http://www.who.int/indoorair/health_impacts/disease/en/index.html), accessed in: June 5, 2012

Yasin A., 2008, Optimal Operation Strategy and Economic Analysis of Rural Electrification of Atouf Village by Electric Network, Diesel Generator and Photovoltaic System, master program, Najah National University, Nablus-Palestine.

Engineering office, 12 July 2012, interview with agriculture engineer: Mohammed El Hennawi, Islamic University, Gaza, Palestine.

## Appendix A: The Popular Trees Types in Palestine




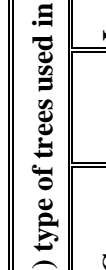

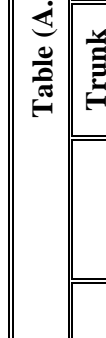

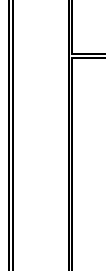
Table (A.1) type of trees used in landscaping in Palestine										
Name	Form	Height (m)	Trunk Diameter (m)	Canopy Spread	Foliage	Longevity (year)	Fruits & Flowers	Tolerant		Image
								Wind	Shade	
Silk Oak ( <i>Grevillia robusta</i> )	Conical or oval	15-20	0.6	10-15	Ever-green	50-150	Orange Yellow flowers, Brown Podlike with Winged Follicles	*	Dense leaf 	
Holly Oak ( <i>Quercus ilex</i> )	round or umbrella <sup>a</sup>	21	0.55	28-30	Ever-green	Greater than 150	Unclear flower, Brown Acorn	*	Dense leaf 	
Sycamore Maple ( <i>Acer pseudo-antanus</i> )	round or oval	18-21	0.4-0.5	12-18	Decid-uous	50-150	Green Yellow flowers-unclear fruits	*	Moderlea f 	
Carob ( <i>Ceratonia siliqua</i> )	round or umbrella <sup>a</sup>	10	0.6	20	Ever-green	Greater than 150	Red flowers, Prolific, Brown Pod	*	Dense leaf 	

Table (A.1) type of trees used in landscaping in Palestine






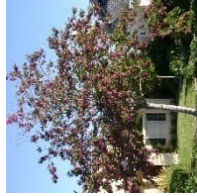


Name	Form	Height (m)	Trunk Diameter (m)	Canopy Spread	Foliage	Longevity (year)	Fruits & Flowers	Tolerant		Image
								Wind	Shade	
Oriental Plane ( <i>Platanus orientalis</i> )	Rounded, umbrella or oval	21-30	0.6	12-30	Deciduous	50-150	Unclear flower, Prolific, Brown Mostly Green Achene	*	Dense leaf 	
Black Locust ( <i>Robinia pseudoacacia</i> )	Oval	20	0.6	10-20	Deciduous	Greater than 150	Showy, Fragrant, White flowers, Brown Pod	*	Moderlea f 	
Idaho Locust ( <i>Robinia ambigua</i> )	Oval	12-15	0.6	6	Deciduous	50-150	Showy, pink, purple rose, Brown Pod	*	Low leaf 	
Japanese Pagoda Tree ( <i>Sophora japonica</i> )	Rounded, umbrella or vase	7-15	0.5	6	Deciduous	50-150	Showy, Fragrant, White Brown Green Pod	*	Moderlea f 	



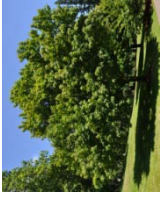









Table (A.1) type of trees used in landscaping in Palestine										
Name	Form	Height (m)	Trunk Diameter (m)	Canopy Spread	Foliage	Longevity (year)	Fruits & Flowers	Tolerant		Image
								Wind	Shade	
Horse Chestnut ( <i>Aesculus hippocastanum</i> )	Rounded	15-20	0.55	10-12	Deciduous	50-150	Showy, Fragrant, Cream flowers, Brown Capsule fruits	*	Dense leaf	
California Fan Palm ( <i>Washingtonia filifera</i> )	Fan Palm	15-20	0.45	4	Evergreen	50-150	Unclear flowers, Black Drupe fruits	-	Dense leaf	
Norway Maple ( <i>Acer platanoides</i> )	Rounded	6-20	0.4-0.5	15	Deciduous	50-150	Green Yellow flowers, Brown Winged Seed	*	Moderate	
Wild Pistachio ( <i>Pistacia atlantica</i> )	round or oval	10	0.6	7	Deciduous	50-150	Unclear flowers, Purple Mostly Blue Drupe	*	Dense leaf	

Table (A.1) type of trees used in landscaping in Palestine										
Name	Form	Height (m)	Trunk Diameter (m)	Canopy Spread	Foliage	Longevity (year)	Fruits & Flowers	Tolerant		Image
								Wind	Shade	
Palestine Live Oak (Quercus calliprinos)	Rounded	15-20	0.45	10	Ever-green	50-150	Green flowers, Acorn ovoid	*	Dense leaf 	
Red Gum (Eucalyptus camaldulanis)	Rounded or oval	12-45	0.45	15-30	Ever-green	50-150	Yellow, White flowers, Brown, or Green Capsule	*	Moderlea f 	
Cypress (Cupressus sempervirens)	Column	15	0.3	15	Ever-green	50-150	Unclear flowers, Brown Cone	*	Moderlea f 	
Aleppo Pine (Pinus halapensis)	Conical	20	0.8	25	Ever-green	Greater than 150	Unclear flowers, Brown, Yellow, Green Cone	*	Moderlea f 	

**Table (A.1) type of trees used in landscaping in Palestine**








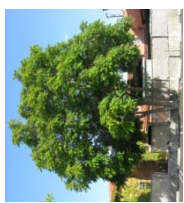

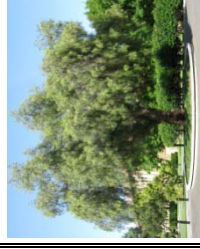

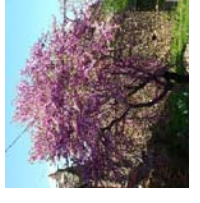




Name	Form	Height (m)	Trunk Diameter (m)	Canopy Spread	Foliage	Longevity (year)	Fruits & Flowers	Tolerant		Image
								Wind	Shade	
Poplar (Populus nigra italica )	Column	12-30	0.8	4-9	Deciduous	40-150	Unclear flower, Brown Capsule	*	Moderlea f 	
Populus alb (White Poplar)	Rounded, umbrella or vase	20	0.4	12	Deciduous	40-150	Unclear flower, Brown Capsule	*	Moderlea f 	
Weeping Willow( Salix babylonica)	Oval, rounded or umbrella	10-15	0.6	5-20	Deciduous	Less than 50	Unclear flower, Brown Capsule	*	Dense leaf 	
Tree of Heaven (Ailanthus altissima)	Oval, rounded or umbrella	15	0.8	15	Deciduous	Less than 50	Prolific, Red or Yellow Winged Seed	*	Dense leaf 	



Table (A.1) type of trees used in landscaping in Palestine

Name	Form	Height (m)	Trunk Diameter (m)	Canopy Spread	Foliage	Longevity (year)	Fruits & Flowers	Tolerant		Image
								Wind	Shade	
Pepper Tree (Schinus molle)	Rounded or umbrella	15	1.4	22	Ever-green	50-150	Fragrant, yellow white flower, Prolific, Rose Drupe	*	Moderlea f 	
Judas Tree (Cersis siliquastrum)	Oval, rounded or umbrella	10	0.4	12-15	Decid-uous	50-150	Showy, Purple or Rose flower, Brown Pod	*	Moderlea f 	
Olive tree(Oleo europaea )	Rounde, umbrella or vase	10	0.6	10-15	Ever-green	Greater than 150	Green Drupe	*	Moderlea f 	
Apricot (Prunus armeniaca)	Rounde, umbrella or vase	7	0.4	10	Decid-uous	50-150	Pink or White flowers Orange Drupe	*	Dense leaf 	

**Table (A.1) type of trees used in landscaping in Palestine**




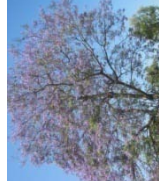




Name	Form	Height (m)	Trunk Diameter (m)	Canopy Spread	Foliage	Longevity (year)	Fruits & Flowers	Tolerant		Image
								Wind	Shade	
Poinciana (Delonix Regia)	Vase or umbrella	10-12	0.4	6-18	Deciduous	50-150	Red or Orange flowers,	*	Moderlea f 	
Jacaranda (Jacaranda Mimosifolia)	Oval, rounded, umbrella or vase	12-15	0.4	20-22	Deciduous	40-150	Unclear flower, Brown Acorn	*	Moderlea f 	
Crape myrtle (Lagerstroemia Indica)	Oval, rounded, umbrella or vase	7-10	0.3-0.4	12	Deciduous	50-150	Lavender, Pink, Red, Rose or White flowers-	*	Moderlea f 	
Chinaberry (Melia azedarach)	Oval, Rounded or Umbrella	10-15	0.6-0.7	18	Deciduous	40-150	Fragrant, Lavender, flowers Yellow Berry	*	Dense leaf 	






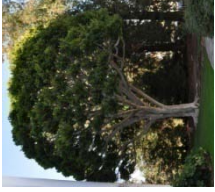



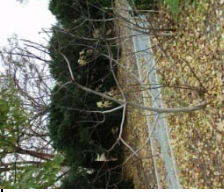






Table (A.1) type of trees used in landscaping in Palestine										
Name	Form	Height (m)	Trunk Diameter (m)	Canopy Spread	Foliage	Longevity (year)	Fruits & Flowers	Tolerant		Image
								Wind	Shade	
Weeping fig (Ficus benjamina)	Oval	10	0.35	10-15	Ever-green	40-150	Unclear flower, Red Follicle	*	Moderlea f 	
Rubber Tree (Ficus Elastica)	Oval	7	0.60	10-15	Ever-green	40-150	Unclear flower, Green fruits	*	Moderlea f 	
Indian Laurel (Ficus Microcarpa Var. Nitida)	round or oval	7	0.60	10-12	Ever-green	50-150	Unclear flower, Green Follicle fruits	*	Dense leaf 	
Roxburgh Fig (Ficus auriculata)	round or oval	7	0.60	10-12	Decid-uous	40-150	Unclear flower, Green Follicle	*	Low leaf 	

Table (A.1) type of trees used in landscaping in Palestine										
Name	Form	Height (m)	Trunk Diameter (m)	Canopy spread	Foliage	Longevity (year)	Fruits & Flowers	Tolerant		Image
								Wind	Shade	
Edible Fig (Ficus Carica)	Rounded, Umbrella or Vase	7-10	0.6	10-15	Deciduous	50-150	Unclear flowers, Green Follicle	*	Moderlea f 	
Rusty-Leaf Fig (Ficus rubiginosa)	Rounded	15	0.6	10-15	Ever-green	50-150	Unclear flower, Green Follicle	*	Dense leaf 	
Guava (Psidium Guajava)	Oval, Rounded or Vase	6	0.4	10-15	Ever-green	50-150	Yellow Berry fruits	*	Moderlea f 	
Canary Island Date Palm (Phoenix Canariensis)	Feather Palm	20	0.6	8	Ever-green	50-150	Orange or Yellow Drupe	*	Low leaf 	

## Appendix (B): Thermal Analysis Data

- **Hours of operation:** refer to the hours of operating air-conditioning, cooling, or heating system if the zone is air-conditioned. If the zone is not air-conditioned, hours of operation refer to the hours of occupancy. In this study, cooling system is considered to be operated all day and night in summer months.
- **Internal design condition:** refer to many values of zone condition such as:
  - Clothing level = 0.4 col (shorts and T-shirts) where 1 col=0.155 m<sup>2</sup>.kw<sup>-1</sup>, (CIBSE-guide A, 1999).
  - Humidity = 60% (average percent of humidity in Gaza).
  - Air speed = 0.5 m/s (pleasant breeze in summer).
  - Lightening level = 300 Lux (suitable for residential zones).
- **Active system (HVAC system):** cooling and heating system are chosen in order to determine the cooling and heating loads in summer and winter respectively with and without trees different scenarios.
- **Comfort band:** refer to environmental temperature that range from 18° C to 26° C. this temperature is appropriate for sedentary or near sedentary physical activity levels, (Departement of Labor-New Zelanda, 2007).
- **Occupancy:** refer to maximum number of persons who occupy the zone. The average number of Palestinian family persons is 7 persons according to Palestinian Central Bureau of statistics, (Palestinian Central Bureau of statistics, 2009).
- **Activity:** refer to the nature of work. For most people, daily activity consists of a mixture of specific activities and/or a combination of work and rest periods in residential zones that record 70 W/m<sup>2</sup> or 1.2 met as an average. The met is the unit of physical activity of humans. Where 1 met = 58.2 W.m<sup>-2</sup>, (CIBSE-guide A, 1999).
- **Internal gain:** refer to the amount of thermal radiation exchanged between the surface and its surroundings. The internal heat gain of a building includes the heat generated by occupants (activity), lightening, and equipments, (Utzinger & Wasley, 2005). Activity is considered as separate item in simulated models. This item refers to the internal gain from lightening and equipments (sensible gain). Table (4-2) and (4-3) show the most common appliances and lightening in residential zones:

<b>Table (B.1) Common used appliances in houses and total watts</b>				
<b>Appliance</b>	<b>Number</b>	<b>Watts</b>	<b>Operation period</b>	<b>Total (w)</b>
<b>Personal Computer</b>	2	300	25%	150
<b>Printer</b>	1	150	5%	7.5
<b>Television/ Receiver</b>	1	120	50%	60
<b>Telephone</b>	3	65	10%	19.5
<b>Refrigerator</b>	1	340	100%	340

<b>Kettle</b>	1	2000	10%	200
<b>Microwave</b>	1	1800	2%	36
<b>Oven</b>	1	2000	13%	250
<b>Washing Machine</b>	1	2400	5%	120
<b>Fan</b>	4	40	25%	40
<b>Conditioner</b>	1	2000	40%	800
<b>Radio</b>	2	65	10%	13
<b>Total Watts</b>				2036
<b>Total Watts/m<sup>2</sup></b>				9.0
<b>Table (4-3) Common used lightening in houses and total watts</b>				
<b>Lights</b>	<b>Number</b>	<b>Watts</b>	<b>Operation period</b>	<b>Total (w)</b>
<b>Double Florescent</b>	20	36	25%	180
<b>Circle incandescent</b>	14	60	25%	210
<b>Circle Tenjestene</b>	4	85	10%	34
<b>Total Watts</b>				424
<b>Total Watts/m<sup>2</sup></b>				1.8844444
<b>Total internal gain W/m<sup>2</sup></b>				11

- **Latent gain:** refer to gains due to the evaporation of moisture into air =2 W/m<sup>2</sup>.
- **Infiltration rate:** refer to the value of air exchange between zone and outside environment. This value is measured by air change rate per hour and it equals 1.0 ach/h for well sealed windows in the case of cooling system.

## Appendix C: The effect of increasing trees number on energy consumption

According to the third study in the chapter 4, the rest of analysis of trees increasing number appears as follow:

Four trees locations possibilities appear in figure (C.1). Planting two trees near east side and two in the west has the highest energy savings for vase, umbrella, and rounded trees. Hence, the value of cooling loads reduction as a result of changing four trees locations can be ordered from highest to lowest as follow: 2E2W, 2E1W1S, 2E2S, 3E1W, 3E1S, 2W1E1S, 2W2S, 2S1E1W, 3W1E, 3W1S, 3S1E and finally 3S1W. Therefore, the effect of planting four vase trees on these locations save energy by about 15.93%, 14.66%, 14.11%, 12.25%, 12.52%, 12.26%, 11.26%, 10.26%, 9.74%, 9.18%, 8.31% and 7.48% respectively. The same trend is noticed for umbrella and rounded trees with lowest values.

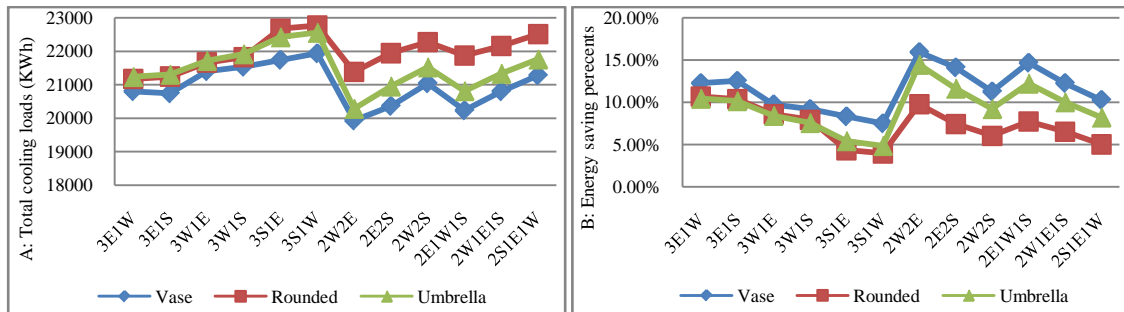


Figure (C.1): The effect of four trees locations possibilities on A: total cooling loads (KWh) and B: Energy savings percents in summer

The results indicate also that planting two trees near east side and two in the west has the lowest incident solar radiation amount for vase, umbrella, and rounded trees. Hence, the value of incident solar radiation reduction as a result of changing two trees locations has the same energy saving trend. Therefore, the effect of planting four vase trees on 2E2W, 2E1W1S, 2E2S, 3E1W, 3E1S, 2W1E1S, 2W2S, 2S1E1W, 3W1E, 3W1S, 3S1E and finally 3S1W blocked incident solar radiation by about 24.83%, 23.98%, 23.23%, 23.86%, 26.07%, 20.89%, 19.98%, 20.08%, 21.36%, 18.87%, 19.08% and 17.35% respectively. The same trend is noticed for umbrella and rounded trees with lowest values. See figure (C.2)

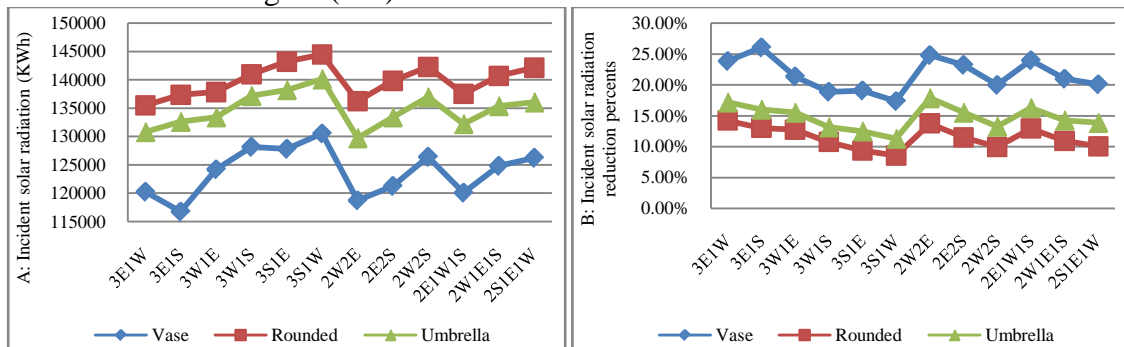


Figure (C.3): The effect of four trees locations possibilities on A: incident solar radiation amount (KWh) and B: incident solar radiation reduction percents in summer

Five trees locations possibilities appear in figure (C.4). Planting two trees near east side, two in the west and one in south has the highest energy savings for vase, umbrella, and rounded trees. Hence, the value of cooling loads reduction as a result of changing two trees locations can be ordered from highest to lowest as follow: 2E2W1S, 3E2W,

3W2E, 2E1W2S, 2E3S, 3E2S, 3E1W1S, 1E2W2S, 2W3S, 3W2S, 3W1E1S and finally 3S1E1W. Therefore, the effect of planting five vase trees on these locations save energy by about 17.84%, 17.01%, 16.50%, 15.66%, 15.12%, 15.03%, 14.15%, 13.60%, 12.25%, 11.72%, 11.63% and 9.91% respectively. The same trend is noticed for umbrella and rounded trees with lowest values.

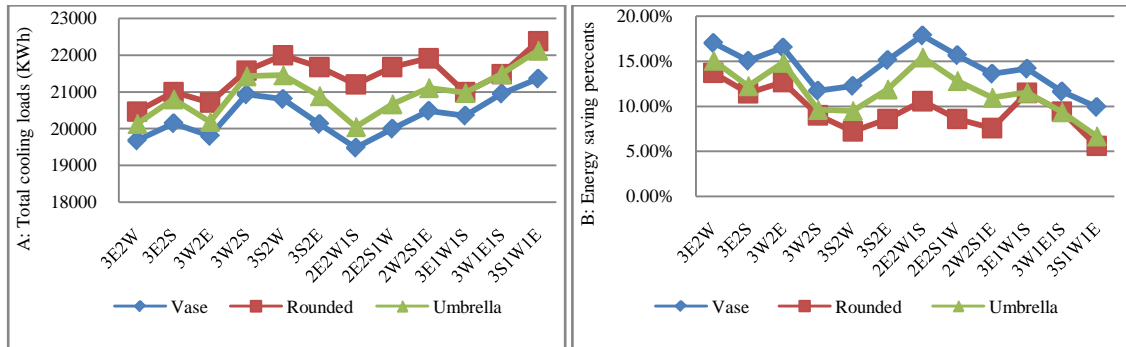


Figure (C.4): The effect of five trees locations possibilities on A: total cooling loads (KWh) and B: Energy savings percents in summer

The results indicate also that planting two trees near east side, two in the west and one in south has the lowest incident solar radiation amount for vase, umbrella, and rounded trees. Hence, the value of incident solar radiation reduction as a result of changing five trees locations has the same energy saving trend. Therefore, 2E2W1S has the highest incident solar radiation reduction percents that equal 29.82% and 1E1W3S has the lowest value that equal 24.85%. See figure (C.5)

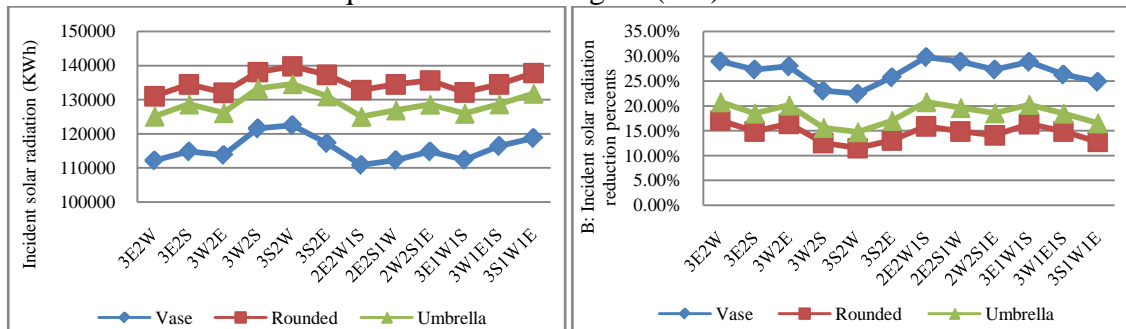


Figure (C.5): The effect of five trees locations possibilities on A: incident solar radiation amount (KWh) and B: incident solar radiation reduction percents in summer

Six trees locations possibilities appear in figure (C.6). Planting two trees near east side, two in the west and two in south has the highest energy savings for vase, umbrella, and rounded trees. Hence, the value of cooling loads reduction as a result of changing six trees locations can be ordered from highest to lowest as follow: 2E2W2S, 3E2W1S, 2E3W1S, 3E3W, 2E1W3S, 3E1W2S, 3E3S, 1E2W3S, 1E3W2S and finally 3W3S. Therefore, the effect of planting six vase trees on these locations save energy by about 20.30%, 18.83%, 18.39%, 17.54%, 16.73%, 16.65%, 16.10%, 14.68%, 14.16% and 12.81% respectively. The same trend is noticed for umbrella and rounded trees with lowest values.



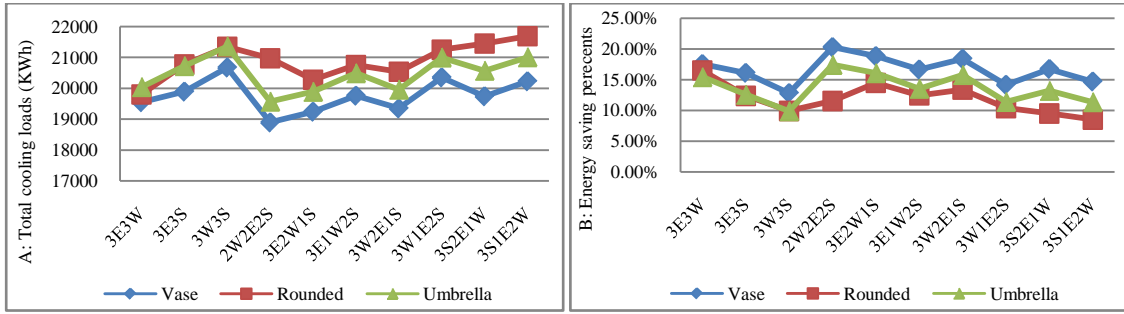


Figure (C.6): The effect of six trees locations possibilities on A: total cooling loads (KWh) and B: Energy savings percents in summer

The results indicate also that planting two trees near east side, two in the west and two in south has the lowest incident solar radiation amount for vase, umbrella, and rounded trees. Hence, the value of incident solar radiation reduction as a result of changing six trees locations has the same energy saving trend. Therefore, 2E2W2S has the highest incident solar radiation reduction percents that equal 34.01% and 3W3S has the lowest value that equal 25.66%. See figure (C.7)

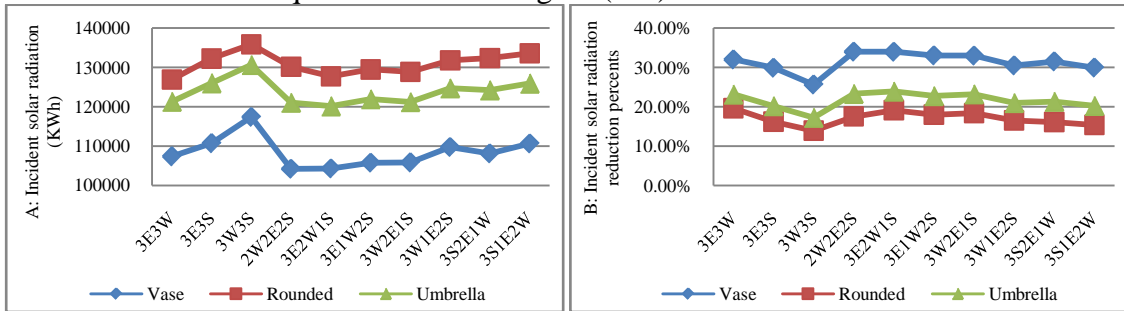


Figure (C.7): The effect of six trees locations possibilities on A: incident solar radiation amount (KWh) and B: incident solar radiation reduction percents in summer

Seventh trees locations possibilities appear in figure (C.8). Planting two trees near east side, two in the west and three in south has the highest energy savings for vase, umbrella, and rounded trees. Hence, the value of cooling loads reduction as a result of changing six trees locations can be ordered from highest to lowest as follow: 2E2W3S, 3E2W2S, 2E3W2S, 3E3W1S, 3E1W3S and finally 3W3S1E. Therefore, the effect of planting seventh vase trees on these locations save energy by about 21.35%, 21.27%, 20.85%, 19.38%, 17.71% and 15.23% respectively.

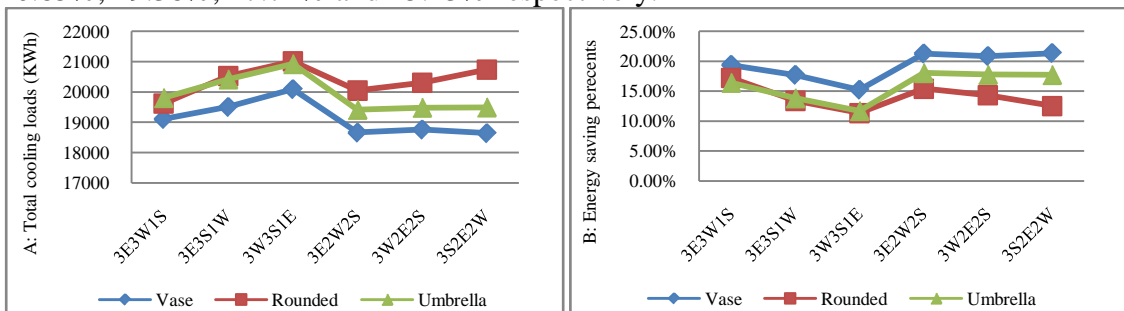


Figure (C.8): The effect of seventh trees locations possibilities on A: total cooling loads (KWh) and B: Energy savings percents in summer

The results indicate also that planting two trees near east side, two in the west and three in south has the lowest incident solar radiation amount for vase, umbrella, and rounded trees. Hence, the value of incident solar radiation reduction as a result of changing eight trees locations has the same energy saving trend. Therefore, 2E2W3S

has the highest incident solar radiation reduction percents that equal 36.66% and 3W3S1E has the lowest value that equal 15.23%. See figure (C.9)

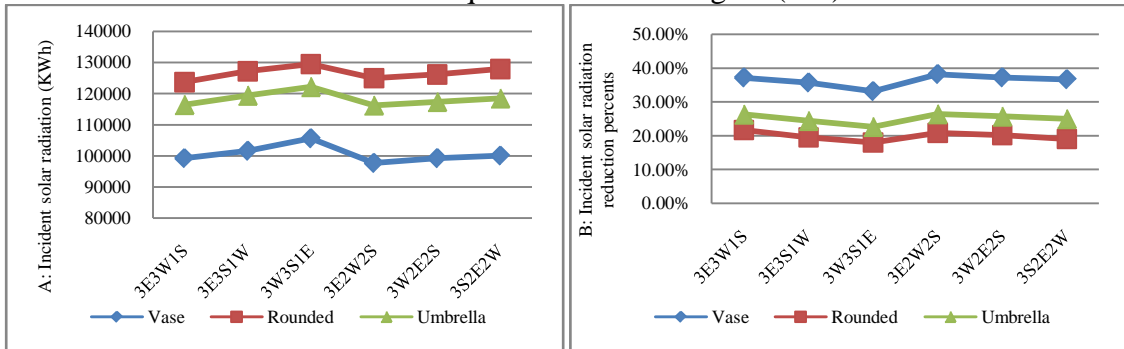


Figure (C.9): The effect of seventh trees locations possibilities on A: incident solar radiation amount (KWh) and B: incident solar radiation reduction percents in summer

Eight trees locations possibilities appear in figure (C.10). Planting three trees near east side, three in the west and two in south has the highest energy savings for vase, umbrella, and rounded trees. Therefore, the effect of planting eight vase trees on 3E3W2S, 3E3S2W and 3W3S2E saves energy by about 22.44%, 22.31% and 21.89% respectively.

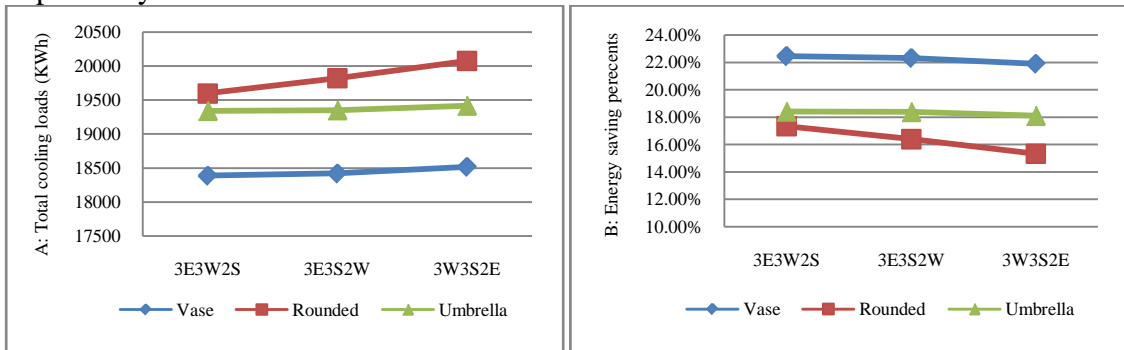


Figure (C.10): The effect of eight trees locations possibilities on A: total cooling loads (KWh) and B: Energy savings percents in summer

The results indicate also that planting three trees near east side, three in the west and two in south has the lowest incident solar radiation amount for vase, umbrella, and rounded trees. Hence, the value of incident solar radiation reduction as a result of changing eight trees locations has the same energy saving trend. Therefore, 2E2W3S has the highest incident solar radiation reduction percents that equal 36.66% and 3W3S1E has the lowest value that equal 15.23%. See figure (C.11)

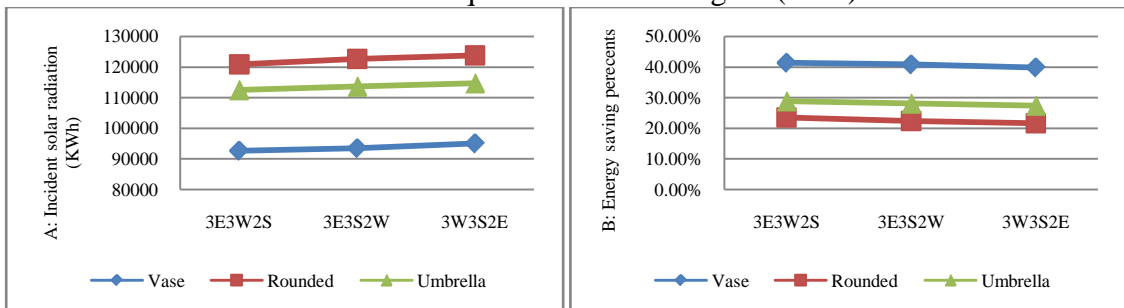


Figure (C.11): The effect of eight trees locations possibilities on A: incident solar radiation amount (KWh) and B: incident solar radiation reduction percents in summer

## Heating loads

As shown in figures (C.12) increasing total heating loads in winter, and energy consumption as a result of increasing trees number is less remarkable than decreasing total cooling loads in summer. Therefore planting nine vase trees around building, increases energy consumption in winter by about 9.47%. This percent is almost equal to energy saving in summer as a result of planting two vase trees on east side. Also, there is a slight increasing of energy consumption as trees number increase gradually. Hence, energy consumption in winter increased by about 8.52%, 8.25%, 8.11%, 7.18%, 6.97%, 6.70%, and 4.86% for planting eight trees on (3E3S2W), seven trees on (3E3S1W), six trees on (3W3S), five trees on (3S2W), four trees on (3S1W), three trees on (3S) and finally two trees on (2S) respectively.

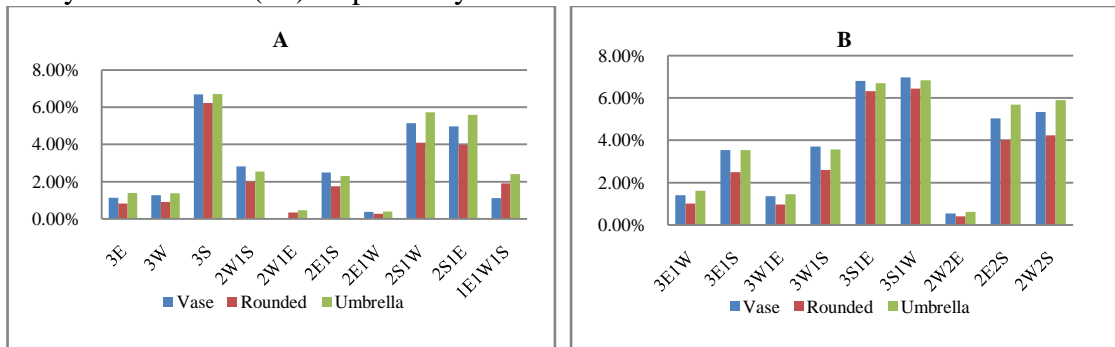


Figure (C.12): The effect of A: three trees locations possibilities and B: four trees locations possibilities on energy consumption in winter

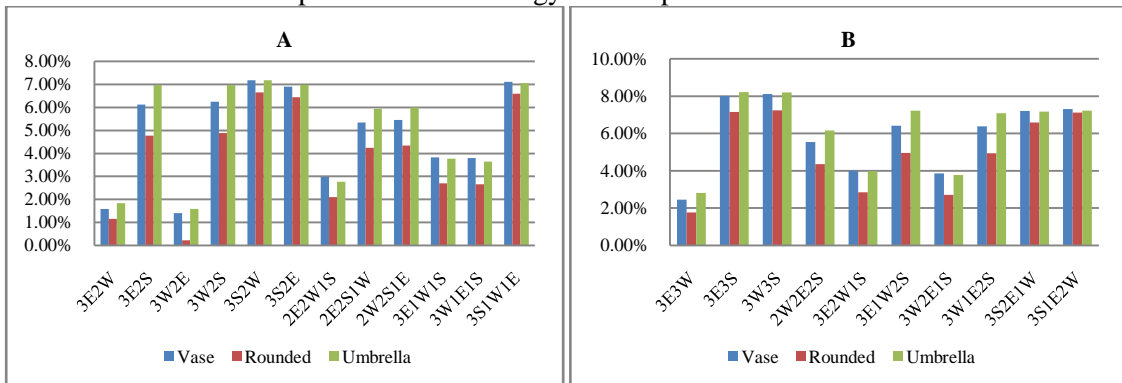


Figure (C.13): The effect of A: five trees locations possibilities and B: six trees locations possibilities on energy consumption in winter

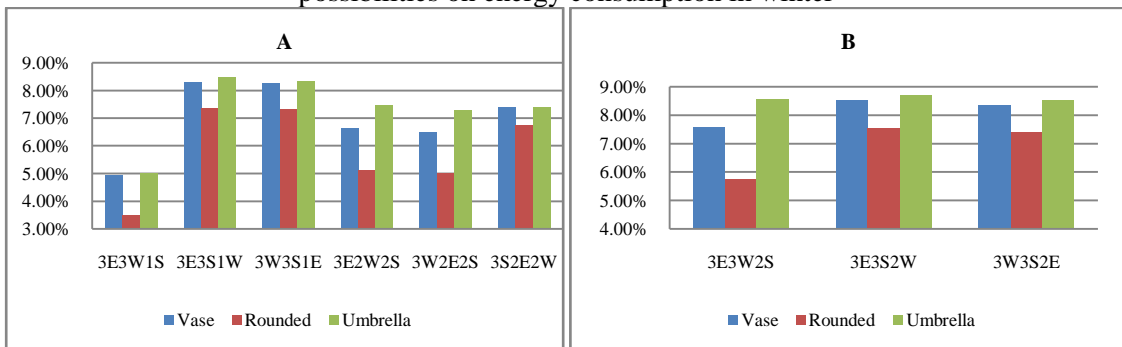


Figure (C.14): The effect of A: seven trees locations possibilities and B: eight trees locations possibilities on energy consumption in winter