

إقرار

أنا الموقع أدناه مقدم الرسالة التي تحمل العنوان:

Towards a sustainable interior design of the commercial buildings in Gaza: Framework of environmental index assessment

أقر بأن ما اشتملت عليه هذه الرسالة إنما هي نتاج جهدي الخاص، باستثناء ما تمت الإشارة إليه حيثما ورد، وإن هذه الرسالة ككل، أو أي جزء منها لم يقدم من قبل لنيل درجة أو لقب علمي أو بحث لدى أية مؤسسة تعليمية أو بحثية أخرى.

DECLARATION

The work provided in this thesis, unless otherwise referenced, is the researcher's own work, and has not been submitted elsewhere for any other degree or qualification.

اسم الطالب :

Student's name: **Eman Ahmed Suliman El-Shaikh Khaleel**

Signature: 

التوقيع:

Date: 28/9/2013

التاريخ:

**The Islamic University – Gaza
Deanery of Postgraduate Studies
Faculty of Engineering
Architecture Department**



Towards a sustainable interior design of the commercial buildings in Gaza: Framework of environmental assessment index

Applicant:
Eman Ahmed Suliman El-Shaikh Khaleel

Supervisors:
**Dr. Raed M. El Ottol
Dr. Omar Asfour**

**Thesis Submitted in Partial Fulfillment of the Requirements for the Degree of
Master in Architectural Engineering**





نتيجة الحكم على أطروحة ماجستير

بناءً على موافقة عمادة الدراسات العليا بالجامعة الإسلامية بغزة على تشكيل لجنة الحكم على أطروحة الباحثة/ إيمان أحمد سليمان الشيخ خليل لنيل درجة الماجستير في كلية الهندسة قسم الهندسة المعمارية وموضوعها:

نحو التصميم الداخلي المستدام في المباني التجارية في غزة ضمن إطار مؤشر التقييم البيئي

Towards a Sustainable interior design of the commercial buildings in Gaza: Framework of environmental assessment index

وبعد المناقشة العلنية التي تمت اليوم الأربعاء 29 ذو الحجة 1432هـ، الموافق 2012/11/14م الساعة الثانية عشرة والنصف ظهراً بمبنى الحديدان، اجتمعت لجنة الحكم على الأطروحة والمكونة من:

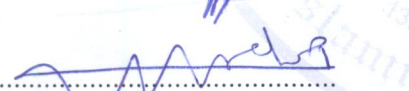
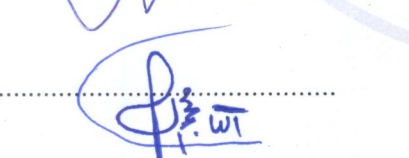
..... 	مشرفاً ورئيساً	د. رائد محمد العطل
..... 	مشرفاً	د. عمر سعيد عصفور
..... 	مناقشاً داخلياً	د. أحمد سلامة محيسن
..... 	مناقشاً خارجياً	د. نهاد محمود المغني

وبعد المداولة أوصت اللجنة بمنح الباحثة درجة الماجستير في كلية الهندسة / قسم الهندسة المعمارية.

واللجنة إذ تمنحها هذه الدرجة فإنها توصيها بتقوى الله ولزوم طاعته وأن تسخر علمها في خدمة دينها ووطنها.

والله ولي التوفيق،،،

عميد الدراسات العليا



أ.د. فؤاد علي العاجز

Abstract

This study confirms the need of incorporating sustainability into the interior design. This is due to the fact that the environmental issues have become a growing concern in the recent paradigm of interiors, which reflect awareness for both ecological aspects and inhabitants' life quality. Interior designers, organizations, institutes, firms and governments perceive the importance of sustainable interior design, yet they don't always put sustainability in practice. Insufficient promotion of sustainable aspects and effective barriers are blamed when implementing sustainability. In Gaza strip, the profession of interior design is rapidly growing and constantly developing. This indicates that re-orienting interior design towards sustainable issues is no longer of a marginal benefit, rather, a pure professional necessity. Thus, the methodology adopted to address the question for addressing in this research includes interviewing with specialists, some issues investigating perceptions, attitudes, behaviors of interior designers/architects at Gaza also, a sample of commercial project has been analyzed using the calculators developed for the most critical environmental problems energy and Indoor environment quality based on SKA- rating, NABERS, and PEARL systems. These calculators helped concluding recommendations regarding practicing sustainability in commercial interiors, which needs to be forced by legislations and laws. Thus, this study provided a wide variety of strategies for sustainable interior design. These recommendations include improvement of indoor air quality, visual comfort, acoustic comfort, thermal comfort, and energy consumption. Despite the fact that designers should be encouraged to practice these recommendations, this study argues that there is an urgent need to include them in buildings laws and legislations to protect and improve our built environment.

أكدت الدراسة على ضرورة إدخال الاستدامة في مجال التصميم الداخلي. حيث أن القضايا البيئية أصبح لها الاهتمام الأكبر في مجال التصميم الداخلي؛ والذي يعكس بدوره الوعي بكل من الجوانب البيئية وجودة حياة الأفراد. إلا أنه رغم هذا الوعي بالبيئة من قبل الحكومات، والشركات، والمؤسسات، نرى أن التطبيق لهذه القضية ما زال محدودا في كثير من الدول. السبب الأساسي في ذلك القصور هو ضعف الترويج للاستدامة من قبل المعنيين. فعلى صعيد قطاع غزة مثلا، فقد شهدت مهنة التصميم الداخلي تطور ملحوظا في السنوات الأخيرة، مما يشير إلى أن توجيه التصميم الداخلي نحو المفاهيم البيئية المستدامة لم يكن قضية هامشية، بل هي ضرورة ملحة. هذا ما دفع الدراسة إلى تبني منهجية من شأنها وضع الخطوة الأولى نحو تصميم داخلي مستدام بيئيا، ذلك من خلال خطوات ثلاث بدأت بإجراء مقابلة مع عدد من المختصين في المؤسسات الحكومية المعنية، ثم استقصاء معرفة وموقف المصممين في كافة المكاتب الهندسية في قطاع غزة بمفهوم التصميم الداخلي المستدام بيئيا، وقياس ممارستهم واختياراتهم بالجوانب البيئية، كما والوقوف على أهم المحفزات والعوائق لتطبيق الاستدامة. وأخيرا تم تحليل أحد المباني التجارية في مدينة غزة باستخدام الحاسبات المقترحة من خلال الدراسة لتقييم كل من استهلاك الطاقة، وجودة الفراغ الداخلي، والتي وضعت الأحد الأدنى من المواصفات البيئية لمشاريع التصميم الداخلي استنادا على ثلاث أدوات مستحدثة للتقييم البيئي المستدام في مشاريع التصميم الداخلي. من خلال ذلك قدمت الدراسة استراتيجيات لتطبيق الاستدامة في مجال التصميم الداخلي شملت خططا لتقليل استهلاك الطاقة في المباني التجارية، والارتقاء بجودة الفراغ الداخلي لتحقيق الراحة الحرارية الصوتية البصرية والسمعية للمستخدمين. لم تقتصر أهداف هذه الدراسة على تشجيع المصممين على ممارسة التصميم الداخلي، بل وأكدت أن المرحلة الحالية للتصميم الداخلي المستدام في قطاع غزة هي مرحلة عاجلة لتطبيق مثل هذه الاستراتيجيات و تضمينها ضمن القوانين واللوائح المعمول بها.

To whom I owe for their endless support, encouragement,
and compassion,

My parents, brothers, and sisters,

I do dedicate this humble thesis.

Acknowledgement

I wish to extend my sincere thanks to those who participated in producing this work. First, I am grateful to ALLAH (SWT) for the support received to accomplish this thesis. Thanks go also to my supervisors: Dr. Raed El Ottol and Dr. Omar Asfour for the kind support and the guide offered. I am fully indebted to my parents and other family's members for their endless support.

I would also like to express my gratitude to the team whose members distributed the questionnaire while not forgetting those who engaged in the survey and also those participated in the interviews for their valuable comments and useful feedback.

My gratitude goes also to Dr. Wesam. EL Madhon, Environmental Department; Islamic University of Gaza, who has greatly assisted in the practical stages of conducting this empirical research.

Very special thank goes to the manger of El Andalusia mall for assisting in obtaining the necessary data and also for permitting the author surveying the buildings. A very special thank is owed to the mall's architects, electricians, and HAVC system workers. Also I like to express my gratitude the IT engineers who assisted in working out the programming calculators.

Finally, this thesis is intended to serve all those concerned with remedying issues related to the environment in Gaza, in addition every architect wishing to learn about sustainable indoor environment.

Table of Contents

Abstract	I
المخلص	II
Dedication	III
Acknowledgement	IV
Table of contents	V
List of figures	VIII
List of tables	X
Abbreviation	XI
1. Introduction and Importance	1
1.1. Background	1
1.2. Scope of the study area	2
1.3. Study's aim	2
1.4. Objectives	2
1.5. Significant Original Contribution to Knowledge	3
1.6. Problem statements	3
1.7. Research hypothesis	5
1.8. Research question	6
1.9. Previous studies	6
1.10. Method, Approach ,and methodology	9
1.10.1. Measurement of variables	10
1.10.2. Flow Chart of Methodology	10
2. Literature Review	12
2.1. Introduction	12
2.2. Environmental impacts for indoor spaces	12
2.3. Concept of sustainable interior design	13
2.4. Environmental assessment tools of Sustainable interiors	15
2.5. Environmental aspects of sustainable interior design	17
2.6. Efficiency using of Energy	18
2.6.1. Lightning saving energy opportunities	20
2.6.1.1. Strategies related to daylight harvesting.	21
2.6.1.2. Strategies related to lighting appliances.	29
2.6.2. HVAC saving energy opportunities	35
2.6.2.1. Passive HVAC	36
2.6.2.2. Mechanical HVAC	37
2.7. Indoor environmental quality IEQ	38
2.7.1. Indoor air quality	38
2.7.1.1. Selecting materials	40
2.7.2. Thermal comfort	43
2.7.3. Acoustic comfort	45
2.7.4. Visual comfort	45
3. Research Methodology	47
3.1. Introduction	47
3.2. Method and Rationale of Approach	47

3.3. Research process	48
3.4. Interviewing specialists	50
3.4.1. Reliability of interviews	51
3.4.2. Validity of interviews	51
3.5. Surveying practicing firms	52
3.5.1. Questionnaire description	52
3.5.2. Data processing	54
3.5.3. Scaling	55
3.5.4. The pilot study	56
3.5.5. Reliability of survey	57
3.5.6. Validity of survey	57
3.5.6.1. Internal Validity	58
3.5.6.2. Structure Validity	58
3.5.7. Sampling	59
3.5.8. Distribution and response rates	60
3.5.9. Bias	60
3.6. Environmental assessing for commercial interior projects	61
3.6.1. Instrument and case study	61
3.6.2. Requirements for indoor environmental quality (IEQ)	62
3.6.2.1. Air quality	64
3.6.2.2. Thermal comfort	65
3.6.2.3. Acoustic comfort	66
3.6.2.4. Visual comfort	66
3.6.3. Assessing Energy efficiency	66
3.6.3.1. Envelop U- Value.	66
3.6.3.2. HVAC system	67
3.6.3.3. Services Hot Water System(SHW)	68
3.6.3.4. Lighting	68
4. (Energy, IEQ) calculators	68
4.1. Introduction	69
4.2. Proposed (Energy and IEQ) calculators.	69
4.2.1. Description	69
4.2.2. Importance and benefits for Gaza	69
4.2.3. Assessing stages	71
4.2.3.1. Assessment Post occupancy stage	71
4.2.3.2. Assessment design stage	71
4.2.4. Scaling and scoring	72
4.2.5. Calculator1,Energy efficiency calculator	72
4.2.5.1. First sheet, Envelope U-value	72
4.2.5.2. Second sheet, HVAC system	74
4.2.5.3. Third sheet, SHW system	75
4.2.5.4. Fourth sheet, Lighting	75
4.2.6. Calculator2, Indoor environment quality calculator	76
4.2.6.1. Locating and selecting the samples.	77
4.2.6.2. First sheet, Indoor Air Quality(IAQ)section	78

4.2.6.3.	Second sheet, Acoustic comfort	79
4.2.6.4.	Third sheet, Thermal comfort section	79
4.2.6.5.	Fourth sheet, Visual comfort	81
5.	Analysis and Results	82
5.1.	Introduction	82
5.2.	Analyzing and reflecting of Interviewing	81
5.3.	Analyzing and reflecting of questionnaires	83
5.3.1.	Measuring the knowledge about sustainable practices	83
5.3.2.	Evaluating the attitudes toward sustainable interior design	86
5.3.3.	Behaviors and practices for sustainable interior design	87
5.3.4.	Barriers and motivation among practicing interior design	97
5.4.	Case study, El Andalusia mall, analysis and finding	98
5.4.1.	Evaluation Energy Efficiency	99
5.4.1.1.	Envelope materials	99
5.4.1.2.	HVAC system	101
5.4.1.3.	SHW	104
5.4.1.4.	Lighting	104
5.4.2.	Evaluation Indoor Environment Quality	105
5.4.2.1.	IAQ	105
5.4.2.2.	Thermal comfort	108
5.4.2.3.	Acoustic comfort	112
5.4.2.4.	Visual comfort	113
6.	Conclusion and recommendations	113
6.1.	Reflections on the objectives and research questions	115
6.2.	Reflections on the Hypotheses	116
6.3.	Findings and conclusion	116
6.3.1.	General Findings	116
6.3.2.	Findings related interior design profession at Gaza	117
6.4.	Preferred vision statement for the study	118
6.5.	Strategies and Recommendations	118
6.5.1.	Strategy (1):	118
6.5.2.	Strategy (2):	119
6.5.3.	Strategy (3):	117
6.5.4.	Strategy (4):	120
6.5.5.	Strategy (5):	121
	Reference	122
	Appendixes	130

List of figure

Figure(1.1): Study scope from sustainable design	3
Figure(1.2): Electric energy consumption for commercial building in Gaza	4
Figure(1.3): Total electric energy consumption	5
Figure(1.4): Eclectic energy consumption for commercial building In Gaza comparing with the total consumption	5
Figure(1.5): Methodology flow chart	11
Figure(2.1):Solidarity of three aspect of sustainable design	14
Figure(2.2)Energy reduction' strategies	19
Figure (2.3). Lightning strategies for reduce energy Source	20
Figure(2.4): Annual cooling energy at different windows size	22
Figure(2.5): Annual heating energy at different windows size	22
Figure(2.6): Controlling light with using light shelf	23
Figure(2.7) :Interior light shelf	24
Figure(2.8):Concept of light shelf	24
Figure(2.9) Tilting light shelf	24
Figure(2.10): Plan view showing angles of horizontal and vertical louver	25
Figure(2.11).Concept of prismatic glazing	26
Figure (2.12): Effect of Using louver	26
Figure(2.13): Top lighting system	27
Figure(2.14): The supermarket's model in RELUX	27
Figure(2.15).Annual energy consumption of the studied supermarket, with and without the application of a lighting control scheme	28
Figure(2.16): Atrium shapes as simulated with pyramidal	28
Figure (2.17). Incandescent lamp	29
Figure (2.18). Compact fluorescent lamp	30
Figure(2.19).Tubular fluorescent lamp	30
Figure(2.20):low pressure sodium	30
Figure(2.21).High pressure sodium	30
Figure(2.22): Solid state lighting	31
Figure(2.23): Luminaries' components	32
Figure(2.24).Luminaire light control methods	32
Figure(2.25).The most typical Luminaries used in commercial	33
Figure(2.26): Thermal comfort in accordance with humidity and temperature	44
Figure(2.27): Thermal comfort in accordance with Air speed and temperature	44
Figure(3.1): Rational for choice of approach of studies	48
Figure(3.2): The four main stages of research	49
Figure(3.3): Statistical test used for questionnaire	55
Figure(3.4): Sample Numbers among Gaza strip	59
Figure(3.5): Internal photos for the El Andalusia	62
Figure(3.6) Six locations at Ground floor	63

Figure(3.7) Six locations at second floor	63
Figure(3.8) Six locations at Third floor	63
Figure(3.9): IAQ Monitor Model 2211	64
Figure(3.10): HAL-HPC300	64
Figure(3.11): Hal-Tech C Particle v2.2 software program	65
Figure (3.12): Smart sensor electronic anemometer.	66
Figure (3.13): Digital Multimeter Mastech ms8209.	66
Figure(3.14): Calculation of Projection factor	67
Figure(4.1):Main- aspects and sub- aspects for calculators	70
Figure(4.2): Steps for using calculators in design stage	71
Figure(4.3): Envelope sheet	71
Figure(4.4): Acoustic comfort sheet	79
Figure(4.5): Thermal comfort in accordance with humidity and temperature	80
Figure(4.6): Thermal comfort in accordance with Air speed and temperature	80
Figure(4.7): Thermal comfort sheet	80
Figure(5.1): A ₂ The most problem at indoor space in Gaza	84
Figure(5.2): Putting environmental aspects as a main objective for design	87
Figure(5.3): Times of practicing sustainability in design of interior	88
Figure(5.4): Presence of a concrete environmental goal	88
Figure(5.5): Confronting any environmental problem while or after design stage	89
Figure(5.6): The reasons for using plants	91
Figure(5.7): The reasons for unwilling to use plants	91
Figure(5.8): Calculation for efficient lightning	92
Figure(5.9): Percent of using passive design, thermal isolator, Air condition for optimal thermal comfort	93
Figure(5.10): Using acoustic comfort	93
Figure(5.11): The priority of heating water systems	95
Figure(5.12): Using special devices and taps for reducing water consumption	95
figure(5.13):Using recycled materials	100
Figure(5.14): Percent of Using software program to make environmental analysis	100
Figure(5.15): Energy consumption by sources	100
Figure(5.16): Envelop result	101
Figure(5.17)Electric energy consumption for the building	102
Figure(5.18): HVAC system result	103
Figure(5.19): Hot water system result	104
Figure(5.20): lighting result	104
Figure(5.21): IAQ results by using calculator	108
Figure(5.22): Thermal comfort results for GFL by using calculator	109
Figure(5.23): Thermal comfort results for FFL by using calculator	110
Figure(5.24): Thermal comfort results for SFL by using calculator	111
Figure(5.25): Acoustic comfort result by using calculator	113
Figure(5.26):Visual comfort result by using calculator	114

List of tables

Table (2.1). Environmental tools assessment	15
Table(2.2): International store energy comparison	20
Table (2.3). Software tools using in lighting analysis	23
Table (2.4): Illustrate discharge light types.	30
Table(2.5): Overview of energy saving strategies and relative energy saving potential	34
Table(2.6): Types, sources, and parameters of indoor air pollutants	39
Table(2.7).Materials' emission estimates	41
Table (2.8). Ways of evaluating materials	42
Table (2.9). Thermal comfort's metrics	44
Table (2.10). Comfort Criteria for public Indoor environment building	44
Table(3.1):List of interviewees	50
Table(3.2): questionnaire' Four sections	53
Table (3.3):Likert scales used through questionnaire.	54
Table(3.4): Kolmogorov-Smirnov test	54
Table(3.5): Scales samples	55
Table(3.6): Cronbach's Alpha for each filed of the questionnaire	57
Table(3.7): The specialists arbitrated the questionnaire	58
Table (3.8). Correlation coefficient of each field of whole the questionnaire	58
Table(3.9): Response rate for surveys	60
Table(3.10): Requirement data for air quality sheet	64
Table(3.11):Requirements data for thermal comfort sheet	65
Table (3.12): Material properties required for energy sheet.	67
Table(4.1): U- value for building elements	73
Table(4.2): The efficiencies of conditioning equipment	74
Table(4.3): Specific of fan powers	74
Table(4.4):Minimum efficiency for water heater	75
Table(4.5): lighting power density for different spaces	75
Table(4.6): weighting of four categories in commercial indoor	76
Table(4.7): measurements distance from some objects	77
Table(4.8): Equipment requirements	77
Table(4.9): illustrate the acceptable level of pollutant	78
Table(4.10): instruments requirements	78
Table(4.11):Nominal illumination level according to commercial spaces	81
Table(5.1): The open question' answers	83
Table (5.2): Means, percent, and rank for "A4"	84
Table (5.3): Designers' knowledge of Environmental evaluation tools.	85
Table (5.4): Means and Test values for "B1"	86
Table (5.5):How do your company's activities contribute to better environment	89
Table (5.6):The priority in choosing finishing materials and construction methods	90
Table(5.7): The priority of using plants	90

Table (5.8): Percentage of natural lighting	92
Table(5.9): The priority of choosing electric elements	94
Table(5.10): The priority of heating water systems	97
Table (5.10): Means and Test values for “D1”	98
Table (5.11): Means and Test values for “D2”	97
Table(5.12): Envelope U- value	99
Table(5.13): Calculation for main wall u- value	100
Table(5.14): Calculation for floor and ceiling	100
Table(5.15): Entrance glass details	100
Table(5.16): conditioners characteristics	102
Table(5.17): Indoor pollutants results for ground floor level(GFL)	105
Table(5.18): Indoor pollutants results	106
Table(5.19): Indoor pollutants results	106
Table(5.20):Results of Smart sensor electronic anemometer and Digital multimeter mastech ms8209for (GFL)	108
Table(5.21): Results of Smart sensor electronic anemometer and Digital multimeter mastech ms8209for (FFL)	110
Table(5.22):Table():Results of Smart sensor electronic anemometer and Digital multimeter mastech ms8209for (SFL)	111
Table(5.23):Results Digital multimeter mastech ms8209for (GFL, FFL, SFL)	112
Table(5.24): Measuring the Luminance	113

Abbreviation

WHO	World health organization
LEED	Leadership in energy and environmental design
HVAC	Heating, Ventilation, Air Conditioning
BREEAM	Research Establishment's Environmental Assessment Method
NABERS	The National Australian Building Environmental Rating Scheme
CASBEE	Comprehensive Assessment Systems for Building Environmental Efficiency
DQI	Design Quality Indicator
EMGB	Manual for Green Buildings
IEQ	Indoor Environment Quality
PVs	Photovoltaic cells
HELU	High Efficiency Lighting Units
ETL	Energy technology List
CFL	Compact Florescent Lamp
LED	Light Emitting Diodes
OLED	Organic Light Emitting Diodes
DECC	Department of Energy and Climate Change
IAQ	Indoor Air Quality
CO	Carbon Monoxide
CO ₂	Carbon dioxide
VOC	Volatile Organic Components
Ppm	Parts per million
Twa	Time Weighted Average
OSHA	Occupational Safety and Health Administration
NIOSH	National Institute of Occupational Safety and Health
ACGH	American Conference of Government Hygienists.
BIM	Building Information Modeling
ASTM	American Society for Testing and Materials
GEI	Greenguard Environmental Institute
BRE	Building Research Establishment
NEP	New Ecological Paradigm
MEV	Model of Ecological Value
TEQ	The Environmental Questionnaire
PCC	Pearson Correlation Coefficient
SCC	Spearman Correlation Coefficient
SHW	Service and Hot Water
SHGC	Solar heat Gain Coefficient
SL	Standby Loss
DCV	Demand control ventilation
LPD	Lighting Power Density
TVOC	Total Volatile Organic Compounds
PM	Particulate Matter

Introduction

This chapter discusses the importance of this study through presenting the research problem, followed by reporting about the methodology adopted to answer the research's questions.

1.1. Background

Sustainability has emerged as a call for design in which it can inspire a new environmental innovation because of its effects on most aspects of life (OSHA, 2011). Indoor spaces, where 90% of our time is spent, are a key term; hence, they have the majority of environmental impact (Moxon, 2011). Interior designers might have an effective role in the choice of materials, achieving low-energy systems, and improving the indoor quality. The quest to achieve a sustainable indoor environment is necessary (OSHA, 2011). Surprisingly, interior designers start to recognize the ecological problems despite ignoring sustainable practicing.

Sustainability is not only a concern for environmental solutions, management systems, energy efficiency, and building products but also a concern for everyday life and its ethics. This is why the green dialogue in interiors is not without challenge; especially in the absence of previous studies that offers strategies deemed essential to achieve a sustainable interior design (ESD, 2007). For instance, in the Gaza strip, despite a partial supervision being undertaken for few indoor spaces of the industrial and health projects these are often designed and/or built without either a set of specifications or full drawing manual (Hamouda A,(2012) , per.comm., 5 May). Therefore, this study highlight the importance of clear specifications for environmentally sustainable interiors in order to avoid potential liabilities to the environment. This can be conduct in similar way of design assessment schemes, as SKA rating and NABERS that are available worldwide to measure the performance of interior projects. NABERS is the national Australian building environmental rating scheme for existing building. SKA rating is run by the royal institute of chartered surveyors in U.K. (Moxon, 2011). Accordingly, measuring the level of inceptions, behaviors and attitudes must be anticipated.

On the basis of the interior design projects in the Gaza Strip, analysis in this study seeks to develop a sustainable commercial interior that is an important backdrop necessary to promote responsibilities for achieving a sustainable indoor environment. In addition, commercial interior projects – including shops, malls, supermarkets, centers, restaurants and hotels – are the bulk of interior projects within the Gaza Strip. Hence, this study offers an inspiring example that has at its stake how to pioneer the interior marked by a sustainable design. It also creates an advanced relationship necessary to widespread sustainability amongst designers, clients, students, firms and governments.

1.2. Scope of the study area

This study lays the template for driving a change in how to practice the interior design within the Gaza strip which would eventually results in a continuous improvement in sustainable design of the interior. Accordingly, this requires measuring attitudes, knowledge, and behaviors toward environmental issues among designers, firms, and governmental organizations. Primarily, this study proposes how to develop specifications of the commercial interiors conceived as an exemplary powerful catalyst that is a step ahead toward achieving innovation in sustainable design of the interior. This study has set out to evaluating energy efficiency and indoor environment quality (IEQ) for commercial interior design projects as shown in figure (1.1).

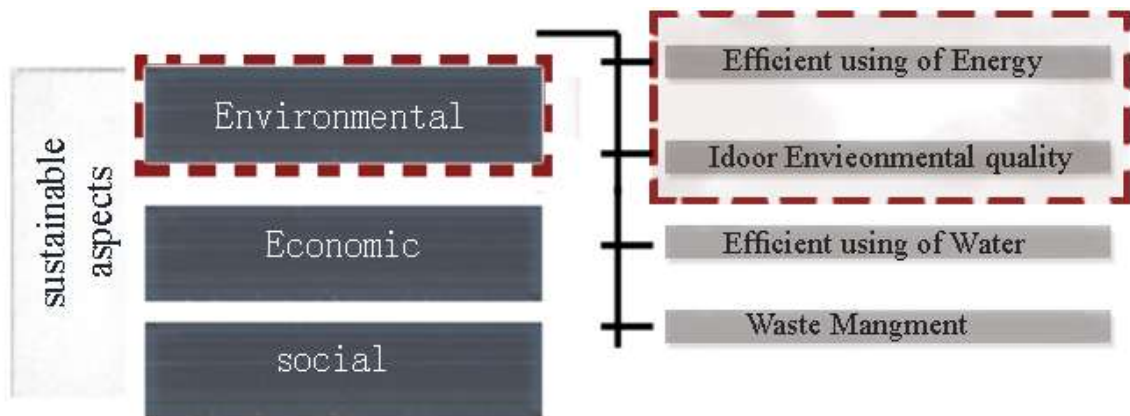

Figure(1.1): Study scope from sustainable design

1.3. Study's aim

This study on the one hand aims at essentially applying the base necessary to avoid a negative environmental impact, thereby enhancing awareness of the environmental responsibilities within the interior design in the Gaza Strip. And then, it proposes putting sustainable commercial interiors in practice as an initial step.

1.4. Objectives

To achieve the above aim, the following objectives are of key concern:

- a. An in-depth understanding of environmental issues within the interior by shedding light on the international approach of sustainability to the interior design;
- b. Developing appropriate indicators for measuring the quality of indoor environment and outline the energy consumption in the interior design of commercial buildings in the Gaza Strip;
- c. Investigating environmental inceptions, attitudes and behaviors amongst designers. Moreover, this study helps assess the environmental behavior needed for commercial projects by adopting sustainable evaluated tools; and

- d. Highlighting guidelines or strategies that lay the template for orienting the concerns of Gaza interior designers, firms, and organizations towards ecological issues and well-sustained interior projects through the lens of gaining insight into the perceived barriers and motivations.

1.5. Significant Original Contribution to Knowledge

This research strives to achieve the four main contributions as follow:

1. It helps the local authorities and Engineering Association in the Gaza Strip to develop a full interior project manual necessary to accomplish a complete construction documents for commercial interior design projects;
2. It inspires and stimulates decision-makers, designers, and clients to adopt the environmentally responsible approach that is useful to implement sustainable practices.
3. It enhances curricula in an attempt to develop new methods that notes the importance of sustainability in the design of interior.
4. This study itself serves as an incentive and viable force towards achieving sustainable interior design in the Gaza Strip.

1.6. Problem statement

Environmental changes, taking into account their implications, are crucial (ASID, 2006) because building's construction within the indoor environment in particular has been largely affected (ASID, 2006). According to climate changes, building account 50% of global house gas emission, and up to 40% of global energy use. Therefore, *“Any building for human purposes should be an elemental, sympathetic feature of the ground, complementary to its nature environment.”* (OSHA, 2011: p. 23). Thereby, enhancing sustainable indoor environment regarded as the intelligent solving key.

Environmental practices have influence on the behaviors of other two aspects of sustainability social and economic (Moxon, 2011). Accordingly, interior designers are key because their design could have an impact on the health and the behaviors of individuals. Most studies that discuss sustainable issues tend to focus on architecture and environmental legislation that target the architects, but largely ignoring environmental aspects of sustainable indoor environment. This study attempts to fill the gap by addressing aspects of sustainability in relation to architecture design of the interior, especially the fresh interior projects. Energy efficiency and Indoor Environmental Quality (IEQ) are particularly chosen for investigations, as it is shown in figure (1.1).

In the Gaza Strip, the scope of this study is particularly relevant. Remarkably, interior design's revival in the Gaza Strip has led to a boom in construction. In accord to an investigated statistics done by the researcher, about 30 to 40 interior-design projects are

annually completed. Aesthetic considerations are met in these projects, yet environmental issues are seriously lacking, for instance material specifications and energy efficiency. More importantly, educational courses of interior design at university level within the Gaza Strip have largely overlooked how to environmental sustainability in the interior design. In response, sustainable commercial projects strengthen collaborative and innovative process of the interior design because these on the one hand help fine tune a fresh sustainable approach to interior design in the Gaza Strip (Hamouda A,(2012) , per.comm., 5 May). On the other, commercial interior design projects easily force to environmental legislation. Hence, this study's scope is how to achieve a sustainable interior design marked by all systems and materials that are designed in respect of all purposes of the surrounding environment. The orientation to interior design approach flagged by sustainability offers indicators' assessment, requires enthusiastic designers and challenges both construction firms and academics.

According to statistic of Electricity Company in Gaza, the total electricity consumption relevant to the last three years is 1,157,422,482 KW, and commercial building consumption is 83,157,873KW as shown in diagrams(1.2)and (1.3)(Radi, 2012). This means that the commercial part consumes about 7% of total electricity, as it is shown in figure (1.4).

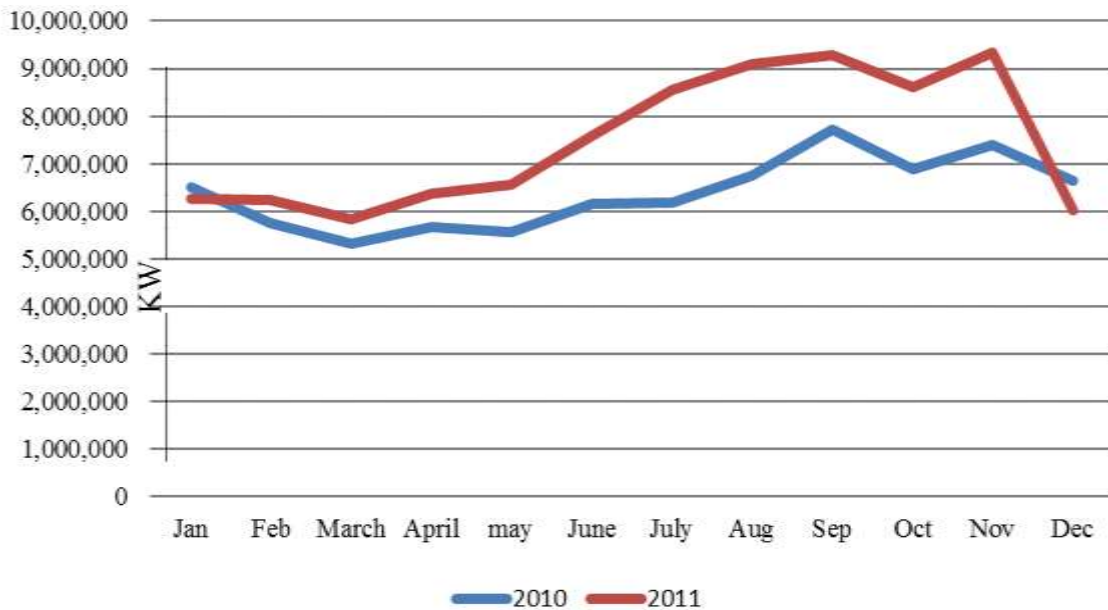

Figure(1.2): Electric energy consumption for commercial buildings in Gaza

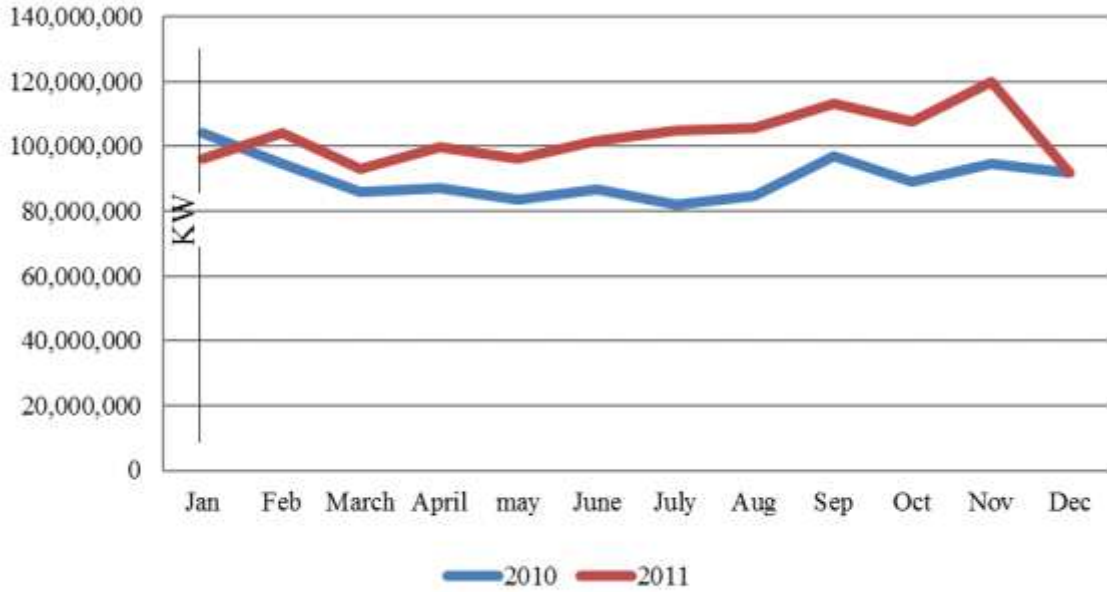

Figure(1.3): Total electric energy consumption

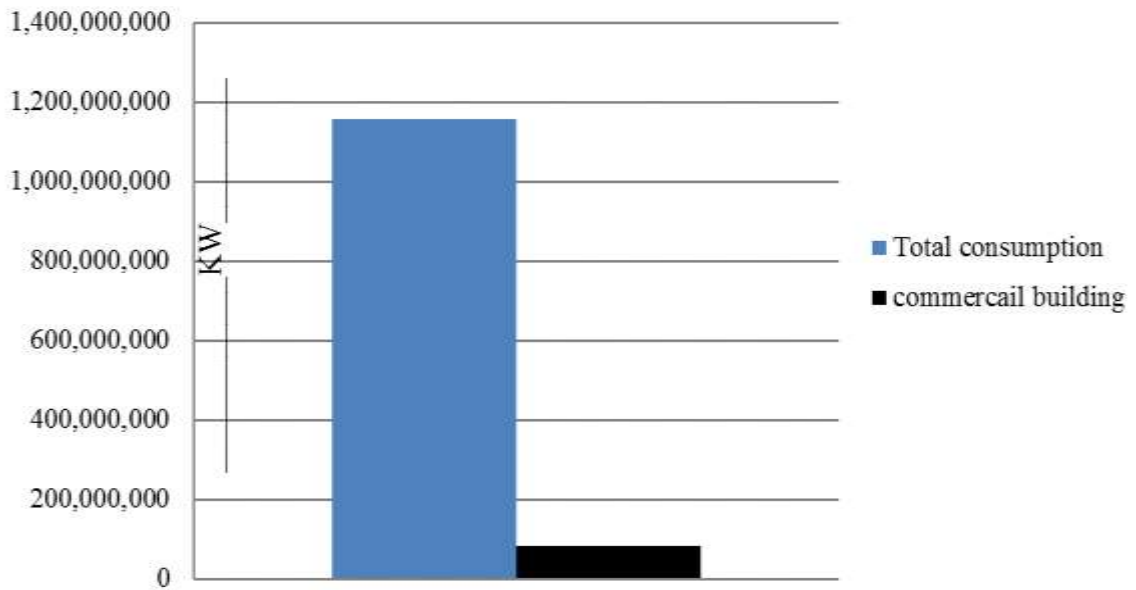

Figure(1.4): Eclectic energy consumption for commercial building In Gaza comparing with the total consumption

1.7. Research’s hypothesis

As sketched previously, practicing interior design in the Gaza strip, has not been considered the environmental aspects due to the absence of forced laws for interior projects, thereby there is a need for an initiative and innovative step toward environmentally sustainable interior design projects.

1.8. Research's questions

The main research questions what are investigated amongst the study are:

- A. What are the international–base of environmental sustainability of the interior design;
- B. How can this study develop an appropriate standards for commercial interior projects at Gaza?
- C. What is the level of the environmental awareness about sustainable practices for organizations, designers, and commercial projects?
- D. What are the values and incentives that lay the template for orienting the concerns of Gaza interior designers, firms, clients, and organizations toward adopting sustainable practices in their interior projects?

1.9. Previous studies

This section presents a review of the previous studies relevant to the questions of this study. It analyzes studies related to the sustainability in interior design, followed by studies that has a similar focus or, rather, utilizing the same methodology procedures as:

"Interior designer's attitudes toward sustainable interior practices and barriers encountered when using sustainable interior design". By Leigh M. Bacon, 2011.

The thesis determined the interior designer's attitudes toward sustainable interior design practices and what the barriers are to overcome the environmental issues. Attitude's questions were categorized onto five questions: preserving earth's resources, encouraging the use of sustainable, interior design practices, benefiting the health of building, occupants, Trend and Open to use, and scored on a five-point Likert scale. Barriers associated with sustainable interior design practices were based on the three categories Project Capabilities, Transition to Sustainability, Knowledge and Skills. Project Capabilities, Transition to Sustainability, Knowledge and Skills. These barriers have been recognized as a significant relationship between attitudes and barriers amongst responses gained from American Society of Interior Designers (ASID) and International Interior Design Association (LIDA).

This study recommends that each designer and project has to be unique concerned with how sustainability might be incorporated and seeks a response to another important question tied to an achievable more sustainable designs.

"The state of environmentally sustainable interior design practices". By Mihyun Kang and Denise A. Guerin, 2009.

The researchers who are concerned with environment have addressed the environmental criteria for interior design. In contrast designers did not practice. Knowing the level of sustainable practices will be important to make influence development in interior design. Hence, this study examined the state of environmentally sustainable interior design

practice. It illustrates that designers always do not address sustainability in practice, despite of its importance because of the poor promoting and wrong perception. Whereas, a lot of designers and clients think that sustainable design is costly and time consuming. Consequently, this study determined the factors that can motivate the interior designers to practice environmentally sustainable interiors projects. The promoting proofs were by:

- Examining the integration between environmental interior design and economic issues.
- Focusing on interior design materials guiding to greener project with less environmental impact.
- Reviewing numbers indicated less costly practices when it use environmentally sustainable interior design approach.

"The social benefits of sustainable design" By National institute of building science.

This study is promoting sustainability through its social benefits which can be realized at different levels of buildings. It depends on environmental impacts for enhancing the social aspects; whereas, the study discussed the environmental gaps' impacts on social life such as illness, absenteeism, fatigue, discomfort, stress, and distract. Indeed, all these social problems can be reduced by sustainability practices. Instead, it described the impact of sustainable building on occupants health, comfort, satisfaction and well-being; then it describes the potential benefits of energy efficiency and other sustainable design feature to occupants safety and security.

"Evaluation on integrating sustainable ideas into interior design students' projects". By R.Btalib and M.Z Suleiman.

This paper investigates the role of the academic sectors in producing the design with fair knowledge on environmental designs. It took a sample of 33 students from university Sian Malaysia and its results led to the following recommendation:

- Green design approach is responsible design so there must be great decisions to sustain our life way.
- The role of interior designers is greater enough that they must contribute the process of designing the built environment.
- The future generation of interior designers must be guide and well aware to have sustainable projects.

"Sustainability for interior design: rating the flooring materials in a LEED registered hotel using the BEES evaluative software for sustainable products". By Sarah Cross Cain, 2007.

The appropriate interior finishing materials has impacted the sustainable movement, so that the evaluating software, system building for environmental and economic sustainability (BEES), can help designers to make the best choices for client's needs.

This study aims to encourage using sustainable materials in indoors, and provide a framework for evaluation flooring materials. The result of study show that BEES is a good tools to identify the complex issues needed to evaluate more fully the materials w intended to specify in o design's application. Finally, the study emphasizes the advantages of the evolution process in order to lead more proactive and progressive steps toward sustainable designs. Then, it supports the performance of eco- friendly materials at the intended functions, and assures the role of interiors to create better physical environment through their design decisions. This study recommends that it is important to have more detailed profiling system for interior to guide and force designers to practice sustainability.

"Selling green: interior design and global impacts 2007". By ASID.

It is one of five papers related to sustainability in design buildings. This guide, selling green, is a toolbox promoting the sustainable design through general principles for cost saving and benefits associated with sustainable design, thus it set out the following pivots which are:

- Cost and values of sustainable design.
- Lost saving in energy, water and lost during operation and maintenance.
- Selling the benefits of sustainable design.
- Selling services of sustainable design.

"Survey on implementing sustainable issues into interior design studies project". By Roslan B talb, Moh suliemain, 2011.

The clients and designers become concerned to address the environmental solutions to the indoor spaces. In contrast they have a little experience due to the Gab in the academic courses. Therefore, this study measures addressing sustainability in interior students' projects in one of the environmental courses among affixed procedure. This survey is aimed to determine the sustainable qualities of materials used in the studio tasks based on the US general services admin sustainable principles followed by us LEED rating system and other sources.

The study confirmed that a lot of prominent university started to apply having these sustainable roles, but there are still empty academic rooms that can be filled to implement sustainable standard practices in interior design. For examples, they must use practices for life cycle analysis, and for reducing landfill, buying local, downsizing, salvage, repurposing, heirloom design, anti- allergy, reducing VOCs, and day lighting for productivity.

"Indoor Air Quality in commercial and institutional buildings". By occupational safety and health administration, 2011.

Indoor air quality (IAQ) problems can be hazardous to user's health, so OSHA provide this documents due to providing the improving ways for ideal IAQ. Moreover, it prevents

IAQ problems for commercial and institutional interiors. It also illustrates the importance of mitigation of IAQ problems that are responsible for giving more comfort, health and wellbeing. It presents the sources of indoor air pollution including space location, building design, systems, maintenance, renovation activities, materials, and furnishing.

IAQ management is an effective action that should control by the design; hence, the document commended the EPA's report and IAQ tools for assessing the IAQ performance. It provides some practices to identify and assessing IAQ. In addition to that, the study mentions that the sources management, engineering controls, and administrative controls are the method managing the indoor pollutant. Finally, it attached sex related appendix discussed:

- The common indoor contaminants.
- Sets out steps to improve indoor air quality.
- Systems can make sure IAQ is proper.
- IAQ problems and complainants.
- IAQ's resources and the mechanism of evolution and controlling.
- Three workshops sponsoring by OSHA toward environmental Tobacco smoke.

1.10. Method, Approach, and Methodology

This study applied mixed methods due to set out different ways of conceptualizing and seeing for sustainable interior design at Gaza strip. For instance, Questionnaires were used to measure clients and designers' environmental inceptions, attitudes, and behaviors, to clarify the barriers and motivations. Interviews were carried out with specialists in the municipalities, engineering associations, ministry of natural economy, and ministry of environmental affairs to collect data. A sample of commercial project was subjected to assessing by using the proposed environmental calculators.

The study approach is different from the related studies. It implies all different aspects of interior profession in the Gaza strip designers, municipalities, associations and clients and students. Accordingly, the methodology integrates Quantitative and Qualitative methods in simultaneous triangulation way in order to employ the correct procedures to find out appropriate strategies to apply sustainability in interior design.

The methodology started with literature review and previous attempts for sustainable studies that added scope and breath to the study. Then, data was collected through the following mixing of Quantitative and Qualitative methods.

- Analyzing the individual interviews for specialists, and questionnaires.
- Improving Environmental tools for Energy efficiency and IEQ.
- Engineering drawing, bills, measurements for the case study.

- Analytical method based on data collection, results and interpretation for similar studies.

Specialists at engineering association were interviewed due to collect data related to the numbers of interiors firms at the Gaza strip, and investigate the reasons and obstacles of applying sustainability in interior projects. Meanwhile, interviews for concerned departments at municipalities were followed to support developing steps toward forceful sustainable practices especially what related to interior projects.

Estimating the size of commercial interior projects in the Gaza strip comparing with the total projects enhances choosing commercial sectors. Likewise, it helps to choose the adjacent points for selling sustainable practices. Then, all investigated indicators through interviews, questionnaires; statistics affirmed that commercial building can be an influential step toward sustainability. Hence, environmental calculators for energy consumption and indoor environmental quality were developed for commercial indoors by using the minimum environmental criteria, and then these calculators were used to evaluate the vase study. Data was deductively and inductively analyzed based on information and results, to proposed strategies, guidelines that support the aim of this study.

1.10.1. Measurement of variables

This study developed environmental assessment calculators for both energy consumption and IEQ for commercial projects by using indicators adjusted with Gaza's environment and in similar way to the international interior schemes as SKA-rating, NABERS, and PEARL system. Hence, these have been developed for interior projects only. SKA- rating is run by the royal institute of chartered surveyors in UK and it offers four rating unclassified as Bronze, silver and Gold. The national Australian building environmental rating scheme (NABERS) awards the project a star rating of up to five stars. PEARL system is developed by Steadman program center at Abu Dhabi urban planning council and it give from one to five pearls.

There were challenges during the research progress. For instance, there are insufficient practical studies related to the environmental issues especially in design of interior. In addition, the study is considered initiative step toward interior managing and sustainability practicing. The most important, few indoor air instruments are available in Gaza institutions. Therefore, these challenges were translated to strategic recommendations.

1.10.2. Flow Chart of Methodology

The research methodology chart serves as a guide in achieving the objectives and scopes of the study. It schematically designs in detail the process of study, in terms of how the data is collected and how it is processed and analyzed to achieve the objectives of the study.

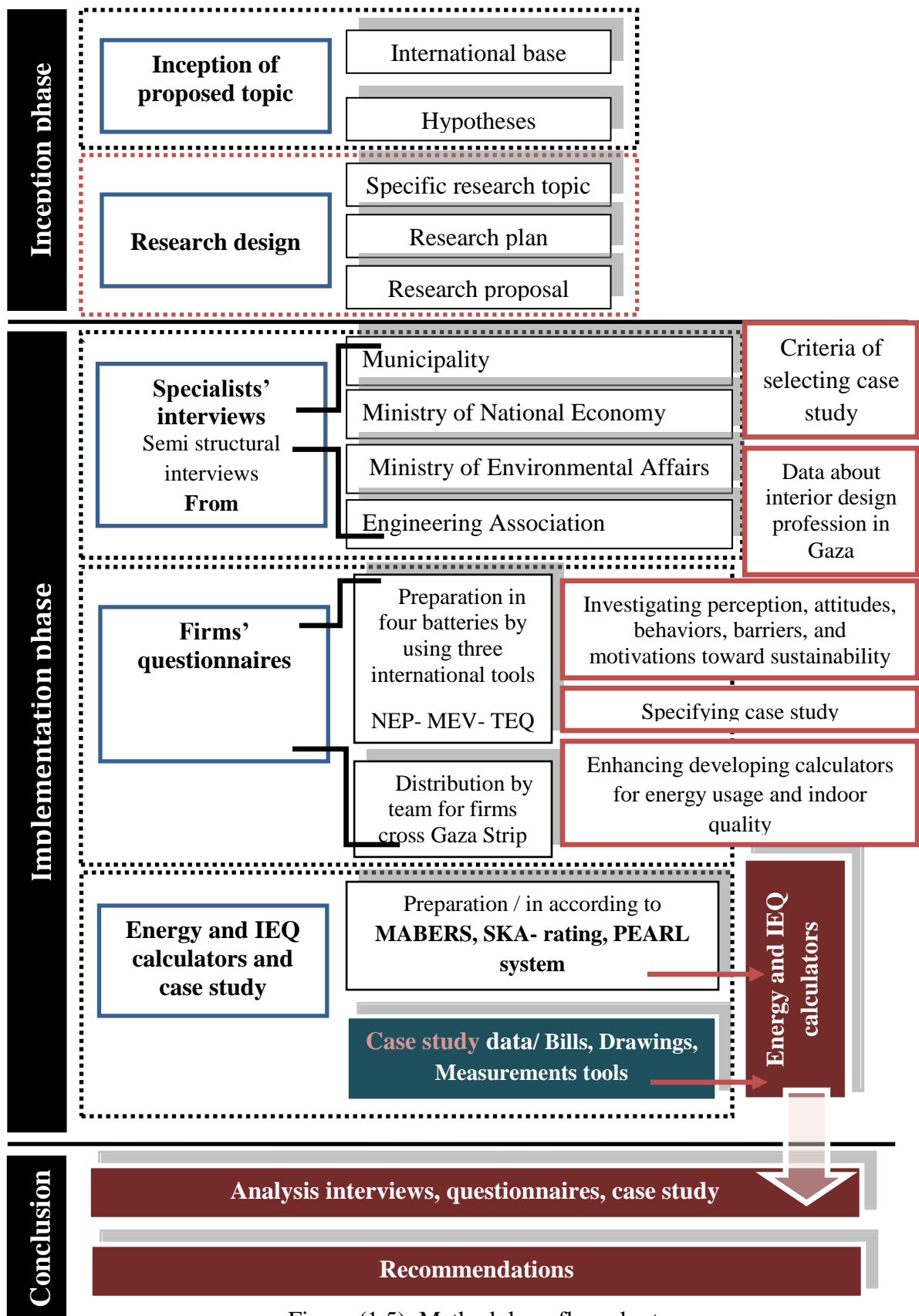

Figure (1.5): Methodology flow chart

Environmentally sustainable interior design

Energy efficiency and IEQ

2.1. Introduction

This chapter reviews the literature relevant to the sustainable commercial interior design movement and how the characteristics of indoor impact both of the indoor environmental quality and energy consumption. Some of international assessing tools is displayed. Then it focuses with details on the sustainable- environmental criteria within interior design in accordance to the four aspects available in the international indicators energy efficiency, indoor environment quality, efficiency of water use, and construction and demolition waste management. The strategies, standards, and measuring method are mentioned in details for the first and second indicators energy efficiency and IEQ.

2.2. Environmentally sustainable interior design

2.2.1. Environmental impacts for indoor spaces

Indoor spaces have a crucial impact on environment; whereas, People spend 90% of their time indoors with pollutant levels may be 2-5 times higher than outdoor levels(Kubba, 2010b). In addition, the energy consumption of the buildings that interior designers often work within represents the biggest threat to climate change in the built environment. The other changes are generating a significant quantity of waste, using for some time toxic materials that associate with high created pollution, unconsidered planning causing depletion of resources. Moreover, 1984 world organization committee report suggested that up to 30% of new and remodeled building worldwide may be the subject of complaints related to indoor quality(ESD, 2007). Thus it is difficult to some extant to practice interior design without causing any environmental damage. Design for interiors needs more consideration for environment.

The concept of considering the interior design as the most significant impact on sustainability of building, still commonly faced misconceptions. Refuting this idea is easy done by putting forward interior design as the most influent of environmental problems such as,

- According to the World Watch Institute (2006), about 10 percent of the global economy involves building construction, operation and equipment. More, using between 17 to 50 percent of the world's natural resources and potentially cause extensive damage to the environment(Cain, 2007).
- World health organization(WHO) charged with developing recommendations on methodology of monitoring indoor air quality by exposure to formaldehyde and nitrogen dioxide (NO₂), exchange ventilation rate measurements based on the

carbon dioxide (CO₂) equilibrium method, and evaluating presence of mould and dampness(JRC, 2011). Whereas, Indoor environments have shown significantly influence rates of respiratory disease, allergy and asthma symptoms, sick building symptoms and worker performance(Cain, 2007).

- According to LEED-NC (new construction), interior design may have control 13 of 57 points in inter LEED score card(Kubba, 2010a).
- Most of problems associated with shortcomings in indoor air may be one of the most common environmental health issues (Kubba, 2010c).
- U.S. Department of Labor (2003) statistics show that absenteeism averages 1.7 percent for private sector and 2.2 percent for public sector employees, which is due to poor indoor air quality, can be reduced by sustainable building practices((ASID), 2007).

2.2.2. Concept of sustainable interior design

Climate change and other environmental issues caused by indoor spaces are mostly occurred after completing the project when the interior designer is no longer involved. Therefore it needs urgently sustainable practices ,keys of solving, by designers who are in an ideal position to provide solutions (Cain, 2007). To simplify the many terms surrounding sustainability, sustainable developments can be used which written by the World Commission on Environment and Development which is "*meeting the needs of the present without compromising the ability of future generations to meet their own needs*"(Moxon, 2012)

Construction experts play a key role in contributing to the technological development among sustainable development that must lead all construction' process. Sustainable interior design approach consider the whole project's categories temporary, flexible, and long- term projects, despite having different requirement. Temporary projects or pop-up projects as exhibitions are established for creating a marketing gimmick or providing disaster relief. Flexible projects are common in retail sector where change is desirable to keep up with changing fashion. long-term interior projects will be for the residential, leisure, education, healthcare and commercial sectors (Cain, 2007, Omer, 2008)

Design process is a systematic process of conscious thought that integrates academic knowledge with imagination. Then, environmentally sustainable design can develop and communicate environmental solutions that are functional and aesthetic(Moxon, 2012). So, environmentally sustainable interior design can be defined as the method of minimizing negative effects and maximizing positive effects of indoor environmental systems over the life cycle of building (M.Kang and A.Guerin, 2009, Moxon, 2012). Sustainable interiors is defined as interiors designed in such a manner that they sensibly address the impact of all their functions, parts and elements on the global environment.

And also it is defined as the attempts to create indoor spaces that are environmentally sustainable and healthy for the occupants (Pilatowicz, 1995).

Recently, sustainability practices at design of interior are not a trend, but it is a necessity in the field of design. This practices convert the responsibility of designers to be not limited and adjust space planning and furnishing positions according to HVAC zone, mechanical rooms, equipment, selecting colors, finishing, lamps, and window operation and treatment relative to energy efficiency coordinating to passive solar energy and other sustainable approaches(M.Kang and A.Guerin, 2009).

To achieve sustainability, it is important to pay attention to create a balance between social, economic, and environmental dimensions, the three intersected aspects of sustainability as shown in figure (2.1). While practicing environmental criteria in a project, social and economic aspects of sustainable design can be easily realized (Kramer, 2012). This enhancing the concept of applying environmental aspects can achieve about 80% for other two economic and social aspects(Moxon, 2012).

Social design literate environmental design, this term can be affirmed when passing through the corporate social responsibility at sustainable practicing. Hence, it can be basically defined as the voluntary commitment of a firm to contribute to social and environmental goals, under this , environmental responsibility is an implied part of social responsibility (Lynes and Andrachuk, 2008).

Economic design literate environmental design, as environmental design is more often promoted based on economic aspects that it save in waste, water, and energy. At LEED tool water efficiency for commercial building can easily reduce at least water consumption by 30%; for example.

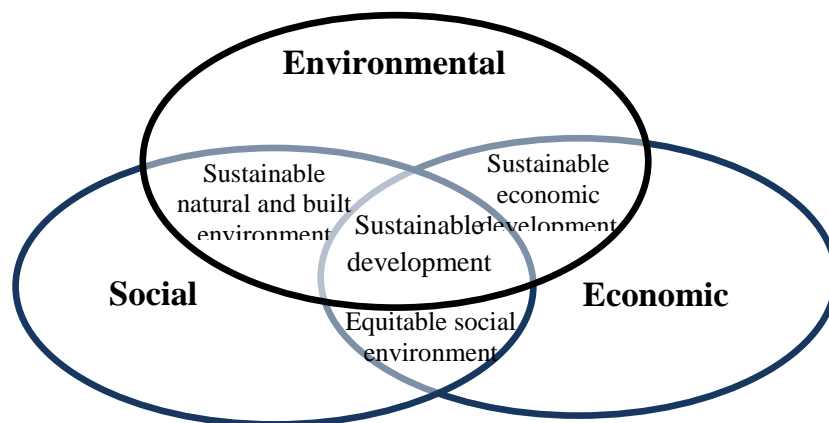

Figure(2.1): Solidarity of three aspect of sustainable design

2.2.3. Environmental assessment tools of Sustainable interiors

Environmental assessment tools are method to formalize a sustainable approach of the design. And then, explore how to make sustainable design choices about energy system and products. The role of these tools varies according to designers, owners, occupants' interests. For example, it helps designers to develop project toward a minimal environmental impact; then, satisfy the financial aspects for owners and create comfort environment for occupants. Table (2.1) outlines the main a available worldwide assessment schemes, the sectors they cover, the categories rating, and what stage they apply. Leadership in energy and environmental design (LEED) and Building Research Establishment's Environmental Assessment Method (BREEAM) are perhaps the best known and most widely used; however, some of the more specialist schemes are of particular relevance to interior designers, such as Ska Rating, which is intended for interior fit-outs, and NABERS, which measures the performance of existing buildings. There are other schemes Green Star, Green Globes, BEAM, CASBEE and DGNB(Cain, 2007) (Moxon, 2012, Ding, 2008).

Table (2.1). Environmental tools assessment







Assessment tools	Categories , stages, rating	References
<p>LEED Leadership in energy and environmental design</p>  <p>www.usgbc.org/leed</p>	<ul style="list-style-type: none"> ▪ Sustainable Sites, ▪ Water Efficiency ▪ Energy and Atmosphere ▪ Materials and Resource, ▪ Indoor Environmental Quality ▪ Innovation and Design Process ▪ Regional Priority <hr/> <ul style="list-style-type: none"> ▪ For new and existing commercial interior projects. <hr/> <ul style="list-style-type: none"> ▪ Silver, gold, platinum 	<p>(Kubba, 2010a)</p>
<p>BREEM Building Research Establishment's Environmental Assessment Method</p>  <p>www.breeam.org</p>	<ul style="list-style-type: none"> ▪ Energy ▪ Transport ▪ Pollution ▪ Materials and Waste ▪ Water ▪ Land Use and Ecology ▪ Health and ▪ Wellbeing, and Management <hr/> <ul style="list-style-type: none"> ▪ Both new and existing buildings can be assessed <hr/> <ul style="list-style-type: none"> ▪ BREEAM has five levels: Pass, Good, Very Good, Excellent and Outstanding. 	<p>(Moxon, 2012)</p>

Table (2.1). Environmental tools assessment

<p>Ska-rating</p>  <p>www.ska-rating.com</p>	<ul style="list-style-type: none"> ▪ Energy and Carbon ▪ Waste ▪ Water ▪ Materials ▪ Pollution ▪ Wellbeing ▪ Transport and Other ▪ Assessments are carried out at the design stage, at handover to the client and one year after occupation. ▪ There are four ratings: Unclassified, Bronze, Silver and Gold. 	<p>(RICS, 2012)</p>
<p>NABERS The National Australian Building Environmental Rating Scheme</p>  <p>www.nabers.com.au</p>	<ul style="list-style-type: none"> ▪ Energy ▪ Water, ▪ Waste ▪ Indoor ▪ Environment performance ▪ Projects are assessed during occupation, using performance data for the previous 12 months. ▪ Rating of up to 5 stars 	<p>(Ding, 2008)</p>
<p>Green Star Australia</p>  <p>www.gbca.org.au</p>	<ul style="list-style-type: none"> ▪ Management ▪ Indoor ▪ Environment Quality ▪ Energy ▪ Transport ▪ Water ▪ Materials ▪ Land Use and Ecology ▪ Emissions, and Innovation ▪ Existing offices is in the pilot stage ▪ rating from 0 to 6 stars 	<p>(Moxon, 2012)</p>
<p>BEAM</p>  <p>www.beamsociety.org.hk</p>	<ul style="list-style-type: none"> ▪ Site Aspects ▪ Materials Aspects ▪ Energy Use ▪ Water Use ▪ Indoor Environmental Quality ▪ Innovations and Additions ▪ new and existing buildings rating of Bronze, Silver, Gold or Platinum 	<p>(Ding, 2008)</p>

There are other worldwide assessment tools as Japan Green Build Council's Comprehensive Assessment Systems for Building Environmental Efficiency (CASBEE), Design Quality Indicator (DQI), Evaluation Manual For Green Buildings (EMGB), Environmental performance guide for building EPGB(Ding, 2008) (Moxon, 2012).

While as, this assessment tools are internationally available, the first attempt among the Arab world which is the Pearl design system for the emirate of Abu Dhabi-rating method for residential and non- residential buildings. It prepared by Estidama program center at Abu Dhabi urban planning council. It conclude criteria of choosing living system, materials, and how reducing energy, water, then how managing waste (Estidama, may, 2009).



2.2.4. Environmental aspects of sustainable interior design

Aspects of sustainable interior design are categorized in correspondent and integral way with assessment tools available worldwide. These aspects mostly include energy use, materials, IEQ, water use, and waste management.

While this thesis discusses energy use and Indoor environmental quality for commercial buildings, and assessing the IEQ will reflect the good selecting materials. Then, IEQ section will include materials criteria.

Both of water and waste managing also have important influence for more sustainable interior design. **Firstly**, unconsciously using of water heighten scarcity of water, climate changes, and fuel depletion. So, the role of interior designers toward water saving, reducing water, recycling, and assessment of water efficiency, is very influential. Despite the ease of applying sustainable using of water strategies, it cannot come by only interior designers; hence, it need team working with architect, landscape architecture, and service engineering. Then, designers roles is to Maximize water efficiency within buildings to reduce the use of municipal water supply and wastewater systems(MCAA, 2007) (Moxon, 2012). For example in LEED, the aggregate use of water should be 20-30% less water than the water use baseline(VA et al., 2007). Water conservation has a priorities to apply first, passive design, followed by water efficiency, the reusing and recycling. Each one can be ensured by:

A. Passive design

It is controlling rainwater run- off, then discharging in to water store. It can be used for watering plants to reduce need of portable water. It is mainly relevant to build up surrounding area termed Sustainable Urban Drainage System (SUDS).

B. Water efficiency

It is improving technology and practices to enhance deliver equal or better services with less water. It deal typically with interior designers' roles by using water saving sanitary fitting, water saving appliances, and water meter(Moxon, 2012). For example, Water Closets should be 1.6 gallons/ flush for more efficiency, and faucets 2.5 gallons/ flush(VA et al., 2007). Then the following criteria should be enhanced.

- The building should provide with dual flush and automatic controls.
- Infrared sensors should be presented for ablution fixtures, and then it reduces consumption by 0.9 %.
- Irrigation works should be at a maximum rate of 0.875 liter/ year.

C. Water reuse and recycled

Water re-use and recycling are used to support passive design, while it can be categorized in three: rainwater re-use; grey water recycling; and black water recycling(Moxon, 2012).

Secondly, Buildings are responsible for sending around million tons of waste annually; therefore, more efficient use of materials would be a major contribution in reducing the environmental impact, reducing demand for landfill, and contribute to economic efficiency. The following are the minimum considerations do the building conforms.

- Well Designing out of the waste, then written plan for construction and demolition (C&D) waste is required.
- Using materials with ability of reducing and recycling.
- 80% of waste are planned for reusing, recycling. Then the maximum waste delivers to landfills.
- Providing plans to segregate the waste by using multiple located contraries.

2.3. Efficiency of using Energy

Buildings are considered one of the biggest energy consumers, for they demand large amount of energy. Globally, buildings are responsible for approximately 40% of total world annual energy consumption in the form of lightning, heating, and cooling(Omer, 2008) .On the other side, about of 27.59% of annual energy consumption can be saved by choosing best orientation, optimize size of windows and shading devices, and optimum isolator thickness(Jaber and Ajib, 2012). It enhances the fact that sustainable development must have the momentum in interior design impact on the environmental through the indoor. Despite this, the responsibilities both of designers and users, the designers have the dominant role that can orient the users' behaviors.

Every interior design project offers opportunities to reduce this energy use, particularly in the context of a total renovation or as part of a new building. The greatest areas of opportunity include the building envelope, lighting, appliances, heating, cooling and ventilating systems, and alternative energy sources((ASID), 2007). Energy efficient

interior spaces can be designed after answered two questions, how and why building use energy that is used usually in two forms: electricity and gas. The low- energy design depends on designers and project's priorities. The following strategies can reduce using energy. Passive and renewable design is basically related to architectural design, and affect the indoor efficiency(Moxon, 2012).

- ❑ Passive design taking into consideration the climate parameters in order to minimized the heating, cooling, lightning..etc.
- ❑ Supplying the needed primary energy from renewable source as much as.
- ❑ Choosing energy- efficient products to ensure that electricity is used efficiently.

Figure (2.2) show three strategies for reducing energy at interior spaces. Some of these strategies depend basically on the architectural design, but interior designer must be aware of efficiency design criteria for lightning, appliance, heating and cooling system. The design criteria for this aspects reviews below in accordance to passive design, energy efficiency and renewable sources.

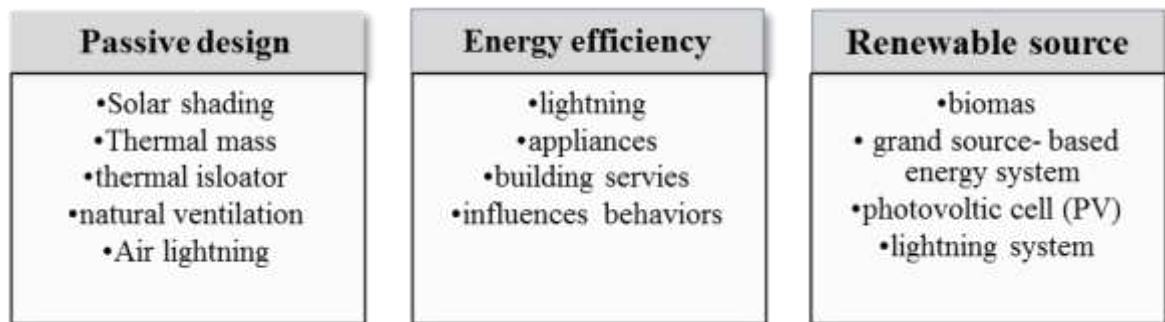

Figure(2.2)Energy reduction' strategies (RICS, 2012, Moxon, 2012)

- A. **Passive design** is the way in which designers can minimize the energy required by their design. as the design manipulating the building's orientation, shape, layout and envelope to gain as much as the advantages of natural energy(Moxon, 2012).
- B. **Energy efficiency** is concerned with maximizing the use of energy resources while providing the desired environmental conditions and services inside the building at the least cost. In engineering, it defined as the ratio of the desired output (useful effect) to the required input (used resources) of any system. Thus, energy efficiency (η) can be defined as the ratio of useful energy output to energy input(Pérez-Lombard et al., 2012).

$$\text{Energy efficiency } (\eta) = \frac{\text{useful energy output}}{\text{energy input}}$$

Another approach to the definition of energy efficiency relates used energy (input) and provided service (output). The ratio of energy input to service output is called energy intensity meaning the amount of energy needed to provide the unit of service(Pérez-Lombard et al., 2012).

Efficient energy consumption per square meter of commercial building varies enormously throughout the world as illustrated in table(2.2)(Simons and Bean, 2001).

Table (2.2): International store energy comparison.

Region	Benchmark (kwh/m ² . Pa)
Netherlands	312
Sweden	390
Malaysia	523
USA	550
Peru	639
CIBSE, Uk	670
Australia	1000

Benchmark for energy consumption is ranged from 312 to 1000 Kw per hours for each meter cube for commercial buildings.

C. **Renewable sources.** Renewable energy systems are the next thing to consider, after passive design and energy-efficiency have been incorporated. They produce energy from renewable sources, rather than finite sources like fossil fuels. The most common small-scale renewable energy technologies are biomass, wind power, solar thermal heating, photovoltaic cells (PVs) and heat pumps(Moxon, 2012) (Omer, 2008).

2.3.1. Lightning saving energy opportunities

Energy consumption of the lightning in building is a major contribution to carbon emission, and estimated as 20- 40% of total energy consumption (Jenkins and Newborough, 2007) . Accordingly, Lighting energy can generally be reduced by 40~80% by installing more efficient lighting Fixtures. Project payback period for advanced lighting systems in commercial building is usually quick because of the long operational hours. So, this review is intended to inform a wide range of readers about the importance of light; both natural and artificial. Hence, several studies views strategies to reduced energy used for lighting as it can be summarize in two strategies that shown in figure(2.3):

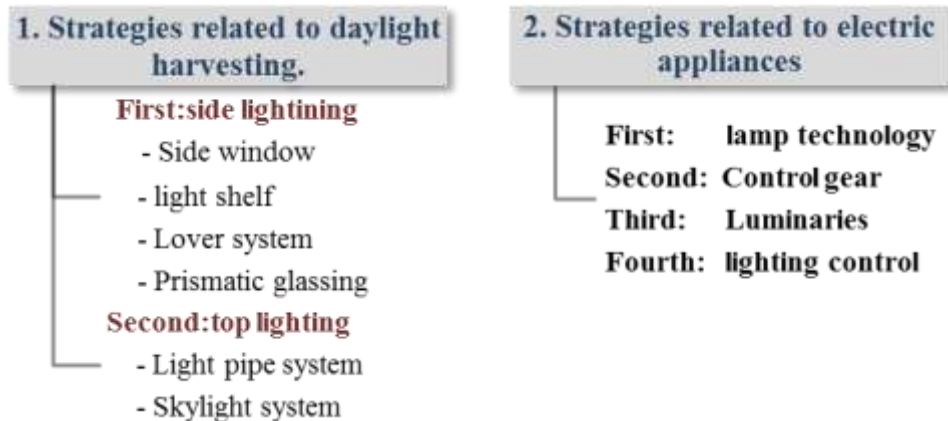

Figure (2.3). Lightning strategies for reduce energy Source (Moxon, 2012).

2.3.1.1. Strategies related to daylight harvesting.

Most of commercial spaces have enough daylight in exterior environment what eliminate the need for electric lightning during most working hours. daylight utilization allows efficiency (Alahmad et al., 2011). This strategies requires carefully designing for fenestration's area, shape, materials, orientation, and shading in order to optimize the quality of luminous environmental for occupants with low- energy use and visual comfort patterns. J. Bokel(2007), shown that it is possible to calculate the yearly energy demanded for heating, cooling, and electric lightning as function of window position, window size, and window shape. The study present that the optimal window size was around 30% of the façade area where the window is positional in the top half of façade. A window size starting at 50%the advantage of a large glass area on the lightning load is negligible. After this limit, As window area increases, the Energy load increase (Yildirim et al., 2007).

Ajib and Jaber(2011) discussed the best size of the window for building located in Mediterranean region. The optimum minimum window size reaches both day lighting and human comfort, is 10% for the façade area. Then By using TRNSYS soft, it estimated the size for all for façade, and concluded that optimum windows size is 10% and 20% for north and west façade respectively. Moreover, the optional percentage of window for both south and east façade is 40% from the local area. And shading device for south façade is economically sized to avoid summer sun today. The energy consumption in winter season is reduced by 5.06% while in summer is reduced by 8.6%, and the annual energy consumption is reduced by 7.36%(Jaber and Ajib, 2012).

Efficient Architectural or interior Design can be attained through numbers of strategies for both side and top lightning to gain optimum performances in sustainable buildings.

A. Side lightning system

- **side window**, it is simple way inside lightning which related to the area of windows, although it has some challenges as no enough area in spaces for windows, decreasing the daylight concentration as the spaces is deeper, and controlling the daylight if the sun is excessive which makes occupants uncomfortable. It was showed that using side windows in a typical six stories office building can save energy for lightning in about 56-62% and reduce in CO₂ emissions of nearly 3 tones(Li et al., 2010) (Ryckaert et al., 2010). The size if windows affected both heating and cooling system as shown in figure (2.4) and (2.5)(Rajkovich et al., 2011, Jenkins and Newborough, 2007).

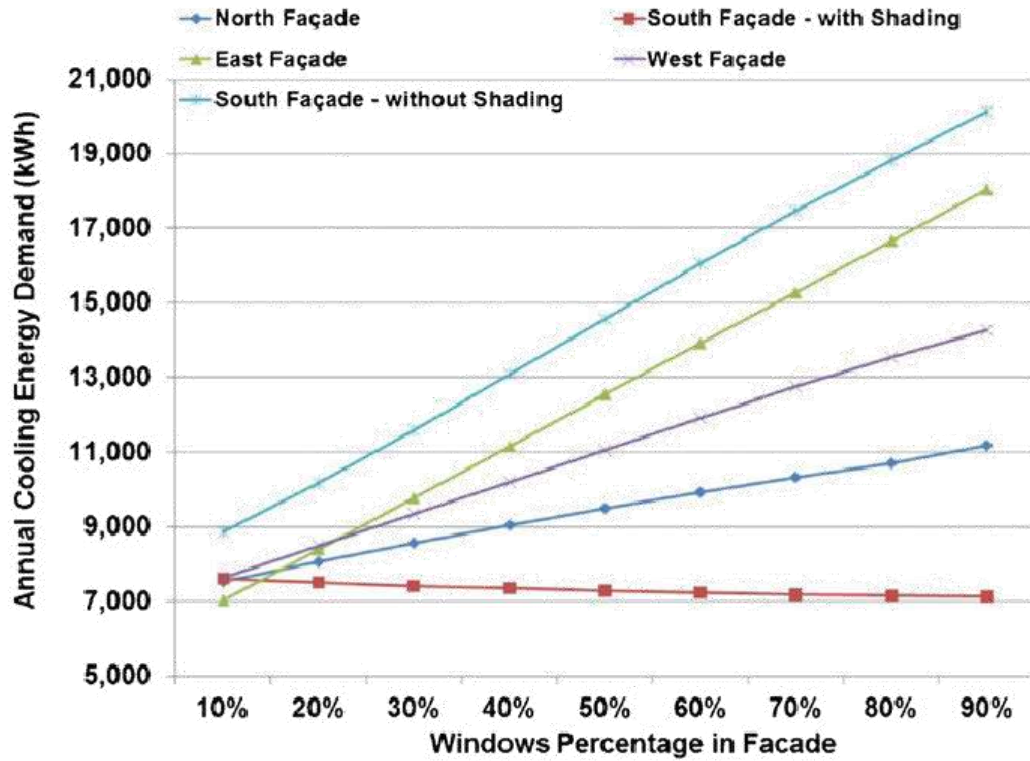

Figure(2.4): Annual cooling energy at different windows size (Trust, December,2011)

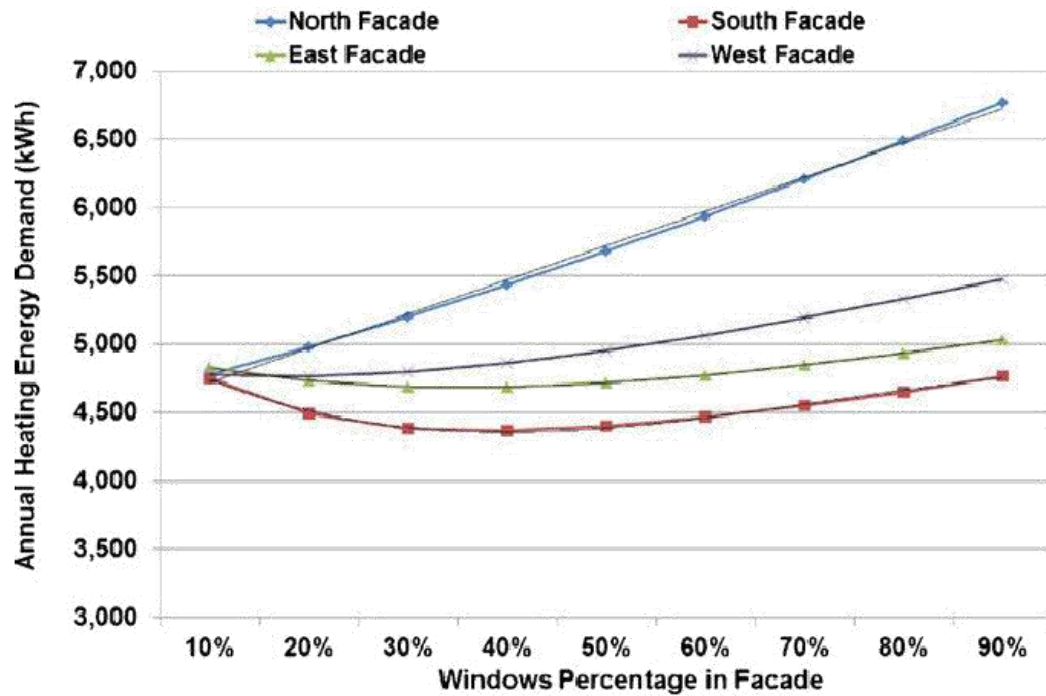

Figure(2.5): Annual heating energy at different windows size (Trust, December,2011).

There are software tools that enable interior designers and architects to confirm environmentally the window's area used in any design which shown in the table (2.3).

Table (2.3). Software tools using in lighting analysis

Tools	Description	Ref.
BRE	Protractors and diagrams BRE Daylight factor protractor could be used to do a quick day lighting analysis.	(Attia et al., 2012)
Ecotect	Ecotect software tool (AutoDesk, 2010) is exported and properly edited to conduct a detailed lighting simulation using Radiance.	(Laouadi and Coffey, 2012)
RELUX	RELUX is used as the simulation tool to calculate daylight factor and illuminance distribution, The energy saving potential of using.	(Linhart and Scartezzini, 2010)

BRE, Ecotect, and RELUX are the more used programs by designers, while there are others programs.

- **Light shelf**, it is a device designed to control day light, and redirect sun light toward the back of the space by reflecting it off the ceiling. The light shelf can provide shade from direct sunlight and decreases glare from the outside as shown in figure (2.6) that while using light shelf, the lighting is perfectly distributed among all space. It is useful specially for commercial indoors that it work primarily with windows that have a large amount of glazing area at a height greater than 2.2 meters (Shi and Chew, 2012, Boubekri, 2008)

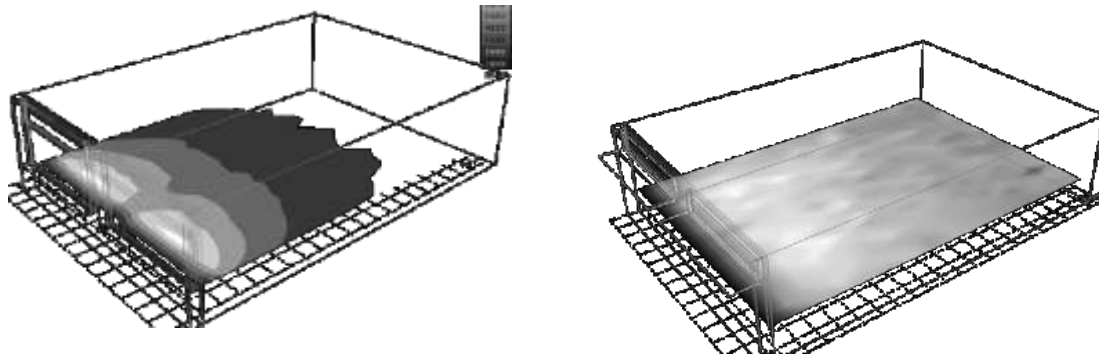

A. Distribution light without light shelf

B. Distribution light by using light shelf

Figure (2.6): Controlling light with using light shelf (Boubekri, 2008) .

Light shelf requires a simple procedure and materials to realize the main concept of it shown in figure (2.7) and (2.8). To design a well-organized function of light shelf needs:

- The windows should face toward the sun.
- Light shelf must be a reflector as aluminum foil taped to a piece of cardboard.
- It has to be installed above the level of people's head.
- The ceiling should be highly reflective to conserve as much light as possible.
- The lower portion of the window need separate treatment to prevent glare, as installing an internal shade or external shade.
- Venetian blind is used to reduce heat gain in the space.



Figure(2.7): Interior light shelf (America, 2009)

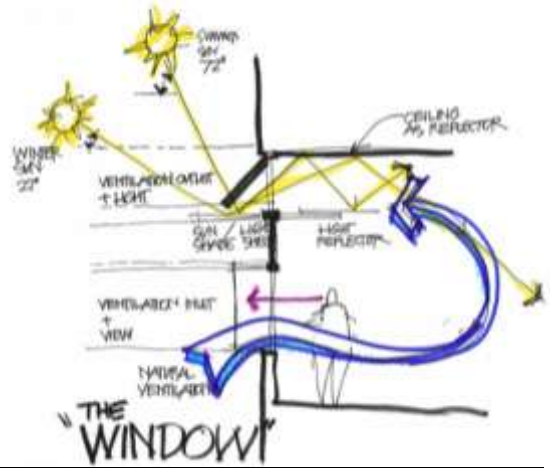

Figure(2.8): Concept of light shelf (OSC, 2009)

Commercial buildings usually have long exterior walls, since with typical clear windows, the light may be deepened to 3-7 meter. Light penetration may be deeper if the windows are very tall. Light shelf can save in electricity ranged from 30-120 watts per meter. It can be provided with automatic light switching in order to dim or turn of when daylight is provided. At night the space will be illuminated with artificial lighting, and then the light shelves may contribute with the illumination. A small amount of tilt may also improve performance as shown in figure(2.9), for it increase the penetration of light into space and introduces the possibility of reflecting sunlight into occupants at low angle(Ochoa et al., 2012).

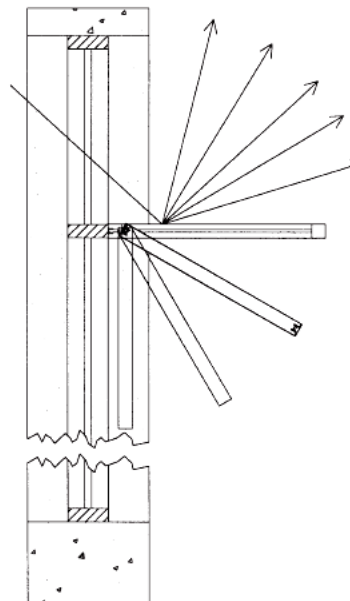

Figure(2.9) Tilting light shelf (Ochoa et al., 2012)

- **Louver system**, it captures sunlight falling on the façade and redirects it toward the back of the space, then it increase daylight levels in the back and reduce them in the front. It may be static or dynamic depending on required performance.(word16)

The optimal static angle for horizontal façade is 20° and it can save 32% of energy use. The optimal angle for vertical louvers on east and west façade was 20° that can save 26% and 25.9% on the east west façade as shown in figure (2.10)(Boubekri, 2008).

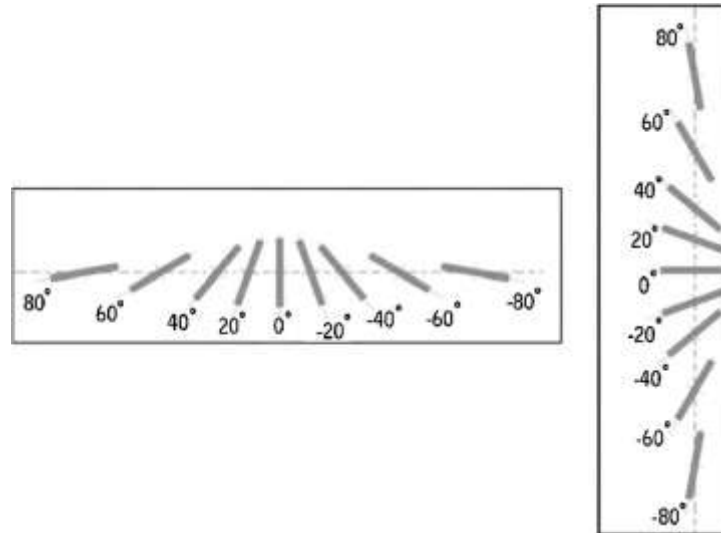

Figure(2.10): Plan view showing angles of horizontal and vertical louver

(Boubekri, 2008)

- **Prismatic glazing**, it changes the direction of sunlight by refraction and reflection (Boubekri, 2008). Prismatic glazing, the light is completely distributed through the space. Hence, the part of sunlight goes to the ceiling then reflects to deeper space. The other part of light goes directly to the wind on place. This distribution of light must be controlled by the space's requirements and occupancies (Kolokotsa et al., 2012).

It is usually made of acrylic in size of 206mm* 206mm, ant it may be produced with silvered prism for reflection. It is useful for high windows as factories or commercial halls. It saves energy used for cooling, as it reduces 10% of radiation on vertical façade on summer days, and 90% on winter days (Li et al., 2010).

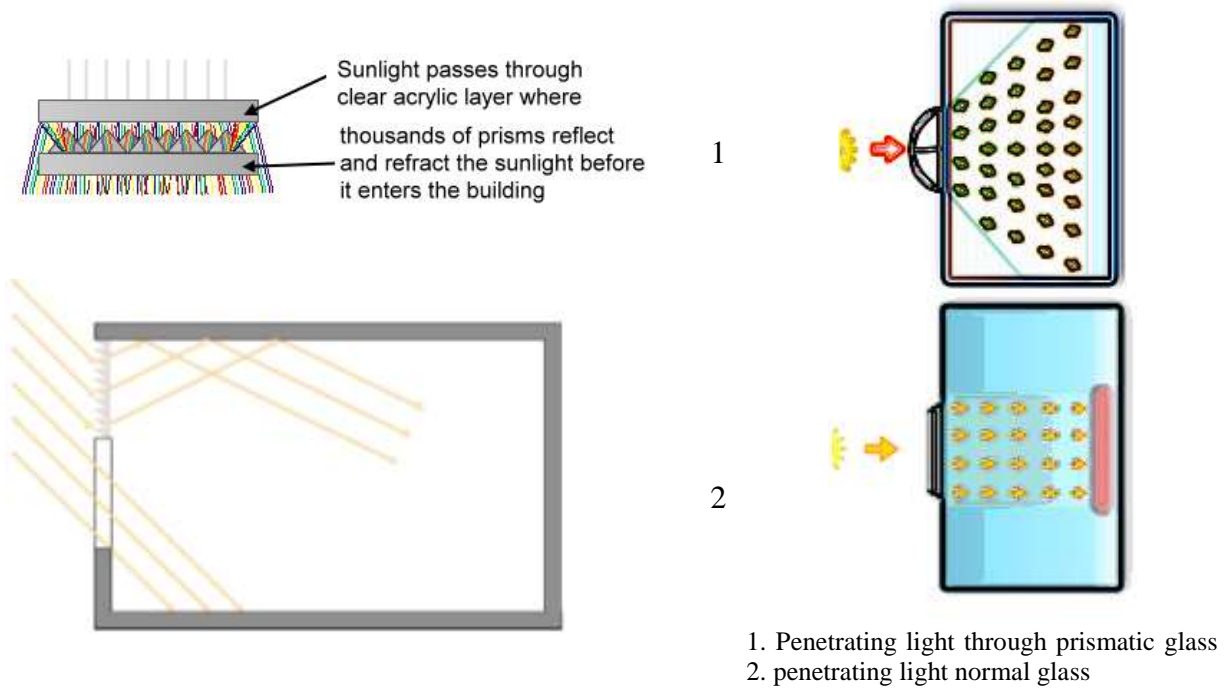

Figure(2.11): Concept of prismatic glazing (Simons and Bean, 2001)

Shading devices that perform the double role of protection against solar radiation and redistribution of available daylight, therefore, they have the potential to minimize overall energy consumption in two ways. Firstly, by reducing cooling loads through their shading function, and secondly, because of the better luminous efficacy of daylight, by reducing the use of artificial lighting through their light distribution function(Kolokotsa et al., 2012).

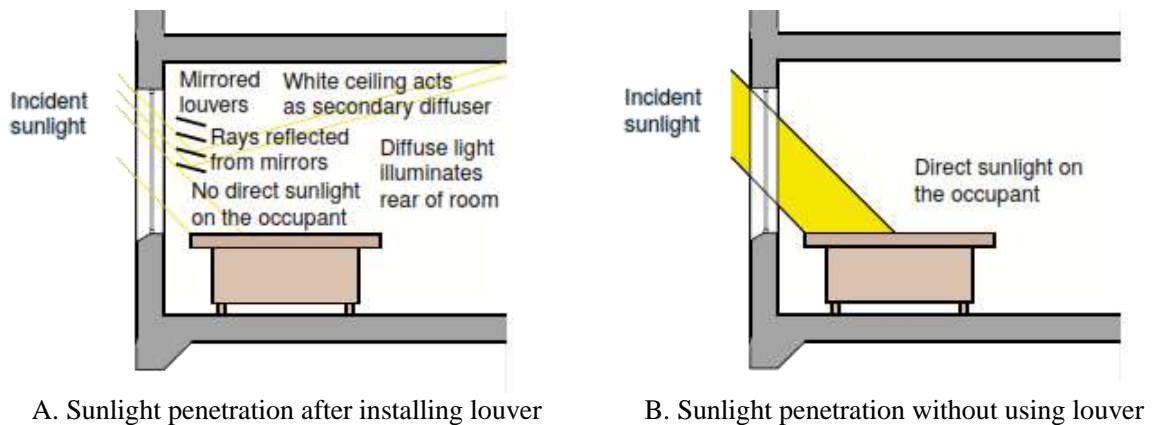
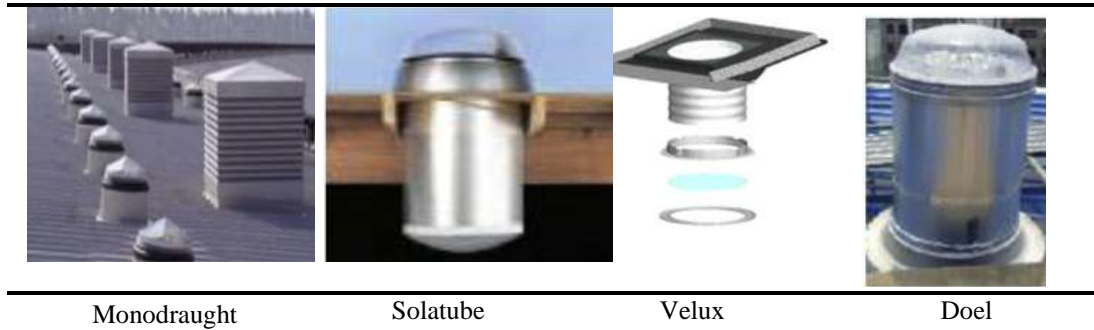

Figure (2.12): Effects of Using louver (Kolokotsa et al., 2012)

B. Top lighting system

□ **Light pipe**, Light tubes or light pipes are used for transporting or distributing natural light. In applications for day lighting, they are also often called sun pipes, solar pipes, solar light pipes, or daylight pipes. Currently, various light pipe systems are commercially available and each system has its own characteristics and effectiveness as light pipe systems manufactured by Monodraught Ltd (UK), Solatube International Inc. (USA), Velux (Denmark), and Doel Corp(Korea) as shown in figure(2.13)(Kim and Kim, 2010).



Figure(2.13): Top lighting system (Kim and Kim, 2010, D. Loe, April, 2003)

As an example, At Dartmouth supermarket, the diameter of sun pipes is 750mm, the sun pipe installed over skylight that it is suitable for thick roof. It has 144 sun pipes installed in 16 rows. The reflection of walls, ceiling, and floor were 0.7, 0.9, and 0.2. The sun pipes have transmittance of 0.8 and windows glazing have transmittance of 0.8. Then, the actual energy saving could be larger when the artificial lights are dimming- controlled lighting. As shown in figure (2.14). By using RELUX software the energy has been determined, and the result has shown potential 22%energy saving annual(Su et al., 2012).



Figure(2.14): The supermarket's model in RELUX (Su et al., 2012)

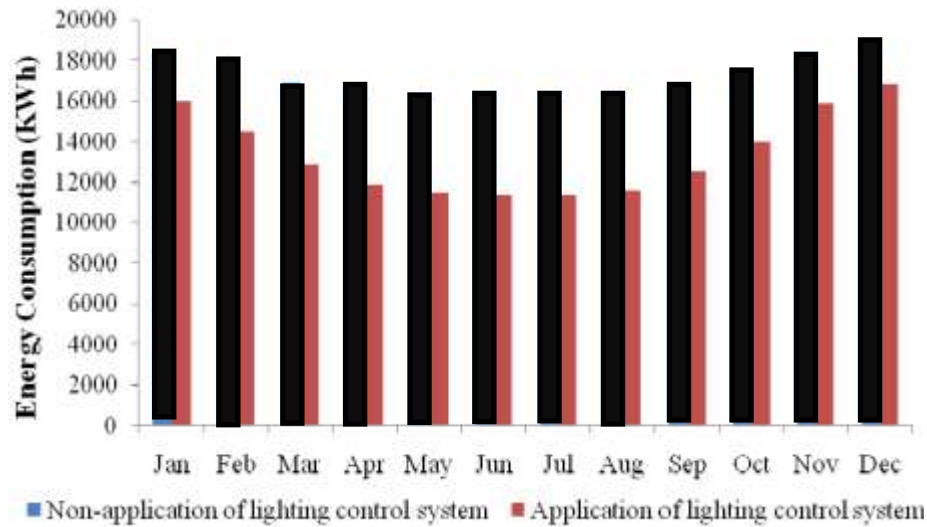

Figure(2.15).Annual energy consumption of the studied supermarket, with and without the application of a lighting control scheme (Su et al., 2012)

□ **Skylight system**, it is used to provide a horizontal or slanted opening in the roof of the building, it is architectural solution strongly affecting space performance (Laouadi et al., 2003), using a computer simulation program to predict the impact of design alternatives on the annual cooling and heating energy of skylight system in cold climate. As compared with a closed atrium space, an open atrium space reduced annual cooling energy ratio by about 62–70% for enclosed atrium, by about 34–40% for three-sided atrium and by about 22–27% for linear atrium. Annual heating energy ratio of the open atrium space was also reduced by up to 6% for the linear atrium. The annual heating energy ratio for the enclosed and three-sided atriums increased by up to 19%(Ryckaert et al., 2010).

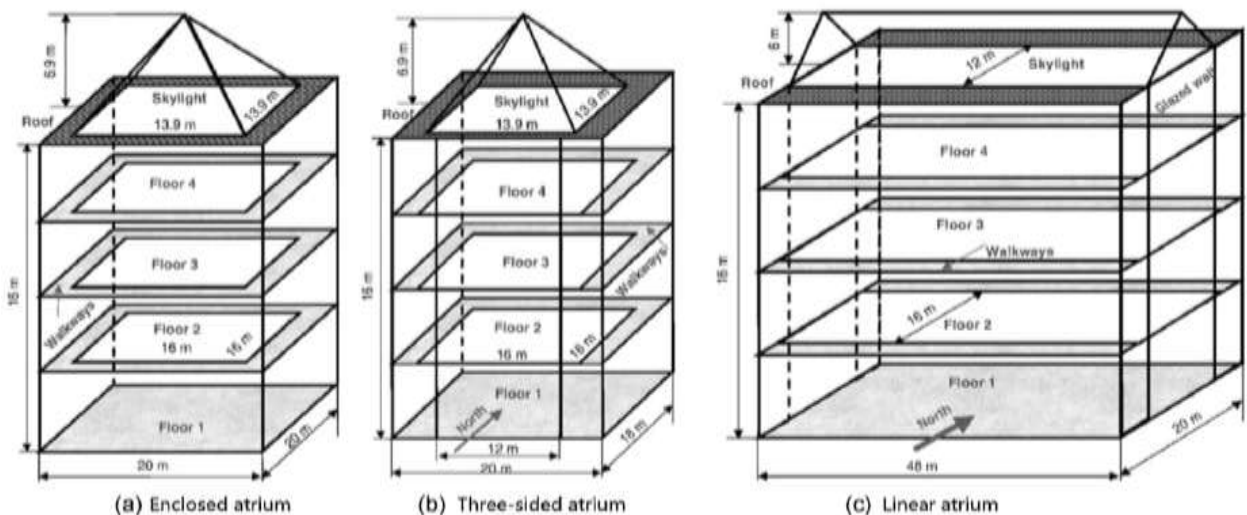

Figure(2.16): Atrium shapes as simulated with pyramidal (Laouadi et al., 2003)

2.3.1.2. Strategies related to lighting appliances.

High Efficiency Lighting Units (HELU) are the light fitting on luminaries or lamps, and control gear in either single package unit or remote control gear. In addition, HELU can also incorporate controlling devices such as dimming and presence controls((ECA), 2011). several attempts were done to develop efficiency appliance such as Energy technology List(ETL), and code for lighting and carbon trust's lighting technology overview(CTV021) that improved a list of efficiency light using in building.

Around 30 40% of electricity consumption could be saved by using more efficient lamps and luminaries together with appropriate lighting controls(DECC:Department of Energy and Climate Change et al., 2009). Actually, designers response to lighting criteria which related to choosing light's color in right place and time; nevertheless, energy management and saving, is respected. Designers should understand how to choose artificial lighting equipment that will deliver the most energy efficient solutions without compromising on quality.

Energy consumption of a lighting installation can simply be established from the following relationship(Jaber and Ajib, 2011):

$$\text{Energy consumption} = \text{Total Power Load} * \text{Operating Hours}$$

So, energy consumption can be reduced by minimizing the total connected power loading or by reducing the operating period associated with lighting installation or, by a combination of the two. Significantly, energy saving is realized four key components of lighting design. Whilst, each component draws a level of efficiency, but all four components together will produce greater efficiency level. These efficiency components are(Trust, December,2011).

- Improvement in Lamps technology
- Improvement in Control gear technology
- Improvement in Luminaires technology
- Lighting control

A. lamp technology

Lamps have different commercial forms which can be classified as incandescent lighting, discharge , and solid state lighting (Dubois and Blomsterberg, 2011).

- Incandescent lamp**, is generated when a electric current passes through a wire; since then, the white and hot glow is created. It is widely used in commercial indoors shops, hotels, and restaurants. It is economical and provide up to 15 times increase in durability for these types of lamp(D. Loe, April, 2003).



Figure(2.17): Incandescent lamp

- Discharge lighting**, is which produces light as a result of gas discharge and phosphors. Examples of lamps that use this process are as shown in the following table.

Table (2.4). Discharge light types.

Discharge lighting types

Fluorescent are applied in tubular or Compact Florescent Lamp (CFL).

- It has High efficiency around 80 lumens per watt.
- It's time life vary around 6,000 hours for compact fluorescent, and 12,000-70,000 hours for tubular.
- It is easily controlled, for it can be switched on, off, and dimmed with the right control gear(Trust, December,2011).

Florescent



Figure(2.18). Compact fluorescent lamp (energy, 2012)



Figure(2.19).Tubular fluorescent lamp ((ECA), 2011)

Low pressure sodium light

- Low pressure sodium is the most efficient light when there is no need for dimming. It is orange that seem to turn all colors a dirty brown. Hence, it mostly use outdoor.
- It has efficiency around 40-150 lumens per watt.
- It's life time is around 15,000 hours.



Figure(2.20):low pressure sodium lamp source:(studio, April, 2012)

High pressure sodium

- High pressure sodium are bright golden lights, so it used in warehouses and outdoor.
- It has high efficiency around 125 lumens per watt, and has life time around 20,000 hours. However, they can be dimmed; they aren't easy to switch on and off.



Figure(2.21).High pressure sodium Source:((ECA), 2011)

Table (2.4). Discharge light types.

Metal halide and ceramic metal halide	<ul style="list-style-type: none"> ▪ Metal halide and ceramic metal halide are highly efficient source around 95 lumens per watt, typically often use in shops to highlight, and also stay of the most sport stadium. ▪ It has life time around 5000-20,000 hours ((ECA), 2011, DECC:Department of Energy and Climate Change et al., 2009).
High pressure mercury	High pressure mercury are light, they aren't efficient around 50 lumens per watt. And has life time 20,000 hours((ECA), 2011).

All these types of Discharge light have more efficiency and long life time. They cost more than non efficient device, but they have low cost by long term.

- **Solid state lighting**, have two types are quite different in form and in their potential applications, Light Emitting Diodes(LED), and Organic Light Emitting Diodes (OLED)shown in figure (2.22) ((ECA), 2011).

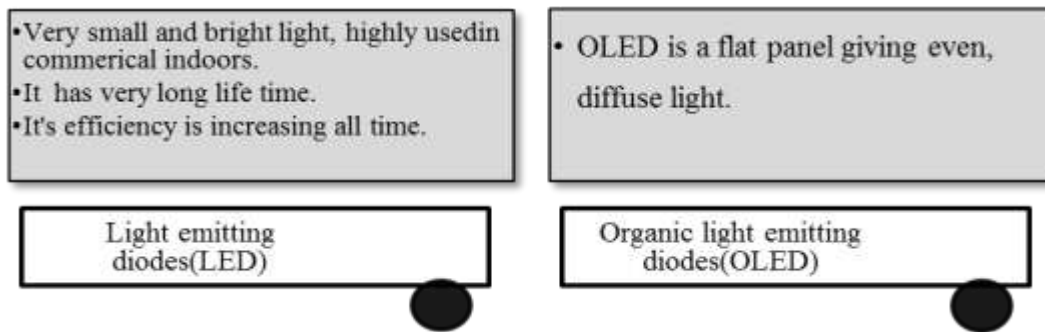

Figure (2.22): Solid state lighting.

B. Control gear

Control gear is to improve the quality of artificial light by driving the lamp at a higher frequency (HF) with no perceptible lamp flickers that can be distracting and discomforting. Headaches, eyestrain and, in extreme cases, epileptic seizures can be experienced. Control gear's role is preserving the lamp life that is important factor to cost of lighting.

C. luminaries

Luminaries are electrical devices used to create artificial light. They have a huge range of types and designs. Modern types of Luminaries, incorporating good optical design, are very efficient compared with older fittings. This means that new lighting installations can provide the required lighting levels within spaces by using fewer lamps than in the past and, therefore, with lower energy usage. Figure(2.23) shows the components of Luminaries lamp, lamp holder, housing, reflector, lamp, and control gear; Moreover,

some of luminaries have diffuser(DECC:Department of Energy and Climate Change et al., 2009).

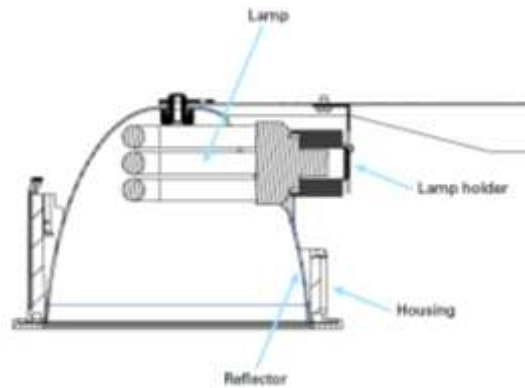

Figure(2.23): Luminaries' components
(DECC:Department of Energy and Climate Change et al., 2009)

The performance of luminaries depends not only on emitted light as shown in figure (2.24), but also on the optical design and qualities materials. The reflecting ability varies from 0.5 for chrome and 0.9 for aluminum materials with silver coating. Figure(2.25) illustrates most of Luminaries used in commercial spaces(Dubois and Blomsterberg, 2011).

The introduction of T5 lamps in 1995 allowed a 40% reduction in energy use compared to T12 lamps, while the addition of reflector material in lighting fixtures with dimming allows reduction anther 40% of energy. This means that modern lighting installations can use only 20% of energy used by older installation. The main optical control methods that are used in the design of Luminaries are diffusion, reflection, refraction, and obstruction(Dubois and Blomsterberg, 2011).

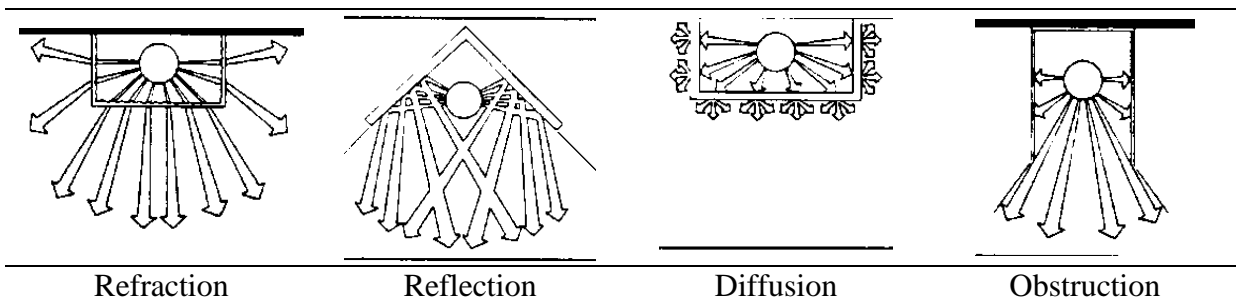

Figure(2.24).Luminaire light control methods ((ECA), 2011)



Figure(2.25).The most typical Luminaries used in commercial (DECC:Department of Energy and Climate Change et al., 2009)

D. Lighting control

Control the lighting is an appreciable step to reduce energy use between 30%-50%. Controlling lighting is merging the right light in right time and place through switching off or dimming the right when there is no necessary use of electricity. For example, on day lighting, it may switch off, and on specific tasks and activities. Automated functions should be combined with user's controls that sensors can monitor daylight and manage operating hours by time clock. Moreover, and many users make their own controls (shown in figure (2.25)). Moreover, improving maintenance, reducing maintained illuminance levels are contributed to reduction of energy(Dubois and Blomsterberg, 2011) (D. Loe, April, 2003). Generally, lighting control has various strategies for reducing electricity use. Although each one has appreciable contribution in energy saving potential as shown in table (2.5), investigating all these techniques as much as possible will be better.

Table (2.5). Overview of energy saving strategies and relative energy saving potential (Dubois and Blomsterberg, 2011)

Energy saving strategy		Relative saving potential
1	Improvement in lamp technology	10% T12to T8 40% T12 to T5
2	Improvement in control gear	4-8%
3	Improvement in Luminaries	40%
4	Lighting control	
5	Use of task/ ambient lighting	22-25%
6	Improving maintenance factor	5%
7	Improving utilization factor	Depend on application
8	Reducing maintained luminance level	20%
9	Reducing of total switch –on- time	6%
10	Use of manual dimming	7-25%
11	Use of switch off occupancy sensors	20-35%
12	Use of daylight dimming	25-60%

Interior designers should carefully select lighting devices, as All these strategies is mostly depend on the way of selecting.

- **Use of task/ ambient lighting**, depends on separating the element of task lighting and building or amenity lighting and to control them both independently in integrated way. It can save around 22% (compare to fixed general lighting solution). It can be used where daylight could provide an ambient level of light adequate for circulation and general tasks, and electric task lighting could provide higher localized illumination. In Danish code, the lx required for task differs from surrounding tasks such as task 500lx, 200lx in immediate surroundings, 100lx in remote surrounding and 50 lx for general lighting(D. Loe, April, 2003) ((ECA), 2011).
- **Improving maintenance factor**, that refers to the ratio of the average luminance on the working plan after a certain period. All of lamp burnout, lamp lumen maintenance, luminaries' dirt depreciation, room surface reflectance, routine cleaning of light devices and room surfaces, are taken in account of MF. For example in offices, shops, which normally become very dirty, the lighting output can be reduces by up to 5% per year((ECA), 2011) (Boubekri, 2008).
- **Improving utilization factor**, that depends on making the most of any light sources available by directing the light to where it is needed. This depend on the arrangement of light in relation to the task, the reflectance of surroundings , and luminous intensity from luminaries(Boubekri, 2008). Where,

$$\text{Utilization factor}(U) = \frac{\text{The initial luminous flux reaching the task}}{\text{The luminous flux from the luminaries}}$$

- **Reducing maintained luminance level**, this strategy has influential effects on commercial building; hence, sale area is generally designed for high lighting level around 1000lux, as there is belief that bright light is attractive to customers. Indeed, designer should not exceed the prescribed luminance level over the task area. For example, USA and Canada recommended 300-500 lx for the area, and in Sweden, an luminance of 500lx is also recommended on task area for individual office, and 300 lx for landscape office. Although, many studies indicate that levels of luminance can be lower than the recommended by the standards. Others claimed that lighting practice that uses 500 lx as the target for maintained luminance is excessive. And by using 400 lx as deign criterion, 20% decrease in energy consumption can be satisfied(Boubekri, 2008, DECC:Department of Energy and Climate Change et al., 2009).
- **Reduction of switch on time**, this affects the electricity consumed; many countries implement limiting range of total switch- on time. For instance, in European standard the total utilization time is 2500 h/yr for commercial building corresponds to about 48h per week and 9.6 per day(5day/week), and in the Swedish context the time is 2600h/ yr. the result is reducing annually energy use by 6%(Dubois and Blomsterberg, 2011).
- **Use of manual/ automatic diming and occupancy sensors**, is commonly the case that lighting installations are switched on when occupants enter a room because daylight levels are insufficient. It is also common for lights to be left on even when daylight levels have increased and may be sufficient to meet the needs of the occupants. There are two main types, infra-red heat sensors and movement detectors. The sensors scan the space continuously and, in the absence of any room occupancy, a controlled program of luminance reduction commences(D. Loe, April, 2003) (Mills and Piette, 1993).

2.3.2. HVAC saving energy opportunities

HVAC (Heating, Ventilation, Air Conditioning) system is the way to maintain good air quality through adequate ventilation with filtration and provide thermal comfort for a zone to be independently controlled to meet the desired conditions((IPCC), 2007). In commercial building, especially food retailing, the services equipment are necessary to follow for enhancing low- energy design or use. Choosing efficient equipment which is appropriate functional design and size; recently there are software programs that guide the designers through various stages of design and can help in the selection of energy efficient alternatives specific to the project's needs as 'Integrated Energy-Efficient Building Design Process' (IEBDP, RNSYS, and cooling program HTB2. The following strategies enable architects, and designers to choose efficient HAVC (Pérez-Lombard et al., 2012, L. Cecchinato, 2012, G.Mahalingam, 2011, Moxon, 2012).

2.3.2.1. Passive HVAC

Interior designers should consider what influences such architectural design has on indoor spaces. Determining the major constituent of energy consumption; for example, are the overall heat loss and gain. Generally, little can normally be done to alter in fabric, but good adding can favorably be done to add thermal isolation, or choosing the appropriate equipment environmental parameters such as internal air temperature, relative humidity and ventilation to be controlled in relation to thermal heat gains and losses and occupancy patterns((ASID), 2007) (Moxon, 2012) (Cecchinato et al., 2010).

- In winter, the sun is directly overhead or slightly to the north, so slight over head on the south windows is need in order to minimize direct sunlight during the summer month. The exact length and angle of this overhang can be calculated in accordance with building location.
- North- facing window are minimized as they would permit cold air to enter during the winter.
- Shade and minimal exposure on the west side of buildings is optimal.
- Proper ventilation that maintains warmth in cold season while refreshing the inside air.

There are passive techniques designers can adopt to gain optimum performance in sustainable building which are((ASID), 2007) (Moxon, 2012) (Cecchinato et al., 2010) (IEA, 2006):

- A. **Solar chimney** is essentially divided into two parts solar air heater and the chimney. Vertical solar and roof solar chimney are the two configuration of solar chimney. Designing a solar chimney includes height, width and depth, type of glazing, type of absorber, and inclusion of isolation or thermal mass. Beside, diameter, other factors such as location, climate, and orientation can also affect its performance.
- B. **Ground source- based energy system** depends on ground source heat) as it highly efficient for space heating and cooling. This technology relies on the fact that, at depth, the earth has a relatively constant temperature, warmer than the air in winter and cooler than the air summer. It can transfer heat stored in the earth into a building during the winter, and transfer heat out of the building during the summer(Cecchinato et al., 2010). Exergy loss of system for building heating model is bigger than that of cooling model. The systems can use vertical drilled shafts, or horizontal pipe fields. Horizontal pipe fields are generally the less expensive option, but they require large open site areas(Moxon, 2012).
- C. **Biomass** can be fed from a variety of sources, and can directly use gasses emitted from the decomposition of biomass, or can use the biomass in high temperature reformers to generate hydrogen. Biomass can consist of a room stove for local heating or a boiler feeding a central heating system. Designers must include an

exhaust flue, adequate space for fuel storage and access for fuel deliveries. It is essential to consider where the fuel comes from, choosing a supplier that guarantees the wood pellets derive from sustainable sources or industrial waste. After all, growing biofuel could potentially divert land from food crops contribute to deforestation(Cecchinato et al., 2010) (Moxon, 2012).

2.3.2.2. Mechanical HVAC

Most of commercial buildings depend basically on air conditioning system, so affordable efficient system should be chosen. Despite the higher first cost of efficiency systems, it is more economic that it's long- term operating cost is reduced through reduction of energy demand, and reduction of maintenance(Clarke, 2001). All the choices of system installation will be dictated by a number of techniques as:

- ❑ Splitting the building into a number of separate zones can provide control that more closely matches the desired conditions. Hence, In buildings without individual zone control, levels of heating and/or cooling can be the same throughout the building. This can result in large amounts of energy being wasted and associated high CO₂ emissions(Cecchinato et al., 2010) (Clarke, 2001).
- ❑ Where major changes are being made to a building, it is worth considering the possibility of not conditioning the whole building and using natural ventilation for part of the building (zonal mixed mode) or of conditioning for only part of the time (seasonal mixed mode). Whereas, major energy saving of about 25% can be achieved in combination of various HVAC operation strategies in commercial buildings(Balta et al., 2010).
- ❑ Some zone controllers can be connected together using a communications network, to an overall controller. This allows the sharing of data, for example, readings of external air temperature can be shared between individual zone controllers on a network(Yang and Zhang, 2010).
- ❑ At design stage, some issues must be considered; isolating supply ducts, installing automatic damper to enable zone control(Pérez-Lombard et al., 2012).
- ❑ Choosing the ideal set point; hence, using of 28C^o set point temperature only during the start of occupied periods resulted 18% saving(Clarke, 2001).
- ❑ Using combination of fan operation schedule generated saves up to 21%(Balta et al., 2010).
- ❑ Combination of increased temperature during occupied and unoccupied period save energy for about 12.2% (Fasiuddin and Budaiwi, 2011).
- ❑ On a global basis commercial refrigeration systems annual leakage rates are higher than 30% of the refrigerant charge, and The diminution of direct greenhouse gases emission is pursued by tightening refrigeration systems(Ge and Tassou, 2011). Several studies have been published about the way to reduce energy consumption in refrigeration system. Some of these studies can be

summarized as Integration between the HVAC system and the refrigeration plant in supermarkets can significantly reduce energy consumption. Moreover, using more efficient equipment, namely evaporators, condensers, pumps and above all more efficient compressors (Pérez-Lombard et al., 2012).

- The energy consumption for HAVC system depends on number of factors as the occupied hours in a day, the cost of electricity for every KW, and the Seasonal energy efficiency ratio(SEER) or coefficient of performance COP were value of COP = 0.875 SEER (Pérez-Lombard et al., 2011, Clarke, 2001).

$$\frac{\text{Units size (BTU/h)} \times \text{No. Of unit} \times \text{hours per year(h)} \times \text{energy cost}(\$/\text{kW}\cdot\text{h})}{\text{SEER(BTU/W.h)} \div 1000 \text{ (kW/W)}}$$

2.4. Indoor environmental quality IEQ

In indoor, environments with number of physical and chemical parameters influence the occupants' comfort. Standards dealing with indoor environmental quality have been developed to define the acceptable ranges of these parameters. Even though the requirements of these standards are met, not all building occupants are satisfied with the indoor environment because of some operative factors. Hence, the same indoor conditions may lead to different subjective responses. IEQ can characterize in four indicators indoor air quality, thermal comfort, acoustic comfort, visual comfort.

2.4.1. Indoor Air Quality (IAQ)

Indoor air quality is defined as air free of pollutants that can cause healthy and comfort. In many case the risk from indoor air pollution caused by humans is relatively low. Otherwise, designers' contributions for indoor have sufficient role to determine the rate of indoor efficiency. The quality of indoor air can be measured among three aspects; satisfying thermal requirements, preventing unhealthy pollutants, and finally allowing well-being. Then, utilizing of these indicators enable optimum quality of indoor environmental(Lee .D, 2010) (S.Brown, 2008). Clean air is composed of mainly nitrogen (78%), oxygen (21%) argon (1%) and carbon dioxide (0.03%). In cities due to human activities, such as chemical plants and traffic emission, more elements are added such as; Carbon monoxide(CO), Carbon dioxide(CO₂), and volatile organic components(VOC), pesticide, Radon and others. Actually, a lot of studies consider VOC and CO₂ as the most influence pollutants; whereas, CO₂ concentration use for measuring HAVC, and reducing VOC percentage for healthier spaces(S.Brown, 2008) (OSHA, 2011). There are enormous indoor air pollutants spreading through space. They can be categories in three biological, chemical, and particle. Other categorization is chemicals, combustion, materials, and waste products. The following description for major pollutants, their sources and acceptable range parameters.

Table (2.6):Types, sources, and parameters for indoor air pollutants
(OSHA, 2011) (S.Brown, 2008) (Orosa and Oliveira, 2012) (Roaf, 2009)

	Air pollutant	Possible sources	parameters
Combustion	Carbon monoxide CO	Garages Auto exhausts	OSHA:50 ppm(parts per million) 8hours ACGH:25ppm as 8hours NIOSH: 35 ppm as 10 hours ASCC, NICNAS, WHO 9 ppm (8 h)
	Carbon dioxide CO2	Human respiration Smoking	ASHARE:300-500 ppm OSHA:5000pm as 8hours ASCC, NICNAS, WHO 800ppm (1h)
Materials	Formaldehyde	Partitions, furniture, shelving, flooring, plastic, (woodchip the highest)	100 µg/m3 (peak)
	VOC	Solvent	Furniture, wood decoration
		Benzene	10 µg/m3 (1 y)
		Toluene	4100 µg/m3 (24 h)
	Fiber	Asbestos	Insulation materials, sheeting, flooring
Chemical	Ozone	Photocopy, machine	0.1 ppm
	Radon	Soil surrounding, some materials, accumulated in attics and basement	4 picocuries per liter of air
Consumer products	Particulates	Cigarette smoke, Carpet fibers	
	Pesticide	Hydrocarbons used against insects and microbiological growth	
Biological	Microbes	Carpet, dirty cooling coils, ductwork, kitchens, spaces with higher humidity	ASHARE recommended humidity levels from 30-40 percent as optimum comfort

Where, the mentioned abbreviations are; **Ppm:** parts per million **Twa:** Time weighted average **OSHA:** Occupational Safety and Health Administration **NIOSH:** National Institute of Occupational Safety and Health **ACGH:** American Conference of Government Hygienists.

2.4.1.1. Selecting materials

Selecting materials for the interior finishing is an important step toward minimizing indoor pollutants. According to LEED requirements sustainable materials are materials made from rapidly renewable resources, are highly durable, recyclable, and low emitting (Bacon, 2011). Designers have misperception that prevent using sustainable materials in their projects include the perception of that sustainable materials are less quality, looking different, more costly, and not readily available. Actually, selecting sustainable products reduce maintenance costs, save energy, reduce replacement, reduce unnecessary resources, and minimize waste generation. All these benefit obtain by the sustainable materials that have the following criteria that can be evaluated to determine how sustainable a product might this criteria include (CIWMB, 2010) (Mhaskar, 2006).

- Products made from Environmentally-resources or attractive materials that enhance reduce materials use, and included reused or recycled products, certified products, Products made waste material, Natural products.
- Products that are Green because they are Alternatives to ozone-depleting substances, Alternatives to products made from PVC and polycarbonate, Alternatives to conventional preservative-treated wood that contains toxins, Alternatives to other components considered hazardous.
- Products that Reduce Environmental Impacts during Construction, Renovation, or Demolition.

Choosing appropriate materials has apparent effects not only for quality of building, but also for occupant. As an example, materials finishing contribute on indoor air quality (IAQ) level of dampness, moisture, and mold problems. Hence, they have a well-documented link to occupant health and cause what known as sick building syndrome (SBS) such as dizziness, nausea, and acute eye, nose throat irritation, asthma (Loftness et al., 2007); (Lockwood, 2006).

Finishing indoor materials plays pivotal role in quality of indoor environment, and the effects are most pronounced in places with highly transient moisture loads such as bathroom and kitchens. Even if there is high ventilation rate in the space and isolation levels, the moistening surfaces cannot avoided, and moisture retention in the finish may cause sustained high humidity as in The Gaza Strip. This indicates that maritime building should matter with properties of materials (Loftness et al., 2007).

Indoor environmental department at Lawrence Berkley national laboratory in California found that improved air quality generated by using environmental design among using sustainable materials and technology lowers SBS symptoms by 20% to 50%, while colds and influenza are reduced by 9% to 20% and allergies and asthma drop by 8% to 25% (Lockwood, 2006) (Loftness et al., 2007).

A. Environmental performance

Using finishing materials has direct and indirect impact on environment at every stage of their life cycle. Often call cradle to cradle not cradle to Grave. This environmental impact assessment is very important in evaluation materials' sustainability. It can be described as a follow:

First: Global warming potential refers to total contribution to global warming resulting from the emission of gases which are Carbon dioxide CO₂ Methane CH₄ and the emitted gases occurred during production of materials as Nitrous Oxide N₂O, hydrofluorocarbons (HFCs), perfluorocarbons (PFCs), and sulphur hexafluoride (SF₆). Actually, these gases have varying levels of impact on global warming. All of emissions that mostly called CO₂ equivalents can be test among valuable tools as BIM(Building Information Modeling)(Commitment, 2007) (Moxon, 2012). The following table illustrates emission estimates for some materials based on a literary review.

Table (2.7).Materials' emission estimates (BIM, 2009) (Industry, 2005)

Type of material	Name of material	kg CO-eq./ton2
Glass	Glass	820
Insulation	Polystyrene	2900
	Glass wool	876
	Cellulose fiber	166
board material	Gypsum boards	1641
	Plywood	333
	Pressed fiber board	67
	MDF (Medium density fiber board)	100
membrane and density layers	Propylene	1890
	PVC	2760
Surfaces	Linoleum	1025
	Vinyl	2778
	Polyamide	3486
	Carpeting	1712
	Paint	1365
	Porcelain	391

Second: Indoor Air Quality there is a gab in scientific consensus about the relative contribution of pollutants in indoor air performance. Generally, VOC emissions are measured to indicate interior performance. High concentration of VOC, formaldehyde, and other chemical cause unpleasant odors led to health problems. Accordingly, today there are low-and no-VOC materials available among paints, adhesives, sealants, wood, carpets, and solvents that do not accede the limited value in specification. In LEED specification this value estimate 0.5 mg/m³ (Cain, 2007) (Mhaskar, 2006) (LEED, 2009).

Third: Human health problems caused by wide range of substances that are used in building materials are ranging from transient irritation to permanent disability and even death, such as Benzene and Toluene(Cain, 2007).

B. Environmental evaluating for materials

Several studies certify low chemical emitting products and materials serve as a primary measure for achieving good indoor air quality. Moreover, the American Society for Testing and Materials(ASTM); for instance, established guidelines for measuring chemical emission using environmental scale ASTM D5i6-97 and D6670-01. Greenguard Environmental Institute (GEI) has established performance- based standards to label goods with low chemical and particles emissions for use indoor primarily building materials, interior finishing, furniture, cleaning and maintenance, and electric equipments(ASTM, 2012) (GEI, 2012) (Loftness et al., 2007). There are available tools that can be used to environmentally design assess or after using building and they vary in type of designer’s target. This tools are included at the following table.

Table (2.8). Ways of evaluating materials
(Cain, 2007) (Montgomery, 2009) (Moxon, 2012) (RICS, 2012)

Tool	Description
Economic and environmental sustainability(BEES)	It is developed by National institute of standards and technology building to measure the environmental performance for building materials using ISO 14000 standards. This can be helpful in understanding the differences between products and enabling the designers makes a more informed decision.
AIA’s environmental resource guide	It enables detailed life cycle data about available of materials buildings.
Envest II	This program is designed for non residential buildings assessment created by Building Research Establishment (BRE). It can give eco-pointed scoring as rating for building’s performance. www.thegreenguide.org.uk ; www.athenasmi.org .
Simapro system	This system is for integrated environmental assessment of products; it measures whole building environmental performance by using eco indicators based on European levels of acceptability.
Athena environmental impact estimator	It gives the users entire building’s profile, in order to make modification.
TEAM Tool for Environmental Analysis and Management	It allows the user to build and use a large database and to model any system representing the operations associated with products, processes and activities.

Table (2.8). Ways of evaluating materials
(Cain, 2007) (Montgomery, 2009) (Moxon, 2012) (RICS, 2012)

GaBi software	GaBi is a word shortening for "Ganzheitliche Bilanz," which means Holistic Balance in German. This software has a variety of analysis options to inform practitioners about the life cycles.
LEED and SKA rating materials credits	They both address key criteria for materials in their rating systems.
Material labeling	<p>An approved method for assessing the performance, so it can recognize the crucial role of interior materials; for example,</p> <ul style="list-style-type: none"> ○ EU member has identified the fungal growth on materials to mandate M/36(Loftness et al., 2007). ○ The carpet and rug institute's green label indoor air quality test program. It indicates the manufacturing way that minimizes any affects on interior air quality. ○ Smart wood and forest stewardship council that certifies wood coming from well- managed forest. <p>Green seal promotes the environmental products, and sets standards towards green seal of approval to less environmental products.</p>

Many types of sustainable materials are now readily available. These materials include low and zero volcanic organic paint(VOC) as(Loftness et al., 2007) (Lockwood, 2006) (Bacon, 2011):

- Straw board made from wheat rather than formaldehyde.
- Linoleum flooring made from jute and linseed oil rather than Vinyl which is packed with toxins.
- Coating contain titanium Tio₂, such this materials can helps to reduce level of NO_x gases that cause respiratory problems.
- porous Materials such as Zeolite, widely use in industry water purification, silica, and nano- packages can reduce biosusceptibility, and prolong the effective release period for biocide which cannot exceed more than two years.

2.4.2. Thermal comfort

Thermal comfort is defined as condition of mid which expresses satisfaction with the thermal environment (S.Brown, 2008). It is vary according to physiological and psychological factors of occupants. Thermal comfort is influenced by physical parameters, air temperature, radiant temperature, air speed, humidity, activities, and clothing(Kubba, 2010d).

Table (2.9). Thermal comfort's metrics (Awabi, 2003) (Kubba, 2010d) (Della S., 2012)

Thermal comfort factors	Factor metrics
▪ Air temperature range	ISO 1994: 20C ^o -24 C ^o (±2) in winter, 23 C ^o - 26 C ^o in summer
▪ Relative humidity RH	ISO: 30% 10 70% for summer and winter. ASHARE: 30-60%
▪ Air velocity AV	ASHARE: 0.05- .0 m/s
▪ Mean radiant temperature (MRT)	Measure of how much cooling (or warming) can get not from air but from the exchange of radiant heat to all the objects in the room. By using insulation materials, the indoor radiant temperature moves toward the air temperature, and then makes more thermal comfort. So warm ceiling should be <5 ^o , cool ceiling < 14 ^o , warm wall< 23 ^o , and cool wall < 10 ^o (ASHARE).

Table (2.9) illustrates the environmental variables' metrics for determining thermal comfort. There are other personal factors related to activities levels met and clothing.

Table (2.10). Comfort Criteria for public Indoor.(Orosa and Oliveira, 2012).

Temp. winter	Temp. summer	Maintained illuminance	Noise
(C ^o)	(C ^o)	(lux)	(NR)
10-21	21-32	300	35-45

Table (2.10) summarizes recommended comfort criteria for public buildings. As it defined by Chartered Institution of Building Services Engineers (CIBSE). Thermal comfort condition in relevance to temperature, air speed , and humidity, as these the indicators controlling the thermal comfort (Kubba, 2010d, PreparatoryCommitteeforefficientbuilding, 2004).

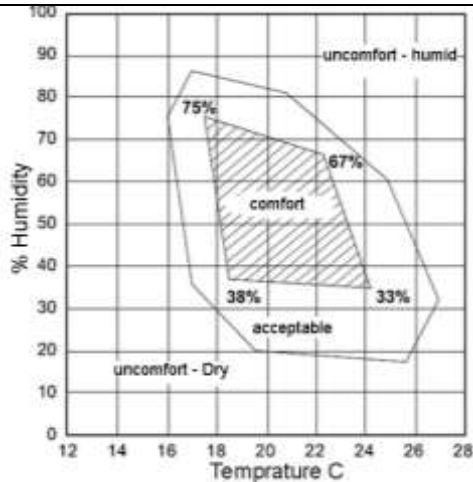

Figure(2.26): Thermal comfort in accordance with humidity and temperature

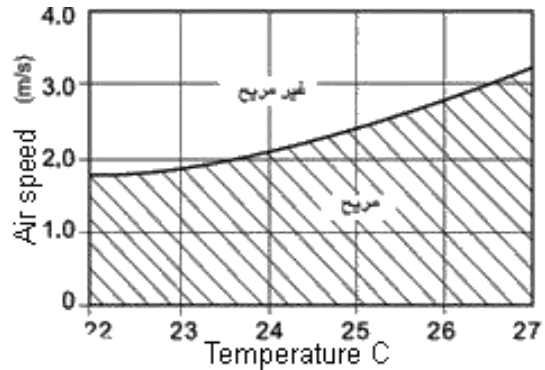

Figure(2.27): Thermal comfort in accordance with Air speed and temperature

(PreparatoryCommitteeforefficientbuilding, 2004)

2.4.3. Acoustic comfort

Acoustic defined is the state of contentment with acoustic condition, as sound is characterized by the sound pressure level in a short term, long term period, and sound frequency. Acoustic comfort is measured in decibel unit at the frequencies over which humans generally hear 20 to 40 db. Therefore noise level should not be higher than 45db, although in Chinese code for design sound maximum level of sound is 55db.

Acoustic comfort evaluation is very important in like workplaces, in which environmental noise causes mental stress and loss of concentration, which can adversely affect worker's performance. By means of collection of both objective measurements of environmental parameters and subjective perceptions, a lot of research has been carried out to study disturbance due to office noise, and acoustic comfort in urban open public spaces and in noisy and quiet roads, acoustic comfort in schools is very important because noise, in combination with thermal and visual comfort, causes annoyance, and impairs communication, learning and concentration. Otherwise, only a few researchers studied acoustic comfort in large-scale retail trade buildings, investigating in particular the acoustics of large public spaces, like atrium spaces and shopping arcades (Della Crociata et al., Rock, 2006).

Large-scale retail trade buildings include supermarkets, hypermarkets, department stores and shopping malls in ascending order of complexity and dimension, whereas; Hypermarkets' acoustic environment depends on a lot of external and internal acoustic sources, as well as work activities. Hypermarkets are characterized by many sound sources, such as HVAC, refrigerated decks, frozen food section, background music, voices, packaging and paging system.

2.4.4. Visual comfort

Visual comfort is defined as a subjective condition of visual well-being induced by the visual environment. There are number of psychological and physical factors affecting visual comfort depend on space and occupants. In commercial building, lighting levels need to be qualified to provide easy seeing during typical display hours. Whereas, the main questions designers should answer, is visual comfort including perceived illuminance level, lighting level of satisfaction, and possible causes of visual discomfort. Moreover, designers should consider beside that the colors in space, glare, windows size and orientations, space dimensions and volume(Della S., 2012).

Electric lighting indoors levels rate from 100-1000 lux. Designing for comfort level of lighting needs to considered the following criteria(RS, 2009) (DECC:Department of Energy and Climate Change et al., 2009):

- Luminance, the amount of light coming from a light fixture that lands on a surface measured in lux.

- Limiting glare rating, unwanted high brightness in the visual field released from windows and luminaires that are viewed directly or through reflections.
- Luminance of the surround, the amount of light leaving a surface in a particular direction. It expressed in Candelas per square meter.
- Modeling characteristics
- Color characteristics of light sources
- Contrast rendering factor
- Uniformity

Lighting design is absolutely based on luminance distribution that it is easier than assessing illuminance distribution. It has a lot of common methods for calculation that assumes that every activity has it's needed of luminous.

There are several available software provide free design of lighting systems. And then allowing easily comparison for different solutions such as' **Dialux** and **Relux**. Other comprehensive mechanical and electrical building services as **Hevacomp**, **Cymap** and **Facet**(RS, 2009).

This chapter enables to familiarize with the assessment aspects for the interior design. Then it basic base to develop appropriate tools to assess any interior design project according to use energy or quality of the indoor spaces.

3.1. Introduction

This chapter offers a complete description of research approach in relation to other approaches, research process, data collection, and the research reliability and viability. Moreover, this chapter includes details for the Way of preparing questionnaire, interviews, and environmentally evaluating for the case study according to the proposed calculators. Finally, explaining the instructions method in order to use the proposed calculators explained in chapter 4.

3.2. Method and Rationale of Approach

A key determining role toward sustainable interior design in Gaza understands all variables perception, behaviors, attitudes and barriers of environmental sustainable practicing. Most studies called for more research on:

“How the different values, attitudes, and action related to sustainable development reinforce or contradict each other and on indentifying groups that include various, combination of values, attitudes and actions”(leiserowitz et al., 2006: p. 313).

Hence, this study applies mixed method to optimize the accurate attitudes toward sustainability in interior design where mixed method enables combining quantitative and qualitative method and providing “ *more comprehensive answers to research questions, going beyond the limitation of a single approach*”(McVilly et al., 2008: p.179).

Demonstrating the behaviors and attitudes among interior designers in the Gaza Strip differs from any similar studies in other areas. The previous related studies implied one aspect of interior design profession either it is related to laws and legislations, or it is concerned with the profession’s stockholders designers, architects, manufacturers. The chosen aspect for analysis is the missing one that is still restricted. On the other hand, all the other aspects should be studied in parallel ways through this study, as it, according to the investigation of this study, is believed to be the first study to concern the environmental aspects of interior design in Gaza.

In studies of Kang M.(2010) and Denise G.(2011), they chose analyzing the attitude and behavior for designers according to environmental criteria, since there are forced environmental laws that oblige practicing sustainability in interior design. Like this study considers that the misunderstanding for sustainable interior design is the main reason for inactive development to sustain indoor spaces. In Europe countries there is an appreciable level of inception in sustainable developing. In spite of the fact that number of organizations, firms, institutes, and individual attempts mentioned at section 2.4 has been established to develop sustainability in interiors, they do have any obligation to practicing

environmental design. El Zeiny R.(2011), and Melterm G(2010) analyzed in their studies the curriculum of interior design programs regarding to the percent of learning sustainable techniques.

Otherwise, the approach of this study used mixed- method in simultaneous triangulation way in order to imply all various aspects affecting the attitude of interior design at The Gaza Strip, in order to increase the likelihood of frank and honest answer, and increase the quality of study (Creswell, 1999). This was a consequence of a scarcity of studies related to sustainable interior design. Moreover, the legislations and regulations regarding sustainable building are less strict than other countries, and this enhances the importance of understanding the barriers preventing employee the laws to serve sustainability. In addition, currently the Gaza Strip has no interior design program at the universities and instates. All these limitations that are shown in figure (3.1) led to study’s approach to highlight the aspects of restrictions in interior design according to environmental developments.

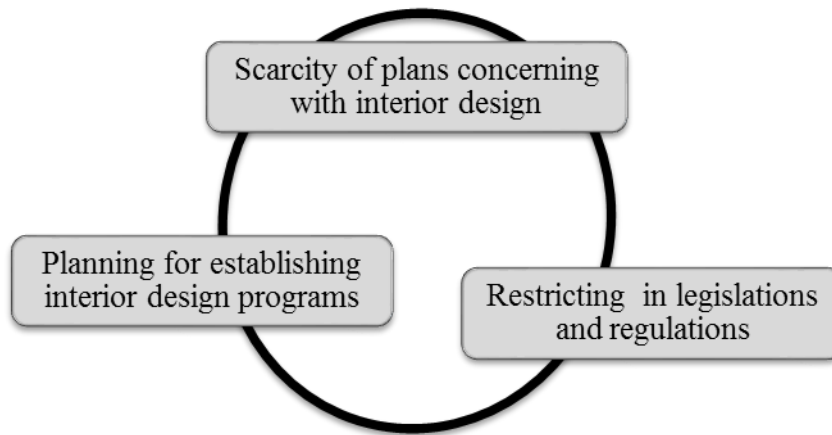

Figure (3.1): Rational for choice of approach of studies.

3.3. Research process

This study has been conducted in four phases as shown in figure (3.2). Hence, Methodological triangulation occurred by combining qualitative and quantitative approaches. Beginning with a literature study, theoretical and empirical materials were gathered from books, academic journals, seasonal reports for specialist international organizations, and some related documents from Gaza’s authorities. The secondary materials were collected from other previous related studies due to focus on other experiences. These secondary materials enable “ *to discover patterns which emerge after close observation, careful documentation, and thoughtful analysis of the research topic*”(Smith, 2012: p. 401).

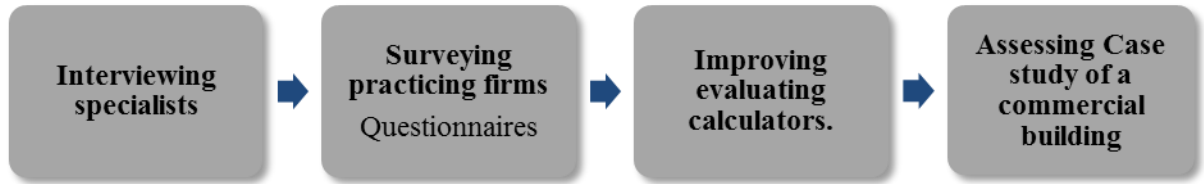

Figure (3.2): The four main stages of research

According to study's investigations, there were no empirical model that covers the entire related studies in Gaza whether what discusses sustainability for indoor spaces or estimate quality of interiors, the study was based the thesis's concept, the inception, attitude, behavior, motivation, and barriers were measured. Presidencies and recommendations of the specialists and decision-makers about this initiative step were formulated. Finally, environmentally sustainable tool assessment for interior projects was suggested.

Both selection of survey's construction and environmental assessing schemes were consistent with research by previous empirical studies for other countries and its modulations. In addition, the survey questions were redeveloped among feedback of literature views and pilot survey.

The literature of thesis study was followed by primary data collecting from interviews and survey. Interviews were conducted along specialists in different related field municipalities, engineering association, Ministry of Natural Economy, Ministry of environmental affairs. Furthermore, survey was the major part of analyzed data. The survey respondents were interior designers, architects working at firms and organizations.

Comprising both of quantitative and qualitative data *“enables acquisition of multi-faceted and riches empirical description unfeasible through mono- method approach; furthermore, it secures triangulation of data sources”*(Creswell, 1999: p. 457). The survey data was analyzed by SPSS both quantitative and qualitative. While the interviews were only analyzed quantitatively. The results then give a full perspective for research objective. It was as the analysis of survey was finalized and the assessing results for the interior projects were presented.

One case study of commercial interior project was evaluated by using the proposed calculators; meanwhile, the environmental grade giving to the projects will be passing or fail because the calculators depend on the minimum environmental standards .while the results were critiqued referring to literature review. In fact, the case study was chosen to consent the study' aims, and enhancing the significance and necessity of this started point toward sustainable interior design in Gaza.

3.4. Interviewing specialists

The main aim for this study is to enhance environmental responsibilities to the interior design, and put initial step in practice a complete set of environmental indicators for commercial projects. Accordingly, the study began with structural interviews with decision-makers and specialists, whose name are shown in table (3.1), working with municipalities, engineering associations, Ministry of National Economy, and Ministry of Environmental Affairs. As, these firms and organization are recruited to develop sustainable level of life in The Gaza Strip.

Whilst, five personal interviews were intercepted in semi-structured form, the interview could format more captured precise data, and ensure in-depth question to attain more clarity and understanding of both current situation of interior design practicing and future planning. Beside, the interviews were conducted using limited and briefed questions combining closed, open- ends and open questions; the value of the questions whereas was well- reviewed especially in combination with questionnaire content. It was targeted not only to confirm the insistent need for thesis in The Gaza Strip, but also to investigate:

1. Presence of environmental **criteria and specifications** for all related products to interior spaces, appliance, equipments, finishing materials, and availability of eco products list.
2. Any **supervision** planning to commercial interior projects among written environmental aspects.
3. Adopting any of **testing way** for the materials, paints, equipment, indoor quality, and indoor pollution.
4. If there is any **potential plans** for such insight to promote sustainable practicing through interior design profession and related field.
5. The importance of implanting this step toward sustainable development.
6. The barriers toward more sustainable world in The Gaza Strip.
7. Any recommendations and additions.

Table(3.1):List of interviewees

	Interviewee	Working Organization	Role in the organization
1	Dr. Nihad El Moghany	General Manger of Engineering and Planning	Gaza- municipality
2	Eng. Ayman Hamoda	Head of Craft Department	Gaza- municipality
3	Eng. Sameer Shabt	Head of Engineering Firms and Companies Department	Engineering association
4	Eng. Emad El horany	General Manger for General industrial administration	Ministry of National Economy
5	Eng. Bahaa El deen Alagha	General manager of Policy and Planning	Environmental Quality Authority

Then it was recorded at five interviewees' offices at average time 45 minutes from 25 of May to 12 of July that ensuring the interviews were long for adequately rapport yet not excessively protracted, while facilitative communication skills. The final open- question enabled participants to inform of any information that was not previously mentioned, and re-concluded the dominate attitude.

The data collected from interviews gave visualizing about the next step, interviewing organizations reveals the respondents of positive attitudes and behaviors towards sustainability. The questions were analyzed, whereas they were used together with data from previous studies as qualitative data in literature views.

3.4.1. Reliability of interviews

Reliability is essential to consider in pre- and post tools; questionnaire, interviews, and assessment tools. Reliability addresses the ability of a measuring tool to provide the same result on repeated occasions (McVilly et al., 2008). Reliability was tested interviews in addition to assessment tools.

An interview is a purposeful discussion (Horton et al., 2004). The use of interviews can help to gather valid and reliable data which are relevant to the research questions and objectives. Semi- structured interviews increase the reliability; hence, all the interviews were asked the same questions. For more increasing of the reliability, set of strategies were used. First, the interviewer was all the time the same person, so all the instructions provided to interviewees were unified. Second, the interviews were restricted to be conducted physically; not by phone or other means, that enable exploring thing like similarities and differences. Third, recording the interviews to keep the rapport between the interviewer and interviewees especially while answering the open questions. Finally, for every authorities, the interview were conducted with the direct responsible person.

3.4.2. Validity of interviews

Validity is the most fundamental consideration in instrument development and refers to that the instrument measures what it claims to measure (McVilly et al., 2008). It was tested through three instruments used in the research. The validity from the interviews is improved by making sure that the information is relevant to study. Therefore, all written questions were constructed according to the literature view and related previous studies.

Three aspects were followed to improve the validity of interviews: (a) choosing directly related level of interviewees, so in every organization the candidates were from the competent departments ;(b) despite the similarity of the questions, every question was recited in accordance to interviewee responsibilities. (c) Every candidate was asked to reply on the questions among his organization not to generalize the answers that reduce containment in the interviews.

3.5. Surveying practicing firms

The attitude survey was manually handed out to interior design firms, as this way allowed serious monitoring of the survey administration process, as there can't be a responsible design without a responsible designers. The survey is relying on manual survey ensured only the elected respondents who answered the questionnaires, and it permitted the respondents to answer perfect questions what enhancing the quality for the study.

3.5.1. Questionnaire description

For more cohesive perspective for attitudes towards sustainability, this phase intended to explore multiple significant variables perception, attitudes, behaviors, and barriers among sustainable practicing. The questionnaire is intercept interviewing for interior designers and architects from 181 existing leading firms and organization along The Gaza Strip. Since then, the survey accumulated variables background, years of experiences, genders, and age to get varying in answers.

Most of questionnaire fields depend on international scales prepared for measuring sustainable attitudes and behaviors toward any sustainable developments. Whereas, many of environmental attitudinal measures have been proposed since the 1960. These scales and tools use variables and valid set of measures or parameters in order to quantify the unquantifiable. Some of this instrument are(Deuble and de Dear, 2012):

1. **New Ecological Paradigm (NEP) scale** created by Riely Dunlap and Kent Van(1978); it found due to measure attitudes of people toward any sustainable development. As it pointed that if things continue on their present course, we will soon experience a major ecological catastrophe.
2. **Model of Ecological Value (MEV) scale** was inspired by Micael Wiseman and Franz Bongeer'(2003). This scale assumes that an individual's ecological values are determined by both preservation the natural resources and restrained utilization and exploitation of nature resources. Hence the questionnaire statements are classified in four groups according to values as the following:
 - Biocentric values that have statements to measure personal responsibilities toward sustainable practices.
 - Anthropocentric values, have a group of statements related to people believes and attitudes.
 - Values solidarity, have accurate questions to clarify the personal and public responsibilities.
 - Values of equality, measure the responsibilities and attitude while the differences of economic distribution.

3. The Environmental Questionnaire [TEQ] scale created by Johnson and Manoli(2008). This scale is amounted both MEV scale (Bongeer and Wisman) and the NEP (Dulepaetal.2000). The scale has 16 statement, since the first nine statements measure attitudes towards preservation and the last seven statements measures attitudes toward utilization.

Consequently, preparing the survey’s questionnaires depended on the above – mentioned environmental scales. A structured questionnaire indirect approach collected by personal interviewee. The questions were proceeded with introductory letter, for it give instruction to complete the questionnaire. Moreover, it invited and motivated the responds to going so.

The format of questionnaire was mainly closed- ended as they are short, not double-barreled, and don’t use colloquialism, previous, acronyms or double negative(Sander et al., 1999). The questions were divided into four sections that shown in table (3.2) of question to be relevant to both criteria discussed in literature views, and initial survey constructed by previous studies significantly. Each sections measure one of the study’s variables.

Table(3.2): questionnaire’ Four sections

section	Objective
I	Measuring the perception about the of sustainable in interior design.
II	Evaluating the percentage of respondents with favorable attitudes revealed good level of support toward sustainable interior design.
III	Reporting behaviors favorable to sustainable practicing revealed a drop of supports
IV	Investigating the barriers prevented sustainable practices, and the motivations will promote using sustainable design among interior projects.

The first group of questions examined the perception about determining the sustainable choice in interior projects. Then, enable to get accurate percent of designers who are having a basic familiars with understanding of term” **sustainable interior design**” . In second group, the questions aimed to genuinely evaluate the positive or negative attitudes for architects and interior designers. Accordingly, both of extent of embracing sustainability was defined, and the reasons keeping the designers skeptical about sustainable practicing at the design of interior are discussed. The third group explored the environmental behaviors at the interior projects whether it is intentional or unintentional, for this is good indicators to the willingness to sustainable practicing. The last group explored the barriers preventing sustainable practicing. It enables to offer introspective strategies to develop the capacity to indoor spaces and its products to be more conscious of the important to apply sustainability in the design of interiors. All these batteries are detailed in appendix (A)

3.5.2. Data processing

The data processing starts with quantitative analysis of percentage of firm in order to get if the sample was representative for designers attitudes. A few remarks on this analysis can be made. Firstly, more experience firms responded the questionnaire greater than the less experienced one. Secondly, there are no differences between respondents answering the questionnaire on pilot and the others.

In order to be able to select the appropriate method of analysis, the level of measurement must be understood. For each type of measurement, there is an appropriate method that can be applied and not others. In this research, ordinal scales were commonly used. Ordinal scale is a ranking or a rating data that normally uses integers in ascending or descending order. The numbers assigned to the important (1, 2, 3, 4, 5), (1, 2, 3) do not indicate that the interval between scales are equal, nor do they indicate absolute quantities as shown in table (3.3). They are merely numerical labels. Based on Likert scale we have the following.

Table (3.3):Likert scales used through questionnaire.

Item	Strongly agree	Agree	Do not Know	Disagree	Strongly Disagree
Scale	5	4	3	2	1
The median value in this case is 3 (3/5=60%)					
Item	Agree	Do not Know	Disagree		
Scale	3	2	1		
The median value in this case is 2 (2/3=66.67%)					

For Testing the Normality for each field, **Kolmogorov-Smirnov test** of normality is used. From Table (3.4), the p-value for each field is greater than 0.05 level of significance, then the distribution for each field is normally distributed. Consequently, parametric tests will be used to perform the statistical data analysis.

Table (3.4): Kolmogorov-Smirnov test.

Field	Kolmogorov-Smirnov	
	Statistic	P-value
(QA): Measuring the knowledge about sustainable practices.	1.166	0.132
(QB): Evaluating the attitudes toward sustainable interior design	0.987	0.284
(QC): Behaviors and practices for sustainable interior design	0.641	0.805
(QD): Barriers and motivation among practicing interior design	1.214	0.105
All paragraphs of the questionnaire	0.675	0.896

Both qualitative and quantitative data were used for analysis methods. The Data analysis was made utilizing (SPSS 20). Some statistical tools shown in figure (3.3) were utilized such as, Kolmogorov-Smirnov test of normality, Pearson correlation coefficient for Validity, and Cronbach's Alpha for Reliability Statistics.

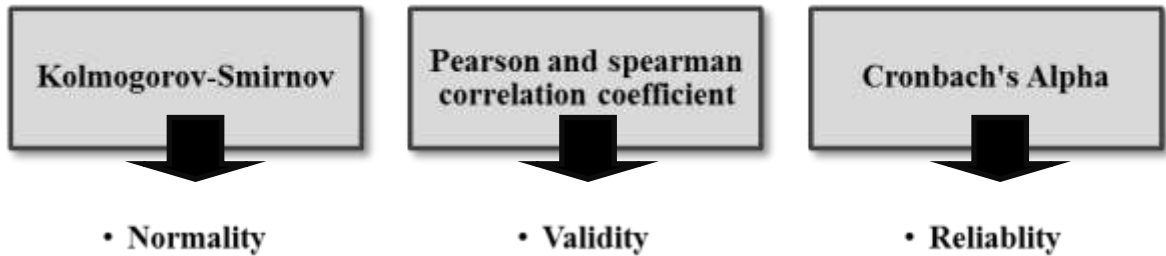

Figure (3.3): Statistical test used for questionnaire

3.5.3. Scaling

Selecting an appropriate scales for questionnaire is not trivial step, for it is astutely discrimination the power of results, cautiously affecting the desire to follow up without expecting too much time, and keenly managing the analyzed data. As this study measured several variables, the scale, therefore, is differential which is postulated in accordance to study's aim and question requirements as shown in table (3.5).

Table(3.5): Scales samples

Ordinal scale	C4: from your experience, do you confront any environmental problem while or after design stage?
Likert scale	A4: how strongly do you agree with the following statements?
Matrix-rating scale	C6: what is the order for the following factors as apriority, when you choose finishing materials and construction ways?
Ratio scale	C2: How many time did you practice sustainability in design of interior?
Open question	A1: From your point of view, how the indoor space can environmentally sustain?

Thus, both ordinal scales, likert scale and matrix- rating scales addition to ratio scales are used to enable the standard deviation regarding to optimal pattern, correlation between inception and behaviors, strategies to motivate using sustainable practices. Ordinal scale is a ranking or a rating data that normally uses integers in ascending or descending order.

The scale used for section [I], inception survey, varied from multi- polar, likert scale, and one introductory open question. Whereas, open question allow respondents to write freely without restricted, as the answer of this question is too limited, but other questions were scaled by multi-polar scales to give wide scope to respondents in order to reach

accurate percentage about respondents' knowledge. The likert scale used for major of statements, which may not always be affirmed by the respondents as inception for such initial study, are optimally measured by a subjective probability scale.

The second section of questions, attitudes, are all measured by likert scales on “agree-disagree” scales what give the respondents a series of attitudes dimension through the five- point “strongly agree- agree- neutral- disagree- strongly disagree”. The middle interval” neutral” represent neither positive agreement, nor negative disagreement referring to zero point.

The percentage respondents' behaviors related to sustainability; mainly measured in the third section are presented in both ratio scales, and matrix- rating scales. The ratio scale presented the percentage of environmental responses according to sustainable aspects of sustainability in interior design. The matrix –rating scales are mostly used in this battery in form of three or seven values to determine how much some factors affect sustainable behaviors positively or negatively.

Finally the last section, the respondents are asked to indicate one areas from five in which they fall on scale, as 1 area is presented the minimal scale and 5 presented more maximal scale. This used in both the barriers preventing sustainable practicing, and the motive factors toward sustainable indoor spaces.

3.5.4. The pilot study

After the questionnaire was valid, reliable, and ready for distribution for the population sample by two statistic and four architectural experts clarified in table (3.7) . The thereby a pilot sample was administered to around 10 firms in order to reveal deficiencies in the design of questionnaire, or procedure of applying. This pilot sample was chosen in Convenience way. While the pilot groups were also given the opportunity to comment on survey, a numbers of logistical issues are address such as:

- Checking the comprehension of questions through measuring responding of the answer in similar way. It enable re-designing parts of questions to overcome difficulties that the pilot study reveals.
- Checking the different measures used through questions and then extra questions were added for applicants after any yes question. This questions confirm the reliability of answers. For example, adding more details for answer of question C₁₁, Have you ever use acoustic isolators, enable more accuracy; whereas, the respondent answer yes, he should mention where exactly using Acoustic isolators.
- Deleting one question, for its result can be achieved from other question's result. This question was asking the respondents if they know about sustainable interior design or not as it can be already gotten from question A1: *How the indoor space can environmentally sustain?*

3.5.5. Reliability of survey

The reliability of an instrument is the degree of consistency which measures the attribute; it is supposed to be measuring (Preston, 2009). The less variation an instrument produces in repeated measurements of an attribute, the higher its reliability. Reliability can be equated with the stability, consistency, or dependability of a measuring tool. The test is repeated to the pilot study on two occasions and then compares the scores obtained by computing a reliability coefficient. Cronbach's Coefficient Alpha is used to measure the reliability of the questionnaire between each field and the mean of the whole fields of the questionnaire. The normal range of Cronbach's coefficient alpha value between 0.0 and + 1.0, and the higher values reflects a higher degree of internal consistency(Preston, 2009). The Cronbach's coefficient alpha was calculated for each field of the questionnaire. Table (3.6) shows the values of Cronbach's Alpha for each field of the questionnaire and the entire questionnaire.

Table(3.6): Cronbach's Alpha for each field of the questionnaire

No.	Field	Cronbach's Alpha
1.	(Q _A): measuring the knowledge about sustainable practices.	0.784
2.	(Q _B): Evaluating the attitudes toward sustainable interior design.	0.449
3.	(Q _C): Behaviors and practices for sustainable interior design	0.762
4.	(Q _D): barriers and motivation among practicing interior design	0.674
All paragraphs of the questionnaire		0.806

For the fields, values of Cronbach's Alpha were in the range from 0.449 and 0.784. This range is considered high; the result ensures the reliability of each field of the questionnaire. Cronbach's Alpha equals 0.806 for the entire questionnaire which indicates an excellent reliability of the entire questionnaire.

3.5.6. Validity of survey

Validity refers to the degree to which an instrument measures what it is supposed to be measuring; hence, Validity has a number of different aspects and assessment approaches. Providing to questionnaire's evaluation by specialists whose mentioned in table (3.7), Statistical validity is used to evaluate instrument validity, which include internal validity and structure validity. Pearson Correlation Coefficient (PCC) test is used for quantitative data, and spearman correlation coefficient(SCC) test is used for qualitative data(Bernardo, 2005). PCC and SCC tests are used for measuring both internal and structural Validity.

Table(3.7): The specialists arbitrated the questionnaire

Name	Specialization
Dr. Farid El Qeeq	Dean for Planning and Development, IUG
Dr. Nihad El moghani	General manger of engineering and planning- Gaza municipality
Dr. Omar Asfour	Associate Professor, Department of Architecture, IUG
Dr. Raed El Otel	Assistant Professor, Department of Architecture, IUG
Dr.Omar El jeady	Applied Accounting Program coordinator at university college of applied science.
Dr. Sameer Safy	Associate Professor of Statistics at Islamic university of Gaza.

3.5.6.1. Internal validity

Internal validity of the questionnaire is the first statistical test that used to test the validity of the questionnaire. It is measured for pilot sample, which consisted of 10 questionnaires through measuring the correlation coefficients between each paragraph in one field and the whole filed. The correlation coefficient's ranges for each paragraph of the first section (QA); for example, are from 0.543-0.85, and The p-values are less than 0.05 which "*It is the probability, if the test statistic really were distributed as it would be under the null hypothesis, and it should be less than 0.05*" (Bernardo, 2005: p. 151). Consequently, it can be said that this field are consistent and valid to be measure what it was set for. The correlation coefficient for each paragraph of other sections also is measured that is shown in appendix B. all the results are referred to the validity of the questionnaire.

3.5.6.2. Structure validity

Structural validity is the second statistical test that used to test the validity of the questionnaire structure by testing the validity of each field and the validity of the whole questionnaire. It measures the correlation coefficient between one filed and all the fields of the questionnaire.

Table (3.8). Correlation coefficient of each field of whole the questionnaire

No.	Field	PCC	P-Value
1.	(Q _A): measuring the knowledge about sustainable practices.	0.545	0.003
2.	(Q _B): Evaluating the attitudes toward sustainable interior design.	0.588	0.000
3.	(Q _C): Behaviors and practices for sustainable interior design	0.797	0.000
4.	(Q _D): barriers and motivation among practicing interior design	0.800	0.000

Table (3.8) clarifies the Pearson Correlation Coefficient (PCC) for each field of whole questionnaire. The p-values (Sig.) are less than 0.05, so the correlation coefficients of all the fields are significant at $\alpha = 0.05$, so it can be said that the fields are valid to be measured what it was set for to achieve the main aim of the study.

3.5.7. Sampling

The sample was carefully chosen as these segment of designers and architects should make accurate estimate of thoughts and behaviors of the designers as a whole at The Gaza Strip what enhanced the main purposed of this study.

According to the interviewing of Head of Engineering Firms and Companies Department at Engineering Associations, The firms of interior designer are 181 existing firms in The Gaza Strip distributed as 82 in Gaza city, 22 in north Gaza, 20 in middle Gaza, and 57 in south Gaza. Then, the sample size is determined by using the following equation. where n is the sample size, N is the number of firms(181) shown in appendix C, and e is the precision level (0.07) with 93% confidence level according to the following equation(Fess, 1995).

$$n = \frac{N}{1+N(e)^2} = \frac{181}{1+181(0.07)^2} \approx 96 \text{ firm}$$

Selecting the 96 firms was done in a way similar to stratified survey. In simple words, some of sample were selected for their influencing decision power on the interior design trends in The Gaza Strip “more experienced one”, and the other sample was chosen as regarded as emerging new paradigm of trend” less experienced one”. Figure(3,4) shows in total firms according Gaza strip, 46 from 82 Gaza city’s firms, 30 from 57 south Gaza firms, 8 from 22 middle Gaza firms, and 12 from 20 north Gaza.

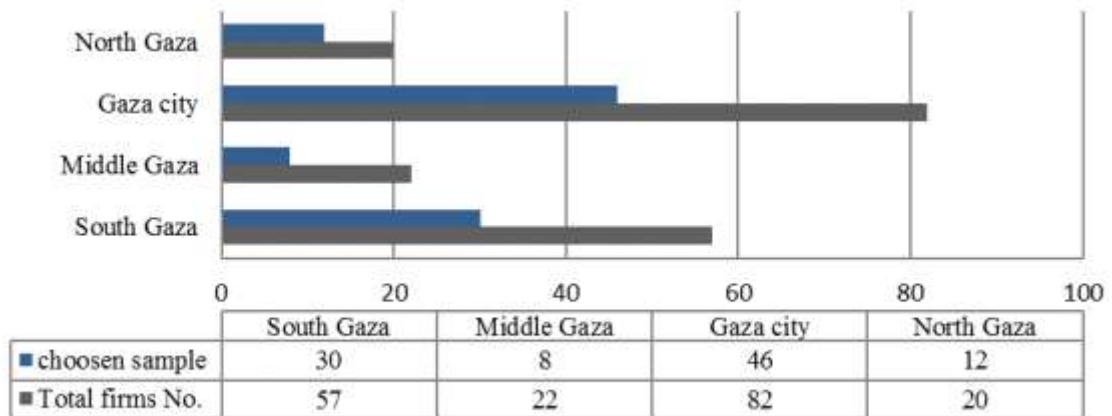

Figure(3.4): Sample Numbers among Gaza strip

Team of engineers participated in distribution the questionnaire, after they had the explanation of study’s aim. They explained what written in introductory letter to the

applicants. The respondents who completed the questionnaire immediately after delivering are 90 of respondents percent, and other respondents delayed it for next time.

3.5.8. Distribution and response rates

Firstly, the respondents need to sign on informed consent before they received the questionnaires. Then, in the fixed date the invitation was delivered manually to the firms, for this method significantly improve response rate; and also, it improve the respondents' knowledge about the study's aim and illustrate what was written in the introductory letter, the first page of questionnaire, the designers reposing questionnaires were either done the survey voluntary or interested to the topic. Total of designers were invited to complete survey are 96 firms among 181 firms with various sectors. 77 participants fully complete the questionnaire.

Table (3.9): Response rate for surveys.

Number of distributed questionnaires	96
Number of respondents	77
Number of uncompleted	9
Response rate	80.2%

The response rate were high as listed in table (3.9). Some strategies enable the higher rate of response. First, expressing commitment for applicant to complete the questionnaire that written in the introductory letter. Second, selecting the appropriate time that the applicant desire. Third, sending sequence of reminding and replacement questionnaire to participants who have not responded. Fourth, considering Variety ways enable more response rate, as some of applicants' request applying by computer and sending via electronic mail.

3.5.9. Bias

Through designing of questions, distributing survey, choosing sample, there are strategies followed to minimize the bias such as:

- Choosing the sample of firms who are obviously practicing architectural and interior design; whereas, at The Gaza Strip there are number of firms have no interest in architectural design and interior during their years of experience.
- Controlling respondent's subconscious reaction where may problems in answering were occurred. Respondents tend to give positive answers when answering Yes-No questions in section II of questionnaire. Accordingly, every Yes- No question was appended with detailed question. For example, when they answer question C11, Have you ever use acoustic isolators?, yes, they should write what are the projects they used isolator.

Nonetheless, there was uncontrolled bias among respondents when answering the first open-end question; from your point of view, how the indoor space can environmentally

sustain? They cannot answer the question, before they had completed the questionnaire. In this case of applying the answers were deleted; thus, the deleted were 36 answers.

3.6. Assessing a commercial case study by using calculator

Investigating by establishing new commercial buildings in Gaza has been increasing last years. This case is a promotive for project's investigators to get promoting, unique, and attractive design that encourage dealing directly with firms of interior design. Moreover, many people in Gaza become favor to spend their time in malls, restaurants, and other commercial building. Therefore, creating legislation instrument for evaluating the environmental performance for indoor commercial buildings, is a good opportunity. Then the proposed calculators in chapter 4, the energy consumption, and indoor environment quality; it is the initial trial for environmentally sustainable interior design.

3.6.1. Instrument and case study

According to the literature review and international assessment tools, an environmentally sustainable calculator has been proposed. The Calculator's details is explained in chapter (4) that is named through this study as (Energy and IEQ) calculators. Once this tool give pass and fail result for the project, it represent acceptance or not for the environmental level of any project that it evaluative according to the minimum environmental standards suitable for Gaza environment. The prescriptive requirements that are needed to complete the targets is accurately clarified in the following titles.

The Environmental Assessment Calculators are used to evaluate *Al Andalusia mall* in Gaza city. It was been built in 2011, and it is built in replace of residential building at Al-Shohadaa street. It has three floors with total area 3000 m²; whereas, the ground floor area is 900 m². It is designed by Furniture and Interior design firm; figure (3.5) show different interior perspectives in the mall.

Choosing the case study to be one of the shopping center at Gaza was justified. Hence, shopping centers are new type of buildings in Gaza, it started in 17of July, 2010 when Gaza mall is established. Moreover, there are number of proposed mall projects, one of them in 8000 m³ in the middle of Gaza, and the largest on El saraya at 44,000 m³. All this reason enhancing creating a developing and managing step as a result of this movements(Rami, 2011).

Supermarkets and food retailing buildings are the major part of non- residential buildings stock that dominate the investment domain in Gaza; Whereas, Gaza have more than 4500 supermarkets, more than 150 restaurants, and more than 120 bakeries (Professions permits, 2012). And due to their operational characteristic. The commercial buildings represented a high percentage of overall energy of the building sectors that is 23% from all energy consumption (Palestinian bureau of statistic, 2009). Their design should take into consideration long- term environmental and economic benefits.



A and B: Shops in the first floor



C: Displaying areas at Ground floor



D: Preparing work for the mall



E: Office area at mall



F: The third floor

Figure(3.5): Internal photos for the El Andalusia mall (Interviewing Eng. El Esawi, 2012)

3.6.2. Requirements for indoor environmental quality (IEQ)

Using the proposed calculators to assess the projects sample, requires inclusive input data intended to set higher accurate results. For each sheets, engineering drawings, actual measurements, bills, and using instruments are used to fill up the calculators.

The indoor environmental building self-assessment tool need to take measurements for air quality, and other measurements related to thermal comfort, acoustic comfort, and visual comfort. These measurements will required specific equipments which is hired from earth and environmental science laboratory at Islamic university- Gaza. All measurements were taken through two days, once on afternoon and the other during morning. The target places is selected by six locations divided in gird

way for each floor as shown in figure(3.6),(3.7), and(3.8), then the average values were entered to the sheets in order to get the result fail or pass environmental spaces. If there is any deficiency in one field, the result is fail.

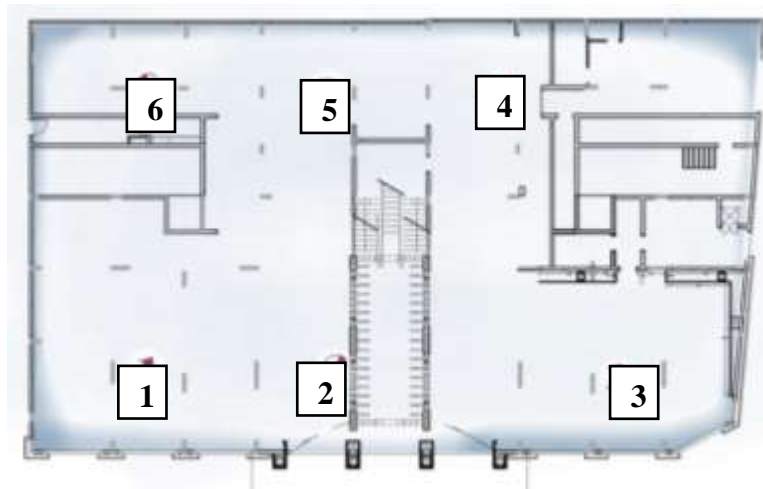

Figure(3.6) Six locations at Ground floor

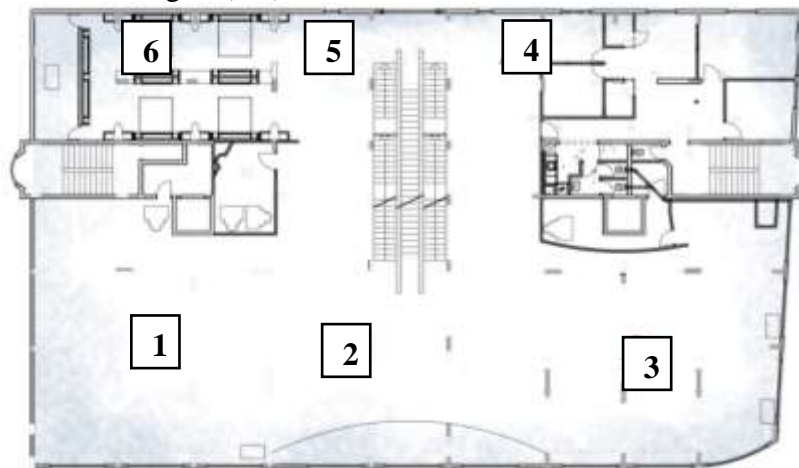

Figure(3.7) Six locations at second floor

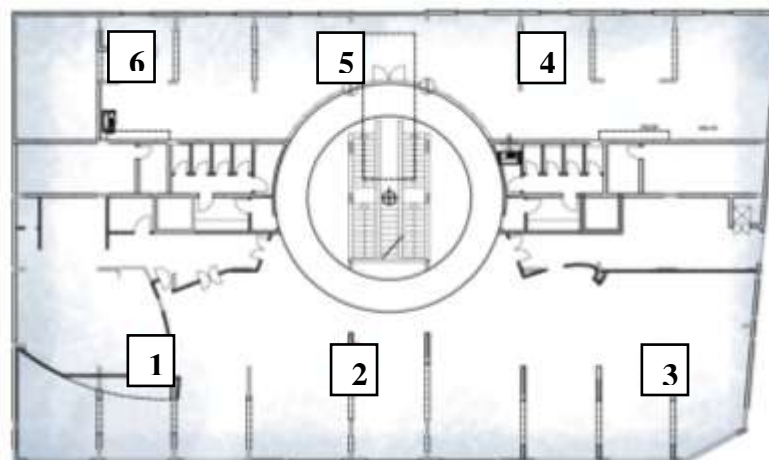

Figure(3.8) Six locations at Third floor

3.6.2.1. Air quality

After investigating the instruments available for indoor air quality at all interested laboratories in the Gaza strip, three of pollutants were measured carbon monoxide, Carbon dioxide, and particulate matter. Each sampling locations were taken twice morning and afternoon, and the measurements was executed for the three floors.

Table (3.10): Requirement data for air quality sheet.

parameter	Equipment	Description
Carbon monoxide CO	IAQ Monitor Model 2211 Shown in figure(3.9)	It range from 0 to 500PPM with accuracy of +/-3% of reading or +/-3PPM whichever is greater, and resolution range 0.1PPM: 0-99PPM 1PPM: 100-500 PPM (kanomax, 2011).
Carbon dioxide CO₂		It's rang is from 0 to 5000PPM with accuracy +/-3% of reading or +/-50PPM whichever is greater. The resolution for the equipment is 1PPM (kanomax, 2011).
Particulate matter	HAL-HPC300 Shown on figure (3.10).	Handheld laser particle counters measures particles suspended in the air. The measured particles Size Range 0.3µm~10µm. it works under operating condition of 5- 45C ^o , and 0-90% RH (Calright, 2011).

Table (3.10) show the parameters and the equipments used to sign up the values. The condition operating, and the specification of equipments; also, illustrate. The figures (3.10) and (3.9) show the HAL-HPC300, and IAQ Monitor Model 2211 that actually used for measuring.



Figure(3.9): IAQ Monitor Model 2211



Figure(3.10): HAL-HPC300

As the data obtained from HAL-HPC300 were convert in Excel file by using Hal-Tech C Particle v2.2 software program; figure (3.11) show its background.

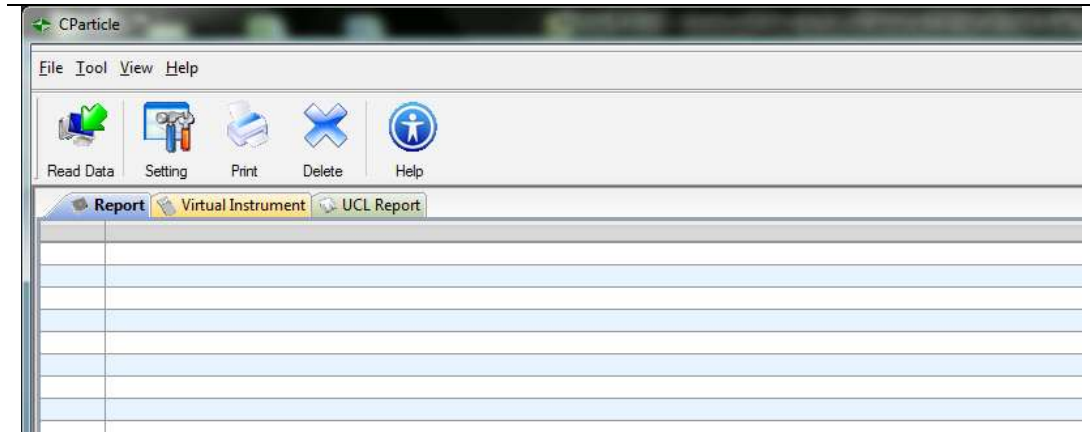

Figure (3.11): Hal-Tech C Particle v2.2 software program.

3.6.2.2. Thermal comfort

According to the Indoor Environment Quality calculator, there are three parameters in order to measure thermal comfort for post occupant space Temperature, Relative Humidity, and Air velocity. These parameters are measured at Al Andalusia mall by using equipment.

Table (3.11): Requirements data for thermal comfort sheet.

Parameter	Equipment/ way	Details of Equipment or way
Temperature C°	Digital Multimeter MASTECH MS8209 Shown in figure (3.12).	Temperature measurement range is -20°~400° ±3.0% (0.1°), -20°~1000° ±3.0% (1°).
Relative humidity%	Digital Multimeter MASTECH MS8209 Shown in figure (3.12).	It measure from 30% - 95%RH with accuracy of ±5.0%., and resolution of 0.1%.
Air velocity (m/s)	SMART SENSOR Electronic Anemometer AR816 shown in figure (3.12).	Air speed measure in m/s with resolution of 0.1m / s.

The table summarize the methodology of getting the input data required for thermal comfort sheet in IEQ calculator. And Figure (3.11) and (3.12) shown the tools used for measuring.



Figure (3.12): Smart sensor electronic anemometer.



Figure (3.13): Digital Multimeter Mastech ms8209.

3.6.2.3. Acoustic comfort

Ambient sound level (dB) for the space was measured using Digital Multimeter MASTECH MS8209 equipment shown in figure (3.13). The same measurements were taken through two days in order to get accurate average for acoustic comfort on both afternoon where the largest occupancy, and on morning the few occupancy. The equipment accuracy is $\pm 1\%$, and with range of 30-100dB and resolution of 1dB (GSM, 1998).

3.6.2.4. Visual comfort

By using the Digital Multimeter MASTECH MS8209 shown in figure(3.13), the luminance (LUX) were measured with rang of Lux (4,000) with resolution 1 lux, and Lux(40,000) with resolution of 10 lux (GSM, 1998). The measurements were recorded in different worked surfaces stairs, displaying areas, offices, kitchen, eating areas, and clothes shops where the six positions in figure(3.6), (3.7), and (3.8) are limited in reference to these places.

3.6.3. Assessing Energy efficiency

Energy Efficiency calculators target four sheets that affecting energy performance building materials, HVAC systems, Service and Hot Water(SHW), lightning, and renewable resource(RS).

3.6.3.1. Envelop U- Value.

Whereas, the design firms provide the study with The used materials for finishing, the u-value for ceiling, walls, and floor were calculated in accordance to Palestinian guideline for energy efficient building design. Table (3.12) illustrate the required data and its calculations.

Table (3.12):Material properties required for energy sheet.

Target	Requirements	Refer.
Materials the u-value (W/m ² .K) for all used materials	<ul style="list-style-type: none"> Opaque material 	wall, floor, and roof.
	<ul style="list-style-type: none"> Vertical fenestration 	Glazing area
		Framing materials
	<ul style="list-style-type: none"> Solar heat gain coefficient 	Accounting from projection factor (PF) of external devices as shown in figure(3.14).
<ul style="list-style-type: none"> Shy light 	(PreparatoryCommitteeforefficientbuilding, 2004)	

The table illustrate all data should collected about materials' specifications, and other space characteristics.

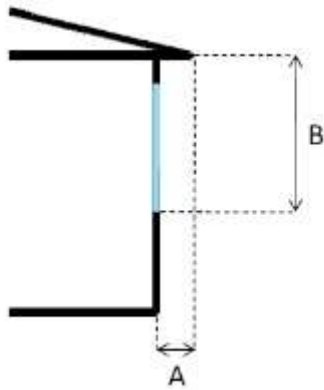

Where $PF = A/B$ (Estidama,2010)

Figure(3.14): Calculation o Projection factor

Material characteristics affect both energy and IEQ; also in energy efficiency assessments there are other targets issues considered in the proposed calculator.

3.6.3.2. HVAC system

Calculators requirements for apply energy calculator is based on minimum permissible in ASHRAE standards.

Table(3.13): Other targets except materials required for energy assessing.

Target	Requirements	Refer.
HAVC All the types of HVAC using in all spaces.	<ul style="list-style-type: none"> The size in (BTU/h or tone), and the number of devices 	Mechanical drawings
	<ul style="list-style-type: none"> The efficiency of the equipments in (SEER, Cop). COP = 0.875 SEER 	
	<ul style="list-style-type: none"> Making sure about specifications of fan system. 	

Where Tone = 12,000 Btu/h, and SEER is seasonal energy efficiency ratio can obtained from company website measured by Btu/ h. COP is coefficient of performance that measure the heat pump energy efficiency.

3.6.3.3. Services Hot Water System (SHW)

Water heating system performance were Compared with calculator criteria. Then, the size category (KW), efficiency value, and capacity. System control and the water temperature data are collected.

3.6.3.4. Lighting

Collecting data about all lighting devices depend on the electric drawings for the mall, and the manufactured companies' web pages. Then for every space in the building, the lighting power density LPD (w/m^2) should be calculated according to the following equation.

$$LPD = \frac{\text{Number of lighting devices* watts per each devices}}{\text{Space's area}}$$

(Energy and IEQ) Calculators

To implement the main objectives for the study, and environmentally assessing both energy and indoor Environment Quality (IEQ) of the commercial interior design in the Gaza Strip, the Energy and IEQ calculators were proposed. These calculators were developed in similar way of SKA-rating tool, NABERS, and Estidama Pearls Design System.

The calculators was prepared on two Excel files for assessing the interior design projects in both designs and post occupancy stages. It basically depends on the standards of Palestinian code for energy efficient buildings, and the other standards from The American Society of Heating, Refrigerating, and Air Conditioning Engineers (ASHRAE) standards in all its parameters, and it depends on minimum standards not idealistic standards. The results of evaluating is pass or fail; therefore.

These calculators are important for concerned authorities, designers, occupants, and researchers. Moreover, availability of such tool for all stockholders, is an applied step toward more sustainable environment.

4.2. Proposed (Energy and IEQ) calculators

4.2.1. Description

Energy and IEQ calculators, developed and proposed by this study, are designed to help interior projects to become more sustainable. They are based on NABERS and Ska-rating which are used to assess the environmental performance of interior design. This is in addition to initiative Estidama- Pearl rating system used in Arab world which aims to transform Abu Dhabi into model of sustainable urbanization.

Based on these three references, this study has developed four evaluation tools including energy efficiency, and indoor environment quality (IEQ) for mechanically ventilated buildings. These tools are named as Energy, and IAQ, calculators as shown in figure (4.1).

Whereas, the ideal evaluating environmental building tool should include all the requirements of different involved in the sustainability aspects; the proposed calculators are presented the minimum environmental standards for multi- criteria. ASHRAE standards were used for both of calculators' requirements and measurements.

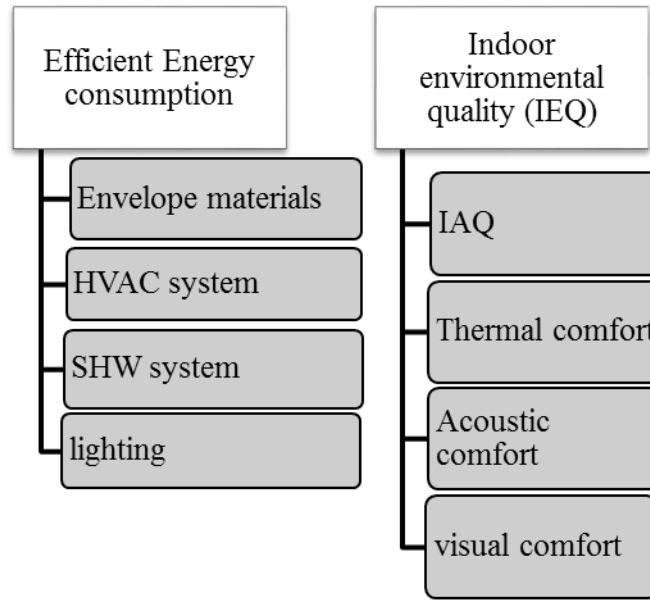

Figure(4.1):Main- aspects and sub- aspects for the developed

4.2.2. Assessment the importance and benefits for Gaza

The Gaza Strip has witnessed a significant increase in establishing malls centers, supermarkets, and retail food stores. Therefore, creating legislation instrument for improving the environmental performance for indoor commercial buildings, is a good opportunity. According to this study, the environmental problems do the commercial building have, will be highlighted.

It is extremely important, particularly in the current situation in the Gaza Strip to ensure that any practicing of interior design projects make informed decision related to legislation and environmental sustainability. Moreover, environmental evaluating tools contribute significantly to connecting designers and their designs with environment. Step forward to creating main legislation instrument in Gaza for improving environmental performance for indoor buildings.

It has been developed for designers leading to good design options, but it can be used by concerned authorities to measure the environmental impacts of any project more accurately. As well as, other stockholders including consultants and developers to benchmark the sustainability of buildings leading to speculative image of building in Gaza with low energy, emissions and performance. Impulsively, it help occupants to follow good practices.

4.2.3. Assessment stages

The Energy and IEQ calculators assessment process can be realized in both design and post occupancy stages. Whereas, evaluating El Andalusia, the commercial case study, represents post occupancy stage.

4.2.3.1. Assessment Post occupancy stage

Post occupant building should be hired for minimum 12 months after completion, there is the option for building to be evaluated if it has been performed in an environmental approach or not. This is that used to evaluate the case study in chapters 3 and 5. The assessment for post occupant project has been done by energy bills gathering, water bills gathering, and using IEQ instruments for measuring pollutants, Acoustic, visual, thermal comfort.

4.2.3.2. Assessment design stage

By using the software programs mentioned in chapter 2 of this thesis, predicted annual energy and water consumption can be calculated; also, IAQ characteristics can be simulated. After that all data can be entered to calculators shown in figure (4.2). In brief, this calculators can be used in both design and post- occupancy stages. Nevertheless, the evaluation that conducted in case study in chapter 3, 4 was used the calculator to evaluate post occupancy building.

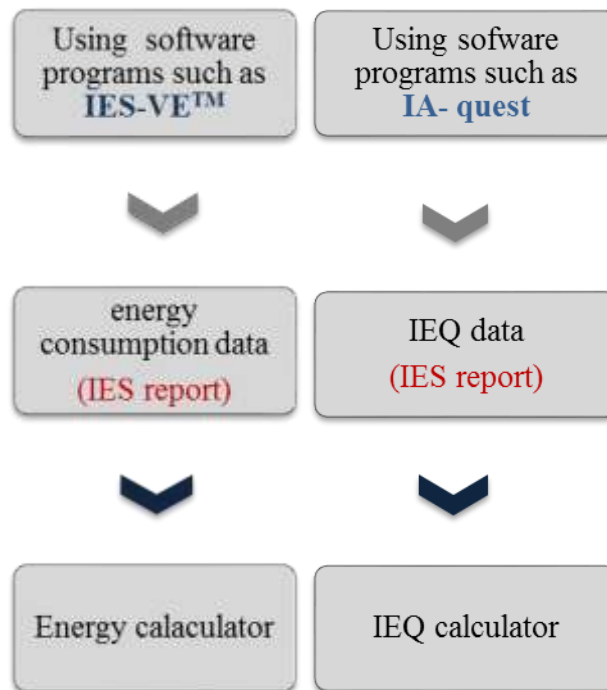

Figure(4.2): Steps for using calculators in design stage

4.2.4. Scaling and scoring

There is no number or score awarding to each criterion, as the calculators depend on the minimum environmental standards for interior projects because of the practicing of interior design in the Gaza Strip, and the absence of any readily used methodological frameworks toward sustainability in design. Hence, the result obtained for the evaluating project is (pass, or fail) reflecting the performance of a building in achieving environmental of sustainability goals.

The evaluation process for a project will be seen as a simple linear process, as each stage cannot supply additional information and participate in feedback other forthcoming stage or stages that each calculators can be done in separately way.

4.2.5. Calculator1, Energy efficiency

Improving the energy performance of indoor practicing is a key to promote building energy consumption. Energy performance calculator basically depends on ASHRAE90.1.2010 standards achieved by 30-50% improvement in building performance when compared with the baseline design energy performance by specifying maximum energy consumption for lighting, HVAC system, and SHW system(RICS, 2012).

4.2.5.1. First sheet, Envelope of indoor

U- Values are important because they form the basis of any energy. It is a measure of heat loss/ gain in a building element such as a wall, floor or roof. It can also be referred to as an ‘overall heat transfer co-efficient’ and measures how well parts of a building transfer heat(Bejan, 1982). Then, it will be the first consideration in interior design decisions that the interior design should calculate. All the field in the design values column should realize in the design of interior as shown in figure (4.3) according to Palestinian code. Envelope sheet in classified on three categories:

- a. **U- Value for Opaque element**, include roof, wall and floor that the target values in table (4.1) is shown.
- b. **Fenestration**, include area of both vertical and skylight elements, and:
 - Openings in each floor should allow light to reach minimum 30% of the most distant floor, and the glazing area should be less than 30% of wall area.
 - Metal framing should have U- value maximum of $1.90 \text{ w/m}^2 \cdot \text{k}$, and for other material U- value should not exceed $2.00 \text{ w/m}^2 \cdot \text{k}$.
 - The u- value for entrance door must not exceed $2.60 \text{ w/m}^2 \cdot \text{k}$, and for the horizontal glazing $3.80 \text{ w/m}^2 \cdot \text{k}$.
 - Solar Heat Gain Coefficient (SHGC) for vertical elements is at maximum 0.36, and for horizontal elements is 0.50.

- c. **Air leakage rate** for indoor space should not exceed 3.64L/s/m² that can calculate from the difference air between outdoor and indoor(OSHA, 2011). Air leakage can also result in poor indoor air quality. Air leakage also contributes to moisture problems that can affect occupants' health.

1. ENVELOPE ELEMENTS				
	Envelope Elements	Target Requirement	Design Value Achieved	Pass / Fail
Opaque Elements	Roof	1.8	??	
	Wall1	2.5	??	
	Floor	1.2	??	
Fenestration	Vertical glazing Area Ratio	30%	??	
	Entrance Door	2.6	??	
	0.25<=PF<0.50	0.3	??	
	Skylight Glazing Area	3%	??	
	skylight Glazing U-Value	3.8	??	
Infiltration	Building Air Leakage Rat L/s/m ²	3.6	??	
Overall Pass/Fail for Building Envelope				??

Figure(4.3): Envelope sheet

For commercial building the U- value of Opaque materials should be less than the values given in the following table (4.1).

Table(4.1): U- value for building elements (Preparatory Committee for efficient building, 2004)

	Roof	Wall			Floor
u- value w/m².k	1.8	Wall1	Wall1	Wall1	1.2
		With opening area, and doors	Between to conditioned floors	Between two different thermal floors	
	1.8	2.2	2.2		

4.2.5.2. Second sheet, HVAC system

The acceptability for the HVAC using the calculator, is depend on three factors equipment efficiency, providing ventilating fan, system performance.

- **The efficiencies of conditioning equipment:** the designed values should be more than given values in table(4.2)

Table(4.2): The efficiencies of conditioning equipment (Estidama, may, 2009) ((NABERS), 2010)

Equipment Type	Size Category	Minimum Efficiency
Air conditioners, Air cooled	< 19kW	3.81 SCoP
	> 19kW and < 40kW	3.28 CoP
	> 40kW and < 70kW	3.22 CoP
	> 70kW and < 223kW	2.93 CoP
	> 223kW	2.84 CoP
Air conditioners, Water and evaporative cooled	< 9kW	3.52 CoP
	< 19kW	3.55 CoP
	> 19kW and < 40kW	3.37 CoP
	> 40kW and < 70kW	3.22 CoP
Air cooled,(Cooling mode)	> 70kW and < 223kW	3.37 CoP
	< 19kW	3.81 CoP
	> 19kW and < 40kW	3.22 CoP
	> 40kW and < 70kW	3.11 CoP
Package unit	> 70kW	2.78 CoP
	All capacities	12.5 - (0.213
Chillers	< 150 tons	2.803
	> 150 tons	2.803

- **Fan system:** It should submit to the minimum specific that are summarized in table(4.3).

Table(4.3): Specific of fan powers (Estidama, may, 2009) ((NABERS), 2010)

System Type	SFP, W/l/s
Central mechanical ventilation, incl. heating & cooling	1.8
Zonal supply system where fan is remote from zone, i.e. ceiling or roof mounted	1.2
Zonal extract system where fan is remote from zone	0.6
Local supply & extract ventilation units such as wall/roof units	1.8
Local supply & extract ventilation units such as window/wall/roof units	0.4
Fan assisted terminal VAV unit	1.2
Fan coil units	0.6

- **System performance:** including the follows:
 - Demand control ventilation (DCV) should be provided when the space area exceed 50 m², and it occupancy's density is 2.3 person/ m².
 - HVAC thermostatic controls should be provided for each zone in the building.
 - Humidity control system should be provided where there is a humidification.
 - All the ducts installed in unconditioned spaces, then it should be insulated. All external ducts should be insulated with good isolators.

4.2.5.3. Third sheet, Service hot water SHW system

- **Hot Water System Efficiency:** it shall be sized according to standards mentioned in ASHRAE 90.1.2010

Table(4.4): Minimum efficiency for water heater (Estidama, may, 2009) ((NABERS), 2010)

Size category	Minimum efficiency(EF)	Reference
>12KW	0.134* capacity(L)+ 45.4	(2007)
Others	0.97- 0.000394* capacity(L)	(Estidama, may, 2009)

The equipment shall match the minimum efficiency requirements with high performance. Performance is estimated by two factors. The first, energy factor (EF) which indicates the energy efficiency based on the amount of water consumed throughout a day, and the second, standby loss(SL). These two factors can be calculated according to equations mentioned in table(4.4) in relation to the system's capacity in liters.

- **Hot Water System Controls,** including three criteria
 - Temperature controls must be provided, that it should not exceed 43C^o for public use and 32C^o for permanent occupancies.
 - If the swimming pool or spa provided with hot water, the pool should provide with vapour retardant. More it should be provided with on- off switch that can shut off the system without adjusting the thermostat setting.
 - It the hot tubs heat more than 32C^o, they must provide with thermal isolators.

4.2.5.4. Fourth Sheet, Lighting

- The internal lighting power density (LPD) can limited by two ways. First, according to whole building function. The second is limited for every zone in the building that is used in the proposed calculator. The LPD should not exceed the targets values in table (4.5).

Table(4.5): lighting power density for different spaces (Estidama, may, 2009) ((NABERS), 2010)

Commercial whole building	LPD(w/m ²)
Storage	7.8
Atrium for first three floors	5.8
Atrium for each addition floor	1.9

Table(4.5): lighting power density for different spaces
(Estidama, may, 2009) ((NABERS), 2010)

electrical room	10.7
Food preparation	11.6
Dining space/ Bar	13.6
Waiting	20.3
Theater/ seating area	11.6
Stair	5.8
Dressing room	5.8
Exercise room	9.7
Gymnasium	10.7
Health clinic	9.7
parking area	2.9
place of prayer	13.6
supermarket / sale area	12.6

There are some strategies that can impressively control the lighting according spaces. Some of these strategies mentioned in section 2.6.1. In shopping centers and malls the following two strategies are necessary.

- Using reduction controls uniform illumination pattern by at least 50 percent.
- Using daylight zone control, occupancy sensors, and time clock controls.

4.2.6. Calculator2, Indoor environment quality (IEQ)

This calculator set of minimum requirements improving environmental indoor quality. It can increase productivity up to 9% for retail sales(Rock, 2006). Assessing environmental indoor quality is weighted by individual categories air quality, thermal comfort, acoustic comfort, and lighting. The real time of measurements is conducted in both periods, between 9:30 am to 12:30 pm, and 2pm to 5pm.According to their importance to the occupants' health and comfort in the retail buildings, the acceptability of IEQ is determined.

Table(4.6): weighting of four categories in
commercial indoor (RICS, 2012)

IE category	Weighting of category
Thermal comfort	30%
Air quality	30%
Acoustic comfort	20%
Lighting quality	20%

Table (4.6) illustrates the weighting of the four aspect of indoor environment quality. This weighting is related to the retail building.

4.2.6.1. Locating and selecting the samples.

The calculator assessing the mechanical building, then the measurements should be recorded during the HVAC system operating normally. The HVAC should be operate for at least one hour prior to the start of measurements((NABERS), 2010, RICS, 2012, Estidama, may, 2009). The measurements equipment should be sited in accordance to the following guidelines:

- Spreading the measurements across the floor as far as possible, it can be done in grid.
- The equipment should be sited at least of the dominions explained in table (4.7). It also perfectly is taken for the working areas, not on corridors.

Table(4.7): measurements distance from some objects(Estidama, may, 2009)

Intended object	Minimum distance of the object(m)
Corner and window	0.5
Walls	0.5
Emitting sources: printer, flowers or plants	1
Elevator	3
door	2

- Equipment used for taking the measurements should have qualitative specifications shown in the following table.

Table(4.8): Equipment requirements((NABERS), 2010)

Parameter	Measure	Equipment requirements
Thermal comfort	Relative humidity (RH)	Handheld instrument that allow a multipoint logging with an accuracy of $\pm 3\%$, range of 5-95%RH and resolution of 0.1%RH
Thermal comfort	Air speed	Handheld instrument that allow multipoint logging with an accuracy of $\pm 1\%$, range of 0-30m/s and resolution of 0.001m/s
Air quality	Carbon Dioxide	Instrument such as a real time carbon dioxide infrared analyzer with an accuracy of $\pm 3\%$, range of 0-3000ppm and resolution of 1ppm
Air quality	Carbon monoxide	Handheld instrument that records real time carbon monoxide levels with an accuracy of $\pm 3\%$, range of 0-200ppm and resolution of 0.1ppm
Air quality	Particulate matter	Real time particulate counter with a sensor based on 90° light scattering with particulate size range of 0.01-10um, measuring range of 0.01-100mg/m ³ and resolution of $\pm 1\%$
Acoustic comfort	Ambient sound	A level 1 or level 2 sound meter with an accuracy of $\pm 1\%$, range of 30-100dB and resolution of 1dB. The meter is to be set to read on A scale to record db.

4.2.6.2. First Sheet, Indoor Air Quality (IAQ)

Criteria for determining indoor Air Quality can be separated in to two categories, one of them is related to comfort level that is measured in section 3 of IEQ calculator. The other category is related to health and impulsively influencing the comfort level. The last category is measured by air pollutants parameters.

The most influencing pollutants are Carbon dioxide (CO₂), Carbon monoxide (CO), Particulate matter (PM), Airborne microbial (AM), Total volatile organic compounds (TVOC). This calculator measured the first three pollutants, while the other emissions especially those related to building materials are not included because the measured instruments are not available in Gaza; this measurement was done by comparing this value with international standard ASHRAE as in table (4.9). Other comparisons are done to outdoor measurements.

Table(4.9): illustrate the acceptable level of pollutant (OSHA, 2011)

Pollutant	ASHRAE standard
Carbon dioxide(CO ₂)	700 ppm
Carbon monoxide(CO)	10,000 µg/m ³ (1 h) 10 mg/m (1h)
Particulate matter(PM _{2.5})	65 µg /m ³ (24h)
Particulate matter(PM ₁)	20 µg /m ³ (24h)
Total VOC (TVOC)	500 µg/m ³ (1 h)
Formaldehyde	100 µg/m ³ (peak)

Whereas, µg /m³ is mean Micrograms per Cubic, mg/m is milligram / meter, and ppm is parts per million

- **Carbon dioxide (CO₂)**, only generated from tenant activity. Its level is influenced by both occupant density, and ventilation system. The measurement sample should be measured in occupied space to measure the occupied impacts.
- **Carbon monoxide (CO)**, it is mainly measured where the plants are placed. The instrument should measure concentration range from 0-200 ppm, with accuracy ±3% over the range of 0 to 10ppm, and with resolution of 0.1 ppm.
- **Particulate matter (PM)**, these pollutants are made up of components including acids (such as, nitrates and sulfates), chemicals materials, and soil or dust particles. They may be less than 5 microns, or more. PM₁₀ less than the required 10 micron; that it is the most influence on occupant health. It is taken in occupied spaces that are controlled by ventilation system and equipment existence.

Table(4.10): instruments requirements

	Range	Accuracy	Resolution
CO₂	0-3000ppm	±3% over the range of 0 to 1500ppm	1ppm
CO	0-200ppm	±3% over the range of 0 to 10ppm	0.1ppm
PM	0.01 - 10µm	0.01 – 100mg/m ³	±1%

4.2.6.3. Second sheet, Acoustic comfort

The acoustic comfort is determined by measuring ambient sound, then comparing it to ASHRAE standard in (dB). It is sited on different- separated spaces. The instrument used for that should measure range of 30 -100 db, with accuracy of ± 1 db and resolution 1dB. And the total acceptable acoustic comfort is 55 db.

2. Acoustic Comfort Inputs						
Samples (dB) taken from the tenanted floors identified in step 1	Results from ambient sound readings (dB)					
	Sample 01	Sample 02	Sample 03	Sample 04	Sample 05	Sample 06
Enter floor name, number here						
Enter floor name, number here						
Enter floor name, number here						
Enter floor name, number here						
Enter floor name, number here						
Enter floor name, number here						
ACOUSTIC COMFORT RESULTS						
Total Average Ambient Sound in the Tenanted Office Space (dB):						#NUM!
FINAL RESULT FOR ACOUSTIC COMFORT						#NUM!

Figure(4.4): Acoustic comfort sheet

The acoustic comfort is determined by measuring ambient sound in dB. The instruments is sited on different separated spaces.

4.2.6.4. Third sheet, Thermal comfort section

If the building is naturally ventilated, then the level of comfort should compare to outdoor temperature, and it should include measurements of air speed only. Otherwise, if the building is mechanically ventilated or a mixed mode system, then the level of comfort is compared with standard of comfort with reference to the climate zone. More, the measurements should include relative humidity and speed of air.

- **Temperature (T)**, it is measured as part of the thermal comfort section for all building types. It may be measured by two methods. The first is by using BMS (building management systems) program that required data about the building in frequency of monthly, weekly, or more. The second is by using hand held instrument where the resolution is quarterly or once only. In case of using the second on the instrument should measure in range of 0-5 C° with accuracy of ± 0.5 C°, and resolution of 0.1 C°. in this calculator the first method is not considered.

- **Relative humidity (RH)**, it is measured only in the calculator by hand held instruments, despite using BMS output data which is available. The instrument must measure in range of 5-95% RH with accuracy of $\pm 3\%$, and resolution of 0.1% RH.
- **Air speed (AS)**, it is executed by instrument with range of 0-30 m/s, with accuracy $\pm 1\%$ and resolution 0.001m//s.

Figure(4.9), and (4.10) show the thermal comfort condition in relevance to temperature, air speed , and humidity, are as the indicators controlling the thermal comfort (Kubba, 2010d, PreparatoryCommitteeforefficientbuilding, 2004).

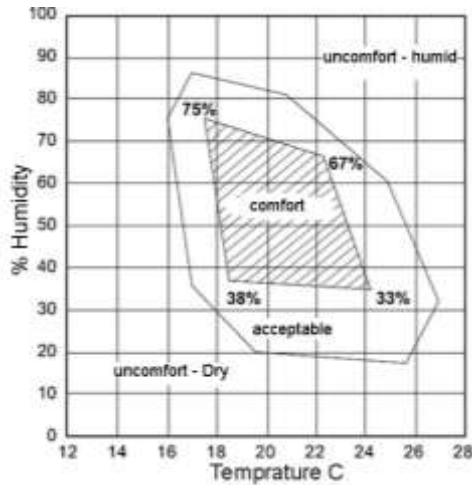

Figure(4.5): Thermal comfort in accordance with humidity and temperature

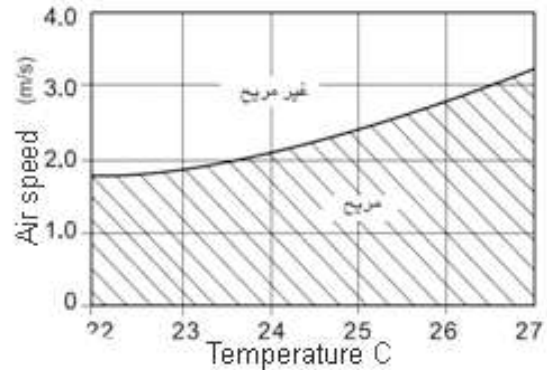

Figure(4.6): Thermal comfort in accordance with Air speed and temperature

Measurements taken at the following locations:		Temperature (°C)	Relative Humidity (%)	Air Speed (m/s)
Enter No. of floors	Sample 1	Morning		
		Afternoon		
	Sample 2	Morning		
		Afternoon		
	Sample 3	Morning		
		Afternoon		
	Sample 4	Morning		
		Afternoon		
	Sample 5	Morning		
		Afternoon		
	Sample 6	Morning		
		Afternoon		
Does the internal temperature is limited?				
Enter the limited temperature				
Final result of thermal comfort				

Figure(4.7): Thermal comfort sheet

4.2.6.5. Fourth sheet, Visual comfort

This calculator is ensured in terms of the adequacy of visual comfort condition; hence, the acceptability of lighting is given when 95% of occupied spaces meets the lighting performance requirements shown in figure (4.11). The measurements are done while the space lightings are operated for at two hours before measuring.

Table(4.11):Nominal illumination level according to commercial spaces
(Estidama, may, 2009)

Area	Illumination level(Lux)
Internal corridors	200
Elevator services	200
Dining area	150-200
Entrance	500
Selling and displaying area	750

Analysis and Results

This section analyzes and discusses the three steps conducted in the methodology. The first one is the interviews performed with various authorities in the Gaza Strip. This step was very important for some issues related to interior design profession, such as materials testing, specifications and legislations for commercial interior design, and the supervision in the design of interior. Then the second step after the interviews, was the questionnaire that carried out with firms throughout the Gaza Strip to assess their perceptions attitudes, behaviors, and the barriers and motivation towards sustainable practicing. Whereas, the questionnaires give indication that designers have good perception, and positive attitude among the analytical process, but their environmental behaviors were not guided. Then to realize the objectives of this thesis, the study improved tools to evaluate commercial project in Gaza to highlight the critical problem existing in the indoors. Then the study will be a basis for researchers, designers.

There were similarities in the answers. Hence, the interviewees generally expressed their support for such these issues in order to contribute to decreasing the environmental impacts. Their answers for the six questions suggested in semi- structural interview were asked in the fifth interviewees.

According to the fifth answers about “Presence of environmental criteria and specifications for all related products to interior spaces, appliance, equipment, finishing materials, and availability of eco products list”, there is no written criteria. Moreover, arbitrating the architectural, electric, sanitary drawings have no written specifications. This may be the first step that should be done to force the designers toward more conscious designs.

There is no supervision for the interior design projects, despite the supervising visit to food building and healthy building by group including staff from municipality and ministry of environment. Although there is no accurate observation for most of interior projects.

The testing for exciting materials or new one has no specification; it just tests the physical characteristics. Moreover, there is no specialist laboratory in Gaza to examine the percent of emitted substances in the building materials.

There are environmental policies for the ministry of environment related to waste management, while the other aspects of sustainability have no plans such as, reducing the energy use, improving the indoor environment quality, and water use.

The interviewees declare that step is advance, but it is important and influential. The first step is suggested to be in food retails or healthy buildings that can easily be forced to the

legislations. Then this step will be more effective after the people imply the Regulatory Plans.

The barriers toward this step in the Gaza Strip are too difficult to force people on such specifications: the capacity for the authorities, needing large staff, and lack of the instruments and tools. Some of these barriers will be overcome by positive environmental attitudes to the designers, while others will be too great to implement despite the positive attitude.

5.3.1. Measuring the knowledge about sustainable practices

This group includes four of questions measured the perception of environmental-sustainable design among interior profession. These question are related to their perception for some characteristics of sustainable interior design, tools of measuring the sustainable level for the project, the apparent environmental problems in most of Gaza indoor spaces. An open question about the sustainable interior design definition precedes all questions; hence, the respondents' answers to this question were deleted.

Forty four percent of respondents completed this question(A₁), as 13% of respondents who answer this question in the starting of the questionnaire, and 18.1% of respondents delay answering the first after looking at the questionnaire' details. Most of answers were general, the others were not accurate. Table (5.1) illustrates the answers.

Table(5.1): The open question' answers

The answers: sustainable design is	NO. of respondents
Good and fitted design	1
That keep up with environment	3
That use materials with no environmental impacts	3
Energy efficient design	1
Green design	1
That depend on the natural lighting and ventilation	1

Among the designers applying for the questionnaires, there was 37.5% who consider that level of natural ventilation and lightening as the most serious problem in indoor spaces in Gaza. And the next largest percent was 29.8% for materials quality. In contrast, the minimum percent was 1.9% for efficient using for water. And other issues' percents ranged from 9.6- 10.6 %.

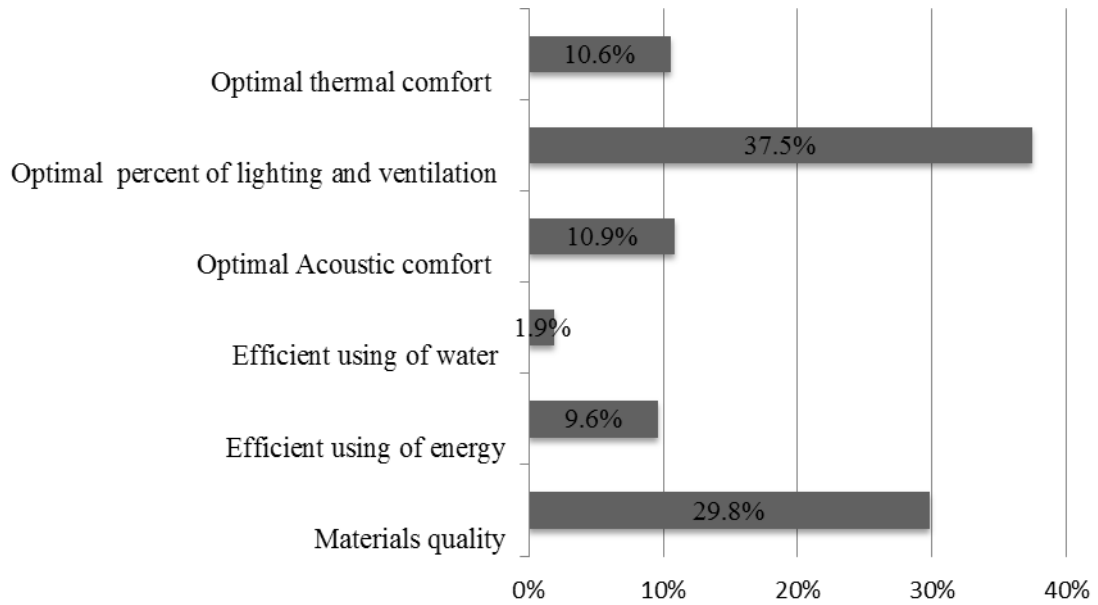

Figure(5.1): A₂, the most serious problem at indoor space in Gaza

The agreement about if the sustainable interior design can achieve the following statements have a mean equals 2.54 (84.82%). The mean of this field is significantly greater than the hypothesized value 2. It conclude that the respondents agreed to field of “A4”.

The mean of paragraph (a) “Sustainability is concerned with environmental aspects as its concern with other aspects economic and social” equals 2.79 (93.01%). The sign of the test is positive, so the mean of this paragraph is significantly greater than the hypothesized value 2. This can conclude that the respondents agreed to this paragraph.

The mean of paragraph (h) “Designers can reduce waste among sustainable interior design” equals 2.31 (77.05%). The sign of the test is positive, so the mean of this paragraph is significantly greater than the hypothesized value 2. It conclude that the respondents agreed to this paragraph.

Table (5.2): Means, percent, and rank for “A4”

Item	Mean	percent (%)	Rank
a. Concern in environmental aspect as its concern with other aspects economic and social.	2.79	93.01	1
b. Enhance ethical aspects toward environment.	2.79	93.01	1

Table (5.2): Means, percent, and rank for “A4”

c.	Has the ability to reduce environmental impacts.	2.60	86.56	4
d.	Contribute to reduce consuming of electricity and energy.	2.55	84.95	5
e.	Reduce space pollutants among sustainable interior design.	2.52	83.87	6
f.	Reduce consuming water among sustainable interior design	2.37	79.03	10
g.	Reduce wasting of among sustainable interior design	2.31	77.05	11
h.	Benefit the physical and mental health of occupants among sustainable interior design	2.52	83.87	6
i.	Increase occupant’s performance among sustainable interior design	2.44	81.18	8
j.	Affect with Activities’ Functional relationship on environmental level for any projects.	2.44	81.18	8
k.	Affect with space’s colors	2.67	89.07	3
All paragraphs of the filed		2.54	84.82	

According the previous table and the other previous A1, A2 results, there are gaps in understanding the comprehensive definition of sustainability in group of respondents, especially, when related to the water consumption criterion, and waste management.

The percent of no response question A₄ that evaluates designers’ knowledge of environmental tools, was 32.5%; that refers to surprising the candidates with unknown tools. Then, the first rank (48.2%) was for paragraph (J) expressing nothing of these tools does the designers know. These indicated designers are often not concerned with the environmental standards that reflect non environmental designs.

Table (5.3): Designers’ knowledge of environmental evaluation tools.

	Tools	Percent	Rank
a.	DQI(design quality indicator)	6.0	5
b.	EMGB(Evaluation manual for green buildings)	8.4	4
c.	EPGB(Environmental performance Guide for building)	2.4	8
d.	GBTool(Green building challenge)	10.8	2
e.	GHEM(Green home evaluation manual)	4.8	6
f.	Leed(leadership in energy and environmental design)	4.8	6
g.	NABERS(National Australian building environmental rating system	1.2	10
h.	SBAT(Sustainable building assessment tool)	10.8	2
i.	SPeAR(sustainable project appraisal routine)	2.4	8
j.	Nothing of these	48.2	1

5.3.2. Evaluating the attitudes toward sustainable interior design

The mean of the filed “B1” equals 3.78 (75.57%), so the mean of this field is significantly greater than the hypothesized value 3. We conclude that the respondents generally agreed to field of “B1”.

The mean of paragraph (a) “Sustainable interior design is insistent step to preserve the natural resources” equals 4.15 (82.90%), so the mean of this paragraph is significantly greater than the hypothesized value 3. We conclude that the respondents agreed to this paragraph.

The mean of paragraph “Sustainability far from esthetical aspects of indoor spaces” equals 3.13 (62.58%). Then the mean of this paragraph is insignificantly different from the hypothesized value 3. The respondents mostly answer neutral to this paragraph.

Table (5.4): Means and Test values for “B1”

Item	Mean	per	Rank
a. Sustainable interior design is insistent step to preserve the natural resources.	4.15	82.90	1
b. Sustainability far from esthetical aspects of indoor spaces.	3.13	62.58	1
c. Sustainable interior design practices are not a passing trend.	4.00	80.00	4
d. Sustainable interior deigns provide less cost.	3.23	64.59	10
e. It is necessary to motivate both of clients and worker to practice sustainability in the design of interior.	3.90	78.06	6
f. It is necessary to insert sustainability through curriculum in related field.	4.02	80.32	2
g. Authorities as engineering association and municipalities have the biggest role environmental awareness.	3.62	72.46	9
h. It is difficult to practice sustainability in case of laws’ absence.	3.63	72.58	8
i. I can encourage clients to use sustainable interior design practices on projects.	3.85	77.10	7
j. I am open to use sustainable interior design practices if there are a motivations	4.02	80.32	2
All paragraphs of the filed	3.78	75.57	

This group (B₁) indicates that the designers have appositive attitude toward sustainable interior design. Accordingly, there should be a tested method to examine if the applied

the sustainable aspects in their projects are the aspects that the next battery will illuminate.

5.3.3. Behaviors and practices for sustainable interior design

The following figure indicates the results of C_1 that 40 of designers who consider environmental aspect among their designs. It may refer to inaccurate percent; hence, supposition for most of designers is that environmental aspect restricted on opening areas to make good ventilation.

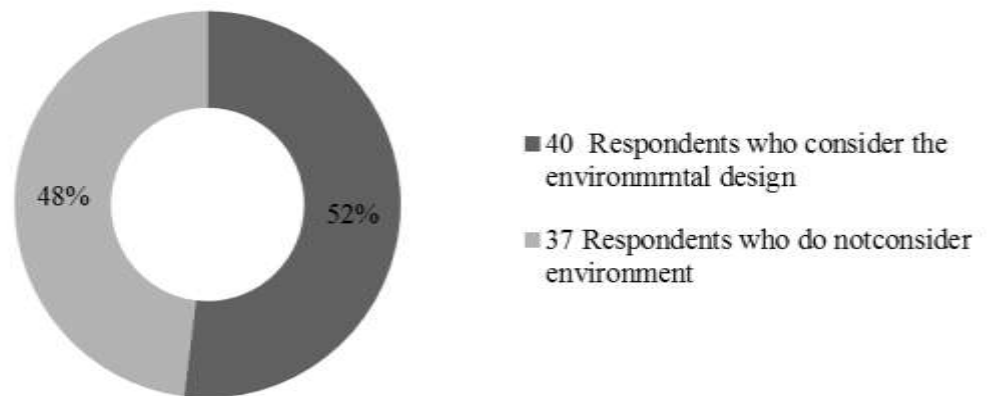

Figure(5.2): Putting environmental aspects as a main objective for design

C₂: Times of practicing sustainability in design of interior

The time of practicing sustainability in design of interior, was investigated in C_2 . Then, the percent of designers who never practice sustainability was 71.0%; that enhances the fact be there problems exist. While some of designers denoted their knowledge about sustainable aspects, they considered some projects as representative of sustainable interior design approach. This percent was not accurate since the mentioned projects that practice sustainability were not completely sustainable according to Chapter Two. This project are Islamic university of Gaza, El Shefaa hospital, and recreational and cultural house.

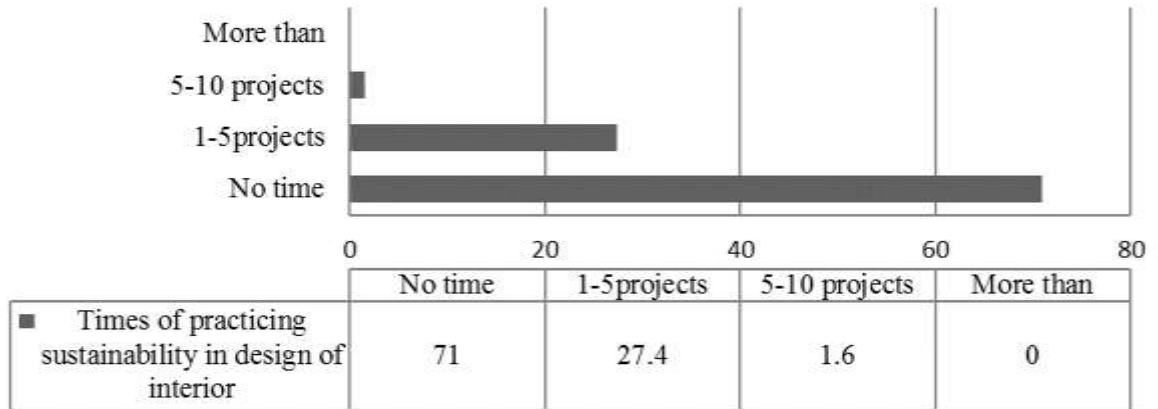

Figure(5.3): Times of practicing sustainability in design of interior

Half of the respondents express in C₃ that there is no goal. The little awareness about environmental issues despite the long experience years, is an indication that the environmental issues is not concerned.

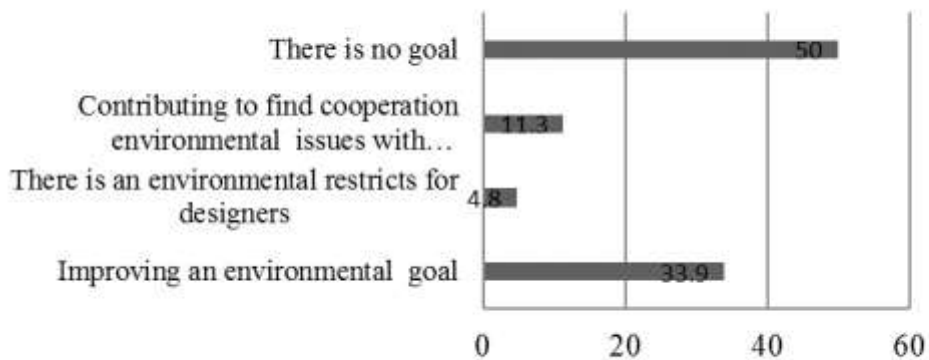

Figure(5.4): presence of a concrete environmental goal

About 54.1% of respondents did not confront any environmental problem, but the most important of these category designers commented that there are no indicators that allow to assess any situation as a problem or not. 8.2% of respondents mentioned some problems as, IAQ causing osteoporosis, maintenance cost, painting problems.

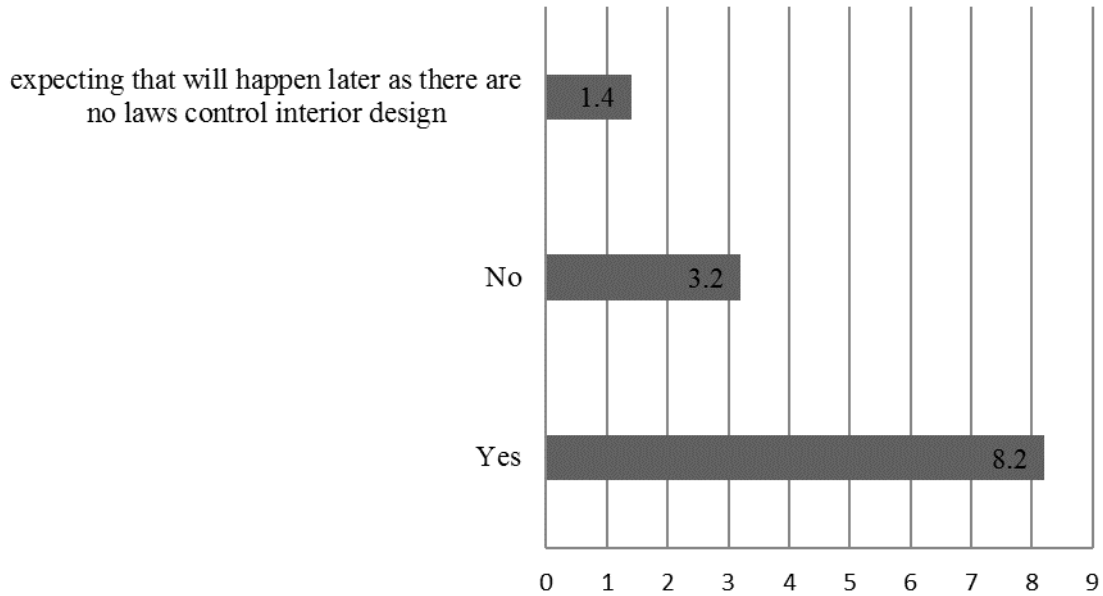

Figure(5.5): Confronting any environmental problem while or after design stage

There were little contributions that ranged from 4.8- 14.5%, while the most percent (53.2%) was for no contribution until now. This is an apparent indicator for absence of focus instruction about environment across the Gaza Strip.

Table (5.5): How do your company's activities contribute to better environment?

How do your company's activities contribute to better environment	Frequency	Percent
Through improving the policy of using recycled materials.	3	4.8
Joining to the firms and institute that concern the environment.	7	11.3
Creating a commitment to apply the concept of sustainability in design of interior.	9	14.5
Optimal investing for energy.	5	8.1
We have small contribution.	5	8.1
There is no contribution until now.	33	53.2

The following table indicates the rank of each factor as a priority when choosing materials and construction methods. This refers to the fact that the clients' requirements is the driving factor in design process, while the environmental aspects impact for both environment and occupants , durability and continuity , and the ability for recycling or reusing, is coming in rank 5.

Table (5.6): The priority in choosing finishing materials and construction methods

What is the order for the following factors as a priority, when you choose finishing materials and construction ways?	Rank
Client's requirements	1
Aesthetic requirements	2
It's impact for both environment and occupants	5
The ability for recycling or reusing	7
Availability	3
Flexibility	4
Durability and continuity	6

Sixty respondents were using plants in their design whereas, client's desires are the most powerful reasons in both cases using plants or not in interior design, while just 7.8% from respondents designers use plants to reduce CO₂ as the first priority as shown in table(5.7). While this question had sex options, the most important is the one that put the clients' desire as the first, then the esthetical requirements, and the last priority was reducing CO₂. That may indicate two important issues, the first, using some of environmental behaviors may be random. The second is that clients' desires are guiding force in any design, so any step should include them.

Table(5.7): the priority of using plants

	1st Priority Frequency		2nd priority Frequency	3rd priority Frequency
Client's desire	31	Esthetical requirements	24	24
		Reducing CO ₂	7	7
Esthetical requirements	23	Client's desire	20	20
		Reducing CO ₂	3	3
Reducing CO ₂	6	Esthetical requirements	2	2
		Client's desire	4	4



Figure(5.6): The reasons for using plants

This figure presents that clients' desires and aesthetic requirements are the first priorities for most designers. While, reducing CO₂ is of less priority when choosing the plants in design of indoor spaces. Seventeen respondents were not concerned with the plants in the indoor spaces as shown in figure (5.7), and that illustrates the priorities for unwilling to use plants.

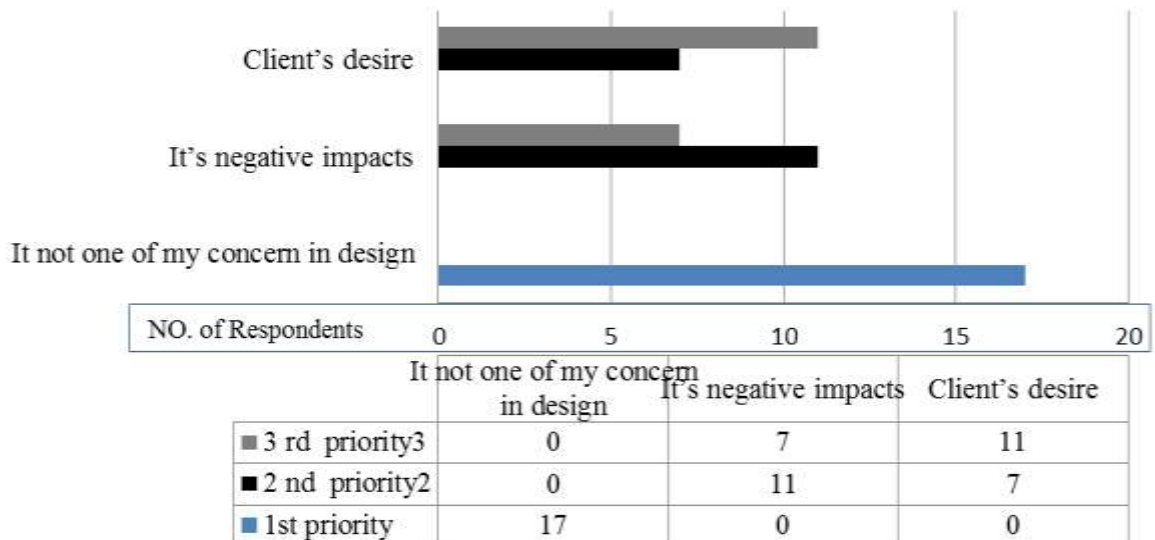

Figure(5.7): The reasons for unwilling to use plants

The percentage of natural lighting is investigated in **C8**. The number of respondents who answered this question is 32 as shown in table (5.8). The disability to predict the exact percent for natural lightning design may indicate that the designers do not depend on exact standards when they design.

Table (5.8): percentage of natural lighting

Lighting design percent	Frequency	Percent
1%-25%	5	15.6
26%-50%	14	43.8
51%-75%	5	15.6
76%-100%	8	25.0
Total	32	100.0

According to C₉ question, it is obvious that designers are using lightning in unconsciousness way that increase using energy. About 54.3% of respondents declared using additive numbers of light elements when designing commercial spaces. The other 45.7% preferred using minimum numbers of elements to realize the appropriate efficiency.

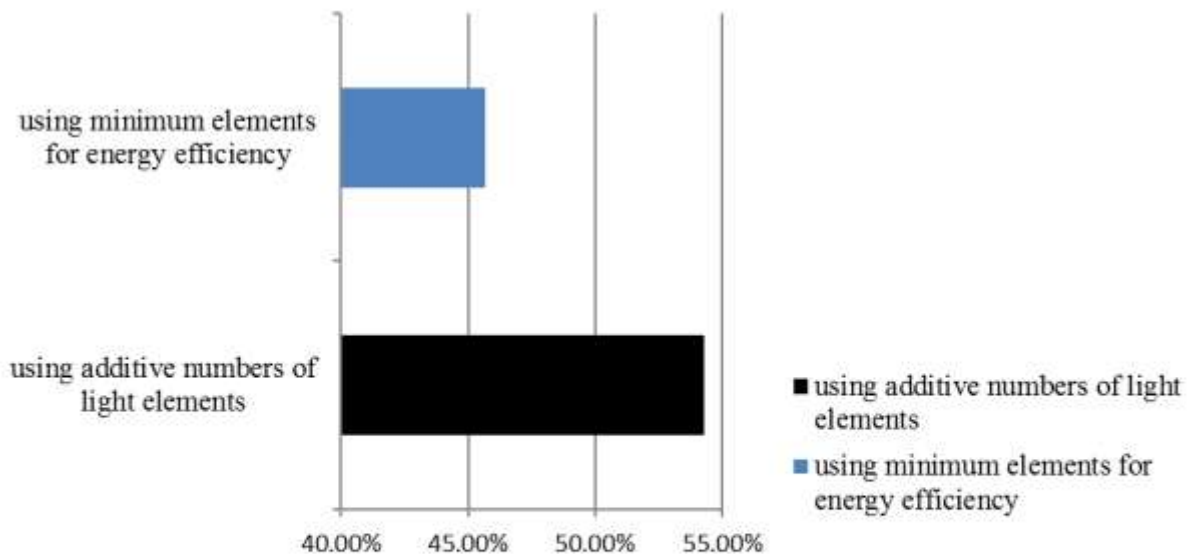

Figure(5.8): Calculation for efficient lightning

Designing for thermal comfort was investigated in C₁₀ question. The percent of respondents who depend on using air conditioners to enhance thermal comfort is 71.0%. While as, 1.7% of respondents use thermal isolators, and 27.3% of designers use passive design method as figure (5.9) show.

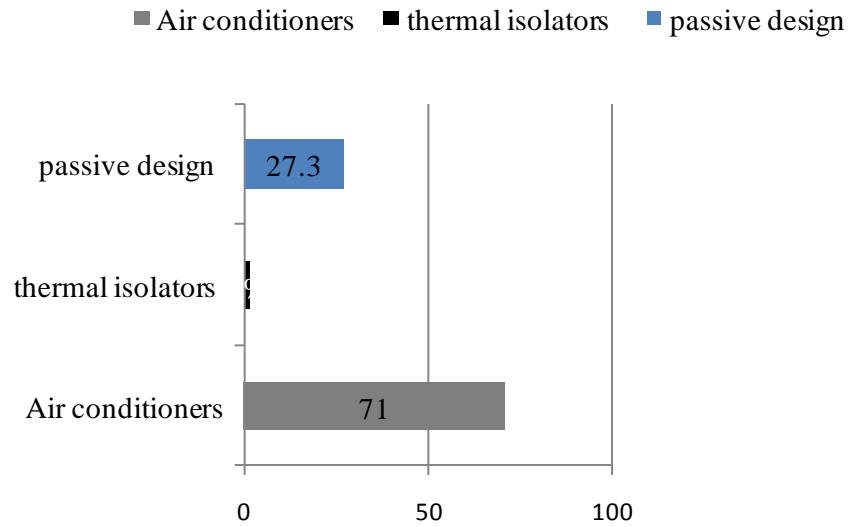

Figure(5.9): percent of using passivedesign, thermal isolator, Air condition for optimal thermal comfort

Question C₁₁ investigates if the designers use acoustic isolators. The following figure illustrates the percent of respondents who use acoustic isolators. These isolators are double wall, wooden boards, and polystyrene.

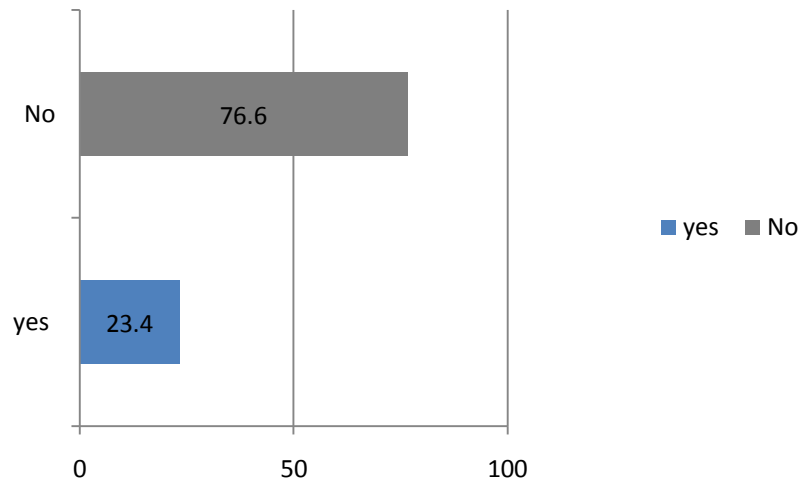

Figure(5.10): Using acoustic comfort

According to the question C₁₂ the first priority for choosing electric devices and light elements is aesthetic requirements. Then, the energy efficiency is the second priority when choosing electric devices and light element. Table (5.9) illustrates the percent of response for each factor.

Table(5.9): The priority of choosing electric elements

	1st Priority Frequency		2nd priority Frequency	3rd priority Frequency
Aesthetics requirements	43	Energy efficiency	31	31
		Commercial marks	12	12
Energy efficiency	23	Aesthetics requirements	19	19
		Commercial marks	4	4
Commercial marks	11	Aesthetics requirements	8	8
		Energy efficiency	2	2

The most used method for water heating as it investigated in C₁₃ was electric heater, and the less percent was for solar heater as shown in figure(5.10), and the passive method was not the first priority for any of the respondents. The following table illustrates the numbers of the respondents for each methods.

Table(5.10): The priority of heating water systems

	1st Priority Frequency		2nd priority Frequency	3rd priority Frequency
Electric heaters	58	Solar heaters	46	46
		Other passive methods	12	12
Solar heaters	19	Electric heaters	13	13
		Other passive methods	6	6
Other passive methods	0	Electric heaters	0	0
		Solar heaters	0	0

This unconscious using of electricity as result of absence of forced standards for using the energy among the building.

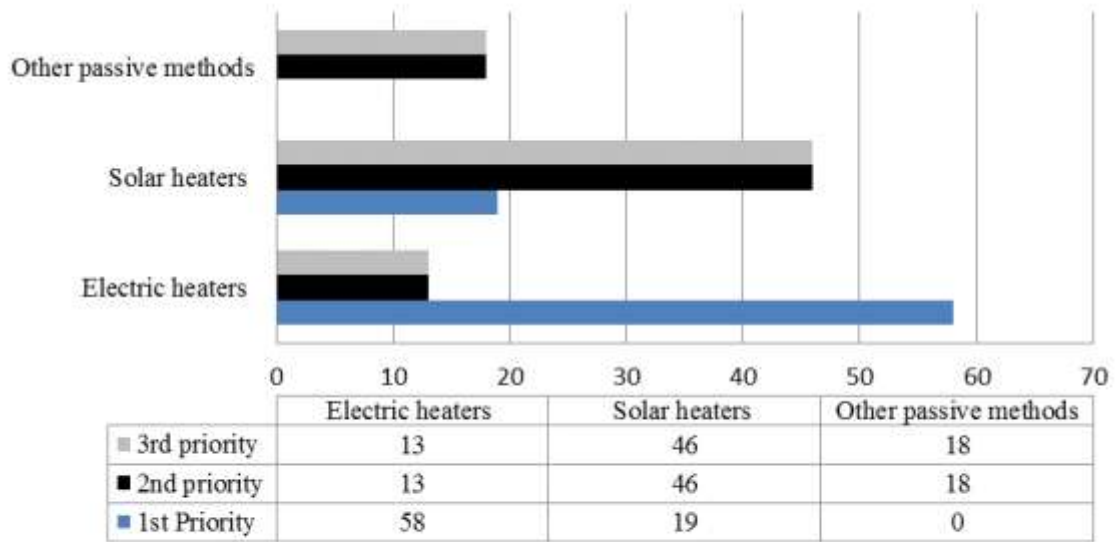

Figure(5.11): The priority of heating water systems

Question C14 investigates the percent of Using special devices and taps for reducing water consumption. The percentage respondents who said that did not use special devices and taps for reducing water use was 66.2%. Then, two of the answers mentioned the projects where they use these devices. One, is the Palestine legislative council, and the second is Yousef El Najar hospital. The other did not write where they use the devices. While 14.3% of the candidates did not answer this question. This indicates the absence of awareness of sustainable aspects.

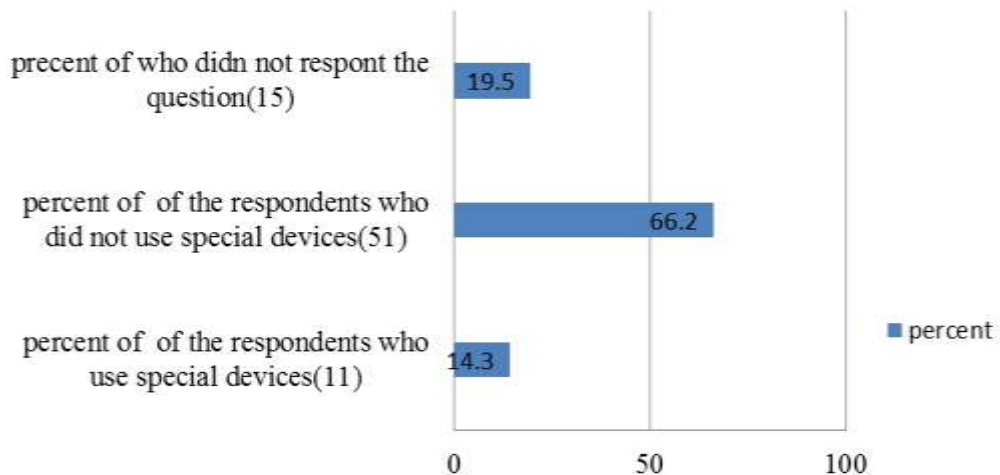

Figure(5.12): Using special devices and taps for reducing water consumption

At C₁₅ question, the percent of the respondents who explicated in that they did not recycle the materials ever was 85.7%, but there are about 11 of respondents who depend on recycled materials in interior design of some projects. These projects are samples of recycling projects such as, El Mathaf restaurant.

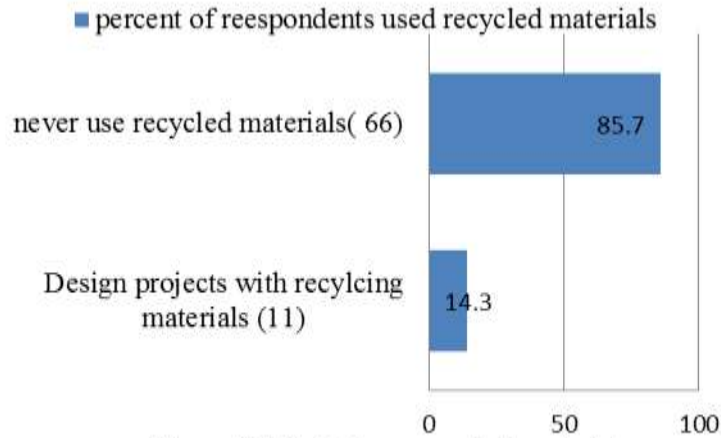

Figure(5.13):Using recycled materials

The results of C₁₆ question indicate that using software program to make environmental analysis, is not a common practice among the designers. This affirms that interior design profession in the Gaza Strip is not a familiar process. Hence, 81.1% did not use any of design software to help in the decisions of engineers.

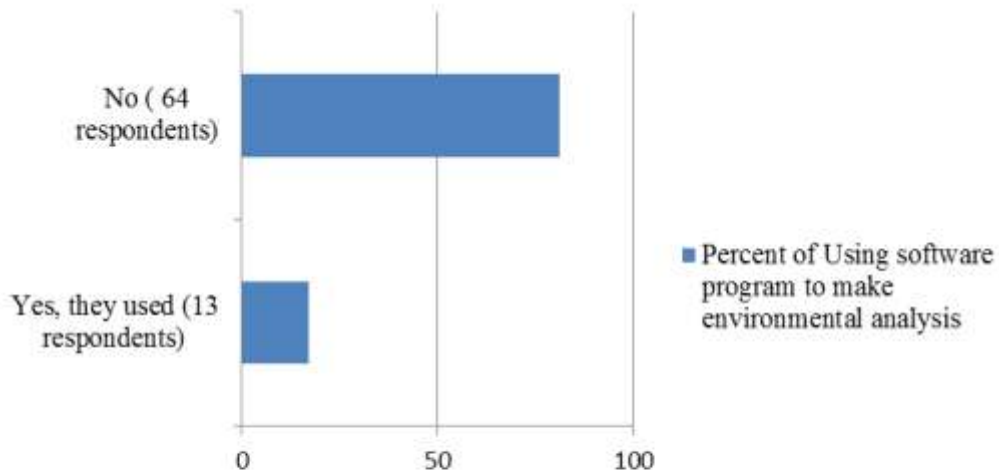

Figure(5.14): percent of using software program to make environmental analysis

5.3.4. Barriers and motivation among practicing interior design

D1: The factors that prevent practicing sustainable interior design

The mean of the filed “D1” equals 3.31 (66.22%), the sign of the test is positive, so the mean of this field is significantly greater than the hypothesized value 3. We conclude that the respondents agreed to most of the written factors as barriers preventing practicing sustainability in interior design.

The mean of paragraph (a) “Cost of sustainable materials” equals 3.81 that indicates the most of respondent consider it as influence barriers. Whereas, paragraph (e) “My level of experience with sustainable interior design practices” has mean equals 2.93 (58.69%) that indicate the respondents (Do not know, neutral) to this paragraph.

Table (5.10): Means and Test values for “D1”

Item	Mean	percen t (%)	Rank
a. Cost of sustainable materials	3.81	76.13	1
b. Project program and the requirements	3.52	70.49	3
c. Desiring to design freely without any restricts	2.95	59.02	11
d. There is no forced law for practicing.	3.47	69.35	5
e. My level of experience with sustainable interior design practices	2.93	58.69	12
f. Lack of expressed from clients.	3.19	63.87	8
g. Lack of resources related to sustainable interior design	3.56	71.15	2
h. Lack of experiences	3.30	66.00	7
i. Lack of expressed from team workers	3.31	66.23	6
j. Life style at Gaza	3.52	70.49	3
k. Lack of focusing on these issues in the media	3.11	62.30	9
l. Eco friendly materials are not available in Gaza.	3.05	60.98	10
All paragraphs of the filed	3.31	66.22	

The mean of the filed “D2” equals 3.18 (63.54%) so the sign of the test is positive, so the mean of this field is significantly greater than the hypothesized value 3. We conclude that the respondents affirm that all these factors can motivate designer for sustainable interior design.

The mean of paragraph(C) “Client’s desire” equals 3.90 (78.06%), so the mean of this paragraph is significantly greater than the hypothesized value 3. We conclude that the respondents agreed to this a good motivation to adopt sustainable interior design in the projects. That adapts with most of results as the clients is influence force.

The mean of paragraph (F) “Find interested in this issues at curriculum” equals 2.58, so the mean of this paragraph is significantly smaller than the hypothesized value 3. We conclude that the respondents disagreed that curriculum is a motivated mean for firms.

Table (5.11): Means and Test values for “D2”

Item	Mean	Percent (%)	Rank
a. Personal initiative	3.10	61.94	4
b. Laws	3.26	65.16	3
c. Client’s desire	3.90	78.06	1
d. Knowledge and inception	3.28	65.52	2
e. Encourage clients to apply sustainability in both economic and aesthetic aspects	2.94	58.71	5
f. Find interested in this issues at curriculum.	2.58	51.67	6
All paragraphs of the filed	3.18	63.54	

Many malls, supermarkets, restaurants in Gaza have similar characteristics, that most of them are located on lower floors or inside ground of high rise commercial or residential buildings. In other words, they are situated in heavy traffic environment that adversely influences the indoor air quality. Moreover, several pollutant sources are existed in retail food buildings, such as using gas stoves, smoking habits, and inefficient HVAC system. All these factors in addition to absence of studies focus on indoor environment quality, and definitively affirm the importance of evaluating the indoor spaces. Moreover, most energy used in supermarkets is in form of both electricity and gas; thus depending on heating, cooling, and lighting, the consumption can be limited. Hence, the energy consumption is depend on shopping activities, equipment, area of displaying, food courts. Water is important indicator for sustainable behavior for the building that must be managed through using efficient appliance, and management systems. Managing construction and demolition waste can contribute in sustainable developing among the countries.

El Andalusia mall is established recently. Three floors with about area of 2700 m² was evaluated including major entrances, exist, and car parking in the front of the mall. The largest dominion is I south oriented. The building divided on three parts supermarket, shops, and cafeteria.

5.4.1. Evaluation Energy Efficiency

The energy consumption along the building has two forms: electricity and oil. According to the electricity bills for 12 months, the average consumption annually is 600,000 kw, while the oil consumption is 72,000 L/year (Radi, 2012, Interviewing Eng. El Esawi, 2012).

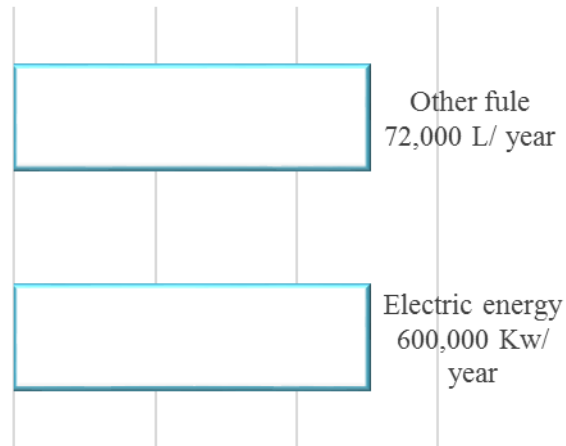

Figure(5.15): Energy consumption by sources

5.4.1.1. Envelope materials

Design of the buildings that depend on the mechanical air conditioners, so there are no opening windows. The exterior southern wall is coated by composite panels, and all interior walls and ceiling were painted with supercryl, and vinyl paint. Porcelain tiles are used for all flooring areas. Security glass is used in the fenestration elements in the main elevation. The following tables (5.12), (5.13), (5.14), and (5.15) illustrate the U- value for floor and ceiling, wall, and roof.

Table(5.12): Envelope U- value

	Materials details	u-value W/m ² .k
Floor & Ceiling	Concrete, porcelain tile	2.6
Roof	Concrete, porcelain tile, supercyle paint	3.8
Wall	Composite panel, plaster, hollow block, plaster, supercyle paint	3.6
	plaster, hollow block, plaster, supercyle paint	3.8

Table(5.13): Calculation for main wall u- value

layers	plaster	Hollow Block	Plaster	Composite panel
Thickness mm	20	200	30	40
Thermal resistance (R) M ² . K/W	0.017	0.22	0.025	0.0103
U-value = $\frac{1}{R}$	$\frac{1}{0.272}$	= 3.67 W/m ² .K, and then other wall have u- value of 3.8 W/m ² .K		

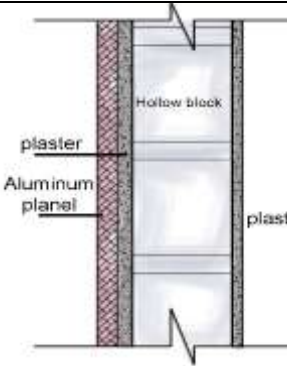

Table(5.14): Calculation for floor and ceiling

Layers	Tile	R.C	Hollow Block	plaster
Thickness mm	20	80	170	20
U- value = 2.6 W/m ² .K				

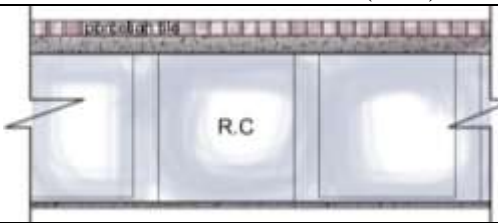

Table(5.15): Entrance glass details

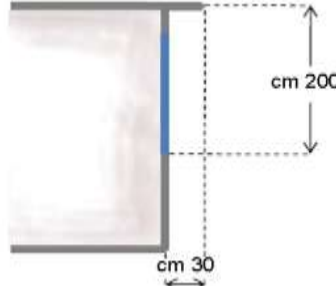
Glass	Solar heat gain coefficient (SHGC) for glass	0.4	
	u- value	5.5	
	Factor projection (FP) = 30 / 200cm	0.15	

The area of glassing is $(2 \times 2.8 \times 9 \times 3)$ 151.2 m², where there is no opening area except the nine one on the main façade along the three floors. Then, the percentage of glassing area is 9.3% regard to the total wall are. Accordingly, the window area is acceptable when compared with the calculator result.

There is no skylight in the mall space, for the mall is built at the first three floors of residential building. All these data were enter the calculator and the result of accepting the envelop is shown in figure (5.16).

1. ENVELOPE ELEMENTS				
	Envelope Elements	Target Requirement	Design Value Achieved	Pass / Fail
opaque Elements	Roof	1.8	2.6	Fail
	Wall1	2.5	3.7	Fail
	Floor	1.2	2.6	Fail
Fenest	Vertical glazing Area	30%	9%	Pass
	Entrance Door	2.6	5.5	Fail
	0.25<=PF<0.50	0.3	0.4	Fail
Infeltration	Building Air Leakage Rate,L/s/m ²	3.6	5	Fail
Overall Pass/Fail for Building Envelope				Fail

Figure(5.16): Envelope result

5.4.1.2. HVAC system

The HAVC system used along the building depends on split duct units. It distributes 10 along ground floor, 8 units in each of first and second floor, and 8 splits units floor administrative department. The specifications for these units are shown in the table (5.16). Electric energy cost of HAVC system can be calculated acceding to the following equation.

$$\frac{\text{Units size (BTU/h)} \times \text{No. Of unit} \times \text{hours per year (h)} \times \text{energy cost (Shekel/kW \cdot h)}}{\text{SEER (BTU/W \cdot h)} \div 1000 \text{ (kW/W)}}$$

Whereas,

The occupied hours in a day are 16 h.

The cost of electricity in Gaza is 0.5 Shekel for every KW,

And the seasonal energy efficiency ratio (SEER) can be calculated from COP value.

COP = 0.875 SEER, then SEER for the using device is $2.5 \times 0.875(8.9)$.

$$\frac{(60,350 \times 26) + (13,997 \times 8)(\text{BTU/h}) \times (8 \times 360)(\text{h}) \times 0.5(\text{Shekel/kW}\cdot\text{h})}{8.9(\text{BTU/W}\cdot\text{h}) \div 1000(\text{kW/W})} = \frac{271,994}{\text{Shekel}}$$

Where 271,994 Shekel is the electricity cost for 8 h per day, and if assuming that the electricity is available 8 hours per day, then the total consumption of electricity is 300,000 Shekel(as the electricity value for 8 hours is 25000 Shekel per month). Consequently, HVAC system consumes the bulk of electricity; it consumes 90.6% from total electricity.



Figure(5.17)Electric energy consumption for the building

Table(5.16): conditioners characteristics

floor	Equipment type	NO	Size category	Coefficient Of Performance (COP)
G.F.L	CU- duct split unit	10	17,585 KW	2.5
F.F.L	CU- duct split unit	8	17,585 KW	2.5
	Split unit	8	4100 KW	3.4
S.F.L	CU- duct split unit	8	17,585 KW	2.5

According to the calculators, the air conditioners used in the building are not subjected to the minimum standards for efficient energy system. All spaces are mechanically ventilated, and every zone provided with thermostatic which is capable of responding to temperature.

2. HEATING VENTILATION AND CONDITIONING (HAVC)					
	size category /Equipment Type	Minimum Efficiency / cop	Design Value	Design Achieved	Pass / Fail
Split unit	Air conditioners Air cooled	Target requirement			----
	< 19kW	3.55		2.5	Fail
	< 9kW	3.52		3.4	Fail
Condensing Unit	Air cooled, (Cooling mode)	Target requirement			----
	Through-the-Wall (Air cooled, cooling mode)	Target requirement			----
Chiller unit	< 150 tons	2.8		5	Pass
	95°F db outdoor air	2.23			Fail
system fan power	Fan System Type	Included?	Target Requirement	Design Value Achieved	Pass / Fail?
	Central mechanical ventilation, incl. heating & cooling	No	-		-
	Zonal supply system where fan is remote from zone, i.e. ceiling or roof mounted	No	-		-
	Zonal extract system where fan is remote from zone	No	-		-
	Zonal supply & extract ventilation units such as ceiling void or roof units serving single room/zone with heat recovery	No	-		-
	Local supply & extract ventilation units such as wall/roof units serving single room/zone with heat recovery	No	-		-
	Local supply & extract ventilation units such as window/wall/roof units serving single area (e.g. toilet extract)	Yes	0.4		Fail
	Other local ventilation units	No	-		-
	Fan assisted terminal VAV unit	Yes	1.2		Fail
	Fan coil units (weighted average)	No	-		-
HVAC SYSTEM					Fail

Figure(5.18): HVAC system result

5.4.1.3. SHW

System of heating water is not operative one at this building, as only two heaters are used for heating food in the restaurant.

3. Service Hot Water System					
Electric Hot Water Systems	Hot Water System Efficiency				
		capacity(L)	Minimum efficiency	Achieve	P/F
	Others	1000	0.62		FAIL
	Hot Water System Controls				
	Are temperature controls provided to satisfy the set point requirements? (43°C for dwellings, 32°C for other occupancies)	NO			Fail
	Are public rest rooms provided?	YES	Is the hot water outlet temperature limited such that it cannot exceed 43°C?	NO	Fail
service hot water system result				fail	

Figure(5.19): Hot water system result

5.4.1.4. Lighting

All lighting units are BEI units which are efficient devices with 3.6 watt . Then according to the equation mentioned in chapter 3, which expresses calculation of LPD(W/m²), all the power density for all spaces are calculated as shown in figure(5.2), Whereas the mall can be classified on nine different spaces in relevant to the function.

4. LIGHTING				
INTERIOR LIGHTING	Building / space Type	Target re	Design Value	P/F
	supermarket / sale area	12.6	1	Pass
	food preparation	13.6	1.4	Pass
	Dining space/ Bar	11.6	1.5	Pass
	Waiting	20.3	1.6	Pass
	Stair	5.8	1.7	Pass
	Dressing room	5.8	1	Pass
	Dining space/ Bar	12.6	0.8	Pass
	Storage			Pass
				Pass
				Pass
Lighting results				Pass

Figure(5.20): lighting result

5.4.2. Evaluation Indoor Environment Quality

5.4.2.1. IAQ

The measurements are taken in two days, but the input values are the average of these two values.

Table(5.17): Indoor pollutants results for ground floor level(GFL)

SM1 GFL			Co₂ (ppm)	Co (ppm)	PM_{<10} mg/m
Location1	1 st day	Morning	430	1.05	0.276
		Afternoon	510	1.3	0.299
	2 nd day	Morning	520	1.1	0.319
		Afternoon	640	1.4	0.325
Location2	1 st day	Morning	708	1.3	0.289
		Afternoon	815	1.4	0.311
	2 nd day	Morning	790	1.3	0.312
		Afternoon	990	1.41	0.310
Location3	1 st day	Morning	530	0.98	0.211
		Afternoon	680	1.1	0.280
	2 nd day	Morning	670	1.2	0.317
		Afternoon	900	1.3	0.316
Location4	1 st day	Morning	800	0.9	0.210
		Afternoon	910	1.0	0.222
	2 nd day	Morning	900	1.1	0.221
		Afternoon	1110	1.2	0.210
Location5	1 st day	Morning	980	0.9	0.198
		Afternoon	1200	1.0	0.154
	2 nd day	Morning	1100	1.1	0.218
		Afternoon	1300	1.1	0.228
Location6	1 st day	Morning	800	0.8	0.201
		Afternoon	800	0.9	0.212
	2 nd day	Morning	1120	0.9	0.225
		Afternoon	1300	1.0	0.234

mg/m is milligram / meter, and **ppm** is parts per million

Table(5.18): Indoor pollutants results

SM1 FFL			Co2 (ppm)	Co (ppm)	PM_{<10} mg/m³
Location1	1 st day	Morning	430	1.1	0.234
		Afternoon	730	1.2	0.319
	2 nd day	Morning	460	0.9	0.234
		Afternoon	820	1.2	0.341
Location2	1 st day	Morning	419	0.8	0.134
		Afternoon	650	1.3	0.345
	2 nd day	Morning	423	0.9	0.245
		Afternoon	730	1.1	0.351
Location3	1 st day	Morning	415	0.9	0.231
		Afternoon	820	1.1	0.331
	2 nd day	Morning	422	1.0	0.256
		Afternoon	730	1.1	0.350
Location4	1 st day	Morning	420	0.8	0.216
		Afternoon	689	1.1	0.345
	2 nd day	Morning	430	0.9	0.301
		Afternoon	780	1.1	0.333

Table(5.19): Indoor pollutants results

SM1 SFL			Co₂ (ppm)	Co (ppm)	PM_{<10} mg/m³
Location1	1 st day	Morning	530	0.9	0.220
		Afternoon	1390	1.2	0.321
	2 nd day	Morning	951	1.1	0.212
		Afternoon	1601	1.2	0.356
Location2	1 st day	Morning	730	1.1	0.298
		Afternoon	1430	1.2	0.323
	2 nd day	Morning	623	1.3	0.243
		Afternoon	1600	0.9	0.350
Location3	1 st day	Morning	891	1.2	0.287
		Afternoon	1502	1.1	0.293
	2 nd day	Morning	761	1.4	0.187
		Afternoon	1660	0.9	0.333
Location4	1 st day	Morning	520	1.1	0.389
		Afternoon	890	1.2	0.397
	2 nd day	Morning	670	1.3	0.356
		Afternoon	1000	1.2	0.333

The average of CO₂ level ranged from 430- 1660 ppm that exceeds the ASHRAE 700 ppm. The weekends(2nd day) levels were generally higher than the corresponding weekday(1st day) levels. This is probably due to higher occupancy density on weekend; moreover, the higher level in location 4,5,6 as this location has higher density, in addition it may be to refrigeration system. The variety of the results refer to poor air distribution,

and the CO₂ higher level in the second floor might be partially contributed to the sources of combustion in food court.

At the second floor of the building, the concentration of CO₂ differs by much smaller fraction in location 2, and 3. This is due to the large amount of air transferred from the dining zone to the kitchen. The restaurant has some of the highest peak CO₂ concentration, because of the highly occupied only a few hours of day, in contrast the other zones are more regularly occupied through the day.

The average of carbon monoxide CO ranged from 0.8- 1.4 ppm is of small level comparing to ASHRAE 9mm. it is obvious that the higher levels are close to entrance which is caused by direct transfer of vehicular emission from the partially parking area. Hence, vehicles exhaust is the only source of CO concentration in the space, and addition to the gas stove in the second floor, and the food process.

The concentration of PM_{<10} for all locations exceed ASHRAE limit 0.15mg/m³, and the highest concentration is measured at the peak meal time periods and in the nearest food tables to the preparing area.

1. Air Quality Inputs					
Samples taken from the tenanted floors identified in step 1			Results from sampling		CO ₂ indoor - CO ₂ outdoor
			CO ₂	PM ₁₀	
			ppm	mg/m ³	ppm
G.F.L	Sample 1	Morning	475	0.297	453
		Afternoon	575	0.312	553
	Sample 2	Morning	749	0.3005	727
		Afternoon	902	0.31	880
	Sample 3	Morning	600	0.264	578
		Afternoon	790	0.298	768
	Sample 4	Morning	850	0.216	828
		Afternoon	1010	0.215	988
	Sample 5	Morning	1040	0.208	1018
		Afternoon	1250	0.191	1228
	Sample 6	Morning	960	0.213	938
		Afternoon	1050	0.223	1028
F.F.L	Sample 1	Morning	445	0.234	423
		Afternoon	775	0.33	753
	Sample 2	Morning	421	0.189	399
		Afternoon	690	0.34	668
	Sample 3	Morning	418	0.23	396

	Sample 4	Afternoon	775	0.34	753
		Morning	425	0.258	403
		Afternoon	734	0.339	712
S.F.L	Sample 1	Morning	740	0.216	718
		Afternoon	1495	0.338	1473
	Sample 2	Morning	676	0.27	654
		Afternoon	1515	0.336	1493
	Sample 3	Morning	826	0.237	804
		Afternoon	1581	0.313	1559
	Sample 4	Morning	595	0.3725	573
		Afternoon	945	0.365	923

AIR QUALITY RESULTS	
Final result of the difference in the indoor & outdoor Carbon Dioxide levels measured	753ppm
Median of the Particulate Matter (PM₁₀) levels measured	0.284mg/m³
Median of the Carbon Monoxide levels measured	22ppm
RESULT	Fail

Figure(5.21): IAQ results by using calculator

5.4.2.2. Thermal comfort

The mall is mechanically ventilating, so the parameters for evaluation thermal comfort is temperature(CO), relative humidity(RH), and air speed. The following table shows the results from the instruments.

Table(5.20):Results of Smart sensor electronic anemometer and Digital multimeter mastech ms8209for (GFL)

SM ₁ GFL			Temperature (°C)	Relative Humidity (%)	Air Speed (m/s)
Location 1	1 st	Morning	28.2	61.0	0.0
	day	Afternoon	29.2	65.2	0.0
	2 nd	Morning	28	66.1	0.0
	day	Afternoon	29.4	65.0	0.0
Location 2	1 st	Morning	27.2	60.6	0.0
	day	Afternoon	28.7	60.1	0.0
	2 nd	Morning	28	61.5	0.0
	day	Afternoon	28.4	78.1	0.0
Location 3	1 st	Morning	29	61.0	0.0
	day	Afternoon	29.3	62.3	0.0
	2 nd	Morning	28.6	72.0	0.0
	day	Afternoon	29.5	75.0	0.0

Table(5.20):Results of Smart sensor electronic anemometer and Digital multimeter mastech ms8209for (GFL)

Location 4	1 st	Morning	29	72.1	0.0
	day	Afternoon	29.5	72.3	0.0
	2 nd	Morning	29.2	75.1	0.0
	day	Afternoon	29.8	76.1	0.0
Location 5	1 st	Morning	28	76.0	0.0
	day	Afternoon	29	72.1	0.0
	2 nd	Morning	29.1	72.1	0.0
	day	Afternoon	29.5	72.1	0.0
Location 6	1 st	Morning	28.9	72.0	0.0
	day	Afternoon	29	71.2	0.0
	2 nd	Morning	29.4	71.0	0.0
	day	Afternoon	29.1	78.1	0.0

Measurements taken at the following locations:		Temperature (°C)	Relative Humidity (%)	Air Speed (m/s)	
Enter No. of floors	Sample 1	Morning	28.1	63.5	0.0
		Afternoon	29.2	61.0	0.0
	Sample 2	Morning	28	66.2	0.0
		Afternoon	29.4	68.6	0.0
	Sample 3	Morning	27.2	73.6	0.0
		Afternoon	28.7	73.7	0.0
	Sample 4	Morning	28	74.0	0.0
		Afternoon	28.4	73.7	0.0
	Sample 5	Morning	28.6	74.0	0.0
		Afternoon	29.5	72.1	0.0
	Sample 6	Morning	29.1	71.0	0.0
		Afternoon	29.0	74.8	0.0
Does the internal temperature is limited?					yes
Enter the limited temperature					24
Final result of thermal comfort					Fail

Figure(5.22)Thermal comfort results for GFL by using calculator

Table(5.21): Results of Smart sensor electronic anemometer and Digital multimeter mastech ms8209for (FFL)

SM1 FFL			Temperature (°C)	Relative Humidity (%)	Air Speed (m/s)
Location1	1 st day	Morning	30.9	78	0.0
		Afternoon	31.8	79	0.0
	2 nd day	Morning	31.2	72	0.0
		Afternoon	32.3	81	0.0
Location2	1 st day	Morning	29.8	79	0.0
		Afternoon	31.2	82	0.0
	2 nd day	Morning	30.2	73	0.0
		Afternoon	32.1	79	0.0
Location3	1 st day	Morning	28.9	71	0.0
		Afternoon	31.1	81	0.0
	2 nd day	Morning	30.4	76	0.0
		Afternoon	32.1	80	0.0
Location4	1 st day	Morning	31.0	72	0.0
		Afternoon	31.4	85	0.0
	2 nd day	Morning	29.8	78	0.0
		Afternoon	32.0	80	0.0

Measurements taken at the following locations:			Temperature (°C)	Relative Humidity (%)	Air Speed (m/s)
Enter No. of floors	Sample 1	Morning	31.5	78	0.0
		Afternoon	32.0	79	0.0
	Sample 2	Morning	29.7	72	0.0
		Afternoon	31.6	81	0.0
	Sample 3	Morning	29.6	79	0.0
		Afternoon	31.6	82	0.0
	Sample 4	Morning	30.4	82.5	0.0
		Afternoon	31.7	78	0.0
Does the internal temperature is limited?					Yes
Enter the limited temperature					24
Final result of thermal comfort					Fail

Figure(5.23)Thermal comfort results for FFL by using calculator

Table (5.22): Results of Smart sensor electronic anemometer and Digital multimeter mastech ms8209for (SFL)

SM1 SFL			Temperature (°C)	Relative Humidity (%)	Air Speed (m/s)
Location1	1 st day	Morning	28	75.0	0.0
		Afternoon	30.6	77.4	0.0
	2 nd day	Morning	29	76.1	0.0
		Afternoon	30.1	77.9	0.0
Location2	1 st day	Morning	29.5	75.6	0.0
		Afternoon	30.2	78.2	0.0
	2 nd day	Morning	30	76.1	0.0
		Afternoon	31.1	78.3	0.0
Location3	1 st day	Morning	28.5	76.2	0.0
		Afternoon	29.2	78.2	0.0
	2 nd day	Morning	29.5	76.8	0.0
		Afternoon	31.1	78.6	0.0
Location4	1 st day	Morning	29.1	76.1	0.0
		Afternoon	30.3	77.9	0.0
	2 nd day	Morning	28.6	77.2	0.0
		Afternoon	31.1	77.9	0.0

The results shown in the previous table are the highest; most the ranges of temperature exceed the ASHRAE comfort limit. The level of temperature is higher in the location with high density. Relative humidity in most locations is under the exceed limit, that may be the results of non crowded area. Air speed cross all the space is 0.0m/s.

Measurements taken at the following locations:			Temperature (°C)	Relative Humidity (%)	Air Speed (m/s)
Enter No. of floors	Sample 1	Morning	28.5	75	0.0
		Afternoon	30.3	77.4	0.0
	Sample 2	Morning	29.7	75.8	0.0
		Afternoon	30.6	78.2	0.0
	Sample 3	Morning	29	79	0.0
		Afternoon	30.1	78.4	0.0
	Sample 4	Morning	28.8	76.6	0.0
		Afternoon	30.7	77.9	0.0
Does the internal temperature is limited?					Yes
Enter the limited temperature					24
Final result of thermal comfort					Fail

Figure(5.24): Thermal results for SFL by using calculator

5.4.2.3. Acoustic comfort

Table(5.23):Results Digital multimeter mastech ms8209for (GFL, FFL, SFL)

SM ₁ GFL			Sound level (db)	SM ₁ &SM ₂ FFL			Sound level (dB)
Location 1	1 st day	Morning	65.0	Location 1	1 st day	Morning	43.1
		Afternoon	66.1			Afternoon	44.1
	2 nd day	Morning	65.2		2 nd day	Morning	43.2
		Afternoon	67.2			Afternoon	47.1
Location 2	1 st day	Morning	65.6	Location 2	1 st day	Morning	44.1
		Afternoon	68.2			Afternoon	48.2
	2 nd day	Morning	66.1		2 nd day	Morning	43.7
		Afternoon	66.3			Afternoon	47.0
Location 3	1 st day	Morning	65.4	Location 3	1 st day	Morning	46.1
		Afternoon	67.5			Afternoon	44.2
	2 nd day	Morning	63.7		2 nd day	Morning	46.6
		Afternoon	67.6			Afternoon	46.1
SFL							
Location 4	1 st day	Morning	65.3	Location 1	1 st day	Morning	44.6
		Afternoon	68.3			Afternoon	55.2
	2 nd day	Morning	62.7		2 nd day	Morning	43.1
		Afternoon	67.2			Afternoon	54.0
Location 5	1 st day	Morning	65.4	Location 2	1 st day	Morning	44.4
		Afternoon	67.3			Afternoon	55.3
	2 nd day	Morning	60.8		2 nd day	Morning	42.6
		Afternoon	67.8			Afternoon	55.1
Location 6	1 st day	Morning	65.3	Location 3	1 st day	Morning	45.1
		Afternoon	67.1			Afternoon	57.9
	2 nd day	Morning	62.1		2 nd day	Morning	43.6
		Afternoon	67.4			Afternoon	55.0

The highest result for sound level in the ground floor is 65 (dB) that is because of the highest density in the floor and the direct relation to the street. At the first floor where there is non- food displaying, the highest sound level is 48.2(dB). This level is acceptable because most of this floor has absorbable materials like clothes, wood, and leather. Otherwise, first floor materials not absorbable .In the second floor level the highest sound level is 55.2(dB).

2. Acoustic Comfort Inputs

Samples (dB) taken from the tenanted floors identified in step 1	Results from ambient sound readings (dB)					
	Sample 01	Sample 02	Sample 03	Sample 04	Sample 05	Sample 06
Enter floor name, number here	67	66.5	65.4	66	65.8	65.4
Enter floor name, number here	44.3	44.3	45.7	45.7	45.5	45.5
Enter floor name, number here	49.2	49.2	49.3	49.3	50.4	50.4
ACOUSTIC COMFORT RESULTS						
Total Average Ambient Sound in the Tenanted Office Space (dB):						49
FINAL RESULT FOR ACOUSTIC COMFORT						Pass

Figure(5.25): Acoustic comfort result by using calculator

The total result for building acoustic is acceptable in accordance to calculator shown in figure (5.22). This result is achieved because the building has small parentage of opening areas. The other reason is because of the furniture way of the spaces that it depend on more display areas with more products, and no empty spaces.

5.4.2.4. Visual comfort

Measuring locations were classified according to their function, then no value of luminance has passed. All measured values were less than the minimum standard. This results can be as a results of small numbers of lighting units that are used in all building. Moreover, the measured values at Ground floor are higher than first and second floors that because of the brighten color used in Ground floor, and the dark in both first and second.

Table(5.24): Measuring the Luminance for three floor of building

SM ₁ GFL	luminance (LUX)	SM ₁ &SM ₂ FFL	luminance (LUX)
Location 1	107	Location 1	70
Location 2	120	Location 2	78
Location 3	130	Location 3	67
		SFL	
Location 4	107	Location 1	81
Location 5	120	Location 2	83
Location 6	123	Location 3	82

Area	Illumination level(Lux)	Achieved value	Pass/ Fail
Internal corridors	200	107	FAIL
Elevator services	200	107	FAIL
Dining area	150-200	83	FAIL
Entrance	500	120	FAIL
Selling and displaying area	750	123	FAIL
Final results			Fail

Figure(5.26):Visual comfort result by using calculator

The visual comfort is also affected by the color of paints that the designer used. The designer used dark wooden furniture, despite not using more light elements. This is obvious especially in the first floor and the second. More over at the first floor designer did not consider the Exhibited shows, that in almost have dark color.

Conclusion and recommendations

The purpose of this thesis was to enhance a necessary step to sustain the interior design in the Gaza Strip. Accordingly, investigating the situation of interior design practice among designers, authorities, and projects was conducted for it enables us to determine the environmental sustainable perception, attitude, barriers, and motivation among the interior design profession. To fulfill this purpose, this study is based upon mixed methods including what has been implemented in four parallel stages, interviewing specialists, surveying firms, and measuring for building, improving calculators. This chapter present the conclusion of the study through reflection on the research objectives, questions, and hypotheses, and then discuss the findings of the study, strategies and recommendations.

6.1. Reflections on the objectives and research questions

This study has asked four questions that support the objectives of the study, and serve the hypotheses. This section presents the ways does the researcher use to answer the questions.

The first question A has enhanced the first objective, and has asked for the international-base of environmental sustainability of the interior design. whereas, chapter 2 has briefly provided the necessary information including the concept of sustainable interior design, common environmental tools for assessing the interior projects, and the environmental aspects of sustainable interior design.

The second question B asked about the appropriate environmental standards for commercial interior projects at Gaza. The details for proposed calculators in chapter 4 for energy efficiency and indoor environment quality IEQ, is answered this question. Whereas, Gaza strip has no written environmental specification except Guidelines for Energy Efficient Building Design. Therefore, programming calculators depend on ASHRAE standards, NABERS, SKA- rating, and pearl system. Using these tools can be satisfied, for all these tools have similar standards for energy consumption and IEQ for the commercial buildings. Moreover, discussion indoor standards is more manageable that outdoor; hence, outdoor criteria have different variables including surrounding environment elements.

The third question C asked for level of awareness about sustainable practices amongst organizations, designers, and commercial projects. The enhance objective C that requires Investigating environmental inceptions, attitudes and behaviors amongst designers, and assesses the environmental behavior needed for commercial projects by adopting sustainable evaluated tools. In order to provide the answer of this question, the researcher pursue three stages which are:

- Interviewing the specialist amongst the interested organization.
- Investigating interior design' firms along Gaza strip.
- Assessing El Andalusia mall, as preventative for commercial buildings in Gaza.

The forth question asked about the values and incentives that has realized the objective D to lay the template for orienting the concerns of Gaza interior designers, firms, clients, and organizations toward adopting sustainable practices in their interior projects. In order to answer this question, the researcher suggest developing a full manual to provide a complete set of environmental standards for commercial interior design. Accordingly, the interior design will subject to this manual.

6.2. Reflection on the hypotheses

The study has one hypotheses mentioned in section 1.7 that made about different interior design profession variables. The researcher test the hypotheses by investigating and evaluating all the aspects of this profession authorities, firms, designers, projects. The collected information about four stages for the study mentioned in figure (3.2) is the answer for this question.

6.3. Findings and conclusions

This study provides different findings what the researcher is intended to classify them in two categories general findings and what are related to interior design profession at Gaza. In order to emphases on Gaza situation.

6.3.1. General Findings

- Interior design is no less important than exterior design; therefore, it must have more concern for authorities, designers, students.
- Optimum design of interior according to the environmental standards have not only positive influence for environmental design, but also for other aspects like economic, social, and ethical.
- Environmentally sustainable interior design can be defined by physical feature of environment such as lighting, color, temperature, air quality, and noise.
- Environmentally sustainable interior design standards have the same aspects among the different international schemes that include using materials, energy consuming, water, indoor environment quality, and waste managing.
- In the Gaza Strip, this is the best opportunity to start with improving evaluating system for interior design projects. This system will be available at engineering

association or at accessory office where any commercial project should be evaluated if it is acceptable to construction or not. Hence interior design profession in Gaza.

- There is no legislation both in terms of general laws and environmental laws that let practice this profession; such laws are not available for all amateur, students, and specialists in the same way.
- There are no studies in the Gaza that discuss environment interior design. Moreover, there is no interior program among universities.

6.3.2. Findings related to interior design profession at Gaza

- There is no specific environmental legislation for the buildings, and no written specifications for interior design projects, the result of free interior design projects were without any restrictions.
- All testing executed to materials in the Gaza Strip are related to the physical properties, and there no testing for environmental impacts of these materials. In addition to the absence of specification for imported materials, so some of products have no tests and permitting license for importing.
- In Gaza, designers denoted their readiness to apply sustainability in design of interior projects, and they have apposite attitude toward sustainable practicing. On other hand, they do not implement sustainability in their designs.
- According to the survey results and calculators evaluating, there is no adequate awareness toward environment among the firms what reflect a negative behavior for indoor spaces. This critical shortages of qualified interior designers to sustain their projects.
- No specifying between decoration designer and interior designers roles that increase the numbers of stockholders and decrease numbers of aware about environment.
- Investigating post occupancy buildings guide to comprehensive plans, and applications for buildings in Gaza, and then it can formulate guideline for more environmental buildings.
- Despite the high cost spending for air conditioning, the indoor spaces do not achieved the comfort conditions that affirm no deeply studying for mechanical conditioners.
- Depending on mechanical ventilation, not natural, causes high running cost for the projects that it present the most percentage for the whole buildings.
- Deepening on artificial lighting make designers to decrease the number of united desired for more visual comfort.
- No use of simulations programs by designers for interior design practicing whether for lighting, acoustic, energy, and IAQ.

- Applying sustainability in design of interior is has no complex challenges, that enables developing recommendations and strategies.

This findings required that there should be accurate and comprehensive strategies among all stockholders. These strategies can be summarized in relevance to responsible authorities.

6.4. Preferred vision statement for the study

Study vision is that all interior design stockholders specialists, designers, students, clients, and craftsmen mutually invest resources of time, money, studies, and plans to sustain interior design by good managing.

6.5. Strategies and Recommendations

Five strategies guided and shape thesis recommendations, these are summarized as:

6.5.1. Strategy (1): developing plans for designers to learn about the lack of environmental interior design practitioners.

This strategy can be realized by the following recommendations:

- **Increasing perception and knowledge** is an initial and important step toward sustainable design. It can be achieved by training how to affirm how to do both of applying environmental aspects and convincing clients for demanding more sustainable designs.
- **Encouraging clients.** Many firms show that they are ready to adopt sustainable practicing in their designs, they must put plans to start applying that. This plans including Awareness campaigns, and providing samples and models.
- **Using simulation software programs** is an effective tools for offering any information needed to make the best choice for client's specific needs and best environmental goals.
- **Joining a communication meeting** that address various level of interests and actions. These communication should be in visual and verbal venues by online, presentations, and dialogues, and it will redirect and concrete the designers with the international and local issues.
- **Committing the environmental legislations** through all design decisions functional design, materials choosing, appliance choosing, spaces requirements. Moreover, calculating the environmental impacts for every projects including percentage of CO², the emitted pollutants from the spaces, energy water consuming, and put plans for managing the demolition and construction wastes.

6.5.2. Strategy (2): Redirect the Authorities behaviors and practicing that are related to interior design profession toward sustainability; hence, Government has a vital role to develop for more real life among sustainable interior design for both designers and clients.

This will be achieved through the following strategies.

- **Adopting environmental standards** to create a responsible concern about environment. This specifications should limited and then supervise the applications of these specification in all project stages.
- **Enhancing competition through firms;** that can be achieved by environmental activities and motivations to go beyond more legal compliance so that it can promote more ecological sustainable practices.
- **Regarding environmental and Eco- labels** emerged as one of the main instruments of market communication that can help authorities to actuate this when importing appliances, and other related products. Moreover, eco- labels is away to inform consumers about environmental impacts of products.
- **Realizing reliable and effective cooperation with non- government organization** is necessary and seriously needed to address sustainability as series issues. It can be done; for example, decreasing fees and taxes for any environmental products.
- **Activating the Regulatory aspects that explicitly embedding in laws** for more govern practicing among architects, interior designers, researchers, and academics to install sustainability in all behaviors.
- **Improving a comprehensive system to evaluate interior projects** including specifications for windows percentage, materials, appliance. These specifications should offer in easy form such Excel file, so that designers can easily fulfill it in parallel with all design steps.
- **Starting steps is to enforce all commercial buildings to apply a license before constructing.** It includes minimum environmental standards that can accept or not the projects among orientations, materials, energy and water consumptions, plans for waste, Indoor environmental quality. Hence, commercial buildings have abilities for promoting sustainability, and it can easily forced to laws.
- **Limiting the monthly usage of electricity and water for different types of commercial buildings** that encourage designers to restrict with these values.

- **Activating and improving the Palestinian energy code** to improve the energy behavior for buildings.
- **Electricity company should put motivations for every commercial buildings that have a plan of reducing energy usage by 30%**, this will encourage more concern with environmental issues.

6.5.3. Strategy (3): Develop new environmental studies and researches that discuss deeply all sustainable aspects

The scope of this research is small piece of a large puzzle, so future studies can take longitudinal perspective for example

- Research should focus on materials specifications, and illustrate the environmental impacts that enable better sustainable design choices.
- Studying the other aspects of sustainability in interior design social and economic, and then apply an important forth aspect related to sustain Arabic culture.
- Offering studies that affirmed that more environmental design is more economic and social one, then it can be published to convinced all stockholders for applying and adopting sustainable practicing.
- Investigated studies for clients attitudes, barriers, and motivations that will provide more strategies related to clients desires.
- Offering studies that are related to how recycled and renewable materials can avoided emission of chemical or microbial contaminate for example, material for furniture, floor finishes, wall finishes, and ceiling.

6.5.4. Strategy (4):Promote sustainable design by developing ways for both architectural and interior design programs curriculum to reach students with more consciousness about environmental impacts for their designs

This strategy can be realized by the following recommendations, Since curriculum has the guiding role in creation of responsible designers, and students; hence, the education should be redirect to development of ethical designers, one who could think and recall ” *design out design that delivers environmental problem* ” (Fry, 1993).

- As there is no specialized interior design programs among universities, so each interior design program should identify diverse specialists of interior design academics that lit program environmental needs.
- Develop and disseminate information about environmental methods by which interior design students can contribute to protect their environment.

- Organize training programs, seminar, conference, training course to increase awareness among students and academic on issues of sustainable interior design.
- Proposed competition for designing building with environmental concepts. For example, buildings with low energy, with optimum indoor quality, or buildings with recycled materials.

6.5.5. Strategy (5): Encourage investors and clients to demand environmental designs and products that will support designer's attitudes and behaviors.

- Organizing guiding meetings, lectures, for both investors who are looking forward to establishing big projects, and the importers who can improve the level of materials and appliances using in buildings.
- There should be provision of facilities for environmental projects, and eco products so that there will be increasing demands for these trends.
- Investors should be encouraged to take into consideration the environment influence of building through its whole plans that is through the initial process, or the final one.

References

2007. Chapter 9 - Special HVAC Systems. *Air Conditioning System Design Manual (Second Edition)*. Burlington: Butterworth-Heinemann.
- 24,May 2012. Type to A, H.
- (ASID), A. S. O. I. D. 2007. selling green *In: TRISTAN ROBERTS AND ALLYSON WENDT, B., INC. (ed.) Interior design and global impact 2007*. Washington, American 608 Massachusetts Ave., NE.
- (ECA), G. S. E.-S. E. C. A. 2011. High efficiency lighting units. 11. Available: <http://etl.decc.gov.uk/etl>.
- (IPCC) 2007. Climate Change 2007: Working Group III: Mitigation of Climate Change. *In: EBERHARD JOCHEM (GERMANY), H. X. P. C. (ed.) Residential and commercial[1] buildings*. The Intergovernmental Panel on Climate Change (IPCC).
- (NABERS), B. E. R. S. 2010. NABERS Energy and Water for Shopping Centres. 1.2. Australia.
- ALAHMAD, M., NADER, W., CHO, Y., SHI, J. & NEAL, J. 2011. Integrating physical and virtual environments to conserve energy in buildings. *Energy and Buildings*, 43, 3710-3717.
- AMERICA, Y. A. 2009. *Product: Luminance Light Shelf System* [Online]. Available: <http://archrecord.construction.com/products/productreports/2009/openings/6.asp>.
- ASTM, T. A. S. F. T. A. M. 2012. *standards* [Online]. international standards worldwide. Available: <http://www.astm.org/Standard/index.shtml> [Accessed 2, jone 2012].
- ATTIA, S., GRATIA, E., DE HERDE, A. & HENSEN, J. L. M. 2012. Simulation-based decision support tool for early stages of zero-energy building design. *Energy and Buildings*, 49, 2-15.
- AWABI 2003. *ventilation of buildings*, USA, London, France, Spon press.
- BACON, L. 2011. *Interior Designer's Attitudes Toward Sustainable Interior Design Practices and Barriers Encountered when Using Sustainable Interior Design Practices*. Master of Science, University of Nebraska.
- BALTA, M. T., DINCER, I. & HEPBASLI, A. 2010. Performance and sustainability assessment of energy options for building HVAC applications. *Energy and Buildings*, 42, 1320-1328.
- BEJAN, A. 1982. Second-Law Analysis in Heat Transfer and Thermal Design. *In: JAMES, P. H. & THOMAS, F. I. (eds.) Advances in Heat Transfer*. Elsevier.
- BERNARDO, J. M. 2005. Reference Analysis. *In: DEY, D. K. & RAO, C. R. (eds.) Handbook of Statistics*. Elsevier.
- BIM, S., SKANSKA, NOIS AND CIVITAS 2009. Greenhouse gas calculations using BIM. *In: SKANSKA NORGE AS, S. (ed.)*. Norway.
- BOUBEKRI, M. 2008. Chapter 6 - Daylighting strategies. *Daylighting, Architecture and Health*. Oxford: Architectural Press.
- CAIN, S. C. 2007. *Sustainability for interior design : Rating the flooring materials in a LEED registered hotel using the BEES evaluative software for sustainable products* Master, University of Florida.

- CECCHINATO, L., CORRADI, M. & MINETTO, S. 2010. Energy performance of supermarket refrigeration and air conditioning integrated systems. *Applied Thermal Engineering*, 30, 1946-1958.
- CIWMB, D. A. 2010. Sustainable Materials. In: TRAINING, C. S. D. (ed.). California Sustainable Design Training.
- CLARKE, J. A. 2001. 6 - HVAC, renewable energy conversion and control systems. *Energy Simulation in Building Design (Second Edition)*. Oxford: Butterworth-Heinemann.
- COMMITMENT, A. A. C. U. P. C. 2007. Implementation Guide In: ACUPCC (ed.).
- CRESWELL, J. W. 1999. Chapter 18 - Mixed-Method Research: Introduction and Application. In: GREGORY, J. C. (ed.) *Handbook of Educational Policy*. San Diego: Academic Press.
- D. LOE April, 2003. Energy efficiency in lighting – an overview. Society of Light and Lighting.
- DECC:DEPARTMENT OF ENERGY AND CLIMATE CHANGE, T. D., FOR BUSINESS, E. A. R. R. B., THE SCOTTISH GOVERNMENT, THE WELSH ASSEMBLY & IRELAND., G. A. I. N. 2009. Lighting A guide to equipment eligible for Enhanced Capital Allowances. *Technology information leaflet ECA763*.
- DELLA CROCIATA, S., SIMONE, A. & MARTELOTTA, F. Acoustic comfort evaluation for hypermarket workers. *Building and Environment*.
- DELLA S., M. F., SIMON F. 2012. *A measurement procedure to assess indoor environment quality for hypermarket workers*.
- DEUBLE, M. P. & DE DEAR, R. J. 2012. Green occupants for green buildings: The missing link? *Building and Environment*, 56, 21-27.
- DING, G. K. C. 2008. Sustainable construction—The role of environmental assessment tools. *Journal of Environmental Management*, 86, 451-464.
- DUBOIS, M.-C. & BLOMSTERBERG, Å. 2011. Energy saving potential and strategies for electric lighting in future North European, low energy office buildings: A literature review. *Energy and Buildings*, 43, 2572-2582.
- ENERGY, U. D. O. 2012. Energy efficiency and renewable energy. Available: http://www.energysavers.gov/your_home/lighting_daylighting/index.cfm/mytopic=12050 [Accessed 16/04/2012].
- ESD 2007. ESD design guide - office and public buildings In: 3 (ed.). Australian.
- ESTIDAMA, P. C. O. may, 2009. ThePearlsDesignSystem. In: COUNCIL, T. A. D. U. P. (ed.).
- FASIUDDIN, M. & BUDAIWI, I. 2011. HVAC system strategies for energy conservation in commercial buildings in Saudi Arabia. *Energy and Buildings*, 43, 3457-3466.
- FESS, E. E. 1995. Determining Sample Size. *Journal of Hand Therapy*, 8, 264.
- G.MAHALINGAM, G. K. A. 2011. Designing energy efficient commercial buildings—A systems framework. *Energy and Building*
- GE, Y. T. & TASSOU, S. A. 2011. Performance evaluation and optimal design of supermarket refrigeration systems with supermarket model “SuperSim”, Part I: Model description and validation. *International Journal of Refrigeration*, 34, 527-539.

- GEI, G. E. I. 2012. *Certification Programs* [Online]. Atlanta: GEI. Available: http://www.greenguard.org/en/manufacturers/multi_meter_mastech/digital_multimeter_mastech_ms8209.php [Accessed 2 June 2012].
- GSM.1998. Available: http://gsmserver.com/shop/equipment/measuring_equipment/multi_meter_mastech/digital_multimeter_mastech_ms8209.php [Accessed 5 May, 2012].
- HORTON, J., MACVE, R. & STRUYVEN, G. 2004. Chapter 20 - Qualitative Research: Experiences in Using Semi-Structured Interviews. In: CHRISTOPHER, H. & BILL, L. (eds.) *The Real Life Guide to Accounting Research*. Oxford: Elsevier.
- IEA, I. E. A. 2006. control strategies for hybrid ventilation in new and retrofitted office and education building In: JAGPAL, R. (ed.) *technical synthesis report* Australia, Belgium, Canada, Denmark, Finland, Germany USA.
- INDUSTRY, N. 2005. Significant reduction in greenhouse gas emissions.
- INTERVIEWINGENG.ELESAWI, E. 2012.
- JABER, S. & AJIB, S. 2011. Optimum, technical and energy efficiency design of residential building in Mediterranean region. *Energy and Buildings*, 43, 1829-1834.
- JABER, S. & AJIB, S. 2012. Novel cooling unit using PCM for residential application. *International Journal of Refrigeration*, 35, 1292-1303.
- JENKINS, D. & NEWBOROUGH, M. 2007. An approach for estimating the carbon emissions associated with office lighting with a daylight contribution. *Applied Energy*, 84, 608-622.
- JRC, W. 2011. Methods for monitoring indoor air quality in schools. In: ORGANIZATION, W. H. (ed.) *national and international indoor air pollution surveys*. Bonn, Germany.
- KIM, J. T. & KIM, G. 2010. Overview and new developments in optical daylighting systems for building a healthy indoor environment. *Building and Environment*, 45, 256-269.
- KOLOKOTSA, D., SANTAMOURIS, M., SYNNEFA, A. & KARLESSI, T. 2012. 3.19 - Passive Solar Architecture. In: EDITOR-IN-CHIEF: ALI, S. (ed.) *Comprehensive Renewable Energy*. Oxford: Elsevier.
- KRAMER, K.-L. 2012. Chapter 1 - Sustainability, User Experience, and Design. *User Experience in the Age of Sustainability*. Boston: Morgan Kaufmann.
- KUBBA, S. 2010a. Chapter 4 - LEED™ Professional Accreditation, Standards, and Codes. *LEED Practices, Certification, and Accreditation Handbook*. Boston: Butterworth-Heinemann.
- KUBBA, S. 2010b. Chapter 5 - Design Strategies and the Green Design Process. *LEED Practices, Certification, and Accreditation Handbook*. Boston: Butterworth-Heinemann.
- KUBBA, S. 2010c. Chapter 7 - Indoor Environmental Quality. *LEED Practices, Certification, and Accreditation Handbook*. Boston: Butterworth-Heinemann.
- KUBBA, S. 2010d. Indoor Environmental Quality. *LEED Practices, Certification, and Accreditation Handbook*.
- L. CECCHINATO, M. C., S. MINETTO 2012. Energy performance of supermarket refrigeration and air conditioning integrated systems working with natural refrigerants. *Applied Thermal Engineering*.

- LAOUADI, A., ATIF, M. R. & GALASIU, A. 2003. Methodology towards developing skylight design tools for thermal and energy performance of atriums in cold climates. *Building and Environment*, 38, 117-127.
- LAOUADI, A. & COFFEY, B. 2012. The energy performance of the Central Sunlighting System. *Journal of Building Performance Simulation*, 5, 234-247.
- LEE .D, Z., LEE.S, KIM. C, AND KIM.S. 2010. Optimum Energy Use to Satisfy Indoor Air Quality Needs in Korea.
- LEED 2009. LEED - a new challenge for low VOC emitting materials. . *Healthy Buildings Conference 2009*
- LEISEROWITZ, A, A., KATES, PARRIS, R. & THOMAS, A. 2006. Sustainability values, attitudes and behaviours: A review of multinational and global trend. . *Annual review of environment and resources* 31, 413 - 444.
- LI, D. H. W., CHEUNG, K. L., WONG, S. L. & LAM, T. N. T. 2010. An analysis of energy-efficient light fittings and lighting controls. *Applied Energy*, 87, 558-567.
- LINHART, F. & SCARTEZZINI, J.-L. 2010. Minimizing lighting power density in office rooms equipped with Anidolic Daylighting Systems. *Solar Energy*, 84, 587-595.
- LOCKWOOD, C. 2006. building thr Green Way *harvard business review*. Watertown, Massachusetts.: Harvard Business Publishing.
- LOFTNESS, V., HAKKINEN, B., ADAN, O. & NEVALAINEN, A. 2007. Elements that contribute to healthy building design. *Environ Health Perspect*, 115, 965-70.
- LYNES, J. K. & ANDRACHUK, M. 2008. Motivations for corporate social and environmental responsibility: A case study of Scandinavian Airlines. *Journal of International Management*, 14, 377-390.
- M.KANG & A.GUERIN 2009. The State of Environmentally Sustainable Interior Design Practice. *American Journal of Environmental Sciences* 5, 179-186.
- MCAA 2007. LEED for New Construction Rating System :Water Efficiency Credit In: ASSOCIATION, M. C. (ed.). Amercia: MCAA.
- MCVILLY, K. R., STANCLIFFE, R. J., PARMENTER, T. R. & BURTON-SMITH, R. M. 2008. Remaining Open to Quantitative, Qualitative, and Mixed-Method Designs: An Unscientific Compromise, or Good Research Practice? In: LARAINÉ MASTERS, G. (ed.) *International Review of Research in Mental Retardation*. Academic Press.
- MHASKAR, Z. 2006. Eco-Friendly Building Materials. Eco-housing partnership
- MILLS, E. & PIETTE, M. A. 1993. Advanced energy-efficient lighting systems: Progress and potential. *Energy*, 18, 75-97.
- MONTGOMERY. 2009. Life cycle assessment tools. Available: http://www.architectureweek.com/2003/0716/environment_1-1.html [Accessed 1 February, 2012].
- MOXON, S. 2012. *sustainability in interior design*, London Laurence King Publishing.
- OCHOA, C. E., ARIES, M. B. C., VAN LOENEN, E. J. & HENSEN, J. L. M. 2012. Considerations on design optimization criteria for windows providing low energy consumption and high visual comfort. *Applied Energy*, 95, 238-245.
- OMER, A. 2008. Energy, environment and sustainable development *Renewable and Sustainable Energy* 12, 2265-2300.

- OROSA, J. A. & OLIVEIRA, A. C. 2012. Thermal Comfort and Indoor Air Quality. 1-13.
- OSC. 2009. *90 Days Later and Beyond* [Online]. Available: <http://oregonsustainabilitycenter.wordpress.com/2009/06/22/osc-research-90-days-later-and-beyond/>.
- OSHA 2011. Indoor Air Quality in Commercial and Institutional Buildings. U.S: department of labor
- PÉREZ-LOMBARD, L., ORTIZ, J., CORONEL, J. F. & MAESTRE, I. R. 2011. A review of HVAC systems requirements in building energy regulations. *Energy and Buildings*, 43, 255-268.
- PÉREZ-LOMBARD, L., ORTIZ, J., MAESTRE, I. R. & CORONEL, J. F. 2012. Constructing HVAC energy efficiency indicators. *Energy and Buildings*, 47, 619-629.
- PILATOWICZ, G. 1995. *Eco-interiors: A guide to environmentally conscious interior design*, New York: Wiley.
- PREPARATORYCOMMITTEEFOR EFFICIENTBUILDING 2004. Guidelines for Energy Efficient Building Design *In: COMPANY, B. (ed.)*. palestine.
- PRESTON, V. 2009. Questionnaire Survey. *In: EDITORS-IN-CHIEF: ROB, K. & NIGEL, T. (eds.) International Encyclopedia of Human Geography*. Oxford: Elsevier.
- RADI, M. 3,may 2012. Type to RADI, E. M.
- RAJKOVICH, N. B., MILLER, W. C. & LARUE, A. M. 2011. Chapter 17 - Zeroing in on Zero Net Energy. *In: FERREDOON PERRY, S. (ed.) Energy, Sustainability and the Environment*. Boston: Butterworth-Heinemann.
- RAMI, R. 2011. commercail Mall and economic development *palestine*
- RICS 2012. Ska rating Good practice measures for retail.
- ROAF, S. 2009. environmental studies: Idoor Air Quality. *In: UNIVERSITY, H.-W. (ed.) Heriot-Watt University*. Heriot-Watt University.
- ROCK, B. A. 2006. 3 - Indoor environmental quality. *Ventilation for Environmental Tobacco Smoke*. Burlington: Butterworth-Heinemann.
- RS, W., BENG, MSC, CENG, FCIBSE, MSL 2009. Lighting & Architecture Heriot-Watt University: School of the Built Environment.
- RYCKAERT, W. R., LOOTENS, C., GELDOF, J. & HANSELAER, P. 2010. Criteria for energy efficient lighting in buildings. *Energy and Buildings*, 42, 341-347.
- S.BROWN 2008. High Quality Indoor Environments for Sustainable Office Buildings. *Construction Innovation*. Cooperative Research Centre (CRC).
- SANDER, A. M., FUCHS, K. L., HIGH JR, W. M., HALL, K. M., KREUTZER, J. S. & ROSENTHAL, M. 1999. The community integration questionnaire revisited: An assessment of factor structure and validity. *Archives of Physical Medicine and Rehabilitation*, 80, 1303-1308.
- SHI, L. & CHEW, M. Y. L. 2012. A review on sustainable design of renewable energy systems. *Renewable and Sustainable Energy Reviews*, 16, 192-207.
- SIMONS, R. H. & BEAN, A. R. 2001. 8 - Interior lighting. *Lighting Engineering*. Oxford: Architectural Press.
- SMITH, A. M. 2012. Research Methodology: A Step-by-step Guide for Beginners. *Nurse Education in Practice*, 12, e25.

- STUDIO, A. D. A. April, 2012. **Types of Architecture Lighting in the Philippines.**
Available: <http://archiandesigns.wordpress.com/2011/06/17/types-of-architecture-lighting-in-the-philippines/>.
- SU, Y., YU, X., ZHANG, L., KARAGIANNI, M. & KHAN, N. 2012. Energy saving potential of Monodraught™ sunpipes installed in a supermarket. *Energy Procedia*, 14, 578-583.
- TRUST, T. C. December, 2011. Lighting: Bright ideas for efficient illumination
- VA, D. O. V. A., LLOYD SIEGEL, F., KURT KNIGHT, P. E. & RENEE TIETJEN, A., RA, LEED - A 2007. sustainable design and energy reduction manual.
- YANG, L. & ZHANG, C.-L. 2010. Analysis on energy saving potential of integrated supermarket HVAC and refrigeration systems using multiple subcoolers. *Energy and Buildings*, 42, 251-258.
- YILDIRIM, K., AKALIN-BASKAYA, A. & CELEBI, M. 2007. The effects of window proximity, partition height, and gender on perceptions of open-plan offices. *Journal of Environmental Psychology*, 27, 154-165.

Appendix A: Questionnaire in Arabic language

بِسْمِ اللَّهِ الرَّحْمَنِ الرَّحِيمِ



الجامعة الإسلامية _ غزة
كلية الدراسات العليا _ قسم الهندسة المعمارية

نموذج استبيان خاص برسالة الماجستير

TOWARDS A SUSTAINABLE INTERIOR **DESIGN WITHIN THE COMMERCIAL BUILDINGS IN GAZA:** **FRAMEWORK OF ENVIRONMENTAL ASSESSMENT INDEX**

نحو تصميم داخلي مستدام
للمباني التجارية في قطاع غزة:
ضمن إطار التقييم البيئي

إعداد:

م.إيمان أحمد الشيخ خليل

إشراف:

د. رائد العطل

د. عمر عصفور

خطاب تمهيدي

نرجو من حضرتكم تعبئة هذا الاستبيان

مساهمتمكم ضرورية ومهمة

يهدف هذا البحث لتقييم المستوى البيئي المستدام لمشاريع التصميم الداخلي على كافة المستويات :

□ قياس درجة وعي ومعرفة المصممين للمفاهيم البيئية، وهذا ما تناقشه محاور الاستبيان

□ الوقوف على مدى توجيه القانون لإيجاد مشاريع ذات جودة بيئية عالية.

□ التقييم البيئي لعينة من المشاريع التجارية.

□ قياس الاجراءات المتبعة والخطط البيئية المستقبلية لكافة المعنيين .

يجرى التقييم في هذا الاستبيان من خلال أربع مجموعات، (المجموعة الأولى) قياس مستوى المعرفة بالمعايير البيئية للتصميم الداخلي المستدام، (المجموعة الثانية) قياس مواقف المصممين من تطبيق مفهوم التصميم الداخلي المستدام، (المجموعة الثالثة) يتم من خلالها قياس نسبة الممارسات البيئية التي يتبعها المصممون ، (المجموعة الرابعة) التعرف على أهم الحوافز والعوائق أمام تطبيق الاستدامة على مستوى التصميم الداخلي في قطاع غزة.

تم اختياركم لتعبئة نموذج الاستبيان كونكم أحد أهم المشاركين في هذا المجال.

شكركم لمساهمتمكم

م. إيمان أحمد الشيخ خليل

(QA) المجموعة الأولى: قياس مستوى المعرفة بمفهوم التصميم البيئي المستدام

A₁. من وجهة نظركم .. كيف يكون الفراغ الداخلي فراغا مستداما بيئيا.

A₂. من وجهة نظركم، أيا من القضايا التالية تؤثر في حال غيابها على جودة الفراغات الداخلية في التصميم.

- a. الاهتمام بجودة مواد البناء b. الاستخدام الأمثل للطاقة c. استخدام أساليب ترشيد المياه
d. المستوى الأمثل للراحة الصوتية e. نسبة الإضاءة والتهوية الطبيعية المرضية. f. مستوى الراحة الحرارية

A₃. ما مدي اقتناعكم بالقضايا التالية:

غير موافق	موافق	موافق
		a. الاستدامة تهتم بالجانب البيئي نفس اهتمامها بالجانب الاجتماعي والاقتصادي
		b. ممارسة الاستدامة في التصميم الداخلي يعزز في المجتمع جوانب اخلاقية اتجاه البيئة.
		c. الاستدامة على مستوى التصميم البيئي قادرة على التقليل من أثر التغييرات السلبية على البيئة.
		d. التصميم الداخلي المستدام يخفض مستوى استهلاك الطاقة من الوقود والكهرباء.
		e. يمكن للمصممين من خلال مفهوم التصميم الداخلي المستدام أن يحل مشكلة تلوث الهواء للفراغات الداخلية.
		f. يمكن للمصممين من خلال مفهوم التصميم الداخلي المستدام الترشيد من استهلاك المياه
		g. يمكن للمصممين من خلال مفهوم التصميم الداخلي المستدام تقليل الفاقد من مواد البناء .
		h. يمكن للمصممين من خلال مفهوم التصميم الداخلي المستدام الارتقاء بمستوى صحة المستخدمين.
		i. يمكن للمصممين من خلال مفهوم التصميم الداخلي المستدام الارتقاء بمستوى أداء المستخدمين.
		j. العلاقات الوظيفية للنشاطات الداخلية تؤثر على المستوى البيئي للمشروع.
		k. اختيار الألوان في الفراغ الداخلي له بعد بيئي.

A₄. أيا من الطرق التالية لقياس الاداء البيئي للفراغ الداخلي انت على معرفة بها.

<input type="checkbox"/>	a. DQI(design quality indicator)
<input type="checkbox"/>	b. EMGB(Evaluation manual for green buildings)
<input type="checkbox"/>	c. EPGB(Environmental performance Guide for building)
<input type="checkbox"/>	d. GBTool(Green building challenge)
<input type="checkbox"/>	e. GHEM(Green home evaluation manual)
<input type="checkbox"/>	f. Leed(leadership in energy and environmental design)
<input type="checkbox"/>	g. BABERS(National Australian building environmental rating system)
<input type="checkbox"/>	h. SBAT(Sustainable building assessment tool)
<input type="checkbox"/>	i. SPeAR(sustainable project appraisal routine)
<input type="checkbox"/>	j. لا شيء مما سبق

(Q_B) المجموعة الثانية: قياس الموقف اتجاه مفهوم التصميم الداخلي المستدام

غير موافق بشدة	غير موافق	محايد	موافق	موافق بشدة
				a. التصميم الداخلي المستدام خطوة ملحة من أجل حماية المصادر الطبيعية والبيئة من الملوثات
				b. الاستدامة هي اتجاه بعيد عن الاعتبارات الجمالية للفراغات الداخلية.
				c. الاستدامة هي ممارسات يجب الالتزام بها باعتبارها ليست موضحة أو اتجاه.
				d. استدامة التصميم الداخلي قادرة على المساهمة في تخفيض تكلفة المشروع.
				e. من الضروري ايجاد ما يشجع استخدام الاستدامة في الفراغات الداخلية على مستوى الزبائن والعاملين
				f. من الضروري ادخال مفاهيم الاستدامة في المناهج الاكاديمية ذات العلاقة بالتصميم الداخلي.
				g. الجهات المسؤولة مثل النقابات والبلديات لها دور كبير في نشر الوعي البيئي.
				h. من الصعب الالتزام بتطبيق الاستدامة في حال غياب قانون يلزم المهندسين على ذلك.
				i. يفضل ايجاد قدر من المعرفة لدى المهندسين والطلبة بأهمية اتباع معايير المستدامة في الفراغ الداخلي
				j. لدي الاستعداد بالالتزام بتطبيق مفهوم الاستدامة في التصميم الداخلي في حال وجود محفزات في هذا الاتجاه.
				k. لدي الاستعداد في اقناع مالك المشروع لإتباع النهج البيئي في التصميم

(Q_C) المجموعة الثالثة: الممارسات البيئية – المستدامة

<input type="checkbox"/> لا	<input type="checkbox"/> نعم	C ₁ . هل تعتبر دائما تطبيق الاساليب البيئية هدفا رئيسا في التصميم؟
C ₂ . عدد المشاريع التي تم فيها تطبيق مفاهيم الاستدامة في مشاريع التصميم الداخلي المستدام واذكرها		
<input type="checkbox"/>	a. لا يوجد	
<input type="checkbox"/>	b. 1-5 مشاريع	
<input type="checkbox"/>	c. 5-10 مشاريع	
<input type="checkbox"/>	d. أكثر من ذلك	
اذكرها:		

C₃. هل يوجد لمؤسستكم هدفا بيئيا نحو مجتمع مستدام

<input type="checkbox"/>	a. نسعى حاليا لتطوير هدف في هذا المنحى.
<input type="checkbox"/>	b. نعم وضع قيود تفرض على المصممين داخل المكتب من اتباع المعايير البيئية
<input type="checkbox"/>	c. نساهم بدرجة كبير في خلق مبادرات مع الجهات المعنية لإيجاد ما يطور هذا المجال
<input type="checkbox"/>	d. لا يوجد

C₄. من خلال خبرتكم في هذا المجال، هل واجهتكم مشكلة بيئية أثناء أو بعد التصميم؟

<input type="checkbox"/>	a. نعم (اذكرها).....
<input type="checkbox"/>	b. لا، لم يسبق أن واجهت أحد التصاميم بعد التنفيذ أي من المشاكل على الصعيد البيئي.
<input type="checkbox"/>	c. اتوقع ظهور عدد من المشاكل البيئية نتيجة للتصميم الداخلي الغير محكوم بقانون معين

C₅. هل لديكم خطة مستقبلية للمساهمة في ترويج المفاهيم البيئية المستدامة.

- a. تطوير خطة لإعادة استخدام مواد البناء
 b. الاشتراك كعضو في أحد المؤسسات أو الشركات المختصة بالبيئة
 c. خلق التزام لتطبيق المفاهيم البيئية في التصميم
 d. الاستغلال الأمثل للطاقة
 e. لدينا مساهمات بسيطة
 f. لا توجد

C₆. ما هي درجة ترتيب العوامل التالية كأوليات يتم بناء عليها اختيار مادة البناء وآلية التشطيب في التصميم الداخلي؟

يتم اعطاء قيمة واحدة في كل صف أو عمود						
7	6	5	4	3	2	1
						a. متطلبات الزيون
						b. المتطلبات الجمالية في التصميم
						c. قلة أثرها السلبي على البيئة والمستخدمين
						d. إمكانية إعادة استخدامها أو التصنيع
						e. توافرها في السوق المحلية
						f. المرونة والسرعة في التنفيذ
						g. الديمومة والاستمرارية

C₇. هل يتم استخدام أنواع من النباتات في التصميم الداخلي؟

b. لا ، وذلك بسبب			a. نعم، فما هي دواعي الاستخدام؟		
3	2	1	3	2	1
		b ₁			a ₁
		b ₂			a ₂
		b ₃			a ₃

C₈. ما هي نسبة الإضاءة الطبيعية الذي تسعى لتحقيقها في الفراغ الداخلي الخاص بالمبنى التجاري مقارنة بالمساحة الاجمالية.....%.

C₉. عند حساب وحدات الإضاءة اللازمة لفراغ تجاري، تفضل اختيار

- a. العدد الأقل لإعطاء الكفاءة المناسبة
 b. إضافة عدد أعلى من القيمة المحسوبة اذا سمحت الميزانية
C₁₀. نسبة الاعتماد الأكبر لتحقيق مستوى الراحة الحرارية للمستخدمين.

- a. استخدام العوازل الحرارية
 b. استخدام وحدات التكييف
 c. أساليب طبيعية

C₁₁. هل يتم الاعتماد على استخدام عوازل صوت في الفراغ؟

a. نعم b. لا

إذا كانت الإجابة بنعم اذكر المواد المستخدمة:.....

C ₁₂ . الأولوية في اختيار الآلات الكهربائية ووحدات الإضاءة		
3	2	1

			a. مواصفاتها الجمالية
			b. كفاءة الطاقة
			c. علامة تجارية
3	2	1	C13. الأولوية في الاعتماد على أساليب التسخين للمياه في الفراغ.
			a. الاعتماد على السخانات الشمسية
			b. الاعتماد على استخدام السخان الكهربائي
			c. أساليب طبيعية
C14. هل يتم استخدام أنواع مخصصة من الأجهزة والحنفيات التي تحكم استهلاك المياه؟			
		<input type="checkbox"/>	a. نعم
		<input type="checkbox"/>	b. لا
<input type="checkbox"/> إذا كانت نعم اذكر اسم المشروع.....			
C15. هل سبق لك اعتماد نظام إعادة استخدام مواد البناء؟ اذكرها			
		<input type="checkbox"/>	a. نعم
		<input type="checkbox"/>	b. لا
إذا كانت الإجابة بنعم، اذكر اسم المشروع.....			
C16. هل سبق لك أي من برامج الحاسوب في تحليل جودة الفراغ الداخلي؟			
		<input type="checkbox"/>	a. نعم
		<input type="checkbox"/>	b. لا

(QD) المجموعة الرابعة: العوائق والمحفزات أمام التصميم الداخلي المستدام

D1. العوائق التي تحد من استخدام الاستدامة في مشاريع التصميم الداخلي

5	4	3	2	1	بحيث يتم تقييم درجة العائق حسب درجة قوته/ حيث (5) يعبر عن قيمة الأعلى (1) يعبر عن القيمة الأقل
					a. تكلفة استخدام مواد البناء المستدامة
					b. طبيعة برنامج المشروع ومتطلباته
					c. الرغبة في عدم التقييد بأي معايير
					d. ليس هناك ما يلزم من اتباع أي من هذه المعايير سواء ضمن النقابات أو البلديات
					e. عدم المعرفة الكافية في هذا المجال.
					f. رغبة وطلبات الزبائن في الوصول لتصميم مشابه لحال المشاريع المحلية
					g. قلة المصادر التي تتحدث عن الاعتبارات البيئية للفراغ الداخلي المستدام
					h. قلة عدد المختصين في هذا المجال
					i. نقص المهتمين بهذا المجال ضمن فريق العمل
					j. نمط الحياة السائد في قطاع غزة.
					k. قلة التركيز على هذه القضايا على المستوى الاعلامي .
					l. مواد البناء الصديقة للبيئة هي مواد غير متوفرة محليا

D2. ما هي المحفزات التي يمكنها أن تدفع المكاتب والمصممين إلى اتباع مفاهيم الاستدامة في التصميم الداخلي للفراغات.

					a. اعتقد أنها مبادرات شخصية من الشركة أو المكتب
					b. القوانين
					c. طلب الزبائن
					d. المعرفة والوعي الكافيان في هذا مجال.
					e. الوصول لدرجة اقناع الزبائن بتطبيقها تحقيقا لدرجة من الرضا على مستوى التكلفة والنواحي الجمالية.
					f. ايجاد من يهتم بهذه القضايا على صعيد المناهج التعليمية.

اسم الشركة أو المكتب:

موقع الشركة البريد الالكتروني	
1. عدد سنوات الخبرة في مجال التصميم الداخلي	
<input type="checkbox"/> 4-0 سنة	<input type="checkbox"/> 9-5 سنة
<input type="checkbox"/> 19-15 سنة	<input type="checkbox"/> أكثر من 20 سنة
2. عدد مشاريع التصميم الداخلي التي تم تطبيقها خلال السنوات الخمس الماضيةمشروع
3. المشاريع الأكثر تنفيذا في مشاريع التصميم الداخلي في الالونة الأخيرة	
<input type="checkbox"/> سكنية	<input type="checkbox"/> تجارية
<input type="checkbox"/> صحية	<input type="checkbox"/> ثقافية
4. عدد المختصين في مجال التصميم الداخلي في المكتب	<input type="checkbox"/> لا يوجد
خامسا: أي ملاحظات أو تعليقات عامة	

.....
.....
.....
.....
.....

شكرا لكم لحسن تعاونكم معنا لإتمام هذا الاستبيان

وقبلوا منا فائق الاحترام والتقدير

م. إيمان أحمد سليمان الشيخ خليل

Appendix B: Questionnaire in English language

(QA) : measuring the knowledge about sustainable practices.

A₁: From your point of view, how the indoor space can environmentally sustain?

.....

.....

A₂: from your point of view, what are the issues decreasing indoor quality if they not consider?

- | | | |
|------------------------------|--|------------------------------|
| a. materials quality | b. Efficient using for energy | c. efficient using for water |
| d. level of acoustic comfort | e. level of natural vent. and lightening | d. level of thermal comfort |

--	--	--

A₃: how strongly do you agree with the following statements?

- | |
|---|
| l. Sustainability is concern in environmental aspect as it is concern with other aspects economic and social. |
| m. Practicing sustainability enhance ethical aspects toward environment. |
| o. Environmental sustainability has the ability to reduce environmental impacts. |
| p. Sustainable interior design can contribute to reduce consuming of electricity and energy. |
| q. Designers can reduce space pollutants among sustainable interior design. |
| r. Designers can reduce consuming water among sustainable interior design |
| s. Designers can reduce wasting of among sustainable interior design |
| t. Designers benefit the physical and mental health of occupants among sustainable interior design |
| u. Designers increasing occupant's performance among sustainable interior design |
| v. Activities' Functional relationship effect on environmental level for any projects. |
| w. Choosing space has an environmental affects |

A₄ . Which of the following tools, measuring the environmental performance, do know?

- | |
|--|
| <input type="checkbox"/> a. DQI(design quality indicator) |
| <input type="checkbox"/> b. EMGB(Evaluation manual for green buildings) |
| <input type="checkbox"/> c. EPGB(Environmental performance Guide for building) |
| <input type="checkbox"/> d. GBTool(Green building challenge) |
| <input type="checkbox"/> e. GHEM(Green home evaluation manual) |
| <input type="checkbox"/> f. Leed(leadership in energy and environmental design) |
| <input type="checkbox"/> g. BABERS(National Australian building environmental rating system) |
| <input type="checkbox"/> h. SBAT(Sustainable building assessment tool) |
| <input type="checkbox"/> i. SPeAR(sustainable project appraisal routine) |
| <input type="checkbox"/> j. Nothing of these |

(Q_B): Evaluating the attitudes toward sustainable interior design.

B₁: How strongly do you agree with the following statements?

- l. Sustainable interior design is insistent step to preserve the natural resources.
- m. Sustainability far from esthetical aspects of indoor spaces.
- n. Sustainable interior design practices are not a passing trend.
- o. Sustainable interior deigns provide less cost.
- p. It is necessary to motivate both of clients and worker to practice sustainability in the design of interior.
- q. It is necessary to insert sustainability through curriculum in related field.
- r. Authorities as engineering association and municipalities have the biggest role environmental awareness .
- s. It is difficult to practice sustainability in case of laws' absence.
- t. Knowledge of Designers and students should be increased toward more sustainable practices.
- u. I can encourage clients to use sustainable interior design practices on projects.
- v. I am open to use sustainable interior design practices if there are a motivations
- w. For more sustainable community in Gaza, there must be an environmental force.

(QC): Behaviors and practices for sustainable interior design

C ₁ : Do you always put environmental aspects as a main objective for design?	yes	No
--	------------	-----------

C₂: How many time did you practice sustainability in design of interior?

- e. No time
- f. 1-5projects
- g. 5-10 projects
- h. More than

Mention it.....

C₃: Is there a concrete environmental goal to be achieved at your company?

- e. We improve an environmental goal.
- f. Yes, there is an environmental restricts for designers
- g. We contribute to find cooperation environmental issues with concerned authorities.
- h. No there is no goal.

C₄: From your experience, do you confront any environmental problem while or after design stage?

- d. Yes(mention it)
- e. No,
- f. I expect that will happen later as there are no laws control interior design.

C₅: How do your company’s activities contribute to better environment?

- g. Through improving the policy of using recycled materials.
- h. Joining to the firms and institute that concern the environment.
- i. Creating a commitment to apply the concept of sustainability in design of interior.
- j. Optimal investing for energy.
- k. We have small contribution.
- l. There is no contribution until no.

C₆: What is the order for the following factors as apriority, when you choose finishing materials and construction ways?

Give on value in each column and row.

- h. Client’s requirements
- i. Aesthetic requirements
- j. It’s impact for both environment and occupants
- k. The ability for recycling or reusing
- l. Availability
- m. Flexibility
- n. Durability and continuity

C7: do you use plant in your design?

d. No, as it		c. Yes, what are the reasons for using?	
b ₁	It not one of my concern in design	a ₁	Reduce CO2
b ₂	It's negative impacts	a ₂	Client's desire
b ₃	Client's desire	a ₃	Aesthetic requirement

C8: what is the percentage of natural lightening you always investigate at indoor commercial spaces?.....%

C9: while you calculate the light elements required to space, you choose

- a. The minimum numbers of elements to realize the appropriate efficiency
- b. Additive numbers of light element.

C10: the method you always use to enhance thermal comfort is

- d. Using thermal isolators
- e. Using air conditioners
- f. Passive design methods

C11: Have you ever use acoustic isolators?

Yes

No

If your answer (yes), mention what the materials you used.....

C1: the priority for choosing electric devices and light element is

- d. It's aesthetic specifications
- e. Energy efficiency
- f. Commercial trade mark

C13: the most method you use for water heating is

- d. Solar heater
- e. Electric heater
- f. Passive design method

C14: do you use special devices and taps for reducing water use.

d. No c. Yes

If your answer is (Yes), write the name of the projects.....

C15:Have you ever depend on recycled materials

- c. Yes
- d. NO

If your answer is (Yes), write the name of the projects.....

C16: Have you ever use any software program to make environmental analysis.

No b.

Yes a.

(Q_D): barriers and motivation among practicing interior design

D₁: How much the following barriers/ factors prevent you to practice sustainable interior design?

You will give (5) for the most strong barriers, and (1) for the least one.

- m. Cost of sustainable materials
- n. Project program and the requirements
- o. Desiring to design freely without any restricts
- p. There is no forced law for practicing.
- q. My level of experience with sustainable interior design practices
- r. Lack of expressed from clients.
- s. Lack of resources related to sustainable interior design
- t. Lack of experiences
- u. Lack of expressed from team workers
- v. Life style at Gaza
- w. Lack of focusing on these issues in the media
- x. Eco friendly materials are not available in Gaza.

D₂ . How much the following factors motivate you to practice sustainable interior design?

You will give (5) for the most strong barriers, and (1) for the least one.

- g. Personal initiative
- h. Laws
- i. Client's desire
- j. Knowledge and inception
- k. Encourage clients to apply sustainability in both economic and aesthetic aspects
- l. Find interested in this issues at curriculum.

1. **Name of the company or firm:**.....

2. **Location of the company:**.....

3. **The Web site:**

4. **What is the number of experience years in practicing interior design profession?**

5. **What is the number of interior design projects in the last years?**

6. **What are the most interior projects you are practicing?**

Residential buildings	Commercial buildings	Office buildings
Health buildings	Cultural buildings	

7. **How much dose the company has of the interior designers?**

8. Any general comment

.....

.....

.....

.....

.....

.....

.....

.....

.....

Thanks for your contribution to complete this questionnaire

Best regards

Eng. Eman Ahmad Suliman El Shaikh Khaleel

تصنيف المكاتب حتى 30/6/2012 (قوة استشاري)

2071029	مختومس																		إزمري عبد الكريم ابو دقة	المركز الهندسي للاشياء والاستشارات-مهارات	CF21	21
2840580	غزة	X	X	X	X	X	X	X	X	X	X	X	X	X	X	X	X	X	أحمد حسين وادي	مستشارون في الهندسة والبناء -لقرا	CF22	22
9/804518	رابع	X	X	X	X	X	X	X	X	X	X	X	X	X	X	X	X	X	رابع عطا الله	المشاركة للهندسة والبناء	CF23	23
2533363	الوسطى																		المخلص خالد الهندي	التخطيط للهندسة والاعمار	CF24	24
2815618	غزة																		تأهض عبد التلطف عنترك	اوقية شامراء هندسي	CF25	25
2827727	غزة	X	X	X	X	X	X	X	X	X	X	X	X	X	X	X	X	X	لؤي أحمد مصبح	الوطنى للهندسة والاعمار	CF26	26
2836449	غزة																		علاء عني ابو زينة	امجد للهندسة والانشاءات	CF27	27
2859901	غزة																		أمل عبد الحليم العطل	ليون الاستشارات الهندسية	CF28	28
2836913	غزة																		أفوز خالد حرارة	أشرف الاستشاري الهندسي	CF29	29
2830863	غزة																		اديب رشدي حميد	بابل للاستشارات الهندسية	CF30	30
9/180636	الوسطى																		صبيحي سلمان عبد الحسي	بغداد للهندسة	CF31	31
2075564	مختومس																		رنا خالد احمد	بلدي للاستشارات	CF32	32
2476957	الشمال																		محمد خليل مطر	بيسان للهندسة والاعمار	CF33	33
2814926	غزة																		ليلى العبداد	دمشق للهندسة والاعمار	CF34	34
2066624	مختومس																		تأهض عبد حسونة	نور للهندسة والتخطيط	CF35	35
2826063	غزة	X	X	X	X	X	X	X	X	X	X	X	X	X	X	X	X	X	مترن طه ابو الطيف	راى كونسلت	CF36	36
2826503	غزة																		وسام المدهون	ريكون الاستشاري الهندسية	CF37	37
2825511	غزة																		زكريا سعدي الحايك	زوايا للاستشارات الهندسية	CF38	38
2538662	الوسطى																		ابن فخري ابراهيم قطار	سامراء	CF39	39
9/768824	مختومس																		محمد عبد السلام القرا	عرب للاستشارات الهندسية والتخطيط	CF40	40
9866696	الوسطى																		سماح حميد حميد	عشار للهندسة	CF41	41
2053303	خان بولس																		سليمان محمد براهيم	غزة للهندسة	CF42	42
9/461399	رابع																		كمال فرج ضهير	مجموعة المعماريون للاستشارات الهندسية	CF43	43

تصنيف المكاتب حتى 30/6/2012 (قبة استشاري)

2137075	2137075	رفع				X	X	X	X	X	مجمع عبد الوهاب قنديل	597847001	مجمع عبد الوهاب قنديل	مجموعة أريبيكو للاستشارات الهندسية	CF44	44
	9420138	غزة			X	X	X	X	X	X	عبد العزيز عبد الله صيام	598990182	عبد العزيز عبد الله صيام	مركز الشرق للهندسة والاصمار	CF45	45
2867690	2867690	غزة		X		X	X	X	X	X	عزت شعبان شقيه	599874661	عزت شعبان شقيه	مركز عمران الحديث	CF46	46
	8/262068	غزة		X		X	X	X	X	X	عمر سلامة محسن	598262068	عمر سلامة محسن	مركز التقنية للهندسة والادارة	CF47	47
2846445	2827173	غزة	X			X	X	X	X	X	ايد اسامة ابو وردة	599411471	ايد اسامة ابو وردة	مركز الهندسة والتخطيط	CF48	48
	2860664	غزة					X	X	X	X	احسان زيد الظللا	599909178	احسان زيد الظللا	مركز غزة للخدمات الهندسية	CF49	49
2147720	2147720	رفع		X		X	X	X	X	X	عمر حناك حرب ابو مور	599301359	عمر حناك حرب ابو مور	مركز للهندسة والتطوير	CF50	50
2883799	2883799	غزة				X	X	X	X	X	هاني فايز ابو عكر	599847110	هاني فايز ابو عكر	تخصصت للاستشارات الهندسية	CF51	51
2860990	2834696	غزة		X		X	X	X	X	X	عفي نبيب رمضان النخلة	599413922	عفي نبيب رمضان النخلة	مجموعه للاستشارات الهندسية	CF52	52
888694	2835053	غزة				X	X	X	X	X	محمد محمود سليمان	598089017	محمد محمود سليمان	ايد سيني للهندسة	CF53	53
2866651	2866651	غزة	X			X	X	X	X	X	يحيى رمضان الخطيب		يحيى رمضان الخطيب	دار الهندسة	CF54	54
2848705	2838195	غزة	X	X		X	X	X	X	X	جمال محمد ابو كاشف	599363730	جمال محمد ابو كاشف	الاستشاريين للتخطيط	CF55	55
	2844557	غزة				X	X	X	X	X	هاتم رستم		هاتم رستم	اربيك	CF56	56
	2886304	غزة				X	X	X	X	X	عبد الكريم الغرابي	599883709	عبد الكريم الغرابي	لوكيبا للهندسة والادارة	CF57	57
2839614	2839614	غزة				X	X	X	X	X	احمد عبد العزيز ابو حبة	599833073	احمد عبد العزيز ابو حبة	الرشيد للاستشارات والمشاريع الهندسية	CF58	58
2139072	2139072	رفع				X	X	X	X	X	عبيد موسى جرجون	598680499	عبيد موسى جرجون	مركز المدينة للهندسة والانشاءات	CF59	59

قائمة المكاتب المصنفة حتى 30/6/2012 (فئة مهندسي (ب)

	2535831	الوسطى				X	X	X	X	590497913	يوسف محمود علقور	المراج للهندسة والاعمار	E/B21	21
	7/405525	رفح				X	X	X	X	597405525	ابراهيم احمد ابو خلال	لتصوير الهندسة	E/B22	22
2474636	9344425	الشمال				X	X	X	X	599472332	سعيد محمد الكرد	الهندسي للتصميم المعماري والعمري	E/B23	23
	9/858531	خانيونس				X	X	X	X	599858531	عثمان ابراهيم ابو علقور	التهيئه للاستشارات الهندسية	E/B24	24
	9831092	غزة				X	X	X	X	599305132	شيمس مطيع صفر	ابراج العرب للهندسة والاعمار	E/B25	25
	2538566	الوسطى				X	X	X	X	597099928	ناصر اسماعيل الجديسي	بناة الحرمين	E/B26	26
		خانيونس				X	X	X	X	0599/531582	محمد الطياري	بناء الهندسة والتخطيط	E/B27	27
2065088	2065088	خانيونس				X	X	X	X	599884482	محمد حسن حماد	بيوتير الهندسي	E/B28	28
	2477544	الشمال				X	X	X	X	598911439	الصدوق اسماعيل خضر	جديليا الهندسي	E/B29	29
	9/193936	خانيونس				X	X	X	X	597209295	علاء زيد فارس	جلاطور	E/B30	30
		رفح					X	X	X	لا يوجد	احمد عبد الفتاح عزيز	حظنين للاستشارات الهندسية	E/B31	31
	8/980189	رفح				X	X	X	X	598980189	احمد هسان ابو عريضة	دار الفتان للهندسة والاعمار	E/B32	32
	9761392	خانيونس				X	X	X	X	599729441	علي مصباح خلف الله	ريوة للهندسة والتخطيط	E/B33	33
	2151018	رفح				X	X	X	X	599639080	فادي عبد السلام ابو حرب	ارواح للهندسة والتصميم	E/B34	34
2852317	2852317	الشمال				X	X	X	X	599413360	ريم محمود الزاهر	ارواح للهندسة والاعمار	E/B35	35
	2472012	الشمال				X	X	X	X	599342231	خليل ابراهيم كيتاني	سلامة الهندسة والاعمار	E/B36	36
	2566713	الوسطى				X	X	X	X	599880669	حسام نصر الجديسي	شمس الهندسة والاعمار	E/B37	37
	9575524	الشمال				X	X	X	X	599014125	محمد ابراهيم التتري	شمس الهندسة والاعمار	E/B38	38
2882021	5/884211	الوسطى				X	X	X	X	599742604	ايهاب مناس اسماعيل	طوبية للهندسة والاعمار	E/B39	39
		غزة				X	X	X	X	599624245	سامي عليان شمسي	فجرب للتدكات الهندسية	E/B40	40
		خانيونس				X	X	X	X	0599/490806	محمد محمود ابو دقة	كوتسيت الهندسي	E/B41	41
2841273	2841273	غزة				X	X	X	X	597586076	احمد محمود ابو شبيب	امسات للهندسة والاعمار	E/B42	42

قائمة المكاتب المصنفة حتى 30/6/2012 (فئة هندسي (ب)

	5/860760	لوسطي				X	X	X	X	X	595860760	عاصم حد الصنات	مجموعة معمل الهندسة	E/B43	43
2073336	9/767791	خانيونس			X	X	X	X	X	X	599324908	غدير ابراهيم بوقفة	مركز الريان للاستشارات	E/B44	44
		خانيونس			X	X	X	X	X	X	599904606	سماح حماد النجار	معمل الهندسي	E/B45	45
	9/361120	الشمال			X	X	X	X	X	X	599361120	فوزان فخري بكفارنة	نهاء الهندسة والعمارة	E/B46	46
	2821131	غزة			X	X	X	X	X	X		نظير مهنا	تصميم الهندسة	E/B47	47
	9/493242	غزة			X	X	X	X	X	X	599493242	هنداء احمد الدوشان	اينش للهندسة والديكور	E/B48	48

