

5-2014

Designing Customizable Network-on-Chip with support for Embedded Private Memory for Multi-Processor System-on-Chips

Azad Fakhari

University of Arkansas, Fayetteville

Follow this and additional works at: <http://scholarworks.uark.edu/etd>



Part of the [Computer and Systems Architecture Commons](#)

Recommended Citation

Fakhari, Azad, "Designing Customizable Network-on-Chip with support for Embedded Private Memory for Multi-Processor System-on-Chips" (2014). *Theses and Dissertations*. 1058.

<http://scholarworks.uark.edu/etd/1058>

This Thesis is brought to you for free and open access by ScholarWorks@UARK. It has been accepted for inclusion in Theses and Dissertations by an authorized administrator of ScholarWorks@UARK. For more information, please contact scholar@uark.edu, ccmiddle@uark.edu.

Designing Customizable Network-on-Chip
with support for Embedded Private Memory
for Multi-Processor System-on-Chips

Designing Customizable Network-on-Chip
with support for Embedded Private Memory
for Multi-Processor System-on-Chips

A thesis submitted in partial fulfillment
of the requirements for the degree of
Master of Science in Computer Engineering

By

Azad Fakhari
Iran University of Science and Technology
Bachelor of Science in Computer Hardware Engineering, 2009

May 2014
University of Arkansas

This thesis is approved for recommendation to the Graduate Council

Dr. David Andrews, Ph.D.
Thesis Director

Dr. Christophe Bobda, Ph.D.
Committee Member

Dr. Jia Di, Ph.D.
Committee Member

Abstract

The computer industry's transition to multiprocessor systems on chip (MPSoC) architectures is increasing the need for new scalable high-bandwidth on-chip communication backbones. Network-on-Chip (NoC) interconnects are gaining interest for serving as the on-chip communication infrastructure. The most important issues to be considered in designing a NoC are topology, routing algorithm, flow control, and buffering and also the trade-offs between performance, power, and area.

This research proposes a custom-designed NoC specifically for MPSoCs on FPGAs. The proposed design allows the communication infrastructure to seamlessly scale as the numbers of processors within the chip increases. The design adds a new level of abstraction to remote-access transactions. The design also considers support for the partitioned global address space model with support for optional embedded local memories embedded in the network interface. The network was designed as a mesh topology to allow a reasonable communication capacity in 2-Dimensional space. The communication protocol between source and destination is AMBA AXI4, and the communication between each two adjacent nodes, is typical AXI type valid/ready handshake. The nodes are distinguished by their user specified address range. Each node is assigned a range of addresses, and in each transaction, based on the destination address, the routers decide the the next node, until the transaction reaches the destination. The design has been implemented on a Xilinx Virtex7 FPGA. However, there is no platform dependency to any brand or any model of FPGAs.

Acknowledgment

I would like to thank my adviser and my mentor Dr. David Andrews for giving me the opportunity to work in his research laboratory and for his support and guidance throughout my Master's program. I would also like to thank Dr. Ken Eguro, from whom I have learned a tremendous amount during my time in Microsoft Research. Additionally, I would like to thank my thesis committee, Dr. Chrisophe Bobda and Dr. Jia Di, for broadening my knowledge in this field. Finally, I would like to thank my labmates in the CSDL lab for their friendship and support.

Table of Contents

1	Introduction	1
1.1	Thesis Contributions and Organization	3
2	Background	5
2.1	Multi-Processor System-on-Chips (MPSoCs)	5
2.2	Network-on-Chips (NoCs)	7
2.3	AMBA AXI4 Protocol	8
3	System Design	11
3.1	High-Level Design	11
3.1.1	Network Specifications	11
3.1.2	Structure of a Node on NoC	12
3.1.3	Address-Based Routing	12
3.1.4	A Transaction from End to End	15
3.2	Low-Level Design	17
3.2.1	Inside a Node	18
3.2.2	Data Transfer	18
3.2.2.1	Receiver (RX)	18
3.2.2.2	Transmitter (TX)	21
3.2.3	Local Ports	21
3.2.3.1	Memory Controller	21
3.2.3.2	AXI Master Interface	22
3.2.3.3	AXI Slave Interface	22
3.2.4	Network Ports	24
3.2.5	Routers	24
3.2.5.1	Service Arbiter	28
3.2.5.2	Port Allocator	29
3.2.6	Top Level	30
3.3	Implementation	30
4	Results	32
4.1	Verification	32
4.1.1	Component Verification	32
4.1.2	System Verification	33
4.1.2.1	Phase One	33
4.1.2.2	Phase Two	33
4.1.2.3	Phase Three	34
4.2	Resource Utilization	34
4.3	Time Analysis	36
5	Conclusion	40
5.1	Research Contributions	41

5.2	Future Work	42
	References	43

List of Figures

2.1	Channel architecture of reads[5]	9
2.2	Channel architecture of writes[5]	10
3.1	Structure of a node from outside	13
3.2	Connections between the nodes	14
3.3	Address ranges in a 4x4 mesh	16
3.4	Inside of a node	19
3.5	Receiver state machine	20
3.6	Receiver Module	21
3.7	The local port and the memory controller	23
3.8	The structure of the router	28
4.1	The resource utilization for different sizes of mesh	35
4.2	Latency with and without interfering traffic	38

List of Tables

4.1	Resource utilization for different sizes of mesh	35
4.2	Number of clock cycles a transaction takes to complete in a NoC with no interfering traffic	37
4.3	Number of clock cycles a transaction takes to complete in a NoC with interfering traffic	39

Terms and Definitions

SoC System-on-Chip. A system in which all components are co-located on a single chip.

MPSoC Multi-processor System-on-Chip. A system-on-chip having multiple processors.

NoC Network-on-Chip. A network type interconnect located on a single chip

FPGA Field Programmable Gate Array. An integrated circuit that can be configured or re-configured by a designer.

AMBA Advanced Microcontroller Bus Architecture

AXI Advanced eXtensible Interface

IP Intellectual Property

NA Network Adapter

NI Network Interface

DSM Deep SubMicron

VLSI Very-large-Scale Integration

IC Integrated Circuit

DOR Dimension-Order Routing

TX Transmitter

RX Receiver

PE Processing Element

TDM Time-Division Multiplexing

VC Virtual Channel

NF Negative First. Routing algorithm

WF West First. Routing algorithm

VHDL VHSIC Hardware Description Language

CRT Constrained Random Testing

Tcl Tool Command Language

RAM Random-Access Memory

LUT Lookup Table. A digital building block used to implement N-bit binary functions via lookup operations.

DMA Direct Memory Access. Often referring to hardware devices that can perform memory-to-memory operations without processor assistance.

Chapter 1

Introduction

Commercial Systems-on-Chip (SoC) designs continue to be dominated by shared-medium bus-based functional interconnects for integrating IP blocks. The continued adherence to bus based interconnects is in part historical due to their wide spread availability, ease of use, and familiarity. Pragmatically bus interconnects still remain relevant for today's multiprocessor SoC (MPSoC) systems that contain relatively few processors. However the number of processors and IP modules that will be integrated into future MPSoCs is projected to follow Moore's law with a doubling of IP modules every 18 months. The commercial MPSoC industry will soon be forced to deal with the inevitable; bus-based interconnection architectures will prevent these systems from delivering the performance that will be required by next generation applications[18][20].

A fundamental question that SoC manufacturers face is determining what type of interconnect structure should replace standard buses. Many types of different structures have been proposed as replacement interconnects for global bus structures for next generation MPSoCs[39]. Hierarchical bus structures are a natural evolution of global buses. While hierarchical buses have some performance advantages over a single bus, their resource requirements and performance will prevent them from scaling to large numbers of processors. They are also limited in their ability to support custom communications patterns. Recently Intel included a ring bus architecture within their Knights corner manycore chip. Ring buses provide better scalability than hierarchical or distributed buses but introduce variable latencies that can effect performance.

Of the different interconnect structures being studied Network on Chip (NoC) structures have continued to enjoy growing interest in the academic community. This interest is primarily based on the NoC's ability to provide performance that scales with the number of processors. In general, a network-on-chip can be viewed as being composed of three main building blocks. The first block contains the links that physically connect the nodes and implements the communication. The

second block is the router, which implements the communication protocol. The router receives packets from the shared links and, according to the address information contained in each packet, forwards the packet to the client attached to it or onto another shared link. The protocol itself consists of a set of policies defined during the design (and implemented within the router) to handle common situations that can occur during the transmission of a packet. Policies include how to process two or more packets arriving at the same time, for a single channel, avoiding deadlock and livelock situations, reducing the communication latency. The last building block is the network adapter (NA) or network interface (NI). This block makes the logic connection between the IP cores and the network.

While NoCs do hold promise, there are still several issues must be explored to understand if NoCs will be able to serve as the interconnect structures for next generation FPGA based MPSoCs. Addressing the following issues was the main motivation for this work.

Issue 1: Support for local memory: Most multi-processor systems use some type of local memory for the PEs. The local memory can be placed in the main interconnect infrastructure where it is accessible by the PE, or a secondary light-weight interconnect can be used for the communication between each PE and its local memory. Consequently, having a smart support for local memory in the interconnect backbone of the MPSoCs reduces the overhead of handling the local memory.

Issue 2: Unification of transactions: In MPSoC systems, based on the type of local resources and the outside resources accessible to the PE, the type of transactions to access different resources may vary. Unifying the transactions regardless of their locality ore remoteness reduces the overhead of generating the transactions in each PE.

Issue 3: Customization of the NoC for each client: In heterogeneous systems, different clients on the interconnect may require different services. For instance a PE may act as both master and slave while a component such as memory controller always acts as slave. Also different PEs may require local memories in different sizes. Customization of the NoC for each client allows the

system to use the resources more efficiently.

This thesis attempts to explore these issues for FPGA Multiprocessor Systems on Chip components.

1.1 Thesis Contributions and Organization

The thesis of this work is that Network-on-Chip interconnects can meet the communication needs while providing specific services for multi-processor systems. Those services include support for local memory, transparency of the locality or the remoteness of the accesses, and customization of each node based on the requirements of its client. These services reduce the overhead of transaction generation on the PEs.

To explore this thesis statement, this thesis provides the following set of contributions:

- A working implementation of a prototype NoC on an FPGA. The NoC is a scalable, reliable, and customizable infrastructure that uses an existing well-known communication protocol, AMBA AXI, as its network interface. This allows the basic NoC to be portable. An important attribute of the proposed NoC is its support of a partitioned global address space memory model to support scalability. The design supports inclusion of embedded local memory in each node, which is accessible both locally and remotely. This allows all transactions, whether local or remote to go through the same serving process. This is important support for the partitioned global address space memory model as it enables the locality or remoteness of the transaction to be transparent from the connected node.
- A complete implementation of both master side and slave sides of the AMBA AXI protocol to interface with the NoC
- The design, implementation, and optimization of a scheduler (service arbiter) to prevent the system from possible congestion.

- The design of a complex memory controller to synchronize remote and local accesses as well as read and write accesses.
- The design of an address compilation mechanism that maps the location of each node in the mesh to an address range, and decodes every address to its relative destination location in the matrix of nodes.
- A tool that automates the generation of the top level architecture. The tool customizes the size of the mesh, the type of the nodes(master/slave/both), and their need for memory controller.
- An automated simulation process that generates the large number of signals in the system, This eliminates the need for system designers to engage in time consuming manual simulation and ordering of waveforms to observe signals.

This thesis takes a close look inside the network and describes different parts both at functional level and the architectural level. Chapter 2 provides some background information on Multi-Processor System-on-Chips as well as Network-on-chips. Details of the AMBA AXI protocol used in this work is also described. Chapter 2 first observes the system at functional level as a network and then explains the design details of every component inside the system. This is followed by detailed discussions of the implementation of the design on the FPGA. Chapter 4 describes the verification process used to test and evaluate the NoC and presents experimental results. Finally, chapter 5 provides conclusions and directions for future work.

Chapter 2

Background

2.1 Multi-Processor System-on-Chips (MPSoCs)

The main motivation for the developments during decades is the System-on-Chip (SoC) technologies, where that complex applications are integrated onto single chips. These products such as mobile phones, notebooks and personal hand-held sets are also becoming faster, smaller-in-size, larger-in-capacity, lighter-in-weight, lower-in-power-consumption and cheaper. Following this trend, more applications and even systems could be integrated onto a single chip. However, the conventional methodologies for SoC design and integration do not evenly advance due to the big challenges confronted.

Deep SubMicron (DSM) effects[16][29][45]: In early days of VLSI design, signal integrity effects such as interconnect delay, crosstalk, inter-symbol interference, substrate coupling, transmission-line effects, etc. were negligible due to slow clock speed and low integration density. Interconnection was reliable and robust. For 250 nm (with aluminum) and 180 nm (with copper) and below, the dominating factor for chip robustness and performance became the interconnect. The speed and the reliability of the wires are not keeping up with the increasing pace of the transistor density. More noise sources due to inductive fringing, crosstalk and transmission line effects are coupled to other circuit nodes globally on the chip via the substrate, common return ground and electromagnetic interference. The increasing use of high-speed circuit families, for example, domino circuitry, scaling of power supply and threshold voltages, and mixed-signal integration combine to make the chips more noise-sensitive. Third, higher device densities and faster switching frequencies cause larger switching-currents to flow in the power and ground networks. Consequently, power supply is plagued with excessive IR voltage drops as well as inductive voltage drops over the power distribution network and package pins. Power supply noise degrades not only the driving capability of gates but also causes possible false switching of logical gates. Today signal and power integrity

analysis is as important as timing, area and power analysis.

Global Synchrony[2][21]: Predominating digital IC designs have been following a globally synchronous design style where a global clock tree is distributed on the chip, and logic blocks function synchronously. This style is unlikely to survive with future wire interconnect because technology scaling does not treat wire delay and gate delay equally. While gate delay has been getting dramatically smaller in proportion to the gate length, wires have slowed down. As the chip s become communication-bound, multiple cycles are required to transmit a signal across their diameter. Moreover, a clock tree is consuming larger portions of power and area budget and clock skew is claiming an ever larger portion of the total cycle time. Even if an unlimited number of transistors are available on a chip, chip design is to be constrained by communication rather than capacity.

Communication Architecture[7][12]: Most SoCs have a bus-based architecture, such as simple, hierarchical or crossbar-type buses. In contrast to the scaling of chip capacity, buses do not scale well with the system size in terms of bandwidth, clocking frequency and power. First, a bus system has very limited concurrent communication capability since only one device can drive a bus segment at a time. Second, as the number of clients grows, the intrinsic resistance and capacitance of the bus also increase. This means that the bus speed is inherently difficult to scale up. Third, a bus is inefficient in energy since every data transfer is broadcast. The entire bus wire has to be switched on and off. This means that the data must reach each receiver at great energy cost. Although improvements such as split-transaction protocols and advanced arbitration schemes for buses have been proposed, these incremental techniques can not overcome the fundamental problems.

Power and Thermal Management[32][38]: As circuits run with higher and higher frequencies, lowering power consumption is becoming extremely important. Power is a design constraint, which is no more subordinate to performance. Despite process and circuit improvements, power consumption shows rapid growth. In face of DSM effects, reducing power consumption is becoming even more challenging. As devices shrink to sub-micron dimensions, the supply voltage must

be reduced to avoid damaging electric fields. This development, in turn, requires a reduced threshold voltage. However, leakage current increases exponentially with a decrease in the threshold voltage. Further, leakage occurs as long as power flows through the circuit. This constant current can produce an increase in the chip temperature, which in turn causes an increase in the thermal voltage, leading to a further increase in leakage current.

Verification[36][11]: Today SoC design teams are struggling with the complexity of multimillion gate designs. System verification runs through the whole design process from specification to implementation, typically with formal methods or simulation-based validation. As the system has become extremely complex, the verification or validation consumes an increasing portion of the product development time. The verification effort has reached as high as 70% of engineering efforts.

Productivity Gap[4][11]: Simply put, productivity gap is the gap between what we are capable of building and what we are capable of designing. In line with Moores law, the logic capacity of a single chip has increased at the rate of 58% per annum compounded. The complexity of developing SoCs is increasing continuously in order to exploit the potential of the chip capacity. However, the productivity of hardware and software design is not growing at a comparable pace. The hardware design productivity is increased at a rate in the range 20% to 25% per annum compounded. Even worse, the software design productivity improves at a rate in the range from 8% to 10% per annum compounded. As a consequence, the costs of developing advanced SoCs are increasing at an alarming pace and time-to-market is negatively affected. The design team size is increased by more than 20% per year. This huge investment is becoming a serious threshold for new product developments and is slowing down the innovation in the semiconductor industry [27]

2.2 Network-on-Chips (NoCs)

Integrating a large number of components onto a chip is becoming a major performance issue in System-on-Chip (SoC) architectures [19][22][13][8]. Network-on-Chip (NoC) has been considered as a solution to address the communication demands of multi-core SoC architectures, due

to scalability and parallelism in communication infrastructure [13][8]. Also, [34] talks about the design trade-offs in NoC design and the performance evaluation based on different factors of the design.

In projects such as CLICHE [15], Nostrum[31], and XGFT[24], new architectures have been proposed to design NoC for multi-processor systems. In some other projects, NoCs have been designed for specific purposes. For instance, in SoCWire [33] the network is designed to be optimized for space application and GALS [41], targets inter-domain communication in heterogeneous DPS platforms. DyNoC[28] has proposed runtime scheduling and resource allocation in the network to increase the performance as well as flexibility. The NoC described in [14] is designed to ease the use of memory in the NoC which is very similar to the proposed design in this thesis. Other works such as [25] focus more on the power issues of the network. Projects such as [9] take advantage of the more novel chip design technologies such as three-dimensional integrated circuits.

Some projects have focused on more specific aspects of Network-on-chip. For instance, virtual channel allocation[40], deadlock free routing[23] and[17], coherency[26], dynamic priority arbitration[43], and congestion control[3] are some of those areas. There are also other projects that focus more on performance analysis [37][6][30]. Projects such as DART[42] and TOPAZ[1] have worked on simulation of the NoC. Among all, CONNECT[35] has provided web-based front-end to design user-customized NoCs for FPGAs.

2.3 AMBA AXI4 Protocol

The AMBA AXI is a high-performance communication protocol suitable for high-bandwidth high-frequency systems. This protocol provides flexibility and efficiency in designing interconnection and memory controllers by separating address, control, and data phases and also separating read and write channels as well as supporting burst-based transactions. There are 5 separate channels in AXI protocol

- Read Address (AR)

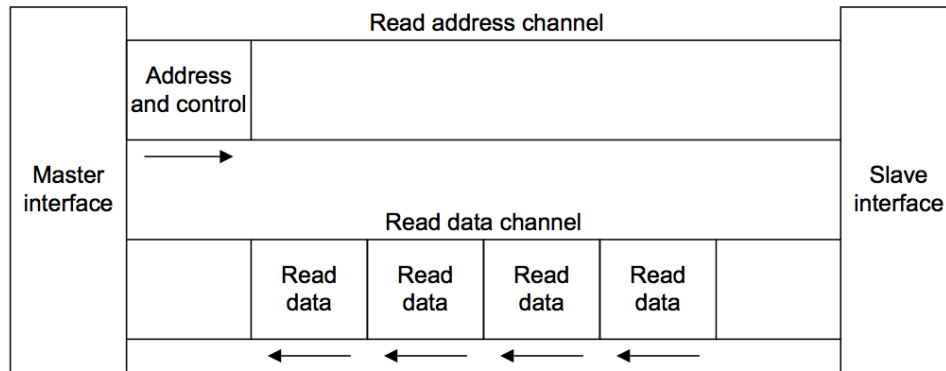

Figure 2.1: Channel architecture of reads[5]

- Read Data (R)
- Write Address (AW)
- Write Data (W)
- Write Response (B)

Read and write channels each have their own address channel to transfer the required address and the control signals. The read data channel carries both read data and the response information from the slave to the master. Write data channel carries write data from the master to the slave. The slave uses the write response channel to respond to write transactions. The completion of a transaction is signaled by the response in both read and write transactions.

A transaction is initiated by a master interface sending the start address and transaction specifications for read/write, to a slave interface. In a write transaction, the master interface sends the data on the corresponding data channel (W) to the slave interface and when the slave receives the entire data it sends a response on the write response channel (B) to the master. In a read transaction, when the slave interface receives the address and the control signals, it sends the requested data to the slave on the read data channel (R).

The data exchange process between a transmitter and a receiver is done using 2 handshake signals. The transmitter end, asserts the Valid signal when the data is ready to be transmitted. The receiver end, asserts the Ready signal when it is ready to receive the data. At the first active clock

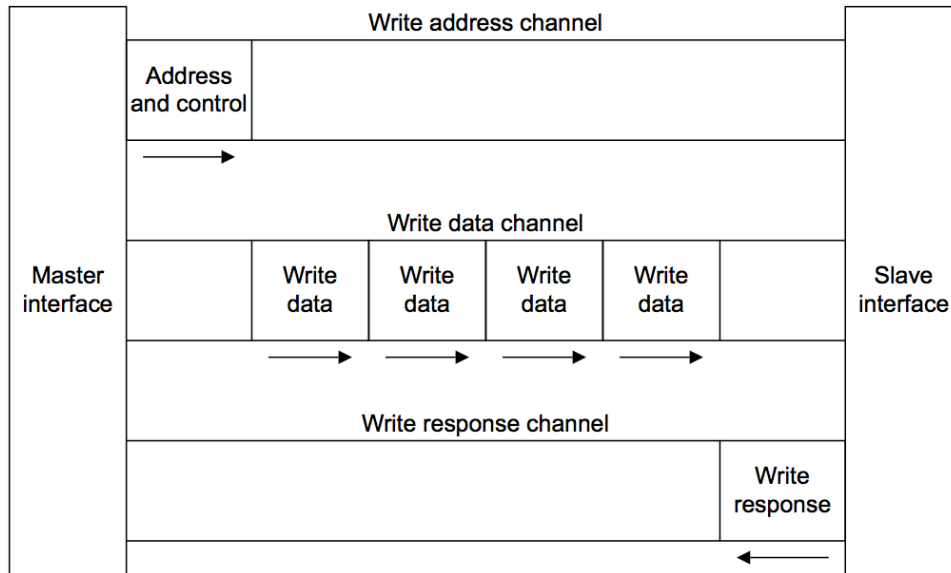

Figure 2.2: Channel architecture of writes[5]

edge after both Valid and Ready signals are asserted, the data will be exchanged. Each channel has its own pair of valid/ready signals.

In burst transactions the master interface sends the length and the type of the burst along with the start address of the burst. Then, the transmitter, asserts the Last signal with the final transfer in the transaction. If the number of transfers does not match the size of the burst, the receiver sends an error as response.

AXI uses a single clock signal and a single active low reset. The burst length is specified with an 8bit signal and the burst type is specifies with a 2bit signal. Those 2 signals along with a number of other control signals are sent along with the address on the address channel. The response is also a 2bit signal which specifies either the completion of a transaction or the type of error[5].

Chapter 3

System Design

In this chapter, the design specification of the system is discussed by first looking at the high level design and the details of the functions it provides. Then a view of the inside of the design is provided to find out how each component works. Finally, the details of the implementation of the design is discussed.

3.1 High-Level Design

In this section we look at the specifications of the network as a whole, and the details of the communication from a high level perspective. We also track a transaction from source to destination to understand the function of the network.

3.1.1 Network Specifications

Every network can be characterized by 3 major factors. First, there is the topology of the network and the geometrical specifications of the nodes. The topology defines the spatial coordination of the network. Then there is the flow control which handles the movement of the data from source to destination. Finally, there is the routing mechanism which is responsible for finding the path from source to destination through the network. This network is designed as a mesh to function efficiently in the 2-dimensional space of the FPGA chip. The flow control is done by doing valid/ready handshake between each two nodes on the path from the source to the destination. The routing mechanism is adaptive and it is an adjusted Dimension-Order Routing (DOR) which changes the order based on the traffic.

3.1.2 Structure of a Node on NoC

Each node in this NoC has 5 sets of ports. There is a set of ports for each possible direction in the mesh, plus a local port which is the network interface for the connected component. The directions are entitled:

- North Port (N)
- East Port (E)
- South Port (S)
- West Port (W)
- Local Port (L)

Each set of ports includes a master subset and a slave subset. Each subset, consists of 5 separate channels for each of the AXI channels. Figure 3.1 illustrates the structure of the node as a block.

The way each node is connected to the neighbor nodes is each master channel is connected to the corresponding slave channel of the adjacent node, as it can be seen in figure 3.2 . For instance, considering the horizontal connection between 2 adjacent nodes, the master AW east port of the node on the left is connected to the slave AW west port of the node on the right. The same way for the vertical connection, the slave B south port of the upper node is connected to the master B north port of the lower node.

For each transmitter on a master channel, there is a receiver on the slave side for the same channel, and for each transmitter on a slave channel, there is a receiver on the master side for the same channel. Therefore, master sides of the channels are connected with the slave sides of the channels of all the adjacent nodes and vice versa.

3.1.3 Address-Based Routing

In this design, the entire address range has been divided between the nodes. For instance, assuming a 2x2 mesh, and 32bit address, the first node is assigned to the address range between 0x00000000

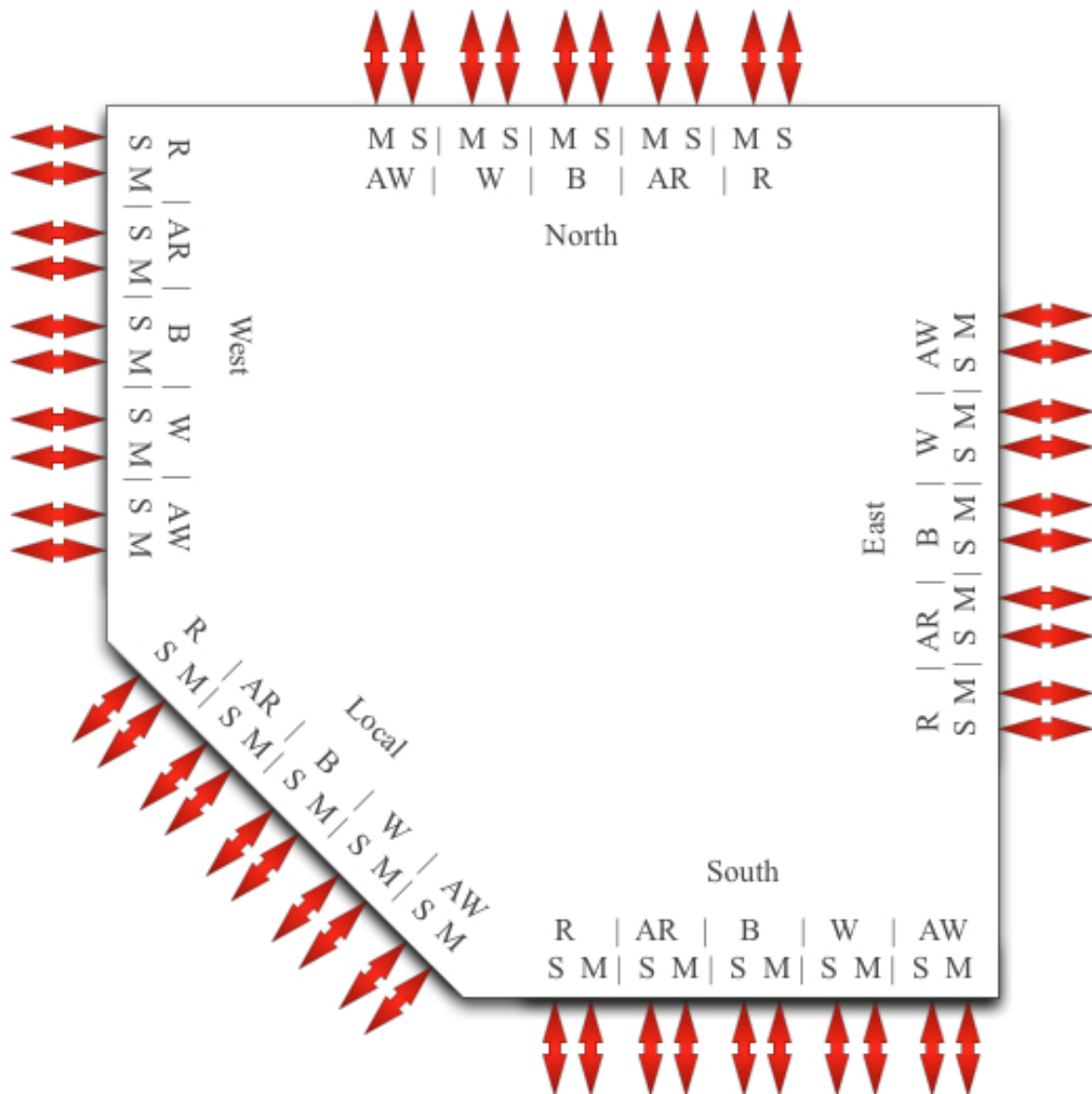

Figure 3.1: Structure of a node from outside

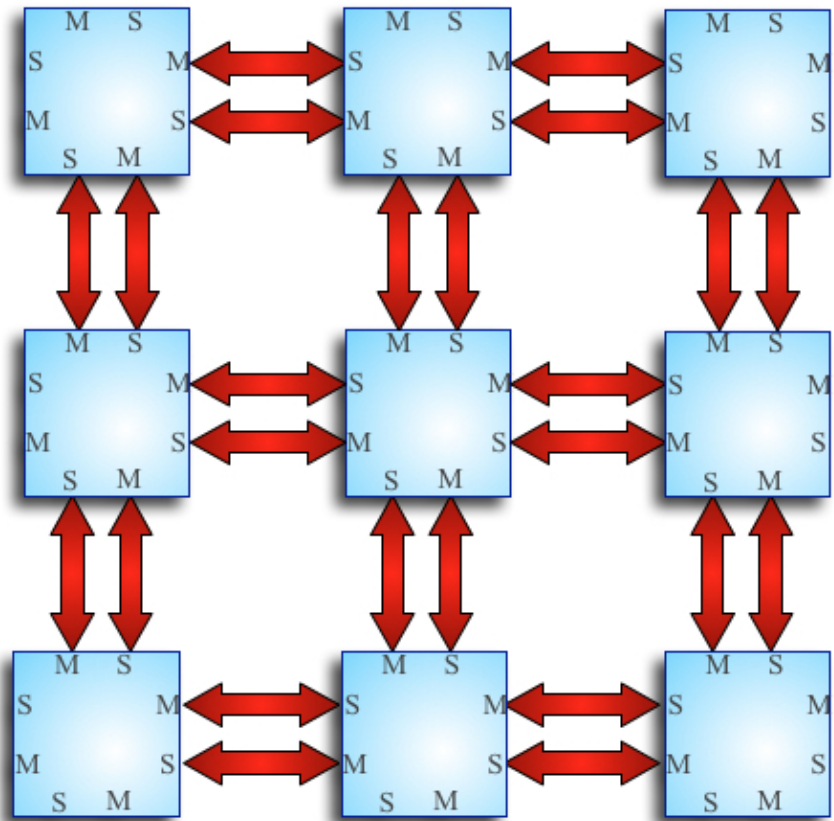

Figure 3.2: Connections between the nodes

and 0x3FFFFFFF, the second node between, 0x40000000 and 0x7FFFFFFF, the third node between 0x80000000 and 0xBFFFFFFF, and finally the fourth node is assigned to the address range between 0xC0000000 and 0xFFFFFFFF. What routers need to do is to decide the direction of the data, based on the destination address. For instance, let's assume a router in the first node (bottom left) receives a piece of data with the destination address of 0xD8AD0080. This destination address belongs to the fourth node (top right). In order to go from the bottom left corner of a 2x2 mesh to the top right corner 2 moves need to be done regardless of the order of their occurrences. One move to the east and one move to the north. Now let's describe a larger mesh and the way address ranges are assigned. Assuming a 4x4 mesh and the address range is divided evenly between the nodes. Figure 3.3 illustrates the way the address range has been divided in the mesh.

In the next section, an entire transaction in the described 4x4 mesh network will be tracked from end to end.

3.1.4 A Transaction from End to End

In the aforementioned 4x4 mesh, node 4 (a.k.a (1, 0)) sends a read request to node 14 (a.k.a (3, 2)) and node 14 responds with the requested data. The slave AR local port, connected to the AXI master interface of a component (for instance a processor), receives a high Valid signal. The request includes a destination address which is 0xED00804C, a burst-type signal defined as incrementing, and a burst length defined as 2. In other word, node 4 wishes to read 2 words from node 14 starting from address 0xED00804C. The AR router in node 4 receives an incoming data request. Before setting the Ready signal high and consequently completing the transfer between the local port and the component, the service arbiter decides when to serve the local port based on the traffic on the AR router (for further information see 3.2.5.1). When the local port is scheduled, a decoder in the router checks the destination address and finds out that the path between node 4 and node 14 consists of 2 east moves and 2 north moves. If both east and north output ports for AR are available, the default setting is to move horizontally (see 3.2.5.2 for more information on this). Assuming the east port is available, the port allocator assigns the east AR transmitter port to

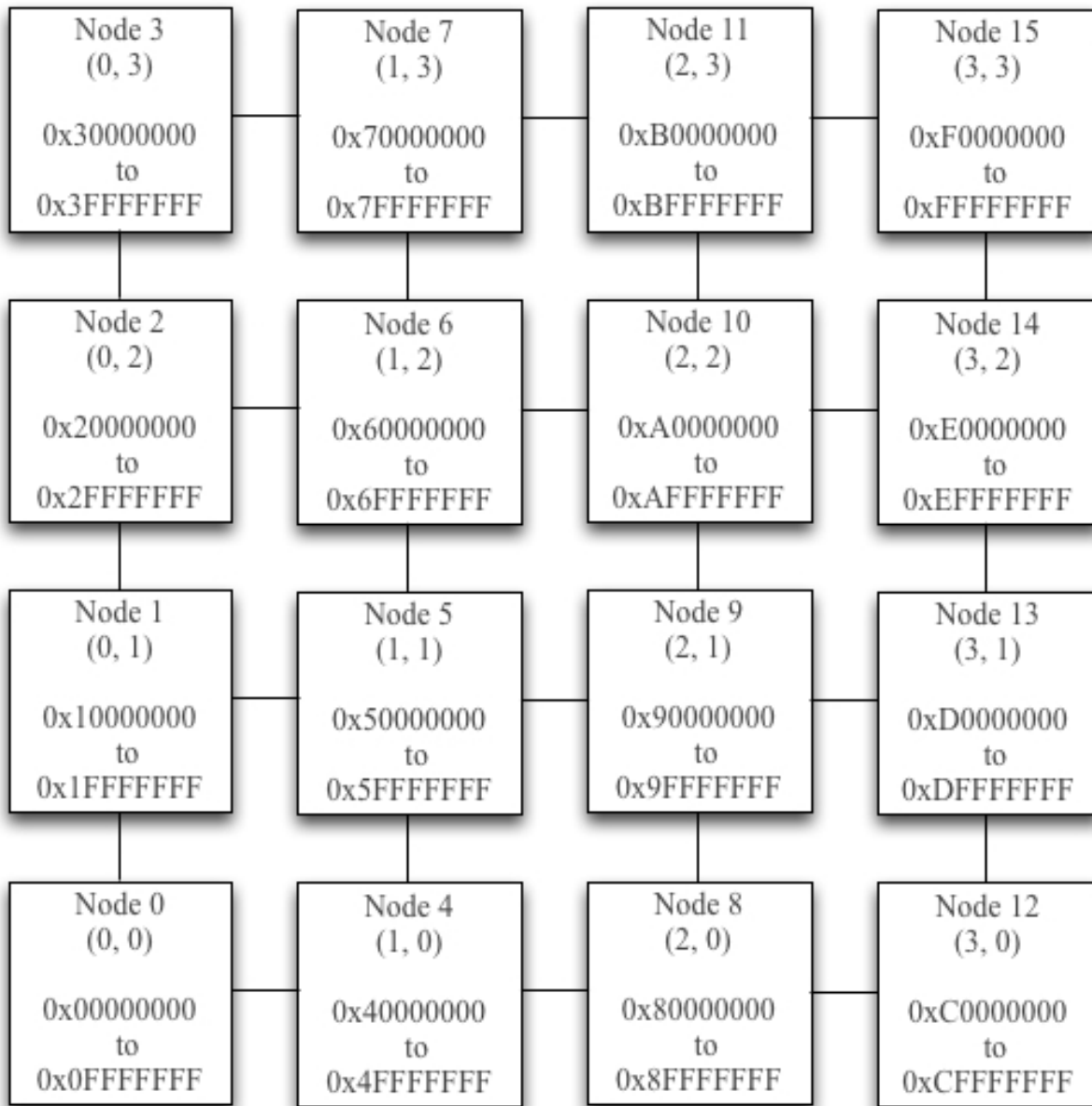

Figure 3.3: Address ranges in a 4x4 mesh

the request and ready signal for the local port becomes high simultaneously with the valid signal on the master AR east port. At this point, node 8 receives a high Valid signal on the slave AR west port. The same happens in the AR router and assuming another horizontal move the read request arrives at node 12. After 2 more transfers to the north, the data arrives at the destination node. This time, when the router decodes the address and finds out that it belongs to this node, instead of sending it out to any of the four directions it will send the data out on the master AR local port. This local port, mimics the behavior of the actual master port on the component that initiated this transaction. Assuming there is a slave component connected to the local interface, the component receives the read address and sends the data at address 0xED00804C on the R channel through the local port to the router. Along with the address, node 14 have received the location of the source of the transaction which is node 4. Therefore, it knows where to send the data. The data on R channel needs to travel from node 14 to node 4 which requires 2 west moves and 2 south moves. Immediately after node 14 sends the data from 0xED00804C, it sends the the data on the next address, 0xED00804D, since the request was for an incrementing burst of length 2. The second word carries the flag Last which informs the source that this is the last piece of data in the burst. It also bears a response signal to indicate the status of the transaction from the slave side. The second word of the burst, also takes two south moves and two west moves, but it does not necessarily take the same path as the first word. There are defined signals for ordering on the receiver side. When the last part of the burst data arrives at node 4, the slave R local port on node 4 receives the data and sends it to the master component.

3.2 Low-Level Design

In this section, a close observation of the inside of the NoC components is provided. Also, their function, and the structure of their hardware is explained.

3.2.1 Inside a Node

Inside each node there are 4 sets of full master/slave NoC interfaces connected to north, east, south, and west ports and one local interface connected to the local port. Each set of interfaces has all 5 channels of AXI on both the master side and the slave side. All signals of the same channel in a node, are connected to a router assigned to that AXI channel and based on the direction of the channel, they are placed on the incoming side of the router or the outgoing side. As a result, there are 5 routers, one for each channel, inside each node. Each router has north, east, south, west, and local incoming ports, and the same exact ports on the outgoing side. Figure 3.4 shows the inside of a node.

Based on the direction of each channel on the master side or the slave side of the protocol, they are assigned to the incoming or the outgoing ports on the router. For instance, in AW router, the slave channels are on the incoming side and the master channels are on the outgoing side, whereas in R router, the slave channels are on the outgoing side and the master channels are on the incoming side. This way, the router decides what direction an incoming data must be sent out.

3.2.2 Data Transfer

For building the channels, simple transmitter and receiver modules have been used. Each of the incoming channels are connected to a receiver module to handle the handshake between the incoming ports of the node and the incoming ports of the router. The transmitters stand between the outgoing ports of the router and the outgoing ports of the nodes. The receiver modules, also, buffer the data until the router is ready to serve them.

3.2.2.1 Receiver (RX)

Receiver module packs all the AXI signals of the channel and saves them on a register. When the router is ready, the data will be transferred and the receiver will become available for the next incoming data. Figure 3.5 demonstrates the process as a state machine. When the receiver is in **idle** state, the ready signal on the corresponding port/channel of the node becomes high. However, the

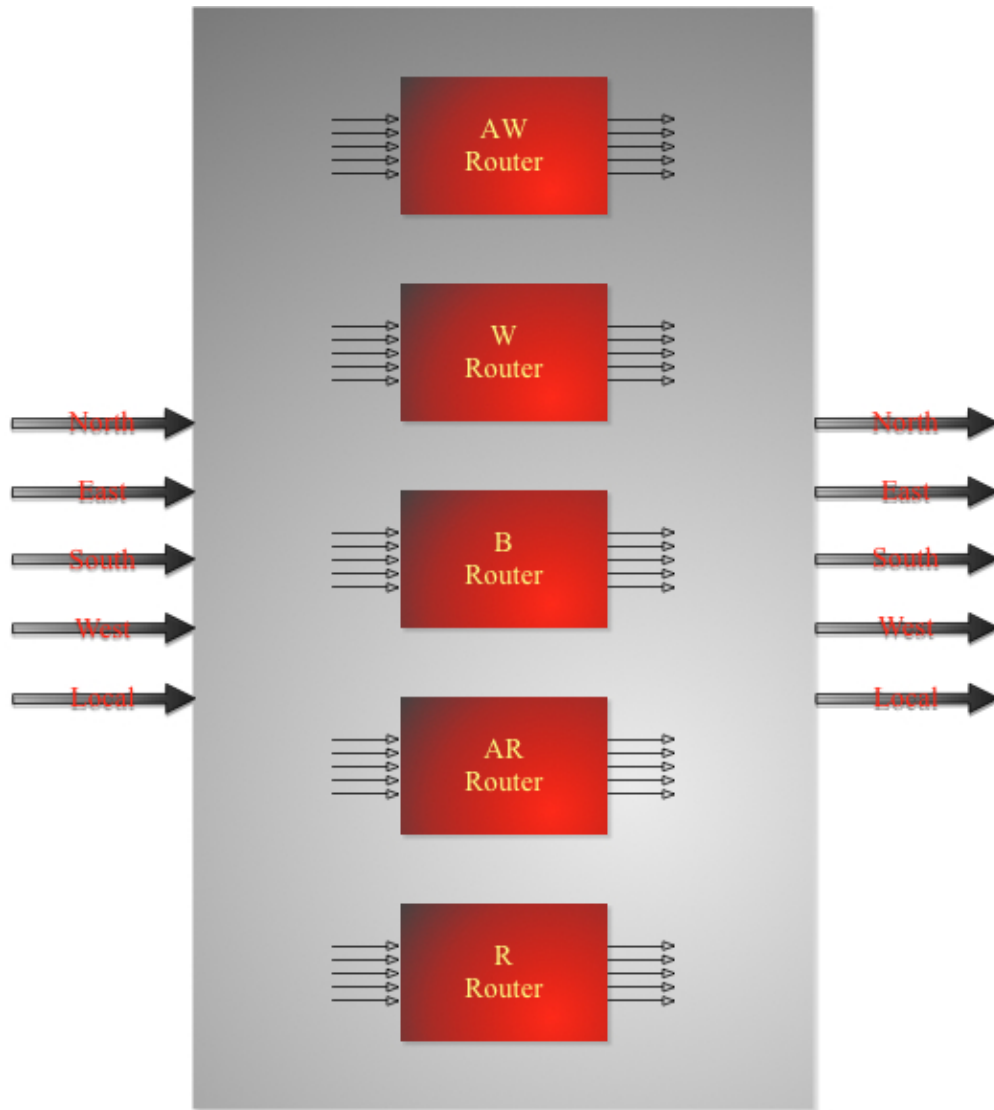

Figure 3.4: Inside of a node

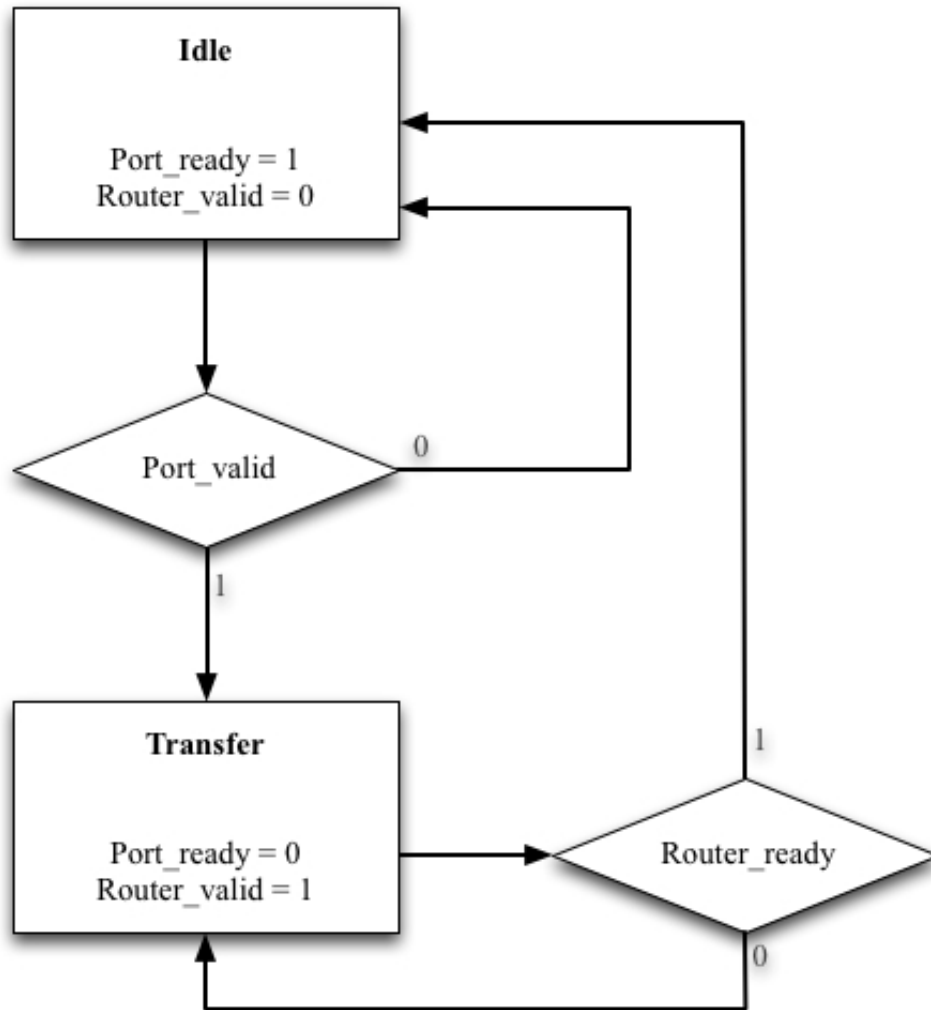

Figure 3.5: Receiver state machine

valid signal on the incoming port of the router becomes low, since there is no new data available in this state. Once an incoming data becomes available, which means the valid signal on the port/channel of the node becomes high, the receiver goes to the **transfer** state. In this state, the port/channel of the node is no longer ready to receive more data, while the valid signal becomes high for the corresponding incoming port on the router. In this state, the data is stored in a register for as long as it requires to wait for the router. When the ready signal on that incoming port of the router becomes high, it means the server is ready to serve the data. Instantly, the receiver goes back to the idle state and becomes available for more incoming data. Figure 3.6 shows what a receiver module looks like.



Figure 3.6: Receiver Module

3.2.2.2 Transmitter (TX)

The transmitter module only unpacks the data from the outgoing side of the router into the corresponding signals in the node.

3.2.3 Local Ports

The main function of network interface is to provide communication between Processing Elements (PE) and the network infrastructure [44]. One of the practical approaches of network interfaces is to communicate between the PE and router based on a standard communication protocol such as AXI [5]. The local port is responsible for the logic connection between a component and the NoC, via AXI protocol. The component can be a master, a slave, or both. A novel capability in this design is a memory controller embedded in the local port of each node, to make the local memory on the node accessible to both the component(local access) and the network(remote access). This capability would be useful in implementing local cache in the MPSoC systems.

3.2.3.1 Memory Controller

As mentioned in 3.1.3, each node is assigned a range of addresses. If the memory controller option is enabled for a node, the beginning of that address range will automatically be assigned to the local memory of the node. For instance, in the 4x4 example in figure 3.3, from 0x00000000 to

0xFFFFFFFF is assigned to node 0. If the local memory is enabled and the size of the memory is defined as 4KB, then the first 4KB (from 0x00000000 to 0x00000FFF) of the address will be assigned to the memory and the rest (from 0x00001000 to 0xFFFFFFFF) will be the interface.

The memory controller abstracts the nature of the memory access (local or remote) from the connected components. On the local port side, if the connected component requests an access and the address is in the address range of the local memory of its own node, then the memory controller accesses the memory and handles the AXI handshakes with the interface. However, if the address does not belong to the node, then the request is for a remote access and it will be passed to the router to find the path to the destination. Also, on the network side, if an incoming request arrives at the local port of a node through the router, and the address is in the address range of the local memory, then the memory controller accesses the memory and then handles the handshakes with the router. Otherwise the local port sends the request, directly to the interface. Figure 3.7 shows the connections between the memory, the interface and the network.

3.2.3.2 AXI Master Interface

If a transaction is issued by an AXI master interface such as a processor, then, when it arrives at the destination, it goes through the master interface of the local port to imitate the behavior of the source. A master interface is always connected to the slave interface of a component. For instance, if a slave component is placed on the NoC, it will be connected to the master interface of the node's local port, and therefore, the network is always master for the component.

3.2.3.3 AXI Slave Interface

When a transaction is issued by an AXI slave interface, such as an external memory controller, then at the destination, the transaction goes through the slave interface to the local port. A slave interface, similar to master, is always connected to the opposite interface of the connected component. A master component on the NoC will always be connected to the slave interface of the local port, therefore, the network is always slave for a master component. A component can have master

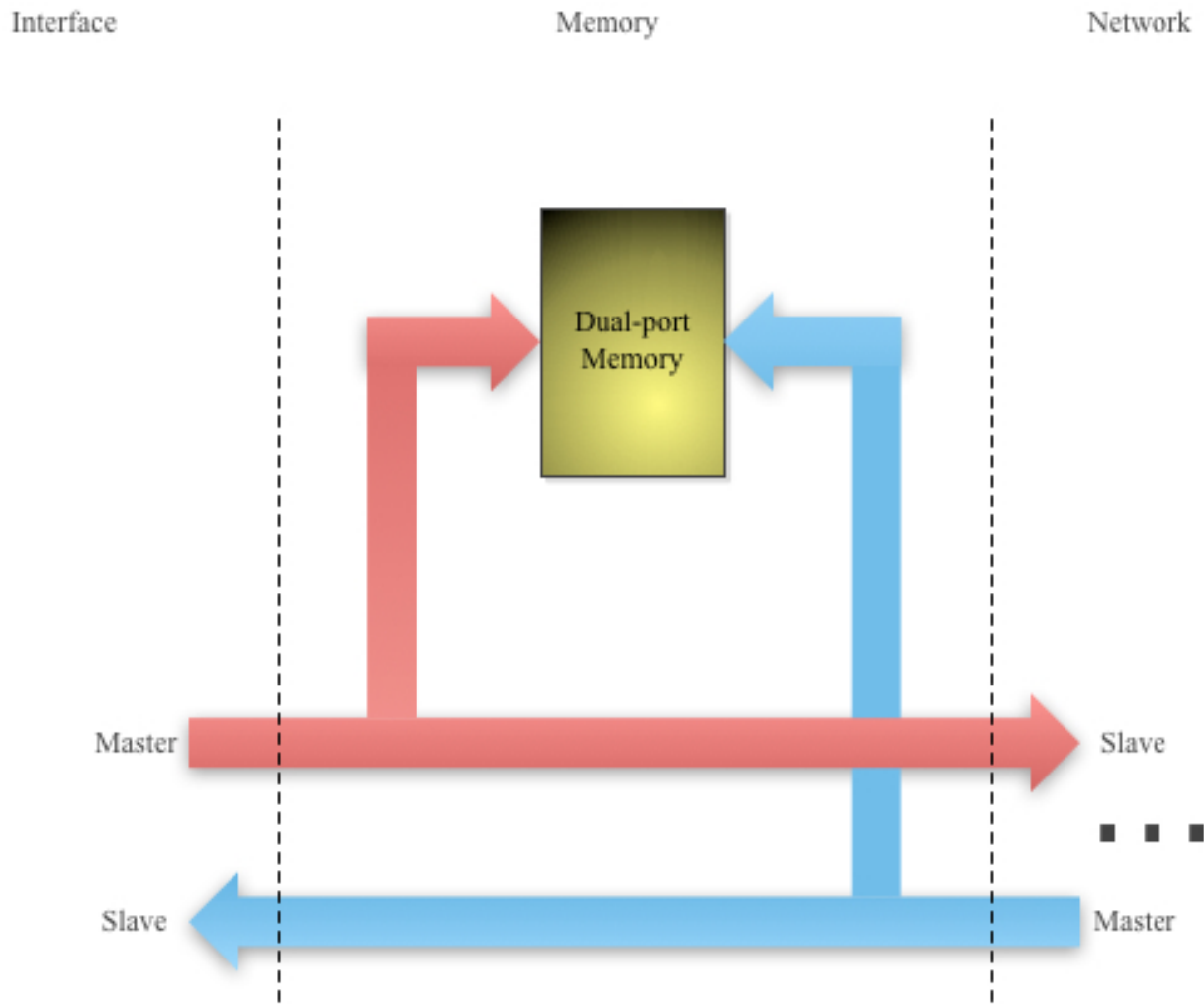

Figure 3.7: The local port and the memory controller

side and slave side at the same time and the local interface will handle both sides simultaneously.

3.2.4 Network Ports

Network ports are similar to the local ports. There are master and slave interfaces for all the directions and each interface has all 5 AXI channels. Each port on a node is connected to an opposite type port on the adjacent node in the opposite direction. As can be seen in figure 3.2, each node's master port is connected to the slave port of the adjacent port in the opposite direction. For instance, the master W channel of the east port of a node is always connected to the slave W channel of the west port of the node on its right. The direction of the signals are completely opposite between master ports and the slave ports, therefore, each master port/channel can be connected to its equivalent slave port/channel on another node. The direction of the channels are different in master ports and slave ports. In master ports, **AW**, **W**, and **AR**, are transmitter and **B** and **R** are receiver channels, whereas in slave ports, **AW**, **W**, and **AR**, are receiver ports and **B** and **R** are transmitter ports.

3.2.5 Routers

The design and implementation of a router requires the definition of a set of policies to deal with packet collision, routing, etc. A NoC router is composed of a number of input ports (connected to shared NoC ports), a number of output ports (connected to possibly other shared ports), and a switching matrix connecting the input ports to the output ports. In addition to this physical connection infrastructure, the router also contains a logic block that implements the flow control policies (routing, arbitration, etc.) and defines the overall strategy for moving data through the NoC.

A **flow control** policy characterizes the data movement along the NoC and as such it involves both global (NoC-level) and local (router-level) issues. One can ensure a deadlock-free routing, for instance, by taking specific measures in the flow control policy (by avoiding certain paths within the NoC for example). Also, the optimization of the NoC resources usage (channels, bandwidth, etc.) and the guarantees on the communication can be ensured as part of the flow control policy

(for instance, by choosing a routing algorithm that minimizes the path). Guarantees on the communication performance and quality are known as quality-of-service. Control can be centralized or distributed. In centralized control, routing decisions are made globally and applied to all nodes, with a strategy that guarantees no traffic contention. This approach avoids the need for arbitration units but requires that all nodes share a common sense of time. A possible implementation of this approach is the use of Time Division Multiplexing (TDM) mechanisms where each packet is associated to a time frame. However, NoCs typically use a distributed control, where each router makes decisions locally. Virtual Channels (VCs) implement the concept of multiplexing a single physical channel over several logically separate channels with individual and independent buffer queues. The main goal of a VC implementation is to improve performance by avoiding deadlocks, optimizing wire usage, and providing some traffic guarantees. Deadlock occurs when network resources are fully occupied and waiting for each other to be released to proceed with the communication, that is, when two paths are blocked in a cyclic fashion

The **routing algorithm** is the logic that selects one output port to forward data that has arrived at the router input. This port is selected according to the routing information available in the packet header. There are several possible routing algorithms that can be used in a NoC, each one leading to different trade-offs between performance and cost. For instance, in a deterministic routing, a packet always uses the same path between two specific nodes. Common deterministic routing schemes are Source Routing and Dimension Order Routing. In source routing, the source core specifies the route to the destination. In Dimension Order Routing routing, the packet follows the one direction first, then moves along the other direction toward the destination. In the adaptive routing, alternative paths between two nodes may be used if the original path or a local link is congested. This involves a dynamic evaluation of the link load and implies a dynamic load balancing strategy. Negative First (NF) and West First (WF) algorithms are examples of adaptive routing algorithms. In the static routing, paths between cores are defined at compilation time (of the application), while in the dynamic routing the path is defined at run-time. A unicast routing indicates that a packet has a single target whereas in the multicast routing a packet can be sent to several nodes in the

NoC simultaneously (similar to a bus) or several slaves of a master node. Similarly, a broadcast communication targets all nodes whereas a narrowcast communication initiated by a master is related to a single slave associated to it. A routing algorithm can also be classified as minimal or non-minimal. A minimal routing guarantees that the shortest path to destination is always chosen. Minimal routing algorithms are those where a bounding box is virtually present and implies that only decreasing distances from source to destination are valid. On the other hand, non minimal routing algorithms allow increasing the distance from source to destination. Routing algorithms can lead to or avoid the occurrence of deadlocks.

While the routing algorithm selects an output port for data, the **arbitration logic** implemented in the router selects one input port when multiple packets arrive at the router simultaneously. Again, one has several options to implement the arbiter: it can be distributed (one per port) or centralized (one per router), it can be based on static (fixed) or dynamic (variable) priorities among ports. A centralized arbiter optimizes the use of the router switching matrix, but may lead to higher latency whereas the distributed approach optimizes the latency. Arbitration logic also defines whether the network assumes a delay or a loss communication model. In the delay model, packets can be delayed, but never dropped. In the loss model a packet can be dropped as a solution, for instance, to a congestion situation. In this case, retransmission logic must be implemented as well.

The **switching** defines how the data is transmitted from the source node to the target node. In the circuit switching approach the whole path (including routers and channels) from source to node is previously established (by the header) and reserved for the transmission of the whole packet. The payload is not sent until the whole path has been reserved. This can increase latency, but once the path is defined, this approach can give some guaranteed throughput. In the packet-based switching approach on the other hand, all flits of the packet are sent as the header establishes the connection between routers. Still in this model the designer can choose between different buffering and forward strategies that impact the overall NoC traffic (storing the whole packet in each router before establishing the connection to the next router or sending the flits in a pipeline

mode for instance). In the store-and-forward strategy, the node stores the complete packet before forwarding it to the next node in the path. In this strategy one must ensure that the buffer size at each node is sufficient to store the whole packet or the packet can be stalled. In the wormhole strategy, on the other hand, the node makes the routing decision and forwards the packet as soon as the header arrives. The subsequent flits follow the header as they arrive. This reduces the latency within the router, but in case of packet stalling, many links risk to be locked at once. The virtual-cut-through mechanism is similar to the wormhole approach but, before forwarding the first data flit to the next node in the path, the node waits for a confirmation that the whole packet can be accepted by the next node. Thus, in case of stalling, no links are affected, only the current node.

The **buffering** policy is the strategy used to store information in the router when there is congestion in the network and a packet cannot be forwarded right away. The buffering strategy (number, location and size of the buffers), has an important impact on the network traffic and, therefore, on the NoC performance. In addition, the buffers are responsible for a large portion of the router area. One can have a single buffer in the router, shared by all input ports, or one can have one buffer per port (input or output). The main advantage of the first approach is the area optimization, but the control can be more complex and additional care must be taken to deal with buffer overflow. In the distributed approach, each input port has its own buffer and the most common implementation is in the form of a FIFO, although other implementations are also possible. Distributed output buffers are also possible, but they tend to be less efficient because several input ports may need to store data in a single structure.

In this design, VC type distributed flow control is used and the routers make the decision locally. The routing algorithm is adaptive and it depends on the traffic of the channels. The arbitration logic is distributed so each channel has its own arbitration, and the arbitration priorities are fixed. This design uses packet switching and considering a burst transaction, a packet, then the packet switching uses the wormhole strategy for storing and forwarding. Each part of the burst data is served individually and all the pieces do not necessarily take the same path. The buffering policy, as mentioned in 3.2.2.1 is storing the data at the receiver side of each transfer, until further

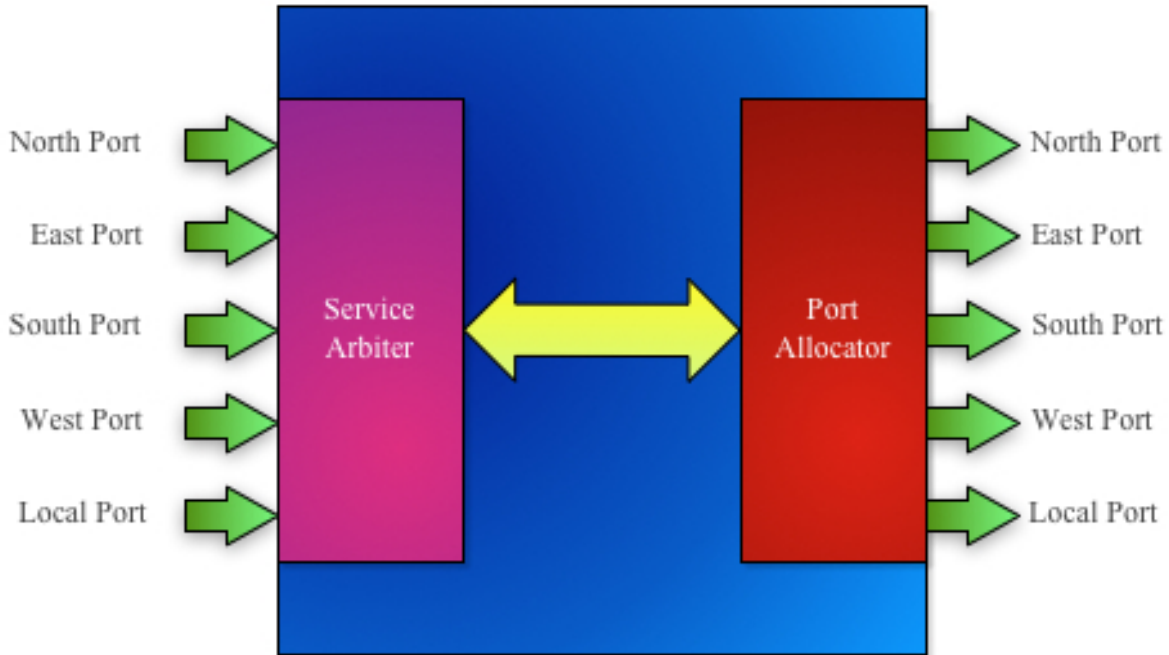

Figure 3.8: The structure of the router

action moves are possible.

Inside the router there is a service arbiter to handle the scheduling when there are more than one request on a channel. Then, the port allocator module makes the routing decision and sends the data out. Figure 3.8 shows the structure of the router.

3.2.5.1 Service Arbiter

The service arbiter is responsible for scheduling the service in the router. There are 2 possible scenarios. The more simple one is when there is only one request at a time. In this case, the router responds to the request instantly by reading the data from the channel. The more complicated scenario is when there are more than one request and they need to be scheduled one by one. There is a defined priority sequence for the incoming ports to the router. North, east, south, west, and then local. When the service arbiter detects multiple requests, it immediately responds to the channel with the highest priority. When serving that channel ends, then the arbiter checks all the other incoming channels starting with the next channel in the priority list. If there is a request, the service arbiter stops to serve the channel, otherwise, it will check the next channel. After finishing

the routing service for one incoming channel, the arbiter always checks the next channel, even if there are other requests waiting in the queue of the same channel. This method, prevents the channels from starvation. For instance, if the incoming ports north, west, and local, request service on the AW channel router, the north channel will be served immediately. When it's finished, the arbiter checks the east channel and then south channel (each channel test happens in one clock cycle) and it skips them because there are no requests. When the arbiter reaches the west channel it stops and serves the west channel. When this one is over, then there will be only one request on the local port and the arbiter, schedules a single request by jumping directly to that request.

3.2.5.2 Port Allocator

When the service arbiter picks the incoming port, then a decoder checks the destination address on the chosen port and it will calculate the relative location of the destination node to the current node. Then all the information goes to the port allocator. The port allocator decides from which outgoing port the current data must leave the node. This is where the routing algorithm is used. Assuming there is no traffic, the routing algorithm is Dimension-Order Routing (DOR) where moving horizontally has priority over moving vertically.

$$Direction = \begin{cases} East & X_{destination} > X_{current} \\ West & X_{destination} < X_{current} \\ North & X_{destination} = X_{current} \text{ and } Y_{destination} > Y_{current} \\ South & X_{destination} = X_{current} \text{ and } Y_{destination} < Y_{current} \\ Local & X_{destination} = X_{current} \text{ and } Y_{destination} = Y_{current} \end{cases}$$

However, when the data has the option of moving both horizontally and vertically to reach the destination, and the horizontal move is not possible (the channel is in use because of traffic) it will choose the vertical move over the horizontal move. This is the adaptive characteristic of the routing algorithm.

3.2.6 Top Level

After designing all the pieces, a top-level design is required to create the mesh network. The top level design instantiates the nodes, customizes them, and makes the proper connections between them. For instance, if the goal is building a 4x4 mesh, the top level design instantiates 16 nodes as a 2 dimensional matrix. Then, based on the user configurations, it customizes the nodes by adding local memory of the defined size to the defined nodes, and adding master local interface, slave local interface, or both, to each node based on the defined characteristics of the node. Finally, for the mesh to function properly, the proper connection between the adjacent nodes must be made. A master port is always connected to a slave port of the same channel in its adjacent node. When the mesh is created, the top level design, maps the local ports to the input/output ports.

Creating each top level design, even by taking advantage of the multi-dimensional arrays of signals and loops, is a time-consuming process. In order to ease the process of creating NoCs with a particular design scenario, there is a script that gathers information from the user about the size of the mesh, the size of each dimension, and the customizations on each node, and generates the top level design.

3.3 Implementation

This NoC was designed in a top-down approach starting with the mesh. The mesh was broken down to nodes, and then in each node the routers, channel interfaces and local-port interface were designed. The channels were divided into the master side and the slave side and each side was divided into 5 different AXI channels. Then each channel was designed using transmitter and receiver modules. The tasks in the routers were distributed between the service arbiter, the port allocator and a decoder for the destination address. The local ports were designed using dual-port memory blocks and the controller logic for the memory controller and the interface. After the design phase, the modeling of the design was done using VHDL. The components were modeled from the bottom up. Each small component was modeled, tested and verified. Then the small com-

ponents were integrated to build larger components and did the same testing and verification parts. At the end, to test and verify the functionality of the NoC, more elaborate tests were designed. The design was implemented on Xilinx Virtex-7 FPGAs using VC707 boards and the version 14.3 of the tools.

Chapter 4

Results

4.1 Verification

For this design, directed verification technique was used. The verification was done both at the component level, after each component was designed and modeled, and at the system level when the entire system was designed, and modeled. Although Constrained Random Testing (CRT) verification technique was not used, the directed verification plan was designed carefully to cover as much of the corner cases as possible. The tests were designed as VHDL test-benches and the mathematical functions inside were used to generate different cases based on the scenario of the test. The waveforms were observed in ModelSim. In order to automate the testing process, the ModelSim Tcl scripts were created and also Make files were used to run them in the right sequence. At the debugging process, both at the component level and the system level, the tests were run several times, and without the automated testing, the testing and verification process would have been excessively time-consuming.

4.1.1 Component Verification

After finishing each component, a test-bench was designed specifically to verify the function of that component. Some of the components were small enough so it was possible to test every possible case. For instance, in the receiver, combining all the possible cases for the handshakes on both sides or in the port arbiter, and testing the entire range of the 32 bit address on the design was feasible. For larger designs, such as a full master/slave AXI channel, covering all the possibilities was not feasible. For cases like this, as much of the corner cases as possible were tested on each channel for several scenarios. For the AXI channel, different situations on each single channel were tried simultaneously with the other channels. Verifying each component means the component functions exactly as desired. After integrating the small components, the functionality becomes

more complex and designing the verification plan becomes more difficult and time-consuming.

4.1.2 System Verification

System verification was done after a complete NoC with the already verified components was created. At this stage the functionality of the system as a whole, was tested. The tests started with simpler scenarios and after each phase, the complexity of the scenarios were increased. In each phase, bugs were found and fixed until the system was functioning correctly. A 4x4 mesh was the subject of the system-level verification to have a reasonable balance between having a system small enough to be observed clock-cycle by clock-cycle and large enough to implement all the possible complexities in a test scenario.

4.1.2.1 Phase One

In this phase, two nodes in the network are picked. Then, from the local interface of the first node, a write transaction is initiated to be sent to the second node. At the second node, if the signals arrive correctly, a process emulates a slave component and stores the write data in the requested address and the correct response signals are sent back to the source. This process is done for burst lengths from 1 to 255 and for addresses both in the local memory range and the interface range. A table in the source node stores all the sent addresses and the data associated with them. Then the same source node reads the written data from the same destination in a different order and compares the read data to the table and checks if the correct data has been read from the destination. The same test is repeated for several pairs of nodes. The completion of this phase verified that single transactions in a NoC, with no traffic caused by other nodes, work correctly.

4.1.2.2 Phase Two

Phase two added the effect of traffic to phase one. In this phase, a node is picked as the source of the transactions. Then, from the selected node, write transactions were sent to all the other nodes in the system. A table in the source node is assigned to each node in the system. This table stores

the addresses that are used in the write transactions and the data associated to those addresses. To make the verification easier, a particular range of data is assigned to each node so when they are read back, they are identifiable. The transactions cover all the possible burst lengths. Then, the source node reads data from every node in the system and compares the read data to the content of the table. The test was repeated for several nodes as the source. The completion of this phase verified that in a network with a light traffic, transactions reach their destination with no fault.

4.1.2.3 Phase Three

Phase three is a more complex version of phase 2 with heavy traffic. In this phase, every single node in the NoC is a source node such as the one described in phase two. Each node sends write transactions to all the other nodes in the network, and they all work simultaneously. Then each source reads back from all the other nodes and compares it to its table. This process creates a heavy traffic in the system. This test, evaluates the master side, of the interface, the slave side, and also the memory controller. The completion of this phase verified that in a network with heavy traffic, transactions reach their destination with no fault.

4.2 Resource Utilization

To analyze the resource utilization of the NoC, different sized of mesh with different configurations were synthesized for Xilinx Virtex-7 FPGA. Table 4.1 shows the synthesis results for 2x2, 3x3, 4x4, 5x5, 6x6, and 7x7 meshes and it shows the resource utilization for flop-flops, LUTs and Block RAMs. Also, figure 4.1 visualizes the results. The growth of the resource utilization is almost linear with the growth of the number of the nodes. Also, the systems with local memory controller enabled use slightly more resources than the ones without the controller. As an analogy, the resource utilization between a 4x4 NoC and a bus-based MPSoC system[10] of the same scale, synthesized for the same platform were compared. Both the NoC and the bus-based system utilize 3% of the flip-flops. The NoC uses 11% of the LUTs while the bus-based system uses only 8.5%. The comparison for block RAMs are irrelevant because the size of the memories can vary.

	Resource Utilization					
	4K Local memory			No Local memory		
	Flop-flops	LUTs	Block RAMs	Flop-flops	LUTs	Block RAMs
2x2	0	2	2	0	1	0
3x3	1	6	4	1	5	0
4x4	3	11	6	3	9	0
5x5	6	19	13	5	16	0
6x6	9	29	19	8	24	0
7x7	12	40	26	11	34	0

Table 4.1: Resource utilization for different sizes of mesh

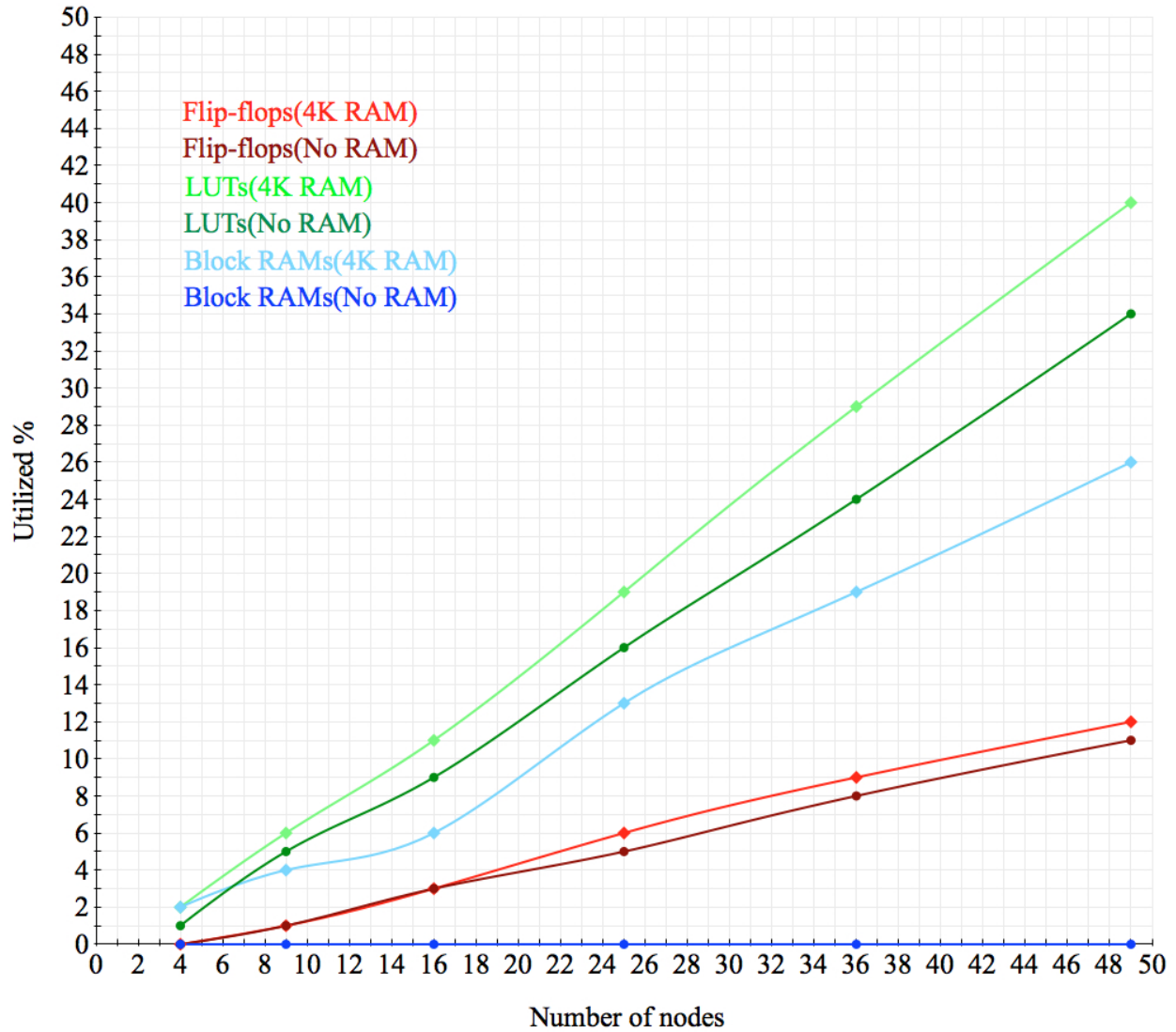

Figure 4.1: The resource utilization for different sizes of mesh

4.3 Time Analysis

In this section, the performance of the NoC is analyzed by observing the time it takes for a transaction to finish which is directly related to the length of the path between the source and the destination. Also, the time it takes for data to traverse from a node to the adjacent node is calculated. For this experiment, a 7x7 mesh was created. A node was selected as source and several other nodes as destination. The source node is node 0 (the bottom left corner of the mesh). To make the result of the experiment deterministic, the data was transferred without any interfering traffic. When there is no interfering traffic in the way, the routers always respond instantly without making the transaction wait in line until another transaction is served. Each transaction is a remote read of size 1 (no burst). At the source node, a process in the test-bench initiates read transactions to go to different nodes. In all the other nodes a process is always waiting for read requests and when it receives one, it responds instantly. This way, only the latency of the network is measured without the effect of the latency of the components connected to the NoC. The source process produces 12 different transactions for 12 different destinations in the mesh. The destination of each transaction is different than the other one. The distance from the source to the destination varies from 1 hop to 12 hops (longest path in a 7x7 mesh). Table 4.2 shows the results. Each transaction consists of a AR request from the source to destination and a R data coming back from the destination node to node 0. The results show that in all cases, passing through each node (including source node) takes 5 clock cycles and it takes one clock cycle for each local interface to transfer data between the component and the NoC. The following equation was extracted from table 4.2 and it shows the latency of the path.

Of course this observation is an ideal case and when there is traffic in the network, the delays increase. In MPSoCs, nodes with higher volume of communication must be placed as close as possible to achieve the minimum delay in the system. For instance, if the main processor and a memory subsystem in a MPSoC, communicate frequently, the optimal delay is achieved by placing them in adjacent nodes in the mesh.

Length of the path (hops)	Latency(clock cycles)
1	22
2	32
3	42
4	52
5	62
6	72
7	82
8	92
9	102
10	112
11	122
12	132

Table 4.2: Number of clock cycles a transaction takes to complete in a NoC with no interfering traffic

$$Latency = 2 \times (Numberofhops + 1) \times 5 \quad (4.1)$$

After this experiment, the effect of interfering traffic on the latency was evaluated. In order to calculate this, in the final phase of verification when there is a considerable amount of traffic in the entire network, for each specific path length, 10 random samples of different paths at different times was taken. The results can be seen in table 4.3. for the same path lengths, there are 10 latency samples (L1 to L10) and the last column is the average of each path length. Figure 4.2 shows a comparison between a transaction in an ideal environment with no interfering traffic and a transaction in a network with a heavy traffic. As can be seen, the network, handles traffic well enough that there is a small difference between the 2 cases.

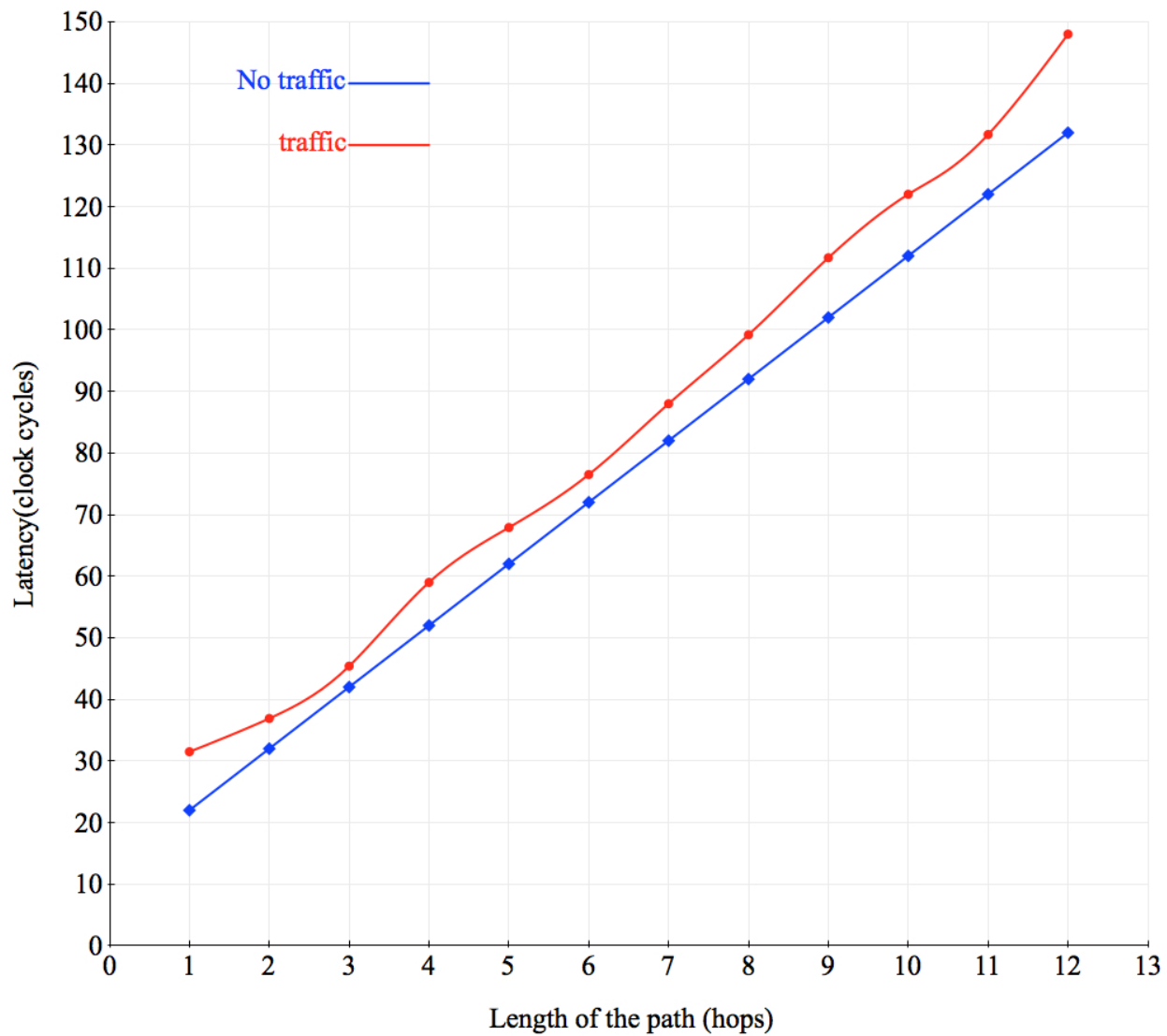

Figure 4.2: Latency with and without interfering traffic

Path (hops)	Latency(clock cycles)										Average
	L1	L2	L3	L4	L5	L6	L7	L8	L9	L10	
1	23	29	51	42	22	37	39	24	22	26	31.5
2	38	38	36	34	37	37	33	36	40	40	36.9
3	42	48	49	44	43	42	53	42	45	46	45.4
4	55	64	63	54	57	65	67	58	55	52	59
5	65	64	77	62	79	65	68	68	67	64	67.9
6	72	74	75	76	72	74	93	77	73	79	76.5
7	89	84	95	83	82	83	91	84	88	101	88
8	100	95	99	93	92	104	112	99	101	97	99.2
9	111	120	104	118	109	117	109	110	103	116	111.7
10	132	117	119	121	124	116	115	137	121	118	122
11	127	142	124	126	127	123	153	138	129	128	131.7
12	145	176	144	139	136	139	153	155	146	151	148.4

Table 4.3: Number of clock cycles a transaction takes to complete in a NoC with interfering traffic

Chapter 5

Conclusion

With the growth of the number of components in SoCs, and more specifically the number of processors in MPSoCs, having reliable, robust and scalable interconnect has become a major part of every design. The most important issue in designing interconnect, is choosing an interconnect based on the requirements of the system. The volume of the traffic, the characteristics of the transactions, and the hardware infrastructure, together define what kind of interconnect is suitable for the system. In multi-processor systems, the interconnect must provide specific services to the clients (which are mostly processors) as efficiently as possible.

This project was designed based on the characteristics of a multi-processor system implemented on Xilinx FPGAs. The system is called Hthreads [10] and it uses thread-based programming to take advantage of the multiprocessing characteristics of the system by scheduling threads to be executed on PEs in parallel. The type of the communications are normally read/writes of small chunks of data between the nodes, and occasionally the DMA type communication of bigger chunks between the host processor and the slave processors when a thread is assigned to a PE. This NoC was initially designed only for AXI-Lite type (no burst) communication. Then to take advantage of the burst capabilities of AXI protocol for DMA, the system was upgraded to support burst. The NoC can handle more traffic than the current Hthread system can produce, but the future generations of Hthreads with higher volume of interaction between the PEs will require such a capable interconnect.

The main characteristics of this interconnect that make it suitable specifically for MPSoC systems are as follows:

- An important characteristic that the majority of multi-processor systems have in common is having **local memory** for each PE. The local memory can be interpreted as a private cache or just a local memory space for the processor. This design provides an embedded support

for local memory. The memory is mapped to the node's address space and a smart memory controller compiles the transactions into series of memory accesses and also provides the feedback signals for the PE

- several aspects of the transactions were **abstracted** to make it easier for the clients to communicate with the NoC. The first aspect was the remoteness or the locality of the transaction. From the network client's perspective, there is no difference between a remote access and a local access because the transactions look the same. What differentiates a local access from a remote access is , to which address domain the transaction address belongs. The other aspect was whether the receiver of the transaction was another network client or a memory. The memory controller makes the response from a memory access look exactly the same as the response from an access to another client.
- This NoC is **customizable** in several areas. The network interface can be customized to include master interface, slave interface, or both, on each individual node. Also, each node can have the local memory available or disable the memory controller based on the requirements of the node. In addition, the size of the local memory is customizable for each single node.

5.1 Research Contributions

The purpose of this research was to provide a scalable and reliable mesh Network-on-Chip for MPSoCs, as well as the support for embedded local memory on the nodes. This platform allows the components on a MPSoCs to communicate with each other by assigning an address range to each component and abstracting the difference between the way local accesses and remote accesses are processed in the network interface. Some of the contributions of this project include:

- Designing a mesh Network-on-Chip with AMBA AXI interface.
- Supporting embedded local memory for nodes, interfacing it both to the interface and to the rest of the network, and automatically assigning the memory to the beginning part of the node's address range

- Adding customizability to each node's interface so they can have master side, slave side, or both, and also enabling or disabling the local memory controller.
- Designing thorough directed testbenches to verify the system and cover as much cases as possible

5.2 Future Work

Designing the script to create the top-level design has made experimenting with different sizes of mesh with different configurations very easy. As a part of the future work, The script can be connected to a front-end web interface to be accessed online easily, without running the script and passing the system configurations to it. Moreover, the same architecture can be used for other topologies. The nodes are designed with 4 network links to be placed in a mesh network. With slight adjustment in the routers and the nodes, the same architecture can be used to create a ring or a tree. Finally, the router can be optimized to spend less sequences on the decision making process. There needs to be different tests to find an optimum spot in the trade-off between the number of sequences and the resource utilization in the router.

References

- [1] P. Abad, P. Prieto, L.G. Menezes, A. Colaso, V. Puente, and J.-A. Gregorio. Topaz: An open-source interconnection network simulator for chip multiprocessors and supercomputers. In *Networks on Chip (NoCS), 2012 Sixth IEEE/ACM International Symposium on*, pages 99–106, 2012.
- [2] V. Agarwal, M. S. Hrishikesh, S.W. Keckler, and D. Burger. Clock rate versus ipc: the end of the road for conventional microarchitectures. In *Computer Architecture, 2000. Proceedings of the 27th International Symposium on*, pages 248–259, 2000.
- [3] N. Alfaraj, Junjie Zhang, Yang Xu, and H.J. Chao. Hope: Hotspot congestion control for clos network on chip. In *Networks on Chip (NoCS), 2011 Fifth IEEE/ACM International Symposium on*, pages 17–24, 2011.
- [4] A. Allan, D. Edenfeld, W.H. Joyner, A.B. Kahng, M. Rodgers, and Y. Zorian. 2001 technology roadmap for semiconductors. *Computer*, 35(1):42–53, 2002.
- [5] ARM. AMBA AXI and ACE Protocol Specification. <http://infocenter.arm.com/help/index.jsp?topic=/com.arm.doc.set.amba/index.html>. Last accessed February 14, 2014.
- [6] Y. Ben-Itzhak, I. Cidon, and A. Kolodny. Delay analysis of wormhole based heterogeneous noc. In *Networks on Chip (NoCS), 2011 Fifth IEEE/ACM International Symposium on*, pages 161–168, 2011.
- [7] L. Benini and G. De Micheli. Networks on chips: a new soc paradigm. *Computer*, 35(1):70–78, 2002.
- [8] L. Benini and G. De Micheli. Networks on chips: a new soc paradigm. *Computer*, 35(1):70–78, 2002.
- [9] L.P. Carloni, P. Pande, and Yuan Xie. Networks-on-chip in emerging interconnect paradigms: Advantages and challenges. In *Networks-on-Chip, 2009. NoCS 2009. 3rd ACM/IEEE International Symposium on*, pages 93–102, 2009.
- [10] E. Cartwright, A. Fahkari, S. Ma, C. Smith, M. Huang, D. Andrews, and J. Agron. Automating the design of mlut mpsohc fpgas in the cloud. In *Field Programmable Logic and Applications (FPL), 2012 22nd International Conference on*, pages 231–236, 2012.
- [11] Steve Leibson Chris Rowen. *Engineering the Complex SOC: Fast, Flexible Design with Configurable Processors*. Prentice Hall PTR, 2004.
- [12] Theo A C M Claassen. An industry perspective on current and future state of the art in system-on-chip (soc) technology. *Proceedings of the IEEE*, 94(6):1121–1137, 2006.
- [13] W.J. Dally and B. Towles. Route packets, not wires: on-chip interconnection networks. In *Design Automation Conference, 2001. Proceedings*, pages 684–689, 2001.

- [14] M. Daneshtalab, M. Ebrahimi, P. Liljeberg, J. Plosila, and H. Tenhunen. A low-latency and memory-efficient on-chip network. In *Networks-on-Chip (NOCS), 2010 Fourth ACM/IEEE International Symposium on*, pages 99–106, 2010.
- [15] M.A.A. El Ghany, M.A. El-Moursy, and M. Ismail. High throughput architecture for cliche; network on chip. In *SOC Conference, 2009. SOCC 2009. IEEE International*, pages 155–158, 2009.
- [16] R. Ho, K.W. Mai, and M.A. Horowitz. The future of wires. *Proceedings of the IEEE*, 89(4):490–504, 2001.
- [17] R. Holsmark, S. Kumar, M. Palesi, and A. Mejia. Hira: A methodology for deadlock free routing in hierarchical networks on chip. In *Networks-on-Chip, 2009. NoCS 2009. 3rd ACM/IEEE International Symposium on*, pages 2–11, 2009.
- [18] M. Horowitz and W. Dally. How scaling will change processor architecture. In *Solid-State Circuits Conference, 2004. Digest of Technical Papers. ISSCC. 2004 IEEE International*, pages 132–133 Vol.1, 2004.
- [19] Y. Hoskote, S. Vangal, A. Singh, N. Borkar, and S. Borkar. A 5-ghz mesh interconnect for a teraflops processor. *Micro, IEEE*, 27(5):51–61, 2007.
- [20] Cheng-Ta Hsieh and M. Pedram. Architectural energy optimization by bus splitting. *Computer-Aided Design of Integrated Circuits and Systems, IEEE Transactions on*, 21(4):408–414, 2002.
- [21] A. Iyer and D. Marculescu. Power and performance evaluation of globally asynchronous locally synchronous processors. In *Computer Architecture, 2002. Proceedings. 29th Annual International Symposium on*, pages 158–168, 2002.
- [22] Axel Jantsch and Hannu Tenhunen, editors. *Networks on Chip*. Kluwer Academic Publishers, Hingham, MA, USA, 2003.
- [23] S. Jovanovic, C. Tanougast, S. Weber, and C. Bobda. A new deadlock-free fault-tolerant routing algorithm for noc interconnections. In *Field Programmable Logic and Applications, 2009. FPL 2009. International Conference on*, pages 326–331, 2009.
- [24] H. Kariniemi and J. Nurmi. On-line reconfigurable xgft network-on-chip designed for improving the fault-tolerance and manufacturability of the mpsoC chips. In *Field Programmable Logic and Applications, 2006. FPL '06. International Conference on*, pages 1–6, 2006.
- [25] Kangmin Lee, Se-Joong Lee, and Hoi-Jun Yoo. Low-power network-on-chip for high-performance soc design. *Very Large Scale Integration (VLSI) Systems, IEEE Transactions on*, 14(2):148–160, 2006.
- [26] M. Lodde, J. Flich, and M.E. Acacio. Heterogeneous noc design for efficient broadcast-based coherence protocol support. In *Networks on Chip (NoCS), 2012 Sixth IEEE/ACM International Symposium on*, pages 59–66, 2012.

- [27] Zhonghai Lu. Design and analysis of on-chip communication for network-on-chip platforms. Master's thesis, KTH, 2007.
- [28] P. Mahr and C. Bobda. Reducing communication costs on dynamic networks-on-chip through runtime relocation of tasks. In *Rapid System Prototyping (RSP), 2012 23rd IEEE International Symposium on*, pages 177–182, 2012.
- [29] J.W. McPherson. Reliability challenges for 45nm and beyond. In *Design Automation Conference, 2006 43rd ACM/IEEE*, pages 176–181, 2006.
- [30] N. Michael, M. Nikolov, Ao Tang, G.E. Suh, and C. Batten. Analysis of application-aware on-chip routing under traffic uncertainty. In *Networks on Chip (NoCS), 2011 Fifth IEEE/ACM International Symposium on*, pages 9–16, 2011.
- [31] M. Millberg, E. Nilsson, R. Thid, S. Kumar, and A. Jantsch. The nostrum backbone—a communication protocol stack for networks on chip. In *VLSI Design, 2004. Proceedings. 17th International Conference on*, pages 693–696, 2004.
- [32] T. Mudge. Power: a first-class architectural design constraint. *Computer*, 34(4):52–58, 2001.
- [33] B. Osterloh, H. Michalik, B. Fiethe, and K. Kotarowski. Socwire: A network-on-chip approach for reconfigurable system-on-chip designs in space applications. In *Adaptive Hardware and Systems, 2008. AHS '08. NASA/ESA Conference on*, pages 51–56, 2008.
- [34] P.P. Pande, C. Grecu, M. Jones, A. Ivanov, and R. Saleh. Performance evaluation and design trade-offs for network-on-chip interconnect architectures. *Computers, IEEE Transactions on*, 54(8):1025–1040, 2005.
- [35] Michael K. Papamichael and James C. Hoe. Connect: Re-examining conventional wisdom for designing nocs in the context of fpgas. In *Proceedings of the ACM/SIGDA International Symposium on Field Programmable Gate Arrays, FPGA '12*, pages 37–46, New York, NY, USA, 2012. ACM.
- [36] Leena Singh Prakash Rashinkar, Peter Paterson. *System-on-a-Chip Verification*. Springer, 2001.
- [37] Yue Qian, Zhonghai Lu, and Wenhua Dou. Analysis of worst-case delay bounds for best-effort communication in wormhole networks on chip. In *Networks-on-Chip, 2009. NoCS 2009. 3rd ACM/IEEE International Symposium on*, pages 44–53, 2009.
- [38] V. Raghunathan, M.B. Srivastava, and R.K. Gupta. A survey of techniques for energy efficient on-chip communication. In *Design Automation Conference, 2003. Proceedings*, pages 900–905, 2003.
- [39] E. Salminen, A. Kulmala, and T.D. Hamalainen. On network-on-chip comparison. In *Digital System Design Architectures, Methods and Tools, 2007. DSD 2007. 10th Euromicro Conference on*, pages 503–510, Aug 2007.

- [40] Keun Sup Shim, Myong Hyon Cho, M. Kinsky, T. Wen, M. Lis, G.E. Suh, and S Devadas. Static virtual channel allocation in oblivious routing. In *Networks-on-Chip, 2009. NoCS 2009. 3rd ACM/IEEE International Symposium on*, pages 38–43, 2009.
- [41] A.T. Tran, D.N. Truong, and B.M. Baas. A gals many-core heterogeneous dsp platform with source-synchronous on-chip interconnection network. In *Networks-on-Chip, 2009. NoCS 2009. 3rd ACM/IEEE International Symposium on*, pages 214–223, 2009.
- [42] Danyao Wang, N.E. Jerger, and J.G. Steffan. Dart: A programmable architecture for noc simulation on fpgas. In *Networks on Chip (NoCS), 2011 Fifth IEEE/ACM International Symposium on*, pages 145–152, 2011.
- [43] Jian Wang, Yubai Li, Qicong Peng, and Taiqiu Tan. A dynamic priority arbiter for network-on-chip. In *Industrial Embedded Systems, 2009. SIES '09. IEEE International Symposium on*, pages 253–256, 2009.
- [44] C.A. Zeferino, M.E. Kreutz, and A.A. Susin. Rasoc: a router soft-core for networks-on-chip. In *Design, Automation and Test in Europe Conference and Exhibition, 2004. Proceedings*, volume 3, pages 198–203 Vol.3, 2004.
- [45] Li-Rong Zheng. *Design, analysis and integration of mixed-signal systems for signal and power integrity*. PhD thesis, KTH, 2001.