

2013

Time of day preferences and resource allocation

Alicia Marie Briganti

Louisiana State University and Agricultural and Mechanical College

Follow this and additional works at: https://digitalcommons.lsu.edu/gradschool_dissertations



Part of the [Psychology Commons](#)

Recommended Citation

Briganti, Alicia Marie, "Time of day preferences and resource allocation" (2013). *LSU Doctoral Dissertations*. 1632.
https://digitalcommons.lsu.edu/gradschool_dissertations/1632

This Dissertation is brought to you for free and open access by the Graduate School at LSU Digital Commons. It has been accepted for inclusion in LSU Doctoral Dissertations by an authorized graduate school editor of LSU Digital Commons. For more information, please contact gradetd@lsu.edu.

TIME OF DAY PREFERENCES AND RESOURCE ALLOCATION

A Dissertation

Submitted to the Graduate Faculty of the
Louisiana State University and
Agricultural and Mechanical College
in partial fulfillment of the
requirements for the degree of
Doctor of Philosophy

in

The Department of Psychology

by

Alicia Marie Briganti

B.A., Louisiana State University, 2003

M.A., University of Texas at Austin, 2007

August 2013

Acknowledgements

First, I wish to thank Emily M. Elliott, my advisor and dissertation supervisor, for her guidance, support, and encouragement during the past five years. I truly appreciate her effort in mentoring me, and I cannot thank her enough for teaching me so much about research, teaching, and life in general. I am also appreciative of the time and effort that my dissertation committee members, Jason Hicks, Katie Cherry, Janet McDonald, and Cynthia DiCarlo, have spent on my behalf. I am grateful for their contributions and for truly challenging me throughout this process, even if it was a difficult journey. I have learned so much more because of their efforts. I thank, too, my former advisor, Leslie Cohen, who was my first mentor. I will always value the education, support, and patience I received from him at the start of my graduate studies.

I wish to thank all of the undergraduate research assistants who spent many hours collecting and organizing data; I could not have finished without their valuable assistance. To my fellow lab mates past and present, Sharon Eaves, Danielle Lutfi-Proctor and Joe Harris, and to my fellow graduate students and friends, especially Rebecca Horn, Marisa Sullivan, Sheila Krogh-Jespersen, and Caitlin Brez, I extend my heartfelt appreciation for their unwavering support, advice, and friendship.

Finally, I would like to acknowledge and thank my family for providing their love, support, and perhaps most importantly, their patience throughout this entire process. My husband, Trey Causey, has provided endless support and encouragement, always willing to help in any way, and pushing me forward during my most difficult moments. I thank my family, especially my parents, for always believing in me and supporting me in every way they could. I share this accomplishment with each and every one of you.

TABLE OF CONTENTS

Acknowledgements	ii
List of Tables	v
List of Figures.....	vi
Abstract.....	vii
Chapter 1: Introduction	1
Chapter 2: Literature Review.....	5
Research Examining Synchrony Effects in Cognitive Tasks	7
Memory Performance	8
Inhibitory Control.....	9
Limitations with Current Body of Research	12
An Investigation of Synchrony Effects in College Students.....	15
Working Memory Capacity.....	15
Irrelevant Speech Effect	16
Summary	17
Chapter 3: Explanation of Current Study.....	19
Psychological Refractory Period.....	20
Explicit Memory Dual Task.....	22
Theoretical and Practical Implications of this Research	25
Summary	26
Method	27
Participants	27
General Design and Measures.....	29
Chapter 4: PRP Experiment.....	33
Materials.....	33
Design and Procedure.....	33
Results and Discussion.....	35
Tone Task (S1)	36
Letter Task (S2).....	37
PRP Effect	39
Regression Analysis	41
Results Split by Chronotype.....	42
Chapter 5: Explicit Memory Dual Task Experiment.....	43
Materials.....	43
Design and Procedure.....	44
Results and Discussion.....	46
Memory Task.....	46
Letter CRT Task.....	47

Regression Analyses.....	51
Results Split by Chronotype.....	52
Results and Discussion of Additional Measures.....	53
GVA Scale.....	53
MCTQ.....	58
Chapter 6: General Discussion	60
Summary of Findings	60
Experiment 1	60
Experiment 2	61
Is Past Research Truly About Synchrony Effects?	63
Limitations of the Current Study.....	64
Future Directions and Conclusions	67
References.....	72
Appendix A.....	80
Appendix B.....	81
Appendix C.....	82
Appendix D.....	84
Appendix E.....	85
Vita.....	86

List of Tables

1. Average Accuracy and RTs for the Tone Task (S1) in Experiment 1 (Standard Deviations in parentheses).....	36
2. Average Accuracy and RTs for the Letter Task (S2) in Experiment 1 (Standard Deviations in parentheses).....	38
3. Means and Standard Deviations (in parentheses) for Percent Accuracy of Recall and Number of Intrusions in Memory Task Only and Dual Task	47
4. Means and Standard Deviations (in parentheses) for Percent Accuracy and RTs of Letter Responses in Letter Task Only and Dual Task.....	49
5. Means and Standard Deviations for Ratings on Each Subscale on the GVA Scale at Each Time Period	53
6. Means, Standard Deviations, and Correlation Coefficients of Some Parameters of the MCTQ with MEQ Score	59

List of Figures

1. Distribution of MEQ scores adapted from Chelminski, Ferraro, Petros, and Plaud (1997). $N = 1,617$, age range = 18-53 years, M age = 19	2
2. Distribution of Chronotypes from Briganti and Elliott (in preparation). $N = 441$, age range = 17-39 years, M age = 19.57.....	3
3. Distribution of Chronotypes adapted from May and Hasher (1998). N (younger adults, 18-23 years) = 1,364, N (older adults, 60-75 years) = 563	3
4. The central-bottleneck model adapted from Bratzke et al. (2007)	21
5. The accuracy in proportion-correct responses to S2 for each level of S1 difficulty following 100ms (short) and 1000ms (long) SOAs	39
6. Reaction times to S2 for each level of S1 difficulty following 100ms (short) and 1000ms (long) SOAs	40
7. Reaction times to letters in the morning and evening experimental sessions during the recall phases of the easy and hard memory tasks	50
8. Reported ratings on the Vigor and Affect subscales of the GVA Scale at each time period.....	54
9. Reported ratings on the Vigor and Affect subscales of the GVA Scale at each time period by Chronotype.....	56
10. Reported ratings on the GVA Scale at each time period during the morning and evening sessions by Chronotype.....	57

Abstract

Previous studies have shown that circadian rhythms can have a significant impact on cognitive task performance (Bodenhausen, 1990; May, Hasher, & Stoltzfus, 1993), and that performance is better during participants' optimal time of day for explicit memory tasks and for tasks where inhibition of responses is required. Researchers have concluded that deficits during one's non-optimal time of day are due to inefficient inhibition (e.g., May & Hasher, 1998). However, previous studies have not sufficiently addressed possible changes in resource allocation, or the amount of resources that are allocated to the primary task versus the amount of resources used to actively inhibit distracting information, and how these changes might be influenced by chronotype and time of participation. One way to address this issue is to use dual-task methodology because past research has shown that when participants are asked to engage in two tasks concurrently, performance on one or both tasks suffers, presumably due to inefficient resources (e.g., Baddeley, 1996). Two experimental paradigms, the psychological refractory period (PRP) and explicit memory dual task, were used to investigate how time of day preferences affected changes in resource allocation. Results showed that, at least for college students, performance on these tasks was not more efficient during peak times, suggesting that optimal allocation of attentional resources does not rely on chronotype synchrony. However, further analyses suggested that synchrony effects may be masked by including Morning and Evening types in the same analysis, as opposed to separating the chronotypes when examining peak and off-peak groups. These two groups of participants showed a pattern of opposite effects in the current experiments, with only Evening types showing a trend towards synchrony. Given that the majority of previous synchrony effect results have been confounded by age, more research should be conducted to disentangle these two factors.

Chapter 1: Introduction

Many common biological factors, such as body temperature, heart rate, hormone levels, and blood pressure, have cyclic lengths of 24-hours that reflect regular peaks and declines throughout the day, though the peaks can vary by individual. These factors are referred to as *circadian* (*circa + dies* in Latin means *about a day*) *rhythms* (Smith, Reilly, & Midkiff, 1989), and all humans exhibit them. For example, everyone's body temperature rises during the day until it reaches its peak, and then declines. As body temperature rises, so do arousal and alertness. Thus, the peaks in arousal tend to parallel those in body temperature.

The majority of individuals exhibit circadian peaks during the middle part of the day. However, there is normal variation in which cycles peak a few hours earlier to a few hours later than average. *Morning* types are individuals who exhibit peaks in arousal and alertness earlier in the day, and *Evening* types are individuals who show peaks later in the day (Horne & Ostberg, 1976). Furthermore, whereas evening types start their waking day with a lower body temperature that increases throughout the day to reach its peak in the afternoon, morning types start with a higher body temperature that increases more rapidly and reaches its peak 1-2 hours earlier (Adan, 1991; Natale & Cicogna, 2002). The time of day that a person is most alert and aroused is considered that person's optimal time of day, and is referred to as his *circadian typology* or *chronotype*.

The most widely used measurement to determine a person's chronotype is Horne and Ostberg's (1976) Morningness-Eveningness Questionnaire (MEQ). Scores range from 16 to 86 (the lower the score, the more of an evening preference), and the different chronotypes resulting from the MEQ include Definitely Evening, Moderately Evening, Neither, Moderately Morning, and Definitely Morning. In many past research studies, the definite and moderate classifications

are grouped as either just *morningness* or *eveningness*. As shown in Figures 1-3 (sample distributions taken from three different studies), there is a normal distribution of preferences, with the majority of individuals being *neither* types. Figures 1 and 2 show distributions of young adult samples, while Figure 3 shows a general shift from eveningness in young adulthood to morningness in older adulthood (May & Hasher, 1998).

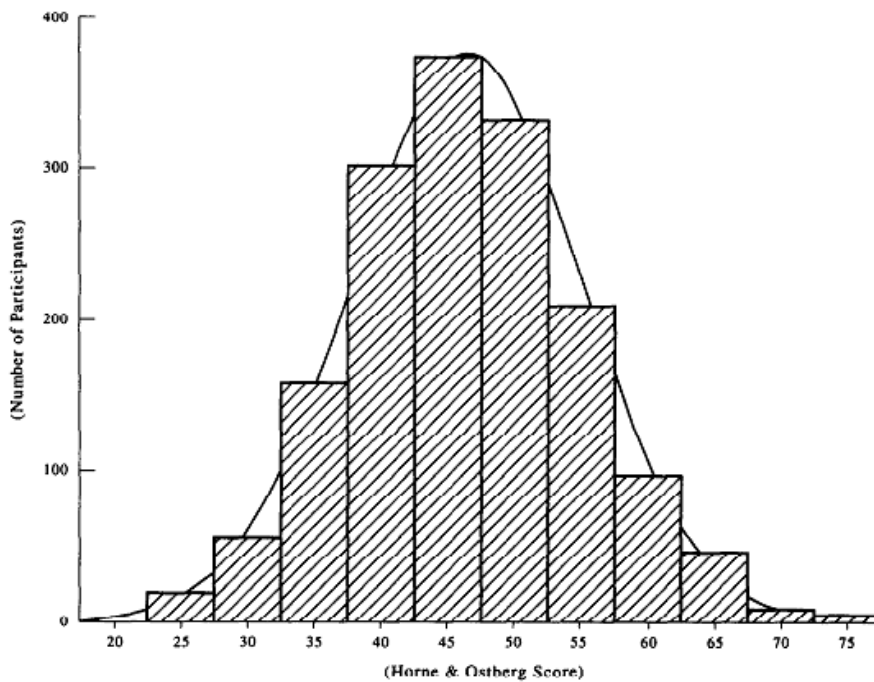

Fig. 1. The H&O scores of all participants displayed as a histogram.

Figure 1. Distribution of MEQ scores adapted from Chelminski, Ferraro, Petros, and Plaud (1997). $N = 1,617$, age range = 18-53 years, M age = 19.

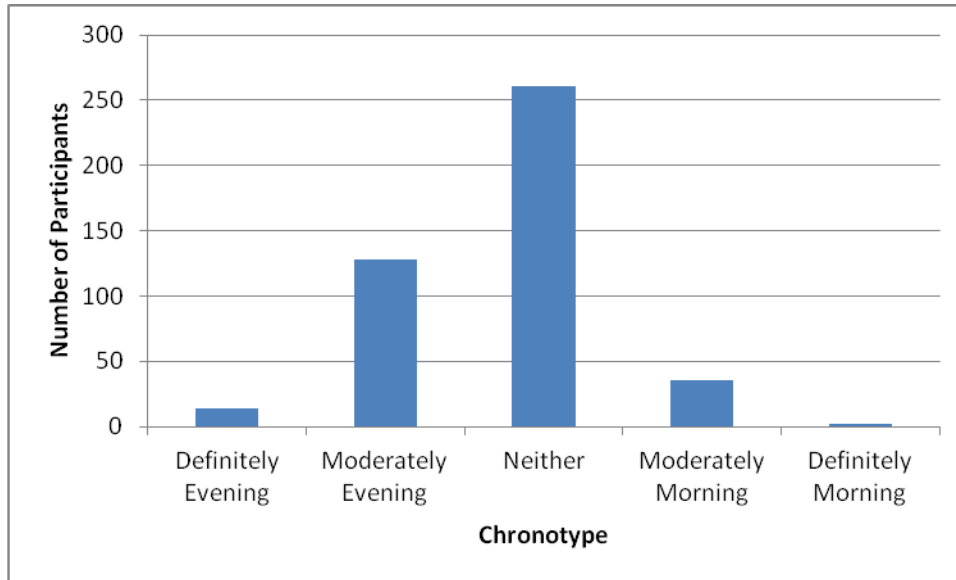

Figure 2. Distribution of Chronotypes from Briganti and Elliott (in preparation). $N = 441$, age range = 17-39 years, M age = 19.57.

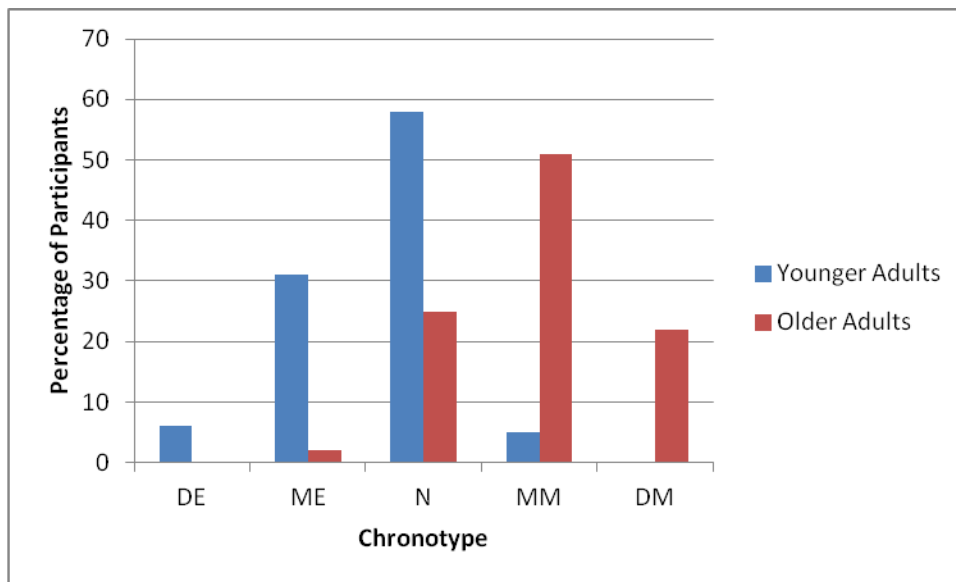

Figure 3. Distribution of Chronotypes adapted from May and Hasher (1998). N (younger adults, 18-23 years) = 1,364, N (older adults, 60-75 years) = 563.

For individuals who have extreme chronotypes, the match between chronotype and time of day has been shown to influence efficiency in task performance. Thus, the term *synchrony effect*, which is the main focus of this paper, refers to the notion that individuals tested at their

optimal time of day will perform more efficiently on tasks than when they are tested at their non-optimal time of day (May & Hasher, 1998). Alternatively, *time-of-day (TOD) effects* refer to the changes in performance of cognitive tasks when tested at different times of the day, but that are not tied to an individual's chronotype.

Not only do circadian rhythms influence physiological processes such as body temperature, they can also impact performance on a variety of cognitive tasks (e.g., Bodenhausen, 1990; Intons-Peterson, Rocchi, West, McLellan, & Hackney, 1998; Hasher, Chung, May, & Foong, 2002; May et al, 1993) and academic achievement (e.g., Dunn, Dunn, Primavera, Sinatra, & Virostko, 1987; Medeiros, Mendes, Lima, & Araujo, 2001; Randler & Frech, 2009), as well as impact important aspects of everyday life, such as health and medical treatments (e.g., Leirer, Tanke, & Morrow, 1994) and adaptation to shift work (e.g., Bohle, Di Milia, Fletcher, & Rajaratnam, 2008; Hossain & Shapiro, 1999). Determining just how much these fluctuations can influence individuals' daily lives is an important aspect of this area of research. This information may have important consequences for experimental, clinical, and academic settings. If there are, indeed, substantial differences in task efficiency, student grades, and medical adherence depending on the time of day, then this factor should not be ignored. Different conclusions could be drawn depending on whether the time of day was optimal for performance on a specific task, so caution should be taken when making conclusions using data that have not taken this factor into account. This is especially true for older populations who may be even more susceptible to time-of-day influences than younger adults (see Yoon, May, & Hasher, 1999 for a summary).

Chapter 2: Literature Review

Several past studies have shown that memory task performance, especially in tasks examining explicit memory and in tasks in which inhibition is important for successful performance, is more efficient when performed during optimal times of the day (e.g., Hasher, Goldstein, & May, 2005; May & Hasher, 1998). However, these previous studies, as will be discussed below, have mostly focused on single-task experiments in which participants must pay attention to one particular aspect of the task while inhibiting other aspects. Attention in this case refers to the process of concentrating one's mind on a particular aspect of one's environment while excluding competing stimuli. According to Cowan's (2005) model of working memory, the information that one is concentrating on is within his focus of attention. Working memory, which according to Cowan is a part of long-term memory, is separated into two components—activated representations from long-term memory and the focus of attention. The focus of attention is considered to be limited in capacity and can hold up to four of the activated long-term memory representations. Thus, if an individual encounters a new telephone number and rehearses the digits to commit them to memory, the digits would be within that person's focus of attention (assuming that the individual has grouped the seven digits into two or three smaller meaningful units). In order to complete mental tasks, at least a small amount of information important to the tasks must be activated from long-term memory and accessible for use. There are individual differences in working memory capacity, and numerous studies have shown that these individual differences are related to how well one can control attention through various central executive processes such as directing attention, filtering out irrelevant information, and suppressing incorrect but natural responses to a task (e.g., Hasher, Stoltzfus, Zacks, & Rypma, 1991; Hasher & Zacks, 1988; Kane & Engle, 2003). The ability to inhibit irrelevant information

has been an important aspect of Hasher and colleagues' work on synchrony effects, but there has been virtually no focus on synchrony effects and the ability to allocate attention among multiple tasks.

While performance in single-task studies is important to study, the results cannot sufficiently explain possible changes in resource allocation to multiple tasks at differing times of day. As Matthews, Davies, Westerman, and Stammers (2000) point out, "primary task measures of workload are not particularly sensitive to changes in resource allocation," and that "the use of multiple measures of task performance (usually speed and accuracy) can facilitate detection of strategy changes in performance" (p. 94). Studies often show performance deficits when participants attempt to complete multiple tasks concurrently, known as dual-task interference. For example, Strayer and Johnston (2001) showed that, in a simulated driving task, using a cellular phone while driving was associated with decreased traffic signal detection and increased reaction times to the detected signals. One explanation for dual-task interference is Kahneman's (1973) capacity or resource theory which suggests we have limited cognitive resources which can be allocated among the tasks in a graded fashion. If capacity is limited, then allocating additional resources to one task will improve performance on that particular task. However, this would come at a cost to any other tasks needing to be performed concurrently because not enough resources are available for other tasks. Thus, attentional control is important in that one can regulate the amount of resources devoted to the most important tasks while reserving smaller amounts of resources for less important tasks. Kahneman also suggested that arousal can work to increase processing resources, and the ability to apply more resources can help to improve task performance. The central executive plays a role in allocating attentional resources (Baddeley & Logie, 1999), and dual-task measures have been used to evaluate the allocation of attentional

resources to competing task demands (Baddeley, 1996; 2001). This research shows that there are adverse costs associated with performance in completing dual tasks relative to performance when each task is completed separately. For these reasons, the use of dual tasks is a better measure of resource allocation than single tasks, and it is of current interest to examine these dual-task costs within individuals of differing chronotypes to determine if synchrony effects are present. If synchrony effects are found, this may suggest that individuals are more efficient multitaskers at their optimal time of day.

In the following review, I will first outline past research examining synchrony effects in cognitive task performance as well as the limitations within this body of research; I will then summarize research on time of day preferences conducted in our own lab; and finally I will explain the dual-task methodologies used in the current study to investigate the ways in which we might allocate cognitive resources according to our time of day preferences.

Research Examining Synchrony Effects in Cognitive Tasks

Synchrony effects have been reported in studies investigating both memory performance and inhibitory control ability. For example, Bodenhausen (1990) and May et al. (1993) reported some of the earlier studies that have shown that cognitive task performance is influenced by circadian patterns such that individuals' performance in cognitive tasks was higher during on-peak times (i.e., in the morning for Morning types) than off-peak times (i.e., in the evening for Morning types). May and Hasher (1998) found synchrony effects in a study examining performance in a stop signal task in which participants have to stop a response that they would normally make (inhibition); Winocur and Hasher (2002) found synchrony effects in a long term memory task; and Yoon et al. (1999) found synchrony effects in a simple word span task.

Memory Performance

To investigate the effects of working memory load, Rowe, Hasher, and Turcotte (2009) examined individual performance in a visuospatial working memory (VSWM) task while manipulating time of testing (on-peak and off-peak), age of participants, and amount of interference (high: increasing set size from 4 to 7, versus low: decreasing set size from 7 to 4) in the Corsi Block VSWM span task. For this task, participants had to remember the order in which blocks were lit up on a computer screen, and then press the blocks in the order in which they appeared. Thus, interference increased as the set size increased. For younger adults who were evening types, performance improved when tested in the late afternoon compared to morning for both the high interference and the low interference conditions, demonstrating a synchrony effect.

A variety of research also exists showing that both younger and older adults exhibit poorer performance in explicit memory tasks at non-optimal times of the day. For example, Intons-Peterson, Rocchi, West, McLellan, and Hackney (1999) found synchrony effects in a false memory task; May et al. (1993) found synchrony effects in sentence recognition; Winocur and Hasher (2002) found synchrony effects in a long-term story recall task; and Yoon et al. (1999) and May, Hasher, and Kane (1999) found synchrony effects in simple word span tasks. In each of these studies, older morning-type adults (as assessed by the MEQ) performed worse at these tasks in the late afternoon (their off-peak time), and younger evening-type adults performed worse in the morning (their off-peak time). In Intons-Peterson et al.'s (1999) study, synchrony effects were stronger for the older adults than the younger adults, suggesting that optimality of testing may be more important for older than younger adults. Similarly, May, Hasher, and Foong (2005) and Yang, Hasher, and Wilson (2007) found synchrony effects when explicit memory in a stem-completion task was examined. May et al. (2005) found that both younger evening-type

and older morning-type adults performed better during optimal times of day than during non-optimal times. In addition, Yang et al. (2007) found, in a sample of exclusively older adults, that controlled retrieval in the explicit portion of the memory task was significantly better at on-peak times than off-peak.

Finally, in samples of college students, Anderson, Petros, Beckwith, Mitchell, and Fritz (1991) examined individual differences on the speed of accessing information from long-term memory during either morning, afternoon, or evening sessions. They found that reaction times for word encoding, lexical access, and semantic memory access decreased over the day for evening-type participants, but reaction times increased over the day for the morning-type participants. Thus, the speed of accessing information from long-term memory was faster in the morning for morning-types and faster in the evening for evening-types, exhibiting synchrony effects. Similarly, Petros, Beckwith, and Anderson (1990) found that memory for prose passages decreased across time of day for morning types, and prose recall slightly increased across time of day for the evening-types. However, evening-types recalled significantly more unit ideas than morning-types overall, and the synchrony effects were only observed for more difficult passages. Additionally, Natale and Lorenzetti (1997) found that narrative comprehension performance, tested with an immediate recognition memory task, was improved for morning-types when tested in the morning than in the afternoon, and vice versa for evening-types. These studies suggest that individuals had an easier time accessing information from long-term memory when they were tested at an optimal time of day.

Inhibitory Control

Several researchers who have investigated synchrony effects in inhibition-based tasks have found similar results to the memory tasks. For example, Yoon, May, and Hasher (2000)

summarized a variety of research that has shown that when individuals were tested using inhibition tasks at on- and off-peak times of the day, performance during off-peak times was diminished compared to performance during on-peak times. This diminished performance at non-optimal times of the day was reflected in studies examining enhanced access to irrelevant information (May, 1999), failure to delete information from working memory that was no longer relevant (May & Hasher, 1998), difficulties in inhibiting dominant responses to stimuli that were inappropriate for the task (May & Hasher, 1998), and negative priming (i.e., slower responding to identify stimuli that was once ignored; Intons-Peterson et al., 1998).

However, when the material to be accessed or produced was familiar or well-learned, or when dominant responses were the correct responses, synchrony effects were not evident. May et al. (2005) presented young and older participants with an implicit stem-completion task and an implicit category completion task during both peak and off-peak times. Participants of both age groups showed significantly more priming (increased sensitivity for remembering certain information due to having experienced, often unaware, the information before) when tested during off-peak times, which suggested that individuals were more likely to produce automatic, unconscious responses at off-peak times. Furthermore, after completing a same/different judgment task with distractors, participants in Rowe, Valderrama, Hasher, and Lenartowicz's (2006) study were subsequently asked to complete word fragments. The word fragment completion task was used to test participants' memory for the distractors in the previous task. Younger adults showed greater priming for distractors when tested in the morning and older adults showed greater priming when tested in the afternoon; however, older adults had better memory for the distractors, overall, than did younger adults. These results imply that older adults

had a hard time ignoring the distractors and thus were able to retrieve them in the word fragment task more so than younger adults.

Finally, in a recent study published on synchrony effects, Wieth and Zacks (2011) found that non-optimal times become optimal for *insight* or creativity tasks, where a knee-jerk response (or one's initial interpretation) is the not best or correct response for the task at hand. Wieth and Zacks gave participants two types of problems—insight and analytic—to solve, either during participants' optimal or non-optimal time of day. In order to solve insight problems, participants usually need to be able to reinterpret the problem and approach solving it using a perspective different from one's initial wrong interpretation. For analytic problems, a solution can usually be achieved based off of one's initial representation of the problem. Thus, Wieth and Zacks suggested that reduced inhibitory control at one's non-optimal time of the day would actually benefit insight-problem solving because it would permit consideration of a larger range of information that may otherwise be ignored during one's optimal time of day. The results supported their hypothesis; participants who worked on insight problems during their non-optimal time of the day were more successful than those who worked the problems during optimal times. The opposite was true for analytic problems. One note of caution, however, is that because this study included only college students, the Evening type group included 195 participants while the Morning type group included only 28 participants—vastly uneven groups.

In sum, results from these studies consistently showed that participating in inhibition memory tasks at optimal times of the day led to improved performance, when inhibition was important to the task, than participating at non-optimal times. Furthermore, when participants of different ages were asked to recall information that they previously had to ignore, older adults were better at remembering the previously irrelevant information during non-optimal times,

suggesting that older adults' ability to inhibit information is less efficient than younger adults' ability.

These results also fit in with Hasher and Zacks (1988) inhibition-based model of memory, which states that inhibitory processes support efficient working memory by limiting the access of irrelevant information into working memory and by removing information from working memory that is no longer relevant (Hasher & Zacks, 1988; Stoltzfus, Hasher, & Zacks, 1996). Thus, efficient inhibitory processes should aid with explicit recollection during optimal times and less efficient inhibitory processes, as seen during non-optimal times, should actually help improve implicit memory performance (or memory performance for items that were previously ignored).

Limitations with Current Body of Research

While past research (e.g., Bodenhausen, 1990; May et al., 1993) has shown that cognitive task performance can be influenced by time of day preferences, there are inconsistencies within the literature regarding the extent to which these effects are present. For example, the most robust effects have been seen when both older and younger adults are used as participants, whereas the effects are less consistent when examined with only younger adults as participants. The participants in Hasher and colleagues' studies, which have been consistent in finding synchrony effects, have typically been both younger and older adults. This may be due to the fact that in most of these studies, all morning participants were also older adults and all evening participants were also younger adults, so age, or some other factor, as well as chronotype may have played a factor in the results. The findings of several studies using solely young adults as participants, on the other hand, have not been as clear. For example, several researchers have found synchrony effects with college students using a visual search task (Natale, Alzani, &

Cicogna, 2003) and long-term memory tasks, including the speed of accessing information from long-term memory (Anderson et al., 1991), performance on prose recall (Petros et al., 1990), and recognition performance and narrative comprehension (e.g., Natale & Lorenzetti, 1997).

Conversely, Bonnefond, Rohmer, Hoefl, Muzet, and Tassi (2003) found no synchrony effects in a descending subtraction task, Matchock and Mordkoff (2009) found differing time-of-day (but not synchrony) effects using various components of attentional networks, Song and Stough (1999) found no overall performance differences between morning and evening types on the Multidimensional Aptitude Battery which assesses aptitude and intelligence, and Roberts and Kyllonen (1999) found evening types performed higher than morning types on working memory tasks even when they were tested in the morning.

Several problems exist, however, within the samples of participants used in some of these studies which may hinder the interpretations of the results. For example, Song and Stough's (1999) classification of participants was atypical in that participants who had neither a morning nor an evening preference were still included in the sample, likely weakening the chance of any effects because the time of testing may still be considered on-peak for a neither type whether it be in the morning or the afternoon. Similarly, Bodenhausen (1990) and Natale and Lorenzetti (1997) also used a median split to classify Morning and Evening types. Unlike Song and Stough, however, they did find synchrony effects in some tasks. Other researchers (e.g., Anderson et al., 1991; Natale et al., 2003) used true Morning/Evening classifications and found synchrony effects, but only in some tasks. Ultimately, classifications of chronotype groups should be consistent in order to make generalizations about synchrony effects.

Finally, the participants in Roberts and Kyllonen's (1999) study were all Air Force recruits with an average MEQ score of 54.36 (closer to morningness than eveningness), whereas

in a general population of college students, more students are classified as evening types (29.3%; Chelminski et al., 1997 - 37%; May & Hasher, 1998) than morning types (5%; May & Hasher, 1998 - 8.3%; Chelminski et al., 1997), as measured by the MEQ. As Roberts and Kyllonen indicated, “the magnitude of these scores indicates that this sample is predisposed towards morningness” (p. 1127). The recruits also likely have a daily schedule more consistent than that of a typical college student, and they had time to phase shift to a morning schedule after a six-week training period. Furthermore, Roberts and Kyllonen used factor analysis to extract three factors from the MEQ, and these factors (evening affect, morning affect, and morning effort) were correlated with the various intelligence and cognitive processing measures used in their study, rather than the original MEQ scores. Finally, all participants were given the cognitive abilities measurement during the morning (8:00am-12:00pm), so this limits comparisons between on-peak and off-peak groups (i.e., all morning participants were on-peak and all evening participants were off-peak). Thus, the researchers made their conclusions based off of chronotype rather than synchrony effects, *per se*.

Given the conflicting results and concerns with the studies that have not found synchrony effects, two experiments were carried out to investigate how chronotype relates to cognitive performance in a general sample of college students using two different experimental approaches (Briganti & Elliott, in preparation). The first approach examined individual differences in working memory capacity (WMC) and their relationship to chronotype, and the second approach utilized an irrelevant speech effect (ISE) task as an experimental manipulation.

An Investigation of Synchrony Effects in College Students

Working Memory Capacity

Working memory is a component of memory that is used to temporarily store and manipulate information, such as solving a mathematical equation in one's head. WMC refers to the amount of information that an individual is able to hold and manipulate at one time. For the first experiment, the main question was whether participants would have different scores on the MEQ depending on whether they had a high WMC or a low WMC. This is relevant because past research has shown that WMC correlates with higher order abilities such as fluid intelligence (e.g., Conway, Cowan, Bunting, Therriault, & Minkoff, 2002; Engle, Tuholski, Laughlin, & Conway, 1999), so it was of interest to determine if more advanced mental abilities were related to one's chronotype. Furthermore, we were interested in examining whether optimality of testing influenced how individuals performed in the WM tasks. For this particular experiment, there were 33 on-peak and 43 off-peak participants (19 Morning types and 57 Evening types). Chronotype and synchrony were between-subject factors and all participants completed three WM tasks. The scores from each task were used to calculate a composite WMC score. Despite there being some evidence that chronotype relates to working memory (Roberts & Kyllonen 1999 found an eveningness advantage in a sample of Air Force recruits), results from the first experiment did not support those findings. There was no significant relationship between a composite measure of WMC and chronotype, and there was no effect of synchrony on WM task performance. Although individual differences do exist in WMC (Conway, Cowan, & Bunting, 2001; Kane & Engle 2003; Unsworth & Engle 2005), the results from this study do not suggest that chronotype is one of the factors that relates to WMC.

Irrelevant Speech Effect

The second study, which was separate from the WMC study, included an experimental manipulation to examine synchrony effects in an ISE task. In a standard ISE task, participants are shown lists of digits to remember. In some trials, words (or sounds) are presented aurally during the digit presentation, and participants are told to ignore the auditory information. The irrelevant speech effect is found when participants recall a significantly greater proportion of digits during silent trials than during trials with auditory distractors. Thus, the irrelevant information interferes with recall (Colle & Welsh, 1976). The central question of Briganti and Elliott's (in preparation) ISE experiment was whether someone who participated in an ISE task during an optimal time of day would perform differentially than someone who was administered the task during a non-optimal time of day. The hypothesis was that participants who engaged in this type of task during on-peak times would perform better than those who engaged in the task during off-peak times. If the ISE includes an attentional-based mechanism, on-peak participants should be more efficient at focusing their attention to remember the relevant items and ignore the irrelevant items than off-peak participants. However, there is an ongoing debate as to whether the ISE includes a role for attention that can be controlled to attend to specific aspects of the task (as Cowan, 1995 and Neath, 2000 suggested) or whether irrelevant information has automatic and obligatory access to memory (as Baddeley, 2007 and Jones, 1993 suggested). If the ISE does include an attentional-based mechanism, then it would stand to reason that participants should have an easier time ignoring distractors (i.e., inhibiting the irrelevant information) during their optimal time of day.

The participants in this experiment included 21 on-peak and 18 off-peak (9 Morning types and 30 Evening types). Chronotype and synchrony were between-subjects factors and

auditory condition (silence or speech) was a within-subjects factor. According to the results, although the standard ISE was found, there were no differences between those who performed an ISE task during an optimal time of day as compared to those who performed it during a non-optimal time of day, a finding that does not support previous literature on inhibition and synchrony effects. Thus, this finding suggests that, although chronotype can influence performance in other cognitive tasks, it has no influence on the ISE. These results do, however, support the ISE theories that suggest irrelevant information in an ISE task has obligatory access to the cognitive system (Baddeley, 2007; Jones, 1993) and corroborate previous research showing no synchrony effects with tasks that involve more automatic explicit processing and retrieval (e.g., Li, Hasher, Jonas, Rahhal, & May, 1998; Yang et al., 2007). While automatic processing in implicit memory tasks has been shown to produce asynchronous effects in that participants remembered more irrelevant information at off-peak times (e.g., May et al., 2005; Rowe et al., 2006), memory for distractors was not examined in the current ISE task, so conclusions cannot be made to address those findings.

Summary

The results from previous research have suggested that optimality of testing is an important issue to consider, especially with regards to cognitive performance of older adults (e.g., May & Hasher, 1998; May et al., 2005; Yang et al., 2007). Research with young adult college students has been less convincing (e.g., Briganti & Elliott, in preparation; Natale et al., 2003; Song & Stough, 2000), and further research is needed to investigate reasons for the discrepancy in synchrony research between young adults and older adults. One possibility is that the tasks utilized in previous research have been selective attention-type tasks which may be

sensitive enough to find synchrony effects in older adults, but not younger adults. This possibility was explored in the current study.

Chapter 3: Explanation of Current Study

What emerged from the results of Briganti and Elliott's WMC/ISE study, as well as previous studies, was the issue that in most of these studies, the results could be explained in terms of selective attention, but this is not sufficient to explain how resources were being allocated to the primary task versus the amount being used to actively inhibit distracting information. It is important to examine how time of day preferences can influence our ability to allocate attentional resources effectively because we are constantly faced with multitasking situations in which we have to divide our attention among two or more tasks simultaneously. A common example of this is when we are driving, especially in an area with which we are unfamiliar. We must pay attention to the street we are driving on, look for the next street we need turn onto, all the while surveying the traffic and the area around us. This can sometimes be a tough task even when we are very alert, so one can imagine that it is even harder when we are tired.

Thus, the primary focus of the current study is to examine whether one's chronotype influences how resources are allocated in dual tasks, depending on the time of day one engages in the tasks. There are several ways in which to examine dual-tasking within cognition. The two tasks that were used in the current study were perceptual selection using the psychological refractory period (PRP) paradigm and explicit memory/reaction time (RT) processes using a standard primary word recall task paired with a secondary choice RT task. These paradigms were selected because they each propose a different model of dual-task interference. The PRP paradigm suggests a postponement model of dual-task interference (Pashler & Johnston, 1989), and the Explicit Memory task suggests a capacity (resource)-sharing model of interference

(Kahneman, 1973). Before describing each of the experiments in the current study, however, it is important to first review these two paradigms in more detail.

Psychological Refractory Period

The PRP paradigm has often been used to study capacity limits by utilizing dual-task performance as a means of taxing the cognitive system. It has been proposed that there is a central *bottleneck* in cognitive processing between stimulus selection and response (Pashler, 1994a; Pashler & Johnston, 1989). Following stimulus selection (perceptual processing), further cognitive processing (central processing) to carry out a response (motor processing) can only occur serially. Thus, if presented with two tasks in a very short time frame, responding to one stimulus delays the response to the second stimulus. Furthermore, it has been shown that response time to the second stimulus depends on the amount of time that lapses between the presentations of the two stimuli, called the stimulus onset asynchrony (SOA). The shorter the SOA, the longer it takes participants to respond to the second stimulus. Thus, researchers have suggested this PRP effect is a result of a bottleneck in the central processing stage (i.e., central processing can only occur for a single task at one time; Matthews et al., 2000). A response to the second task cannot be made until processing of the first task is complete (refer to Figure 4 for a depiction of the central-bottleneck model). With shorter SOAs, there is more overlap between processing streams, but with longer SOAs, the two processing streams do not overlap, so there is no delay in responding to the second task. The focus in the current studies was on the amount of time it took participants to make a response to the second stimulus given variations in SOA. If time-of-day preferences are important for this task, then one might expect to see even more slowing in the central processing stage, and thus a greater performance decrement in the second task, during one's non-optimal time of day.

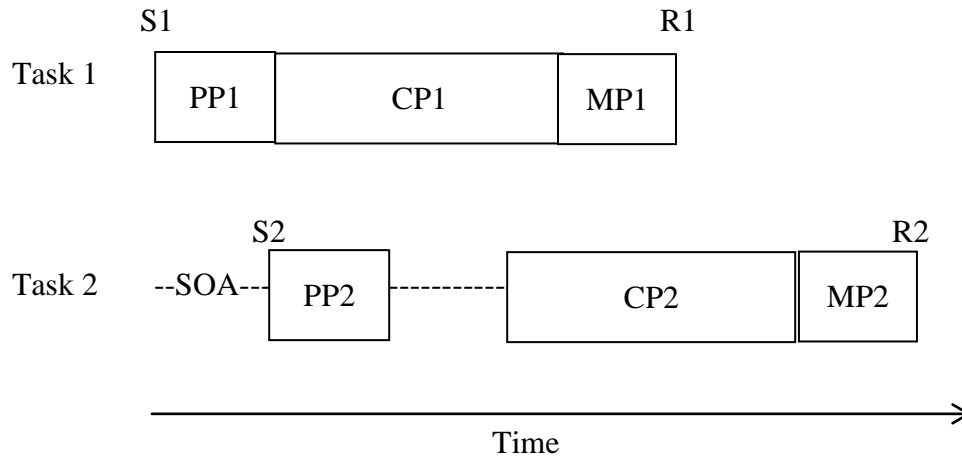

Figure 4. The central-bottleneck model adapted from Bratzke et al. (2007).

Note: S = stimulus; PP = perceptual processing; CP = central processing; MP = motor processing; R = response; SOA = stimulus-onset asynchrony. According to the model, CP2 cannot begin until CP1 is complete. With shorter SOAs, there is more overlap of CP; thus, the response time for Task 2 is prolonged.

The PRP effect was recently examined in a TOD-based study (Bratzke, Rolke, Ulrich, & Peters, 2007). Bratzke et al. used a constant routine paradigm in which they kept their participants awake for an extended period of time (28 hours, starting between 8:30 and 9:30am) and periodically administered a PRP task throughout their period of wakefulness. They found that RTs slowed down during the night for Task 2 but not for Task 1, and that the fastest RTs were recorded at 11:00pm and the slowest RTs were recorded at 7:00am. Furthermore, the difference in RT between the shortest and longest SOAs was smallest at 11:00pm and largest at 7:00am. Thus, the researchers concluded that central processing, or the cognitive processing needed to generate a response, is impaired at night (though this impairment is due to slowing and not decreased accuracy). Sleep deprivation may account for a portion of the slowed processing but it is not the main contributor because RTs decreased again after the 7:00am testing time when participants had been awake for a longer period of time. However, Bratzke et al. only

included six participants in their study, and the constant routine paradigm does not take into account a person's actual chronotype, which may limit generalization of the findings.

Explicit Memory Dual Task

Another way to examine central limits in processing using the dual-task performance method is by requiring participants to divide their attention in an explicit memory recall task. Divided attention (DA) in explicit memory processes are traditionally studied using a word recall task as the primary task and a continuous reaction time task as the secondary task. Within these studies, the primary task is usually the more difficult task and the secondary task is usually an easier task. During divided attention conditions, both of these tasks are performed concurrently. Studies of dual task performance suggest that the encoding and retrieval phases of memory are differentially affected by secondary task performance (e.g., Baddeley, Lewis, Eldridge, & Thompson, 1984; Craik, Govoni, Naveh-Benjamin, & Anderson, 1996; Naveh-Benjamin, Craik, Perretta, & Tonev, 2000; Logie, Sala, MacPherson, & Cooper, 2007). Overwhelmingly, the results from the DA literature suggest that, depending on when DA occurs (either at encoding or at retrieval), the effects of DA can be detrimental to performance on the primary task, relative to full attention (FA) conditions. Most studies show that performance on the word recall portion of the task is disrupted when DA is introduced at encoding, but the results are mixed when DA is introduced at retrieval.

Baddeley et al. (1984) and Craik et al. (1996) have reported that completion of a concurrent secondary task during encoding has a significant disruptive effect on memory recall performance, but the same disruptive effect was not found when the secondary task was completed during retrieval. Within the literature as a whole, results seem to consistently show that encoding processes are disrupted by any type of simultaneous processing or secondary tasks.

For example, Craik et al. (1996) found a drop in recall performance when DA was introduced at encoding when the secondary task involved simple visual stimuli and key presses; Baddeley et al. (1984) and Murdock (1965) found similar effects when the secondary task was a card sorting task; and Fernandes and Moscovitch (2000) found detrimental effects with other verbal secondary tasks. Furthermore, Craik et al. (1996) found that changing the instructions to emphasize either the memory task or the RT task had large effects at encoding (i.e., when the RT task was emphasized, RTs became faster and recall became worse).

Retrieval processes, on the other hand, do not seem to be as affected by simultaneous processing, as Anderson, Craik, and Naveh-Benjamin (1998), Baddeley, et al. (1984), Craik, et al. (1996), and Naveh-Benjamin, Craik, Guez, and Dori (1998) have shown. However, other studies have shown detrimental memory performance when DA at retrieval includes source memory tasks (Craik, 2001), when there is similarity of secondary task information and memory task information (e.g., both verbal; Fernandes & Moscovitch, 2000), when the secondary task was a number-monitoring task (this particular study also included older adults as participants; Park, Smith, Dudley, & Lafronza, 1989) and when target words were encoded deeply and semantically as opposed to words encoded by simply reading (Jacoby, 1991). Jacoby suggested that DA at retrieval reduced participants' ability to use recollection processes for the deeply encoded words. He concluded that perhaps semantic encoding is affected by the DA procedure but not familiarity (although the memory task in this study was source monitoring rather than recall). Similarly, Hicks and Marsh (2000) found that recognition memory performance can be diminished under certain dual task conditions, such as experimenter-controlled pace of the secondary task, more difficult secondary tasks requiring a great deal of attention, and encoding tasks that required a deeper level of processing. However, even in studies that have found

disruptions at retrieval, the amount of disruption on memory performance was usually greater when the secondary task was introduced during encoding compared to retrieval.

In contrast to the effects of primary task performance described above, when examining the results of secondary tasks alone, task performance tends to show more cost of DA at retrieval than at encoding in terms of both speed and accuracy. For example, Craik et al. (1996) found that DA at encoding led to large reductions in memory performance in the primary task but only small increases in RT in the secondary task. Conversely, DA at retrieval led to small or no reductions in memory performance in the primary task but much larger increases in RT in the secondary task. Thus, although Baddeley et al. (1984) concluded that retrieval processes may be “obligatory,” Johnston, Griffith, and Wagstaff (1972) suggested that retrieval processes may require more attentional and processing resources in order to be completed. Researchers have suggested that more attention is needed for the memory task during retrieval, especially for recall tasks, than encoding because participants showed slower RTs in the secondary task during retrieval as compared to encoding. In other words, if the same amount of processing resources were needed for the memory task during both encoding and retrieval, then RTs presumably should also be similar under both conditions, but evidence suggests otherwise (e.g., Craik et al., 1996; Naveh-Benjamin et al., 2000).

Nevertheless, the finding that secondary tasks are more affected during retrieval than during encoding does not necessarily mean that the process of retrieval is more demanding. Another explanation could be that there are methodological factors that allow more flexibility (e.g., slowing down) when DA is at retrieval than when it is at encoding. For example, when DA is at encoding, participants cannot control when words are presented, so they may allocate a bit more resources to performance in the secondary task which they can control; thus, word recall

suffers but RT does not. On the other hand, when DA is at retrieval, participants can control their verbal recall as well as their manual responses to the secondary task. Participants may first allocate resources to recalling the words and then use what is left to respond to the secondary task. Because full attention to encoding was allowed, word recall does not suffer greatly, but there are larger increases in secondary task RTs. Taking into account this flexibility in task switching and allocating attentional resources with respect to time of day preferences was the aim of the current study. By manipulating difficulty of the primary task and keeping difficulty of the secondary task comparable, I can also examine more closely secondary task costs in terms of both accuracy and speed, and whether dual-task costs depend on the match between time of day of participation and one's chronotype (i.e., synchrony effects).

Theoretical and Practical Implications of this Research

This type of design has theoretical implications because it allows for the allocation of cognitive resources between dual tasks to be investigated with respect to synchrony effects, and addresses a gap in the literature. Previous synchrony effect research examined aspects of attention and inhibition, but it cannot really be determined from these previous studies just how resources were being allocated to the primary task. By manipulating both the difficulty of the tasks and the match between one's chronotype and time of participation, examining secondary task costs in the current experiments could provide new information about synchrony effects and may help to resolve conflicts in the current literature which have focused more on selective attention in single tasks.

The results of these experiments could also have practical implications because we are often faced with dual tasks in our everyday lives, and our ability to effectively perform dual tasks may well depend on the match between our time-of-day preferences and time at which we are

faced with the tasks. Levy, Pashler, and Boer (2006) examined the central-bottleneck model in a practical simulated driving experiment. When participants had to respond concurrently to both a choice task and a braking task, Levy et al. found that participants were slower to brake when the SOA between the two tasks was reduced; in other words, brake reaction times increased as SOA decreased, showing the central bottleneck, PRP effect. If such a simple, everyday task can be influenced by something as benign as the amount of time-delay between tasks, then examining whether chronotype and synchrony influence the performance of dual tasks is also important. If slowed reaction times and impairment in central processing during non-optimal times impairs performance in dual tasks in a laboratory experiment, then that could have an even more detrimental effect on more real-world tasks such as actual driving ability. Thus, if we can better understand how attention is allocated between different tasks at different times of the day, it could have implications for real-world experiences such as driving.

Summary

In summary, both experiments in the current study utilized multiple measures of task performance in order to enable detection of possible strategy changes in performance in dual tasks based on time of day preferences. One hypothesis was that we are better able to allocate attention to multiple tasks during our optimal time of the day, which would enable us to perform the tasks more efficiently. Furthermore, by manipulating the difficulty of the primary task in each of the experiments, we investigated the effects such a manipulation would have on secondary task performance. If increasing primary task difficulty increases the amount of resources needed to complete the task, then there should be less spare resources to devote to the secondary task. Thus, secondary task performance should decrease as primary task difficulty

increases. One further question of importance was if these effects are exacerbated during one's non-optimal time of day.

The first experiment was designed similarly to Pashler and Johnston's (1989) procedure which used two seemingly easy choice-response tasks. The second experiment utilized the explicit memory procedure using DA at retrieval. While most previous studies have manipulated the point at which DA is introduced, the current focus was on DA at retrieval because of the interest in secondary task costs, and secondary task performance has been shown to be more sensitive in this memory paradigm when DA is at retrieval. Also, the fact that participants had to actually respond to both tasks during retrieval makes it more comparable to the PRP task.

Method

Participants

Power Analysis. To determine the appropriate sample size for these experiments, I used the results from the keypress portion of Rohrer and Pashler's (2003) study as a starting point. Using the means and standard deviations (calculated from the reported standard errors), I used the G*Power 3 (Erdfelder, Faul, & Buchner, 1996) post hoc t-test power analysis to determine the effect size, which resulted in $d = 0.65$ ($n = 12$). This is considered to be between a medium and large effect, but the design of the study is an all within-subjects design. Because an all within-subject design is more powerful than the proposed study's design (mixed-factor), I chose to use a medium effect size ($f = 0.25$) as my desired effect size, along with a desired power of 0.80. I then entered these parameters into a G*Power 2 x 2 F-test a priori power analysis (repeated measures, within-between interaction) with $df = 1$. The resulting suggested total sample size was 34. However, because I am investigating the interaction between synchrony and

attention condition, this number was applied to each group, for a total of 68 participants, with 34 participants in each on-peak/off-peak group.

Current Study. Participants in the initial screening were undergraduate students enrolled in psychology courses at Louisiana State University, and they were given either course or extra credit in their psychology classes for participation in these experiments. During the initial screening, chronotype was assessed using a computerized version of the MEQ (Horne & Ostberg, 1976), and those students who were classified as either Morning (scored > 58) or Evening types¹ (scored < 42) were invited to return to participate in the PRP and Memory tasks either in the morning (between 7:00-10:00AM) or in the evening (between 4:00-7:00PM). These times were selected based off of previous synchrony effect research (e.g., Intons-Peterson et al., 1999; May & Hasher, 1998), and there was no set time period between the screening session and the experimental session. However, the average amount of time between the two sessions was approximately 30 days, and it ranged from four days to 190 days (the one instance of 190 days spanned across two semesters and was an outlier; the next highest time period was 86 days).

Individuals were not invited to participate in the experimental session if they reported hearing loss or uncorrected vision impairment, if they were not native English speakers, and if they scored as a Neither type on the MEQ. There was a total of 404 individuals eligible to participate in the experimental session—315 Evening types and 89 Morning types. As an additional incentive to participate in the experimental session, participants' names were entered into a drawing to win one of three \$50 gift cards. Of those invited to complete the experimental

¹ Although the majority of young adults are generally classified in the Neither group, they were not included in this study for two reasons. First, I am mainly interested in the extreme groups because of the results of past synchrony effect studies. Secondly, it does not seem feasible to include a Neither group because if its peak time is the middle of the day, then its off-peak time would presumably be in the middle of the night, which is not a time that is possible to recruit participants. Thus, only Morning and Evening type participants were included in this study.

session, the final sample included 74 participants (M age = 19.79; SD = 2.25; 54 females). Of these 74 participants, 18 scored as Morning types on the MEQ (M score = 61.50; one Definitely Morning, 17 Moderately Morning) and 56 scored as Evening types (M score = 35.73; eight Definitely Evening, 48 Moderately Evening). These Morning types represent 24% of the experimental sample, which is slightly higher than the 22% of Morning types who were eligible for participation. The percentage of Morning and Evening types was representative of the population of eligible participants, but this led to uneven on-peak/off-peak and morning/evening group sizes.

General Design and Measures

Forty-six of the participants completed the experimental session during an on-peak time (eight Morning on-peak, 38 Evening on-peak) and the remaining participants completed the experimental session during an off-peak time (10 Morning off-peak, 18 Evening off-peak). The original intention was to include a fully-balanced design of chronotypes and time of testing, but this was not achieved. These uneven group sizes, especially for the on-peak group, limited the conclusions reached from the results of the analyses because they call into question whether the results are due to the actual group differences or due to the uneven number of participants in each group. Synchrony was considered a between-subjects factor while presentation of the tasks was within subjects. Thus, all participants participated in both the PRP and memory experiments. Because some aspects of the tasks require verbal responses, each participant was tested individually.

During the experimental sessions, the Global Vigor and Affect Scale (GVA; Monk, 1989) was administered before and after each experimental task as a measure of alertness (Global Vigor; GV) and mood (Global Affect; GA), and a post-experiment questionnaire was

administered to assess potential mediating factors such as how many hours of sleep the participants received the night before the experiment (see Appendix A for a list of all questions). The GVA Scale was used to detect changes in subjective alertness and mood and was given three times over the course of the experimental session. The scale contained eight questions, and participants responded to each question using a visual analogue scale (VAS) ranging from 1 to 10 with descriptive anchors at each end (i.e., for the “How alert do you feel?” question, the anchors were “1 - very little” to “10 - very much”). The GV subscale included indexes of alertness, effort, weariness, and sleepiness while the GA subscale included indexes of sadness, tenseness, happiness, and calmness.

Additionally, a newer chronotype assessment, the Munich Chronotype Questionnaire (MCTQ; Roenneberg, Wirz-Justice, & Mellow, 2003) was also administered at the end of the experiments, but it was primarily used as a chronotype manipulation check. The MEQ provides a measure of one’s specific chronotype by yielding scores based upon responses to questions asking about sleep preferences rather than actual sleep practices. Based on their reported preferences, participants are then classified into one of five groups ranging from definitely evening to definitely morning. The MCTQ, however, provides a more sensitive measure because it includes analyses of sleep patterns for both work days and free days (Roenneberg et al., 2003). Zavada, Gordijn, Beersma, Daan, and Roenneberg (2005) conducted a comparison of these two questionnaires in a sample of over 2,000 Dutch participants, and we attempted to replicate their findings in a local sample.

To conduct the large-scale comparison of these two different chronotype measurements, we administered both the MEQ and the MCTQ to 638 participants as part of a previous study. After excluding some participants based on age (excluding anyone over 24 years) and

incomplete data, we yielded a sample of 493 participants. We found that average midpoint of sleep on free days (collected from the MCTQ) correlated most highly with scores on the MEQ ($r = -0.66$), which replicated Zavada et al. (2005; $r = -0.72$) and Roenneberg et al. (2007). This correlation suggests that as MEQ scores increase from eveningness to morningness, the midpoint of sleep on free days decreases. In other words, the closer one gets to morningness, the midpoint of the sleep period is earlier. Thus, if the MEQ is based on time-of-day preferences for activities and not necessarily on what people actually do, it makes sense that the highest correlation with the MEQ would be with the midpoint of sleep on free days—days in which people are free to choose when they go to bed.

Our results also matched Zavada et al.'s (2005) in terms of average MEQ score (47.18 versus 47.0, respectively) and average midpoints of sleep on both free (5:12am versus 5:23am) and work (3:50am versus 4:02am) days. Furthermore, our results are similar to those of Roenneberg et al.'s (2003) pilot study to assess the MCTQ which included 500 participants. The average midpoint of sleep for free days for their sample was 5:02am and the average midpoint of sleep for work days was 3:10am. Given the results of these studies, the current study used the MEQ scores as a way to classify participants into on-peak and off-peak groups, but we also administered the MCTQ and used it as a manipulation check for the group classifications. For example, if someone scores as an evening person based off of the MEQ in which responses are based on one's preferences, this does not necessarily mean that the person would be at his peak if he came into the lab to participate in a study at 6:00pm on a weekday. It could be that he has evening tendencies on the weekend when he is free to plan his days, but is sleep-deprived during the week because of weekday demands. Thus, what should be considered an on-peak time at 6:00pm might actually be off-peak because he is getting less sleep during the week. A more

useful way to use the questionnaires may be to first classify participants based on the MEQ, but then use the MCTQ midpoint of sleep times to make sure that there are not large discrepancies between the midpoint of sleep on work versus free days.

After participants were given instructions, they signed an informed consent form and completed the first of three GVA scales. Participants completed each task in the following order: first GVA scale; PRP experiment; second GVA scale; Memory experiment; third GVA scale; MCTQ; post-experiment questionnaire. The tasks remained in this fixed order for all participants in order to avoid introducing method variance, as is typical for research in individual differences (Carlson & Moses, 2001). Participants are typically exposed to identical experimental contexts so that individual performance can be compared with respect to each other. Individual differences (i.e., chronotype) were a crucial component of this research, and it was important to determine any effects due to these differences. The duration of the experiment was approximately 90 minutes; the PRP experiment lasted approximately 20 minutes, the Memory experiment lasted approximately 45-50 minutes, and the remaining time was spent filling out the questionnaires.

Chapter 4: PRP Experiment

Materials

All tasks were presented using E-Prime software (Schneider, Eschman, & Zuccolotto, 2002) on Dell desktop computers with 17-inch monitors. The stimuli consisted of one tone (stimulus 1, S1) and one letter (stimulus 2, S2) on each trial. The tone was a 800-Hz tone presented binaurally either once or twice via headphones at a comfortable listening volume, and the letter was either A, B, or C presented visually on the computer monitor in black ink Courier New font size 34 against a white background.

Design and Procedure

The design of this experiment incorporated elements from both Pashler and Johnston (1989) and Ruthruff, Pashler, and Klaassen (2001) studies. The experiment was divided into one practice block of 20 trials for the easy task, one practice block of 20 trials for the hard task, and one experimental block of each task type with 60 trials each. Additionally, three baseline blocks with 60 trials each were presented in which participants had to respond to the easy version of the tone only, the hard version of the tone only, and to the letters only. These baseline measures were included as a manipulation check to make sure that single-task performance was better than dual-task performance. Participants were told to respond to the tone before responding to the letter, and to respond to each task as quickly and accurately as possible. The order of blocks was the same for all participants and was as follows: practice easy, practice hard, experimental easy, experimental hard, baseline tone only easy, baseline tone only hard, baseline letter only. The order of blocks was kept the same so as not to introduce method variance; however, this could

also have introduced a limitation that may have affected the difficulty manipulation with the easy version of the task always occurring before the hard version.

At the beginning of each block of trials, a fixation cross was presented in the center of the computer monitor for 1000 ms to notify participants where the letter would be located. The tone (S1) was presented either once for 17ms or twice for 17ms each separated by 50ms, and following a variable SOA (100 ms or 1,000 ms), the letter (S2) appeared in the center of the screen for 2500 ms or until a response was made. Within each block, the stream of trials was constant. The letter presented on each trial was selected randomly without constraint, and each of the SOAs was used equally often in random order. The SOAs of 100 and 1,000 ms were chosen to maximize the chance of finding the PRP effect based on past findings (i.e., they were on the lower and higher ends of the SOAs typically used). As Pashler (1994a) explained, the time it takes an individual to respond to S2 becomes progressively greater as SOA is shortened. Once the SOA goes below 200ms, the slope between SOA and RT approaches -1 indicating that a response cannot be made to S2 until a certain amount of time has passed after S1 presentation. Thus, 100ms is below this threshold and should definitively result in the PRP effect when compared to the longer 1000ms SOA.

For the easy version of the task, participants, using their right hand and the keypad on the right side of the keyboard, made responses to S1 by pressing the “1” key for one tone or “2” key for two tones. Participants made responses to S2 by pressing either the “B” key for “A,” the “N” key for “B,” or the “M” key for “C” using their left hand. The letter remained on the screen until both responses were detected or until 2,500 ms has lapsed, whichever came first. For the hard version of the task, participants made responses to S1 by responding with the *opposite* number of tones (i.e., pressing the “2” key for one tone and the “1” key for two tones). Responses to S2

remained the same. The intertrial interval was 1000 ms. Participants were told to keep their fingers on the appropriate keys for the duration of each block.

For the first baseline block, participants were told to respond only to the tones (pressing “1” for one tone and “2” for two tones) presented and to ignore the letters. For the second baseline block, participants were again told to respond only to the tones and ignore the letters; this time they were responding with the number of the key opposite of the number of tones presented. Finally, for the third baseline block, participants were told to ignore the tones and respond only to the letters presented on the screen.

Following completion of this experiment and before starting the second experiment, participants filled out the second GVA scale.

Results and Discussion

Several analyses were conducted in order to investigate synchrony effects in the PRP paradigm. All analyses used an alpha level of 0.05 unless otherwise indicated. Two 2 x 2 x 2 mixed-model analyses of variance (ANOVA) were performed with SOA (100 ms/short and 1,000 ms/long) and difficulty (easy and hard) as within-subjects factors and synchrony (on-peak and off-peak) as a between-subjects factor. The dependent variables were accuracy of responses and RT. Trials with RTs exceeding the maximum (2500ms) and trials with incorrect responses were considered as errors and were excluded from the analyses. RTs faster than 200ms were also excluded as they were considered false responses (most of these were already excluded as incorrect response errors). These analyses were conducted for both Task 1 (tone task) and Task 2 (letter task); however, performance in Task 2 was the main focus of interest in this experiment. Baseline comparisons revealed that RTs were significantly faster in the baseline trials compared

to experimental trials for both the tone task and letter task, showing that participants, as expected, were slower to respond when they had to perform two tasks in quick succession compared to each task alone. Finally, statistics for any analyses yielding non-significant results can be found in Appendix B.

Tone Task (S1)

Descriptive statistics for the following analyses can be found in Table 1. Examining Task 1 first, a main effect of difficulty on accuracy was found; $F(1,72) = 34.90$, $MSE < 0.01$, partial $\eta^2 = 0.33$, with the easy tone task yielding a higher accuracy score ($M = 0.96$, $SE = 0.01$) than the hard task ($M = 0.92$, $SE = 0.01$), suggesting that participants responded with higher accuracy when the response keys matched the number of tones than when it was reversed. No other significant results were found with accuracy in Task 1.

Table 1. Average Accuracy and RTs for the Tone Task (S1) in Experiment 1 (Standard Deviations in parentheses).

		On-Peak		Off-Peak	
		Easy	Hard	Easy	Hard
Short SOA	Accuracy	0.95 (0.07)	0.92 (0.08)	0.97 (0.04)	0.93 (0.07)
	RT	719.59 (233.11)	828.92 (244.58)	723.34 (168.84)	835.43 (186.11)
Long SOA	Accuracy	0.96 (0.10)	0.91 (0.11)	0.97 (0.04)	0.93 (0.06)
	RT	757.67 (303.35)	874.47 (316.97)	779.29 (277.88)	905.57 (301.59)

A main effect of difficulty on RT was also found for Task 1, $F(1,72) = 64.30$, $MSE = 14602.63$, partial $\eta^2 = 0.47$, mirroring the effects on accuracy. Participants were faster to respond

during the easy version of the task ($M = 744.97\text{ms}$, $SE = 29.13$) compared to the hard version ($M = 861.10\text{ms}$, $SE = 30.94$). This is an important finding because it shows that the difficulty manipulation was effective. Participants were faster to respond when they had to make a response that matched the number of tones they heard; when they had to make a response opposite to the number of tones they heard, their response time slowed because they had to inhibit their initial tendency to respond a certain way.

There was also a main effect of SOA; $F(1,72) = 8.74$, $MSE = 21894.96$, partial $\eta^2 = 0.11$, with participants responding faster to the tones when they were followed by the shorter SOA ($M = 776.82\text{ms}$, $SE = 25.05$) than when the tones were followed by the longer SOA ($M = 829.25\text{ms}$, $SE = 35.08$). One interpretation of these results is that the quicker presentation of the letters following the short SOA influenced participants to respond faster to the tones in anticipation of responding to the letters. However, as will be shown later, quicker responses to the tones presented before the short SOA did not help with response time for the letters. Finally, no main effects were found for synchrony and no interactions were found in any of the Task 1 analyses.

Letter Task (S2)

Descriptive statistics for the following analyses can be found in Table 2. As stated previously, performance, specifically RT, in Task 2 was the main focus in this experiment. Examining the results for letter accuracy, there was a significant main effect of SOA; $F(1,72) = 17.39$, $MSE < 0.01$, partial $\eta^2 = 0.20$, with participants responding more accurately following the long SOA ($M = 0.97$, $SE = 0.01$) than the short SOA ($M = 0.95$, $SE = 0.01$). There was also a significant main effect of difficulty, $F(1,72) = 6.61$, $MSE = 0.01$, partial $\eta^2 = 0.08$. Participants responded to the letters with higher accuracy levels in the easy version of the task ($M = .97$, $SE < 0.01$) than the hard version ($M = .95$, $SE = 0.01$). However, the means produced a ceiling effect

as is typical in a PRP task, and the main effects were qualified by a significant interaction between SOA and difficulty, $F(1,72) = 4.02$, $MSE < 0.01$, partial $\eta^2 = 0.05$. According to a paired samples t-test, there was a larger decrease in accuracy following the short SOA in the hard version of the task (2.66% decrease) compared to the easy version (0.86% decrease), $t(73) = 2.03$, $p < 0.05$ (see Figure 5 for a depiction of the interaction). Interpreting these results together with the main effect of SOA in tone RTs suggests that participants' faster response to the tones when they were followed by the short SOA interfered with letter accuracy, but only in the hard condition.

Table 2. Average Accuracy and RTs for the Letter Task (S2) in Experiment 1 (Standard Deviations in parentheses).

		On-Peak		Off-Peak	
		Easy	Hard	Easy	Hard
Short SOA	Accuracy	0.96 (0.04)	0.92 (0.11)	0.98 (0.02)	0.95 (0.07)
	RT	940.07 (277.97)	1091.83 (307.51)	951.45 (200.08)	1096.89 (247.91)
Long SOA	Accuracy	0.97 (0.05)	0.94 (0.12)	0.99 (0.02)	0.98 (0.02)
	RT	534.97 (124.63)	579.78 (138.27)	548.21 (87.34)	584.39 (145.07)

Also of interest was a main effect of peak, $F(1,72) = 4.38$, $MSE = 0.01$, partial $\eta^2 = 0.06$. However, the results were opposite of what was expected; on-peak participants were less accurate in the letter task ($M = 0.95$, $SE = 0.01$) than off-peak participants ($M = 0.97$, $SE = 0.01$). Nevertheless, these results should be interpreted with caution because participants in both conditions showed a ceiling effect. In fact, the high accuracy rates found in the current experiment are quite common and similar to accuracy data from previous studies. For example,

the error rates in Pashler's (1994b) study ranged from 1.0%-4.3%, and the error rates in Ruthruff et al.'s (2001) study ranged between 2.2%-3.7%. Some researchers do not even report accuracy results because there does not seem to be a speed/accuracy tradeoff (e.g., Tombu & Jolicoeur (2002), and accuracy does not provide as much practical importance to this task as does reaction time.

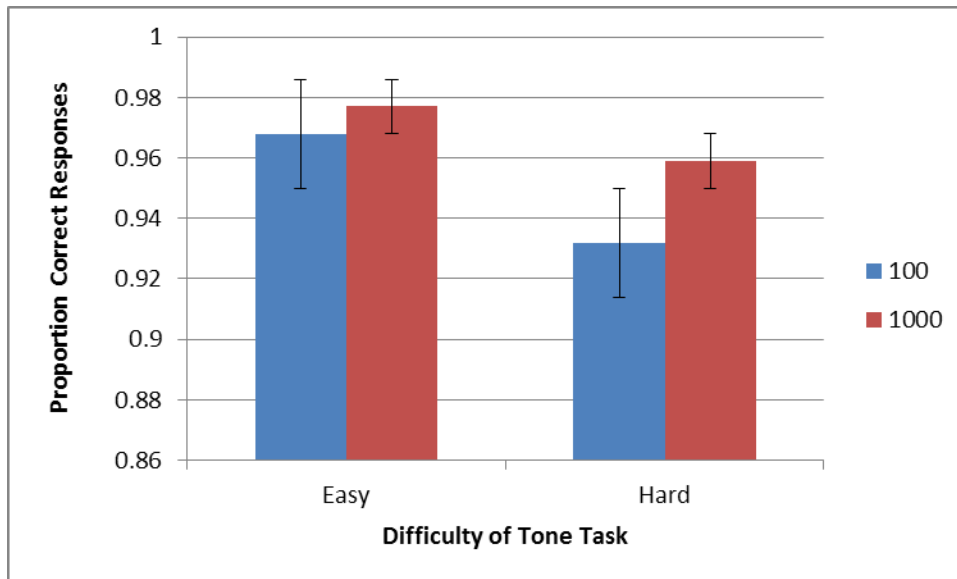

Figure 5. The accuracy in proportion-correct responses to S2 for each level of S1 difficulty following 100ms (short) and 1000ms (long) SOAs.

PRP Effect

In order to determine if there was a PRP effect in this experiment, similar analyses were conducted on RT in Task 2. A significant main effect was found for SOA; $F(1,72) = 489.99$, $MSE = 29833.66$, partial $\eta^2 = 0.87$, with participants responding faster to the letters following the long SOA ($M = 561.84\text{ms}$, $SE = 14.27$) compared to the short SOA ($M = 1020.06\text{ms}$, $SE = 31.10$), replicating the standard PRP effect. There was also a main effect of difficulty, $F(1,72) = 65.79$, $MSE = 9460.05$, partial $\eta^2 = 0.48$, with participants responding to the letters faster following the easy version of Task 1 ($M = 743.67\text{ms}$, $SE = 20.85$) than the hard version ($M =$

838.22ms, $SE = 24.28$). Similar to the accuracy results, these main effects were qualified by an interaction between SOA and difficulty, $F(1,72) = 37.61$, $MSE = 5408.39$, partial $\eta^2 = 0.34$.

According to a paired samples t-test ($t(73) = -6.35$, $p < 0.05$), the PRP effect was larger for the hard version of the task ($M = 512.22\text{ms}$) compared to the easy version ($M = 404.39\text{ms}$). Overall, participants were slowest to respond to the letters following the short SOA in the hard version of the task (refer to Figure 6 for a depiction of this interaction). No other significant effects were found in Task 2. Thus, although the size of the PRP effect was sensitive to the difficulty manipulation, the PRP effect was found regardless of the synchrony between chronotype and time of participation.

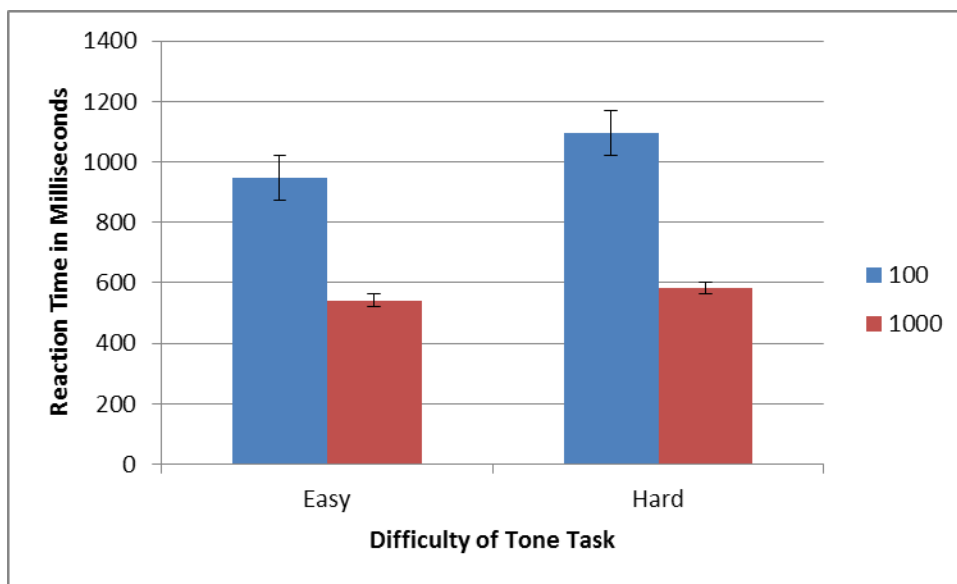

Figure 6. Reaction times to S2 for each level of S1 difficulty following 100ms (short) and 1000ms (long) SOAs.

Similar analyses were conducted using both chronotype (morning types or evening types) and time of participation (morning or evening) as between-subjects factors to see if these variables alone (rather than the synchrony of the two) influenced any of the results, but the same

pattern of findings emerged. There were no main effects of either chronotype or time of participation, and these factors did not interact with SOA or difficulty.

Regression Analysis

Rather than examining differences in on-peak versus off-peak, a hierarchical regression analysis was conducted using MEQ category (morningness/eveningness) as a dichotomous categorical variable to determine the extent to which MEQ scores predicted the PRP effect. The PRP effect was determined by subtracting RT in the long SOA condition from RT in the short SOA condition, yielding a difference score. A two-step hierarchical regression analysis using this difference score as the criterion variable was conducted. Number of hours of sleep the previous night, taken from the post-experiment questionnaire, was entered in step one to control for amount of sleep ($n = 63$ because the questionnaire was introduced after the start of the experiment and one participant did not answer the question). In step two, MEQ category was entered. Results for step one indicated that hours of sleep was not predictive of the PRP effect, $R^2 = 0.01$; $F(1,61) = 0.30$, *ns*. Additionally, MEQ category did not significantly predict the PRP effect, $\Delta R^2 = 0.03$; $F(2,60) = 1.08$, *ns*. Thus, even after controlling for the amount of sleep participants had the night before the experiment, one's chronotype was not a significant influence on the size of the PRP effect. Furthermore, after controlling for amount of time awake before participating in the experiment, MEQ category was not a significant predictor of the PRP effect, $\Delta R^2 = 0.02$; $F(2,59) = 2.39$, *ns* (62 participants reported time awake). For the morning sessions, Morning types woke up approximately 0.5 hours earlier than evening types, and for the evening sessions, Morning types woke up approximately two hours earlier than Evening types. However, this variable did not contribute to any variance in the PRP effect.

Results Split by Chronotype

In order to examine the data more closely, cases were split by chronotype and analyzed separately. In other words, synchrony effects were examined separately for Morning types and Evening types. One limitation that should be noted, however, is that group sizes were small and uneven for these analyses. Independent samples t-tests were performed with PRP effect as the dependent variable. Results did not reveal a significant effect for the evening types, $t(54) = -0.83$, $p = 0.41$. However, off-peak participants had a somewhat larger PRP effect ($M = 498.82$, $SD = 145.13$) than on-peak participants ($M = 455.72$, $SD = 196.68$). The result for Morning types also was not significant, $t(16) = 1.42$, $p = 0.17$, but on-peak participants had a slightly larger PRP effect ($M = 472.13$, $SD = 130.53$) than off-peak participants ($M = 384.15$, $SD = 130.42$), which is in the opposite direction of the performance of Evening types and the opposite direction of what was expected. These findings, although not statistically significant, are concerning because they seem to suggest that any type of synchrony effect that could be found in the larger sample is being masked by combining the two different chronotypes.

Chapter 5: Explicit Memory Dual Task Experiment

Materials

For the aurally-based primary task, 20 word lists, consisting of 15 monosyllabic words in each list, were created using the MRC Psycholinguistic database (Wilson, 1988). The average of the Kučera and Francis (1967) frequency ratings of the experimental words was 192.00 (ranged from 50-967), and the average of the concreteness ratings was 477.97 (ranged from 195-642). The number of letters ranged from three to six. These word lists can be found in Appendix C. The choice was made to use monosyllabic words in order to reduce the memory load given that there were 15 words in each list. Using Audacity software (2012), the words were recorded in a female voice, and the word durations ranged from approximately 550 ms to 1,000 ms per word. For the easy version of the task, each word in a list was presented twice during the encoding phase. For the hard version of the task, each word was presented once during the encoding phase. Experimenters manually recorded participants' verbal responses using a response sheet and then used the keyboard to type in the responses.

The assignment of the different lists was counterbalanced to the different recall/difficulty conditions. There were four lists that were always used for the practice trials. From the 16 remaining lists, four groups of lists were created such that each group was used approximately equally often in each of the memory-only easy, memory-only hard, dual easy, and dual hard conditions. However, the lists were not counterbalanced across synchrony or chronotype. The visual secondary keypress task was the same letter discrimination RT task as described in the PRP experiment; however, it was continuous and coincided with the recall phase of this experiment, lasting for 30 seconds.

Design and Procedure

Elements of the design of this study were guided by Rohrer and Pashler (2003). This experiment consisted of three conditions: keypress only (CRT), recall-only, and dual task (recall and CRT together). Participants were first run through two practice trials of the CRT task and two practice trials each of the recall-only task (one each of easy and hard) and the dual task (one each of easy and hard). Following the practice trials, participants completed four trials of each of the above memory conditions and eight trials of the CRT task for a total of 24 trials. The ordering of the trials was completely randomized by the computer program. For the memory-only task, participants were asked to remember as many of the presented words as possible for later recall, and for the reaction time task, participants were asked to press a specific key on the keyboard corresponding with each presented letter (the letters were selected randomly by the computer program). For the dual-task trials, participants were asked to respond to the letters while, at the same time, verbally recalling as many words as possible.

For the memory portion of the experiment, participants heard a list of 15 randomly presented words through headphones worn by each participant. The task difficulty manipulation was based on the repetition effect found in previous studies which have found that words that are repeated are better remembered than words that are presented only once. For example, Melton (1967), Waugh (1963), and Toppino, Hara, and Hackman (2002) found that recall of words that were presented twice in a list was higher than recall of words that were presented only once. Thus, for the difficult version of the task, one word was presented at a rate of 2s per word for a total of 30s of word presentation. For the easy version of the task, each of the 15 words in a list was presented twice at a rate of 2s per word for a total of 60s of word presentation. The words were randomly selected for presentation, meaning a word could be presented twice in a row or

spaced apart, depending on the randomization. Following each encoding phase, participants engaged in a distractor counting task for 30s (counting backwards from a randomly chosen three-digit number presented on the screen), which was followed by a 30s recall phase. Two question marks (e.g., ??) presented on the screen after the distractor task cued the beginning of the recall phase, and participants spoke aloud any words they remembered, in any order, from the most recently presented list. While participants were verbally recalling the words, the experimenter wrote down each word on a recall sheet, in the order that they were recalled. Each recall phase was also recorded through a microphone worn by the participant and saved into individual sound files on the computer. The recall period started as soon as participants vocalized a response, and it lasted for 30 seconds even if a participant could not recall any words (the participant and experimenter sat quietly through the duration of the 30s recall period if the participant stopped recalling before the recall phase ended). After the 30s recall phase was completed, the experimenter typed in all of the words recalled, even if a word did not appear in the list, using a secondary keyboard. For the dual-task condition, the word presentation procedure was the same as the memory-only condition. It was then followed by the same 30s, backwards counting distractor task. The question mark symbols indicated the start of the recall phase, and as soon as participants made their first verbal response, the first letter appeared on the screen at which time participants verbally recalled words while engaging in the CRT task using the keyboard. Again, the recall period lasted for 30s, and if a participant stopped recalling before the recall phase ended, he continued responding to the secondary RT task until the 30s elapsed. Once the recall phase ended, the experimenter typed in all words recalled.

Following the conclusion of this experiment, participants filled out the third and last GVA scale as well as the MCTQ and post-experiment questionnaire.

Results and Discussion

Several analyses were conducted in order to investigate synchrony effects in the Explicit Memory experiment. All analyses used an alpha level of 0.05 unless otherwise indicated, and statistics for any non-significant results can be found in Appendix D.

Memory Task

Descriptive statistics for the following analyses can be found in Table 3. A 2 x 2 x 2 mixed-model ANOVA was performed on the memory portion of the experiment with condition (single and dual task) and difficulty (easy and hard) as within-subjects factors and synchrony (on-peak and off-peak) as a between-subjects factor. The dependent variables were proportion correct recall and number of prior-list intrusions. Results of the analysis on proportion correct recall indicated a significant main effect of condition, $F(1,72) = 4.41$, $MSE < 0.01$, partial $\eta^2 = 0.06$. Participants recalled a greater proportion of words in the single-task condition ($M = 29.4\%$, $SE = 0.01$) than in the dual-task condition ($M = 27.8\%$, $SE = 0.01$); however, the average number of words recalled was relatively small in both conditions which suggests this may have been a more difficult memory task than intended. No other significant results were found for this analysis indicating that synchrony had no effect on memory recall. Results for the analysis on number of intrusions indicated a main effect of difficulty, $F(1,72) = 37.61$, $MSE = 5408.39$, partial $\eta^2 = 0.34$, with the hard version of the task yielding more intrusions ($M = 1.10$, $SE = 0.14$) than the easy version ($M = 0.79$, $SE = 0.10$). However, the number of intrusions in both versions was very small and may have also been due to the difficulty of the task. The majority of the errors reflected errors of omission. No other significant results were obtained for this analysis.

Table 3. Means and Standard Deviations (in parentheses) for Percent Accuracy of Recall and Number of Intrusions in Memory Task Only and Dual Task.

		On-Peak		Off-Peak	
		Easy	Hard	Easy	Hard
Memory Only	Accuracy	0.30 (0.12)	0.30 (0.13)	0.29 (0.08)	0.28 (0.13)
	Intrusions	1.09 (1.28)	1.22 (1.46)	0.71 (0.98)	1.07 (1.33)
Dual Task	Accuracy	0.29 (0.11)	0.29 (0.13)	0.28 (0.10)	0.25 (0.09)
	Intrusions	0.80 (1.00)	1.26 (1.34)	0.54 (0.88)	0.86 (1.04)

Similar analyses were also conducted with between-subjects factors of Chronotype (Morning types and Evening types) and Time of Participation (morning and evening). No significant effects were found for Chronotype on proportion correct recall, but there was a significant main effect of time of participation, $F(1,72) = 5.85$, $MSE = 0.04$, partial $\eta^2 = 0.08$. Participants who completed the experiments in the evening ($n = 56$) recalled significantly more words ($M = 30.8\%$, $SE = 0.01$) than participants who completed the experiments in the morning ($n = 18$; $M = 25.2\%$, $SE = 0.02$). Consistent main effects of difficulty were found for the analyses on number of intrusions; there were more intrusions for the hard version of the task than for the easy version when Chronotype ($M_{hard} = 1.14$, $SE = 0.16$; $M_{easy} = 0.81$, $SE = 0.12$) and Time of Participation ($M_{hard} = 1.11$, $SE = 0.14$; $M_{easy} = 0.76$, $SE = 0.10$) were used as factors. No other significant results were achieved.

Letter CRT Task

Descriptive statistics for the following analyses can be found in Table 4. Two separate 2 x 2 mixed-model ANOVAs were performed on the CRT portion of the experiment with

synchrony as the between-subjects factor for both analyses. For one analysis the within-subjects factor was condition (single and dual task) and for the other analysis, the within-subjects factor was difficulty of memory task (easy and hard). The dependent variables for both analyses were accuracy and RT of letter responses. Difficulty was run separate from type of condition because difficulty level did not exist in the CRT single-task condition. The difficulty was manipulated for the word recall portion of the task (one presentation of the words versus two presentations), so when participants completed the CRT task by itself, difficulty was not a factor and could not be analyzed.

Accuracy. For the 2 (Condition) x 2 (Synchrony) ANOVA on letter response accuracy, there was a moderate effect of condition, but it did not quite reach significance, $F(1,72) = 3.87$, $p = 0.05$. Performance in both conditions exhibited a ceiling effect; accuracy for the single task was $M = 0.97$ ($SE < 0.01$), and accuracy for the dual task was $M = 0.97$ ($SE < 0.01$). No other significant results were obtained for this analysis, and no significant effects resulted from the 2 (Difficulty) x 2 (Synchrony) ANOVA on letter response accuracy. Similar results were found for the main effect of condition when Time of Participation was a between-subjects factor, but this time the analysis did reach significance; $F(1,72) = 4.23$, $MSE < 0.01$, $\text{partial } \eta^2 = 0.08$ (the means were identical to the means in the previous analysis). Consistent main effects were found for difficulty when Chronotype and Time of Participation were used as between-subjects factors with accuracy being higher in the easy version of the task than the hard version. However, as with all other accuracy results, performance is at ceiling, so these results are difficult to interpret.

Table 4. Means and Standard Deviations (in parentheses) for Percent Accuracy and RTs of Letter Responses in Letter Task Only and Dual Task.

		On-Peak		Off-Peak	
Letter Task	Accuracy	0.97 (0.02)		0.97 (0.02)	
	RT	513.42 (71.81)		504.96 (49.74)	
Dual Task		Easy	Hard	Easy	Hard
	Accuracy	0.97 (0.03)	0.96 (0.04)	0.97 (0.03)	0.97 (0.04)
	RT	638.76 (121.58)	636.85 (119.10)	639.29 (170.96)	615.68 (150.54)

Reaction Time. The 2 (Condition) x 2 (Synchrony) ANOVA on letter response RT resulted in a significant main effect of condition, $F(1,72) = 99.12$, $MSE = 5352.11$, partial $\eta^2 = 0.58$, with participants responding faster in the single-task condition ($M = 509.19\text{ms}$, $SE = 7.72$) than in the dual-task condition ($M = 632.64\text{ms}$, $SE = 16.11$). A similar pattern emerged when Chronotype and Time of Participation were used as between-subjects factors, but no other significant results were found for these analyses. For the 2 (Difficulty) x 2 (Synchrony) ANOVA, the main effect of difficulty approached significance, $F(1,72) = 3.96$, $MSE = 1429.98$, partial $\eta^2 = 0.05$, $p = 0.05$. Reaction time in the easy version was slightly slower ($M = 639.02\text{ms}$, $SE = 17.03$) than in the hard version ($M = 626.26\text{ms}$, $SE = 15.79$). No other significant effects were found for this analysis, and no significant effects emerged when Chronotype was used as a factor.

For the 2 (Difficulty) x 2 (Time of Participation) ANOVA, there was a main effect of difficulty, $F(1,72) = 5.35$, $MSE = 1373.22$, partial $\eta^2 = 0.07$; participants responded faster in the hard version of the experiment ($M = 631.73\text{ms}$, $SE = 16.05$) than in the easy version ($M =$

646.48ms, $SE = 17.05$). However, this main effect was qualified by a significant interaction between difficulty and time of participation, $F(1,72) = 5.96$, $MSE = 8182.10$, partial $\eta^2 = 0.08$. Bonferroni-adjusted pairwise comparisons indicated that there was no difference in RT between the difficulty levels for the participants who completed the experiment in the evening (a 0.82ms difference), but participants who completed the experiment in the morning responded significantly slower in the easy version of the memory task compared to the hard version (a 30.33ms difference). One possible explanation for these results is that individuals who participated in the morning were more focused on trying to recall words in the easy version of the memory task which negatively affected their RT to the secondary task. If this was the case, however, it unfortunately did not lead to a higher recall percentage for these individuals. A visual depiction of this interaction can be found in Figure 7. No other terms from this analysis were significant.

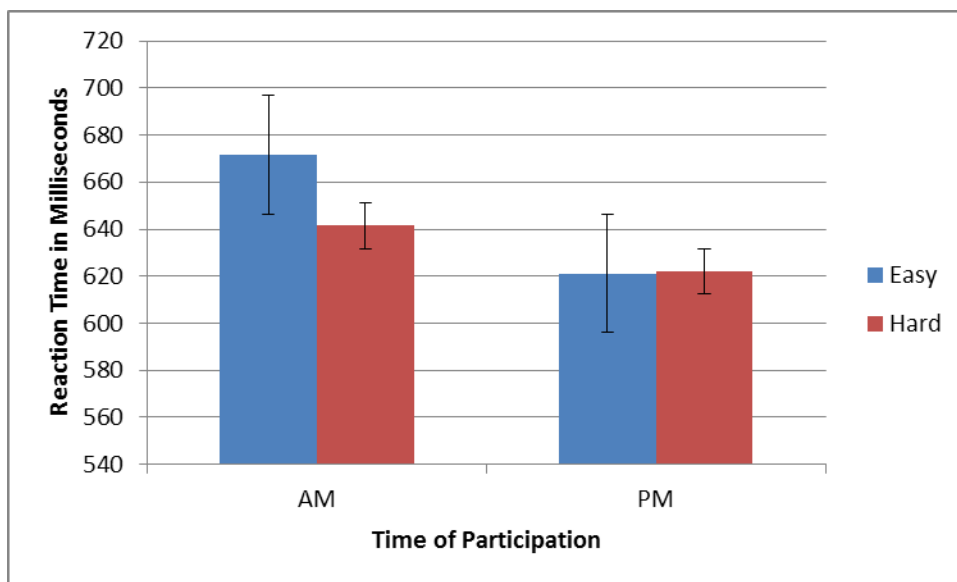

Figure 7. Reaction times to letters in the morning and evening experimental sessions during the recall phases of the easy and hard memory tasks.

Regression Analyses

Two hierarchical regression analyses were conducted to determine if MEQ score was a significant predictor of dual task costs in the Explicit Memory experiment. MEQ score was divided into two categories, morningness and eveningness, and used as a categorical variable. Dual task cost for recall was calculated by subtracting the proportion of correct word recall in the single-task trials from the proportion of correct word recall in the dual-task trials (both from the easy version), yielding a difference score. Dual task cost for letter response RT was calculated by subtracting the mean single-task RT from the mean dual-task RT, yielding a separate difference score.

For the first hierarchical regression, number of hours slept was entered in step one to control for amount of sleep the participants self-reported from the night before. The variable MEQ category was entered in step two as the predictor variable, and the dual-task cost difference score was used as the criterion variable. Neither the first model, hours of sleep ($R^2 = 0.04$; $F(1,61) = 2.71$, *ns*) nor the second model, MEQ category ($\Delta R^2 = 0.00$; $F(2,60) = 1.34$, *ns*) was a significant predictor of dual-task costs for recall. Thus, even after controlling for amount of sleep the night before the experiment, MEQ did not predict performance. Similar results were obtained for dual-task costs of RT; after controlling for amount of sleep ($R^2 = 0.02$; $F(1,61) = 1.19$, *ns*), MEQ category did not predict dual-task costs to a significant degree ($\Delta R^2 = 0.00$; $F(2,60) = 1.05$, *ns*). These results again suggest that, even after controlling for the amount of sleep that participants received the night before the experiment, one's chronotype did not predict dual-task costs. Similar results were obtained when controlling for the amount of time awake before the experiment (62 participants reported time awake; memory costs: $\Delta R^2 = 0.00$; $F(2,59) = 0.50$, *ns*;

RT costs: $\Delta R^2 = 0.01$; $F(2,59) = 0.58$, *ns*). Thus, results were not affected by amount of sleep nor by the amount of time awake.

Results Split by Chronotype

The data were again split by chronotype to examine Morning and Evening types separately, and both percent correct word recall and RT on the letter task were examined. The ANOVA for the memory task did not reach significance for Evening types, $F(1,54) = 2.51$, $p = 0.12$ nor Morning types, $F(1,16) = 3.58$, $p = 0.08$. However, Evening on-peak participants trended towards recalling a greater proportion of words ($M = 31.1\%$, $SE = 0.02$) than Evening off-peak participants ($M = 26.7\%$, $SE = 0.02$) while Morning on-peak participants trended towards recalling less words ($M = 21.8\%$, $SE = 0.03$) than Morning off-peak participants ($M = 29.5\%$, $SE = 0.03$).

The ANOVA for the CRT task also did not reach significance for the Evening types, $F(1,54) = 0.80$, $p = 0.37$, nor the Morning types, $F(1,16) = 1.94$, $p = 0.18$, but the means are again trending in specific directions. Evening types were slightly faster to respond to the letters during on-peak times ($M = 573.25$, $SE = 13.54$) than off-peak ($M = 594.65$ ms, $SE = 19.68$), but Morning types were marginally faster to respond during off-peak times ($M = 515.06$, $SE = 34.36$) compared to on-peak ($M = 586.84$, $SE = 38.41$). Similar to the results of these analyses in Experiment 1, Morning types are behaving differently than Evening types and in the opposite direction of the predictions. Combining these two groups together could be masking any effects that would otherwise be found by looking at them separately. In fact, the results suggest that these trends could be exhibiting time of day effects rather than synchrony effects because both morning and evening participants are showing greater performance during the evening than the

morning. However, more data would need to be collected with more participants in each group in order to make this conclusion.

Results and Discussion of Additional Measures

GVA Scale

The GVA Scale was administered to detect changes in subjective alertness and mood and was given three times over the course of the experimental session. It should also be noted that data collection had already started before the introduction of this questionnaire; thus for the following analyses, $n = 64$ rather than 74.

Table 5. Means and Standard Deviations for Ratings on Each Subscale on the GVA Scale at Each Time Period.

	On-Peak			Off-Peak		
	Time 1	Time 2	Time 3	Time 1	Time 2	Time 3
Global Vigor	6.85 (1.48)	6.15 (1.63)	5.33 (1.87)	6.16 (1.60)	5.80 (2.04)	4.96 (1.84)
Global Affect	7.49 (1.41)	7.26 (1.43)	6.72 (1.49)	7.00 (1.80)	6.64 (1.66)	6.60 (1.92)

Synchrony. Descriptive statistics for this analysis can be found in Table 5. A 3 x 2 x 2 mixed model ANOVA was conducted with time of completion (Time 1, Time 2, Time 3) and subscales (Vigor Index, Affect Index) as within-subject factor and Synchrony as a between-subjects factor. The dependent variable was average rating on the VAS and could range from 1-10, with higher scores indicating higher alertness and mood. Results indicated that there was not a significant main effect of synchrony, $F(1,62) = 1.94, p = 0.17$. Average ratings on the GVA Scale were similar for on-peak ($M = 6.63, SE = 0.20$) and off-peak ($M = 6.19, SE = 0.25$) participants. Mauchly's Test of Sphericity indicated that the assumption of sphericity had been

violated for time of completion, $\chi^2(2) = 12.82, p = .002$; therefore Huynh-Feldt estimates of sphericity ($\epsilon = 0.88$) were used to correct the degrees of freedom. Results indicated a significant effect of time, $F(1.75, 108.55) = 33.24, MSE = 0.99, \text{partial } \eta^2 = 0.35$; Bonferroni post-hoc tests revealed that the GVA ratings significantly decreased from Time 1 ($M = 6.87, SE = 0.16$) to Time 2 ($M = 6.46, SE = 0.17$) to Time 3 ($M = 5.90, SE = 0.18$). There was also a significant main effect of subscale, $F(1, 62) = 27.47, MSE = 3.84, \text{partial } \eta^2 = 0.31$ with higher ratings for the Affect Index ($M = 6.95, SE = 0.18$) compared to the Vigor Index ($M = 5.88, SE = 0.19$). Importantly, both of these effects were qualified by a significant interaction between time and subscale, $F(2, 124) = 5.03, MSE = 0.95, \text{partial } \eta^2 = 0.08$ (refer to Figure 8 for a depiction of this interaction). According to Bonferroni-corrected post hoc comparisons, ratings on the GV scale decreased significantly from Time 1 to Time 2 to Time 3, and ratings on the GA scale decreased significantly from Time 1 to Time 3, but there was no significant difference in ratings between Time 1 and Time 2 nor between Time 2 and Time 3.

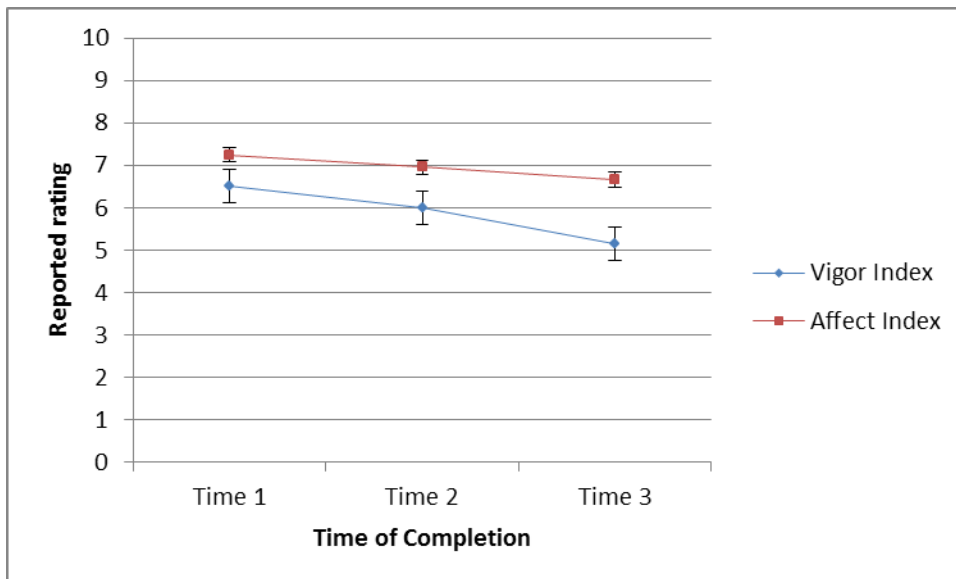

Figure 8. Reported ratings on the Vigor and Affect subscales of the GVA Scale at each time period.

Time of Participation. Another 3 x 2 x 2 mixed-model ANOVA was performed on average ratings with time of participation as the between-subjects factor. Tests revealed the same pattern of results as were found in the previous analysis (i.e., main effects of time and subscales as well as an interaction between the two); additionally, a significant main effect of time of participation was also obtained, $F(1,62) = 4.56$, $MSE = 8.74$, partial $\eta^2 = 0.07$. Participants in the evening sessions reported higher ratings ($M = 6.69$, $SE = 0.18$) of both alertness and mood than did participants in the morning sessions ($M = 6.00$, $SE = 0.26$).

Chronotype. A third mixed-model ANOVA was carried out on GVA scale ratings using Chronotype as the between-subjects factor. After determining that sphericity had been violated ($\chi^2(2) = 12.77$, $p = 0.00$), the Huynh-Feldt correction ($\epsilon = 0.88$) was used to correct for degrees of freedom. Again, a similar pattern of results emerged for the main effects of time and subscale and the interaction between the two. Interestingly, the three-way interaction between Chronotype, time of completion, and GVA subscale also reached significance, $F(1.99,123.34) = 3.56$, $MSE = 0.91$, partial $\eta^2 = 0.05$. According to Bonferroni-adjusted pairwise comparisons run separately for each chronotype, Evening-types' ratings on the GV subscale significantly decreased at each time period, and their ratings on the GA subscale only differed significantly from Time 1 to Time 3, but not Time 2. For Morning types, ratings on the GV subscale significantly differed from Time 1 to Time 3 and from Time 2 to Time 3. Morning types rated their GA subscales similarly at each time period. Figure 9 shows a visual depiction of this interaction. According to an independent samples t-test, the decrease in vigor scores from Time 1 to Time 3 was significantly greater for Morning types (2.42 point difference) than Evening types (1.15 point difference), $t(62) = -2.32$, $p < 0.05$. This may help to explain why Morning types

exhibited a trend towards asynchronous effects—they subjectively reported a larger decrease in alertness over the course of the experiment than did Evening types.

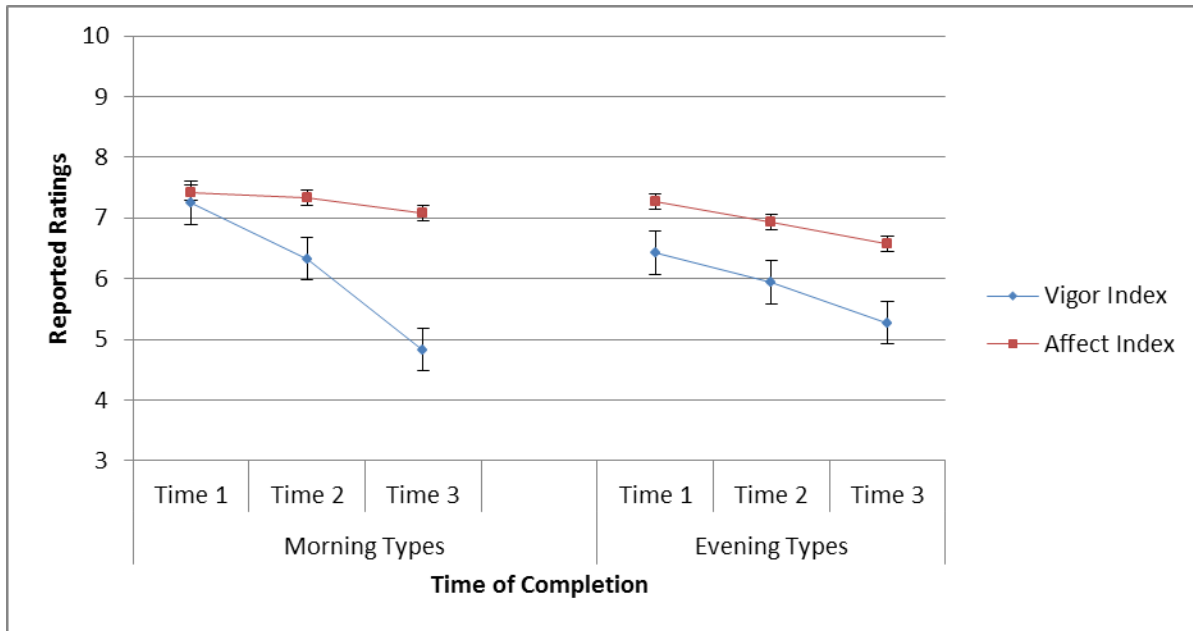

Figure 9. Reported ratings on the Vigor and Affect subscales of the GVA Scale at each time period by Chronotype.

Given the main effect of time of participation mentioned above, and this three-way interaction, a 3 x 2 x 2 x 2 ANOVA was run with both Chronotype and Time of Participation entered as between-subject factors and Time and Subscale entered as within-subject factors. Mauchly’s Test of Sphericity showed that sphericity had been violated, $\chi^2(2) = 10.87, p = 0.00$, so degrees of freedom was corrected using the Huynh-Feldt estimation ($\epsilon = 0.92$). The most interesting finding was a three-way interaction between time, chronotype, and time of participation, $F(1.85, 110.73) = 3.90, MSE = 3.53, \text{partial } \eta^2 = 0.06$. According to Bonferroni-adjusted post hoc comparisons for each chronotype collapsed across subscale, GVA scale ratings decreased significantly from Time 1 to Time 3 for Evening types who participated in the morning sessions, and ratings decreased significantly between Time 1, Time 2, and Time 3 for

Evening types who participated in the evening. Morning types who participated in the morning significantly decreased their ratings from Time 1 to Time 2 to Time 3, and those who participated in the evening kept their ratings roughly the same at each time period. Figure 10 illustrates this interaction. These results were not found, however, when synchrony, which includes both chronotype and time of participation, was used as a factor. These results may help to explain why Morning types, who exhibited a decrease in alertness and mood in the morning but not the evening, exhibited worse task performance in the morning (which is usually considered an on-peak time of day for this group) than in the evening.

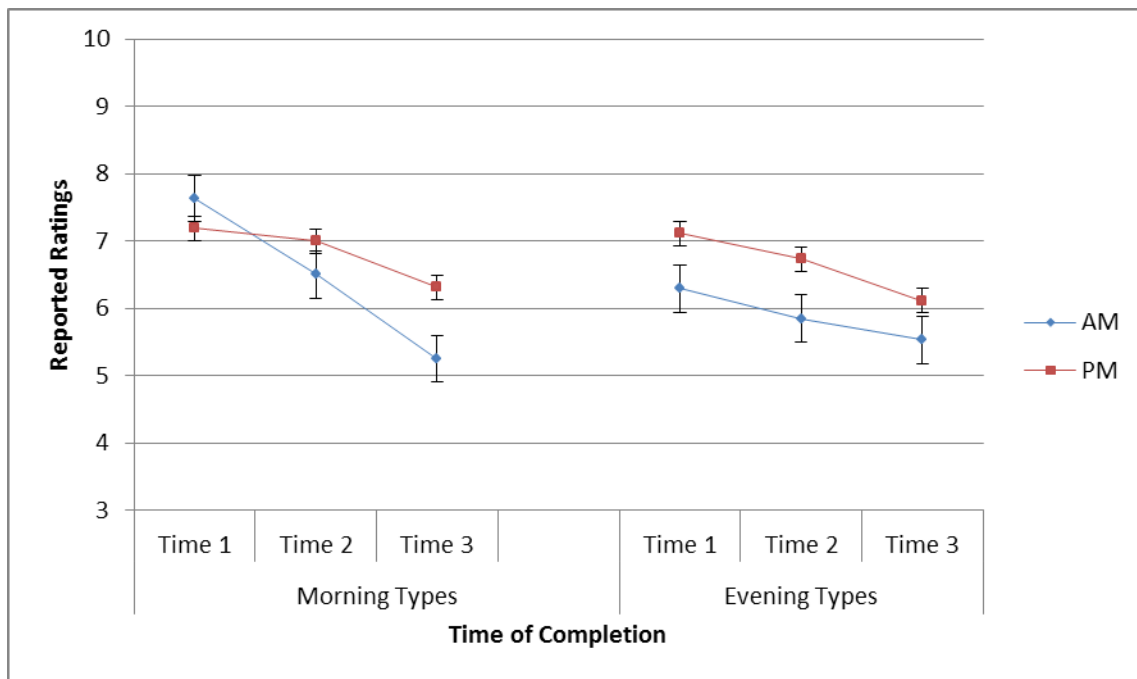

Figure 10. Reported ratings on the GVA Scale at each time period during the morning and evening sessions by Chronotype.

Regression Analyses. Several regression analyses were conducted to determine if alertness level predicted dual-task costs in these experiments. As with the previous analyses, $n = 64$ because not all participants completed the GVA scales. First, difference scores were created using the Vigor subscale of the GVA. To determine a change in alertness level between the

beginning of the PRP experiment and the end, scores on the Vigor index at Time 2 were subtracted from scores at Time 1. A higher difference score suggests a larger decrease in alertness. A bivariate regression was conducted, where the difference score was entered as the independent variable and the PRP effect score was entered as the dependent variable. The results were statistically significant ($R^2 = .068$, $F[1,62] = 4.52$, $p < .05$), indicating that a change in alertness from Time 1 to Time 2 accounted for 6.8% of the variance in the PRP effect.

The difference score between Time 2 and Time 3 was also created to be used for regression analyses in the Memory experiment. Two bivariate regressions were run in which the difference score was used as the independent variable and the dual-task costs for recall and for RT were used as dependent variables. The results for recall were statistically significant, ($R^2 = .073$, $F[1,62] = 4.88$, $p < .05$) indicating that a change in alertness from Time 2 to Time 3 accounted for 7.3% of the variance in dual-task costs for recall performance. The results for RT performance were not statistically significant.

MCTQ

The MCTQ was used as a manipulation check for the MEQ. Descriptive statistics for parameters of the MCTQ can be found in Table 6; all times were coded using the 24-hour scale. Following the work of Zavada et al. (2005), scores on the MEQ were compared with responses from the MCTQ. Both midsleep on work days (MSW; $r = -0.60$) and midsleep on free days (MSF; $r = -0.67$) correlated significantly with MEQ score (the negative correlations signify earlier mid-sleep times as MEQ scores increase to greater morningness). Furthermore, MSF was the most strongly correlated of any of the variables collected from the MCTQ, replicating the findings of both Zavada et al. and Briganti and Elliott's (in preparation) previous large-scale comparison. A regression analysis was then conducted to determine the extent to which MSF

predicted categories from the MEQ. According to the results, MSF significantly predicted MEQ category, $\beta = -0.66$, $t(74) = -7.47$, $p < 0.01$. MSF also explained a significant proportion of variance in the MEQ, $R^2 = 0.44$, $F(1,72) = 55.76$. These results suggest that chronotype as measured by the MCTQ is closely related to morningness-eveningness as measured by the MEQ; thus, the MEQ was confirmed to be a reliable measure of chronotype. Furthermore, similar to the results using MEQ scores, MSF was not a significant predictor of the PRP effect or dual-task costs.

Additionally, it was of interest to see participants who keep a more consistent schedule throughout the week may be a more useful sample in these types of experiments than those who have an inconsistent schedule, so the difference between mid-sleep on free and work days was examined. Results of multiple regression analyses showed that the difference scores in midpoints of sleep between free and work days was not a significant predictor of dual-task costs. Although utilizing both measures provided important additional information about the sample of participants, the MCTQ did not seem to result in better classification of chronotypes.

Table 6. Means, Standard Deviations, and Correlation Coefficients of Some Parameters of the MCTQ with MEQ Score.

		Work Days				Free Days			
	MEQ Score	Sleep Onset	Mid-sleep	Sleep Offset	Sleep Duration	Sleep Onset	Mid-sleep	Sleep Offset	Sleep Duration
<i>Mean</i>	42	12:19	4:10	8:01	7.68h	1:46	5:56	10:05	8.31h
<i>SD</i>	11.88	1.23	1.14	1.22	1.27	1.29	1.43	2.16	1.72
<i>r</i>	--	0.56**	-0.60**	-0.46**	0.19	0.48**	-0.67**	-0.62**	-0.31**

Note: ** indicates $p < 0.01$; *Ms* indicate morning times, except for sleep durations; sleep durations and *SDs* indicate hours. All times were coded using the 24-hour scale.

Chapter 6: General Discussion

The main goal of the current study was to investigate synchrony effects utilizing dual-task paradigms to determine if attentional resources are divided among the tasks differently depending on synchrony between chronotype and time of participation. Another goal was to determine if there was also a difference in resource allocation depending upon the difficulty of the primary task. The two experimental paradigms that were used included PRP and Explicit Memory, and each one had an easy and a hard version. For the easy version of the PRP experiment, participants had to press the number key that corresponded to the number of tones presented, and for the hard version, participants had to press the number key that corresponded to the opposite of the number of tones presented. For the easy version of the Memory experiment, words were presented twice within each list, and for the hard version words were presented only once within each list. Overall, synchrony effects were not found in the current dual-task experiments as expected, but there may be several reasons why the predictions were not supported.

Summary of Findings

Experiment 1

An overall PRP effect was found in this experiment; participants were slower to respond to the letter discrimination task (S2) when it followed the short SOA compared to when it followed the long SOA. Because the 100ms SOA was so short, participants were still processing the tones (S1) when S2 was presented; thus, the response rate of S2 increased and could not take place until S1 was given a response. The main effect of SOA interacted with difficulty in that the increase in response times to the letters following the short SOA was more pronounced in the

hard version of the experiment. Also, the difficulty manipulation was confirmed because both higher accuracy and decreased RTs to the tones were found in the easy version of the task.

Nevertheless, contrary to the prediction, participants who completed this task at an off-peak time did not show a larger PRP effect than participants who completed it during an on-peak time. Thus, when participants were tested non-optimally, they exhibited the same postponement in cognitive processing of S2 that optimally tested participants exhibited. In other words, participants tested at off-peak times of day did not respond slower following the short SOA than on-peak participants. The only significant effect that was obtained with synchrony was accuracy in the letter task. Off-peak participants responded more accurately than on-peak participants, but the means from both groups were at ceiling, so this result cannot be interpreted unequivocally. Furthermore, use of MEQ categories showed that chronotype was not a significant predictor of the PRP effect, even after controlling for the amount of sleep participants received the night before the experiment. Finally, even when using chronotype as a factor and time of participation as a factor, no new significant findings emerged.

One interesting finding to emerge from this experiment is that level of alertness was an important factor in predicting the PRP effect, not chronotype. More specifically, the difference in vigor before the PRP experiment compared to after explained a significant proportion of variance in the PRP effect. As participants' reported alertness level decreased, the PRP effect increased, which suggests some individual variability within the sample. However, alertness did not change with synchrony as expected.

Experiment 2

For the memory portion of Experiment 2, participants recalled more words in the single-task condition than in the dual-task condition; however, the difference was only 1.8% more

words. Given that the percentage of words recalled in both conditions was relatively low (around 30%), the overall task may have been more difficult than originally intended. Furthermore, the difficulty manipulation did not seem to work because there was no real difference in the amount of words recalled between the easy and hard versions of the task. The only difference between the two versions of the memory task was in the number of prior-list intrusions, but even those were extremely low. When time of participation was used as a factor in the analyses, individuals who participated in the evening sessions recalled about 5% more words than those who participated in the morning sessions, which showed that these college students had better recall performance in the evening. However, there was no influence of one's chronotype or synchrony in any of these analyses, suggesting that participants did not allocate attentional resources differently during optimal times of the day compared to non-optimal times.

Just as in the PRP task, accuracy in the letter task for this experiment was high, reaching around 97% correct. However, participants responded significantly faster in the single-task condition compared to the dual-task condition, and participants who completed the experiment in the morning responded slower in the easy version of the task whereas there was no difference in RT between the difficulty levels for participants who completed the experiment in the evening. One explanation for this finding was that morning-session participants allocated more attentional resources to the recall portion of the task which increased their RT to the letter task; however, these participants did not recall significantly more words in the easy version of the task, so this explanation is not fully supported.

Finally, while MEQ category was not a significant predictor of dual-task costs in this experiment, the difference score in alertness levels between Time 2 and Time 3 was a significant predictor of dual-task costs in recall. In other words, as participants became less alert over the

course of Experiment 2, dual-task cost for the memory portion increased. Alertness levels were not related to synchrony as expected.

Is Past Research Truly About Synchrony Effects?

The majority of past research has shown synchrony between chronotype and time of testing can influence measures of explicit memory (e.g., May et al., 1993), implicit memory (e.g., May et al., 2005; Rowe et al., 2006), and efficiency of inhibition, or the ability to ignore distractions (e.g., May & Hasher, 1998). However, participants' chronotypes in these studies were confounded by age, in that Evening types were all younger adults and Morning types were all older adults. The researchers admitted that they were unable to incorporate fully crossed designs because of the extremely small number of Evening older adults and Morning younger adults (also a problem encountered in the current study). One could argue that these effects are primarily due to the time of testing and age of the participants, rather than synchrony between the two, per se. For example, it may be the case that younger adults perform more efficiently in the evening and older adults in the morning, regardless of their actual chronotype. One general conclusion from these studies is that younger and older adults performed similarly in the morning, but there are robust age differences in the afternoon—young adults' performance improves in the afternoon compared to the morning whereas older adults' performance deteriorates. Thus, the magnitude of age differences increases in the afternoon compared to the morning. Synchrony effects may be important mainly in determining age differences that may otherwise be either masked or overestimated because time of participation is not usually addressed in cognitive research. Furthermore, the Evening type participants in the current study showed patterns similar to the Evening type participants in these previous studies (though the effects in the current study were not significant); it was the Morning type younger adults who

showed a trend towards the opposite effects. It is difficult for researchers of these prior studies to conclude that synchrony effects are not tied into age because they were deliberate in choosing only Evening type younger adults and Morning type older adults as participants. However, they do admit that the impact of synchrony may be greater for older adults than younger adults, at least in some tasks (e.g., inhibitory functioning; May & Hasher, 1998).

The current study was an attempt to find synchrony effects in a population of strictly college students, with the assumption that if synchrony effects are independent, then age of the participants should not be a significant factor. In other words, if synchrony effects were to exist in the past experiments, then they should be found even when using only college students. The results obtained in the current study, however, did not support the prediction that on-peak participants would be more efficient at allocating attentional resources to multiple tasks compared to off-peak participants. As stated previously, there are several possible reasons why synchrony effects were not found in the current experiments. One reason is that synchrony effects do not exist in dual-task paradigms and cannot be found. Another possibility is that synchrony effects are confounded with age, and that the effects would only be found when including both younger and older adults as participants. A third possibility is that college students are a unique population with regard to chronotype because of their inconsistent daily schedules, so it would be difficult to find synchrony effects in any type of assessment when utilizing only college students.

Limitations of the Current Study

There are several issues to consider as possible limitations in this study. First, great effort was taken to ensure that the two synchrony groups would include true Morning types and true Evening types, a choice which also justified the exclusion of Neither types. One possibility of the

inconsistent results of previous studies using college students is that this distinction was not well-defined because of the inclusion of Neither types in some studies (e.g., Bodenhausen, 1990 and Song & Stough, 2000 used a median split of MEQ scores to determine groups). However, restricting the types to just morning and evening resulted in uneven sample sizes between the two groups. In fact, the final analyses included 39% more on-peak than off-peak participants. This is mainly the consequence of so many college students scoring as Evening types (68% of participants in this study) and participating in evening sessions (roughly 76% of the final sample participated in the evening sessions. It seems as though Hasher and colleagues utilized the “best case scenario” by including both older and younger adults to form synchrony groups whereby younger adults were truly Evening types and older adults were truly Morning types. In fact, for several of the studies, the average MEQ scores for the Evening and Morning groups averaged closer to the Definitely Evening range (16-30) and the Definitely Morning range (70-86), respectively than in the current study which had more Moderate values. For example, May et al.’s (1993) participant MEQ means were 29.3 for Evening types and 70.2 for Morning types; Hasher et al.’s (2002) means were 19.7 and 67.3, and May et al.’s (2005) means were 27.6 and 68.2, respectively. In the current study, the means were 35.73 for Evening types and 61.50 for Morning types which may be one reason why synchrony effects were not found in dual-task costs.

Another limitation is that, even though MEQ seems to be a reliable measure of chronotype, there were no differences in levels of alertness (as measured by the GVA) between the on-peak group and the off-peak group. According to chronotype research, one of the reasons individuals perform better during optimal times is because of an increased level of arousal or alertness. If the on-peak and off-peak groups did not differ in their arousal levels, then this may

explain why there were no meaningful differences in performance between the two groups. It would be useful in future studies to support chronotype classifications with actual physiological measures, such as body temperature. The MEQ was originally externally validated using recordings of participants' body temperature; however, only oral temperature was only collected for 48 of the 150 participants who completed the questionnaire. It could very well be the case that the MEQ is not as valid a measure as was once thought, and that Hasher and colleagues are findings their results because of some other difference factor present between young and older adults apart from their chronotype. This possibility should be examined further, as well as the possibility that chronotype would be more appropriately used as a continuous variable rather than as strict categories. Given that the majority of the population scores as Neither types, it seems unfair to exclude them from the bulk of these studies.

One limitation of the PRP study is that the order of the easy and hard versions of Task 1 was not counterbalanced. All participants received the easy version followed by the hard version. This ordering of the tasks may have influenced the perception of difficulty. In other words, if participants became accustomed to the easy version of the task, then the opposite tone-mapping of the hard version may have been perceived as even more difficult. This could have resulted in the significant difference between the two conditions, rather than the manipulation, per se. On the other hand, one could argue that participants should have become better at the task, even the hard version, because of practice effects. This limitation may not have greatly affected the results, however, because participants were aware of the hard condition; they received a practice block of each condition before the experimental blocks, so they were not first introduced to the hard version of the task after completing all of the easy trials.

Although the memory portion of Experiment 2 was not the main focus, it should be mentioned that the difficulty of this task may have led to low recall rates. For example, once participants realized that they could no longer recall words, they may have stopped trying and thus concentrated more on the secondary CRT task. This would suggest a possible strategy change and may have influenced the results by deflating the average response time on the dual-task trials. Once participants started concentrating more on the CRT task, they would become faster and thus the average RT of each trial would decrease compared to when participants were also trying to recall words. Furthermore, in typical divided attention memory tasks, the average free recall in the single-task conditions is usually much higher than what was found in the current study (e.g., an average of 9 out of 15 words in Craik et al., 1996; an average of 8 out of 12 words in Naveh-Benjamin et al., 2000). Although past studies have shown that memory retrieval is not greatly affected when divided attention is at retrieval, the averages in all conditions in the current study were lower than what is typically found. Furthermore, the difficulty manipulation did not work in the current experiment. For the easy version of the task, participants were provided with two occurrences of each word in a list, but this did not increase the percentage of words recalled compared to a single presentation of the words in the hard version. One possibility is because the words were randomly presented, and past research has shown that the greatest benefit of repetition is when multiple presentations of a word are spaced rather than massed (e.g., Toppino et al., 2002). This was not controlled for in the current experiment.

Future Directions and Conclusions

One of the biggest concerns within this literature that was not resolved in the current study is the inconsistent results that have been found when using solely young adults (i.e., college students) as participants. Given that there were no effects of synchrony in the current

study, there still remains the question of whether college students are a unique population when it comes to synchrony effects. Unlike older adults who are in the working world, and young children who go to school at the same time every morning, college students tend to have a rather unpredictable schedule, depending both on class schedules and work schedules (for students who work while in college). For example, college students tend to have more variable schedules because of having different classes on different days of the week, possibly waking up at different times each day, and working and studying around their class schedules. Children, on the other hand, go to school at the same time each day and usually have designated bedtimes, and older adults usually go to work at the same time each morning and retire to bed more consistently each night (and even for retired older adults, they still usually wake up and go to bed on a more consistent schedule).

Consequently, the MEQ may be more sensitive to these extreme groups because their preferred times, which the MEQ assesses, most likely match their actual times more closely than for college students. This may also explain why many of the studies that have found chronotype synchrony effects are those that have included older adults in their samples as the Morning types and younger adults as the Evening types, rather than including Morning and Evening younger adults only. Future studies should continue to examine this issue to see if it can be resolved. Perhaps using young adults who are not in college but rather who are working full time and have consistent schedules, similar to older adults, would provide a better sample. Other possible samples to investigate include young adults who are enrolled in GED programs in adult education centers and those who attend community college, rather than the traditional college student. Furthermore, as May and Hasher's (1998) distribution (Figure 3) shows, the majority of college students are Neither types whereas the majority of older adults are Morning types. Many

of Hasher and colleagues' participants scored closer to the extremes (Definitely Morning and Definitely Evening) than the participants in the current study, so Hasher and colleagues were better able to maximize the differences in chronotype compared to the current study.

Another avenue of future research would be to include Neither type participants, especially because the majority of young adults score as Neither types. It is possible that we are missing out on useful information by not including this large group of individuals. There are limited findings that suggest that cognitive performance of Neither types does not vary across the day (May & Hasher, 2004 as cited in Rowe et al, 2006; Rowe et al, 2006). However, one could argue that Neither types were not tested at their true on-peak and off-peak times because the time of testing was still in the morning and in the evening. It is possible that Neither types perform similarly in the morning and in the evening because their arousal levels peak mid-day which is between those two time periods. Nevertheless, more research is needed to investigate this possibility.

Another reason to more fully investigate how Neither types perform is to disentangle chronotype effects from merely time-of-participation effects. When looking at synchrony separately for Morning and Evening participants in the current study, results showed a pattern of Evening types exhibiting the traditional synchrony effects but Morning types exhibiting reverse synchrony effects. It may be the case that, at least for college students, chronotype is a more important factor in influencing cognitive ability than synchrony. There is some evidence from previous studies to support this idea. For example, Preckel, Lipnevich, Schneider, and Roberts (2011) showed in a meta-analytic investigation that eveningness had a positive relationship with cognitive ability while morningness had a negative relationship with cognitive ability. Furthermore, Preckel et al. found age to have a moderating effect on the relationship between

eveningness and cognitive ability. That is, as age increased the correlations also increased. This finding also further supports the notion that age is an important factor in synchrony effects, and that these effects may be too small in samples of strictly college students to be statistically significant.

It could also prove useful to examine more fully the relationship between children's chronotype and task performance at different times of the day as this would enable an investigation of age differences in synchrony effects using a variety of age groups. Little research has been conducted with the population of children, and most of it has looked at children's success in an educational setting. For example, Dunn et al. (1987) found a synchrony effect of student grades in difficult classes. Third through sixth grade students who were Morning types received higher grades in classes they took in the morning than in classes they took in the afternoon, and the opposite was true for Evening types. Additionally, Randler and Frech (2009) found that Morning type adolescents had greater school achievement. One study that looked at synchrony effects in adolescents found a synchrony effect for fluid intelligence measures, but not crystallized intelligence (Goldstein, Hahn, Hasher, Wiprzycka, & Zelazo, 2007). However, given that adolescence is the time when preferences tend to shift from morningness to eveningness, more research would be beneficial in addressing age-related changes in circadian rhythms and how they influence performance on various tasks. Specifically, it would enhance the literature to investigate chronotype effects using younger children who have a strong morning preference and compare them to young adults with a strong evening preference.

In conclusion, synchrony effects were not found in the current study using college students that have morning or evening preferences. This could be due to the fact that college

students are a unique group and will not show consistent effects on their own, that synchrony effects are confounded with age and show a larger effect in older adults, or it could be due to the possibility that synchrony effects do not show up as well in dual-task situations. Given that this is the first study to examine these two aspects together, more research should be conducted in order to make definitive conclusions. It would also prove useful to identify boundary conditions for when chronotype is relevant to performance considering that synchrony effects are not found in all cognitive tasks.

References

- Adan, A. (1991). Influence of morningness-eveningness preference in the relationship between body temperature and performance: A diurnal study. *Personality and Individual Differences, 12*, 1159-1169.
- Anderson, N. D., Craik, F. I. M., & Naveh-Benjamin, M. (1998). The attentional demands of encoding and retrieval in younger and older adults: 1. Evidence from divided attention costs. *Psychology and Aging, 13*, 405-423.
- Anderson, M. J., Petros, T. V., Beckwith, B. E., Mitchell, W. W., & Fritz, S. (1991). Individual differences in the effect of time of day on long-term memory access. *The American Journal of Psychology, 104*, 241-255.
- Audacity Team (2012). Audacity (Version 2.0.0) [Computer program]. Retrieved June 11, 2012 from <http://audacity.sourceforge.net/>
- Baddeley, A. (1996). Exploring the central executive. *Quarterly Journal of Experimental Psychology, 49A*, 5-28.
- Baddeley, A. D. (2001). Is working memory still working? *American Psychologist, 56*, 851-864.
- Baddeley, A. D. (2007). *Working memory, thought and action*. Oxford: Oxford University Press.
- Baddeley, A., Lewis, V., Eldridge, M., & Thomson, N. (1984). Attention and retrieval from long-term memory. *Journal of Experimental Psychology: General, 113*, 518-540.
- Baddeley, A. D., & Logie, R. H. (1999). Working memory: The multiple component model. In A. Miyake, P. Shah (eds.), *Models of working memory: Mechanisms of active maintenance and executive control* (pp. 28-61). New York, NY US: Cambridge University Press.
- Bodenhausen, G. V. (1990). Stereotypes and judgmental heuristics: Evidence of circadian variations in discrimination. *Psychological Science, 1*, 319-322.
- Bohle, P., Di Milia, L., Fletcher, A., & Rajaratnam, S. (2008). Introduction: Aging and the multifaceted influences on adaptation to working time. *Chronobiology International, 25*(2), 155-164.
- Bonnefond, A., Rohmer, O., Hoeft, A., Muzet, A., & Tassi, P. (2003). Interaction of age with time of day and mental load in different cognitive tasks. *Perceptual and Motor Skills, 96*, 1223-1236.
- Bratzke, D., Rolke, B., Ulrich, R. & Peters, M. (2007). Central slowing during the night. *Psychological Science, 18*, 456-461.

- Briganti, A. M., & Elliott, E. M. Effect of time of day preferences on cognitive task performance in college students. *Manuscript in preparation*.
- Carlson, S. M., & Moses, L. J. (2001). Individual differences in inhibitory control and children's theory of mind. *Child Development, 72*(4), 1032-1053.
- Chelminski, I., Ferraro, F. R., Petros, T., & Plaud, J. J. (1997). Horne and Ostberg questionnaire: A score distribution in a large sample of young adults. *Personality and Individual Differences, 23*, 647-652.
- Colle, H. A., & Welsh, A. (1976). Acoustic masking in primary memory. *Journal of Verbal Learning and Verbal Behavior, 15*, 17-31.
- Conway, A. R. A., Cowan, N., Bunting, M. F. (2001). The cocktail party phenomenon revisited: The importance of working memory capacity. *Psychonomic Bulletin & Review, 8*, 331-335.
- Conway, A. R. A., Cowan, N., Bunting, M. F., Theriault, D. J., & Minkoff, S. R. B. (2002). A latent variable analysis of working memory capacity, short-term memory capacity, processing speed, and general fluid intelligence. *Intelligence, 30*, 163-183.
- Cowan, N. (1995). *Attention and memory: An integrated framework*. New York: Oxford University Press.
- Cowan, N. (2005). *Working memory capacity*. New York, NY US: Psychology Press.
- Craik, F. M. (2001). Effects of dividing attention on encoding and retrieval processes. In H. Roediger, J. S. Nairne, I. Neath, A. M. Surprenant (Eds.), *The nature of remembering: Essays in honor of Robert G. Crowder* (pp. 55-68). Washington, DC US: American Psychological Association.
- Craik, F. I. M., Govoni, R., Naveh-Benjamin, M., & Anderson, N. D. (1996). The effects of divided attention on encoding and retrieval processes in human memory. *Journal of Experimental Psychology: General, 125*, 159-180.
- Dunn, R., Dunn, K., Primavera, L., Sinatra, R., & Virostko, J. (1987). A timely solution. *The Clearing House: A Journal of Educational Strategies, Issues and Ideas, 61*, 5-8.
- Engle, R. W., Tuholski, S. W., Laughlin, J. E., & Conway, A. R. A. (1999). Working memory, short-term memory, and general fluid intelligence: A latent-variable approach. *Journal of Experimental Psychology: General, 128*, 309-331.
- Erdfelder, E., Faul, F., & Buchner, A. (1996). GPOWER: A general power analysis program. *Behavior Research Methods, Instruments, & Computers, 28*, 1-11.

- Fernandes, M. A., & Moscovitch, M. (2000). Divided attention and memory: Evidence of substantial interference effects at retrieval and encoding. *Journal of Experimental Psychology: General*, *129*, 155-176.
- Goldstein, D., Hahn, C. S., Hasher, L., Wiprzycka, U. J., & Zelazo, P. D. (2007). Time of day, intellectual performance, and behavioral problems in morning versus evening type adolescents: Is there a synchrony effect? *Personality and Individual Differences*, *42*, 431-440.
- Hasher, L., Chung, C., May, C. P., & Foong, N. (2002). Age, time of testing, and proactive interference. *Canadian Journal of Experimental Psychology*, *56*(3), 200-207.
- Hasher, L., Goldstein, D & May, C. (2005). It's about time: Circadian rhythms, memory and aging. In C. Izawa & N. Ohta (Eds). *Human Learning and Memory: Advances in Theory and Application: The 4th Tsukuba International Conference on Memory* (pp. 199-217). Mahwah, NJ: Lawrence Erlbaum Associates.
- Hasher, L., Stoltzfus, E. R., Zacks, R. T., & Rypma, B. (1991). Age and inhibition. *Journal of Experimental Psychology: Learning, Memory, & Cognition*, *17*, 163-169.
- Hasher, L. & Zacks, R. T. (1988). Working memory, comprehension, and aging: A review and a new view. In G. H. Bower (Ed.) *The psychology of learning and motivation*. (pp. 193-225). San Diego: Academic Press.
- Hicks, J. L., & Marsh, R. L. (2000). Toward specifying the attentional demands of recognition memory. *Journal of Experimental Psychology: Learning, Memory, and Cognition*, *26*, 1483-1498.
- Horne, J., & Ostberg, O. (1976). A self-assessment questionnaire to determine morningness eveningness in human circadian rhythms. *International Journal of Chronobiology*, *4*, 97-110.
- Hossain, J. L., & Shapiro, C. M. (1999). Considerations and possible consequences of shift work. *Journal of Psychosomatic Research*, *47*(4), 293-296.
- Intons-Peterson, M. J., Rocchi, P., West, T., McLellan, K., & Hackney, A. (1998). Aging, optimal testing times, and negative priming. *Journal of Experimental Psychology: Learning, Memory, and Cognition*, *24*, 362-376.
- Intons-Peterson, M. J., Rocchi, P., West, T., McLellan, K., & Hackney, A. (1999). Age, testing at preferred or nonpreferred times (testing optimality), and false memory. *Journal of Experimental Psychology: Learning, Memory, and Cognition*, *25*, 23-40.
- Jacoby, L. L. (1991). A process dissociation framework: Separating automatic from intentional uses of memory. *Journal of Memory and Language*, *30*, 513-541.

- Johnston, W.A., Griffith, D., & Wagstaff, R. R. (1972). Speed, accuracy, and ease of recall. *Journal of Verbal Learning and Verbal Behavior*, *11*, 512-520.
- Jones, D. M. (1993). Objects, streams, and threads of auditory attention. In A. Baddeley & L. Weiskrantz (Eds.), *Attention: Selection, awareness, and control*. (pp. 87-104). Oxford: Oxford University Press.
- Kahneman, D. (1973). *Attention and effort*. Englewood Cliffs, NJ: Prentice Hall.
- Kane, M. J., & Engle, R. W. (2003). Working-memory capacity and the control of attention: The contributions of goal neglect, response competition, and task set to Stroop interference. *Journal of Experimental Psychology: General*, *132*, 47-70.
- Kučera, F., & Francis, W. (1967). *Computational analysis of present-day American English*. Providence, RI: Brown University Press.
- Leirer, V. O., Tanke, E., & Morrow, D. G. (1994). Time of day and naturalistic prospective memory. *Experimental Aging Research*, *20*(2), 127-134.
- Levy, J., Pashler, H., & Boer, E. (2006). Central interference in driving: Is there any stopping the psychological refractory period? *Psychological Science*, *17*, 228-235.
- Li, K. Z. H., Hasher, L., Jonas, D., Rahhal, T. A., & May, C. P. (1998). Distractibility, circadian arousal, and aging: A boundary condition? *Psychology and Aging*, *13*(4), 574-583.
- Logie, R. H., Sala, S. D., MacPherson, S. E., & Cooper, J. (2007). Dual task demands on encoding and retrieval processes: Evidence from healthy adult ageing. *Cortex: A Journal Devoted to the Study of the Nervous System and Behavior*, *43*, 159-169.
- Matchock, R. L., & Mordkoff, J. T. (2009). Chronotype and time-of-day influences on the alerting, orienting, and executive components of attention. *Experimental Brain Research*, *192*, 189-198.
- Matthews, G., Davies, D., Westerman, S. J., & Stammers, R. B. (2000). *Human performance: Cognition, stress, and individual differences*. Hove England: Psychology Press/Taylor & Francis (UK).
- May, C. P. (1999). Synchrony effect in cognition: The costs and a benefit. *Psychonomic Bulletin and Review*, *6*, 142-147.
- May, C. P., & Hasher, L. (1998). Synchrony effects in inhibitory control over thought and action. *Journal of Experimental Psychology: Human, Perception, and Performance*, *24*, 363-379.
- May, C. P., Hasher, L., & Foong, N. (2005). Implicit memory, age, and time of day: Paradoxical priming effects. *Psychological Science*, *16*, 96-100.

- May, C. P., Hasher, L., & Kane, M. J. (1999). The role of interference in memory span. *Memory & Cognition*, 27, 759-767.
- May, C. P., Hasher, L., & Stoltzfus, E. R. (1993). Optimal time of day and the magnitude of age differences in memory. *Psychological Science*, 4, 326-330.
- Medeiros, A. D., Mendes, D. F., Lima, P. F., & Araujo, J. F. (2001). The relationships between sleep-wake cycle and academic performance in medical students. *Biological Rhythm Research*, 32(2), 263-270.
- Melton, A. W. (1967). Repetition and retrieval from memory. *Science*, 158, 532.
- Monk, T. H. (1989). A Visual Analogue Scale technique to measure global vigor and affect. *Psychiatry Research*, 27, 89-99.
- Murdock, B. B., Jr. (1965). Effects of a subsidiary task on short-term memory. *British Journal of Psychology*, 56, 413-419.
- Natale, V., Alzani, A., & Cicogna, P. (2003). Cognitive efficiency and circadian typologies: A diurnal study. *Personality and Individual Differences*, 35, 1089-1105.
- Natale, V., & Cicogna, P. (2002). Morningness-eveningness dimension: Is it really a continuum? *Personality and Individual Differences*, 32, 809-816.
- Natale, V., & Lorenzetti, R. (1997). Influences of morningness-eveningness and time of day on narrative comprehension. *Personality and Individual Differences*, 23, 685-690.
- Naveh-Benjamin, M., Craik, F. I. M., Guez, J., & Dori, H. (1998). Effects of divided attention on encoding and retrieval processes in human memory: Further support for an asymmetry. *Journal of Experimental Psychology: Learning, Memory, and Cognition*, 24, 1091-1104.
- Naveh-Benjamin, M., Craik, F. I. M., Perretta, J.G., & Tonev, S. T. (2000). The effects of divided attention on encoding and retrieval processes: The resiliency of retrieval processes. *The Quarterly Journal of Experimental Psychology*, 53A, 609-625.
- Neath, I. (2000). Modeling the effects of irrelevant speech on memory. *Psychonomic Bulletin & Review*, 7, 403-423.
- Park, D. C., Smith, A. D., Dudley, W. N., & Lafronza, V. N. (1989). Effects of age and a divided attention task presented during encoding and retrieval on memory. *Journal of Experimental Psychology: Learning, Memory, and Cognition*, 15, 1185-1191.
- Pashler, H. (1994a). Dual-task interference in simple tasks: Data and theory. *Psychological Bulletin*, 116, 220-244.

- Pashler, H. (1994b). Graded capacity-sharing in dual-task interference? *Journal of Experimental Psychology: Human Perception and Performance*, *20*, 330-342.
- Pashler, H., & Johnston, J. C. (1989). Chronometric evidence for central postponement in temporally overlapping tasks. *The Quarterly Journal of Experimental Psychology*, *41*, 19-45.
- Petros, T. V., Beckwith, B. E., & Anderson, M. (1990). Individual differences in the effects of time of day and passage difficulty on prose memory in adults. *British Journal of Psychology*, *81*, 63-72.
- Preckel, F., Lipnevich, A. A., Schneider, S., & Roberts, R. D. (2011). Chronotype, cognitive abilities, and academic achievement: A meta-analytic investigation. *Learning and Individual Differences*, *21*, 483-492.
- Randler, C., & Frech, D. (2009). Young people's time-of-day preferences affect their school performance. *Journal of Youth Studies*, *12*(6), 653-667.
- Roberts, R. D., & Kyllonen, P. C. (1999). Morningness-eveningness and intelligence: Early to bed, early to rise will likely make you anything but wise! *Personality and Individual Differences*, *27*, 1123-1133.
- Roenneberg, T., Kuehne, T., Juda, M., Kantermann, T., Allebrandt, K., Gordijn, M., et al. (2007). *Sleep Medicine Reviews*, *11*, 429-438.
- Roenneberg, T., Wirz-Justice, A., & Meroz, M. (2003). Life between clocks—daily temporal patterns of human chronotypes. *Journal of Biological Rhythms*, *18*, 80-90.
- Rohrer, D., & Pashler, H. E. (2003). Concurrent task effects on memory retrieval. *Psychonomic Bulletin & Review*, *10*, 96-103.
- Rowe, G., Hasher, L., & Turcotte, J. (2009). Age and synchrony effects in visuospatial working memory. *The Quarterly Journal of Experimental Psychology*, *62*, 1873-1880.
- Rowe, G., Valderrama, S., Hasher, L., & Lenartowicz, A. (2006). Attentional disregulation: A benefit for implicit memory. *Psychology and Aging*, *21*, 826-830.
- Ruthruff, E., Pashler, H. E., & Klaassen, A. (2001). Processing bottlenecks in dual-task performance: Structural limitation or strategic postponement? *Psychonomic Bulletin & Review*, *8*, 73-80.
- Schneider, W., Eschman, A., & Zuccolotto, A. (2002). *E-Prime User's Guide*. Pittsburgh: Psychology Software Tools Inc.

- Smith, C. S., Reilly, C., & Midkiff, K. (1989). Evaluation of three circadian rhythm questionnaires with suggestions for an improved measures of morningness. *Journal of Applied Psychology, 74*, 728-738.
- Song, J., & Stough, C. (1999). The relationship between morningness-eveningness, time-of-day, speed of information processing, and intelligence. *Personality and Individual Differences, 29*, 1179-1190.
- Stoltzfus, E. R., Hasher, L., & Zacks, R. T. (1996). Working memory and aging: Current status of the inhibitory view. In J. T. E. Richardson (Ed.), *Working memory and human cognition* (pp. 66-88). New York: Oxford University Press.
- Strayer, D. L., & Johnston, W. A. (2001). Driven to distraction: Dual-task studies of simulated driving and conversing on a cellular telephone. *Psychological Science, 12*, 462-466.
- Tombu, M., & Jolicoeur, P. (2002). All-or-none bottleneck versus capacity sharing accounts of the psychological refractory period phenomenon. *Psychological Research, 66*, 274-286.
- Toppino, T. C., Hara, Y., & Hackman, J. (2002). The spacing effect in the free recall of homogenous lists: Present and accounted for. *Memory & Cognition, 30*, 601-606.
- Unsworth, N., & Engle, R. W. (2005). Individual differences in working memory capacity and learning: Evidence from the serial reaction time task. *Memory & Cognition, 33*, 213-220.
- Waugh, N. C. (1963). Immediate memory as a function of repetition. *Journal of Verbal Learning and Verbal Behavior, 2*, 107-112.
- Wieth, M. B., & Zacks, R. T. (2011). Time of day effects on problem solving: When the non optimal is optimal. *Thinking & Reasoning, 17*, 387-401.
- Wilson, M. D. (1988). The MRC Psycholinguistic Database: Machine Readable Dictionary, Version 2. *Behavioural Research Methods, Instruments and Computers, 20*(1), 6-11. Retrieved from http://www.psy.uwa.edu.au/mrcdatabase/uwa_mrc.htm
- Winocur, G., & Hasher, L. (2002). Circadian rhythms and memory in aged humans and animals In L. R. Squire & D. L. Schacter (Eds.), *Neuropsychology of memory* (pp. 273-285). New York: Guilford Press.
- Yang, L., Hasher, L., & Wilson, D. E. (2007). Synchrony effects in automatic and controlled retrieval. *Psychonomic Bulletin & Review, 14*, 51-56.
- Yoon, C., May, C. P., & Hasher, L. (1999). Aging, circadian arousal patterns, and cognition. In N. Schwarz, D. Park, B. Knauper, & S. Sudman (Eds.), *Cognition, aging, and self reports* (pp. 117-143). Philadelphia, PA: Psychology Press.

Yoon, C., May, C. P., & Hasher, L. (2000). Aging, circadian arousal patterns, and cognition. In D. C. Park & N. Schwarz (Eds.). *Cognitive aging: A primer* (pp. 151-171). New York: Psychology Press.

Zavada, A., Gorgijn, M. C. M., Beersma, D. G. M., Daan, S., & Roenneberg, T. (2005). Comparison of the Munich Chronotype Questionnaire with the Horne-Ostberg's morningness-eveningness score. *Chronobiology International*, 22, 267-278.

Appendix A

Post-Experiment Questionnaire

Subject # _____ Date _____ Time _____

Please answer the following questions to the best of your ability.

1. Approximately how many hours did you sleep last night?
2. What time did you wake up this morning?
3. Have you had a nap today?
4. Have you consumed caffeine or any other type of stimulant today? If so, what did you consume and how much?

Appendix B

Non-Significant Results for PRP Experiment

Non-significant *F*-values and Measures of Effect Size for Tone Task Accuracy

	<i>F</i> value	Partial η^2
Peak	0.80	0.011
SOA	0.07	0.001
SOA*Peak	0.17	0.002
Difficulty*Peak	0.15	0.002
SOA*Difficulty	1.37	0.019
SOA*Difficulty*Peak	1.37	0.019

Non-significant *F*-values and Measures of Effect Size for Tone Task RT

	<i>F</i> value	Partial η^2
Peak	0.79	0.001
SOA*Peak	0.36	0.005
Difficulty*Peak	0.05	0.001
SOA*Difficulty	0.40	0.006
SOA*Difficulty*Peak	0.04	0.001

Non-significant *F*-values and Measures of Effect Size for Letter Task Accuracy

	<i>F</i> value	Partial η^2
SOA*Peak	0.36	0.005
Difficulty*Peak	1.00	0.014
SOA*Difficulty*Peak	0.04	0.001

Non-significant *F*-values and Measures of Effect Size for Letter Task RT

	<i>F</i> value	Partial η^2
Peak	0.04	0.001
SOA*Peak	0.00	0.000
Difficulty*Peak	0.10	0.001
SOA*Difficulty*Peak	0.004	0.000

Appendix C

LIST 1

AIR
BAY
CHAIN
CHIEF
DOG
FOOT
HALL
LEAD
NEED
NEWS
SHIP
SOUND
THING
TREE
WIND

LIST 3

BALL
BIRTH
DESK
GIRL
KNIFE
MOON
NOTE
OWN
PEACE
ROSE
SEAT
SONG
SPOT
SQUARE
STEP

LIST 5

ARM
DATE
DUST
GRASS
GUY
HOT
LIGHT
NOSE
PICK
ROLE
SLEEP
STREET
WHEEL
WIFE
YEAR

LIST 7

DOUBT
FIELD
GONE
HOUSE
NICE
NONE
RACE
READ
SON
THIN
TRY
WANT
WET
WHILE
YOUNG

LIST 2

BIT
CENT
COME
FAT
HAND
LOT
PHONE
PLANE
POST
RAIN
ROAD
ROCK
STOP
TEETH
TOWN

LIST 4

BANK
BILL
BLOCK
BOAT
CROSS
FEET
FLESH
JUDGE
MET
POOL
SHARE
SIGN
SPEND
TRUCK
WALL

LIST 6

DUE
FOUR
HUGE
JUNE
LOSS
MAIN
MEN
NIGHT
PUT
SEEN
SIR
SPOKE
STRUCK
TERM
USED

LIST 8

BEST
CHECK
DONE
EACH
HALF
LIE
LIST
NINE
SAT
SERVE
SIGHT
SINCE
TWICE
WIDE
WRONG

LIST 9
BEACH
BRIDGE
BROAD
CAR
FARM
FORT
GOLD
HEART
KEY
NECK
RUN
SNOW
TASK
TEST
WINE

LIST 11
BED
BOARD
BOOK
CHEST
DANCE
DRESS
FOOD
FRAME
GLASS
GUN
PLACE
PLAN
STONE
TRAIN
WOOD

LIST 13
BACK
BASE
DOOR
DRAW
FEW
GAME
JOB
QUITE
ROUND
RULE
SEE
SEEK
TOLD
TRIP
TYPE

LIST 15
BREAK
DOWN
FEED
GUESS
HELD
LONG
MOVE
PALE
POINT
PRESS
SHOW
SPEAK
SPEED
STATE
VOICE

LIST 10
BAND
BROKE
CHANGE
CLUB
COAST
COURT
FACE
GAS
GROUND
HILL
LAKE
PAGE
PLANT
SKY
STAFF

LIST 12
BOX
BOY
CLAY
DRINK
FREE
HAIR
HAT
HORSE
JACK
LAND
LINE
MOUTH
SHAPE
STORE
TALL

LIST 14
AGE
CUT
DRIVE
DRY
GOOD
HEAD
HIGH
HOLE
MISS
SAW
SCHOOL
SHARP
SIDE
SPREAD
WALK

LIST 16
CALL
COST
END
FAIR
GREW
HOLD
HOW
PAST
PURE
SCALE
SHORT
SLIGHT
TAX
WAY
WORLD

Appendix D

Non-Significant Results for Memory Experiment

Non-significant *F*-values and Measures of Effect Size for Correct Recall

	<i>F</i> value	Partial η^2
Peak	0.58	0.008
Condition*Peak	0.70	0.010
Difficulty	2.10	0.028
Difficulty*Peak	1.69	0.023
Condition*Difficulty	0.70	0.010
Condition*Difficulty*Peak	0.15	0.002

Non-significant *F*-values and Measures of Effect Size for Intrusions

	<i>F</i> value	Partial η^2
Peak	1.95	0.026
Condition	2.19	0.029
Condition*Peak	0.13	0.002
Difficulty*Peak	0.04	0.001
Condition*Difficulty	0.40	0.006
Condition*Difficulty*Peak	0.62	0.009

Non-significant *F*-values and Measures of Effect Size for Letter Task, by Condition

	Accuracy		RT	
	<i>F</i> value	Partial η^2	<i>F</i> value	Partial η^2
Peak	0.15	0.002	0.18	0.003
Condition*Peak	0.04	0.001	0.01	0.000

Non-significant *F*-values and Measures of Effect Size for Letter Task, by Difficulty

	Accuracy		RT	
	<i>F</i> value	Partial η^2	<i>F</i> value	Partial η^2
Peak	0.13	0.002	0.10	0.001
Difficulty	2.97	0.04	--	--
Difficulty*Peak	2.00	0.03	2.86	0.04

Appendix E

IRB Approval

Application for Exemption from Institutional Oversight

Unless qualified as meeting the specific criteria for exemption from Institutional Review Board (IRB) oversight, ALL LSU research/ projects using living humans as subjects, or samples, or data obtained from humans, directly or indirectly, with or without their consent, must be approved or exempted in advance by the LSU IRB. This Form helps the PI determine if a project may be exempted, and is used to request an exemption.

LSU

Institutional Review Board
Dr. Robert Mathews, Chair
131 David Boyd Hall
Baton Rouge, LA 70803
P: 225.578.8692
F: 225.578.6792
irb@lsu.edu
lsu.edu/irb

– Applicant, Please fill out the application in its entirety and include the completed application as well as parts A-E, listed below, when submitting to the IRB. Once the application is completed, please submit two copies of the completed application to the IRB Office or to a member of the Human Subjects Screening Committee. Members of this committee can be found at <http://www.lsu.edu/screeningmembers.shtml>

– A Complete Application Includes All of the Following:

- (A) Two copies of this completed form and two copies of part B thru E.
- (B) A brief project description (adequate to evaluate risks to subjects and to explain your responses to Parts 1&2)
- (C) Copies of all instruments to be used.
*If this proposal is part of a grant proposal, include a copy of the proposal and all recruitment material.
- (D) The consent form that you will use in the study (see part 3 for more information.)
- (E) Certificate of Completion of Human Subjects Protection Training for all personnel involved in the project, including students who are involved with testing or handling data, unless already on file with the IRB. Training link: (<http://phrp.nihtraining.com/users/login.php>)
- (F) IRB Security of Data Agreement: (<http://www.lsu.edu/irb/IRB%20Security%20of%20Data.pdf>)

1) Principal Investigator: Rank:

Dept: Ph: E-mail:

2) Co Investigator(s): please include department, rank, phone and e-mail for each

IRB#	E5578	LSU Proposal #
<input checked="" type="checkbox"/>	Complete Application	
<input checked="" type="checkbox"/>	Human Subjects Training on file	

3) Project Title:

Study Exempted By:
Dr. Robert C. Mathews, Chairman
Institutional Review Board
Louisiana State University
203 B-1 David Boyd Hall
225-578-8692 | www.lsu.edu/irb
Exemption Expires: 7-29-2014

4) Proposal? (yes or no) If Yes, LSU Proposal Number

Also, if YES, either This application completely matches the scope of work in the grant
OR More IRB Applications will be filed later

5) Subject pool (e.g. Psychology students)

*Circle any "vulnerable populations" to be used: (children <18; the mentally impaired, pregnant women, the aged, other). Projects with incarcerated persons cannot be exempted.

6) PI Signature Date (no per signatures)

** I certify my responses are accurate and complete. If the project scope or design is later changes, I will resubmit for review. I will obtain written approval from the Authorized Representative of all non-LSU Institutions in which the study is conducted. I also understand that it is my responsibility to maintain copies of all consent forms at LSU for three years after completion of the study. If I leave LSU before that time the consent forms should be preserved in the Departmental Office.

Screening Committee Action: Exempted <input checked="" type="checkbox"/> Not Exempted <input type="checkbox"/>		Category/Paragraph <u>2</u>
Reviewer <u>Mathews</u>	Signature <u>[Signature]</u>	Date <u>7/30/11</u>

Vita

Alicia Marie Briganti, a native of New Iberia, Louisiana, graduated from Catholic High School in May 2000 ranked in the top 10 percent of her class. She then entered college at Louisiana State University (LSU) in August 2000 and received her Bachelor of Science degree in Psychology in 2003. Upon graduating from LSU, Alicia began her graduate school training in August 2004 at the University of Texas in Austin, TX where she completed the requirements to earn her Master of Arts degree in Developmental Psychology in May 2007. Her thesis examined the use of social cues in early word learning. She then moved back to Louisiana to continue her graduate school training in the Department of Psychology at LSU in the area of Cognitive Developmental Psychology. Upon graduating and receiving her PhD in August 2013, she will begin her position as Assistant Professor of Psychology at Dalton State College in Dalton, GA.