



Durham E-Theses

Becoming (Un)Stable: Twenty Years of Financial Stability Governance at the Bank of England

MORRIS, JOHN,HOGAN

How to cite:

MORRIS, JOHN,HOGAN (2016) *Becoming (Un)Stable: Twenty Years of Financial Stability Governance at the Bank of England*, Durham theses, Durham University. Available at Durham E-Theses Online: <http://etheses.dur.ac.uk/11414/>

Use policy

The full-text may be used and/or reproduced, and given to third parties in any format or medium, without prior permission or charge, for personal research or study, educational, or not-for-profit purposes provided that:

- a full bibliographic reference is made to the original source
- a [link](#) is made to the metadata record in Durham E-Theses
- the full-text is not changed in any way

The full-text must not be sold in any format or medium without the formal permission of the copyright holders.

Please consult the [full Durham E-Theses policy](#) for further details.

Academic Support Office, Durham University, University Office, Old Elvet, Durham DH1 3HP
e-mail: e-theses.admin@dur.ac.uk Tel: +44 0191 334 6107
<http://etheses.dur.ac.uk>

Becoming (Un)Stable:

Twenty Years of Financial Stability Governance at the Bank of England

This thesis is the first critical social scientific study of a central bank's financial stability agenda, in this case the Bank of England. The study is broadly situated in a trajectory of research into geographies of money and finance that is concerned with global financial processes, opening up the black box of institutional practices and the interaction between discourse and the economy. More specifically, the thesis contributes a Deleuzian cultural economy and three key concepts as a means for interrogating the financial stability practices of the central bank in question: assemblage, performativity and (in)stability. The methodology of the thesis has involved creating a financial stability archive from some 2000 documents, texts and videos publically available on the Bank of England website. Texts within this archive were read in a consistent and rigorous way, drawing on a grounded theory approach that was 'somewhere between abduction and deduction' (Crang 2003: 132). And, finally, the empirical contribution of the thesis is concerned with financial stability techniques and develops across five chapters concerned, respectively, with press conferences, credit derivatives, Value-at Risk, stress testing and confidence.

John Hogan Morris
10-4-2015

**Becoming (Un)stable: Twenty years of Financial Stability
Governance at the Bank of England**

John Hogan Morris

This thesis is submitted for the qualification of Doctor of Philosophy.

The research was conducted in the Department of Geography at Durham University.

Thesis submitted to Durham University in October 2015.

Table of Contents

List of Chapters:	Page:
Chapter 1. Introduction	5
Chapter 2. A Deleuzian Cultural Economy of Central Banking and Financial Stability	32
Chapter 3. Researching the Assemblage	66
Chapter 4. Financial Stability Reports and Press Conference Performances	81
Chapter 5. Credit Derivatives as Debt –Risk Assemblages	108
Chapter 6. Value-at-Risk: Calculation, Precision and Accuracy	127
Chapter 7. Stress Testing: Assembling Possibility, Hypothesis and (Peri)performativity	147
Chapter 8. Assembling Money, Enunciation and Confidence	168
Chapter 9. Concluding Reflections on Central Banking and Financial Stability	197
Bibliography	212

List of Tables:	Page:
Table 1: Final Procedure for Textual Analysis	76
Table 2: Procedure for Video Analysis	77

List of Illustrations:	Page:
Figure 1: The Assemblage	57
Figure 2: Coming to the Archive	69
Figure 3: Early Financial Stability Reports	85
Figure 4: Later Financial Stability Reports	86
Figure 5: Systemic Risk Survey	87
Figure 6: Visualization of the RAMSI Framework	91
Figure 7: Establishing Authority in Press Conferences	94
Figure 8: How CDOs Work	110
Figure 9: How CDSs Work	111
Figure 10: Jorion Article (a)	138
Figure 11: Jorion Article (b)	139
Figure 12: Jorion Article (c)	140
Figure 13: Stress Test Assumptions	154

Statement of Copyright

The copyright of this thesis rests with the author. No quotation from it should be published without the author's prior written consent and information derived from it should be acknowledged.

Acknowledgements

Very many people have helped me to complete this project. I would like to thank Paul Langley and Ben Anderson for supervision of the highest standard. It is a testament to both that I have always enjoyed our intellectually stimulating and extremely humorous discussions in supervisions so much. Paul and Ben have always given me full ownership of the project and have encouraged me to pursue avenues that I think are important. I greatly value Ben's rigorous reading of many iterations of chapters and his advice on a heady mix of social theory and philosophy. Ben's enthusiasm, encouragement and support for a project on finance has been invaluable and much appreciated. I cannot thank Paul enough for the way in which he has supported and mentored me in my writing, helping me to get my academic career up and running, and for insisting that I read Thrift and Dewsbury on performativity.

I consider myself very lucky to be part of a very supportive and talented PhD community in Durham Geography. I would like to thank Andrew Telford and Esther Hitchen for their help in reading iterations of Chapter Four and providing both encouragement and insightful comments both in the classroom and the pub. I moved to Durham from Bristol and have thoroughly enjoyed my time in the North East. I have drawn immensely from the friendship and support of Jack Williams, Naomi Maynard, Jess Benjamin, Philip Garnett, Ingrid Medby, Hannah Bickerdike, Sophie Tindale, Gillian Carnegie, Siobhan Whadcoat, Will Christiansen, Mariana Santos, Rosie Fewings, Adam Trueman and Christine Hamilton.

I am also extremely appreciative of invitations to gain exposure for work in progress at a number of academic events. This provided outstanding opportunities for feedback, questions and provocations. I would like to thank Joyce Goggin, Thomas Bay, James Brassett, Simon Lilley, Nina Boy, Nat O'Grady, Pippa Thornton, Phoebe Moore and Karen Lai Peak Yue for inviting me to a series of conferences and workshops across the UK and Europe. I have found exchanges with Duncan Wigan, James Brassett, Alexis Stenfors, Amin Samman, Sarah Hall and Dimitri Papadopoulos to have been incredibly useful in the development of my work.

Finally, this project would not have been possible without the love, encouragement and support of my parents.

Dedication

For David and Hilda Morris who are a constant source of strength, support and determination.

Chapter One-Introduction

1.1 Why Financial Stability?

‘The Governor of the Bank of England is a man who is universally respected and trusted...No man has done more towards the rehabilitation of the financial life of Europe...His work in this respect will probably never be fully known or acknowledged, but it has been inestimable’ (Philip Snowden M.P., in the House of Commons, 14th May, 1928 cf. Saw 1944: 109).

‘In my time at the Monetary Policy Committee (MPC) at the Bank, I was surprised by the lack of interest in issues relating to financial markets. Indeed there seemed to be a deliberate policy to run down resources in the financial stability wing’ (Sushil Wadhvani, 1999 cf. Conaghan 2012: 41).

The two statements above both touch on the overarching problematic of this thesis- the lack of existing research into the Bank of England’s work in relation to finance and the financial sector. However, that said, both quotes suggest a different explanation for the lacuna of financial stability. For Philip Snowden, the telling and vital contribution made by the Bank of England’s Governor Sir Montagu Norman may ‘never be fully known or acknowledged’ because much of the financial stability work of the Bank of England under Norman was carried out behind closed doors and in secrecy. And, because this quote reduces the Bank of England to the agency of the governor, this glosses over the networked and assembled nature of the Bank of England’s work, as well as the contemporary shift to transparency (Holmes 2014). Moving forward over 50 years, and Sushil Wadhvani, a member of the Bank of England’s Monetary Policy Committee (MPC), is speaking during a period of much greater transparency, but at this stage, not much of the Bank’s energies are being focused on the financial sector in ways that impacted policy (Turner Review 2009: 84). This second quote is symptomatic of the way in which the Bank of England no longer had the same responsibilities for financial stability as it did 50 years previously. At this time the Financial Services Authority (FSA) had the main supervisory role and engrained thinking about how stability was the preserve of markets functioning efficiently.

Founded as a private institution in 1694, the Bank of England’s key principal at the time was to “promote the public good and benefit of our people” by managing the public debt of the government. This role of ‘national banker’ was clearly and squarely financial. However, it seems

that, analogous to the trends identified above, when an account is given of what central banks do, the explanation underplays the financial stability work undertaken at many of these public institutions. For example, for a widely used *Introduction to Global Financial Markets*, central banks are described as being ‘a distinct entity to a commercial bank and providing a number of regulatory, supervisory and governmental functions’ (Valdez and Molyneux 2010:20, 55). Similarly, a former First Deputy Managing Director of the International Monetary Fund sketches out another functional explanation when he says that central banks serve as ‘bankers for the government by managing the national debt’ and managing both exchange rates and foreign reserves (Fischer 2005:170). The most commonly encountered and recognised function of the central bank is the setting of interest rates and in doing so controls the supply and price of money and credit (Maxfield 1997:5).

Central banks also play a major role in the economy by supervising the commercial banks, and other financial institutions, by serving as a lender of last resort to struggling banks. Such financial functions are considered to promote ‘financial stability’. However, while authors across a range of social science disciplines including International Relations, Anthropology, Communication Studies, International Political Economy, Sociology and Human Geography have pushed and pulled at the question of what a central bank is and how it operates, work has almost exclusively looked at the monetary, inflation targeting feature of central banks (Guthrie and Wright 2000; Harvey 2006, 2010; Smart 2006; Krippner 2007; Hall 2008; Holmes 2009, 2014; Mann 2010; McCormack 2012, 2015; Bowman *et al* 2012; Knafo 2013; Braun 2015). The financial stability functions of central banks have garnered considerably less attention. As the then Governor of the Bank of England suggested:

‘Our job is to create a background of stability which enables other people to do interesting things. They will be interesting: we will not be and we will be faceless...But that outcome is really very important, that we will not be interesting or new or newsworthy and that will be a sign of our success’ (Mervyn King, 27 January 2004 cf. Conaghan 2012:1).

The aim of this thesis then is to explore and develop a conceptually sophisticated and empirically rich account of the financial stability work of a central bank. It is here that the thesis makes an original empirical contribution, because it is the only substantial project in human geography, anthropology and political studies looking to problematize and investigate financial stability. The account given then, is one in which ‘financial stability’ is culturally contingent on the different techniques and technologies employed to act on, and govern it. Alongside this, the thesis argues for a reconceptualization of the relationship between central bank and economy. Rather than the

bounded and unitary central bank standing over the financial system and regulatory in an almost command and control fashion, the central bank governs alongside and through a number of risk management techniques employed by financial institutions. In this introductory chapter I retrace the recent history of the Bank of England, before surveying the geographical literature of money and finance in relation to processes of financial accumulation and financial stability, financial institutions and financial discourses. I then introduce the main theoretical contributions this thesis makes to this geographical literature, before moving onto the recent history of the financial stability agenda and the empirical contributions of the thesis.

1.2 The Bank of England

This thesis will examine the financial stability practices of the Bank of England since the mid-1990s, and during this period there have been three Governors of the Bank of England. Baron Eddie George had been an employee of the Bank of England since 1962 and served for two 5 year terms as Governor. In 2003 he was succeeded by Sir Mervyn King. King had been chief economist at the Bank of England since 1991 and Deputy Governor since 1998. King's appointment broke a trend of Bank Governors being experienced bankers because King was the first professional economist to be given the key role at the Bank (Davies and Green 2010:279). It is possible to interpret this as a result on the Bank's focus on monetary policy and targets since 1997, as King chaired the MPC since 1998. Like Baron George, Sir King served as Governor for two terms. At the end of his second term, King was replaced by Mark Carney, former Governor at Canada's central bank, the Bank of Canada. Carney had worked for investment banking giant Goldman Sachs before switching over to the public sector. Carney gained notoriety and popularity for his decision making during the Global Financial Crisis and his stewardship of the Canadian economy during this difficult period. In 2011 Carney also began chairing the Global Financial Stability Board (GFSB). This is an organisation which aims to coordinate financial authorities and standard setting bodies so that they may develop 'strong and coherent regulatory and supervisory policies' (www.financialstabilityboard.org). Under Carney's leadership, and reacting to significant features of the global financial system prior to the Global financial Crisis, the GFSB made progress in consolidating four main priorities of: (i)

constructing resilient financial institutions, (ii) ending the problem of institutions that are too big to fail when they are under distress (iii) reducing the risks within and created by shadow banking and (iv) making derivatives markets safer (www.BankofEngland.co.uk). In 2013, with his reputation at a very high level, Carney became the first non-Briton to be appointed Governor of the Bank of England since it was established.

Of particular import to this research, the Bank of England was divided into two separate wings in 1994, one for monetary stability and one for financial stability (Davies and Green 2010:53). The election of the New Labour government in 1997 saw two further key institutional changes occur within the Bank of England. The first was a separation of powers, between the Bank of England, the Treasury, and the newly created Financial Services Authority (FSA). Two separate Deputy Governors were appointed, which exacerbated the division between monetary and financial stabilities (Davies and Green 2010:53). Broadly speaking, financial oversight was hived off to the FSA. The second was a two tiered change relating to the enactment of monetary policy: (a) the Bank was made formally independent from political control and (b) the bank was legally bound to a policy of inflation targeting according to a target set by the Chancellor of the Exchequer.

While these significant changes have been associated with New Labour, they can be viewed as being symptomatic of wider trends in economic governance. In particular, the central bank was thought to have the overarching focus of establishing price stability (Conaghan 2012). Central bank independence had been advocated by public choice political science in order to insulate monetary policy from the exigencies of self-interested governments going into the campaign for re-election (Nordhaus 1975). Furthermore, heavy weight, and later politically important, academic economists, such as Ben Bernanke, Frederic Mishkin and Adam Posen, had argued both cogently and persuasively that inflation had real economic costs, and that inflation targeting was an effective way of shaping inflationary expectations (See Bernanke *et al* 1999). Since 1997 the Bank of England has been setting interest rates to target a rate of inflation of 2%. The interest rate was to be set at monthly meetings by a Monetary Policy Committee (MPC), consisting of 9 members; '5 bank people and 4 external members chosen by the Chancellor' (Conaghan 2012: 29).

Created in 2000 as part of the Financial Services and Markets Act, the FSA had four statutory objectives, namely: maintaining confidence in the UK financial system, contributing to the protection and enhancement of stability of the UK financial system, securing the appropriate degree of protection for consumers; and the reduction of financial crime (www.FSA.gov.uk). However, many of the events that occurred under the umbrella term of the Global Financial Crisis indicated

that the tripartite arrangement between the FSA, the Bank of England and the Treasury was unclear and ineffective (Davies and Green 2010: 77; See Turner Review 2009:90). Certainly confidence, stability and consumer protection had been undermined by the bank run on Northern Rock in 2007, and it is arguable that some sorts of financial crimes had been committed, such as the rigging of the inter-bank LIBOR interest rate in 2007 and 2008 (Stenfors 2014).

Reflections on the crisis highlighted that the FSA had been preoccupied with risk at the level of individual institutions. This was thought to have been at the neglect of systemic risk. In the aftermath of the crisis period, the FSA was dissolved and its functions divided between the newly created Financial Conduct Authority (FCA), and the Prudential Regulation Authority (PRA) within the Bank of England. Within this change was the creation of the Financial Policy Committee (FPC). The post-crisis architecture is such that the FCA is consumer based, while the FPC regulates both institutions and the system. In terms of the latter, the FPC is charged with identifying, monitoring and taking action to remove or reduce systemic risks with a view to protecting and enhancing the resilience of the UK financial system. The members of the FPC include the Bank Governor, three of the Deputy Governors, the Chief Executive of the FCA, the Bank's Executive Director for Financial Stability Strategy and Risk, four external members appointed by the Chancellor, and a non-voting representative of the Treasury' (www.BankofEngland.co.uk). The FPC is concerned with systemic issues, while the PRA is charged with the more granular task of regulating at the level of individual financial firms and institutions.

The FPC publishes a record of its formal policy meetings, and is now responsible for the Bank's biannual '*Financial Stability Review*'. *Financial Stability Reviews (FSRs)* have appeared twice a year and aim to both highlight 'developments affecting the stability of the financial system, and promote the latest thinking on risk, regulation and market institutions' (FSR 1996a). The Bank has produced the review in partnership with another organization, initially this was with the Securities and Investments Board and then from 2000, the Financial Services Authority. Significantly the name was changed in 2006, to the *Financial Stability Report* in order 'to reflect a change in content and aims' (www.BankofEngland.co.uk). The FPC of the Bank of England has been releasing financial stability reports through press conferences since 2011.

In light of these substantial institutional changes involving the Bank of England, a focus on institutions suggests that the Bank was not significant to securing financial stability before the Global Financial Crisis. Moreover, a focus on techniques challenges this presupposition and begins to

illuminate the 'faceless' approach to the work of the Bank that King talks of in his 2004 quote. Making the move to focus on techniques, this thesis will focus on publications, press conferences, credit derivatives, Value-at-Risk, Stress testing and confidence as sites and practices fundamental to understanding the governance of financial stability. These are techniques which all attempt to make the uncertain financial future actionable in the present. And yet, I develop Deleuzian ideas of reterritorialization and deterritorialization to argue that such techniques secure and stabilize imperfectly and tangentially, so that the techniques themselves are a constant object of concern for the central bank. In doing so, I reconceptualise established ideas about bounded agency, performativity and stability that currently exist in the central banking literature on monetary policy.

1.3. Central Banking and Financial Stability in Economic Geography

Geographical research into money and finance in the 1990s grew as consequence of the recognition of the 'financial dimensions of a series of political and economic crises alongside the growing economic, social and cultural prominence of the financial sector' (Leyshon 1995:531). Geographies of money and finance give us several established vantage points with which to consider central banking and financial stability. In order to show points of intersection and extension between the existing literature and the main contributions of the thesis, I consider the three most pertinent to be geographies of global accumulation processes, geographies of financial institutions and geographies of financial discourses, performativities and subjectivities.

1.3.1. The Stability of Global Accumulation Processes.

The first clustering of literature that speaks to central banking and financial stability is around the topic of global processes of accumulation. The aspect of this literature that I wish to identify here is the difficulty in attributing stability to financial practices. Geographical work, such as Harvey (1982), Aalbers (2008), Dymski (2009, 2010) and Castree (2010), has tended to build on established critiques of finance, in particular those anchored in the political economy writings of Marx (1894), Keynes (1936) and Minsky (1982). And, as geographers have attempted to modify and re-contextualise the insights from these authors, they consistently retain the instability of

financial accumulation. Here, then, is a critical geography literature into which this thesis fits and contributes by taking a Deleuzian direction.

For Marx (1894), finance acted as a pro-cyclical accelerator to the production process because financial markets ‘push the accumulation process forward in the upswing’. This sees an acceleration of accumulation in a way that goes beyond its own capabilities. The growth process is subsequently oversensitive and unstable (Crotty 1986). When we approach geographical work couched in Marx’s writings, the figure of David Harvey looms large due to his seminal exposition of global and structural processes in space and time (1982, 1985, 1989). For Harvey, the crisis tendencies of the capitalist system cannot be fixed, but can only be temporally delayed or spatially relocated through a process he refers to as ‘capital switching’ (1982). Thus capital periodically ‘switches’ from one sector of the economy to another, away from sectors with low payoffs, over-accumulation and surplus capital, towards those that offer opportunities for higher payoffs. While Harvey posits the productive economy, built environment and social infrastructure as the ‘three circuits’ between which capital can switch, the 30 year process of contemporary financialization constitutes a ‘spatially revolutionary’ fourth circuit of capital¹ (Aalbers 2008:149; Kalb 2013: 259). Here surplus capital, in the form of liquidity, is itself used as credit for speculative purposes. However, because capital switching is a logic and process of relocation, all it ultimately achieves is to ‘transfer capitalism’s inherent contradictions to a wider sphere’ (Harvey 1985: 60). And, within the political economic geography literature, only Christophers (2014) has attempted to relate broad-brush concerns with unstable global processes to the fine tip, sociological literature on financial techniques and market practices.

To return to Marx’s influence, in geography there is a Marxian influenced² ‘Regulation School’ which attempts to situate money within a crisis ridden capitalist system (Lipietz 1987; Peck and Tickell 1992; Jessop 2000). To this we might add Noel Castree (2010), for whom the global financial instability experienced during the Global Financial Crisis was a function of the huge concentrations of debt created to solve the perennial over accumulation problem of capitalism in its modern guise. Across these authors, we see that Marx’s insights may be updated, but they retain the basic thought that financial accumulation is inherently unstable.

¹ See Castree and Christophers (2015) for a proposal that housing and infrastructure designed to mitigate climate change should be deliberately channelled as a new spatial fix (2015: 380).

² Regulation theorists attempt to add more nuance and sensitivity to the Marxian distinction between economic base and superstructure by using a context of accumulation regime, itself divided into mode of ‘social regulation’ and ‘accumulation system’ (Leyshon and Thrift 1997: 268).

However, political economy inspired geographical research in accumulation processes is not restricted to developing on Marx's writings in the Nineteenth Century. There are also scholars working in a 'Post-Keynesian' tradition who follow the insights of John Maynard Keynes³ and Hyman Minsky.

Keynes is similarly attuned to the destabilizing relationship between financial and productive sectors. When faced by an uncertain future and periods of low profits, entrepreneurs and investors are likely to hoard liquid assets (cash), instead of investing the money in production. Keynes argues that finance is inherently prone to 'bear and bull' markets due to radical uncertainty about the future and a fetish for liquid assets, combined with the myopic behaviour of investors. During market panics there is a rush for liquid assets, which are perceived to be safer. This diverts investment away from the productive economy. The uncertainty of future dividends from investment in financial markets leads to an unstable financial system in which uncertainty and ambiguity can only be managed temporarily, rather than fixed permanently (Keynes 1936).

Keynes greatly influenced Hyman Minsky, who effectively attempts to update Keynesian insights for a period in which there is a much more developed and sophisticated financial system. For Minsky, highly developed and complex financial systems are almost always unstable, because patterns of lending occur in three distinct stages, namely those of Hedge, Speculative and Ponzi stage respectively (Minsky 1982; 1986). For Minsky, the illusion of stability during the Speculative and Ponzi stages of lending is destabilizing because too many bad loans are made which are underpinned by rising asset prices. When these prices start to fall, myopic investors tend to liquidate such assets at the same time. Key then, is the thought that stability itself can be destabilizing.

Broadly geographical accounts of accumulation processes continue to develop from Minsky's time of writing in the early 1980s. As Gretta Krippner has long argued, the American economy has evinced substantial increases in the 'accumulation of profits through financial channels' from the 1950s onwards (Krippner 2005: 174, 178). For Pike and Pollard (2010), this process of financialization generates the 'analytic opportunity and a political economic imperative to move finance into the heart of economic geography' (2010: 29). Gary Dymski (2009, 2010) has attempted to fully update and 'spatialize' Minsky Crises, in order to account for 'economy wide crises' linked to the 'macroeconomic dynamics of the economy' (2010: 223). The three main

³ See Davidson (2007a/b) for a particularly clear exposition of Post- Keynesian ideas.

developments that Dymski seeks to include when updating Minsky's work from the 1980s to account for the Subprime Crisis are the effects of racial exclusion on financial market dynamics, the emergence of the USA as a global 'liquidity sink' and the substantial growth of lending from banks to non-banks (Dymski 2009: 240). A second author who attends to significant changes in contemporary global accumulation is Anastasia Nesvetailova (2007, 2008a/b, 2010a). For Nesvetailova, the insights of both Keynes and Minsky can be combined to think about 'the illusion of liquidity' in a financialized economy as being analogous to the illusion of stability in these earlier authors' work (2007, 2008a/b, 2010a). The advance that Nesvetailova makes is to argue that stability is an illusion within an emergent financial system which features advanced and often experimental innovation. The 'illusion of liquidity' that Nesvetailova has written about extensively is underpinned by financial engineering and widespread risk trading processes⁴ in international investment banking (2010a). This illusion is that innovative financialized products will be traded as if as liquid as cash assets, even in times of financial distress. This contemporary financial illusion can be found at macroeconomic, market centred and international levels (Nesvetailova 2008a: 83). Significant to the argument I am developing here is that the problems Nesvetailova identifies with finance recur at a variety of scales. I return to this thought, that financial stability and instability are inseparable, in the theory chapter in which I argue for a dynamic process and tension shifting between reterritorialization and deterritorialization, in the form of hedging and speculation.

1.3.2 Investigating Financial Institutions

The second subset of financial geographies that I want to introduce is that of institutions. A focus on institutions takes one through a literature which begins with structural 'black boxes' of finance capital, and leads onto a sociologically and anthropologically inflected literature in which central banks are themselves 'agencements' of many composite parts and fit into wider assemblages or 'apparatuses' of governance.

The first, and so far only, overtly geographical theorisation of the central bank is that provided by Geoff Mann (2010), for whom the relationship between interest-rate policy and the broad trend of

⁴ See Chapter Five of this thesis.

Neoliberalism⁵ is of particular salience. The approach attends to material geographies- or ‘international spatial political economy’ - taking as its object of study ‘material-distributive dimensions and discursive-ideological issues’ (Mann 2010:11). For Mann, monetary policy decision making, and the setting of interest rates, operates through Hobbesian sovereignty. Mann describes what he sees as a ‘technocratic, class-privileged, autonomous governance of the central material and ideological aspects of collective and individual life’ (Mann 2010:18).

To extend this within a broadly Marxian reading, and to return to the oeuvre of David Harvey, governmental bodies and state institutions, such as central banks, have a role to play in the capital switching process, as was evidenced in the Global Financial Crisis and the switching of losses from private balance sheets to the public or sovereign debt markets (Harvey 2010). However, such an account is problematic because in formulating power as structural and that of a sovereign institution, it appears to elide the discourse, persuasion, justification and negotiation involved in central banking (Holmes 2009, 2014). In the end, Mann and Harvey give us a black-box of a public institution.

Economic geographers have attempted to open the black box of financial institutions in other contexts. In his 1998 *Progress in Human Geography* report, Leyshon attests to one set of interpretations, which he labels ‘bodies at work in financial services’ (Leyshon 1998: 436). Here, then, is a cluster of literature for which ‘economic action is embedded in the social context and the specific institutions within which it takes place’ (McDowell 1997:21 cf. Leyshon 1998:436). Geographers then have attended to the interstices of power and gender in the financial services industry (Leidner 1993; Knights and Murray 1994; Halford and Savage 1995; McDowell 1997). For example, Halford and Savage (1995) write about the consequences of the deregulatory ‘Big Bang’ in London’s financial district for the previously entrenched masculine paternalism in that particular

⁵ This is a controversial and greatly contested concept. Harvey defines it as an all-encompassing ‘doctrine that market exchange is an ethic in itself, capable of acting as a guide for all human action’ (2005). Similarly, for Mann ‘Neoliberalism’ refers to ‘the multiscalar efforts to construct a regime in which the movement of capital and goods is determined as much as possible by firms’ short-term returns’ (Mann 2010:3). Alternatively for Foucault (2008) neo-liberalism has a number of varieties. On the Foucauldian account, Anglo-American Neoliberalism seeks to reduce a story of human motivation and action to the rational, utility optimising *homo economicus* of neo-classical economics (2008:250, 268). Influenced by Foucault, Stephen J Collier advances a non-structuralist account of ‘variegated’ neoliberalism (2012:186).

locale. This piece gives an insight into the hybridity of gendered performances, with the selling aspect of the job requiring ‘feminine’ empathy at the same time that management roles channelled ‘masculine’ aggression. In such a way, ethnographic work inside private financial institutions such as merchant banks in the City of London paints a picture of organizational discourses and how these map onto constitute gender cultures such as the ‘Sexy/Greedy’ South East of England (Leyshon and Thrift 1997; McDowell 1994, 1997).

Related and perhaps also taking a lead from international political economy’s interest in economic epistemic communities is a geographical literature on ‘communities of practice’ (Yeung 2005; Jones 2008 cf. Wainwright 2013:5). The difference being that while epistemic communities seem to firmly focus their analysis on ideas and shared knowledge (Chwiero 2009), the communities of practice literature investigates the role of ‘networked assemblages of actors with shared cultures’ (Wainwright 2013:5). Such an approach can gesture towards why crises catch investors and regulators alike out, because widely adopted group behaviours contribute to myopic cultures and herding (Clark 2011). This geographical literature attempts to situate financial practices, such as insurance under-writing or mortgage securitization, within localised regional spaces (French 2002; Marshall *et al* 2011; Aalbers *et al* 2011; Wainwright 2013).

Such an approach moves us towards a sociology inflected literature influenced by the social studies of technology and actor-network theory. This sets up the focus of the thesis on techniques and technical practices. Again ethnography is used but in such a way as to describe financial markets as ‘*agencements*’ (Callon 2006:13; Hardie and MacKenzie 2007). Here then is a concerted effort to move beyond both bodies and discourses to bring material objects, devices and techniques into focus. For such work, technologies such as ‘electronic trading platforms, financial economic theories and credit scoring techniques play a key role’ by reproducing and shaping the economy (Hall 2010: 2, 4). In this approach the agency of markets and institutions becomes relational, distributed and often non-human. And, as Hall (2010:5) documents, this predominantly sociological and anthropological literature can itself be divided into two branches.

The first encompasses ‘micro-sociological’ research into the computers, screens and interfaces which constitute ‘money’s eyes’ (Knorr Cetina and Bruegger 2002; Preda 2006; Poon 2007; Pryke 2010). The second branch is dominated by the contributions of Donald MacKenzie (2003, 2006) and his co-authors and is preoccupied in the way that economic theory performs, by bringing about or contributing to, the economy. As will be discussed in detail in the next chapter, the paradigmatic example of such work is MacKenzie’s account of how the Black-Scholes-Merton option pricing

theory 'altered patterns of pricing in a way that increased the validity' of the formula's prediction (MacKenzie 2003:852 cf. Hall 2010:5). In her review of geographies of money and finance, Hall does not shy away from the critique of such ethnographic research that it 'potentially reifies forms of 'rational', neoclassical economic calculation and hence overlooks questions of power and politics in the reproduction' of finance (Hall 2010: 2).

Certainly this is where the political economy influenced geographies of money that Leyshon (1995) reviewed in the 1990s could critique this later literature. After-all, what does this literature have to say about the way in which, during the Global Financial Crisis, financial institutions were able to shift their losses onto the public sector balance sheet? For her part, Sarah Hall suggests that the aftermath of this Crisis reinforces 'earlier calls for a greater political sensitivity to cultural economy research about money and finance' (Hall 2010:6). So Douglas Holmes (2014: 51) has argued that the monetary policy of central banks be considered as part of a networked 'apparatus'. Likewise Langley's 'cultural economy' account of the governance of the Global Financial Crisis does engage with politics, through its emphasis on improvised and strategic apparatuses of crisis management, illustrated by the Supervisory Capital Assessment Program (SCAP). Important for the account I go onto develop in this thesis, is Langley's emphasis on distributed agency, and the idea from Holmes that that central banks can be implicated in apparatuses, networks or assemblages (Langley 2014: 32, 84, 121; Holmes 2014). This then is work that moves beyond the (sovereign) power and agency of an institution. And while Langley (2014) and Paudyn (2014) both clearly and convincingly detail the apparatuses, *agencements* and risk based governmental logics behind Global Financial and Eurozone regulatory crisis interventions, no one analysis has looked at both the ten year period before the GFC and the 5 year period afterwards as a unified study of financial stability. The key point that can be distilled from work in both the social studies of finance and cultural economy (i.e. Langley 2008b, 2013b; Holmes 2014) is that a set of broadly Deleuzian concepts⁶ can direct attention to the significance of techniques and devices, alongside bodies and discourses, in relational and distributed forms of agency.

1.3.3 Financial Discourses, Performativities and Subjectivities

As encountered earlier, the political economy perspective to economic geography brings with it a somewhat structural and functional overview of the role of monetary and financial institutions and a sense that these are global, systemic and historical processes (Kindleberger 1976; Braudel 1982;

⁶ Assemblage, apparatus and *agencement* are all some instantiation of Deleuze's relational conception of 'arrangement.' See Callon (2006:13).

Cox 1987; Gill and Law 1989; Arrighi 1994). A particularly influential Gramscian concept identified by Leyshon (1995: 533) is that of hegemony- the dominance of a particular section of a society and the adoption of the interests of the few, as the wider interest of the many.⁷ Here we have a number of texts preoccupied with the shift of power away from state institutions towards ‘transnational interests of social elites who represent financial capital’ (Gill 1990; Leyshon and Tickell 1994; Underhill 1994; Van der Pijl 1998). The unit of study here is transnational classes. However, the phenomenon of financialization does not necessarily have to be conceived from an overtly Marxian or political economy perspective. After all, this literature moves from a preoccupation with inherently unstable global processes of financialization as treated by political economists, to a more cultural economy approach for which financialization involves a ‘bundling together’ of economy and subjectivities in everyday life and settings (Christophers 2013). There is a ‘critical social accountancy’ cluster and a group of authors who focus on the ‘financialization of everyday life’ (French *et al* 2011 802-804). For Froud *et al* (2000), and Erturk *et al* (2008), processes that push ‘shareholder value’, and ‘coupon-pool capitalism’ to the forefront of the analysis leads to the argument that household behaviour has changed capitalism to a more financialized version in which holding stocks and shares is becoming more and more common.

The set of *Progress in Human Geography* reports written at the end of the 2000s by Sarah Hall pay greater testament to the ‘cultural turn’ in the social sciences, with seemingly essential categories of economics, finance and capital being reconceptualised as being contingent, discursive and cultural performances (du Gay and Pryke 2002; de Goede 2003; Amin and Thrift 2004; Aitken 2007). Indeed, what Brett Christophers’ later report on ‘historical geographies of crises’ illustrates is that discourses play an important part in financial governance in such a way that goes beyond the organizational and institutional contexts discussed by authors such as McDowell (1997) and reviewed in the previous section (Christophers 2013:5). This can be the societal framing of an economic issue (Blyth 2002, 2013)⁸ so that it becomes widely held as a crisis, or can be the discourses that form part of regulatory responses of apparatuses in a way that both stimulates and legitimizes action across a population (Brassett and Clarke 2012; Langley 2013a, 2014). Christophers (2013:289) suggests a number of studies that highlight the role of crises within economic discourses. For Carstensen (2013), the Danish banking Crisis of the 1980s still exerts

⁷ What in neo-Gramscian analysis is an ‘historical bloc’ of ‘ideas, institutions and material capacities’ (Leyshon and Thrift 1997:272).

⁸ Here Blyth’s work gives us both inflation in the 1970s (2002) and sovereign debt following the Global Financial Crisis (2013).

discursive and rhetorical influence of the policy environment in Denmark. Taking the most recent financial crisis, discourses that Flandreau (2012) identifies as originating in the aftermath of the Great Depression became part of a superficial interventionism that incorporated 'hollowed out' Keynesian narratives (see Best 2004). Christophers (2013:290-291) also mentions Amin Samman's (2012) work on the return of Depression oriented discourses in the midst of the contemporary Global Financial Crisis. In Samman's own words, this is a result of the interaction between 'conjuncture and historical representation' in newspapers such as '*The Economist*, *The Financial Times* and *The Wall Street Journal*' (2012: 213,219).

Secondly, a cultural economy or broadly geographical literature attends to the ways in which financial discourses and their associated techniques operate in a performative manner. Interdisciplinary approaches to financialization as a micro level process draw our attention to the ways in which every-day financial provisioning through mortgage borrowing, saving for pensions and investment in shares has meshed personal financial security together with the fluctuations of international financial markets (Martin 2002; Langley 2004, 2006, 2008a/b). Indeed as both Brassett and Clarke (2012) and Langley (2010, 2013a) document, discourses around 'toxicity', 'trauma' and 'liquidity' contributed performatively to the construction of a crisis ridden Anglo-American economic sphere in 2008. Particularly relevant here is Douglas Holmes' taking up and modification of performativity in the context of central bank monetary policy aiming to shape inflationary expectations (2009, 2014). A considerable strength of much this literature - its focus on Foucauldian processes of subject formation - *does* bring politics back in to the cultural economy perspective. Therein the cultivation of self-regulating subjects and calculable lifestyles is inseparable from the political imperatives of advanced liberal governance and 'governmentality' (Foucault 2007, 2008). The specific self-oriented and calculative techniques and technologies captured by this approach is a countermeasure for the preoccupation with global processes in political economy inflected work. In the period following Hall's initial report on the financial subjectivities literature, Christophers (2013:6) is able to cite work by 'French and Kneale on biofinancial subjects' (2012) and Johnson on 'contingent lives' and risk appetites (2013) to argue that geographical work on financial subjectification does have 'political economic significance'. To this we should also add Hall on the discursive power of elites in the City of London (Hall 2009: 177). Indeed a notable strand of work featuring the 'bundle of economy and subjectivity' (Christophers 2013: 6) features power-relationships oriented around the obligations of repayment within creditor and debtor relationships (See Graeber 2012; Amato and Fantacci 2012; Lazzarato 2012). And as Langley points out, such

financialized subject positions are always partial, incomplete or uncertain (Langley 2007). In relation to central banking, there is just one article broaching the interstices of power- knowledge- subjectivity, Clarke and Roberts (2014), in which the authors make the case that Bank of England Governor Mark Carney performs ‘two ideal types of masculinity’, that of both ‘traditional business’ and ‘traditional bourgeois’ masculinity (Clarke and Roberts 2014:6). Crucial to the ambitions and arguments of this thesis, I attempt to contribute to the bundling of economy and subjectivity, by drawing out a variety of layers of performativities and performances and that come to light with sustained study of central banking and financial stability.

The ‘value added’ contribution that this thesis makes to the literature is to provide a careful analysis of the performativity of particular economic techniques ‘at large and in the wild’ of financial stability governance. Within this broader ambition, the thesis makes a modest contribution in extending performativity studies in new directions when analysing the press conferences of the Bank of England. Further, this thesis provides an analysis of how assemblages of financial stability which work through a variety of techniques has the additional effect of calling forth particular and market attachments such as confidence.

1.4 Outline of the Thesis

The thesis connects with economic geography work which is itself couched in critical and heterodox political economy account of accumulation processes, in which financial stability is seen as an intangible misnomer. A review of geographical research into financial institutions demonstrates that techniques and devices can be inculcated alongside bodies and discourses, in relational and distributed forms of agency. Further, the literature on discourses, performativities and subjectivities is being extended by mobilisation of the concept into a new empirical case, financial stability. Similarly the thesis attempts to move the concept of performativity into a new direction. Having outlined a number of ways, then, in which this thesis connects with and extends the existing literatures on geographies of money and finance, I now want to turn to the specific theoretical and empirical contribution to be made.

In the second chapter I outline salient aspects of a theoretical approach I am developing, which I am referring to as a ‘Deleuzian cultural economy.’ I begin by introducing what existing cultural economy literature has to say about central banking. Here I focus on performativity and distributed agency as key features of the heterogeneous and interdisciplinary cultural economy literature. In

particular, I identify Douglas Holmes' rich ethnographic research as offering a conception of the central bank as being part of a *performative apparatus* (Holmes 2014: 53). The contribution a 'Deleuzian' cultural economy makes to this existing conceptualisation is to rethink the two terms – apparatus and performativity - that Holmes offers and brings together, and to propose an additional third concept, that of the dynamic tension within finance. (In)stability is my characterization of an ongoing tension between deterritorialization and reterritorialization within finance.

1.4.1 Lively and Layered Performativities

Firstly, I modify the account of performativity offered by Holmes. While Holmes argues that economics formats and shapes the economy, this is not the only possible account of performativity open to a cultural economist. Instead, it is argued that performativity comprises at least four overlapping layers. In addition to the near 'Austinian' performativity conceptualised by Holmes, I argue that the way in which financial stability reports are released, communicated and taken up from press conferences, and through social media involve reiteration and citational practices. In other words, the sort of generic performativity of a discursive operation, most prominently set out by de Goede's (2005) reading of Judith Butler (1993). Further though, I present the case that performative force does not solely reside in the reiteration of previously established authority contexts. Here I draw on the work of Derrida and Deleuze respectively, to argue that financial performativity also involves disruption and creativity. On the one hand, the Derridean account of the performative recognizes that 'conventional systems or institutions are themselves necessarily implicated in an iterability they cannot simply contain' (Loxley 2007:89). On the other, Thrift and Dewsbury's reading (2000) of Deleuze gives us a culture that is non-representational, lively and speculative action whose consequences are not known in advance.

1.4.2 Assemblage Thinking

Secondly, I tackle Holmes' formulation of central banks being implicated in an 'apparatus of interlocutors' (2014:51). The prevalent view in the existing literature conceives of central banking as taking the form of the governance of x by y , most typically as the governance of finance/economy by the central bank. In such a way central banks are viewed as bounded actors which govern with policies. Instead, the focus of this thesis is techniques. While Holmes himself makes this move

beyond the 'governance of x by y' through his invocation of Actor- Network authors such as 'Callon', 'Latour' and 'Law', it does seem that his account is still restrictive in important ways for this present study. Unlike much work which uses *agencement*, 'assemblage thinking' involves a concern for subjectification (Deleuze 1992:340). This in turn allows an account of the bundling together of economy and subjectivity, both by returning to the attempts to foster secure, responsible, prudent and confident traders and publics through a financial stability assemblage.

Turning to a small group of authors writing in a more-or-less Foucauldian approach, I want to say that this contribution is valuable but needs extending. In de Goede (2012), the identification, monitoring and tracking of international circuits of terrorist monies is conceptualised as an assemblage of 'technical', 'cultural' and 'atmospheric' elements (de Goede 2012: 28-29). Paul Langley (2014) and Benjamin Braun (2015) are also authors who moves beyond the governance of x by y. For Langley, the Global Financial Crisis was governed by and through a series of *dispositifs*, namely apparatuses which, in Foucault's terms, are of a 'strategic nature' that respond to an 'urgent need' (Langley 2014: 32). Braun (2015) follows Langley when conceptualising the monetary policy work of the European Central Bank as a *dispositif*.

The Foucauldian approaches that Braun, Langley and de Goede take does fit their studies of governance, be it monetary stability or financial security, but modification is needed to convincingly use distributed agency in the present context of financial stability. This is in order to give an account that not only includes moments of clear and effective governance, but the before, after and tensions of a financial life that often exceeds attempts to govern it. As Deleuze clarifies his point about *dispositifs* (Foucauldian apparatuses) that:

'dispositifs of power would emerge wherever reterritorializations, even abstract ones, are brought about. *Dispositifs* of power would then be a component of *agencements*. But in addition to this, the *agencements* would also be composed of points of deterritorialization' (Deleuze 1994: 186).

The lines of flight then, that I introduce in my work on credit derivatives, Value-at- Risk, stress testing and confidence- and the sense that things exceed attempts to govern them- becomes difficult within an apparatus of strategic purpose and capture.

1.4.3 Financial (In)stability- a dynamic tension

Thirdly, and to develop the previous point that a Deleuzian assemblage must attend to de-territorialization, I develop the Deleuzian device of dynamic tension to think about financial stability. There is evidence to suggest that financial stability was not well-thought out by regulators prior to the Global Financial Crisis. Furthermore, if we consider longstanding critiques of finance anchored in the discernible writings of Marx (1894), Keynes (1936) and Minsky (1982), we see academic precedence for a view that financial stability alone is intangible and is inseparable from instability. While for Marx (1894) financial accumulation accelerates productive processes in a way that destabilizes this later process, Keynes instead located instability in the background condition of uncertainty about the future in which people are investing combined with the preference for liquid assets such as cash money when economic conditions deteriorate (Davidson 2007b). Like Keynes, Minsky (1982) locates crisis tendencies within the uncertainties of financial accumulation itself. So on such a reading, periods of perceived stability actually contribute to future instability by prompting stages in which credit is too easily available and offered without due and proper scrutiny. Anastasia Nesvetailova has developed the insights of Keynes and Minsky to argue that the financial innovation that emerged during a period of relative stability in the 1990s-2000s, led to the destabilizing illusion that many of the financial products being traded would all be equally liquid. However, and as Langley (2010) documents, the Global Financial Crisis was preceded by a general and widespread tightening of global liquidity, in particular for mortgage backed securities. This argument for the inherent fragility of financialized capitalism is one that I carry forward in this thesis. The argument that I am developing from Deleuze and Guattari (1983, 1987) is that capitalist accumulation is driven by a continuous process of pursuit of profit, but at the same time the accumulation process requires a process of reterritorialization to capture and retain those profits. There is then, a tension between hedging and speculation, which are two fundamental financial techniques of making the risks of the uncertain future actionable in the present. This is one of the most central 'schiz-flows', or dynamic tensions in which one term is continually passing into another (Goodchild 2010:30). And as Deleuze and Guattari write in their brief consideration of central banks, these institutions are 'defined much more by what escapes them or their impotence than by their zone of power' (Deleuze and Guattari 1987:239).

So, if we are to conceptualise the central bank as a financial stability assemblage which attempts to act on finance in way that secures it from future events, we must also consider the interplay between re-territorialization and deterritorialization. These two categories lie in dynamic tension- that which I am labelling (in)stability.

1.4.4 Performativity as an Instance of Assemblage

Opening up the category of the performative in the way outlined in section 1.4.1 collapses instances of performativity into the account of assemblage provided by Deleuze and Guattari (1987) in *A Thousand Plateaus*. In other words, performativity becomes an instance of assemblage. As Deleuze and Guattari argue, the illocutionary force that a speech act has in being said is explained by an already existing web of conventions, what Austin refers to as ‘felicity conditions’ that need to be in place for the speech act to be successful (1962). Deleuze and Guattari explain the illocutionary through ‘collective assemblages of enunciation’ (1987: 87). Here I want to extend this reading, to argue that we conceptualise the ongoing situation which is altered by the performative, in terms of the intermingling of bodies and objects that Deleuze gives us in the machinic assemblage (1987: 97). The consequence then, is that a ‘Deleuzian’ cultural economy provides a very machinic account of performativity. The two segments of the assemblage that Deleuze and Guattari give us interact in the form of financial stability techniques, including documents, credit derivatives, Value-at-Risk, stress testing, press conferences and confidence.

1.5. Outline of the Chapters

As noted above, Chapter Two elucidates the Deleuzian features of the cultural economy approach I am using to conceptualise central banking and financial stability. In Chapter Three my concern is research methods and I outline the implications for research of what I am calling a ‘Deleuzian cultural economy’. The way I have undertaken this analysis has been to construct a financial stability archive, using a range of publicly available texts and materials from the Bank of England’s website. To begin with there were in excess of 2000 documents here. Consequently, the first main task was compiling the archive. Even when these procedures had taken place, the archive consisted of some 800 documents, which included speeches, transcripts, publications, reports and videos. In this methods chapter I outline the four broad questions I was asking of the archive:

- (i) What have been the financial techniques used to govern through financial stability?
- (ii) How have financial stability techniques developed over time?

- (iii) How the financial stability techniques used were justified and what were the logics and legitimizations driving the adoption of these techniques?
- (iv) How does each technique act on financial stability?

I then document how I developed my analytic procedure. Once fully developed, the analytic process for documents consisted of three stages. The ‘grounded theory method’ (Glaser and Strauss 1967) that I have worked with on this project, developing theory as data is collected, is, as Mike Crang argues, ‘somewhere between abduction and deduction’ (Crang 2003: 132). The first stage involved reading whole documents line by line. A second stage of reading was used to develop themes and make comments on the fragments generated by the first stage of reading. This was also a creative stage, which opened up a dialogue with a broad range of social theory to interpret what is being said. This helped to generate concepts. The third stage of reading involved returning to the fragments and highlighting pertinent sections that exemplified the conceptual arguments that I wanted to make. In addition to this, video analysis of financial stability press conference webcasts became an important part of my research. These videos *are* an important part of the archived financial stability press conferences because they are stored within the financial stability report section of the Bank of England website and are always presented before the report itself. This effectively means asking the same questions of the video footage as one would of documents, although visuality becomes even more significant.

From Chapter Four onwards, the thesis moves into a more empirical phase, with an exploration of the Bank of England’s understanding of the techniques at play in contemporary financial stability governance, namely FSRs, press conferences, credit derivatives, Value-at-Risk, stress testing and confidence.

In 1996, the Bank of England began to produce Financial Stability Reviews, initially in anticipation of changes to the regulatory system that were expected to follow the 1997 general election. As Howard Davies has it, the first Financial Stability Review (FSR) was ‘an entirely unsuccessful attempt’ to pre-emptively ‘protect the Bank’s role in institutional supervision’ (Davies 2006:9). Thus Chapter Four seeks to link together both the role of FSRs within assemblages and the performativity at place within financial stability governance. In short, I outline the rationale for why financial stability reports are crucial for an understanding of the development of the governance of financial stability.

The chapter begins by providing an account of what, theoretically speaking, FSRs are and how they operate. Here I outline what is it that FSRs do by drawing on literature about the performativity of the economy. More than this, their graphs and data visualisations can be characterized using Miller and Rose's term of an 'intellectual technology' (1990). This focus on visualisation suggests an increasing focus on an audience of informed and professional investors. The chapter then develops a line of argument such that FSRs be considered part of an *agencement* of distributed agency. FSRs refer to many of the techniques and practices of financial risk management that contribute to, and work on, financial stability. For example, not only to FSRs announce the results of stress tests, but they also refer to the development of this technique.

The third section of this chapter engages with the theoretical work on performativity as outlined in Chapter Two. So while the previous section makes the case that FSRs are in some sense instances of the *agencement* that social studies of finance authors work with, here it is argued that performativity involves reiterative and ritualistic practices and a process of 'writing the financial system'. More than this, the specific focus is on the press conferences of the Bank of England which coincide with the release of financial stability reports and results of their stress testing exercises. Drawing on Jacques Derrida's and Gilles Deleuze's writings on iterability and difference, the chapter analyses the disruption and creativity that is also present in the central bank's press conferences. The ostensible production of financial stability by the Bank is thus shown to draw attention to an additional layer of financial performativity that has been previously neglected in cultural economy research, that which I term 'lively practices'.

Chapters Five and Six each focus respectively, on one of the techniques of risk management that were central to the assemblage of financial stability from the mid-1990s. In a 1998 monograph, the Bank of England set out the rationale for what Andrew Baker has called the 'Internal Risk Management' paradigm (IRM). IRM holds that firms should privately price their risks (Baker 2013b:419-420). The introduction to this aforementioned Bank of England text argues that forces of modernity such as 'the complexity of banking, the blurring of functional dividing lines, globalisation and the speed of portfolio adjustment are making such external regulation via common ratios increasingly inappropriate' (Goodhart *et al* 1998:xvii). At the foundation of this paradigm is the Efficient Market Hypothesis, which holds that 'liquid financial markets are characterised by the efficient processing of all available information, which in turn, would make the actual price of a security a good estimation of its intrinsic value' (Baker 2013b: 420). Risk management becomes a

technical and mathematical problem. Here the Bank of England makes the case emphatically that although:

‘there must always remain a role for external regulation, there can be no alternative to placing greater reliance on internal risk management...prudential regulation is necessary because of imperfect consumer information and agency problems associated with the nature of a firm’s business’ (Goodhart *et al* 1998: xvii).

The Bank of England cites two technical devices of internal risk management, ‘value-at-risk’ and ‘credit derivatives’, as being important developments in this approach to regulation and the ‘control of risk’ (Goodhart *et al* 1998: xix).

On the one hand, credit derivatives are a type of financial product which works with the logic of trading a characteristic of an asset, such as price, without actually owning the asset itself. If derivatives of any kind serve to ‘unbundle funding – and, thus, ‘liquidity risk’ -- from the underlying risk to which an agent is seeking exposure via a particular contract, then credit derivatives unbundle ‘credit risk’ or ‘default risk’ from the funding of credit-debt relations’ (Tucker Speech 2007a:22). After first explaining how Collateralised Debt Obligations and Credit Default Swaps work, and why they are derivatives, Chapter Five focuses on a central problematic – how were credit derivatives articulated by the Bank of England during the first decade of its independence. From 1998- 2003, the Bank takes an ambivalent position in which credit derivatives are recognised as having good and bad aspects. That either view can be formed is testament to the diversifying security logic of the derivative (Martin 2007) and the uncertainty and risk underpinning the credit/debtor relationship on which the derivative is based (Amato and Fantacci 2012). Moreover, that both are contemporaneously present, is due to the dual performativity of risk (Wigan 2009). However, the Bank of England’s position gradually moves towards one which is concerned about the complexity of credit derivatives. As the Bank of England becomes increasingly more preoccupied with the gradual tightening of global credit conditions and liquidity, this concern becomes supplanted with fears about the ability to adequately value credit derivatives. This mood is exacerbated during the Global Financial Crisis, and once government interventions have taken hold, the Bank returns to its concern with the complexity of financial innovation. I have interpreted clear regulatory moves to make credit derivatives standardised and less complicated as following a logic of reterritorialization. My final argument within this chapter is that the ongoing logic of deterritorialization and reterritorialization that comes to the fore in Bank of England discourses

allows the interpretation that the chains of obligations and swaps present in credit derivatives are effectively understood using something akin to assemblage thought.

The focus for Chapter Six is upon Value-at-Risk, a probabilistic technique of calculating prospective losses of trading positions. This technique was first developed and deployed by financial institutions such as J.P Morgan to measure market risk. It provides a 'single number estimate of how much a firm can lose to the price volatility of the instruments it holds' during normal circumstances or conditions (Buckley 2011:96). So, to use Pablo Triana's example, 'a one-day 95 percent VaR of \$50 million' means that a firm 'would be expected to lose more than \$50 million only 12 day's out of a year's 250 trading days' (Triana 2012: xixii). Chapter Six is an account in which I use archival analysis to present why Value-at-Risk was adopted as a measure of market risk. The adoption of VaR was, on this reading, a result of its purported accuracy, because it is both constantly and consistently cited as an accurate measure for market risk by the Bank of England. The secondary literature suggests that, in the Asian Financial Crisis of the late 1990s, this had disastrous results for aggregate stability as there was a simultaneous and widespread cutting of positions. Although quiet on VaR at the time, the Bank of England later acknowledges and responds to this critique in the early 2000s. In Deleuzian terms, this was a move to account for the suggestion that this Crisis was a moment of 'deterritorialization' or destabilization for VaR.

It is argued that the response of mainstream financial economics to post-Asian Financial Crisis criticisms that VaR contributed to market volatility was to shift the terms of reference, away from accuracy towards a technical standard of precision. The Bank of England publishes an article by Phillippe Jorion in FSR 2002b, in which it is argued that there are 'important objectives beyond accuracy' (FSR 2002b:116). Later in this piece Jorion develops this thought to make the case that 'the quest for accuracy in VaR measures, which would dictate fast-moving systems, should take second place to stability in the market risk charge' (FSR 2002b:125). Chapter Six completes its analysis of VaR by analysing how, in the context of the Global Financial Crisis, the technique is again criticized, and -although the critique is now being centred on the assumption of normality within the calculation- this still means that attention again focused on the inaccuracy of VaR. As Andrew Haldane of the Bank of England argues at this time, 'VaR suffers a fatal flaw as a risk management and regulatory measure: it is essentially silent about risks in the tail beyond the confidence interval' (Haldane Speech 2012c:16). In other words, levels of regulatory capital were calculated from an inaccurate calculation. This then, is treated as a second way in which

deterritorialization was meshed together with territorialisation within Bank of England thinking on VaR.

While credit derivatives and Value-at-Risk are the most established techniques of financial stability that this thesis examines, Chapters Seven and Eight move to consider emergent and ambiguous techniques.

The aftermath of the Global Financial Crisis has seen the codification of powers for counter-cyclical intervention through ‘the integration of stress testing techniques into national supervisory assessments of the capital adequacy of banking’ (Langley 2014:178). Stress testing involves the running of an anticipatory exercise in which the impact of a hypothetical scenario of three ‘low probability-high impact’ events is measured on the balance sheets, exposures and reserve capital held across banks in a financial system (Geithner 2014). This overhaul of previous legislation addresses both the normality assumptions of Value-at-Risk, and the pro-cyclical nature of credit. In Chapter Seven, rather than just focusing on stress testing’s initial mobilisation as a reactionary tool within the crisis management apparatus, I detail the ongoing development of stress testing as an emergent assemblage of risk management. Analysis of the financial stability archive suggests that one early understanding that the Bank of England has held is that the more rigorous the stress test, the more effective it will be. Further analysis of documents and speeches demonstrates the existence of both probabilistic and possibilistic language in discussions of stress testing. So, for example, Andrew Hauser speaks about the ‘*possibility* that investors cannot meet sudden margin calls (for a given haircut) if the mark-to-market value of the underlying collateral falls sharply and/or credit downgrades require collateral substitution’ (Hauser Speech 2013a:7). That said, Andrew Haldane elsewhere maintains that ‘a stress scenario is just one point on a probability distribution’ (Haldane Speech 2009c:5). And further, a sense of a coalescence of subjective and objective probabilities can be inferred from Haldane’s invocation of ‘meteorology’ as an analogy for stress testing (Haldane Speech 2012e: 19). I analyse this in Louise Amoore’s terms as the coming together of ‘multiple forms of probability’, in terms of ‘the consideration of past frequencies and personal convictions’ (Amoore 2013:45). I then extend Amoore’s (2013) work on the possibilistic risk calculus by opening up the term ‘possible’ to capture the ‘plausible’ and ‘hypothetical’ as distinct modes of risk management through possibility. I detail how and why these have changed and developed in stress testing over time since the Subprime Crisis. In 2012, the focus on the ‘possible’ entails an ambiguity, which allows the Federal Reserve to base its stress tests on ‘deliberately stringent hypothetical’ scenarios, while the Bank of England employs scenarios that are ‘extreme but

plausible.’ Moving forward to 2014, when presented with evidence that stress testing has the performative effect of ‘altering an ongoing situation’, the Governor Bank of England is certainly more careful in emphasizing that its 2015 stress scenario of a widespread ‘deterioration in global economic conditions’ is a ‘not a prediction’ or a forecast (Carney 2014). Stress scenarios then, are coupled with this caveat that they are hypothetical, because rather than being based on some evidence, they proceed deductively by holding an assumption as being true. This in itself is interesting, because it gestures to yet another different account of performativity- the (peri)performative. By referring to a speech act, a prediction’, Governor Carney is invoking, in the words of Eve Kosofsky Sedgwick, an utterance which is *about* a performative and clusters *around* the performative (Sedgwick 2003: 68).

Chapter Eight provides an account of attempts to govern confidence through an assemblage of enunciation and money. In this chapter I begin by introducing the notion of confidence as an ‘object-target’ for governance. Particularly important here is Ben Anderson’s thought that certain categories can be known through their ‘inscription in reality’. Here then, I relate the manner in which the Bank of England seeks to govern (through) confidence, to contemporary work in the social sciences which attempts to grasp and articulate what it is the very nature of confidence. Instead, my focus here is squarely on which of these conceptions is guiding Bank of England interventions. I provide documentary examples that, at times, confidence is spoken about in psychological terms and later in terms of emotions. I go on to present further examples that the Bank of England does bring in ways of talking about confidence that ascribe to it a vitality and a materiality. The conclusion I draw from this is that for the Bank of England, confidence is a somewhat ambiguous object-target.

In the remainder of the chapter I provide an account of a technique of governance as a Deleuzian assemblage that is, at once both enunciative and machinic. Here I present Bank statements that understand confidence as being something that language and public announcements can influence and affect. In discussion of this, I cautiously connect this to Sine Norholm’s work (2015) on financial discourses and affect, without being able to use the archive to support her work. I continue the analysis of how the Bank of England discusses confidence to argue that the Bank attempts to manage the panic that can follow central bank statements about institutions or the financial system which express concern. I argue that central banks manage this relationship by using minimalist and ambiguous language.

Second, and in terms of the machinic, I have gathered together and presented statements which indicate that the Bank of England is working with an understanding that capital inflows can lead to confidence. The clearest academic literature that discusses this relationship directly are Langley (2014) and Konings (2015) who discuss relationships between money/capital and affect. Although, here, to claim that the archive conclusively supports such findings would be to over-infer from the evidence.

These Bank statements make the case that not only is confidence stimulated by capital, but losses in confidence can lead to capital outflows. I conclude the chapter with an account of how the Bank's main initiative focusing on confidence is to push for increased transparency, and demonstrate that the Bank is aware of the apparent inconsistency of this when taken together with the ambiguity of language used to avoid stimulating panic.

By way of conclusion, Chapter Nine retraces the main empirical findings of the analysis of the financial stability archive. Firstly I outline the significance of my research and findings for how we conceptualise central banking and financial stability. Here I reiterate my findings across the empirical chapters on the techniques identified by the Bank as promoting or impacting financial stability. Second, I tease out the different ways in which the aforementioned techniques act on financial stability. I make the case that due to substantial inconsistencies across techniques, 'financial stability' is a mutable concept. Alongside this, I argue that if we take the dynamic tension of (in)stability seriously, then stability must be considered to be an abstraction and isolation on one part of the dualism. Here I bring in the Deleuzian concept of 'the diagram', which is known through assemblages, in order to conceptualise financial stability.

I go onto consider the consequences of my findings for geographies of money and finance. I highlight the way that I have assembled a series of examples that suggest at least four ways in which financial stability press conferences can be said to be performative, drawing on Austin, Butler, Deleuze and Sedgwick. In such a way this thesis provides support for Chris Clarke's (2012) claim that multiple forms of performativity can be co-present and overlapping in performance of the financial economy.

Furthermore, the focus on distributed agency serves to provide a cultural economy account that moves beyond the popular notion that cultural economy is synonymous with a concern for performativity. The final part of this section identifies the way that the Deleuzian approach I am developing ties together accounts of global processes with a concern for techniques at a much smaller scale. The consequence of this is that the account is pessimistic about the ability to use

financial techniques to promote stability due to their tendency for deterritorialization. I argue that Geography needs to do more research to understand financial techniques.

In my outline for future work, and consistent with my call for further research, I propose an agenda for doing more work on techniques such as confidence, press conferences, stress testing and credit derivatives. This research would mainly involve ethnographic research methods and interviews, and would extend the scope of Deleuzian cultural economy to make use of concepts such as affect, resonance and the virtual. In addition to this, I propose more research into the emerging technique of stress testing. It is supposed that this agenda would bring a substantial dose of non-deterministic materialism into the sub-discipline of Cultural Economy.

To briefly summarise this introduction and reiterate the points made, this thesis is the first critical social scientific study of a central bank's financial stability agenda, in this case the Bank of England. The study is broadly situated in a trajectory of research into geographies of money and finance that is concerned with global financial processes, opening up the black box of institutional practices and the interaction between discourse and the economy. More specifically, the thesis contributes a Deleuzian cultural economy and three key concepts as a means for interrogating the financial stability practices of the central bank in question: assemblage, performativity and (in)stability. The methodology of the thesis has involved creating a financial stability archive from some 2000 documents, texts and videos publically available on the Bank of England website. Texts within this archive were read in a consistent and rigorous way, drawing on a grounded theory approach that was 'somewhere between abduction and deduction' (Crag 2003: 132). And, finally, the empirical contribution of the thesis develops across five chapters concerned, respectively, with press conferences, credit derivatives, Value-at Risk, stress testing and confidence.

Chapter Two- A Deleuzian Cultural Economy of Central Banking and Financial Stability

Cultural Economy is a broadly conceived label for an interdisciplinary range of approaches including (but not restricted to) global political economy, human geography, business studies, anthropology and economic sociology (See Amin and Thrift 2004; du Gay and Pryke 2002). As such, Cultural Economy can be thought of as the diverse responses of a wide range of scholars of the economy to the ‘cultural turn’ in social theory (Langley 2014: 3). Such scholarship is provoked by a firm belief that something called ‘culture is both somehow critical to understanding what is happening to, as well as to practically intervening in, contemporary economic and organizational life’ (du Gay and Pryke 2002:1). The aforementioned inter-disciplinary distinctions, such as those between cultural, politics and economy overlap and ‘interact’ because of ‘the cultural dimensions of the economy, the economic aspects of culture and the political character of both’ (Zelizer 2011: 377; Best and Paterson 2010:2). As du Gay and Pryke (2002:9) go onto argue:

‘actual cultural interests and capacities- and the distinctions they might give rise to- can only be formulated and assessed in the context of definitive normative and technical regimes ...There is no reason to assume that these regimes are founded on any prior, general analytic distinction or opposition between ‘culture’ and something else- rather than such a distinction emerging historically as a contingent feature, say, of particular relations between such regimes.’

On such an approach, some activity that may be thought of as purely ‘quantitative’, such as calculation, is ‘not culturally neutral but is shaped by both culture and context’ (Dodd 2014: 297). In particular, the way in which the cultural contingency of ‘the economy’ has been carried forward through two key concepts- performativity and relational agency.

For performative examples of cultural economy, economics is said to ‘format and frame’ markets and economic relations rather than merely describing them (Callon 1998). And, as I detail further in this chapter, this has almost exclusively been seen as either the claim that the discipline of financial economics contributes to the construction of the economy (MacKenzie 2003, 2004), or an alternative claim that finance involves the reiteration of discursive operations to constitute the ‘economic’ (de Goede 2005; See also Langley 2008a). As such economic discourse is seen as being both representational and technological (du Gay and Pryke 2002:2).

Further, cultural economy is also interested in forms of distributed and relational agency (see Callon 1998; MacKenzie and Hardie 2007; Butler 2010; de Goede 2012; Langley 2008b, 2013, 2014; Holmes 2014). And, while this insight has typically either manifested itself as apparatus (Holmes 2014; Langley 2014; Braun 2015) or *agencement* (Callon 1998; MacKenzie and Hardie 2007), agency becomes ascribed not just to humans, or technical devices and technologies, but these networks or collectives in which the component parts participate.

As Langley argues in relation to the governance of the Global Financial Crisis, ‘cultural economy and social studies of finance (SSF) do not provide, however, a ready-made and established set of conceptual tools’ for the study of financial crises (2014: 3). This point can be extended more generally to include the governance of financial stability and indeed central banking. In such a way, the closest to a cultural economy account of the central bank is that found in Douglas Holmes’ *Economy of Words* (2014). Here Holmes characterizes monetary policy as a *performative apparatus* (2014:51). However, this important conceptual starting place does need reworking and here I read *performative apparatus* through Deleuze, treating him in Benjamin Lozano’s (2015:73) terms, as ‘a heterodox political economist’, or indeed, as a speculative cultural economist.⁹

To consider Cultural Economy’s and SSF’s accounts of performativity through a Deleuzian lens is to focus on difference, practice and the non-representational, as opposed to the existing cultural

⁹ DeLanda (1999) puts it well when he argues that Deleuze is a ‘non-essentialist realist’ who goes, ‘beyond the simple dichotomy between complete determinism and complete indeterminism’ (34-35).

economy view of economic discourse as representational and repetitive, in terms of the re-signification of existing meanings (Thrift and Dewsbury 2000). In the *Logic of Sense* (1990), Deleuze attempts to argue that linguistic meaning is 'founded not upon a representationalist relationship between words and the world, but rather upon a play of words and world that itself escapes representation' (May 1997: 193). While I do not argue that all meaning is founded on non-representation, it does seem that at times discourse does evince disruption, difference and creativity, as well as repetition. Following J.L. Austin, the established cultural economy view treats unsuccessful performatives as 'misfires'¹⁰, a term which surely relegates their status to something unwanted. It is argued later in this chapter that misfires or 'lively practices' tell us about the expertise of central bankers and the socio-technical *agencements* of which they are components (Callon 2010). Performative force then, is just as closely related to the rupture from prior authority contexts as it is related to reiteration. On this reading, culture is as much about the non-representational and speculative gambles as it is representation and the already known.

To move onto reconsider 'apparatus', the term does give the sense that central banks govern through that which they are said to regulate. However, there are two Deleuzian modifications that need to be made. The first is to argue that while 'apparatus' is generally suitable for an account of *governance* or capture, it is, and here I think that both the Global Financial Crisis itself and the more tangible concept of financial instability indicate this, important that one must also include 'points of deterritorialization' (Deleuze 1994: 186). Both governance and escape are included in Deleuze's conception of the *agencement*, and his account of machinic worlds and arrangements of discourse and objects. However, and to bring in the second modification, the conceptualisation of assemblage is critical here, because it argues that parts of assemblages do have some stand-alone properties, and this allows parts of one assemblage to be implicated in other distinct assemblages, such as those involving credit derivatives, stress testing and targeting of confidence. This can be contrast to the *agencement* invoked in much SSF research, in which the 'characteristics of components are constituted by the *agencements* of which they are made up' (Hardie and Mackenzie 2007: 3-4).

¹⁰My understanding of 'misfire' follows the debate between Butler and Callon in *Journal of Cultural Economy* (2010). Butler (following Derrida) points out that misfire is the iteration and breach at the base of the performative (Butler 2010:152). Callon (2010: 164-165), for his part, makes the case that performatives are so particular that misfire is the norm, and that it is these breakdowns of the performative that bring politics into the economic. Esposito (2013) goes further to suggest that performativity turns into misfire due to the role of uncertainty and surprise in the economy.

What makes this Deleuzian cultural economy particularly economic or financial, is that it draws on Deleuze and Guattari's *Capitalism and Schizophrenia* project (1983, 1987). It is across these texts that Deleuze and Guattari give a dispersed account of finance, money and debt in the capitalist system. And, while Deleuze may provide a confusing and mutable account of money in which it is wrought with a dynamic tension, it is less the characterization of money, and more the identification of dynamic tensions within finance, that this thesis fixes onto (Kerslake 2015:39; Dodd 2014: 235-236). Deleuze gives an account of capitalism in which there are dynamic tensions, or 'schiz-flows' in which one term is constantly and perpetually passing into the other (Deleuze and Guattari 1983: 242). For Deleuze and Guattari, the fundamental dynamic tension within capitalism is that of deterritorialization and reterritorialization. Abstractly, this captures the way capitalism seeks out new markets for profit, but also speaks to the way it seeks to lock in and capture that profit. I view these two processes as being ways in which the uncertain are actionable, which, in the context of finance means hedging and profit. The consequence of this for financial stability is that finance is always passing between deterritorialization and reterritorialization. In other words, we must mobilize both terms *in an ongoing process* and I do so with the concept of financial (in)stability.

Fourth and finally, the consequence of opening up the category of the performative in the way I suggest in the first section of this chapter causes it to fold into the account of assemblage provided by Deleuze and Guattari in *A Thousand Plateaus (ATP)*. Performativity becomes an instance of assemblage. For Deleuze, the illocutionary force that a speech act has in being said is a product of a tangled web of conventions- what Austin refers to as 'felicity conditions' that have to be in place (1962). The illocutionary then, is 'explained by 'collective assemblages of enunciation' (Deleuze and Guattari 1987: 87). Here I want to extend this reading, to argue that we conceptualise the perlocutionary - the on-going situation which is altered by and results from the performative - in terms of the intermingling of bodies and objects that Deleuze gives us in the machinic assemblage (1987: 97). This account of intermingling modes and objects speaks to the lively practices that I develop in my section of performativity. The Deleuzian cultural economy is one then that attends to the open, discursive and material nature of economic life. The account I am developing will attend to the way that performative collective regimes of enunciations coalesce with machinic assemblages in the form of financial stability techniques.

2.1. Performativity as Layered and 'Lively'

As identified in the introduction, cultural economy work is often treated as being one and the same as an interest in discourse and discursive practices (See Christophers (2014) for an example of this thought). And, while cultural performances are a significant part of central banking, I want to argue that the performativities of the central bank need to be considered complex, multi-layered, clustering and overlapping. In other words, as a field Cultural Economy needs to engage more with new materialism.¹¹ The theoretical emphasis on techniques belies an interest in material practices of risk management.

The existing social science literature has attempted to conceptualise the power of central banks in a way which can be characterised under three main themes- functional, structural and social constructivist. Here I first review these three strands of literature before developing a fourth account which attends to performativity. The focus of the latter approach is, I argue, able to add something to the three other overarching approaches. That is to say, on the one hand, the persuasiveness of the idea of the central bank preceded its structural and functional role in the economy. On the other hand, the impact of the central bank is due to both material and discursive factors and that these two elements are inseparable within the central banking assemblage.

In terms of a functional view, a central bank is a distinct entity to a commercial bank and performs a number of common and similar, yet hardly uniform, regulatory, supervisory and governmental roles (Valdez and Molyneux 2010:20, 55). Geoffrey Ingham (2004) provides a sketch of central bank power which is functional. Central banks are said to be integral for the liquidity of the payments system as they provide short term funds to ‘enable the commercial banks to balance their books and to augment their reserves after they have met the demand for loans’ (Ingham 2004: 137). Furthermore, central banks are said to be critically and functionally influential because of their ability to act as ‘lender of last resort’ (Ingham 2004: 142). On such a neo-Chartalist view¹², central banks both create money but concurrently supervise the commercial banks and other financial institutions by serving as a lender of last resort to struggling banks (Dodd 2014:110). The functional view is couched in the role of the state in maintaining monetary and financial stability is a function of both national security and the production and reproduction of state authority.

¹¹ de Goede (2012) reads the financial security assemblage through new materialist authors such as Jane Bennett (2005). See also Lozano (2015) or Konings (2015) on new materialism in finance.

¹² A view in which the state has an important role in the creation and continued functioning of money as specie. See Dodd (2014) for an account of the story of money grounded in the state building of the Seventeenth and Eighteenth Centuries.

A second approach is the structural account, which seeks to build on work by scholars working from a critical political economy perspective, namely Harvey (2006, 2010), Marazzi (2008, 2010), Mann (2010), Jessop (2010) and Knafo (2013). To this we can also add the first half of Rodney Bruce Hall's analysis of central banking power (2008). These authors write about central banks using a conception of power as being relational and part of material social structures. Power is structural due to the central bank's position within capitalism. This structural power derives from a series of relationships underpinned by the materiality of capital held by central banks and their ability to create money, allocate credit, monetize debt and value products (Hall 2008:84-111).

Structural accounts of central banking have several variants. In Samuel Knafo's account of liberal economic governance, the Gold Standard was a 'structure of power rather than one of regulation...it was often fuelled by the need to discipline market actors (financiers) who were generally reluctant to conform to official policies' (Knafo 2013: 176-178). What made the Gold Standard radical was that it required a state-bank to issue banknotes, thus constituting the kind of state intervention that became the norm for central banks.

Taking a more Marxian analysis, Harvey (2006, 2010) and Jessop (2010) argue that central banks emerged as creatures of the capitalist state that they supported. For Harvey, the institutions 'vital to capitalist reproduction are separated from those concerned with reproducing the labourer and labour power' (Jessop 2006); and state institutions must 'attain a certain balance if society as a whole is to be reproduced' (Harvey 2006). Further, central banks are structurally important because they help capitalism to offset its crises by moving crises around both spatially and temporally (Harvey 2010).

Geoff Mann's 'international spatial political economy' is the nearest attempt to explicitly analyse and critique central banking within the geographical literature. In Mann's account of monetary policy in central banking, power is a result of 'structural limitations' - in other words central bank power is dependent on their 'interest rate operating procedures'. The instruments any one central bank can use to affect interest rate are historically and contextually specific, but Mann argues that they can be generalized into two categories (a) 'lending to and accepting deposits from the financial sector at rates determined by the central bank' and (b) 'participation in the market for domestic government securities' (Mann 2010:5).

For Rodney Bruce Hall, structural power involves the construction of subject positions with 'the result of hierarchical binary relationships' (Hall 2008: 88). Here Hall is looking at the way that

certain material relationships, such as ‘money issuer/money user’, allow a central bank to make money available to the commercial banking sector (Hall 2008: 91). For example, when the interbank credit system is facing difficulties, central banks intervene to inject liquidity throughout the financial system (Hall 2008: 93-94). In this role, the bank’s structural power creates the binary ‘lender of last resort/bail out institution’ (Hall 2008: 94-95).

In its various guises structuralism is initially persuasive because it locates power within material social relationships, in particularly the ability to create capital and credit. However, against this view, Marieke de Goede has long criticised the idea that material practices or relationships ‘exist prior to, or independently from, ideas and beliefs about them’ (de Goede 2003:81). Instead, structural categories, such as capital and capitalist relationships, are contingent, contested and unstable. In *Virtue, Fortune and Faith*, de Goede goes onto argue that knowledge and interpretation are not mere adjuncts to ‘material financial structures’ (de Goede 2005:7). In Butler’s terms, ‘agency is not purely complicit with prior operations of (financial) power’ (Butler 1997:10). And while I am not arguing that the material is irrelevant, I am making the case that it is intertwined with the discursive (Hardy and Thomas 2015). In other words, money takes a ‘variety of material forms and yet also depends on a variety of accounting systems’ (Dodd 2014: 171). de Goede corroborates this with her repeated observations that money is sustained by writing (2003:95), and that ‘money, credit and capital...(are) systems of writing’ (2005 :5).

As touched upon previously, Rodney Bruce Hall (2008) seeks to improve on the aforementioned structural accounts of central banking by using an explicitly social constructivist framework grounded in the philosophy of John Searle. Hall therefore forwards the notion that alongside material and structural power, central banks share in the deontic power of social institutions. The central focus of Hall’s account is the role of credibility and price stability to ‘anchor expectations’ in an era of fiat money. Hall argues that being a ‘bank of issue’ carries with it a collectively assigned status which consequently allows it to set the rate of interest and manage the supply of credit and money (Hall 2008: 57). In attempting to offer more than a structural account, the second conception of power employed by Hall is ‘productive power’. By this, central banks are able to use ‘discursive practices’ and ‘knowledge systems’ to create and alter meanings. So while structural power is employed in ‘the co-constitution of subjects’, via a binary, ‘productive power is more diffuse and more extensive’ (Hall 2008: 90-91). In monetary policy, Hall argues that central banks have the ability to fix and change both the demand and supply for money in the banking system (Hall 2008: 92). In liquidity provision, central banks have the power to change social meanings by

the choice of language in the public statements by high ranking officials. The application of productive power in emergency liquidity funding and work with insolvent institutions is the power to alter social meanings of market conditions, for example by transforming the social status of ‘distressed’ to the social status ‘recovering’ (Hall 2008: 95).

Likewise, while social constructivism provides a fuller account of the role of central banks than that provided by the structural account, nonetheless we might question whether it is entirely satisfactory (Hall 2008: 222-223). Hall’s two poles of power appear to be a way of keeping the non-discursive and material (structural) power apart from the discursive (productive) power of language. This however, is not possible when one considers a significant feature of the cultural economy literature on monetary policy, namely the idea that what central banks do is exercise *performative force*, and it is in performative practices that the material and discursive fold into each other (Holmes 2009, 2013; McCormack 2012; Hardy and Thomas 2015:9). Power may well be ‘essentially’ relational (Foucault 2014:251), but it can still be argued that the relational positions are not rigid structural binaries, but are much more open¹³ ended, dynamic and performed.

Here then I develop a fourth strand of literature on the power of central banks, drawing together the insights of a disparate group of authors to mobilise the category of performativity in an account of central banking. In *Writing the Economy*, Graham Smart (2006) provides a rich ethnographic study of the working patterns and behaviours of economists within the Bank of Canada. In this account, a technology mediated discourse allows communication between central bank employees in the Bank of Canada, as well as the subsequent creation of communications materials which are disseminated to the general public. Although Smart does not explicitly categorise his account of the central bank, the way that he explores and elucidates the manner in which economists’ discursive practices engender intersubjectivity and enable individual and organisational learning, initially lends itself to a constructionist categorisation. Smart argues that ‘the economy’ is a cultural construct’ and an intersubjective reality established through the discourse practices of collaborating economists’ (Smart 2006: 22). On the other hand, the idea that economics is both ‘performed’ and is a ‘writing intensive activity’ which creates written and spoken discourse seems to suggest that Smart collapses into an account which is performative (Smart 2006:12, 14).

This notion of performativity in central banking has historical precedence. For example, and moving to the Gold Standard period of the Nineteenth Century, the very idea of ‘the lender of last

¹³ Without being completely open. See DeLanda (1999) on the continuum between absolute openness and absolute determinism that Deleuze works with.

resort' function had a performative effect rather being a bi-product of functional value. The measures associated with 'the Gold Standard' were planned in the belief that the financial system was structured by a central bank (Knafo 2013: 137). This was not the case, but because it was thought that the central bank was needed to ensure gold convertibility, state officials created 'the very entity that 'lender of last resort' was intended to describe' (Knafo 2013: 137). Consequently we can say that the central bank exercised power, persuasion and authority *before* it performed its function of lender of last resort. Moving forward to the twentieth century and onwards, monetary policy has been, and is premised on, the practices of experts bringing about the circumstances they describe- in this case price stability through inflation forecasts (Holmes 2009: 383; McCormack 2012,2015; Holmes 2014; Braun 2015). The Federal Reserve generates the expectation of interest rate policy anchoring to a target in the future. It attempts this by releasing a series of 'persuasive narratives' knitted together by a nearly continuous stream of statistics and analytics in a chain of both people and objects (McCormack 2012: 1549; See also McCormack 2015). Douglas Holmes' work shows that central bank practitioners have long worked with the assumption *that talking about future intentions* on interests rates is just as important as actual rate decisions. This is because the policy discourse shapes market expectations. In Holmes' recent book, he develops this idea of performativity as the 'collaboration' between central bank and public 'across a communicative field in which 'experimentation' is undertaken by the reflexive subjects both inside and outside of the central bank (Holmes 2014: 26). Similarly for Benjamin Braun (2015), the communicative apparatus of the central bank performs credibility, in Goffman's (1959) sense of a performance in one 'front of house' venue whilst behaving differently behind 'closed doors' (Braun 2015:371).

Performativity, then, has the potential to disrupt structural binaries and renders problematic the distinctions between material and discursive and policymakers and public we find in Hall's social constructivist account. This is because 'discourse and discursive imagination' becomes bound to 'materialization', material practices and multiple performances (de Goede 2012: 32). Structuralism claims to be able to account for performativity in its own terms, that discourse becomes something akin to a structure. However, it can equally be said that structure can be accounted for in discursive terms, that fixity, surface and boundary are particular discursive effects of stabilization (de Goede 2012:32). The central issue about whether discourse structures seems to be one of stability and material essentialism versus instability and linguistic non-essentialism, and as Foucault argues in *The Order of Things*, language and history buffer modern knowledge in ways that disrupt and escape fixed, unambiguous and uncontested meanings (Foucault 1970 cf. Best 2008:361-62). To refine this

opposition in a Deleuzian way, it is not a simple case of stability versus instability, but a case of intermediate forms of stability and determinism- in other words complex and non-linear accounts of causation (DeLanda 1999: 35).¹⁴

Broadly speaking, a political economy approach which treats categories such as capital, class and production as natural categories and existing independently of representation and discursive practices, finds critique in the cultural economy literature. Within this literature, Thrift and Amin argue that ‘production, distribution and accumulation of resources have always been a cultural performance’ (Thrift and Amin 2004: xii). In other words, economic objects are constituted through the discourse used to describe them. Culture is, according to du Gay and Pryke, not a logic or sphere, opposed to ‘politics’ or ‘economics’, but is exactly the way ‘in which we are not ‘natural, living, social, religious, economic or political beings’ (du Gay and Pryke 2002: 4-5). In such a way, Cultural Economy is anti-essentialist and further, opposed to universal accounts of human beings. Such an approach seeks to disturb any superficial and wholly artificial separation of culture from economy and attends to the ‘empirical and practical’ ways in which culture has been used in particular institutional or political contexts (Aitken 2007: 39).

It is important to remember that the adoption of performativity by cultural economy approaches is rich, variable and contested, and, as Chris Clarke points out, there are two dominant existing cultural economy approaches to scholarship which embrace and employ the concept in the context of finance and the economy (Clarke 2012). These are, to borrow the categorisation made by MacKenzie (2001), ‘Austinian’ and ‘Generic’ performativity respectively. So for Clarke, while the two accounts of Austinian and Generic performativity are at work in the ‘layered performances’ of financial stability by the bank; technical, ‘Austinian’ performativity overlaps and intersects with a more reiterative, ‘Generic’ performativity. However, I extend this by going further by drawing on Jacques Derrida’s and Gilles Deleuze’s writings on iterability and difference. This thesis analyses the disruption and creativity that is also present in the central bank’s press conferences. The ostensible production of financial stability by the Bank is thus shown to draw attention to an additional layer of financial performativity that has been previously neglected in cultural economy research, which I have termed ‘lively practices.’

¹⁴ This can be contrasted to efficient causation in which action A will always have effect B.

The most widely utilised entry point to the performativity literature is that which is commonly classified as the Social Studies of Finance. For such approaches, ‘Austinian’ performativity occurs whenever the technical discipline of economics is thought to ‘shape’ and ‘format the economy, rather than recording how it functions’ (Callon 1998:2; see MacKenzie *et al* 2007). And, although Callon’s own writings on performativity take an altogether different direction¹⁵, he has provided inspiration for sociologists such as Donald MacKenzie (2006a/b) or Knorr Cetina and Preda (2005) (cf. Langley 2010: 74). On Mackenzie’s formulation, ‘Austinian’ performativity holds for circumstances in which the reflexive use of a mathematic economic model in some way leads to the world gradually conforming to its depiction within the model (MacKenzie 2001). MacKenzie’s work, and that co-authored with Yuval Millo, makes the case most effectively when analysing how the Black-Scholes-Merton formula- used in the pricing of options- itself employed assumptions that were initially unrealistic but became increasingly less so due to changes in the reality it sought to represent (MacKenzie 2001, MacKenzie and Millo 2003).

At the analytical foundations of this conception of the performative is J.L. Austin’s analysis of language in which a speech act, such as a chairman opening a board meeting, is said to bring about the effect which it names. In such a situation, one is actually doing something- *opening the meeting*- rather than merely *reporting* the event of a meeting of a board of directors (Austin 1962). When Butler reads Austin, she draws a distinction between the illocutionary, which ‘brings something into being’, such as a judge convicting a defendant, and the perlocutionary, which ‘alters an ongoing situation’ (Butler 2010:151). As Christophers points out, it is the perlocutionary which is associated with the most prominent work in SSF. In other words, financial theories ‘contribute to the construction’ of the world they seek to theorize (Christophers 2014: 18).

This branch of the performativity literature has taken and developed Austin’s account of language such that it is mobilised within Actor- Network Theory and Science and Technology Studies. The focus here is the way that performative agency is distributed and works through networks that include humans, but also ‘equipment, technical devices and algorithms’ (Callon 2005:4 cf. Hardie and MacKenzie 2007). Seemingly important for this version of performativity is the repeated focus

¹⁵ Chris Clarke attentively takes Callon ‘in parallel with Butler’ because Callon suggests that “markets are not always existing, natural or intelligible in terms of a-historical laws, but require continuous effort (or performance) to maintain and grow” (C. Holmes 2009: 440 cf. Clarke 2012: 265).

on materiality because, indeed, the socio-technical are often cast as inseparable.¹⁶ What this thesis takes from this branch of the performativity literature is that material or ‘machinic’ techniques of financial stability are brought to the forefront ahead of institutions or policies. And yet, to fix solely on the material would be to seemingly misread Austin. As Chris Clarke (2012: 266) has pointed out, ‘that Austin holds an essentially pragmatic philosophical approach in this sense might well constitute a key strength of his work because one of his central claims is to stress how the uttering of a statement is the performance of an act’. In such a way, Clarke cites Loxley’s elucidation that, in Austin, there is no separation, and therefore no relation for us to assess, between utterance and situation. The utterance is not setting out to describe a situation, an event or an action: it is an event or an action (Loxley 2007:8 cf Clarke 2012: 266). This pragmatism, is captured by Muniesa’s (2014:16) nuanced and two-pronged explanation that (a) ‘to signify is an active process’ and, (b) ‘to effect is to bring reality about’.

So, as we have already encountered, performativity is a contested concept and the performative account provided by authors such as Mackenzie (2003) does not exhaust the types of performativity at play in finance *tout court*. Instead, performativity has alternatively been construed as being ‘Generic’. This approach attends to the reiterative practices through which ‘a discursive operation produces the effect that it names’ (Butler 1993:2).¹⁷ For example, Clarke and Roberts’ (2014:6) recent article on overlapping gendered performances argues that we can see that ‘masculinity’ is performed in at least two distinct ways by the Bank of England Governor Mark Carney. Within finance, the application of this approach is most commonly associated with the work of Marieke de Goede (2005), and later developed in Paul Langley’s work on everyday financial subjectivities (2008a).¹⁸ The object of interest here is how the category of performativity can be utilised within broader Foucauldian concerns with the three dimensions of power-knowledge- subjectivity.

As Langley explains, de Goede’s (2003; 2005a) approach is initially ‘derived from the work of Judith Butler which is itself grounded in a Foucauldian reading of power and Derrida’s deconstructionist engagement with Austin’ (Langley 2010: 74). Such an approach attempts to

¹⁶ For example here, we could consider the materialist titles of two of MacKenzie’s books, ‘*An Engine Not a Camera*’ (2006) and ‘*Material Markets*’ (2009).

¹⁷ Again here, we must reiterate the point about pragmatism in Austin, that this performativity is about both discourse and practices (Clarke 2012: 266).

¹⁸ See also Thrift (2000), Aitken (2007), Langley (2010) and Brassett and Clarke (2012).

displace discourse in favour of matter; a move from discursive practices of meaning making to material practices. However, if we advance and read de Goede's more recent (2012) contribution on '*Speculative Security*', we find that her reading of Butler is now through Bialasiewicz *et al* (2007) which:

'Moves us away from a reliance on the idea of (social) construction, towards *materialization*, whereby discourse "stabilizes over time to produce the effect of boundary, fixity and surface"' (Butler, 1993: 9, 12). Discourse is thus not something that subjects use in order to describe objects; it is that which constitutes both subjects and objects' (Bialasiewicz *et al* 2007: 407).

At this stage of the debate, it is important to note that not all accounts of performativity sit in one or the other of the two camps presented above. Elena Esposito has argued that because economics is an 'object that observes itself' (2013: 108), it becomes impossible 'to study the economy in the absence of the theory that discuss them' (Caliskan and Callon 2009, p.377 cf. Esposito 2013:113). As Esposito (2013: 113) puts it, 'economics becomes so extended that it completely overlaps the economy.'

Indeed, and to focus again on overlaps, it has been argued elsewhere that both seemingly competing conceptualisations of performativity contain a common emphasis on context, historicity and contingency (Clarke 2012: 268). Chris Clarke argues that in order to 'adequately grasp his (Austin's) understanding of the performative is ...to embrace the contingent and historicised nature of performative utterances.' So for Clarke, 'further reflection... might show how they both constitute a valid and useful understanding of performative finance, especially perhaps when used together' (Clarke, 2012:268). In line with this argument, Clarke goes onto to propose the notion of overlapping or 'layered performativities.'

Holmes' (2009, 2014) approach is particularly interesting because he is seemingly providing some kind of third way (Holmes 2009). As Holmes later emphasizes in MacKenzie, Muniesa and Siu's treatment of Callon, 'it is this kind of interweaving of 'words' and 'action' - of representations and interventions- that the concept of 'performativity' is designed to capture' (MacKenzie, Muniesa and Siu 2007:5 cf. Holmes 2014:23).

I build on these three attempts to challenge and reconceptualise the category of performativity and now move onto the theoretical contribution that this thesis makes to the performativity of finance. This is to draw on the insights of Derrida and Deleuze to argue that in addition to layers of generic and Austinian performativity in central banking, there is at least one additional layer at play. To

paraphrase anthropologist Daniel Miller, a focus on Austinian performativity has to potential to abstract out ‘relevant’ or ‘salient’ market characteristics from the material social entanglements that do not conform to the ideal type of markets posited in economics (Miller 2002: 229). These social entanglements are brought to the forefront of this section. For Thrift and Dewsbury (2000:414), a ‘major apprehension’ with generic performativity is the lack of creativity and ‘free play’, as the existing account prioritizes ultimately restrictive discursive operations. For example, the gendered subjects that we encounter in Butler ‘unconsciously’ resignify ‘a self- identical principle which forecloses an analysis of the variable nature of social action and change’ (Thrift and Dewsbury 2000: 414).¹⁹ The critique then, is that if generic performativity is about a performance of something, then perhaps the consequence is to lose touch of the liveliness and potential for disruption are lost from ‘performance’.

The contribution made here then, is to argue for a greater engagement with the work of Derrida and Deleuze. For Derrida (1988), communication is made possible by the breach or distance which lies at the heart of language’s ‘iterability’ (See Loxley 2007). Such ruptures have the potential to disrupt seemingly regimented conventions. Secondly however, I transpose Deleuzian ideas from Thrift and Dewsbury (2000) to look at gambles with unknown outcomes which are underpinned by difference. Again such actions disrupt the repetition of established discursive operations.

While Douglas Holmes explicitly draws on the work of Callon and MacKenzie on performativity (2014:23), he attempts to develop the concept using an appreciation of experimentation, which unfolds ‘in collaboration with the public across a communicative field in which research, broadly conceived, is ubiquitous and enacted by reflexive, thinking subjects.’ While the financial stability press conference can certainly be thought of as part of the collaborative or negotiated process between bank and public, more is needed to do justice to the complex dynamics at play in the press conference.

So, in particular, Holmes cites Muniesa and Callon on experimentation as the ‘organization of trials that lead to outcomes that are assessed and taken as starting points for further action’ (Muniesa and Callon 2007: 163). This may fit in with the ritualistic nature of the press conference and the publication to an extent, but is not quite appropriate for the Question and Answer session of the

¹⁹ It is not clear that this critique can be still be made of Butler’s recent thoughts on ‘performative agency’. For example, ‘the subject who can take responsibility for building a future must become capable of both translation and invention, what I am proposing we might understand as a kind of performative agency’ (Butler 2010: 155). Nonetheless the Deleuzian emphasis on creativity and difference is a sound way of leading to ‘invention’.

press conference that will be discussed in Chapter Four. Certainly the Bank tries to anticipate potential questions, but there is certainly not the element of control that we would imagine in an experimental trial. This then, is the liveliness and creativity of the Question and Answer session. In particular, Holmes' communicative experiments do not engage with the sort of structural breaches within language that we encounter through a Derridean reading. Nor does 'experimental trial' capture the unplanned or improvised gamble with unknown consequences that we encounter through Deleuze.

Holmes himself touches on creativity when he gives an account of the institutional management of the press conference. In his chapter on 'Representational Labour', Holmes reports a 'rehearsal' prior to the MPC interest rate decision and press conference. Rehearsal itself is suggestive of a process in which one tries to execute a script, in the knowledge that it may not go according to plan. Similarly, during this rehearsal, there is a presentation reporting on 'what external commentators', such as analysts in private firms and media commentators, were predicting regarding the decision that the MPC would arrive at on interest rates the following week. Included in this speculative outside analysis were theories about the motives and analyses that they imagined were informing the committee members' votes' (Holmes 2014:185). There *are* some extremely crafted and fluent answers that are seemingly pre-planned answers to anticipated questions, but this is not all. The creativity and unscripted nature of questions and answers can be found in the podcasts and transcripts of the June 2014 Financial Stability Press conference. In the remainder of the section I elaborate on the additional layer of performativity I am introducing, the layer of lively practices.

The move towards a lively conception of performativity, lies on an engagement with the work of Twentieth Century philosophers Jacques Derrida and Gilles Deleuze. Both of these authors are concerned with difference, but they take this concept in radically different directions (May 1997).

Derrida's seminal engagement with Anglo-American philosopher John Searle is important because it attends to the slippages in communication that do not appear to be captured by Holmes' idea of a negotiated performativity. Indeed there is no mention of Derrida (1988) in the communicative imperatives of *Economy of Words* (Holmes 2014). Butler writes that 'in 'Signature, Event, Context', Derrida argued that we can only think the process of iterability by understanding the rupture or failure that characterizes every interstitial moment within iteration' (Butler 2010:152). In other words, for Derrida, a sign or mark that was not repeatable would not be able to function as 'an element in a language and code.'

And, this repeatability or iterability of the mark means that while two identical marks are the same, there is also a difference because there are two of them (Loxley 2007:77-78). There is then, 'an irreducible difference to the structure of the mark.' For Todd May, this irreducible difference or absence is both spatial and temporal (May 1997:100). On the one hand, it is spatial because the consequence of language being a formal system of differences is that the meaningfulness of any given element in language is only by reference to other elements that are not present. On the other hand, it is temporal because the intention to mean something cannot ever be 'fully present to itself' (May 1997: 100).

As Loxley puts it, performativity as the 'simple conformity to constitutive rules can be put into question by the recognition that 'conventional systems or institutions are themselves necessarily implicated in an iterability they cannot simply contain' (Loxley 2007:89). So for Butler, if it is both true that a financial 'theory tends to produce the phenomenon', but also 'that it can sometimes fail to produce what it anticipates, then it seems we have opened up the possibility of 'misfire' at the basis of performativity itself' (Butler 2010:152). And, while such lively practices are referred to in the literature as 'misfires' (see Callon 2010), this seemingly lower status is not fairly warranted, according to Derrida at least, because such difference is embedded at the heart of each and every performative utterance (Derrida 1988:18).

If one way of being concerned with difference is through Derrida's concern with the 'necessity of absence or breach' within communication (Loxley 2007:77), then Deleuze is interested in how repetition or representation can be contrasted to a pure difference in which 'risky, creative and experimental' actions can anticipate but 'not know' their outcomes' (Williams 2013: 16). A Deleuzian alternative, of the kind suggested by Thrift and Dewsbury, is one which is sensitive to the creativity and novelty of performance, rather than merely the performance of existing categories and symbolism. To make this point, Thrift and Dewsbury suggest we think in terms of possibility, the real and representation for generic performativity, and the virtual, the actual and practice for a more Deleuzian variant of performance (Deleuze 1968 [1994]: 263). Thrift and Dewsbury read Deleuze as arguing that 'the realisation of the possible operates by the principles of imitation and resemblance', in this case the repetition of discursive operations. Because 'there are many possibles, any realisation of any one of them necessarily limits these potential possibles to only one.' To take this further and to relate to Deleuze's work on difference (1968 [1994]), 'the possible comes to completion only by being figured and represented as realisation, and thus filling the hollow or gap that difference resides in, nothing new is created.' Without difference, or the 'interval between, the new cannot take form' (Thrift and Dewsbury 2000:416). This mere

representation can be contrasted to practice. To go on and quote an extensive section from Thrift and Dewsbury (2000:416):

‘The *actualization of the virtual* does not operate through resemblance or representation but by generating difference, divergence and creation...’in order to be actualized, the virtual cannot proceed by elimination or limitation, but must *create its own lines of actualization in positive acts*. The reason for this is simple. While the real is in the image and likeness of the possible that it realized, the actual on the other hand, does not resemble the vitality it embodies. It is difference that is primary in the process of actualization- the difference between the virtual from which we begin and the actual at which we arrive’. This is the difference then, between representation and *practice*. In the one, we know the outcome, in the other, we can only...guess. And this imagination extends to conceptual practice, as well as the realm of percepts, affects and sensations.’

So, on this reading, another central aspect of the performative is not the known of representation but instead is that which diverges, and differentiates- instead of knowledge, here we have guesswork. On such Deleuzian terms, difference is something ‘risky, creative and experimental’, an action which can anticipate but ‘not know its outcomes’ (Williams 2013: 16). This Deleuzian version of performativity is radically different then to the existing approaches to performativity in central banking that can be distilled from the diverse literature because there is a liveliness here that is omitted from preceding accounts. And, central to my concerns is the performativity of both discourses and devices which coalesce within techniques. The various layers of performativity will be explored throughout this thesis, but lively practices come to the fore, specifically in Chapter Four. I present evidence that central banking does involve the invocation of generic and authority laden rituals, but I then go onto provide evidence of ways in which creativity is also present in the performance of central banking. One such way of doing this is through the ability to improvise an answer to a difficult question in a convincing and meaningful way. I provide illustration of improvisation in Chapter Four. An alternative, also highlighted in Chapter Four, is the ability to employ humour and make jokes, which as Bergson (1935) reminds us, involves imagination, and what Pixley (2012) and de Goede (2005b) would identify as emotion as well.

2.2 Central Banking as ‘Assemblage’

This theory chapter now moves onto challenge a second baseline assumption of much of the extant social science literature concerned with central banking- the assumption that central banks are unitary and bounded agents that govern when they are acting, such as when raising interest rates, being the lender of last resort or by shaping expectations through public communications. This assumption is seemingly commonsensical. After-all, if this is not the case, then why is it that we are interested, if not fascinated, by the central bank and its governor? (See Greider 1987; Van Overtveldt 2010; Axilrod 2009; Conaghan 2012). I approach this question of agency and action through an initial and different engagement with social science accounts of central banking.

The assumption of unity and boundedness leads to a view manifest in the literature; that governance entails governance *of some thing by some other thing*. So for Geoff Mann (2010), central banks govern in the form of a technocratic and Hobbesian sovereign looming above a society and here we see a governance of an economy. The sovereign central bank is one that exercises an absolute right, a concentration of power over an economy and through ceremony. Similarly for Samuel Knafo (2013) the emergence of the Bank of England as a central bank is about power over merchants and bankers in financial district of London (Knafo 2013: 36, 176). In the account that can be gleaned from the writings of David Harvey (2006, 2010), he posits a hierarchy of institutions, ‘as the banks do for the individual capitalists, as the central bank does for the private banks, as a de facto ‘world banker’ does for national central banks’ (Harvey 2006: 249). As Nigel Dodd argues, on this more Marxian reading of the central bank, power is predominantly negative and disciplinary upon those lower down through, at its extreme worst ‘brutal class realignment’ (Dodd 2014:70). What can be discerned in Harvey’s work is then is a governance by one level over another. This general pattern is also ascribable to Rodney Bruce Hall’s *Central Banking as Global Governance* (2008), in which the power of the central bank is grounded in subject/object relationships. Such relationships work both ways, as it were, with bond and FOREX markets sometimes exerting structural power over a central bank.

The problem with approaches that treat central banks as unitary and bounded actors is that they encounter a significant lacuna. As David Hudson has pointed out, when we treat our object of analysis as a unitary actor within a simple subject/object relationship, be it ‘the Central Bank’ or ‘Finance’, then one elides the ‘ensemble of governance, as a state-market condominium’ (Hudson 2005: 65). One then has very little to say *of* finance, that is to say, specify the ‘it’ that is being both

governed and analysed. And, it is precisely finance and financial techniques that central banks do speak of in their financial stability reports. The analysis then neglects an important feature of governance.

So, if we are not to treat central banks as either a unitary black-box, or part of the formula x governs y , what is an expedient or feasible alternative? As I have outlined in this chapter and my review of geographical literature, distributed and relational agency is a central conceptual concern in cultural economy. To move towards one such author, I want to draw on Langley's notion of 'governance through economy' (2014:39), to forward the idea that central banks govern (or have governed) *through* finance and financial techniques. This is similar to the move towards an economic governance whereby state officials achieve policy objectives through markets (Krippner 2007:477). And further, this is not a new phenomenon. Indeed, when we consider a view of financial governance from the 1940s we have a relational and distributed view in which:

'... the relation between the Treasury and the Bank of England and through the Bank of England with the big banks, the Government have been able to devise in this imperfect world about as perfect a system for working this part of our financial machinery as could be found.' (Sir George Schuster M.P in the House of Commons, 3rd February 1943 cf. Saw 1944:1).

At this stage it is important to add that the argument I am developing here about a literature focusing on unitary actors cannot be levelled at social science accounts of financial governance *tout court*. As Velthuis (2015) has recently argued, central banks in Europe and the United States seek to govern publics and markets *through* the financial media, and in doing so need to negotiate the rules, frameworks and reward systems that are present in newsrooms. This is important because it highlights that central banks are not unitary actors and that the realities of the medium through which central banks operate are not a simple transition mechanism.

Similarly, I consider four relational approaches to the governance of money from the social science literature, to be found in the work of Douglas Holmes (2014), Marieke de Goede (2012), Paul Langley (2014) and Benjamin Braun (2015). The first of these authors specifically develops a relational account of central banking. For Douglas Holmes' central banks are implicated in an 'intellectual and...performative apparatus' of monetary policy in his *Economy of Words* (2014). For example, Holmes argues that:

'the Fed has developed an intellectual apparatus operating *in vivo*, a performative apparatus composed of interlocutors who are not merely representing economic conditions: they are actively participating in the creation of those conditions The two hundred and seventy

interlocutors that make up this formal apparatus are, of course, linked informally to secondary and tertiary networks (of their own making)- networks composed of countless other contacts who do not merely have intellectual access to a vast communicative field but who are the circuitry of the field' (Holmes 2014: 51).

At first reading, 'apparatus' apparently links to Foucault's writings on the *dispositif* (1979b, 1986, 2007, 2008) which, prior to the English translations of *Security Territory, Population* (2007) and *The Birth of Biopolitics* (2008), was thought to be one of Foucault's most elusive and challenging theoretical devices (Brigg 2006: 69). Deleuze's (1992) translation as 'concrete social apparatus' became a focal point for scholarship, and following the translations of the aforementioned lecture series, 'apparatus of security' is the standard translation. The welfare, education and health systems of advanced liberal societies are viewed as tangled webs of 'discourses, institutions and regulatory decisions' (Foucault 1979b: 195; Dean 1999:29). Such apparatuses of security function 'to enable the circulations that define the personal and commercial 'freedoms' of liberal-democratic life' (Anderson 2012:34).

However, despite the term 'apparatus', it seems reasonable to characterize Holmes' central bank as closer to a more Deleuzian conception of *agencement*. I make this move because Holmes' work both employs and modifies the concept of performativity through authors such as Callon and MacKenzie (Holmes 2014:12). This term '*agencement*' denotes 'sociotechnical arrangements when they are considered from the point of view of their capacity to act and give meaning to action'. The consequence is that 'actors' thought to lie within *agencements* 'do not have inherent properties or a fixed ontology. Their characteristics are constituted by the *agencements* of which they are made up ' (Hardie and MacKenzie 2007: 3-4).

There are, however, two apprehensions that I have with using an *agencement* approach for central banking. The first is that much of the sociological work on socio-technical *agencements*, emphasize the technical at the expense of subjectivation (see Callon, Millo and Muniesa 2007). Although techniques are a fundamental concern of the thesis I am developing, I want to say that more is enrolled in this account of distributed agency. And, unlike much of this SSF *agencement* centred work, assemblage thinking involves a concern for the discourses which connect with publics and summon up subjectivities, (Deleuze 1992:340). This in turn allows an account of the bundling together of economy and subjectivity, both by returning to the attempts to foster secure, responsible, prudent and confident traders and publics through a financial stability assemblage.

Secondly an *agencement* approach is absolutely fine if one is characterising one aspect of central banking, and one network. However, this becomes problematic if one wants the components within an *agencement* to also be present within other *agencements*. This should be in contrast to assemblage, where, the component parts of an assemblage are said to be ‘autonomous from their relations’ (DeLanda 2006:10). Assemblage thinking holds that although no component part can be absolutely isolated from the multiple relations in which it is involved, every part still retains certain stand alone “properties” that are not defined by the set of relations it finds itself within (DeLanda 2006:9). These properties are retained by the entity when it moves from one set of relations to another. Thus an element is, in the words of Anderson *et al*, ‘conditioned, but not determined, by its relations’ with other elements (2012a:177). This rather abstract point is significant because it implies that the same thing can be a component in two separate assemblages (Allen 2011:155). Assemblage thinking therefore promises to provide a fuller account of central banking than currently exists in the literature because one can study the price stability -assemblage and an emerging financial stability-assemblage. Thus the Bank of England can be implicated in assemblages of both monetary and financial governance. Further, it allows several smaller assemblages, such as discourse-money-confidence, stress testing and credit derivatives, to cluster around financial stability.

Holmes is preoccupied with the ‘nature and status of the public in this monetary regime’ and while I think that this is a wholly appropriate for the issue of price stability, precisely because the central bank is governing through expectations of a population, something slightly different is needed here. This is because financial stability is governance through financial practices, equations, regulatory models, hypothetical scenarios and public communications. In short, an attention to an assemblage of technologies, devices, people and techniques is needed. As Nigel Dodd puts it, a Deleuzian reading of contemporary capitalism is such that ‘money... is part of a complex series of interrelated flows of people, goods, images, bodies and ideas’ (Dodd 2014: 232).

An alternative to *agencement* is suggested by a reworking of de Goede’s formulation of the ‘finance-security assemblage’, which she employs to frame her work on governmental attempts to monitor and pursue international flows of terrorist monies. For de Goede, the finance-security assemblage involves diverse elements which work together across multiple sites (de Goede 2012: 28). As Bennett tells us, this is a thoroughly material ‘working whole’ consisting of ‘somatic, technical, cultural and atmospheric elements’ (Bennett 2005: 447 cf. de Goede 2012: 29). And despite the seemingly Deleuzian terminology, de Goede does not cite Deleuze at any point and elsewhere

maintains that she is pursuing ‘Foucauldian’ concerns by other means (Gilbert *et al* 2013:58). Close to de Goede’s account is that of Langley (2013a, 2014). He provides an account of financial governance that moves beyond governance of *x* by *y* in his argument that the Global Financial Crisis was governed by and through a series of *dispositifs*. Here Langley’s work makes explicit connections to the work of Foucault. Langley (2014:32) quotes Foucault and writes that ‘a *dispositif*’ is ‘essentially of a *strategic* nature’ (p. 196, *original emphasis*), a particular configuration that ‘has as its major function at a given historical moment that of responding to an urgent need (pp. 194-5)’. To take an example, for Langley the governing of the Subprime Crisis is best conceived of as being through a series of *dispositifs*, such as the Troubled Assets Relief Programme (TARP). This ‘apparatus’ was the contingent product of ‘prevailing economic theories of liquid markets, financial market models and strategies and the calculations of bank balance sheets and CDS contracts’ (Langley 2013a: 115). In his very recent *Economy and Society* paper, Benjamin Braun (2015:371) ‘follows Langley’ in terms of employing a Foucauldian apparatus in the context of European Central Bank monetary policy and guidance of inflationary expectations.

And while de Goede, Langley and Braun’s use of apparatuses/assemblage does clearly fit their particular empirical cases, and includes a focus on subjectivation, some modification is needed to give an account that not only includes moments of clear and effective governance, but the before, after and tensions of a financial life that often exceeds attempts to govern it. And here subjectivation and agency is something much more ‘fragile and fluid’ than in Foucault’s treatment (Langley 2014: 32).

To move towards the assemblage as set out in *A Thousand Plateaus (ATP)* (1987), Deleuze and Guattari describe assemblages as comprising:

‘Two segments, one of content, the other of expression. On the one hand it is a machinic assemblage of bodies, of actions and passions, an intermingling of bodies reacting to one another; on the other hand it is a collective assemblage of enunciation, of acts and statement... Then on one vertical axis, the assemblage has both territorial sides, which stabilize it and cutting edges of deterritorialization which carry it away...on the second axis, what is compared or combined of the two aspects, what always inserts one in to the other, are the sequences of conjugated degrees and of deterritorialization and the operations of reterritorialization which stabilize the aggregate at a given moment’ (Deleuze and Guattari 1987: 97-98).

In short, the arguments that I am making here are that we must go beyond focusing on merely institutions and policies when conceptualising the financial stability work of the Bank of England. Instead I am focusing on a contingent fitting together of various financial stability techniques. And, while techniques such as press conferences do employ some performances of parliamentary sovereignty, the general emphasis is on the way in which central banks are implicated in assemblages of distributed action. So the existing literature on relational and distributed governance, from authors such as Holmes (2014), Langley (2014) and Braun (2015), focuses on the clear governmental or reterritorializing function of the central bank. The difference in the account I am developing attends to moments of disorganization, instability and deterritorialization.

2.3 Financial (In)stability as a dynamic tension.

Distributed agency and performativity are not the only SSF concepts that I seek to rework within the context of central banking and financial stability. As they are developed here, the Deleuzian concepts of performativity and assemblage could quite plausibly be inserted into a wide range of accounts of cultural life. In short, I have as my target the very concept of stability. The geographical literature review in Chapter One argued that geographies of financial accumulation tend to draw on critical and heterodox political economy ideas, couched in the work of Marx (1894), Keynes (1936) and Minsky (1982). The crucial thought running through these works is that financial crises occur precisely due to inherent features of financial capitalism. For classical Marxists, these are the inherent contradictions of capitalism, while Keynes locates the very nature of money and the future as drivers for instability. For Minsky, stages of stability actively contribute to later periods of instability.

Indeed, what is striking when one traces the history of the concept of ‘financial stability’, there is substantial evidence to suggest that the concept was not well-thought out prior to the Global Financial Crisis. For example, in 2004 Charles Goodhart argued that ‘there is currently no good way to define, nor certainly give a quantitative measurement of, financial stability’ (cf. Davies and Green 2010:54). Davies and Green note that subsequently ‘financial stability’ has been hard to define and it seems that to many who work in financial governance, its meaning changes often and can only be fixed in any coherent way as the absence of the more tangible and pervasive concept of ‘instability’ (Davies and Green 2010:55, 57). And, to combine this line of argument with the previously

encountered geographies of financial accumulation, finance shifts between stability and instability- with stability often itself becoming a destabilizing force.

To move onto what makes this Deleuzian account predominantly an economic one, I move onto consider money, finance and debt in the work of Deleuze and Guattari. Here, when we consider Deleuze and Guattari's ambition to provide a critical account of the development of capitalism, it is somewhat disappointing that only Hardt and Negri (2001) attempt to use Deleuzian concepts to account for the development of globalized capital in the contemporary world. As such, very few authors have attempted to fully develop Deleuze's writings on finance. Further, there is little convergence between the uses of concepts in a small and diverse literature. Authors such as Arnoldi (2004) and Lozano (2013, 2015) seem to be attracted to Deleuze's formulation of the 'virtual' and the potential therein for a discussion of the abstract yet material nature of much contemporary financial innovation, such as synthetic finance. Philip Goodchild's analysis of money following his reading of Deleuze points to the 'immanence' of money and 'capital as desire' within everyday contemporary life (2010: 31-32; See also Goodchild 2009). Langley (2014: 42, 247) alternatively seizes on the systemic 'modulation' of financial flows in crisis governance. This reticence to draw on or incorporate Deleuzian concepts into financial accounts can, in part, be considered to be a result of several issues with Deleuze's account of money (Kerslake 2015). Throughout the *Capitalism and Schizophrenia* project (1983, 1987), Deleuze and Guattari give us a mutable and often confusing account of money in which it is wrought with a 'dynamic tension between payment money and finance money' (See Kerslake 2015: 39; Dodd 2014: 235-236). While 'payment money' is that is the medium of exchange and units of currency in simple circulation- the money which pays bills and buys things- 'finance money' is that which is created by banks incurring debts to themselves. This latter form of money is about 'the power to control time through the creation and destruction of money' (Dodd 2014: 233). According to Nigel Dodd, Deleuze and Guattari leave it open as to how these two forms are seen as being a homogenous money in the public psyche (Dodd 2014: 236). If we read Goodchild on this, then Deleuze and Guattari give us a philosophy of 'schiz-flows', in which 'one term is continually passing into the other' in a perpetual process of being- becoming (Goodchild 2010: 30). It is beyond both the scope and the ambition of this thesis to provide a conceptual account of money due to the sophisticated and rich level of existing debates within heterodox theories of money.²⁰ However, even if we do find Deleuze and Guattari's account of money to be problematic, this does not mean that we should not employ other Deleuzian concepts such as a

²⁰ Here a reader interested in such conceptual debates should see Ingham (2004), Dodd (1994, 2014) or Zelizer (1997).

dynamic tension- in which one term moves into the other- to think about finance. It is interesting that in his recent and illuminating account of 'money as icon', Martijn Konings identifies a second dynamic tension within money- that it is both 'liquid and solid' (2015: 17). By this Konings means that money is both a 'complex relational construction' and 'a solid objective fact' (Konings 2015: 17). This suggests to me that we do need to account for dynamic tensions within finance.²¹ Here then is one firmly Deleuzian approach to economy- it embraces the dynamic tensions in financial life.

Moreover, Deleuze and Guattari argue that the fundamental dynamic tension within capitalism is that between deterritorialisation and reterritorialization. For example, in *Anti-Oedipus* (1983) they write that if one is to attend to the 'real history of corresponding society', one is better able to understand why 'capitalism is continually reterritorializing with one hand what it was deterritorializing with the other' (Deleuze and Guattari 1983: 259). In the same section the authors elaborate that 'it may be all but impossible to distinguish deterritorialization from reterritorialization, since they are mutually enmeshed, or like opposite facets of one and the same process' (Deleuze and Guattari 1983: 258).

On this account, capitalism:

'both does and does not have an exterior limit: it has an exterior limit that is schizophrenia, that is, the absolute decoding of flows, but it functions only by pushing back and pushing back and exorcising this limit. And it also has, yet does not have interior limits: it has interior limits under the specific conditions of capitalist production and circulation, that is, in capital itself, but it functions only by reproducing and widening these limits on an always vaster scale' (Deleuze and Guattari 1983: 250).

In other words, capitalism is continuously pushing beyond its limits as an open ended process of deterritorializing to seek out opportunities for profit, and at the same time reterritorializing to capture that profit. It is the logic of capitalism to then look and move beyond this new limit. It is a deficient account of capitalism if it were to mobilize de-territorialization without reterritorialization (Goodchild 2010:30).

Here then, as Goodchild argues in strictly Deleuzian terms, we have a dualism in which both terms need to be embraced and mobilized (2010: 30). In other words, normal financial practices of profit and arbitrage feed off price instability which is seemingly necessary for these forms of accumulation.

²¹ See also Konings (2011a) for an extended account of the paradoxical nature of money.

At the same time, some measuring of price stability is also desirable for the entrepreneurial investment process (Blyth 2002). Derivative practices embody this logic- there is an indifference to the direction of fluctuations in prices because speculative trading occurs alongside hedging. Stability isolated by itself can then be treated as an ‘abstraction’ rather than an ‘expression of a sociological reality’ (Walters 2006 cf. Aitken 2015: 5).

Here I draw on the fundamental dynamic within an assemblage which Deleuze argues distinguishes the former concept from that of a Foucauldian apparatus. As Deleuze puts the point when writing about *dispositifs* (Foucauldian apparatuses) in an essay entitled ‘Desire and Pleasure’:

‘*Dispositifs* of power would emerge wherever reterritorializations, even abstract ones, are brought about. *Dispositifs* of power would then be a component of *agencements*. But the *agencements* would also be composed of points of deterritorialization’ (Deleuze 1994: 186).

What Deleuze is offering us is a view of two contrasting processes, both of stabilization and of (cutting edges of) destabilization, destratification and flight (see figure 1).

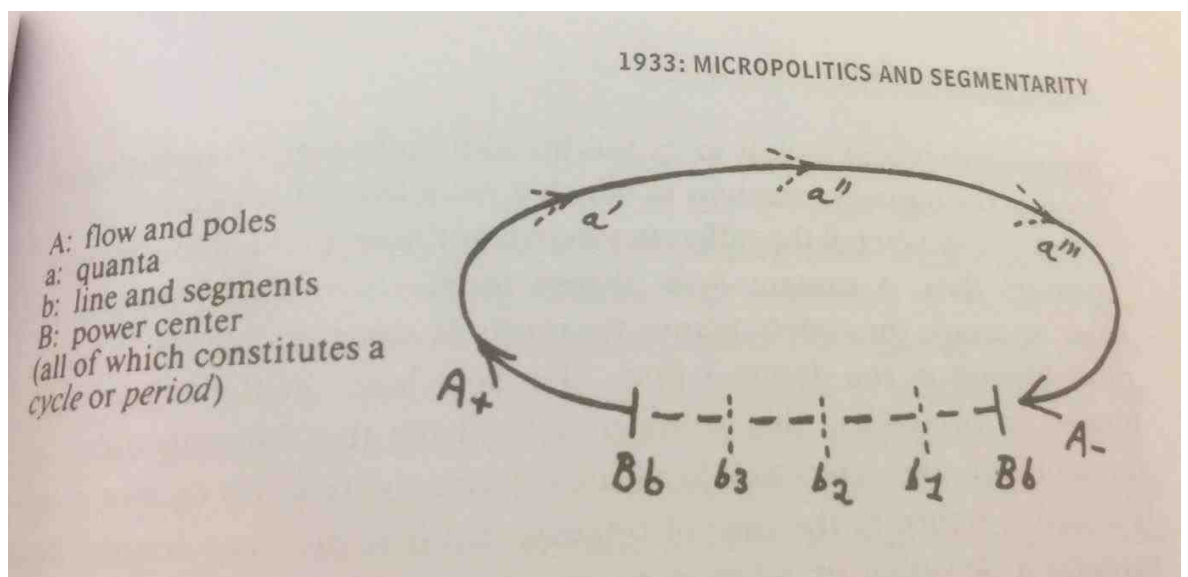

Figure 1: *The Assemblage*, taken from Deleuze and Guattari 1987: 241.

To draw on Allen and Pryke (1999:53 cf. Dodd 2014: 232):

‘In the Deleuzian spatial vocabulary , individuals are made up of a tangle of lines which cross over one another in all kinds of ways, composing and decomposing lives in a manner that illustrates their subtle modifications and detours as well as their more fixed attachments and territories.’

And to illustrate what a Deleuzian approach offers in comparison to the more or less Foucauldian literature consisting of authors such as de Goede (2012), Langley (2014), Holmes (2014) and Braun (2015), I turn to a section of *The Birth of Biopolitics* in which Foucault effectively encounters the breakdown of the Keynesian state-apparatuses of post-war Britain and the United States. As Foucault elaborates:

‘Finally, and above all, there are processes of clogging, such that the mechanisms for producing freedom, precisely those that called upon to manufacture this freedom, actually produce destructive effects which prevail over the very freedom they are supposed to produce. This is, if you like, the ambiguity of all the devices which could be called ‘liberogenic’, that is to say, devices intended to produce freedom which potentially risk producing exactly the opposite’

(Foucault 2008: 68-69).

Here the dynamic tension between reterritorialization and deterritorialization must take the forefront of the analysis. Such a move goes beyond a concern with Foucault’s prescient insights on the art of governance in *Security, Territory, Population* (2007) to instead read closely this short passage. Foucault’s account of ‘clogging of mechanisms’ with ‘destructive effects’ points to the destabilization of liberal apparatuses. And, because the liberogenic concept itself is underdeveloped in the secondary literature, authors working within his analytical frameworks have consistently looked to Foucault as a theorist on the development and ongoing intensification of security apparatuses (See Nealon 2008; Langley 2014). In *Birth of Biopolitics* we see an example of what Deleuze himself offers as a general distinction between his own work and that of Foucault (Deleuze 1994: 186). Instead here is the documentation of a process of destabilization (Foucault 2008: 68-69). More than this however, Foucault gives us an account of a dynamic tension within liberalism that ‘devices intended to produce freedom...potentially risk producing exactly the opposite’ (2008: 69).

While de Goede’s working of assemblage does seek to include tensions, contradictions and frictions of the assemblage, it seems to me that fundamentally its purpose is to reterritorialize- in other words stabilize, make actionable or organise. Thus this is only one aspect of the vertical axis that Deleuze gives us. The ‘cutting edges of deterritorialization’ are a critically important innovation of a ‘Deleuzian cultural economy’ because they account for the tangible instability and

crises that frustrate attempts of governance. And while Deleuze himself had little to say about central banking, that which he and Guattari did say is revealing as to the direction that the analysis offered here will take:

‘banking power, concentrated most notably in the central banks... is indeed a question of the relative power to regulate ‘as much as’ possible the communication, conversion and coadaptation of the two parts of the circuit.’ Central banks then are ‘defined much more by what escapes them or their impotence than by their zone of power’ (Deleuze and Guattari 1987:239).

In *ATP*, Deleuze and Guattari sketch out a central bank as being part of an assemblage or ‘one of many points in the border between’ processes of reterritorialization and deterritorialization of flows (Deleuze and Guattari 1987: 239). That is to say, between the organization of a function for a particular purpose, and the escape from this organization. And, for Deleuze and Guattari, flows are that which has yet to be captured, organised or re-territorialized by the Foucauldian (apparatus) aspect of the assemblage. So, in Figure 2, the central bank within the points marked *B*, while the small *bs* connote attempts to reterritorialize flows, marked as the small *as* circulating between *A+* and *A-*.

The first of two economic examples given in *ATP*, the reterritorialization of monetary flows occurs in the form of ‘a corporate budget (real wages, net profit, management salaries, interest on assets, reserves, investments, etc)’. These are ways in which flows of money are structured organised and stabilized. In the second instance ‘the poles of the flow are the creation of money and its destruction; the singularities are nominal liquid assets; the quanta are inflation, deflation, stagflation etc’ (Deleuze and Guattari 1987: 239). This captures the circulation and movement of money. As the dynamic flows of money circulate, they do not allow themselves to be segmented (as in *b1-b3*). Within the ‘power center’ or central bank’ is the reterritorialization or attempt to capture, of the manner most attuned to the account of financial governance provided by de Goede (2012) and Langley (2014).

The Deleuzian concept that I am developing here is (in)stability. That is, the *continual process* of deterritorialization and reterritorialization within finance, and both the dynamic tension and mutual enmeshment between the two. This is important for financial stability, because it suggests that finance is never just deterritorializing or reterritorializing, but instead *is constantly in a process of one becoming the other*. This can be contrasted to existing interpretations of Deleuze, such as that of Manuel DeLanda, for which it is possible to make a clear dichotomy where reterritorialization is

synonymous with stability, and opposed to deterritorialization and instability (DeLanda 2006: 12). And, while in Chapter Six the deterritorializations of VaR that the Bank of England is aware of do involve instability, across the thesis as a whole I diverge from this. I argue that, as I understand and employ them, the terms 'territorialization' and 'stability' are not synonymous.²² Territorialization and deterritorialisation are, then, ways of rendering the risk of an uncertain future actionable through 'calculation, comprehension and colonization' (de Goede 2012:xxi). Within the financial context, this can be seen as the moving between security, in the form of hedging, and profit, in the form of speculation²³ (Esposito 2011: 118).

I begin with the geographies of financial globalization. Following the Wall Street Crash of 1929 and consequent Great Depression of the 1930s, finance became regulated in a way that sought to stabilize and dampen the perceived excesses of financial speculation. For example, speculative investment banking was cleaved from commercial, deposit taking banking by the Glass-Steagall Act of 1933. At the end of the Second World War, the 1944 Bretton Woods Agreement put in place further territorializing and stabilizing regulations, such as cross border capital controls, a managed exchange rate system and the creation of the International Monetary Fund. Such a Keynesian or 'embedded' liberalism sought to both eliminate the cyclical extremes of an unregulated entrepreneurial economy and to put finance at the service of the purportedly more 'productive' parts of the economy which employed the majority of the population (Ruggie 1982; Greider 1997; Blyth 2002). In such a way, by the mid-1960s financial accumulation began to turn on such a way that profitability involved eluding and escaping the territorializing and stabilizing regulations imposed during the Bretton Woods era (Konings 2011b: 111). In particular, the development of 'euromarkets' for debt in Europe's financial centres effectively deterritorialized US dollars into these ostensibly European monetary spaces and accrued greater profits than domestically bound dollars (Leyshon and Thrift 1997: 89). During the early 1970s, the Bretton Woods system deteriorated further, exemplified by the breaking down of exchange rate coordination. In *World Financial Orders*, Langley (2002) gives an account of the 'unprecedented transformation of the spatiality' of 'world credit practices' from the 1970s and onwards to become a 'global finance' (Langley 2002: 93).²⁴ Here we could point to, the 'abolition of capital controls', 'deregulation of

²² I thank Gavin Bridge for pushing me on this point.

²³ Here by speculation I am thinking of the investment in securities to gain profit. See de Goede (2005: 47-145) for a Cultural Economy account of speculation and investment.

²⁴ See Chapter Three of Leyshon and Thrift's *Money/Space* (1997) for an account of this historical process from a UK perspective. See also Baker, A., Hudson, D. and Woodward, R. (eds.), (2005) for a pre-Subprime Crisis volume on the 'multi-level' governance of global finance.

the London Stock Exchange' and the dismantling of 'artificial barriers between financial sectors' which all occurred in the early 1980s and affected the spatiality of credit creation in the City of London (Woodward 2005: 156). This novel spatiality has been primarily viewed as negative, destructive and intimately related to financial instability (Strange 1986, 1998; Best 2005, 2007; Nesvetailova 2007, 2010; Dymski 2000; Harvey 2010; Engelen *et al* 2011). Throughout the 1980s, 1990s and 2000s the global political economy has been marked by a succession of high -profile financial crises and instabilities related to the globalization of capital flows and credit.²⁵ Such experiences of the Twentieth Century have served to equivocate between financial deterritorialization and financial instability. For example, In *Mad Money* Susan Strange (1998: 14-17) draws on a wide range of authors, including Kindleberger (1987), Greider (1997) and Eatwell (1996), to argue that speculation under complete deregulation would serve to be a destabilizing force for the global financial system. Similarly, and moving further forward to consider the Global Financial Crisis, Engelen *et al.* give an account of private equity and hedge funds as 'nomadic war machines' which are 'a marauding, rootless army' seeking out opportunities for 'value-extraction' (Engelen *et al.* 2011:77),

However, the equivocation between deterritorialization and instability we can read into this brief history of contemporary financial globalization fixes squarely on the speculative and fragile nature of financial accumulation in a way that it escapes the regulatory state.²⁶ Thus, such an account neglects the 'hedging' propensity of financial practices and the uses to which these were put from the 1990s onwards. As Elena Esposito eloquently puts it, 'the meaning of the economy' is the 'present social management of the obscurity of the future and the social use of time to protect against the threats of time' (Esposito 2011: 40). Reterritorialization and deterritorialization are two contrasting ways of manipulating present risks about an uncertain future and present themselves in terms of hedging and speculation. And, within the context of the ongoing development of American finance, Martijn Konings (2011b:126) argues that the opening up of securities markets in the late 1980s and early 1990s created 'a densely populated and highly competitive market' in which 'fine-tuned instruments were needed to carve out opportunities and exploit smaller margins.' During the early 1990s the technical problem of risk assessment was no longer solely used to identify bad risks that should be

²⁵ Here I am thinking of the 'Third World Debt' Crisis, the 'Tequila' Crisis, the Asian Financial Crisis and the Global Financial Crisis respectively.

²⁶ In *Mad Money* (1998) Strange argues that because of this globalization and innovation, state bound regulation has become obsolete and re-regulation must occur at the international level.

avoided and instead put to the additional use of identifying ‘how a given portfolio could be invested with an optimal risk and return profile’ (Konings 2011b: 126). In other words, financial risk management techniques, such as credit derivatives and Value-at-Risk, somewhat imperfectly secure against future events²⁷, such as portfolio losses, defaults and price fluctuations, and, increasingly since the 1990s, were put to use to seek out a rate of return.²⁸ Perhaps the best characterization of the blending of these strategies is Marieke de Goede’s (2012:xxi) term ‘Speculative Security’, in which security practices are:

‘rendered possible through appeal to the uncertain but potentially catastrophic futures that fungible money flows can cause. And they are speculative in ends because they foster a fragile and contestable state of security.’

Or, as Louise Amoore (2013: 61) has it, a host of financial ‘risks are not treated as threats in and of themselves but as sets of relations that can be unbundled, reattached to other elements, and repriced.’ This mutable shifting between speculation and hedging, then, seems to delineate a logical difference to the deterritorializations exemplified by financial globalization, market penetration and expansion or land grabs. And, to push this further, the relationship between re-territorialization and stabilization with which this thesis is preoccupied should be considered to be a ‘state –market condominium’ (Hudson 2005) through which state sovereign techniques, such as capital adequacy standards, are reworked, and market risk management techniques are a constant object of policy concern for the Bank of England.

In chapters Four to Eight, I present a financial stability assemblage of press conferences, financial stability reviews, credit derivatives, Value-at-Risk calculations, stress testing and money-enunciation- confidence. Therefore, the account of (in)stability that I am providing fixes onto the ongoing process and enmeshment of territorialization, deterritorialization and reterritorialization (Deleuze and Guattari 1987: 98) within these risk management techniques.

²⁷ For Esposito (2011) this process is imperfect precisely because financial engineering oversimplifies the future.

²⁸ The Goodhart *et al* (1998) book *Financial Regulation: Why, how and where now?* is a particularly illuminating example of the regulatory community coming to terms with this development. This focus on financial innovation rather than globalization puts an emphasis on arguments from authors such as Esposito (2011:123) and Nesvetailova (2010a/b). This is also part of Strange’s (1998) argument although she deals with a less sophisticated and pervasive innovation.

2.4 Performativity as an Instance of Assemblage

As signposted in the introduction to this chapter, the consequence of opening up the category of the performative in the way I suggest collapses performativity into the account of assemblage provided by Deleuze and Guattari in *ATP*. This, I think, is consistent with Elena Esposito's recent argument that what is needed is a broader conception of performativity, one in which the concept is extended to the 'whole economy' (Esposito 2013: 134). In other words, a successful performative utterance or performance becomes an instance of assemblage. As Deleuze and Guattari argue:

'The performative itself is explained by the illocutionary, not the opposite. It is the illocutionary that constitutes the nondiscursive of implicit presuppositions. And the illocutionary is in turn explained by collective assemblages of enunciation, by juridical acts or equivalents of juridical acts, which far from depending on subjectification proceedings or assignments of subjects in language, in fact determine their distribution' (Deleuze and Guattari 1987:87).

On this reading, the illocutionary force that a speech act has in being said is explained by an already existing web of conventions, what Austin refers to as the 'felicity conditions' that need to be in place for a successful performance (1962). The illocutionary then, is 'explained by 'collective assemblages of enunciation' (Deleuze and Guattari 1987: 87). Here I want to extend this reading, to argue that we conceptualise the perlocutionary effect, the on-going situation which is altered by and results from the performative, in terms of the intermingling of bodies and objects that Deleuze gives us in the machinic assemblage (1987: 97). Within this category are the material practices and techniques of financial stability such as press conferences, derivatives, calculative devices (VaR), stress tests and the assemblage of money, enunciation and confidence.

This account of intermingling modes and objects speaks to the lively practices that I developed in my section of performativity. So for Deleuze and Guattari (1987: 98-99):

'on the one hand the ship-machine, the hotel-machine, the circus-machine, the castle-machine, the- court machine, each with its own intermingled pieces, gears, processes and bodies contained in one another or bursting out of containment... a precise state of intermingling bodies in a society, including all the attractions and repulsions, sympathies and antipathies, alterations, amalgamations, penetrations and expansions that affect bodies of all kinds in their relations to one another.'

The consequence then, is that a Deleuzian cultural economy provides a much wider account of performativity than that introduced and mobilised by the Social Studies of Finance. Financial life is a series of actual and real ‘connections between discourses things, subjects and organs’ (Dodd 2014: 228). Crucial is the Deleuzian focus on the two interacting segments of the assemblage. This is because the account I am building sees performative collective regimes of enunciations coalesce with machinic assemblages in the form of financial stability techniques. Financial stability is governed through an assemblage of an array of techniques, sites and material forms, including credit derivatives, Value-at-Risk, stress testing, press conferences and money-enunciation-confidence.

2.5. Conclusion

To conclude this theory chapter- and reiterate my main conceptual moves- here I am presenting a cultural economy account which broadens the categories of performativity and apparatus as currently used to describe and analyse financial governance. Taking the Bank of England’s financial stability work into account, the ideas that either economics shapes the economy, or that the economy is a performed discursive domain, need to be broadened to include moments of rupture from established convention, as well as moments of improvisation. Secondly, central banks are not treated as bounded and unitary actors but instead govern through outside techniques and material practices. The category of apparatus needs to be opened out to include a series of heterogeneous elements, including people, techniques, discourses, money, financial projects, calculations, models and confidence. This opening up of the concept to that of assemblage means that it includes instances where components of the apparatus exceed attempts to hold them together in regulatory harmony. It also allows us to account for governance through deterritorialization, such as the security logic of the credit derivative (Chapter Five).

Thirdly, I have drawn on the discussion of the political economy of financial accumulation to deconstruct the notion of ‘financial stability’ so that it should not be considered a tangible state of affairs but instead part of a ‘schiz-flow’ or dynamic tension between territorialization and deterritorialization. The deterritorializing with which this thesis is preoccupied is not a globalizing escaping of the territorial regulator but instead the way in which, since the 1990s, techniques of risk management secure, albeit imperfectly, both seek out rates of return and secure against future

events by manipulating risk. Stability does not occur merely through geographical reterritorialization but instead a melding of state and market through which state sovereign techniques, such as capital adequacy standards, are reworked, and risk management techniques are a constant object of policy concern for central banks. I am therefore describing this process using a Deleuzian inspired concept of (in)stability, from which the title of the thesis derives.

Fourth and finally, the consequence of opening up the category of the performative in the way I suggest in the first section of this chapter, causes it to fold into the account of assemblage provided by Deleuze and Guattari in *A Thousand Plateaus (ATP)*. Performativity becomes an instance of assemblage. This account of intermingling modes and objects speaks to the lively practices that I develop in my section on performativity. The account I am developing centres on the way that machinic assemblages and collective assemblages of enunciation coalesce in the form of financial stability techniques. As the conceptual moves made in sections 2.2 and 2.3, these techniques are subject to both deterritorialization and reterritorialization.

Chapter Three- Researching the Assemblage.

3.1. Researching a Deleuzian Assemblage

The conceptual moves made in the previous chapter have significant implications for the study of financial stability and the central bank. Firstly, not only does performativity cover the technical discipline of economics and the performance of economic discourses and practices, but also involves phenomena traditionally bracketed out as ‘misfires’ or ‘overflowings’ (Callon 2010). Further, performativity includes creative and speculative actions and statements about performatives which have dramatic- if not performative- force.

Secondly, the central bank is not the absolute unit of study, as is the case with Graham Smart’s study of the Bank of Canada (2006), for instance. Rather than undertaking some sort of actor-network, ethnographic microanalysis within the Bank, this Deleuzian cultural economy interrogates the wider arrangements in which the Bank, and elements within the bank, are implicated. The relational and assemblage approach is needed, because it focuses on financial stability techniques in which the enuciative and the machinic coalesce. A Deleuzian cultural economy is able to study the financial stability assemblage precisely because its Deleuzian reading of the assemblage is able to negotiate the ‘somewhat stifling debate in the (International Relations) literature’, namely the ‘discourse- praxis divide or real-ideal divide’ (de Goede 2012: 31). In such a way Deleuze and Guattari tell us in *A Thousand Plateaus* that (1987:98):

‘An assemblage comprises two segments, one of content (real), the other of expression (ideal). On the one hand it is a *machinic assemblage* of bodies, of actions and passions, an intermingling of bodies reacting one another; on the other hand it is a *collective assemblage of enunciation*, of acts and statements.’

The ‘collective assemblage of enunciation’ refers to statements which are ‘not tied to a personal subjectivity, but emerges from social assemblages, and technical apparatuses’ (Young 2013:70). Such statements are ‘impersonal but attributable to collectivities’ (Young 2013: 70). And this corresponds to the way that the Financial Stability Reports are at first a collection of articles by authors, but eventually develop so that they become depersonalized, with no single person named as author of the Report. So, for Deleuze and Guattari, the ‘the court-machine’ may well consist of ‘its own intermingled pieces, gears, processes, and bodies contained in one another or bursting out of containment’, but in addition to this is ‘the regime of signs or of enunciation; each regime with

its incorporeal transformations, acts, death sentences and judgements, proceedings, law' (Deleuze and Guattari 1987:98).

Deleuze and Guattari are clear that this is not a case of 'representation or imitation of the machinic assemblage', because 'the stoker's discourse does not describe stoking as a body; it has its own form, and a development without resemblance. Yet it is attributed to bodies, to the whole ship as a body' (Deleuze and Guattari 1987: 98). In such a way, discourse is attributed to the central bank-machine. More than this however, the depersonalized statements of the central bank collective do not simply represent an assemblage. They can be used to trace the financial stability assemblage, but they also allow us to answer the wider question of what is the discrete notion of financial stability that is being worked upon by each significant part of the financial stability assemblage. This Deleuzian 'two segment' conceptualisation of the assemblage means that the assemblage is open to an analysis of the collective assemblage of enunciation. The way I have undertaken this analysis has been to construct a financial stability archive, using a range of publicly available texts and materials from the Bank of England's website. This diverges from conventional methodological approaches in the social studies of finance or economic sociology, which tend to utilise ethnography and interviews. The Bank of England was not prepared to allow me to conduct this sort of research. In many ways, this is in keeping with a trend I have noticed in central banking of 'managed transparency.'²⁹ In light of this, it is not clear to me that Bank Staff would have contradicted official communications and public documents. Further, making an archive of public communications documents does allow me to consider the approach I have taken as close to an ethnography of public communications as I possibly could.

3.2. Archival Research

'Archives matter. What is included shapes forever what we think we were and hence what we might become' (Pollock 2007: 12).

²⁹'Managed transparency' involves openness about a carefully constructed and cultivated message. For example, the selective and pre-emptive screening of questions from members of the public I observed at a public engagement event- the Bank of England Open Forum. This could not be included in the thesis as this was the first event of this kind put on by the Bank and it occurred after submission of the thesis. Interestingly, and related, I have found that people within finance and the regulatory community have been much more forthcoming to me since I have become a post-doctoral researcher. This could be a reflection of a new found knowledge-based status or membership of an epistemic community (Chwieroth 2009),

Archives have traditionally been conceived as an ‘inert depository’ in which the past is stored, by means of documents and texts. However, as Griselda Pollock argues in the above quotation, archives are ‘pre-selected in ways that reflect what each culture considered worth storing and remembering’ (Pollock 2007:12). And, indeed, there is no single readymade and inert financial stability archive at the Bank of England. In Derrida’s conceptualisation of the archive, the process of archiving is driven by conflicting desires, between destruction and preservation or a violent amalgamation he dubs ‘*archive fever*’ (Derrida and Prenowitz 1995: 14). In other words, archival research is not a way discovering an ‘objective reality’ that exists ‘out there’ independently in the archive. Instead, archival research works through an active process of ‘condensing particular patterns and repetitions whilst ignoring others’ (Law 2004: 113). In John Law’s terminology archival research becomes seen as a process of ‘method assemblage.’ This archive was an assemblage both in terms of form- of the fitting together of many fragments- and content (the financial stability assemblage).

3.3. Assembling an Archive

For Derrida, ‘archivization’ - library and archival technology-shapes the nature of the knowledge that can be produced’ (Manoff 2004:12). As mentioned previously, there is no single and pre-established financial stability archive. The technology I had at my disposal for creating a specific ‘financial stability archive’ were the Bank of England website, and a desk-top Personal Computer with internet access and printing resources. Because the documents are all publically available and all in one place, this removed access issues and saved considerable time in terms of physical data collection and transcription that many PhD students have to factor into their research design. However, it must be remembered that there was no ready- made financial stability archive as such. I faced over 2000 stored documents on this online resource over a period covering 1996-2015 (See Figure 2).

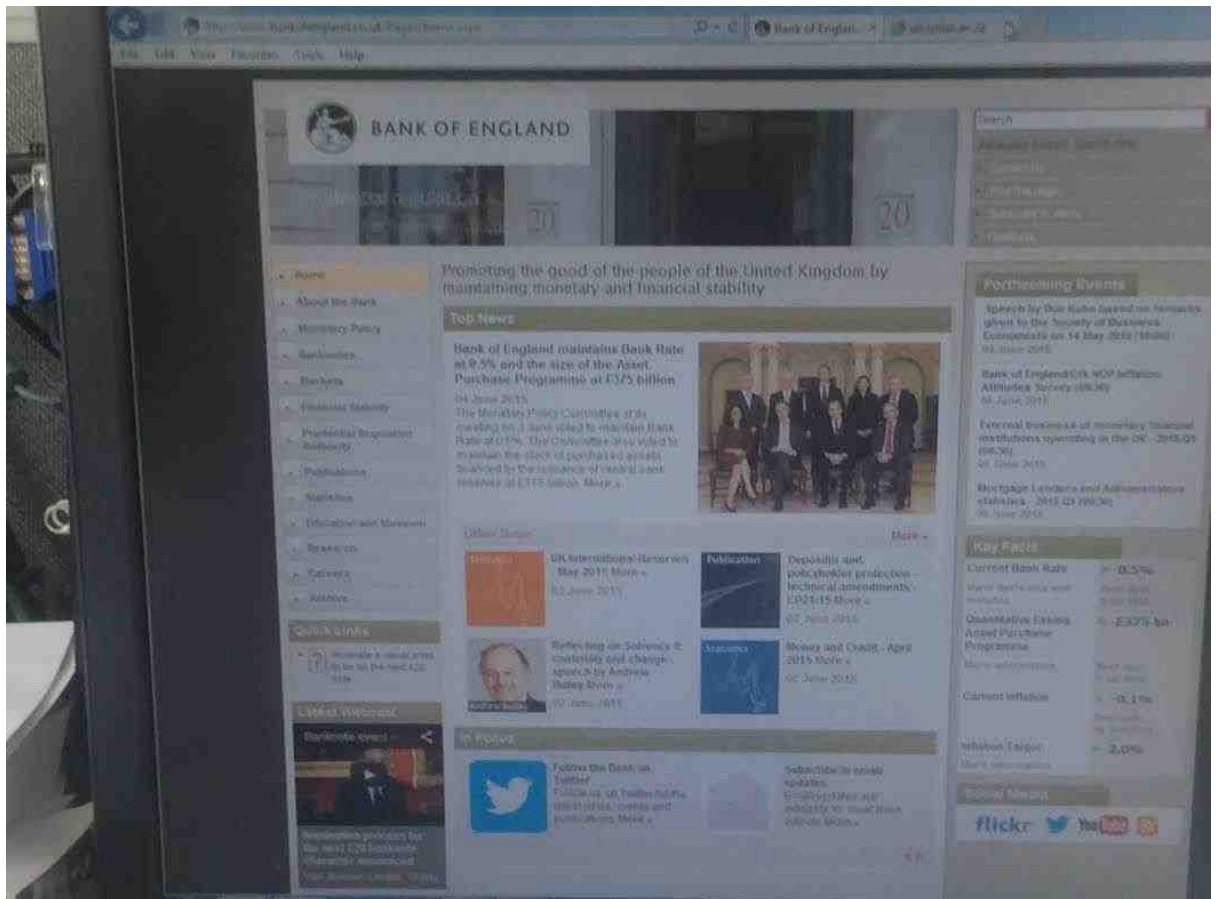

Figure 2– Coming to the Archive

The first task then, was selecting documents of interest for analysis- these were documents referring to finance, the financial sector and financial stability. Financial Stability Reviews and Reports are to be found in their own section under ‘Publications’.³⁰ From publications one can also find ‘Speeches’ and ‘News Releases.’ Within ‘Speeches’ are speeches and articles from 2012-2015. Earlier speeches and articles have to be accessed through the ‘Archive Section’ on the tool bar.³¹ Stress testing has its own mini archive under the heading of ‘Financial Policy Committee’.

So while FSRs are quite straightforward to locate, speeches and articles referring to finance require further work to find items of interest and to screen out those that do not speak to my concerns. Speeches and articles are listed in terms of date, titles and speaker/author.

³⁰ This can be found at <http://www.bankofengland.co.uk/publications/Pages/fsr/default.aspx>

³¹ See <http://www.bankofengland.co.uk/archive/Pages/digitalcontent/historicpubs/publications.aspx>

I employed several techniques for selecting articles, which was effectively a way of coding³² the articles as being ‘of interest’. On some occasions, a title such as ‘Enhancing Financial Stability: the role of transparency’ (Kohn Speech 2011a) -gives a clear indication that finance is the subject of the speech or article. Likewise, a title such as ‘The UK Productivity Puzzle; A Sectoral Perspective’ (McCafferty Speech 2014c), demarcates that the speech is clearly not about finance. Alternatively, this kind of screening for content can also be done using speakers and authors- Members of the FPC, such as Andrew Haldane, Andrew Bailey and Paul Tucker are all Bank staff who comment on the financial sector. For example, while Haldane’s ‘well-known’ ‘Dog and the Frisbee’ speech (Haldane Speech 2012g)³³ has an ambiguous title, the fact that it is a speech by a man who has been the Chief Economist and Executive Director of Financial Stability makes this a document of interest. This can be contrast to a speech by someone such as David Blanchflower, whose area of expertise is labour economics. Sometimes a title may not explicitly contain the phrase finance, but may include a ‘trigger word’ which signifies themes associated with finance, such as ‘Shining a light in the Shadows’ (Hauser Speech 2012a) – a reference to ‘Shadow Banking.’ Here some financial literacy or basic knowledge of terms used in newspapers such as the *Financial Times* is needed. If a speech is made at a particular event, such as the Mansion House Bankers and Merchant’s Dinner, it can also become an item of interest, if it is plausible that the Speaker will be addressing an audience that has an interest in finance. This process involved a high degree of researcher judgement, historical knowledge of the Bank of England and its Committees and financial literacy that cannot be incorporated into the research process using analytical software such as NVivo. I am a longstanding reader of both the *Financial Times* and *The Economist* magazine and have been studying financial governance since 2008. Even when these procedures were put in place, the archive consists of some 800 documents, which includes speeches, transcripts, publications, reports and videos. Because the documents were all publicly available documents released under the auspices of the Bank of England, the fragments were initially treated as having a uniform status and being directly comparable to each other.

³² My reluctance to use the term ‘coding’ results from the association between coding and a positivist content analysis in which we can make inferences from the number of occurrences of a phenomena in a text.

³³ This speech can be found at

<http://www.bankofengland.co.uk/archive/Documents/historicpubs/speeches/2012/speech596.pdf>

3.4 Archive as Discourse?

This initial focus on depersonalized statements does not serve to discount other statements attributable to Bank Staff such as the Governor. To push further at this relation between ‘real and ideal’ worlds I draw on a recent article by Cynthia Hardy and Robyn Thomas (2015) who argue that a preoccupation with discourse does not preclude materiality because discourses form and function ‘at the interface of linguistic and material worlds’ (Hardy and Thomas 2015). The second segment of the financial stability assemblage, that of machinic assemblages, can be analysed using textual analysis techniques because Hardy and Thomas give us an instructive account of discourse that intersects with bodies, objects and practices. In particular, the way that linguistic and material divisions collapse in the form of practices, can be applied to the financial stability techniques that I am tracing through my archive.

Firstly, when we consider Foucault’s genealogical writings, what separates these works from a history of ideas is that genealogy fixes on the inscription of political power/discourse on the body. A ‘subject function’, such as ‘femininity’ is fixed or normalized on the body, and it is this which supports the emergence of the individual ‘about which one can speak, hold discourses and attempt to found sciences’ (Foucault 2006, p.56 cf. Hardy and Thomas 2015:3). Discourse then fix onto bodies that are present within the assemblage.

Second, the relationship between objects and discourse is such that objects do not ‘pre-exist as objects in some way that is revealed by the discourse’ (Carter et al 2008: 92 cf. Hardy and Thomas 2015). Instead there is a much more complex process through which ‘some concepts are discursively attached to particular parts of an ambiguous material world; a world that has an ontological status and a physical existence apart from our experience of them’ (Phillips and Hardy 1999:3). Carter *et al* (2008 phrase this nicely when they make the case that ‘an object we assume to observe is a reaction’ - a result of an assemblage of practices’ - is an objectification of the processes we observe (Carter *et al* 2008: 92). Discourses then can be related back to the machinic worlds (of objects) of the first segment of the assemblage Deleuze and Guattari give us in *A Thousand Plateaus* (1987: 97-99).

Finally, and crucially for my focus on techniques, Hardy and Thomas argue that it is through practice that ‘linguistic and material divisions collapse into each other’ (Hardy and Thomas 2015:9). Not only is a diagnosis of clinical depression ‘a discursive utterance’ but it further emerges:

‘from an array of (material) practices that allow the diagnosis to be made in first place... such as procedure, medications, treatments and examinations ... to fixate on the discursive at the expense of the material grants too great a weight to language without recognizing the material arrangements in which power is enmeshed and extended’ (Hardy and Thomas 2015:10).

So, in taking this approach to the real-ideal divide, we have a conception of discourse and materiality in which the body is the very condition of (financial) subjectivity, in which some (financial) concepts are discursively attached to objects and in which the material and discursive collapse into each other through (financial) practices. The cultural economy account that I have set up in Chapter Two then, in both the account of central bank as a Deleuzian assemblage and a wider and layered account of performativity, allows us to talk about both ‘real’ and ‘ideal’ aspects of the assemblage through the way that discourses form and function ‘at the interface of linguistic and material worlds’ (Hardy and Thomas 2015:2).

3.5. Undertaking Textual Analysis

Developing my methodology for textual analysis involved making three fundamental decisions. The first was to decide what the role of documents was to be in the study. Secondly, I had to decide what questions I would ask of the texts. Thirdly I had to decide upon an analytic procedure for reading and analysing the texts. I detail these decisions and procedures in the following sections.

3.5.1 The role of documents in the study

Existing studies of central banks use documents in a variety of ways. For Graham Smart (2006), the documents are the centrepiece of all the writing and genre activities by central bank staff, but his main analysis lies in extremely rich interview data that he has collected from ethnographic research. These interviews, then, are Smart’s main object of analysis. As a reflection of this, a few examples of the documents themselves are presented in appendices at the back of the book. For Smart, the main focus is the story behind the documents, rather than the documents themselves. Therefore, this was the existing study least like mine.

Rodney Bruce Hall (2008) weaves in documents, in terms of central bank speeches, into a social account of money and monetary institutions. This again has some similarities with my approach, in

terms of the assembling of fragments into a rich theoretical account of economic activities. However, and perhaps as a consequence of his social constructivism, he treats such speeches as discourse or ideas and contrasts this to the materiality of money. In contrast to my study, Hall downplays the visuality of the documents he is working with.

Douglas Holmes (2014) is interested in the ‘drafting of technical reports, writing speeches, crafting presentations, compiling briefing documents and composing of policy statements’ (Holmes 2014:5). Holmes then is preoccupied with the writing process, and the constructive use of monetary performativity to influence the economy. Like Smart, Holmes draws on interview data, but Holmes also includes, ‘as often as possible’ documents or excerpts ‘for readers to appraise and interpret for themselves’ (Holmes 2014:5). While in Chapter Four I do look at the Financial Stability Reports, specifically, my later work on the creation of the documents focused on the way in which Bank reports are not being transparent, but instead are trying to reassure and support confidence in the financial system. And if Holmes is tracing a technique, it is the forward guidance of inflationary expectations, rather than the assemblage of different financial stability techniques, both inside and outside of the central bank, that is the focus in this thesis.

3.5.2 Asking Questions of Documents and Texts

I was using the documents to answer four broad questions. The first question emerged as an important theme from the second reading of the texts, and became a way with which to organise the thesis, namely what have been the financial techniques used to govern through financial stability? These techniques emerged through looking at the way the Bank for England website was organised, and by seeing recurring patterns through which financial stability reports were organised and recurrently discussed certain elements. Here I initially identified credit derivatives, Value-at-Risk and confidence as three recurring techniques. In such a way, this would help to identify the object of study through the techniques that act on it.

The second broad question I was investigating is intimately related to the first- how have financial stability techniques developed over time? This was best achieved by making the conscious decision to order the fragments that were developed from the first reading into chronological order for each technique. Through this process I follow changes within a technique (VaR) and the subsequent improvisation of stress testing built up on top of that initial technique. Likewise the shift towards the mediation and performed nature of financial stability through press conferences is an important development picked up by this chronological ordering. Further, reading documents chronologically

drew my attention to changes in the format of the Financial Stability Reports over time, which tells us something about the trajectory of the financial stability agenda (See Chapter Four).

The third broad question relates to how the financial stability techniques used were justified and what were the logics and legitimizations driving the adoption of these techniques? So to use the credit derivatives as an example, the security logic becomes a clear theme when examining the Banks's early thoughts on their development and emergence, with the promise of market completion.

The fourth and final question that was asked of the documents was how does each technique act on financial stability? This aimed to learn as much about the Bank of England's position on financial stability as it did the financial stability technique. I was particularly interested in seeing if there was consistency across statements about techniques.

3.5.3 Developing an Analytical Procedure

The first technique that I was tracing, credit derivatives, was to serve as a pilot run for analysing financial stability documents and it is out of this particular technique and chapter that a more systematic analytical process was developed. I printed out the documents and, in chronological order, read them line by line and drew comparisons between texts. I physically marked my notes and highlighting onto the documents. The main strength of this process was that it was engaging with the materiality of the texts as physical documents. The main issues I found with this initial procedure was that it required me to go back and type up fully the fragments I wanted to integrate into my narrative. Further, it was arduous to compare texts in this initial procedure.

Once fully developed, the analytic process for documents consisted of three stages (see Table 1). The first stage involved reading whole documents line by line. This could be extremely time consuming because the documents varied between as many as over a hundred pages to as few as one. Reading documents in their entirety is important because to prevents a researcher from taking small units out of context. Fragments that appeared highly relevant to financial stability and the techniques I was investigating were pulled out from the larger documents. This part of the process involved creating computer 'word documents' of between ten and sixty pages. Within these documents were the fragments that would then be used to develop an analysis. These fragments were placed in chronological order.

A second stage of reading was used to develop themes and make comments on the fragments generated by the first stage of reading. These themes were used to draw links between a variety of documents. Primarily, I was tracing the Bank of England's understanding of techniques of financial risk management and economic governance. I was interested in how understandings of these techniques changed over time, and how these techniques were legitimated. A further area that developed through chronological ordering of documents was that the format and design of the Financial Stability Reports changed significantly over time. These are essentially interpretative questions which also relied on some measure of financial literacy and so needed to be carried out by a (human) researcher.

This was also creative stage, which opened up a dialogue with a broad range of social theory to interpret what is being said. This helped to generate concepts such as security logics embedded in credit derivatives, the concept of improvisation in press conferences and the idea that 'the possible' is an umbrella term for both plausible and hypothetical, which have distinct approaches to reasoning. These concepts inductively generated from the data were consistently highlighted in red. This 'grounded theory' helped me to remember ideas that seemed important and helped me to develop ideas systematically (Crang 2003:130). It was also a stage in which close comparisons were made between different fragments and some details are exaggerated in order to develop theory. This latter process led me to ask what features of additional texts did or did not fit with the analytic frameworks being developed and helped me to modify the analysis (to include lines or moments of escape, moments of recapture and also ambiguity in meaning where documents contradict each other). It was important to keep these fragments in chronological order so that each technique that was being traced could be done so in a logical and coherent manner.

The third stage of reading involved returning to the fragments and highlighting pertinent sections that exemplified the conceptual arguments that I wanted to make. These sections were highlighted in yellow. Not all these sections did make it into the final edit of the thesis.

Table 1- Final Procedure for Analysis

Stage of Analysis	Unit/s of Analysis	Research Tasks
First Read	Whole Document	Pulling out fragments of relevant text and place in chronological order.
Second Read	Fragments	Making comments and pulling out themes (in red)
Third Read	Fragments	Highlighting for use in article or thesis (in yellow)

3.5.4 Video analysis of Financial Stability Press Conferences

Although they are not documented reports per se, the videos of financial stability press conferences *are* an important part of the archived financial stability press conferences because they are stored within the financial stability report section of the Bank of England website and are always presented before the report itself. The reason that these videos became a significant area of research was because they speak to debates about the performativity of central banks and the emphasis on communication and media in the central banking literature (Smart 2006; Holmes 2006; Holmes 2009, 2014; Velthuis 2015). In other words there are stutters and stammers, speculative and creative acts and statements that are dramatically forceful.

Video analysis involved first producing and making notes on a printed transcript of the press conference, before watching the video footage of the conference with the printed and marked transcript alongside. It was then possible to assess the plausibility of the analysis of the transcripts, as well as having some important focal points with which to structure viewing the video. The aim of this was to treat the video as a text. This effectively means asking the same questions of the video footage as one would of documents, although representation becomes even more significant. In addition to this, in order to ascertain that the manner of performing various actions, as opposed to the linguistic content alone, viewing the video was also important.

Table 2 – Procedure for Video Analysis

Stage of Analysis	Unit of Analysis	Research Task
First Read	Whole Transcript of press Conference	Making comments and pulling out themes (in red)
Video/Re-read	Whole recording of press conference	Comparing video footage to initial notes on transcript of press conference
Additional Comments	Whole transcript of press conference	Write additional notes on the document and highlight useful text to be presented in thesis (in yellow)

3.6 A Methodological Note.

When taught research methods at university, students of philosophy of social science are almost always introduced to a distinction between three general accounts of reasoning in relation to the analysis of research data. These are deduction, induction and abduction (Hacking 1999:197). Deductive reasoning makes inferences from premises to draw conclusions. For example, ‘if A is greater than B and B is greater than C, then A is greater than C. In philosophical terms, the truth of the conclusion is guaranteed because true premises lead to a true conclusion (Popper 1935).

Alternatively, inductive reasoning takes evidence from specific cases to support a general rule (Carnap 1952). A classical philosophical example is to infer that from every observable case of swans, that all have been white, that all future swans will also be white. The apparent weakness with this is that no number of past observations is able to conclusively ‘prove’ a theory and guarantee a particular future observation (Russell 1912). In Taleb’s (2008) terms, the next swan I see may well be black.

A third category of reasoning is abductive- here we are interested in the likeliest possible explanation from an incomplete number of observations. An example of this would be the verdict of a jury, which is the most likely explanation given the set of evidence that has been presented. Abductive reasoning is considered to be more intuitive or creative. The truth of the inference is therefore not guaranteed because there may well be further evidence that was not presented that rules out the verdict (Peirce 1901).

The 'grounded theory method' (Glaser and Strauss 1967) that I have worked with on this project, developing theory as data is collected, is, as Mike Crang argues, 'somewhere between abduction and deduction' (Crang 2003: 132). Theory is developed from data and this theory is used to guide further data collection. The issue raised by this is that for those who follow inductive reasoning, grounded theory has a tendency to force ideas on data. For this particular project, this is not a huge difficulty because my grounded theory process returns to the text fragments after an initial theory has already been developed, in order to re-define the theory to fit the data better. So for example, the need for an extension of the concept of performativity was underscored by the stutters and stammers of press conference footage, and in developing this category by reading Thrift and Dewsbury's (2000) account of lively practices, I discovered a more dramatic series of statements *about* other performative utterances. While this did not exactly fit with the Deleuzian account of Thrift and Dewsbury, I have developed this further category by reading Eve Kosofsky Sedgwick's work on 'peri-performatives' (2003) and fed this back into the chapter on VaR and discursive shifts during the writing up of this chapter. In such a way, the seemingly abductive approach to developing theory out of research materials has in fact also been put into practice through developing the three overarching conceptual categories outlined in Chapter Two. The grounded theory method led me to extend the account of the financial stability assemblage on several occasions, when it became clear that stress testing is a technique in itself, and that press conferences needed to be attended to.

3.7. Conclusion

In this methodology chapter I have outlined the way in which I have used a set of texts to study and assemblage of techniques and material practices. This Deleuzian cultural economy interrogates the wider arrangements and techniques in which the Bank, and elements within the bank, are implicated. By focusing on financial stability techniques in which the enunciative and the machinic coalesce, this

approach is able to negotiate the real-ideal divide in much political economy inflected work. Also following on from the conceptual moves made in Chapter Two, the extension of performativity allows a much wider range of statements and documents to be analysed. For example, creative and speculative statements as well as phenomena traditionally bracketed out as ‘misfires’ or ‘overflowings’ (Callon 2010).

The chapter has then gone onto elucidate the way in which I compiled an archive from an unstructured collection of resources on the Bank of England website. What Derrida has called the process of ‘archivization’ (Derrida and Prenowitz 1994:14), involved sifting through documents looking for indicators that the source was discussing financial stability. As such, indicators included titles referring to finance, names of authors and speakers responsible for financial stability issues and trigger words using phrases and metaphors associated with finance.

I then made the important move of questioning the critical presupposing that an archive is merely a depository of discourse. Drawing on Hardy and Thomas (2015), I made the case that in practices (or techniques) material and linguistic divisions collapse into each other.

Later the chapter highlighted the role of documents in this study when compared to author authors on central banking, such as Smart (2006), Hall (2008) and Holmes (2014). Four key questions were asked of the archive within this study:

I was asking of the archive:

- (i) What have been the financial techniques used to govern through financial stability?
- (ii) How have financial stability techniques developed over time?
- (iii) How the financial stability techniques used were justified and what were the logics and legitimizations driving the adoption of these techniques?
- (iv) How does each technique act on financial stability?

The chapter details the analytical procedure that was developed in order to trace financial stability techniques. The first stage involved reading whole documents line by line. This was followed by a re-reading to develop themes and make comments on the fragments generated by the first stage of reading. Finally the third stage of reading involved returning to the fragments and highlighting

pertinent sections that exemplified the conceptual arguments that I wanted to make. In the remainder of the chapter I have set out a justification for extending the archive to include video footage and transcripts of financial stability press conferences, before outlining the grounded theory (Glaser and Strauss 1967) and abductive nature of this study. Having set the methodology in place, the thesis now moves to a more empirical phase. Here then are chapters documenting what the Bank of England has said about and through a variety of financial stability techniques, namely the FSRs, press conferences, credit derivatives, Value at Risk, stress testing and confidence,

Chapter Four: Financial Stability Reports and Press Conference Performances.

4.1 Introduction

As I noted in Chapter Two, ‘financial stability’ may now be an extensively used term but, importantly, it is also elusive and ambiguous. The Bank of England has been producing a large volume of financial stability documents since just before its operational independence from the Treasury. The first financial stability report in 1996 features an editorial from Sir Eddie George and Andrew Large in which it is argued that financial risk management has changed significantly since the days of Walter Bagehot so that:

‘Taking and managing financial risk is the very essence of the business of banks and securities firms alike. It is their contribution to society. So it is more important than ever for practitioners and regulators to keep abreast of the latest developments’ (FSR 1996:2).

Financial Stability Reviews/ Reports (FSRs) appear twice a year and aim to highlight ‘developments affecting the stability of the financial system, and promote the latest thinking on risk, regulation and market institutions’ (FSR 1996:2). The Bank has produced the report in partnership with another organization. Initially this was ‘with the Securities and Investments Board and then, from 1998, with the Financial Services Authority.’ Significantly the name was changed in 2006, to the *Financial Stability Report* in order ‘to reflect a change in content and aims’ (Bank of England). While the Bank is not explicit about the technicalities of this change, what can be discerned from the 2006- May 2008 FSRs is that there is a move away from articles that can be attributed to individuals about a range of financial system topics and a greater focus on ‘shocks, structure, prospects and mitigating risks’ in relation to the UK financial system (FSR 2006a). Then, from October 2008- December 2009, the FSRs become preoccupied with the Global Financial Crisis and exhibit several changes throughout this period. Here there is a real sense that the Bank is reacting to events as they happen, and is attempting to intervene. From June 2010, the Bank reverts closer and more consistently to the Financial Stability Report form introduced in 2006.

The Bank of England has been releasing financial stability reports through press conferences since 2011, and transcripts, webcasts and podcasts of these press conferences are readily available on the

Bank of England's website. Since 2014 these press conferences have become increasingly important because the results of the 2014 and 2015 editions of these stress tests have been released as part of financial stability press conferences.

The purpose of this chapter is to begin to set the trajectory of analysis of the emergence and consolidation of a number of discrete techniques for achieving financial stability. In such a way, the chapter makes three steps that are consistent with the readings of performativity and assemblage set out in Chapter Two. As highlighted there, a broader conceptualisation of assemblage, as sketched out by Deleuze and Guattari in *A Thousand Plateaus*, seemingly conceptualises performativity as an instance of assemblage.

First, the chapter begins by attempting to theorize what FSRs are by using literature on the performativity of the economy. It is argued that more than just being discourse, FSRs have a visuality that which helps bring into being financial stability as a problem-object of government and amenable to reterritorialization. It is further suggested that the changing visuality over a ten year period serves to shift the intended audience of the reports towards professional investor audiences. The second section argues that FSRs are part of an assemblage of distributed agency. This means that rather than acting alone on financial stability, they tend to describe many other techniques and practices- such as stress testing- in such a way as to consolidate them together and assess their present status as a means for providing financial stability. The case of stress testing is highlighted as an instructive example of this. So, not only do FSRs form part of the assemblage by conveying the results of the stress tests, but they also refer to the other composite parts of both stress testing and other assemblages, such as Value-at-Risk, credit derivatives and confidence.

The third section of this chapter asks how to understand the place of the FSR, and its release in distributed actions and in performative terms, as much more than the account currently *en vogue* in sociological writings on finance. While section two provides an account of performativity closest to the *agencement* approach broadly favoured by scholars who identify with the social studies of finance, in this third section the argument is that central banking also depends on the reiterative practices which imbue the Bank with meaning and authority. However, rather than concluding that central bankers are merely the embodiment of established contexts of institutional authority, I present the argument that utterances can gain force through breaking with prior conventions. I go onto characterise such actions as 'lively practices.' In this section, I analyse video footage and transcripts of all Financial Stability Report press conferences to the present date. Like Douglas Holmes, I argue that performativity is a salient analytical framework to conceptualise the press conference, but

go further to argue that more conceptual reconfiguration is needed. Here I am interested in two versions of rupture, those provided by Jacques Derrida (1972) and Gilles Deleuze (1990). The communicative ruptures that Derrida brings to our attention have the potential to disrupt seemingly regimented conventions. Secondly however, I transpose Deleuzian ideas from Thrift and Dewsbury (2000) to look at 'risky, creative and experimental' actions which underpin difference. Again such actions disrupt the repetition of established discursive operations.

4.1. What are FSRS?

As outlined in the introduction, the Bank of England has been producing financial stability reports since 1996. The existing cultural economy literature provides three distinct vantage points from which to consider the content and significance of FSRS; namely data and tools, discourse and visuality.

Firstly, discourse is important. Rather prosaically, the discursive and political labour that has gone into carving out global finance as a 'discrete and bounded space', often beyond political contestation and domestic regulation, means that representation becomes vitally important in understanding every day and mundane encounters with the financial system (Langley 2005:89). In the case of the mainstream media this provides a traction point for discursive heuristics, analogies and metaphors, such as 'liquidity', 'hot money' or 'toxic assets' (McCloskey 1983; Thompson 1998; Brassett and Clarke 2012).

Second, the literature orients us towards data, tools and the metaphor of the 'engine'. When it comes to models and data, purportedly descriptive 'measurement tools ...do not merely record a reality independent of themselves; they contribute powerfully to shaping...the reality that they measure' (Callon 1998: 23 cf. de Goede 2005: 118). In other words, and from the vantage point of the growing interdisciplinary field of the social studies of finance, the data and statistics purportedly used to record in the manner of a camera, is actually more akin to the active driving force of an engine (Mackenzie 2006:12).

Third and finally, authors such as Rob Aitken (2007) have moved beyond a focus on the performativity of economic models and algorithms (Mackenzie 2001, 2003; Mackenzie and Millo 2003) to argue that in rather different historical and more 'popular' contexts, 'visuality is a set of practices central to the making of economic spaces and key to our assessments of those spaces'

(Aitken 2007:22). To focus on an extended and illustrative quotation from Michael Pryke's (2010) illuminating work on 'money's eyes' (435):

'Graphs, figures, even tables should not be seen as: 'primarily 'representational' in the sense of their ability to communicate something, but rather as primarily signficatory. They always signify but need not necessarily represent (something else). This is an important distinction. It enables us to approach visualisation (in its multifarious forms) as *constitutive of a reality rather than as a mere reflection of it* (however accurate or distorted). And this pertains to all forms of visualisation. Thus from this perspective intelligibility, knowledge or sense are the effects of the form of visualisation...not the conditions of their possibility or existence (Thompson 1998, p.286, emphasis added' cf. Pryke 2010: 435).

Seen in this way, financial stability reports are not just statements or discourses but have a visuality that contributes to bringing financial stability into being as a concern for financial governance. The example that I will go onto introduce is the way that visually these documents become more scientific and technical. If, for Marieke de Goede, the Dow Jones Industrial Average 'performs this history of the financial markets' in the United States, then, by analogy, the Financial Stability Report unifies and consolidates what the UK financial system looks like , and consists of, during a 6 month snapshot. This is because 'financial indices create the financial market as a unified, observable and measurable phenomenon' (de Goede 2005: 118).

When understood in these terms, a concerted shift towards the mathematization of economics can be seen through the evolution of the financial stability report. At the beginning of the reports' life cycle, sketches, illustrations and photographs made the world of the City of London somewhat more tangible and 'real' (Figure 3). Importantly though, these early visual effects are non-technical and non-calculative. In some ways, they constitute as almost promotion and vindication, rather than surveillance, of the people and institutions in the City of London.

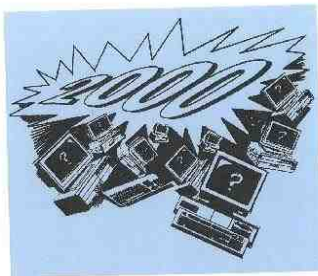

The bank supervision plan to conduct reviews of all banking institutions by the middle of 1998 in order to identify areas that are potentially vulnerable.

Other US financial market regulators are also devoting substantial resources to addressing Year 2000 issues. For example, the US Securities and Exchange Commission (SEC) has provided specific guidance to public companies regarding their obligations to disclose information about the anticipated costs, problems, and uncertainties associated with the Year 2000 issue.

The Federal Reserve is also pursuing a comprehensive strategy to achieve and test the Year 2000 readiness of Fedwire, the electronic large-value transfer system for funds and securities that it manages and

operates. It is also developing a contingency plan which includes:

- alternate plans to address the usability of businesses to resist Year 2000 readiness schedules;
- business (contingency) plans to address any unexpected material problems with the century date change; and
- system contingency plans to address problems experienced by customers at the date change.

The New York Clearing House has established several committees and task forces to deal with Year 2000 issues. The Clearing House members have been working with the US national group of SWIFT users to establish common test cases across three funds transfer facilities (CHIPS, SWIFT and Fedwire). These common test dates will enable

depository institutions to simultaneously test their systems' interaction with the three services, and with other depository institutions worldwide. In addition to weekly testing, 26 September 1998 has been scheduled for co-ordinated testing, and additional test dates are planned for November 1998 and in 1999.

US securities markets

The US Securities Industry Association (SIA) has established various committees of members to manage its programme, including the question of industry-wide testing.

This industry-wide (or 'street-wide') Year 2000 testing aims to provide an opportunity for all firms in the US securities industry to jointly test their applications and interfaces with each other, as well as with the relevant exchanges and payment and settlement utilities.

The industry-wide testing committee, together with the other relevant parties, is currently identifying a set of minimally acceptable testing requirements. The tests will involve a complete trade cycle for equities, options, corporate and municipal bonds, unit investment trusts and mutual funds. About 300 individual securities firms, and between 30-40 exchanges, are expected to take part in this series of tests.

Industry-wide issues

Benchmarking, certification and standards

A common problem has been to know how much weight can be put



total of all domestic public sector debt outstanding.

A further way of addressing credit risk in OTC derivatives is through provisions to close-out particular contracts after a certain period or, in some cases, once their mark-to-market value reaches a pre-specified level.

On organized exchanges such as LIFFE at the end of each working day the exchange's clearing house becomes the central counterparty. In the two exchange members that have bought or sold derivatives contracts. Thus, the clearing members (broadly the firms at the centre of derivatives markets) do not take credit risk on each other, but on the clearing house. Clearing houses

manage the risks which they assume as central counterparty by asking for initial margin when contracts are taken out, and by daily flows of margin between the clearing house and members as contracts values change.

Table 4 shows that daily money movements to the London Clearing House can be substantial. During the 1987 equity market crash, smooth flows of money to US derivative clearing houses were threatened, not because significant members of member firms had become insolvent, but because of general uncertainty about the solvency of many firms. For a brief period this reduced the commercial banks' willingness to provide the necessary liquidity.

Figure 3: Early Financial Stability Reports

In 2001, graphic representations of data becomes the norm for FSRs. Fligstein suggests that such an emphasis represents a focus on a more consciously scientific approach to governance. This is because 'ultimately, science rests on evidence'. But more than this, science needs to have ways to control people in order that they do not 'fudge evidence either intentionally or unintentionally, and quantification is one way to do this' (Fligstein 1998:326).

Moving forward five years later and to 2006, the reports are even more data and statistic heavy. We have a sense of what the financial sector looks like, in terms of its composite parts and outputs (Figure 4). Again, pushing further than this, is the sense that the financial system can be quantified and governed. The transformation in the reports is one of a move towards technical expertise. The graphs 'render aspects of existence thinkable...calculable and amenable to deliberated and planful initiatives' (Miller and Rose 1990:3 cf. de Goede 2005: 118). For Miller and Rose, such scientific visualities are to be understood as '*intellectual technologies* that render aspects of existence amenable to inscription and calculation' (Miller and Rose 1990:1).

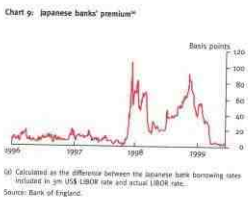
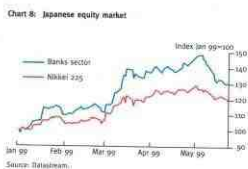
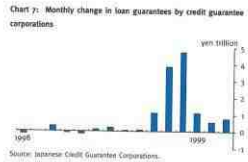
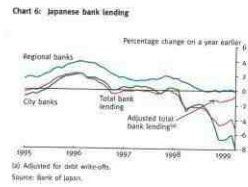

In the year to 31 March 1999, Japanese banks reported a 23 per cent fall in aggregate operating profits to ¥2.5 trillion. This included a ¥10 trillion provision for bad and doubtful debts. They are likely to face new non-performing loans as a result of the recession being deeper and more drawn out than expected. But they should now be in a better position to bear those losses, following steps taken by the Japanese authorities over the past year to recapitalize the banks and avoid a banking collapse. On 9 March, fifteen major Japanese banks submitted applications to the Financial Revitalisation Committee for public funds totalling ¥745 trillion (about £38 billion), 1.5 per cent of GDP⁵⁶. All retail deposits of internationally active banks are guaranteed by the Deposit Insurance Corporation until 1 March 2000. That has been judged necessary given the financial fragility in Japan, but looking beyond the eventual resolution of the current problems, it could increase moral hazard. The banks have agreed to an unprecedented degree of structural reform, including closing branches, cutting staff, withdrawing from many overseas operations and pursuing proposals for mergers (eg as announced by Daiwa Bank and Bank of Osaka in mid-February).

The capital position of the banks will also have been helped since last autumn by the rise in the Nikkei and by the recovery in government bond prices prompted by the Ministry of Finance indication in mid-February that the official Trust Fund Bureau would resume purchases.

Bank shares themselves have out-performed the rest of the market: the TOPIX bank index rose by 9.5 per cent more than the Nikkei 225 between 1 January and 28 May 1999 (Chart 8). And the premium that Japanese banks have had to pay to borrow in the London market appears to have declined significantly, although that may largely reflect the absence of the weaker banks from the market (Chart 9).

Overall, the uncertainties remain significant, given the Japanese economy's structural difficulties, including the large current and prospective government deficit. While the authorities' actions have averted a spreading financial crisis, Japan's problems continue to pose threats to stability.

The euro area
Any slowdown in economic growth across the euro area will tend to impair loan exposures. Major UK banks' cross-border claims on European borrowers were €75.1bn at the end of last year, 8.3 per cent of their total assets, and equivalent to 130 per cent of their regulatory capital. But the picture differs from country to country.

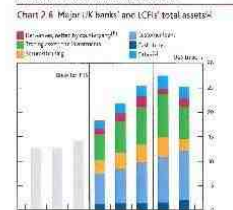
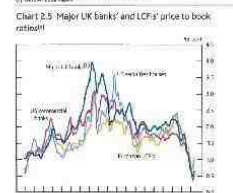
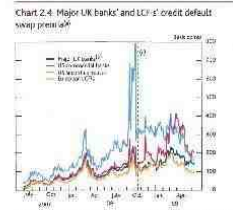

Continued uncertainty around banking sectors in major economies is evident in financial markets. Threats of insolvency against major UK banks and LCFs' debt securities are evident (Chart 2.4). Equity prices also remain weak, at around 30%-55% of pre-1998 levels (Chart 2.3). Firms' debt-to-book ratios for most banks remain historically low (Chart 2.5). For some institutions these ratios are currently below one, implying further falls in the book value of equity are expected.

...and banks globally remain highly leveraged. Underpinning this outlook is concern over the size of banks' balance sheets, which have grown substantially over the past decade (Chart 2.6). While total assets of the world's largest banks fell in 2000, this fall was concentrated among the US securities houses and European LCFs. In both cases, there were significant falls in trading assets. In contrast, a number of acquisitions completed in 2000 resulted in a rise in net assets for the largest US commercial banks. Among the major UK banks, there was a significant shift in the composition of total assets as secured lending to other financial institutions fell while loans and cash holdings rose.

Chart 2.7 maps the changes in banks' assets in 2000 onto one possible measure of leverage. On this measure, leverage of the major UK banks remained broadly unchanged during 2000, with the median level at just over 30 times capital. The US commercial banks experienced the largest changes in leverage, with the median ratio rising significantly to around 60 times capital. This rise reflected both acquisitions completed during 2000 and significant injection of capital associated with losses incurred over the same period.

...and seek to strengthen capital buffers. A number of banks internationally have sought to improve their capital positions, including through conversions of preferred shares and convertible notes to equity, private sector capital raising and participation in government support schemes (Table 2.4). The most significant capital raising has been completed or announced by US commercial banks. Following the US stress-testing exercise, these institutions have announced capital-raising plans generating a 2.5 percentage point increase in their core Tier 1 capital ratio in the United Kingdom, capital injectors – including through the Asset Protection Scheme (APS) – are projected to add a percentage point to the major UK banks' core Tier 1 ratio. UK banks are also actively seeking opportunities to generate capital internally through debt buybacks and exchanges (Box 4) and the disposal of assets.

Nevertheless, leverage remains elevated across the global banking system. Capital raising completed or announced by banks since end 2008 will reduce the median leverage ratio to pre-2007 levels, at around 35 times capital, with the greatest impact on the US commercial banks (Chart 2.7). But at these levels, capital buffers would still be eroded significantly if

Figure 4: Later Financial Stability Reports

To build on this performative analysis of the science behind financial stability reporting, is Miller and Rose's Foucauldian point about the politics at play here. For these two authors, forms of 'governmentality have come to depend in crucial respects upon intellectual technologies, practical activities and social authority associated with expertise' (Miller and Rose 1990:1). In other words, graphs, charts and diagrams render reality into a calculable form and, through technical expertise, have an active role in the productive and self-policing behaviours of citizens and publics which are fostered in advanced liberal democracies. Further, and to contextualise the FSRs, it would appear then that FSRs become likelier to appeal to a technical proficient, professional market audience (See Braun 2015). We see a shift then, from governing a generalist population to governing a specialist financialized audience.

Due to their constitutive role, FSRs then are part of the assemblage that seeks to govern (through) finance. Certainly some of these diagrams and charts are future oriented forecasts, corresponding to the ‘anticipatory epistemic objects’ (Anderson 2007, 2009) that act on the future in the present. An example here is the Systemic Risk Surveys, one of which looks like this:

Chart 2.16 Concerns around geopolitical risk have risen

Systemic Risk Survey: respondents citing geopolitical risk as a key risk^(a)

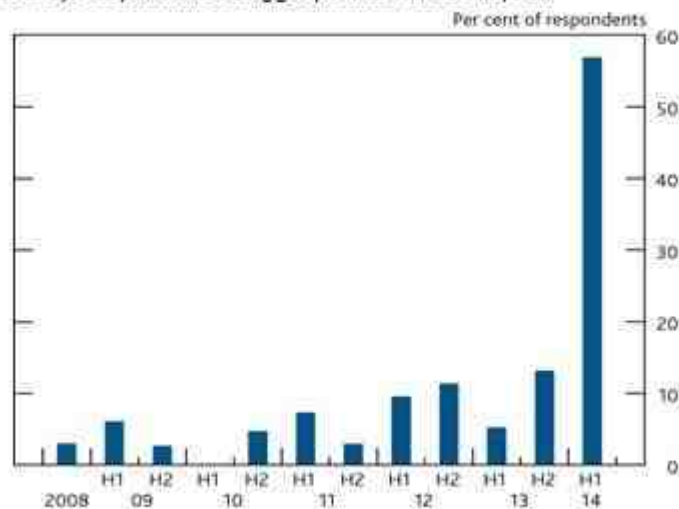

Sources: Bank of England Systemic Risk Surveys and Bank calculations.

(a) Percentage of respondents who cited geopolitical risk as a key risk, when asked to list the five risks they thought would have the greatest impact on the UK financial system if they were to materialise.

Figure 5: Systemic Risk Survey

However, more generally Anderson’s formulation seems to suit the inflation forecast more so than the financial stability report. What the inflation report and the FSR do have in common however, is their performativity- they contribute to the construction of the economy and alter an ongoing (financial) system (Christophers 2014d: 7). In the case of the FSR, if we pursue Miller and Rose’s point, it presumably acts in a governmental way that presents observable evidence of the activities of institutions in the City of London, thereby promoting self-policing behaviour in the City.

The extent to which this governmental strategy is truly effective is a contentious point. Davies and Green write that the:

‘concrete benefits delivered by FSRs are so far very modest. They may have informed public debate, but there is little evidence that they have been effective as early warning systems, or that they have changed behaviour in the financial authorities of firms themselves’ (Davies and Green 2010:66).

For these practitioner-authors, FSRs 'are too bland and fail to highlight emerging stress that might alert private sector to the risks they are running, and might cause them to modify their behaviour, in a timely way' (Davies and Green 2010:67). This then highlights a significant tension in the governmental strategy of FSRs when held alongside the performative nature of those very same documents. Davies and Green identify the dilemma as being 'how high should the threshold of confidence be before a central bank highlights a potential problem whose identification might itself cause a collapse of confidence?' (Davies and Green 2010:66). For these practitioner-authors, a lesson of the Global Financial Crisis is that the FSRs need to be used in a more governmental way, in the sense that 'central banks should in future err more on the side of pointed analysis and be less afraid to be precise about emerging risks' (Davies and Green 2010: 66). Nonetheless, debates about effectiveness merely underscore that, though their changing form and content, FSRs bring into being an object to be governed.

4.2. Distributed Agency of FSRs

FSRs, however, do not act alone on financial stability. Rather, they tend to describe many other techniques and practices with which the FSRs themselves interact. The crucial question of how the FSR fits into central banking, and indeed central banking when conceived as assemblage, can be best illustrated through the lens of the recent development of the stress test. As previously mentioned, macroprudential stress testing involves periodically running an anticipatory exercise in which the impact of a hypothetical scenario is calculated for the banking system. Depending upon the results of a test, banks may be required to set aside additional capital reserves to mitigate economic downturns.

Although it initially gained public prominence as a forward looking device within the improvised governmental response to Global Financial Crisis (Langley 2013b), the regular running of such an exercise has since become a key regulatory technique (www.bis.org/publ/bcbs155.htm). The results of these tests are publically announced as part of the financial stability press conference. Stress testing is a window into the distributed agency we see within the way in which FSRs shape the financial system.

During the June 2014 press conference, in which the Bank of England outlines a loan income cap to dampen a new housing bubble, Paul Mason, a television journalist, asks in an accusatory tone whether the Bank's financial stability tool kit is ineffective, describing the Bank as the 'Bank of Zero'. In particular, the point at issue is Mason's typically blunt claim that there has been 'zero impact from the stress test.' What Carney and Bailey's responses to the question reveal is that

'there's no reason to come to the conclusion that the stress test is zero' (Carney, June 2014). In other words, the stress test itself is said to have an impact and seemingly substantive consequences. As Bailey (June 2014) argues:

'Today if you look at the Financial Stability Report, the FPC has essentially closed its recommendation on capital. And the reason it's closed its recommendation on capital is because of the actions that have been taken in the interim period on adjusting and raising capital and adjusting the capital position of the banking system in this country. That is not a zero impact.'

As Carney and Bailey have it, and consequently critical to the impact of the Bank, is the technical device of the stress test. It is an important example, because firstly stress testing can be said to be performative in the Austinian sense, precisely because a positive stress test on an institution can confer confidence upon it, as in the case of the US Treasury's Supervisory Capital Assessment Program of spring 2009 (Langley 2013a:51, 55). Similarly, a negative assessment can actually bring about pressure on a bank's regulatory capital provision.

Notably FSRs do two things here. The first is that FSRs themselves have an active role to play in the stress test because the results of the stress tests are released through the financial stability report and its press conference. FSRs are inseparable from both discursive operations and assemblages. Concretely this takes the form of the following excerpt from the opening remarks of the December 2014 press conference:

'Let me turn to the stress test concluded today. The test builds on the recently-completed European test, which incorporated weaker global growth and a snap back of global interest rates. To this base, we have added a severe shock in the UK economy and housing market... **the test results demonstrate that the core of the banking system has become significantly more resilient since the FPC's 2013 capital exercise. Most importantly, the results suggest that the banking system is strong enough to continue to serve households and businesses during a severe shock.** To be clear, the firms were not allowed to respond to the stress by cutting the supply of lending. Given this performance, the FPC judges that no system-wide macroprudential actions are required. In light of the stress, the PRA Board judged that the capitalisation of three firms had to be strengthened relative to their position at end 2013' (Carney, December 2014).

The second aspect of interest is that FSRs also speak of and refer back to the composite parts of the assemblage at play. The case of the stress test is instructive as the responses from Carney and Bailey represents a ‘mode of anticipation that constitutes part of economic activity itself’, and furthermore, ‘organizations of human and non-human networks, including technology, that enter into specific economic activities’ (Butler 2010: 150). Within this line of argument, we are, in Langley’s terms, faced with an ascription of ‘agency to calculative devices of risk’ (Langley 2008b: 472). Is this problematic?

Perhaps not, due to an argument that Judith Butler (2010: 150) has recently made that agency can be ascribed to non-human domains where there is no clearly speaking subject. Butler’s argument is to undermine the working assumption within Austin’s original formulation that there always need be some *person* ‘who is delegated to speak or that performative discourse has to take the form of *discrete verbal enunciation*’ (Butler 2010:150).

Financial stability reports, then, contribute to and record the composition of financial stability assemblages. The agency of technical devices is important within the Bank of England’s stress testing, because at its heart we find the RAMSI suite of models (Alessandri *et al* (2009)), which estimate resilience in a stress scenario (Burrows, Learmonth and McKeown 2012). According to Bank of England staff, ‘RAMSI is comprised of a set of equations that model each component of the largest UK banks’ income, dependent on the composition of their balance sheets and projections for various macrofinancial variables’ (Burrows, Learmonth and McKeown 2012:4). The component models include: ‘a Bayesian vector autoregression model to simulate macroeconomic scenarios, satellite models for credit and market risk and net interest income, an interbank network model and an asset price function to simulate fire sales of assets’ (*Bank of International Settlements* 2013).

Figure 1: RAMSI framework

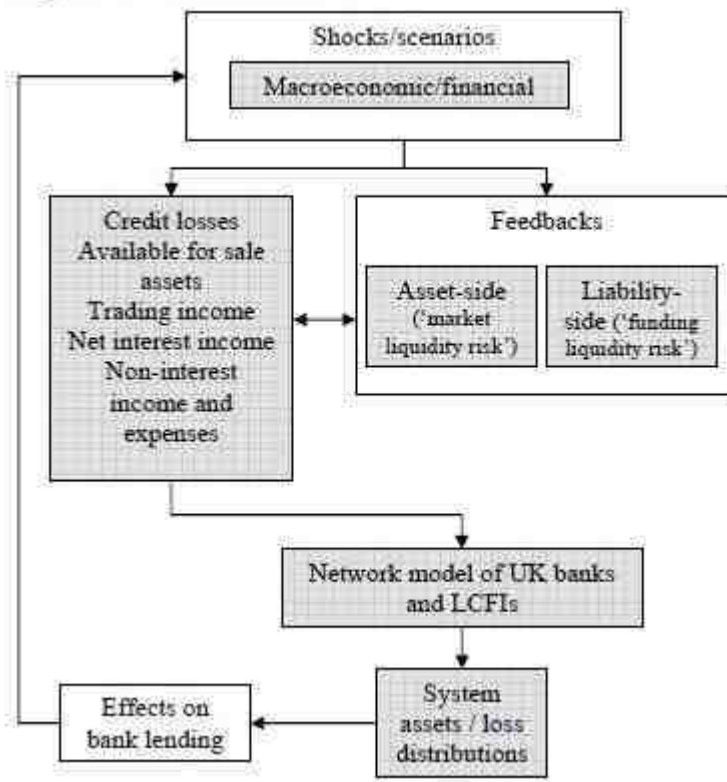

Figure 6: Visualisation of the RAMSI framework, taken from <http://ftalphaville.ft.com/2009/06/15/57056/say-hello-to-ramsi/>

All this is not to do away with human agency or action. After all, as the Bank of England readily concedes, RAMSI ‘is in no sense perfect. The simplicity of much of RAMSI means it must be combined with judgement when running stress tests’ (Burrows, Learmonth and McKeown 2012:4). What we are then facing in the stress test is a distributed agency of an *agencement* (Hardie and Mackenzie 2007: 58). This, as Callon tells us, is an economic actor which is not necessarily an individual human being alone but rather a wider sum of parts, which can include humans, but also ‘tools, equipment, technical devices and algorithms’ (Callon 2005: 4).

So far in this chapter we have seen that Financial Stability Reports have a visibility such that they are more than mere descriptive statements and bring the financial sector into being, as something that can be quantified and governed. Further, they are implicated in a distributed performative agency. What I now go onto argue is that financial stability reports have evinced a second significant change in the near 20 twenty years of use. This is a shift towards mediation and performance, and that this

has occurred in ways that require a reconceptualization of the concept of performativity as mobilised in the context of economic life.

4.3. The Layered Performances of Central banking

In this third and final section of the chapter, I ask how to best understand the place of the FSR in performative terms as much more than the account of *agencement* provided at the end of Section Two. Performative life is complex and exhibits itself in myriad ways and I make the case here that due to it having different facets, economic performativity needs to be extended (Esposito 2013) and conceived of as being either the layering different form described by Chris Clarke (2012) or alternatively, Sedgwick's (2003) clustering of different forms *around and besides* each other.

4.3.1 Writing the Financial System

Bank of England Governor Mark Carney gives us a clue to locating the performative force of the central bank when he refers to the mandate that the FPC has been given by Parliament: 'Our role – given to us by Parliament - is to manage risks to financial stability, including the build-up of unsustainable levels of leverage, debt or credit growth' (Carney, June 2014).

Moreover, the theme of Parliamentary sovereignty can be inferred from a series of authoritative rituals at play in the release of financial stability reports. This attends to the way in which both inflation forecasts and financial stability reports are released, communicated and taken up from press conferences, in the form of almost ritualistic events. Working with Graham Smart's insights from one of the editors of the monetary policy report at the Bank of Canada: 'the whole thing is a pretty structured, cohesive process, twice a year. Now they know what to expect, and we know what to expect' (Smart 2006: 167). So, the Financial Stability Report (FSR) is produced and released twice a year. At each publication of an FSR, the Bank of England hosts a Press Conference, at which Governor of the Bank and Chairperson of the Financial Policy Committee (FPC) is joined by three other members of the FPC, typically deputy Governors and the Head of Financial Stability. The five people sit behind four desks, each has a Bank of England emblem on it. The opening to the press conference is consistently of the following form, with Nils Blythe welcoming the press and talking through the FPC line-up present in the meeting. The governor then welcomes the press:

'Nils Blythe: Good morning everyone and welcome to the financial stability report press conference, on my left is Andrew Bailey Deputy Governor for financial regulation. On my far right is Spencer Dale, the Bank's Director for Financial Stability and Risk. Next to him is John Cunliffe, Deputy Governor for Financial Stability, and next to me is the Governor of the Bank of England, Mark Carney.

Governor: Thank you very much Nils. Good morning everybody.'

The 'Question and Answers' format also remains the same and is quite regimented. Always introduced last, and as 'Governor', the journalists address Mervyn King or Mark Carney as 'Governor' and are given the microphone for one question, before returning the microphone to the Governor for his response. The Governor can then choose to answer the question himself, or nominate one of the other FPC members to respond to the question. It is clear that the authority of the Governor and the Bank is a strong theme during the press conference. However, delegation within the press conference also brings into light the contributions of other high ranking officials within the Bank.

In such a way, in the physical production of conventions and practices is suggestive that 'the economy' is a performed domain (Clarke 2012:263-5). Here performativity is construed as the 'reiterative practices through which a discursive operation produces the effect that it names' (Butler 1993:2). When Carney is interpolated as the 'Governor' or sits behind a desk with the Bank's emblem on it, there is something both reiterative and authoritative about his position. In other words, it is the cultivation of a certain type of subject position.

When a question is asked, it is the Governor who is given the microphone, and he who decides whether he will answer the questions, or whether it will be another FOPC member who answers it. The press conference then highlights for us the generic performativity at play in central banking. Both the ritualistic and reiterative performative is present alongside the propensity for central bank statements to shape and format the economy.



Figure 7: Establishing Authority in Press Conferences

Perhaps the earliest fully elaborated attempt to articulate the discursive force of the central bank is that provided by Rodney Bruce Hall (2008,) for whom ‘productive power’ is exercised through ‘knowledge systems and discursive practices...through which meaning is produced, fixed, lived, experienced and transformed’ (Hall 2008:90). Hall gives the example of a central bank transforming the social status of a commercial bank from ‘insolvent’ to ‘recovering’ (Hall 2008:95). Certainly, there is something like this at play with the Governor’s opening remarks within the financial stability press conference. This part of the press conference is archived on the Bank’s website as a separate document to the podcast of the conference, or indeed the report itself. Within his opening remarks, the Governor of the Bank provides a verdict on the state of the financial system, and makes some comment on the performance in relations to the previous report and conference. Here I present four short examples to give a sense of the social status making practice of the opening remarks.

In this first example, Governor King is speaking in the context of deteriorating economic conditions in the Eurozone, where seemingly unresolvable large sovereign debts are causing investors in sovereign bonds much concern. King infers a status on the Eurozone, ‘worsening’, and goes onto make a distinction between UK bank exposures, and European sovereign debt exposures by Banks in other financial systems:

‘The most serious and immediate risk to the UK financial system stems from the worsening sovereign debt crisis in several euro-area countries. As the Report makes clear, direct UK bank exposures to those economies are limited. But experience has shown that contagion can spread through financial markets especially when there is uncertainty about the precise location of exposures’ **(King June 2011).**

A year later, in the opening remarks to the Financial Stability Report press conference, Governor King makes clear the gravity of the situation facing the Eurozone. Notably, the Governor’s opening statement confers the social status of ‘deterioration’ for levels of financial stability:

‘Since we last met, **the outlook for financial stability has deteriorated.** The crisis in the euro area has generated a great deal of uncertainty around the economic outlook and exposed severe vulnerabilities in the European banking system. **The fortunes of the United Kingdom economy, and in particular our financial system, have inevitably been affected’ (King, June 2012).**

Moving along further into the future to 2013, Governor Carney conveys more optimistic verdicts on an emergent recovery in the UK economy, which Carney declares is taking hold:

‘In the six months since the June *Financial Stability Report* **an economic recovery has taken hold in the UK.** Confidence has returned and credit conditions have eased further. UK banks have bolstered their capital positions by more than £20bn to meet the shortfalls identified by the Financial Policy Committee (FPC) and Prudential Regulation Authority (PRA). Liquidity conditions remain robust’ **(Carney November 2013).**

Carney’s opening remarks before the next Financial Stability Report are even more effusive, with the ‘recovery’ being described as ‘broadening’ and introducing a new status of ‘durable expansion.’ Despite this, Carney still warns against possible points of future fragility which may undermine the purported expansion:

‘With the recovery in the UK economy broadening and gaining momentum in recent months, the Bank of England is now focussed on turning that recovery into a durable expansion. To do so, our policy tools must be used in concert. The legacy of high indebtedness and structural imbalances means that there are financial stability risks that, if left unchecked, could undermine the durability of the expansion’ (Carney, June 2014).

Such statements appear to have the productive power that Rodney Bruce Hall refers to in *Central Banking as Global Governance* (2008). Productive power is said to differ from structural power because it is extensive, diffuse, and not part of a binary. In this account productive power concerns the discursive production of subjects such as ‘liquid or illiquid’ (Hall 2008:95). That said, it is important to remember that productive power is derivative of institutional power. Here, I am thinking of the example Hall gives of Alan Greenspan issuing an important calming statement following the 1987 Stock Market Crash. For Hall:

‘the productive power of the exercise of the central bank’s *deontic power* of emergency liquidity provision transformed the social and economic meanings of the disappearance of trillions of dollars of market capitalization into a painful but discrete and manageable, event from a harbinger of a major downturn in the availability of credit’ (Hall 2008:95).

So the productive power follows from the unique authorisation afforded the central bank. However, the issue with this reading, is that the very deontic powers such as lender of last resort, are themselves performed categories. So for example, and taking Knafo’s aforementioned analysis of the role of the central bank in the Gold Standard system, state officials created ‘the very entity that ‘lender of last resort’ was intended to describe’ (Knafo 2013: 137). Consequently we can say that the social and economic meaning of the central bank preceded, rather than being a function of, the deontic power of the central bank. Instead then, we have an account in which discursive operations can be seen as prior and in some sense independent from, institutional power. And, as I have argued in Chapter Two, and reprise and reiterate in Chapter Eight, a Deleuzian approach to assemblage is one in which the material and the discursive cannot be prised apart.

When searching for an alternative analysis, an initially tempting route to go down is to conceptualise members of the FPC as ‘petty sovereigns’ in the sense originally articulated by Butler in *Prearious Life* (2004) and utilised by de Goede in her monograph *Speculative Security* (2012).

Butler is trying to capture the managerial power behind many of the sovereign decisions made during the war on terror. The analogy here is to decisions such as changes in interest rates, or indeed when to inject money into the economy through quantitative easing. Alternatively, if an unnoticed but fundamental agency is key for Butler, then a separate explanation for the discursive force of the FPC could be that it is an instance of Bourdieu's 'habitus', where the high ranking officials are an embodiment of established contexts of authority. Here habitus refers to the 'lasting dispositions, trained capacities and structured propensities to think, feel and act in determinant ways' (Wacquant 2005: 316). However, I want to suggest here that neither of these existing routes adequately capture quite what is at play here.

Firstly, although we might agree with Butler that throughout the process of delegation within the Bank of England press conference, 'power precedes them and constitutes them as sovereigns', there are still compelling grounds to break the analogy. For, as Butler argues, petty sovereigns have minimal accountability because they 'do not offer either representative or legitimating functions to the policy' (Butler 2004: 62). Given that Members of the FPC at the press conference both represent the Bank and explain and legitimize policy, they cannot be considered 'petty sovereigns'. Secondly, it is possible to critique Bourdieu's formulation of habitus by aligning the argument with those made by Butler elsewhere that, there are instances where 'an utterance gains force through breaking with prior positions' (Butler 1997:145). For example, the decision by the Federal Reserve *not* to provide a rescue package for Lehman Brothers in 2008 despite having previously done so for other institutions. And, as Butler puts it in a later article in the *Journal of Cultural Economy*, if we were to 'usefully consider how a hesitation, cough, or less than enthusiastic adjective on the part of... current chair Bernanke actually facilitates certain movements on the stock market. That would surely be one way of finding performativity in the midst of economic life' (Butler 2010:150).

Thus, something is elided here, a force which persists even when established authority contexts are disrupted. And, as such the entry point must be different. In particular geographers Thrift and Dewsbury (2000: 414), argue that a 'major apprehension' with generic performativity is the lack of creativity and 'free play', as the existing account prioritizes ultimately restrictive discursive operations. For example, the gendered subjects that we encounter in Butler's early work 'unconsciously resignify a self-identical principle' in a way that does not differ or depart from that principle (Thrift and Dewsbury 2000: 414). The critique, then, is that if generic performativity is about a performance of something, then perhaps the consequence is to lose touch of the liveliness

and potential for disruption from the ‘performance’ of central banking. This does include central bank press conferences, but could also apply to central bank interventions such as programmes of quantitative easing and asset purchases.

Moreover, as much as existing work does highlight for us some sort of ritualistic performance, it does not quite capture the open, unknown and quite frankly speculative nature of what the central banker is often doing. As such delivery becomes all the more imperative. The unscripted nature of questions and answers can be found in the podcasts and transcripts of the June 2014 Financial Stability Press conference. In the remainder of the chapter I elaborate on the additional layer of performativity I am introducing, the layer of lively practices.

This is a part-Deleuzian/part-Derridean field of creativity, liveliness and disruption. For Derrida, communication is made possible by the breach which lies at the heart of language’s ‘iterability’ (Loxley 2007). Such ruptures have the potential to disrupt seemingly regimented conventions. Secondly however, I transpose Deleuzian ideas from Thrift and Dewsbury (2000) to look at gambles with unknown outcomes which again disrupt the repetition of established discursive operations.

4.3.2. Derrida and Difference: Disrupting Conventions

Firstly, and as mentioned in Chapter Two, Derrida’s often provocative³⁴ engagement with analytic philosophy through his exchanges with John Searle attends to the slippages in communication that do not figure in work influenced by Austin’s work on language. The iteration that is present in communication has at its very centre rupture or failure. In other words, for Derrida, a sign or mark that was not repeatable would not be able to function as ‘an element in a language and code’ (Butler 2010:152). And, this repeatability or iterability of the mark means that while two identical marks are the same there is a difference- between each due to their being more than one (Loxley 2007:77-78). As highlighted in Chapter Two, the structural breach embedded in iteration is both spatial and temporal (May 1997: 100). The consequence of this is that performativity cannot solely operate through conforming to ‘constitutive rules’ (Loxley 2007: 89). To illustrate this conceptual argument, I begin with an example in which a journalist from the Guardian newspaper asks Governor King about the public debt crisis in Greece during the summer of 2011. At this particular

³⁴ See the essay ‘*Limited Inc. abc...*’(1988) in which Derrida refers to Searle as ‘Sar!’.

moment in time it looked increasingly likely that Greece would default on its public debt with dangerous ramifications for European Banks exposed to Greek sovereign debt through credit default swap contracts. The point I am illustrating here is that the iterability of the mark, and the distance between utterer and receiver disrupts the scripted flow and format of question and answer. Governor King does not hear the entire question at first and needs others in the room to clarify it for him:

Jill Treanor, (The Guardian): As you know there's been much talk in the market that the Greek crisis is actually the next Lehman moment, do you think that when you talk about loss of confidence you're actually concerned that there is a new Lehman moment in the market?

Mervyn King: Sorry, a new -?

Jill Treanor: Lehman, Lehman.

Male: Lehman moment.

Mervyn King: Well, I don't like to use that phrase because I'm not sure that the sovereign crisis now and what happened in the case of Lehman Brothers have much in common.'

(*Questions and Answers*, June 2011)

Hence, conceiving of performativity in the way that Derrida does brings to light the disruptions that are structurally embedded within the very operation of language, namely within both writing and speech (May 1997:99). The spatial gap between Governor King and Jill Treanor creates a break, exemplified by King saying, 'sorry, a new-?' This breach is filled by another interlocutor, disrupting the conventional and established back and forth between King and Treanor.

Spatial disruption is not the only aspect of misfire that Derrida highlights. There is also a temporal absence apparent in press conference dialogue. To illustrate this, I now move onto an example of answering an unusually phrased question, one to which both Governor Carney and Deputy Governor Bailey have a brief moment where they do not know what their response should be and they delay. The question is from 2014 and pertains to the Bank of England's introduction of a cap so that no more than 15% of any lender's total number of new residential mortgages should be at or greater than 4.5 times the borrower's income. The journalist, Helia Ebrahimi, wants to know more about the regulatory implications of the Bank's newly announced policy stance:

Helia Ebrahimi, (CNBC): House builders will be very happy with you today, but can you tell us a bit about these biting sanctions? What could you do to banks if they breach this 15% cap? And also do you regret that your communication strategy has left you being characterised as an unreliable boyfriend? (Laughter).

Mark Carney: Why don't I take the second one - Andrew why don't you take the first one and I'll take the second one? No, I'll do it the other way around. I don't know what you'd say about it actually, Andrew?

Andrew Bailey: Nor do I.

Mark Carney: Exactly, look - I'm a - as colleagues are - we're dedicated central bankers. What we're focused on is faithfully delivering the mandates we have.'

(Questions and Answers, June 2014)

In this extract then, there is an element of impasse, as neither Governor nor Deputy Governor 'knows what you'd say about it' for an initial period after the question is being asked. Governor Carney is confused about who is best suited to answer the question. There is, then, a momentary gap, or temporal rupture, between question and answer. Here we might think of this as being a

similar phenomenon to the weekend of 15th September 2008, where the Federal Reserve and Bank of England seemingly had to react to the huge losses posted by Lehman Brothers and make a decision whether to bail out the bank or allow Lehman to fail. The main point to take away here, is that the central banker needs to have the resolve to persevere when exiting authority contexts are disrupted.

4.3.2 Deleuze and Difference: Creativity and not knowing the outcome.

If the preceding examples from press conference exchanges evinced Derrida's concern with the intractability of breach within communication, then Deleuze is interested in how repetition can be contrasted to a pure difference in which 'risky, creative and experimental' actions can anticipate but 'not know' their outcomes' (Williams 2013:16). A Deleuzian alternative of the kind suggested by Thrift and Dewsbury, is one which is sensitive to the creativity of performance, rather than merely the ritualistic performance of existing categories and symbolism. Thrift and Dewsbury read Deleuze as arguing that generic performativity works through imitation, resemblance and repetition. To take this further and to relate to Deleuze's work on difference (1968 [1994]), 'the possible comes to completion only by being represented as realisation, and thus filling the hollow or gap that difference resides in, nothing new is created.' The new is unable to take form without the hollow (Thrift and Dewsbury 2000: 416). This representation can be contrast to 'practice' in which we can only speculate on what 'the outcome' will be (Thrift and Dewsbury 2000: 416). The two examples I utilise here are improvisation and humour. Here I first push away at the layer of lively practices to show improvisation by Andrew Haldane, the Bank of England's Executive Director of Financial Stability. It is a difficult question, and I have selected it because it is not an obvious question related directly to an event, but instead draws together statements made by Haldane, and Mark Carney over the reforms to banking conventions in the Basel III Capital Accord:

'Ben Chu, (The Independent): A question for Andy Haldane. In your recent 'Dog and the Frisbee' speech you seem to suggest that the thrust of the Basel III approach which is the emphasis on complexity might be misconceived. Mark Carney, who we now know is going

to be the next Governor of the Bank of England, suggested that your concerns were uneven and not based on a full appreciation of the facts. Are we looking at a misunderstanding there or is it a fundamental difference on the philosophy of how you regulate the banking sector?

Andrew Haldane: Just a couple of points on that if I can, Ben. So on the Basel III question just to be absolutely clear what I said in the speech you mentioned. There's no question in my mind - and I've said it repeatedly - that Basel III was a significant improvement over Basel II, in particular in clarifying and simplifying and raising the numerator of the capital ratio, okay. But the part it left untouched was the denominator, which is risk weighted assets and concerns we have about its opacity, about its complexity, about its inconsistency - in fact exactly the things we discuss in today's Report...on to the second point, I mean if you, as I know you have, if you were to put Mark and I's speech cheek by jowl, you would find not so much as a fag paper of difference between them on the regulatory reform agenda. The particular issue you mention actually concerned the leverage ratio. And guess what? The country - one, that has a leverage ratio, and two, has been one of the biggest supporters of it because it protected them from the storms we've had over the last few years - was indeed Canada, and has indeed been Mark. So I think, insofar as there's anything at all, there is complete consistency on what we want by way of the future regulatory agenda, and improving risk weights are one element of that.'

(Questions and Answers, November 2012)

At this stage, although confirmed, Carney had not started working at the Bank of England. In light of its unpredictable nature, I characterize the response as improvisation by Haldane, as to not create any friction between himself and the incoming Governor Carney. Haldane has to be resourceful in his answer. This can be contrasted to the following extract, where the respondents seemingly have a response prepared in advance for a question regarding Paul Tucker's future as Deputy Governor as he was overlooked for the Governor's job in favour of Mark Carney. Haldane then, makes use of what he has available, evidence of Carney's record as Governor of the Bank of Canada, to defuse a politically charged question in a way that does not undermine or critique the future Governor. This

can be contrasted to the much more scripted seeming response of King and Bailey to a question about Tucker's future.

Chris Giles, The Financial Times: I'm sorry, we've all been terribly British about this so far, but I do think that we have to ask Paul Tucker if he would comment on his future after the recent appointment of Mark Carney. But I also wanted to ask another question - a proper question -

Mervyn King: You asked one. Paul will answer that, and then you can come back to your second question next time round. Paul.

Paul Tucker: I'm the Deputy Governor for Financial Stability. There's a job of work to be done; I'm doing it.

Mervyn King: Next question.'

(Questions and Answers, November 2012)

The latter exchange conveys a sense of a pre-meditated shutting down of an avenue of discussion as quickly as possible, without any elaboration. In effect, this is an example of what I have described in the methodology chapter as 'managed transparency'. In this latter exchange King immediately hands over to Tucker, seemingly confident in the answer Tucker will provide. This can be compared to the former passage which was a much longer and effusive discussion and rejection of a politically charged question. Haldane appears to be thinking on his feet and improvising, rather than citing an answer he has rehearsed. This then, is another lively practice.

The final lively practice I want to distil from these Questions and Answer sessions is the dimension of comic 'imagination' to a conception of lively practices, to sit alongside stuttering, mishearing, and improvisation (Bergson 1935:41). Firstly, I turn to a brief moment in a press conference in which laughter emerges as a response to Larry Elliott's unorthodox question. It is then, a journalist

who demonstrates creativity within the Q&A format to ask a question in relation to the LIBOR manipulation allegations being levelled at certain banks:

‘Larry Elliott, (The Guardian): I just wondered whether you saw any parallels at all between what's been going on in the financial sector with that and whether the mis-selling of swaps and manipulation of Libor is the equivalent of rubbish bags piling up in the streets in the Winter of Discontent? And is there a broad similarity between those two historical movements, do you think? And that perhaps the City even now doesn't quite get it in the way that the trade unions didn't quite get it at the end of the 1970s?

Mervyn King: That's a very interesting hypothesis [laughter], and I'd encourage you to write more on it so that we can reflect on it. I don't think my expertise is in the area of recent UK political history, so I think this is something I'd like to reflect on before drawing clear parallels.’

(Questions and Answers, June 2012)

Mervyn King's response, which I have characterized previously as bemusement, can be characterised as a practice prior to a proper speech act from the Governor- which King is referring to when he mentions that it is pre- 'reflection' and the official drawing of parallels by the Governor. The Governor is not sure of the consequences of a speculative answer. Humour then, demonstrates imagination in terms of both questions asked by journalists, but also this later aspect is that which constitutes a gamble whose consequences are unknown.

Finally, I consider a brief exchange, in which Mark Carney attempts to inject some humour into the end stages of the press conference. Carney is responding quickly to a sporting metaphor used by Nils Blythe to indicate that the press conference is winding down. I would suggest then, that Carney is reacting instinctively to what has just preceded. His joke is a gamble and he does not know whether or not it will provoke laughter:

‘Nils Blythe: We're into extra time, but we'll take one more quick question from Ed.

Mark Carney: Injury time.’

(Questions and Answers, November 2013).

I have used these examples then, to bring to the forefront another aspect of performativity, the creativity of humour. The Governor displays ability to invert the resistance strategy of undermining the rationality of finance that de Goede (2005b) draws from her reading of Foucault (1988). This is exhibited in creative posing of questions by journalists, and the pre-reflective bemusement on behalf of the Governor. Further, imagination and creativity is clearly evident in Andrew Haldane's improvised response to an awkward question about his future manager. Finally, the humour and laughter highlighted in these examples is seemingly emblematic of lively practices in the press conference. These are gambles, the outcomes of which are not known. Importantly, often the success such examples of creativity and imagination relies on the manner or context with which the line is delivered. This notion of delivery within performance is often absent in accounts of the performativity of economic life.

4.4. Conclusion

To conclude this chapter, I reiterate the point that the FSRs form part of the assemblages through which the Bank of England attempts to govern. They are, in the words of Miller and Rose an 'intellectual technology' (1990) which have a visibility. And, as such, the visual transformation of the reports between 1996 and 2011 shows that they are part of the process of rendering the financial system calculable and governable by scientific procedures. This analysis of visibility also suggests a move towards a target audience of informed and professional investor publics. But, more than just being a process of governance or reterritorialization, it is also important to consider that the FSRs are a means through which the Bank of England is self-referential. FSRs refer to the various assemblages which seek to act on financial stability. As demonstrated with my reading of press conferences, FSRs have much to tell us about credit derivatives, value at risk, stress testing, confidence as composite parts of the Bank of England's financial stability assemblage. And, by applying the methodology outlined in Chapter Three, the Bank of England's understandings of these techniques and technologies can be sketched and analysed.

This chapter has also used both stress testing and press conferences to argue that the performativity in which FSRs are implicated involves distributed and non-human agency, captured by the notion of *agencement*. More than this however, by analysing press conference transcripts and video recordings, this chapter supports Chris Clarke's (2012) view that different forms of performativity can be overlapping. And here it is argued that central banking involves reiterative practices which

imbue senior Bank staff with authority. Further still, the chapter has argued that to understand the performativity of the economy we must add an additional layer, a layer that is generally marginalised by generic and Austinian performativity – lively practices. And here I analyse texts and video recordings through Derrida and Deleuze. For Derrida, communication is made possible by the breach or distance which lies at the heart of language’s ‘iterability’ (See Loxley 2007:77). Such ruptures have the potential to disrupt seemingly regimented press conference conventions. Central bankers persevere through this misfires or breakdowns. Secondly, however, I transpose Deleuzian ideas from Thrift and Dewsbury (2000) to look at gambles with unknown outcomes. Here, I presented examples of humour, laughter and improvisation to foreground lively practices. In some ways, it seems appropriate to speak of a central banker able to negotiate roles and contexts.

In closing, I want to suggest that lively practices do matter for theorising the economy because it is this delivery and performance of the central banker that financial media pick up on and report to the general public. If it is politically significant that the Subprime Crisis was narrated as a traumatic event and therefore to be governed in a particular way (Brassett and Clarke 2012), then it is surely just as important when *The Financial Times* reflects on the character, judgement and ‘impeccable timing’ of a central banker such as Mario Draghi of the European Central Bank in ‘ending the Eurozone Crisis’ (5th March 2015). In the following chapter the focus turns to one of the aforementioned techniques of financial stability governance, namely credit derivatives.

Chapter Five: Credit Derivatives as Debt-Risk Assemblage

As Bryan and Rafferty (2006a) put it, derivatives are on some occasions lauded for their elegance and flexibility, other times despised as a form of speculation, or simply not very well understood. They have a long history, stretching back 4,000 years, and were originally developed to insure against, or transfer, the risks associated with price fluctuations in agricultural commodity markets. Since then, they have become the preserve of financial traders. Derivatives are an agreement between two parties, which establishes the price to be paid for a particular commodity in a future transaction between those same parties. More specifically, they can be in the form of futures, forwards, options or swaps.³⁵ The incentive to trade commodity derivatives is to lock in the future price of some goods in question, in order to ‘buy certainty’ and thereby gain a measure of security (Bryan and Rafferty 2007: 136). Derivatives, then, are concerned with making parties secure in the face of an uncertain future. This logic of the derivative also makes it possible to unbundle and purchase the risk of possessing an asset, without actually buying the underlying asset to which the derivative refers. Conceivably, derivatives thus ensure that ‘the attributes of any asset’ can be ‘configured as universally recognisable and generic and therefore tradable’, irrespective of the market for the asset itself (Bryan and Rafferty 2006a:52). Buyers of derivatives are therefore often said to be taking positions which may be ‘covered’ (i.e. related to their holdings of underlying assets), or ‘uncovered’. Such contracts are written and traded in two types of markets: on exchanges, where largely standardised derivatives are mainly traded in terms of price; and (ii) more informally, on ‘over-the-counter’ (OTC) markets, in which they tend not to be standardized. Until the mid-1980s, derivatives were widely accepted to be instruments that helped to create commodity price certainty over time. However, the last 30 years or so has seen the development, of an array of financial contracts, especially credit derivatives, which perform a far more heterogeneous array of functions and are typically written and traded on OTC markets. Risk is ubiquitous in credit relationships because lenders might end up losing their loans upon default, while investors lose out when bonds default. The rationale behind credit derivatives then is to sell

³⁵ See Arnoldi (2004) for a clear explanation of how these contracts work and the differences between them. The key idea is that all of these contracts allow one to trade a characteristic of an asset without owning that asset.

on the risk without relinquishing the underlying loan (Valdez and Molyneux 2010: 430). Derivatives have thus moved away from the idea that ‘the value of the derivative derives from the price of the underlying commodity and are an adjunct to trade in these commodities’ (Bryan and Rafferty 2006a:40). And, if derivatives of any kind serve to ‘unbundle funding – and, thus, ‘liquidity risk’-- from the underlying risk to which an agent is seeking exposure via a particular contract, then credit derivatives unbundle ‘credit risk’ or ‘default risk’ from the funding of credit-debt relations’ (Tucker Speech 2007a:22).

In the following chapter, I first unpack the device of the credit derivative, using the examples of the collateralised debt obligation (CDO) and the credit default swap (CDS). While such financial instruments are well known for their supposed impenetrable complexity, the aim here is to attend to why it is that they are both examples of derivatives and how each works on risk (Christophers 2009).

Second, the chapter turns to analysis of my financial stability archive of some 800 documents. This section follows Bank of England discourses on credit derivatives up until the mid-2000s. This section identifies the considerable ambiguity in the Bank’s position on credit derivatives: while often espousing the potential of the credit derivative to disperse credit risk, complete credit markets and thus contribute to financial stability, fears about the insecurities engendered by credit derivatives were also consistently expressed by the Bank for nearly a decade. The positive opportunity- for risk dispersal- presented by the credit derivative can be explained by what authors such as Martin (2007) and Amoore (2011) describe as a ‘security logic’ of the derivative- the propensity of the derivative to de-territorialise risk. The potential danger presented in the discourse can be explained as being a result of the default risk underpinning the credit relationship on which the derivative is based (Amato and Fantacci 2012). The way in which profit is obtained through the derivative- through the liability structure- sees the reterritorialization of uncertainty and risk. Furthermore, that these two views are constantly found *together* reflects what Duncan Wigan (2009) describes as a dual performativity of risk, that risk is always both an opportunity and a danger.

The third part of this chapter moves onto a significant shift in the Bank of England’s statements concerning credit derivatives. In the sense that from the early-2000s onwards, the Bank identified the complexity of structured credit devices such as CDOs as being a major flaw in the derivatives system. This position does change in the sense that, due to developments in both mortgage markets and derivatives markets, the Bank becomes preoccupied with the difficulty in valuing credit derivatives. And, while this new danger is identified in the build up to and during the peak of the Global Financial Crisis, following major governmental interventions into the financial system, the

Bank returns to a concern with complexity. It is argued that this is a further example of deterritorialization, with the Bank's regulatory response to make credit derivatives more transparent and standardized. This response is couched in the language of recoding, re-organisation and reterritorialization. I go onto characterize the oscillation between deterritorialization and reterritorialization that appears present in Bank statements about credit derivatives and effectively being along an assemblage line of thinking.

5.1. The Mechanics of Credit Derivatives

Arguably at the heart of the so-called 'innovations' in global finance that preceded the 2007-2009 Global Crisis (Engelen *et al* 2011), the volume of credit derivatives outstanding accelerated dramatically during the first years of the new millennium (Arnoldi 2004; Mackenzie 2007). For individual financial market intermediaries, seeking to cover credit risk in their asset portfolio or deciding to take a position on particular risks, participation in credit derivatives markets has a clear rationale. In this vein, for example, credit derivatives were widely held to have 'come of age' as tools of risk management by the late 1990s, especially as credit default swaps (CDSs) had successfully contained the fallout from the Enron default in 1997 and mitigated against Russia's sovereign debt default (Clope 2009). This suggested that credit derivatives could indeed contribute to financial stability. At the level of the financial system as a whole, moreover, the growth of credit derivatives came to be regarded as a positive development by regulatory authorities on the grounds that these contracts enabled the transfer and dispersal of risk 'away from highly leveraged institutions' (Greenspan 2007: 371). In short, the successful management of risk by each intermediary institution- i.e. internal risk management- was equated with an advance in collective security through the successful management of 'systemic risk' (Collier and Lakoff 2008). In such a way, credit derivatives were thought to contribute to financial stability.

CDOs are structured credit instruments made by bundling up the risk characteristics of an array of underlying assets, and in the run-up to the Global Financial Crisis tended to include sub-prime mortgages, that is, loans to people who were a bad credit risk. When a mortgage originating institution writes a mortgage loan, a possible option is to securitize that asset. It is a derivative because the mortgage repayment is separated from the underlying asset of the house. This means that the institution sells the mortgage repayment to a shell company that it has been set up in order

to pool and sell on the mortgage repayments to investors. In other words the financial institution can take the mortgage repayments connected to the asset in question and pool these repayments with those other repayment streams that are connected to other assets. This process creates, effectively, one large (bundle) of ‘promised future cash flows from a wide range of different sources’ (Christophers 2009:12). Further, this asset bundle can be segmented into different orderly sections. It is typical for the cash flows, in this case mortgage repayments, to be grouped by their perceived riskiness. This will create a safe group (or tranche), a middle tranche and a risky tranche. This tranching creates a liability/reward structure, through which losses accrue to the tranches in terms of highest risk first. This structure is the ‘who owes what and to whom?’ of the derivative contract. As Christophers eloquently explains, these ‘tranches -the CDOs-are then sold on separately, paying different interest rates, to different sets of investors...with different appetites for risk’ (Christophers 2009: 12).

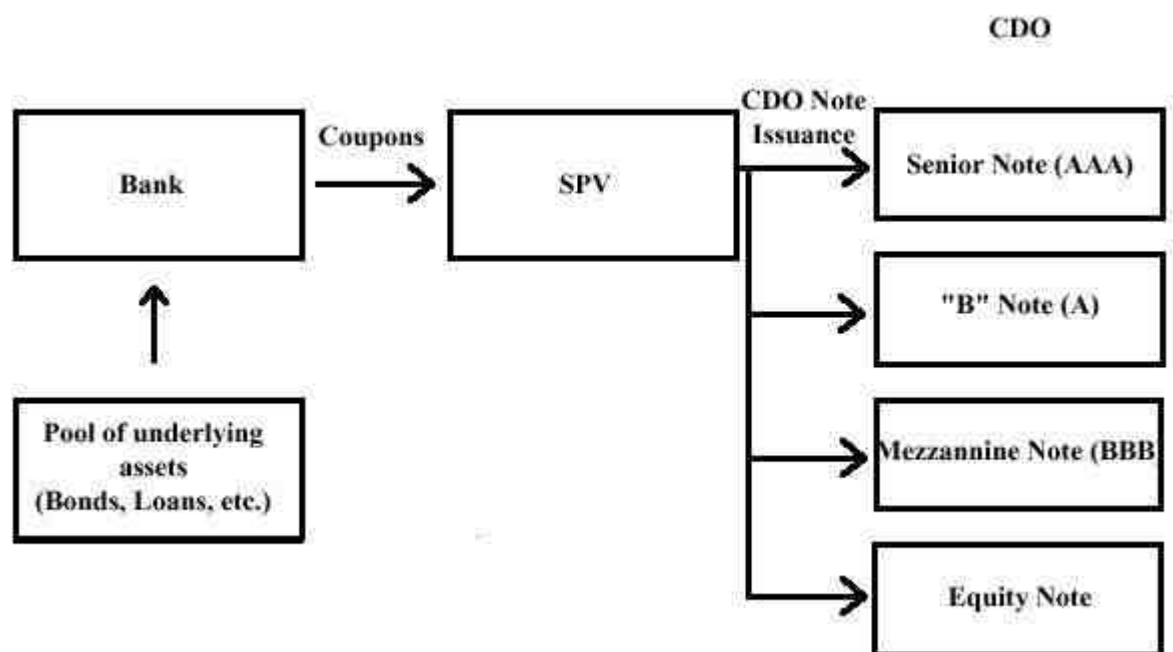

Figure 8- How CDOs work. Found at:

<http://www.actuarial-files.com/content/risk/creditderivatives.html>

So to unpack *Figure 8*, a number of ‘assets are pooled, packaged and sold by their owner to a shell of a company (a Special Purpose Vehicle), specially created by its originator for the

purposes of structuring the assets, thereby recreating them anew as asset-backed securities, and issuing notes on these new securities to fund the operation’ (Lozano 2015: 60). These notes reflect the aforementioned tranching based on perceived levels of risk.

On the other hand, credit default swaps (Figure 9) are an agreement whereby a bondholder, of say a company, pays a premium for someone else to take on the risk of default. The swap is a derivative because ownership of the underlying company does not change hands. This can metaphorically be thought of as being close to an insurance policy against default. The premium is paid for an agreed period of time and if the bond has not defaulted in this time, the premium taker (CDS Seller) can keep the payments and has nothing to pay. Should the bond default during this time period, then the bondholder (CDS buyer) ‘hands over the bond in return for its face value’ (Valdez and Molyneux, 2010:430). This again is the liability structure.

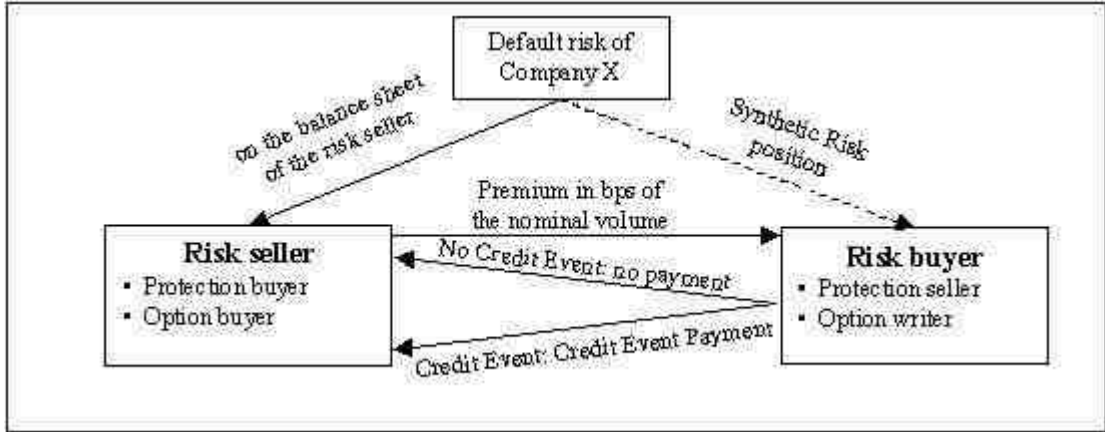

Figure 9: How CDSs Work. Found at <http://people.stern.nyu.edu/igiddy/syntheticabs.htm>

5.2. Bank of England Discourses on Credit Derivatives

This section begins by turning to the financial stability archive that I compiled from unstructured materials on the Bank of England website. At the forefront of analysis of documents from 1998 to 2003 is a considerable regulatory ambivalence in which the Bank of England consistently acknowledges both the positives and negatives of credit derivatives. The section analyses the positives as being the way in which derivatives disperse risk and thereby contribute to financial stability (Martin 2007; Amoore 2011). The negatives are analysed as being the risks and uncertainties that lie at the heart of the credit-debt relation on which the derivative is based (Amato and Fantacci 2012;

Lazzarato 2012). Finally, that these two aspects are consistently found together is a result of the dual performativity of risk as both opportunity and danger (Wigan 2009).

5.2.1 Regulatory Ambivalence: The Good and the Bad of Credit Derivatives.

In a 1998 Bank of England publication, for instance, derivatives are viewed primarily as a ‘new technology for risk management’ and possibly ‘may turn out to be the most significant financial innovation of the 1990s’. In this early text we see the emergence of a significant idea: ‘this new credit risk management tool should make the global allocation of risk more efficient...the new instruments make *credit markets complete*’ (Goodhart *et al* 1998:94). This is the idea that ‘in particular credit default products’ constituted the height of a sophisticated credit market that efficiently distributes risk to those most suited to bear it. The hope here is that it makes systemic collapse less likely. Later, of course, and in the context of the post-2007 crisis, it became common for regulators to acknowledge that credit derivatives did not distribute risks and thereby reduce systemic risk, but created systemic risks that were effectively concentrated in certain key institutions such as Bear Stearns and AIG.

What we find in the Bank of England archives, then, is an initial example of the legitimization of credit derivative practices, highlighted by the association of ‘improper’ application of risk management techniques with ‘gambling’. Nonetheless, in the financial stability publication, and when thinking about derivatives, such a normative statement about the ‘proper’ status of calculation also lies in tension with an admission of ‘the difficulties involved in pricing credit derivatives’ (Goodhart *et al* 1998:94). The Bank concedes that ‘the evaluation of credit risk is more complicated than the evaluation of market risk’ (Goodhart *et al* 1998:94). Indeed, here the Bank attempts to bypass the tension of its position over improper financial behaviour, deferring to the opinion of an industry expert:

‘as Paul Varotsis writes in a recent BBA volume on credit derivatives, ‘the lack of a scientific pricing method has never been a deterrent to trading (BBA 1997)’ (Goodhart *et al* 1998:94).

I characterize this as the ‘valuation difficulty’ within a technique of calculation. In drawing together a tentative conclusion on credit derivatives the Bank writes that:

‘Some of the risks previously confined to the banking sector might spread to other economic sectors via credit derivatives, and some commentators question whether this might be undesirable. We think that it would be an advantage, because non-financial institutions are not a source of systemic risk. If some banking risks can be unloaded onto non-banks, this should decrease systemic risk, rather than increase it. But third parties should be aware of the risks they are taking on’ (Goodhart *et al* 1998:96).

Therefore, in this early Bank of England publication, credit derivatives are described from a regulatory perspective, as being potentially ‘a new beast to be tamed’ (Goodhart *et al* 1998:91). The implication, in short, is that the provision of security cannot be left to the pre-emptive logic of the derivative. Taming implies a docility and a discipline which does ‘not allow things to escape’, or be ‘abandoned to themselves’ (Foucault 2007:45). Indeed, later the document explains the various facets of the disciplinary reasoning behind this argument:

‘While they may be used for more efficient risk management, they may also increase *systemic risk* if applied improperly. For example, a bank ‘gambling on resurrection’ could take on concentrated credit risk positions much more quickly than through the traditional lending process. Second, the credit markets are currently over the counter markets and relatively illiquid compared with other derivatives markets. It is therefore important that banks take the related liquidity risks into account in their control of trading activities... if there are improper internal capital allocations, then the writing of credit derivatives among a limited number of banks could lead to a ‘cascading’ of credit risk among the market participants, with systemic consequences if there is default in this group’ (Goodhart *et al* 1998:95).

However, here the Bank of England argues that ‘caveat emptor should apply’, i.e. the goods are *subject to defects*, rather than prohibited *because* of these defects. Events are therefore *allowed to happen*, and although they are not completely abandoned, ‘laissez faire is indispensable at a certain level’ (Foucault 2007: 68).

In the 1998 publication, then, there was qualified optimism about the potential benefits of credit derivatives. Two aspects are particularly important: (a) the hope that the new instruments may lead to market completion and thus make systemic collapse less likely, (b) a worry over the difficulties

that arise in valuing derivatives. In an elaboration on its initial take on credit derivatives, within a year they were primarily being viewed in more unequivocal terms as a 'risk unbundling' technology with 'significant economic benefits' (FSR 1999a:104).³⁶ Indeed, it is interesting that in 1999 the Bank of England considered credit derivatives to be 'a serious alternative to central counterparties' as a means of controlling counterparty credit risk (FSR 1999a:124). There was also a recognition that credit derivatives created 'another level of complexity' for credit risk models because 'credit derivative technology uses a different and more complicated form of probabilities than those traditionally used in portfolio theory' (FSR 1999a:112).

Similarly, in both 2000 and 2001, the potential benefits of credit derivatives were no longer presented alongside issues with pricing or valuation. Instead, enthusiasm for credit derivatives was still tempered, but this time with issues about systemic risk. As such, credit derivatives were viewed as positive development because they 'diversified risk by broadening the population of investors in credit risk' (FSR 2000b:16). The hope here is that risk is dispersed and systemic collapse is much less likely. However the Bank of England maintained that 'financial stability authorities need to follow' developments in credit risks 'closely' (FSR 2000b:16). The 'cash flows associated with derivatives' are 'generally not seen as a material problem in overall liquidity management', however, concerns are raised for dynamic hedging to occur in 'abnormal conditions...when the relationships between prices of financial instruments can alter suddenly' (FSR 2000b:108). In 2001, Clementi's speech reiterates the attractiveness of the risk management function of credit derivatives:

'In a wider sense the development of these markets for the transfer of credit risk is highly desirable. The institution best placed to originate a loan is not necessarily best placed to bear the risk. Markets in credit risk allow financial institutions to diversify their exposure across different sectors and geographic regions while retaining customer relationships... if they work well, markets in credit risk transfer have the potential to enhance financial stability and efficiency by ensuring that exposures to shocks are diffused throughout the system with no single player excessively exposed' (Clementi Speech 2001a:11).

³⁶ This document can be found at <http://www.bankofengland.co.uk/archive/Documents/historicpubs/fsr/1999/fsrfull9906.pdf>

However alongside this, the FSR maintains that ‘there is also the possibility that they could deliberately or inadvertently concentrate’ risk because ‘market participants can set limits on their own counterparty exposures but not on the aggregate exposures that the whole market might have to a particular counterparty’ (FSR 2001a:140).

FSR 2002a³⁷ is a particularly important document, because it discusses the role: ‘relatively novel means of credit risk transfer’ played in ‘the aftermath of the Enron default; and that...credit default swaps, have performed as intended’ (and dispersed risk). It is important to note that even then, the other, negative account was still present. The Bank warns that:

‘It is more difficult now to assess where risk is ending up. Greater use of credit derivatives by international banks to manage credit risk is also bringing into the credit arena some challenges already encountered in accounting measurement of interest rate and exchange rate risk’ (FSR 2002a:10-11).

The salient questions, Howard Davies reminded us, were both of locating the risks and asking ‘whether they have been correctly priced’ (Davies Speech 2002:38). As Davies summarised, ‘there are signs that credit transfer has, overall, been a stabilising factor, but there are concerns about whether some of the buyers of credit risk have properly assessed the risks they have taken on’ (Davies Speech 2002:38). The analysis serves to highlight ambivalence at the heart of the ability of credit derivatives to disperse risk and make systemic collapse less likely. Close inspection of the Bank of England archive, during the formative period in which the trade in credit derivatives was expanding, suggests that the potential to act as a device for credit risk management (and thus security logic more broadly) is inseparable from a fear about the various dangers associated with these calculative techniques at the heart of structured credit.

The two sides of the Bank of England’s early position on credit derivatives can be analysed using existing literature on derivatives and credit respectively. On the one hand, for critical security authors such as Louise Amoore, crucial to the way in which the logic of the derivative circulates in contemporary security practices is how ‘the reward characteristics of the derivative are sustained in a way that is indifferent to the risks of individual underlying elements’ (Amoore 2013:60).

Consequently, the logic of the derivative is present in the way that modern homeland security practices frame possible futures in a way that is ‘isolated from or indifferent to’ the ‘underlying

³⁷ The document can be found at <http://www.bankofengland.co.uk/archive/Documents/historicpubs/fsr/2002/fsrfull0206.pdf>

probabilities at the heart of derivative risk scores' (Amoore 2013:61). This is a particular instantiation of the wider social logic which Randy Martin extrapolates from a range of practices traditionally seen as being either divorced from, or simply beyond, the economic such as 'medicine, grammar, music' and dance. Abstractly, the logic sees the 'transmission of some characteristic from an originating source to a consequent site, expression or manifestation' (Martin 2013:67). The derivative then is a 'social principle' in which values are dispersed 'as to distribute their volatilities and consequences' (Martin, Rafferty and Bryan 2008: 129).³⁸ In terms of our case of credit derivatives, the logic works through the seductive promise of market completion, that 'all possible future contingent states of the world can be encompassed in a contract and actively managed' (Wigan 2009:158). Here then is a security logic which contributes to financial stability. And, in both cases of the CDO and the CDS, risks are sold to investors, seemingly diversifying an array of risks primarily associated with the holding of the underlying assets. Amato and Fantacci describe this as a paradigm shift from:

'an originate and hold model, in which the supplier of credit enters it in the balance sheet accepting the risk, to an originate and distribute model in which the supplier of credit distributes it, selling it on the market together with the associated risk in the form of securities' (Amato and Fantacci 2012:70).

Moreover, and in stark Deleuzian terms, the 'originate to distribute' model is underpinned by a logic of deterritorialization because it is a force which seeks to make risk actionable and move, disperse and eviscerate default risk from an underlying loan. The credit derivative is, then, a technique of financial stability because it prevents build ups of risk in places that cannot bear it.

On the other hand, if the security logic of the derivative is an opportunity to diversify risk and thus contribute to financial stability, a critical political economy of credit suggests a recurrent danger can be associated with credit derivatives. It is beyond the scope of this thesis to engage with the rich and much varied debate in critical political economy over the basic ontology of the financial derivative.³⁹

³⁸ See also Engelen *et al* (2011:61) for a critique of this logic of dispersal.

³⁹ Here an interested reader should consult Pryke and Allen (2000) or Mackenzie (2012) for overviews. For some authors, credit derivatives are fictitious or self-referential abstract replicas; merely benchmarked to themselves rather than productive processes (Arnoldi 2004; Cloke 2009; Maurer 2001; Rotman 1987; Wigan 2009, 2010). While for others, this detachment from production means that derivatives are essentially volatile and speculative, and are thus both uncertain and dangerous (LiPuma and Lee 2004; Tickell 2000; Wigan 2009). The leading political economy account of derivatives as a modern form of money can be found in Bryan and Rafferty (2006a). For an explicitly Deleuzian account of derivatives which attends to movement, identity and money cultures see Allen and Pryke (1999). Lozano (2015) takes this Deleuzian approach further to argue

More pertinent for the analysis here is the fact that the specific derivative under consideration here, credit derivatives, are brought into being by particular material and technological calculative processes. The credit derivative is a logic of reterritorialization or governance because the obligation that someone owes is never entirely dispersed. Instead, it is transferred so that it can be extended or settled at a later date. In particular the liability structure of the credit derivatives- the 'who owes what and to whom' - is a process of organisation or reterritorialization. Even though the debt may be dispersed or diversified, there is still a liability structure organizing the relationship. So while the derivative may distribute default risk, they are not indifferent to the underlying debt because the system means that debts have to be repaid. Here I draw on a heterodox political economy of credit and Amato and Fantacci's 'phenomenology of credit', in which the authors argue that credit requires 'the institution of a shared space of promising and waiting' (Amato and Fantacci 2012:29). The repayment of a loan in the future is dependent on future economic conditions that are uncertain. There is, in other words, an intrinsic riskiness for both debtors and creditors because 'risk is inherent in the relationship, because the relationship is structurally suspended over a fundamental uncertainty' (Amato and Fantacci 2012:30).⁴⁰ This much is in keeping with what Adam Tickell (2000) has long argued, that that credit derivatives are at heart defined by an uncertainty.

that the 'virtual' ontology of synthetic derivatives allows them 'to be plastically injected wherever and to whomever', to be created out of nothing and without restriction, and renders them hyperfungible- able to 'affect their profound materiality on the terms of all exchanges' (Lozano 2015: 79).

⁴⁰ To take a Deleuzian reading further, one must go to Deleuze and Guattari's engagement with Nietzsche's *Genealogy of Morals*. For Deleuze and Guattari, credit is not based on exchange but rather, an asymmetrical creditor-debtor power relation (Deleuze and Guattari 1983: 190). Debt therefore manifests itself as either an institutionalised power relation (Ingham 2004) or a culturally embedded exploitative relation (Lazzarato 2012:23). In other words, everyday credit and debt is about governance of the individual both in terms of surveillance and self-regulation (Langley 2008a; See also Konings 2015:131).

That these two sides of the credit derivative consistently appear together is a direct consequence of risk being more than the set of different techniques of rendering reality into a 'calculable form' (Dean 2010:206). What I want to do here is focus on risk as a performed category (MacKenzie 2005b). Risk is performative' 'because the way organizations depict their risks has a significant effect on the way they will, eventually, (embody risk) react to events and to other actors (Millo and MacKenzie 2009: 639). Duncan Wigan presciently points out that risk has a two faceted etymology. Firstly, risk can be conceived of as 'potential danger'. Alternatively, risk can come to mean 'opportunities in an uncertain rupture, or adventure and potential gain'. Wigan's argument then is that it is erroneous to separate the two aspects 'at the expense of an appreciation of the broader scope of risk as a performative rationality' (Wigan 2009: 163). And, when we consider the Bank of England discourses about credit derivatives, it is clear that the doubly faceted nature of risk is present. Alongside the opportunities tantalisingly promised by market completion are first a concern about pricing difficulties, before later morphing into a variety of fears about possible risks associated with credit derivatives. To draw from Deleuze and Guattari, reterritorialization and de-territorialization are enmeshed (Deleuze and Guattari 1983:258). If the liability structure of debt reterritorializes so that profits can be accrued and the market clears, it is underpinned by risk, uncertainty and destabilization.

5.3.2. Deterritorialization : A Problem with Complexity

To return to the archived texts, and returning to 2003, the financial stability reports document a sense of a period of change in which there was:

'a redistribution of credit risk, both within the banking sector and to non-bank financial institutions – not only via well-established mechanisms such as syndication and securitisation, but also via credit derivatives and structured credit products sold to non-bank investors. The credit markets – and so the capacity to manage credit risk – have continued to develop during 2003' (FSR 2003b:25).

Against the backdrop of the apparent maturing of markets for credit risk, however, both the 2003 Financial Stability Reports and speeches by three senior staff members acknowledged that

innovation ‘has brought increasing complexity to the financial sector’ (Davies Speech 2002:38). FSR 2003a warned, for instance, that:

‘there is specifically a danger that the riskiness of some innovative investment products designed to enhance yield might be underestimated or misunderstood, given the complexity of the payoffs; there is often a small probability of a very large fall in value’ (FSR 2003a:11).

So in 2003 there is a clear sense of the ambivalence highlighted in the previous section of this chapter. The middle of the first decade of the new millennium also saw the Bank very neatly knit credit derivatives into a broader narrative of the recent course taken by global finance. Indeed, there was a rather triumphalist tone about this particular portrayal of credit derivatives. Consider, for example, the following from a speech by Deputy Governor Large in 2003:

‘I would like to mention complex financial instruments... We have all read alarmist stories but Alan Greenspan often makes the point that one may over estimate some of the risks and underestimate the benefits. Shocks such as the Asian crisis, LTCM, 9/11 have been successfully absorbed by the financial system. The fact is that they have not triggered a systemic financial crisis and the instruments themselves contribute to flexibility or resilience in the system. The enable financial institutions such as banks to transfer or diversify risk to a wide variety of participants including mutual funds an insurance companies and hence reduce concentration’ (Large Speech 2003c:7-8).

However, later in the same speech, Large goes onto suggest that the Bank and its staff are also still fully aware of the tension between efficient risk transfer, (leading to market completion and thus enhancing financial stability), and concerns about complexity, transparency, and thus, and explicitly, pricing:

‘We need to understand the implications and threats of these instruments. We start by breaking down the whole area of complex instruments into a more granular form...firstly there is the question of opacity and data. It is very hard to know both where risks have been transferred from and who is now on the receiving end. A dilemma of today’s world is that despite attempts to improve transparency the new

instruments themselves can actually make it more opaque. Secondly there are questions of pricing and evaluation' (Large Speech 2003c:8).

The Bank of England's ambivalence about credit derivatives is yet again present in 2004. In the June FSR the 'holding of other bank's credit derivatives' is seen as a good thing because 'CDSs may aid a bank facing a liquidity shock, but may 'not help the banking system as a whole in the case of a system wide liquidity shock, as CDSs are 'inside' rather than 'outside' assets' (FSR 2004a:64). Like- wise, while 'products such as credit default swaps' are said to 'facilitate the transfer of credit risk to those agents able to bear and manage it most efficiently', at the same time they present:

'Multiple challenges for prudential regulation. One of these challenges is part of a wider issue, which is how to assess the risks that arise in the trading book when it acts as the conduit for the dispersion of risks...credit derivatives, while often a tool for reducing concentrations of credit risk, may also create direct credit exposures' (FSR 2004b: 75).

If, during the first half of the 2000s, both facets of risk- opportunity and danger- are clearly present in the treatment of credit derivatives in Financial Stability Reports, this later develops into a preoccupation with downside risks. In this section I forward the argument that credit derivatives consistently managed to frustrate attempts to act on, organise, and reterritorialize them through a series of dangers, risks and problems associated with financial innovation.

Initially, this is the risk associated with the increased complexity of credit derivatives. In 2007, the central bank's statements become more squarely centred on the creation of 'new and ever more complex financial instruments' in an era of innovation. The emergence of 'exotic' synthetic instruments which invested in tranches of CDOs was cause for concern because they are 'highly sensitive to small changes in the correlations of underlying returns which we do not understand with any great precision' (King Speech 2007a:5). Complexity is a key theme in FSR 2007a and by the release of FSR 2007b it was thought to be a source of uncertainty. As Bank Governor King argued:

'Ever more complex instruments are designed almost every day. Some of the important risks that could affect all instruments – from terrorist attacks, invasion of computer systems, or even the consequences of a flu pandemic – are almost *impossible to quantify*, and past experience offers little guide' (King Speech 2007a:5 *emphasis added*).

Alongside this, other anxieties are still present in collective regimes of enunciation about credit derivatives, especially those reporting developments in the US Subprime mortgage sector in which the number of defaults on mortgages was rapidly increasing. For example,

‘market contacts have pointed to the recent volatility of prices in the synthetic US sub-prime markets as suggestive of how, during a period of stress, prices in the cash and derivative markets may become disconnected, causing the correlation assumptions underpinning hedging to break down and crystallising basis risks’ (FSR 2007a:47).

Emerging fragilities in the global financial system start to become the focus of FSRs discussing credit derivatives. Investors bought these financial instruments assuming that the credit ratings attached to the ‘Mortgage-Backed Securities’ were accurate reflections of this risk involved and subprime mortgage loans tripled ‘between 2000 and 2006, reaching US\$ 1.17 trillion’ (Broome 2014: 189). However, this seemingly ‘everyone wins’ scenario did not last forever.

As Langley suggests, the calculative devices of Internal Risk Management failed because they:

‘failed, in their own terms, to price default risk effectively; securitization enabled so-called ‘risk spreading’ among investors, but intensified the contraction of lending once uncertainties became apparent and liquidity dried up; and interest-only and adjustable rate mortgage products sharply exposed borrowers to uncertainties over interest rates and house prices and lenders to rapidly rising default rates’ (Langley 2008b:472).

It is FSR 2007b which highlights the crystallisation of concerns about the pricing of credit derivatives because ‘price moves a long way outside the range of historical experience confounded pricing models’ (FSR 2007b:19). The Bank of England forecasts go as far as saying that that ‘the greatest vulnerability facing the financial system is a significant increase in the probability of risk pricing uncertainty’ (FSR 2007b:15).

As more and more of these subprime borrowers defaulted on their mortgages during the mid-2000s, financial institutions became increasingly unsure of how to value the credit derivatives on their own, or other banks’, balance sheets (Broome 2014: 189). In 2007, BNP Paribas publicly conceded that there was a valuation problem for assets related to subprime lending (Pixley 2012: 184). In particular, it is important not to underestimate the significance of BNP Paribas for the Bank of

England's understanding of credit derivatives. As this French bank publicly admitted that it was unsure how to calculate industry wide exposures to credit derivatives, the following excerpt from a Bank of England document suggests that:

'The announcement by BNP Paribas in early August that it was temporarily suspending redemptions from several funds, demonstrated *the global spread of valuation difficulties*. These events highlighted how inadequate information about the location of exposures in global credit markets could translate into sharply heightened uncertainty about counterparty risk' (FSR2007b: 7 *emphasis added*).

Indeed, in the same FSR, the Bank of England reports that the market for mortgage backed securities and collateralised debt obligations became illiquid:

'BNP Paribas suspended redemptions from three money market funds for two weeks in August because they did not feel they could fairly value their positions...As money market funds had previously been assumed to be low risk, this came as a further adverse shock to investors' expectations. In the absence of reliable information and confidence on the part of both buyers and sellers, markets in ABS largely shut and CDO issuance came to a near halt' (FSR 2007b:19).

The difficulty with pricing credit derivatives remains at the heart of financial stability discourses in 2008. Following the collapse of Lehman Brothers due to this bank being overexposed to credit derivative products, significantly overleveraged and unable to find buyer or bailout agreement with public authorities, the Bank of England argues that:

'valuation uncertainty rose sharply, particularly for more complex products where informational problems were most acute, as end-investors lost confidence in credit rating methodologies' (FSR 2008b: 8-9).

Indeed, 'illiquidity and uncertainty' have 'led to a lack of price discovery, amplifying uncertainty about asset values and mispricing. For example, there remains significant variation and inconsistencies between the prices of US sub-prime RMBS tranches' (FSR 2008b:12). As Nigel Dodd points out, this valuation difficulty is a symptom of money's deterritorialization (Dodd 2014:223).

Going into 2009, and both the intensification of the Global Financial Crisis and the public bailout of distressed financial institutions, the downside risk associated with credit derivatives seemingly reverts further and further towards a concern with the complexity of financial innovation. The textual analysis demonstrates that when the Bank of England is concerned about credit derivatives, the issue is often the perceived complexity of the CDO chains. As Andrew Haldane of the Bank of England argues:

‘Financial innovation often took a particular form – structured credit - with risk decomposed and then reconstituted like the meat in an increasingly exotic sausage. The result was a *complex* interlocking set of claims. With each restructuring of ingredients, the web branched and the dimensionality of the network multiplied... End-investors in these instruments were no more likely to know the name of the companies in their portfolios than the name of the cow or pig in their exotic hot dog’ (Haldane Speech 2009b:16 *emphasis added*).

What I want to argue is it is around this risk associated with credit derivatives- this facet of deterritorialization- that the Bank of England focuses efforts to reterritorialize through a sort of recoding of credit derivatives. With this analysis of complexity taking prime position within the Bank of England regulatory thinking, the post-crisis consensus around credit derivatives is that they need to be more transparent and standardised. As Donald Kohn argues in a 2011 speech:

‘The long chains of claims embodied in the securitization, re-securitization, and derivatives based on securitizations made it almost impossible for people to understand and price the risks they were taking. The complexity of the securities and their risk characteristics meant that the models used to price them were exceedingly difficult to understand... The chains of borrowing and lending made it difficult to trace interdependencies among counterparties and the amount and character of the collateral securing the obligations Transparency about these structures – full information about them readily available to all market participants – is required to protect financial stability. Investors in the instruments and counterparties of those involved in the chains need to have the opportunity to evaluate their risk’ (Kohn 2011a:8).

In 2012, the Bank of England suggests that that:

‘public disclosure of information by financial institutions can contribute to the resilience of the UK financial system’ because ‘transparency enables market forces to act as a disciplining mechanism on individual institutions’ behaviour and enables more accurate pricing of risk within the financial system’ (FSR 2012a:57).

Further, in the second FSR of 2012, it is reiterated that ‘reforms should help to mitigate systemic risk in OTC derivatives markets by improving risk management, reducing interconnectedness and improving transparency’ (FSR 2012b:43).

Alongside transparency, there has also been a limited regulatory movement towards the standardisation of CDOs (Fisher Speech 2012a: 8). This, as Haldane eloquently phrased it, would ‘re-wire the global financial web, transforming it from a dense, complex cats-cradle to a simplified hub-and spoke configuration’ (Haldane Speech 2012b:15).⁴¹ The end-point then would be for a:

‘Financial product mark-up Language (FpML), which is already used in the industry for communications and processes, to provide a standardised presentation of each listed or cleared product... LexiFi is selling a commercial programming language, MLFi, which breaks down financial transactions into their primitive constituents. These elements can be combined using a standardised syntax to describe instruments at any level of complexity. In essence, this approach is an attempt to create a “DNA string” for derivatives’ (Haldane Speech 2012b:12).

The logic of reterritorialization- that is re-organization- seems directly at the surface of speeches and texts which seek to simplify and standardize the complex chains created through credit derivatives transactions. A further and important point highlighted by the chains of structured credit products, and the understanding that there is a continued vacillation between deterritorialization and reterritorialization, is that regulatory thinking on credit derivatives has significant features of assemblage thinking. In other words, credit derivatives involve the contingent fixing together of heterogeneous elements into a provisional whole, which experiences deterritorialization and reterritorialization (Anderson *et al* 2011). An account of credit derivatives as assemblages has a close congruence with the account of financial innovation as ‘bricolage’ given by Engelen *et al* (2011: 51) in which structures are ‘built up by fitting together events’. Indeed, as these authors go onto argue, financial innovation concentrated risk in the centre of circuits, rather than dispersing it through

⁴¹ An interested reader can find this speech at <http://www.bankofengland.co.uk/archive/Documents/historicpubs/speeches/2012/speech552.pdf>

chains (Engelen *et al* 2011 56-63). And certainly, the form of the argument is the same- that risk is not dispersed safely to the risk bearing margins. However, Engelen *et al* appear to underplay the inherently relational nature of credit derivatives that assemblage thinking attends to. Engelen *et al* focus on the 'agency of bricoleurs'- that is to say, agents rather than relational processes (2011: 56). In my account, greater emphasis is placed on the process of re-organization and return through the liability structure of debts associated with these financial products.

5.5. Conclusions

In this chapter I have taken Bank of England statements about CDOs and CDSs as my object of enquiry. Having first highlighted how these financial instruments work, why they are instances of derivatives and what it is they do to risk, the chapter moved onto Bank of England statements about credit derivatives. Statements made between 1998 and 2003 are consistently preoccupied with the potential these derivatives have to diversify risks and complete markets, alongside -and contemporaneous to- a variety of negative risks. The secondary literatures in critical risk studies and heterodox political economy is able to provide a window on these findings. It can be argued, with authors such as Randy Martin (2007) and Louise Amoore (2011, 2013), that market completion is an instantiation of derivative logic. This means that credit derivatives disperse risks to areas most able to bear them. In such a way, credit derivatives work through a logic of deterritorialization. Similarly, authors influenced by firstly Nietzsche, and then Deleuze and Guattari, such as Lazzarato (2012) and Amato and Fantacci (2012), help us to understand the negative risks also mentioned in these Bank of England statements. Credit derivatives involve the bundling and manipulation of debt. Debt relationships, Amato and Fantacci tell us, are underpinned by uncertainty and the risk of default (2012:30). Again returning to dynamic tensions and a Deleuzian lens, the liability structure of distributed and complex chains of debt relationships is a logic of reorganization, stabilization and reterritorialization. This is because the system of credit requires that debt has to be repaid by someone. That these two sides of risk are consistently jointly present can be considered to be a consequence of what Duncan Wigan (2009) describes as the dual performativity of risk. The chapter then returned to the textual analysis of Bank of England Financial Stability documents and speeches charting the position regulators have taken on credit derivatives. Starting from 2003, the analysis finds at first ambivalence towards them, caught between optimism about the diversification of credit risk, and a worry about their valuation. Later, the Bank of England becomes

fixated on the complexity of structured credit products such as CDOs. During the immediate build-up to and emergence of the Subprime Crisis, Bank of England statements become preoccupied with a variety of downside risks, but in particular the ability of financial institutions to accurately price credit derivatives and to know where risk has become concentrated. This is exemplified by the Bank of England emphasizing the significance of BNP Paribas' admission that they cannot price CDOs. This, as Nigel Dodd has argued, is an instance of deterritorialization (2014:223). Regulators initially sought to target liquidity in interbank markets before then reconceptualising the problem as being one of the solvency of financial institutions (Langley:2014: 9-10). Following the height of this crisis, the Bank of England returns its attention to the downside risk of the complexity of financial innovation. The consequence of this is that regulators begin to build support for reforms aimed at improving the transparency and standardization of credit derivatives. I have understood this focus on the re-writing of credit derivatives using a standardized and transparent formula as following a logic of reorganization, stabilization and reterritorialization. I have characterized the Bank's understanding of credit derivatives chains that move along the axis of deterritorialization and reterritorialization as being something akin to assemblage thinking. In the following chapter I focus on Bank of England statements concerning the development and use of a means of measuring market risk- the Value-at-Risk calculation.

Chapter Six: Value- at- Risk: Calculation, Precision and Accuracy.

Financial stability can be thought about using the two primary paradigms of risk in the broad academic literature of security and risk studies. The first of these approaches is a 'sociological account' for which risk is 'viewed within a... narrative of phases of modernity and as a feature of the ontological condition of humans within' the contemporary world (Dean 2010: 207). For this approach, contemporary risks are the 'manufactured...by-products of an industrial machine which needs a new politics to control it' (Hutter and Power 2005:1). In short, it is a principle which characterizes types of society and as such, is an actually existing global entity (Dean 2010:207). Accounts such as Giddens (1998) and Watson (2007), are situated in the tradition of Ulrich Beck's *Risk Society* (1992). On this approach, risk is characterised as a very real threat to financial stability. Within this 'financial risk society' (Watson 2007: 62), the unprecedented and traumatic stock market crash of 1987 could be taken as an example of the manifestation of the many and varied material risks associated with investing and trading securities.

The second overarching approach to risk is anchored in a critical body of scholarship for which 'risk cannot be isolated as a tangible entity or event' (Amoore 2013:7). Instead, financial stability and 'risk management are performative', rather than descriptive, 'because the way organizations depict their risks has a significant effect on the way they will, eventually, react to events and to other actors...(and) an influential risk management system will bring about institutionalised patterns of risk embodiment (Millo and Mackenzie 2009: 639). To return to our example of the 1987 Stock market crash, this event prompted the emergence of techniques such as Value-at-Risk as 'a key risk management tool in financial firms' (Haldane Speech 2009a:3). For this overarching approach to risk, such financial stability technologies and techniques are a way of governing future events in the present.

As we saw in the previous chapter, for authors such as Randy Martin (2007) and Louise Amoore (2011, 2013), the security logic of credit derivatives is largely premised on being a technique for governing the future, in the present. Future financial stability is therefore made actionable by present techniques. And, for the technique of credit derivatives, financial stability is acted on and enacted as market completion in credit markets. Another technique that came to prominence at the end of the twentieth century, as a second way of making the future actionable in the present, was the use of Value- at-Risk (VaR) calculations. This technique was first developed and deployed by financial institutions such as J.P. Morgan to measure market risk (Goodhart *et al* 1998).

During the mid-1990s to mid-2000s, VaR became a significant part of financial governance through changes in the rule of the Securities and Exchange Commission in the United States and later its incorporation into the Basel II capital accord. Importantly, VaR acts on and brings forth a distinct formulation of financial stability, the idea that stability can be achieved by each institution managing its own level of market risk independently.

The contours of the chapter are fourfold. Firstly, I provide an exegesis of how Value-at-Risk works before turning to analysis of my financial stability archive. Secondly, I present the case that when Bank of England publications are analysed, it becomes clear that while it was a standard of accuracy which initially drove the adoption of VaR, this standard is later disavowed in response to sustained criticism of VaR in the early 2000s. This critique of VaR held that it actually served to increase market volatility by leading to the widespread and simultaneous cutting of positions. This I characterize as a critique of the deterritorializing facet of VaR.

While initially the Bank of England does not respond to this critique, it later does defend the use of VaR in 2002. The third section provides examples from the archive that the Bank of England modifies a discourse so that in order to justify continued use of VaR, there has to be a subtle yet significant shift in the standard regulating the use of VaR. Through these intertwined processes the Bank of England seeks to engender a shift in the epistemic standard applied to VaR, from a standard of accuracy to a standard of precision. Due to the role of an article in FSR 2002b written by Philippe Jorion, I have analysed this shift as hinging on a public facing economist acting as a technical expert. The shift to precision is made through appeal to 'smoothing mechanisms' in the Basel version of VaR. The Foucauldian (1972:194) idea of a fragmented shift in a discursive field is a second analytical tool with which to interpret this occurrence.

Fourth and finally I make the case that despite this shift to precision, and according to Bank of England statements, the extreme events of the Global Financial Crisis undermined the assumption of normality with the VaR calculation. And from this point of view, the inaccuracy of this assumption created a regulatory blind spot, an ignoring of extreme macroeconomic conditions. Here then, we see a renewed criticism of the accuracy of VaR and a second moment in which Bank understandings of VaR must encounter deterritorialization. Further, here the Bank of England does take on board this critique of VaR.

6.1 A Primer in Value-at-Risk

Although there are approximately 200 technical finance manuals explaining VaR, there is a very small social and critical studies of finance literature on this calculative instrument. Michael Power has written about VaR in the context of risk management in organizational life and documents the emergence of VaR through J.P Morgan's introduction of the *RiskMetrics* approach to calculate and standardize capital at risk across an organization (Power 2007:71-73). VaR tells a trader or institution what losses are probable from a particular set of trading conditions under normal circumstances. So, to use Pablo Triana's example:

'a one-day 95 percent VaR of \$50 million' means that a firm 'would be expected to lose more than \$50 million only 12 day's out of a year's 250 trading days' (Triana 2012: xi-xii).

It was in the mid-1990s that public policy and governance entered the equation. This was a result of changing perceptions about 'the potential for technology to support the applications of finance theory, challenges to regulatory conservatism and an 'institutional climate of financialization' (Power 2007:72).

Andrew Baker argues that for a substantial period, financial stability was promoted through a view that the private and individual pricing of risk would determine aggregate risk (Baker 2013a: 115). As such the calculative device of Value-at-Risk first emerged as a measurement tool 'inside dealing floors' to ascertain the level of market risk associated with specific trading decisions (Triana 2012: xv). As Gillian Tett argues in *Fools Gold*, VaR was presented as 'a credible internal code of conduct' (Tett 2009: 39).

For Power, 'the significant change' occurred in 1996 when the Basel Committee moved towards the formalization of a philosophy whereby 'banks regulate capital according to their own models, subject to regulatory oversight' (Power 2005:581-582). During this period, VaR came to take 'a degree of prominence' within the regulatory community...including through the design and implementation of Basel II' (Haldane Speech 2009a:4). In 2004, the Securities and Exchange Commission in the United States formally adjusted its 'net capital rule' and agreed that VaR could be used to calculate the 'costliness, affordability and leverage of trading positions' (Triana 2012: xxxiv). As Power acknowledges, the story of operational risk was still unfolding and although he does mention power and address definitional contestations and struggles over 'collection paradoxes

and calculative ideologies', he does not do so in a way that problematizes what finance is (Power 2005: 595).

Pablo Triana, almost certainly the most outspoken and vehement critic of Value at Risk, criticizes VaR's unrealistic assumptions that market conditions will be normal, that past data can indicate future losses and the dubious reliance on the statistical concept of correlation (Triana 2012: xi-xii). For Triana, VaR's tendency to understate risk makes it at the very least a main contributing factor and, at worst, the lead culprit in the subprime crisis of 2007 because it allowed the accumulation of dysfunctional assets on bank balance sheets. While Triana has the power of financial institutions in his sights in his critique of VaR, there is little sensitivity to the qualitative changes in the discourses around VaR. For Triana, discourses are inseparable from material interests and are either 'for' or 'against' VaR. This misses out some of the subtleties of the debate which can be brought to attention by a critical and analytical approach to discourses about probabilistic risk measures such as VaR.

6.3. Bank of England Enunciation: The Relationship between VaR and Accuracy

What detailed archival research into VaR reveals, is that when we study the adoption of technical devices financial economics for regulatory purposes, the idea of different epistemic standards is salient. By epistemic standards I refer to the epistemic rules or 'grammars' that operate within a particular technical discipline at a particular time (Amoore 2014: 3-4).⁴² The contemporary relationship between science, mathematics and finance is important here (de Goede 2001). In other words, there are different standards or 'grammars' of knowledge at play in different instances. For example, the first empirical chapter outlined that: 'the lack of a scientific pricing method has never been a deterrent to trading (BBA, 1997)' (Goodhart *et al* 1998:94). Similarly, a discussion of setting a level for capital adequacy ratios in a financial stability report reveals that 'we should of course be under no illusion that the ratios chosen in 1988 were arrived through a scientific process' (FSR 2000b:155). These two historical and textual examples serve to illustrate that a true value does not always need to be produced in the sense of scientific standards of knowledge. In this section I focus on the role of accuracy in early Bank of England statements concerning Value at Risk and the measurement of risk.

⁴² Here Amoore (2014:3) reads Wittgenstein's comments on the 'grammar' of mathematics, namely the way in which number is assembled in a calculus so as to make things possible or to have effects in the world.

While I must clarify that I am not arguing that financial risk management developed in a linear fashion, I do want to argue that a standard of accuracy was historically important for the widespread use of VaR (Millo and Mackenzie 2009: 640). Alongside this we could also add efficiency (Triana 2012: xxxiii), and usefulness, as other important factors in the proliferation of VaR before the Subprime Crisis. However, a wide range of Bank of England documents supports Gillian Tett's assertion that originally 'VaR was primarily concerned with measuring market risk' (Tett 2009: 58).

Whilst in 1997 there is an admission that the Bank of England is 'not yet convinced that risk management has evolved sufficiently to capture all elements of specific risk in an empirically-proven manner', the Bank is 'ready to review promptly if and when the industry can provide convincing evidence that specific risk is being modelled adequately' (FSR 1997a: 80). In this period the Bank seems very open to the contribution finance has in developing regulatory techniques.

Only a little later, trading activities and markets are evaluated in terms of the level of VaR in the respective markets. This allows risk to be measured, 'recognised' and probability assigned to it (Clementi speech 1999a 3). In such a way, the Bank of England now takes the position that it is possible for risk to be 'captured accurately' and with 'greater sensitivity', so that 'if risks appear to be higher than the capital set aside to back them... or whether a higher figure is needed' (Clementi Speech 2001b:3). Consequently regulators hope to 'align regulatory capital more closely with the underlying risks' (FSR 2001a:99-100). The Bank of England is thinking here in terms of 'the actual riskiness of different loans' (FSR 2001b:124).

The Bank of England also writes about VaR in terms of accuracy. The comparison between sensitive VaR models against 'clumsy' capital risk weightings 'with no allowance for the benefits of diversification across markets' (FSR 1997b: 4). It can also be found in Bank of England documents that there suggests a difference in terms of an accuracy which does not ignore differences between firms or understate the risk that is 'actually being taken' (FSR 1997b:6). Other choices of language imply that both risk and capital ratios can be measured in a way that arrives at a true value. In this way 'accuracy' (FSR 1999a: 94), 'misstating' (FSR 1998b:75), and 'distorting' (FSR 1999a: 94) imply deviation from a 'true' value.

The first step in the epistemic standard of accuracy is a realism about risk, in which claims are made about there being ‘actual riskiness’ or ‘actual risk’. This provides a foundation for the use of VaR as a proxy or measurement of market risk exposure and market risk in trading activities, which frequently happens in FSRs. For example, the following was written during a period in which the bursting of the dotcom bubble and the collapse of LTCM brought market risk to prominence:

‘Average value at risk (VaR) – the maximum amount which, on the basis of relatively recent price movements and within a specified level of confidence, an institution would expect to lose on its positions over a given trading period – generally declined for the trading books of major US securities firms between annual reporting dates in 1999 and 2000 (Chart 166 in Section VIII). Given that volatility of many markets in 2000 was relatively high, lower reported VaRs suggest that securities firms might have reduced the size of their market risk positions’ (FSR 2001a: 65).

Similarly, in the second FSR of 2001 VaR is seen as a clear proxy for market risk:

‘As measured by average Value-at-Risk (VaR) as a proportion of shareholders’ funds, market risk in trading activities was higher for a number of LCFIs in H1 2001 than in 2000, perhaps partly because of higher historical volatility in financial markets. But, according to published data, exposures remained a fraction of shareholders’ equity and below 1999 levels. Since then, market participants, taken as a whole, appear to have avoided large trading losses in spite of the large movements in some prices since 11 September’ (FSR 2001b:82).

Moving forwards three years to 2004, we can find further evidence of this link between VaR and market risk when the Bank of England argues that:

‘Market risks typically reside in both the ‘trading’ or ‘banking’ books, a distinction used by banking regulators. Trading book positions are in principle marked to market frequently (although it is sometimes necessary to ‘mark to model’ in the absence of liquid markets). By contrast, market risk in the banking book is not accounted for on a mark-to-market basis. In practice, when interpreting banks’ disclosures it can be unclear whether some financial instruments are located in the trading book or elsewhere. Proposed changes in accounting standards may resolve this, which would be welcome. Trading book assets of

most large UK-owned banks account for around 10% of total assets. As measured by average value-at-risk (VaR), in most cases market risk in these portfolios decreased marginally during 2003 (Chart 96). Trading book VaRs were also relatively small as a percentage of capital and of average quarterly earnings. Interest rate risk makes up around two thirds of large UK-owned banks' VaR. Foreign exchange, equity and credit risk make up the majority of the rest.

(FSR 2004a: 68)

Millo and MacKenzie credit Michael Power (2007) with the insight that the growth of risk management in the last two decades is related to a *'gradual convergence between risk calculation and risk management'* (Millo and MacKenzie 2009). For Millo and MacKenzie, the shift from 'descriptive knowledge (risk calculation) into (practice-oriented) risk management' would have the consequence of organizational actors that gradually shift resources towards communicating and coordinating action and pay relatively less attention to merely calculating risk levels' (Millo and MacKenzie 2009: 639). The idea then, is that usefulness, for example making communication clearer, becomes a more significant factor in model based risk management than accuracy alone. What I want to do here is to problematize this 'gradual convergence', and focus on a significant transformation in the technique of VaR, and how this was dealt with in an inventive and imaginative manner.

6.3.1. 1998 and a First Stage of Deterritorialization.

As we have already seen, VaR was developed as part of JP Morgan's *Risk Metric* and championed as an internal code of conduct within the investment banking industry (Tett 2009). The decision to incorporate VaR into legislation such as the 'net capital rule' of the Securities and Exchange Commission meant that effectively, investment banks were governing the costliness, affordability and leverage of (their own) trading positions' (Power 2005:581-582; Triana 2012: xxxiv). Fundamentally then- and in Deleuzian terms- VaR is an attempt to measure, stabilize and reterritorialize. In this section I document the first stage in which the Bank of England encounters critical and negative understandings of VaR following the device's widespread adoption.

In 1999- very soon after the Asian Financial Crisis- the Bank of England is relatively uncritical of the role of VaR in the global economic turbulence around this particular crisis, as VaR is still described as 'almost the industry standard measure' (FSR 1999a:130). And then in 2000 both FSRs have very little to say about VaR (FSR 2000a/b). Against this, the argument forward by Pablo Triana, and earlier Donald MacKenzie, is that widespread use of VaR would lead to *en mass*- cutting of positions when VaR was breached, and therefore contribute to market volatility. More critical scholars of finance, such as de Goede (2001), discuss the case of Long Term Capital Management (LTCM) and the role of VaR in the collapse of this hedge fund in 1998.

By the early 2000s the Bank of England acknowledges the critique of VaR as it reports that critics, 'such as *The Economist* newspaper', argue 'that VaR-based capital requirements experienced sharp increases during the Summer of 1998, leading to forced position cutting and increased volatility' (FSR 2002b:123). According to Donald MacKenzie, the 'events of 1998...suggest a reflexive loop that is counterperformative rather than performative' because VaR brought about the instability it was seeking to avoid (MacKenzie 2005:186). In other words:

'When a VaR limit is breached, traders are typically asked to cut down positions (by risk managers) until their exposure (to risk) is reduced back below their VaR limit. In a quest to reduce risk, traders are forced to sell some of their portfolio into the market. If many firms do this concurrently, massive volatility and crashing prices may rapidly ensue...the end result: massive liquidations leading to additional massive liquidations (as VaR gets breached over and over again) causing huge losses and potentially a system wide breakdown' (Triana 2012:29).

If VaR is an attempt to stabilize financial trading then this featured is enmeshed with deterritorialization. This is because the widespread adoption of a regulatory calculation can be understood to have three deterritorializing effects. First, and as the above authors identify, simultaneous cutting of positions through use of the same model can increase market volatility. Second, and this is the main argument of Triana's (2012) book, that financial institutions supported the regulatory use of VaR because they knew how to manipulate it. Third, if all market participants use the same model, then all participants are equally blind to what the model is blind to, leading to systemic vulnerability. I will go onto make the case that in 2002 the Bank of England engages with the first critique of VaR, but argues against this critique being valid. . Later, and following the Global Financial Crisis, the Bank shares the same understanding as the third critique of VaR

The argument I am forwarding in the following section is that, when faced by the allegation that volatility destabilization was caused by VaR, the Bank of England made an important rhetorical move to justify continued use of VaR- it disavowed the calculative device's own accuracy. In the following section I work with Foucault's archaeology of 'discursive formations' to think about a 'fragmented shift'. This allows a dominant discourse, such as that surrounding and supporting the use of VaR, to mutate without having its dominance superseded. Crucial for this reading of an intervention by the Bank of England is an article by Professor Phillippe Jorion in FSR 2002b, entitled 'Fallacies about the effects of market risk management systems.'

6.3.2. The Epistemic Shift as a Moment of Reterritorialization

At this point it can be asked, what is a form of economic governance that disavows its own accuracy? The answer I forward here is that in Deleuzian terms, the technique of VaR had to be seen to be stabilizing. . In this section I work with Foucault's⁴³ archaeology of 'discursive formations' to think about a 'fragmented shift'. This allows a dominant discourse, such as that surrounding VaR, to mutate without having its dominance superseded. In terms of the Bank of England document as a discursive transformation, it is argued in *The Archaeology of Knowledge*⁴⁴ that:

'What is important then, is an attention to the way that the tranquillity with which they (discourses) are accepted must be disturbed; we must show that they do not come about of themselves, but are always the result of a construction the rules of which must be known and the justification of which must be scrutinized: we must define in what conditions and in view of which analyses certain of them are legitimate; and we must indicate which of them can never be accepted in any circumstances' (Foucault 1972:28).

Foucault then seizes upon the way that dominant fields of discourse, such as 'philology... mutate' and are profoundly affected... without the 'positivity of philology ever being put into question' (Foucault 1972: 194). In the words of Foucault, this is in the first instance a 'single system for the formation of statements' and, in the second case, a standard for knowledge (Foucault 1972: 206).

⁴³ For Deleuze, Foucault is the philosopher par excellence of reterritorialization (Deleuze 1994: 186).

⁴⁴ It is important to note the Deleuze reflects on the 'theory of discourse' in the *Archaeology of Knowledge* as being the concept from Foucault that influenced him the most (Deleuze and Parnet 2000).

For Foucault, the variety of thresholds he believes he has discovered in discourse obey no hard and fast rules. They have irregular chronologies and discursive formations do not cross thresholds at regular intervals (Foucault 1972: 206).⁴⁵ In FSR 1999b (138), the Bank of England reports that ‘*CreditMetrics* and the other Merton-style models...accurately estimate Value at Risk for portfolios of US dollar denominated international bonds over rolling twelve month periods between 1988 and 1998.’ The study is somewhat negative in its conclusions since ‘the models used in the study yield far more ‘exceptions’ than they would if they were accurately measuring risk’. Here, then, the Bank of England is already to starting to shift the terms of engagement away from the accuracy of VaR (FSR 1999b:138). The important document for this interpretation of a fundamental shift is one of the Jorion penned chapter of FSR 2002b⁴⁶ because the article in question purports to show that:

‘Capital requirements should be constructed so as to be reasonably ‘smooth’ over time, be they for market or credit risk. This fact has escaped most of the literature on Value-at-Risk, where the focus has been near-exclusively on developing accurate 1-day volatility forecasts. One notable exception is Christoffersen and Diebold (2000), who show that there is scant evidence of predictability of volatility at horizons longer than ten days. Other important objectives, beyond accuracy, are the average level of capital as well as fluctuations in capital requirements’ (Jorion, FSR 2002b:116).

Jorion signals a shift from accuracy to one of precision because, he argues, there are other ‘important objectives beyond accuracy’ (Jorion, FSR 2002b:116). Later it is argued that ‘the quest for accuracy in VaR measures, which would dictate fast-moving systems, should take second place to stability in the market risk charge’ (Jorion, FSR 2002b:125). Calculations are drawn up and completed, data is plotted into graphs and lines are drawn. It is the comparison between the lines within charts 4 and 5 in Figures 11 and 12 which is crucial to explaining the precision brought about through the market risk charge of the VaR calculation used in Basel II. Further still, in this document, the different VaR calculations (Basel Market Risk Charge and Daily VaR) are included and have a role to play (see Figures 10 and 12). The discursive transformation set out by Jorion lies with the

⁴⁵ The caveat here is that I am reluctant to subscribe to an archaeology which posits quasi-structural formation rules rather than a description of historical conditions which connect ‘rules’ such as the technical grammar of accuracy as ultimately imbricated in the relationships between power/knowledge and truth/subjectivity. These grammars are themselves contingent and open to the exercise of power.

⁴⁶ This key document can be accessed at:

<http://www.bankofengland.co.uk/archive/Documents/historicpubs/fsr/2002/fsrfull0212.pdf>: pp 115-127.

'smoothing mechanism' that Jorion finds in the Basel Market Risk Charge. Capital and risk calculations using the Basel model of VaR are 'not volatile' (as alleged), but 'smooth'. This is important, because it prioritizes 'a capital charge based on an average over 60 days', rather than accuracy' (Jorion, FSR 2002b:116,126).

Quite literally, the transformation in interpretation of a set of data is drawn from 'P Jorion's calculations' (Figure 12). The transformation derives from the technician's ability to calculate, interpret data and make inferences, (i.e. the graphs showing 'smooth' curves for the capital charges under the Basel version of VaR), and to explain the significance of this data. Capital and risk calculations using the Basel model of VaR are not volatile (as alleged by VaR's critics), but smooth. Jorion's interpretation is the 'authentic' interpretation of the data, as opposed to the 'fallacies' which are his target in this part of the FSR. The display of the calculative process and use of data that Jorion provides establishes the authenticity of this technical experiment. The lines on the graph contribute to the epistemic shift, because the smoothness of these lines is at stake in the moving of the epistemic standard away from accuracy to precision (Figures 11 and 12). The stability sought for then, is a case of achieving the same results given the same inputs. This differs somewhat from the idea that the intended target is being recorded. In other words, this is a matter of reliability or precision, rather than accuracy. This follows Lorraine Daston's general point about scientific practices- that other admirable methodological qualities are just as desirable as accuracy (Daston 1995b:8; Amoore 2013:67; See Langley 2014:166).

The Market Risk Charge is then computed as the higher of the previous day's VaR, or the average VaR over the last 60 business days, times a 'multiplicative' factor k :

$$MRC_t = \text{Max}\left(k \frac{1}{60} \sum_{i=1}^{60} VaR_{t-i}, VaR_{t-1}\right) \quad (2)$$

where k is to be determined by local regulators, subject to an absolute floor of 3²¹.

Apparently, the effect of these rules on the MRC has not been fully appreciated. This is the first paper, to our knowledge, that specifically analyzes the time-series behavior of the market risk charges. By now, there is an enormous literature on VaR, derived from statistical time-series techniques that narrowly focus on 1-day VaR accuracy issues²².

Here, two smoothing mechanisms are involved. The first is the requirement that the model be based on at least a year of historical data. More precisely, the 'average life' of weights on past observations must be at least six months. This requirement can be traced to the observation of Jackson et al (1997) that short windows can lead to inaccurate VaR. But, as we will show, this requirement also has the effect of creating VaR measures that are very stable over time. The second mechanism consists of taking the average VaR over 60 days.

Modelling daily VaR

Let us examine first the requirement of a minimum window for computing daily VaR numbers. With the historical-simulation method, the window must be at least one year. Requiring at least 250 days seems reasonable as this would yield an expected 2.5 observations in the left tail. But then, as shown by Pritsker (2001), the VaR risk forecast will not be very responsive to changes in recent volatility, due to the fact that each observation in the 250-day window has a relatively small weight of 1/250. We need to have several observations below the previous quantile to start moving VaR measures.

Alternatively, consider parametric VaR models based on the standard deviation. Such models can

accommodate time-variation in risk more easily. More recent models mix historical simulations with parametric volatility modeling²³. Consider, for instance, a simple RiskMetrics-type Exponentially Weighted Moving Average (EWMA) forecast. The conditional variance forecast is:

$$h_t = \lambda h_{t-1} + (1 - \lambda) r_{t-1}^2 \quad (3)$$

where λ is the decay factor and r the rate of return on the asset.

With a dollar position of W_{t-1} , VaR can be computed as $VaR = W_{t-1} \times 2.33 \sqrt{h_t}$, at the 99% level assuming a conditional normal distribution. This could be extended to other parametric distributions, however, with a different multiplication factor.

Replacing recursively, this yields geometrically declining weights

$$h_t = (1 - \lambda) [r_{t-1}^2 + \lambda r_{t-2}^2 + \lambda^2 r_{t-3}^2 \dots] \quad (4)$$

The average life is the weighted sum of number of days

$$\sum_{i=1}^{\infty} i \times [(1 - \lambda) \lambda^{i-1}] = 1/(1 - \lambda) \quad (5)$$

For example, the average life of the RiskMetrics model with $\lambda=0.94$ is 16.7 days, or 0.067 years, assuming a 250-day year. This is not allowed under the Basel rules, however. We need λ to be at least 0.992 to achieve an average life of half a year. Alternatively, banks could use a moving average over one year, with equal weights within the window

$$\hat{h}_t = \frac{1}{250} \sum_{i=1}^{250} r_{t-i}^2 \quad (6)$$

Chart 3 and Chart 4 compare the evolution of daily VaR models for the DM/US\$ rate since 1980. First, note that the historical-simulation model generally yields a higher 99% VaR than the other models. This reflects the well-known observation that daily financial series have tails fatter than the normal²⁴.

In Chart 3, the EWMA with $\lambda=0.94$ is indeed very volatile, due to the higher weight on recent data. This

21: Ignoring the specific risk charge, which is explained in more detail in the Basel Amendment (1996).

22: See Hendricks (1996), Jackson et al (1997), Christoffersen (1998), Lopez (1999), among others.

23: See for instance Boudoukh et al (1998) and Hull and White (1998).

24: See Hendricks (1996).

Figure 10: Jorion Article (a)

is not relevant, however, since such fast-moving models are not allowed under the Basel rules. Chart 4 shows that the normal-MA model based on a moving window of 250 days is much smoother. The historical-simulation method is more volatile, but still much smoother than the EWMA model with decay of 0.94. Finally, the EWMA with $\lambda=0.992$, which is the minimum decay allowed under Basel rules, is nearly as smooth as the normal model.

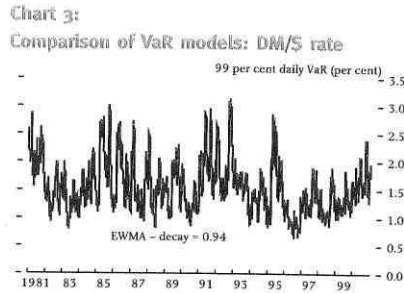

Source: P Jorion's calculations.

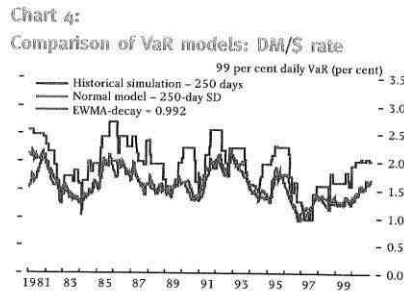

Source: P Jorion's calculations.

The fact that banks are constrained to use slow-moving VaR forecasts explains the finding by Berkowitz and O'Brien (2002) that banks' VaR forecasts can be beaten by a simple GARCH model applied to the history of P&L. At first sight, these findings are surprising since GARCH models have no information on changing positions. One interpretation is that "these results may reflect substantial computational difficulties in constructing large-scale structural models of trading risks for large, complex portfolios". Another interpretation, however, is that the banks' structural models are simply hamstrung by the Basel requirements. And, this may be a rational outcome since the purpose of these VaR

models is to produce a smooth capital requirement and not necessarily to measure next day's risk with utmost accuracy.

Which VaR is binding?

The market risk charge is composed of the maximum of two terms. Which of these terms in Equation (2) will be binding? The first term, which is three times the 60-day average, will in general be higher than yesterday's VaR, and thus will be binding. The bank would have to experience an enormous increase in the previous day's VaR for it to become the dominant factor.

To see this point, assume that VaR is stable at VaR_0 for the last 60-day period, except for a spike on the last day. The second term in Equation (2) will be binding when

$$VaR_{t-1} > 3 \frac{1}{60} [VaR_{t-1} + 59VaR_0] \quad (7)$$

which implies

$$VaR_{t-1} > (3 \times 59 / 57) \times VaR_0 = 3.11 \times VaR_0 \quad (8)$$

This could happen in one of two ways. Assuming stable risk factors, this could be achieved if the exposure W_{t-1} , or size of positions, is multiplied by a factor greater than 3.1. Alternatively, with constant exposures, this could also be achieved by an increase in the volatility of risk factors $\sqrt{h_t}$. The latter is much less likely, however.

Table 2 displays the required latest return, expressed in terms of volatility, such that the second term is binding, for various values of the decay parameter for the EWMA model, as well as the 250-day MA. Lower values for λ imply greater weight on the last observation. Hence, a smaller movement is required for the latest observation to be binding.

Table 2:
Required return for last VaR term to be binding

Model	EWMA, Decay (λ)					MA 250 days
	0.92	0.94	0.96	0.98	0.992	
Parameters	0.92	0.94	0.96	0.98	0.992	250 days
Required return	10.4 σ	12.0 σ	14.7 σ	20.8 σ	32.9 σ	46.5 σ

Source: P Jorion's calculations.

The table shows, for instance, that with $\lambda=0.94$ we require a shock twelve times the daily standard deviation. This happened only once in our equity and currency sample, during the crash of October 19, 1987.

Figure 11: Jorion Article (b)

movement of 32.9 times the standard deviation for the latest VaR to be binding. With a simple moving average over the last year, the required move implies a factor of 46.5. It is highly unlikely that an exogenous shock to volatility could induce yesterday's VaR to be binding. Therefore, in what follows, we will assume that the market risk charge is driven by three times the average VaR. This is not to say, however, that the second term in the market risk charge is useless. It serves to catch banks that suddenly increase their positions.

Evaluation of the Basel market risk charge

The contention is that VaR-based capital requirements experienced sharp increases during Summer 1998, leading to forced position cutting. The question is: how did the increased volatility of financial markets affect the Basel capital requirements?

Chart 5 displays movements in the market risk charge for a fixed position in the exchange rate between the dollar and the DM (now the euro). Note how smooth the lines are compared to those in the previous graph. This is due to the averaging over the last 60 days. The figure does not include the normal-EWMA model with decay of 0.94 since it is not allowed. The graph shows no evidence of sharply higher market risk charge during 1998. The fluctuations in market risk charges in 1998 are actually lower than over the rest of the sample period.

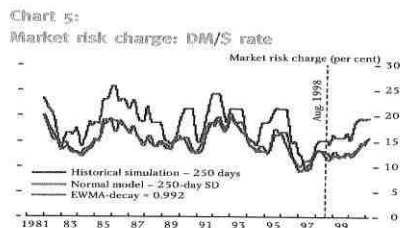

Source: P Jorion's calculations.

One could argue that volatility was confined to other markets, however. So, we turn to US equities. Chart 6 plots the MRC for a fixed position in US stocks. There is some evidence of an increase in the MRC during 1998, but not out of line with the history of the last 20 years.

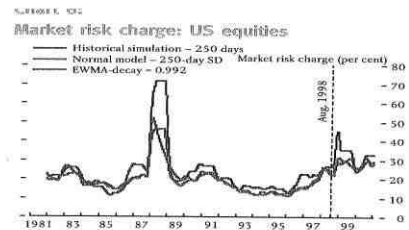

Source: P Jorion's calculations.

Chart 7 gives more detail for 1998. The graph shows that the increase in the MRC was very slow. It was barely noticeable for the normal model with a 250-day MA and for the EWMA with decay of 0.992. There is a greater increase for the historical simulation method, but due to the averaging process, the MRC only reaches a peak by the end of November, by which time the crisis was over.

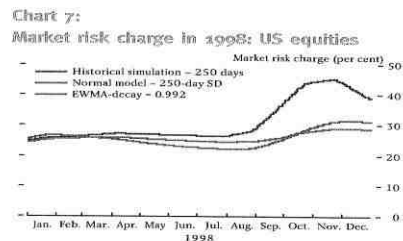

Source: P Jorion's calculations.

Finally, Chart 8 plots the MRC for a short position in 10-year Treasury notes. Again, there is no evidence of sharp movements in the MRC for the HS and MA models. While the 1980s were much more volatile than the 1990s for Treasuries, 1998 was certainly not an eventful year in terms of the Basel market risk charge. In conclusion, it seems inappropriate to blame increases in VaR models for position cutting.

Objective functions for VaR models

The previous section indicates that smoothness in the VaR-based capital charge is a desirable property. This has been largely ignored in the VaR literature, which has focused on purely statistical issues such as bias and bunching.

Figure 12: Jorion Article (c)

In such a way, 'enunciative modalities' of institutional sites and subject positions can be associated with bureaucrats or economists (Foucault 1972:56-57). Public facing economists are becoming more and more prominent (Mata and Medema 2013), and here I think it is possible to view such economists as technical experts in the contemporary age (See Miller and Rose 1990). Academic

economists such as Ben Bernanke and Paul Krugman have both a prominent role and high profile in public life, be that through sovereign institutions such as the Federal Reserve, media profile, or some combination of the two. As Graham Smart has it, economists in the (central) Bank of Canada ‘collaborate in creating specialized written knowledge and apply ‘this knowledge in formulating and implementing’ public policies (Smart 2006: 7). Central bank economists then play a role in promulgating an ‘economy of words’, by negotiating the tension between statements designed to format the economy, with how the statements play out in the wild of a national economy (Holmes 2014).

It is important to acknowledge that this is not the only account of economics as a technical discipline. Conceptualising this as a modality of knowledge provides an extension of existing scholarship in the social studies of finance (SSF). So, as already encountered, Millo and Mackenzie focus on the idea that usefulness can be as important to sustain an inaccurate model (Millo and Mackenzie 2009). However, this does not quite sit right in this situation. Given that it can be levelled that VaR allowed the accumulation of toxic assets on bank balance sheets, it does not seem appropriate to say that VaR is useful. If anything, and as we will see, it is the drive towards usefulness that sees the Bank of England shift the focus of VaR usage from accuracy to precision. Usefulness, in terms of bringing about the feature it names, is therefore normative rather than descriptive when thinking about VaR. Similarly, Langley, drawing on the history of science, argues that it is a positive affective charge which then sustains the performative force of precise techniques (Langley 2013b:55, 67). However, what I am specifically interested here is the process, rather than the effect. So rather than asking why governance might disavow its accuracy, the matter at hand is how and using what techniques is the Bank able to do so.

Alternatively, other SSF authors such as Mallard (2007) and Holmes (2013), themselves drawing on the history of science, conceptualise ruptures in techniques as ‘experiments.’ This is a promising line of enquiry, because it acknowledges the technical modality of expertise present in central banking (Holmes 2014). Here it becomes clear that ‘the significance of an experiment never lies only in the technical achievement of the test itself’ (Mallard 2007: 157). Aspects such as design and the social practices used to disseminate results are also pertinent to the financial stability reporting of the Bank. For Miller and Rose (1990), the governmentality of economic life has increasingly involved experts, expertise and expert knowledge. As such, governance from the sort of distance one would expect from a central bank has come ‘to rely on in crucial respects upon ‘expertise’: ‘the

social authority ascribed to particular agents and forms of judgement on the basis of their claims to possess specialized truths and rare powers' (Miller and Rose 1990:2). As they phrase it nicely, expertise is a 'complex amalgam of professionals, truth claims and technical procedures' (Miller and Rose 1990: 8). This, however, still does not adequately capture the logics at play in the relevant Bank of England publications. In this chapter I have attempt to unpack the black box of expertise to see how it functions within public policy. In particular, Foucault captures this operation of power or reterritorialization when he says that:

'but as the establishment of a relation, in medical discourse between a number of distinct elements, some of which concerned the status of doctors, others the institutional and technical site from which they spoke, others their position as subjects perceiving, observing, describing, teaching etc. it can be said that this relation between different elements...is effected by clinical discourse: it is this, as a practice, that establishes between them all a system of relations that is not really given or constituted a priori; and if there is a unity, if the modalities of enunciation that it uses, or to which it gives place are not simply juxtaposed by a series of historical contingencies, it is because it makes constant use of this group of relations' (Foucault 1972:59).

I am consequently treating this article in FSR2002b by Jorion, and the system of relations bound up with it, as a 'threshold of positivity'⁴⁷ (Foucault 1972: 193). Taken together are a system of distinct elements such as professional status of Professor Jorion, the institutional site of the central bank, and the calculating subject. In the final section of this chapter I draw on FSR statements and comments by Andrew Haldane to make the case that the Bank raises issues with the assumptions of normality in the VaR calculation. This I interpret as a moment in which Bank understandings of VaR coalesce around deterritorialization.

6. 3.3. A Second Deterritorialization: Global Financial Crisis.

While this subtle shift in the regulatory discourse help to reterritorialize and sustain the use of VaR throughout the first half of the decade, critical attention soon returned to the accuracy of the

⁴⁷ In which a discursive system is transformed.

calculation. In the period prior to the Subprime Crisis, the Bank of England raised issue with the accuracy of the statement of risk by the model:

‘As noted in previous FSRs, disclosed Value-at-Risk (VaR) measures have remained relatively stable in recent years while the trading revenues of the major UK banks and LCFIs have risen strongly. One explanation for this is that current measures of VaR may be understating risk due to the combined effects of their largely backward-looking nature and the recently benign financial market conditions. This highlights the need (which is recognised by most financial firms) to examine VaRs under stressed market conditions’ (FSR 2007a:33).

The following year the Bank of England reiterates the point that the estimation of market risk may well be too low because:

‘Backward-looking models take time to respond to sudden changes in market conditions. This can be true of models used for pricing assets, but also those used to manage market risk. As noted in previous Reports, in benign financial conditions, Value-at-Risk models may understate the risk that is actually being taken. These models are based on estimates of the volatility of asset returns and the correlations between them. A change in either of these estimates can have a considerable impact on a firm’s Value-at-Risk. This highlights the importance of using forward-looking stress testing, with sufficiently severe scenarios, in assessing market risk’ (FSR 2008a: 47).

The events of the Subprime Crisis, and subsequent global financial crisis, revealed two significant developments involving the risks associated with credit derivatives. Firstly, systemic risk became concentrated at several large financial institutions, in particular insurance giant AIG, which had become drastically overexposed to credit default swap contracts. Secondly, risks that were being taken by financial institutions were seriously under-priced. Following BNP Paribas’s abstention from CDO trading due to the difficulty with pricing its positions, anxiety in credit markets threatened to undermine the fragile and uncertain circulations of global finance which supported advanced liberal societies and lifestyles (Langley 2013a). Due to the series of problems that emerged in this period, it became widely recognised that on its own, VaR is unable to account for high-impact/ low probability events, so called tail-risks. As Andrew Haldane (2012c:16) notes:

“The simplicity of VaR has led to its ubiquitous use in finance (Jorion (2006)). But VaR suffers a fatal flaw as a risk management and regulatory measure: it is essentially silent about risks in the tail beyond the confidence interval. For example, even if a trader’s 99% VaR-based limit is \$10 million, there is nothing to stop them constructing a portfolio which delivers a 1% chance of a \$1 billion loss. VaR would be blind to that risk and regulatory capital requirements seriously understated.

Worse still, the fatter the tails of the risk distribution, the more misleading VaR-based risk measures will be. Consider holding a portfolio of world equities and, based on data from 1693 to 2011, calculate the VaR. The 99% VaR assuming the data are normal gives a loss of \$6 trillion at today’s prices. Using the actual data raises the estimated VaR by one third to \$7.8 trillion. Finally, calculating the risk conditional on being in the 1% tail of the distribution gives a loss of \$18.4 trillion. Simple VaR underestimates risk by a factor of 1.5 and 3. This example is far from hypothetical. The inadequacies of VaR were amply illustrated during the crisis.”

In the above quoted speech from Andrew Haldane, VaR is described as being ‘misleading’, ‘blind to risk’, ‘inadequate’ as a measure of potential losses and responsible for the ‘understating of risk. In other words, the accuracy of VaR again became the focus of much recrimination in the regulatory community.

The fundamental issue is, as de Goede argues, that the assumption of normality is that is constructed into the ‘very mathematical models which are supposed to measure it’ and is thus a normative claim not ‘of how things *are*, but how things *ought to be*’ (de Goede 2001:160). The problem with this, simply put, is that ‘financial markets are not normal’ (Triana 2012:19). VaR then has an inaccurate assumption of normality and further, has a blind-spot of extreme events and economic shocks.

6.4 Conclusion

Value-at-Risk emerged in the 1990s and worked on financial stability as something which could be privately managed within individual institutions. It was hoped that on a piecemeal basis, this would contribute to an aggregate of stability. I have argued in this chapter that such internal risk management be considered to be a form of stabilization or territorialisation. An analysis of Bank of England publications suggests that the adoption of VaR was a result of its purported accuracy as a

standard of technical knowledge. This was due to its consistent use as a measure for market risk in Bank of England documents. In this chapter I have applied a Deleuzian argument that enmeshed with the ability of VaR to measure, stabilize and reterritorialize, are several processes of deterritorialization. This understanding is that widespread use of VaR can increase volatility, leaves market participants vulnerable to blind-spots in the model and does not account for abnormal shocks to the financial system. I have used the financial stability archive to characterise two episodes of failure of Value-at-Risk as periods in which VaR is being understood as subject to deterritorialization. In the first instance, the global financial volatility at the end of the 1990s was viewed as a situation in which widespread use of the same measure of risk increased volatility due to mass position cutting. And while the Bank at first does not respond to this critique, it later does in FSR 2002b. In the face of this difficulty, the Bank of England attempted to shift the epistemic standard away from accuracy to one of precision. And, here I have focused on an article written by Phillippe Jorion who uses calculations about the stability of the VaR calculated market risk charge to argue that VaR should be appraised in terms of a standard of knowledge of precision. This then, is a process of reterritorialization. The shift to precision was made through appeal to ‘smoothing mechanisms’ in the Basel version of VaR. This can be analysed through Foucault’s archaeological work on the fragmented shifts and mutations within dominant discursive fields. Here I have placed emphasis on the role of public facing economist as technical expert. The change is prompted by changing relations and elements within the discursive field, as professional status of a Professor, institutional site of a central bank and the technocrat as calculating subject all come together.

And, while this subtle alteration in discourse sustained the use of VaR as the main regulatory tool for measuring market risk and requisite regulatory capital held as insurance against potential downturns, risk management would be severely reappraised following another period seen to be one of extreme deterritorialization. The instability was seen to lie within the under-pricing and concentration of risk that VaR oversaw during the early 2000. In particular, inadequacies with the assumption of normality within the VaR calculation, and the fact that it did not take into account extreme combinations of events, led to renewed criticism of the accuracy of the likely losses and level of market risk attached to trading strategies. Moreover, this time it is the Bank of England that is raising the critique. As Andrew Haldane argues, ‘the fatter the tails of the risk distribution, the more misleading VaR-based risk measures will be’ (Haldane 2012e: 16). Following the Subprime Crisis, it has become widely recognised that on its own, VaR is unable to account for high-impact/ low probability events, so called tail-risks. To address this, the Bank of England recognises the need to modify and supplement the VaR assemblage with another technique, stress testing. Stress testing,

is a significant add-on because it includes the demand for 'extreme but plausible' scenarios. I turn to the emergence of this technique in the following chapter.

Chapter Seven: Stress Testing- Assembling Possibility, Hypothesis and (Peri)performativity

The limitations of Value-at-Risk, highlighted in the previous chapter, and exemplified by the regulatory response to events such as the Thai currency crisis and subsequent financial contagion that spread across East and Southeast Asia during 1997-1998, make it clear that financial governance must not only consider the normal but must also attend to:

‘What extreme circumstances, in the absence of any response by lenders or regulators, would reduce capitalisation to well below required minimum levels? We find that the circumstances which would create such a substantial decline are a ‘triple whammy’ combining the spread of discounting which features in all our scenarios; a housing market boom and bust; and a substantial erosion of the retail franchise due to increased competition in retail deposit markets’ (FSR 1997a:44-45).

As early as the 1990s then, it was apparent to regulators that there was ‘the need to supplement measures of Value-at-Risk in market risk models with stress testing’ at the micro-prudential or firm level. (FSR 1998b:75). In other words, at the end of this decade the Bank of England publicly acknowledges that VaR ‘will not capture the potential impact of ‘extreme’ market events’ (FSR 2000b:79). There is then, a need to extend what Foucault would characterize as the ‘bandwidth of the acceptable’ (2007: 6) beyond the assumption of normality. To unpack these three ‘extreme’ events in the above scenario, firstly it is problematic when the bid prices for securities are higher than the offers made for them because typically people will not sell a security for lower than the price they are willing to pay for it. There would most likely be widespread illiquidity in securities markets. Secondly, a housing market boom and bust is a quintessential asset bubble, with many entrants to the housing market as prices rise, before a drop in house prices and a rush to exit the housing market (Kindleberger and Aliber 2011:13). Certainly, in this context Japan’s economy remained stagnant following the bursting of a significant housing bubble in the 1980s (Kindleberger and Aliber 2011:173). Third and finally, deposit market competition raises the cost of bank liabilities. The outcome is that bank lending to commercial franchises contracts. In sum, this extreme scenario features decreased liquidity, a commercial credit crunch and the bursting of an asset price bubble.

Following the Global Financial Crisis, the fundamental problem was thought to be overleveraged institutions with insufficient regulatory capital, and the measurement of risk using techniques designed by the banks themselves (Triana 2012). This system-wide problem became exposed by a series of exceptional events, including an asset price bubble bursting in the American housing market, huge derivatives losses posted against asset backed securities, a commercial credit crunch and the failure of a systemically important institution, Lehman Brothers, due to extremely illiquid interbank credit markets.

Simply put, under the new, post- GFC regime, banks are to set aside more high quality capital to mitigate against extreme macroeconomic shocks. In the United Kingdom, the *Vickers Report* recommended that there be a 'ring-fence' between retail banking and investment banking which recognised that both types of banking were valuable, but sought to prevent the dangers associated with the latter from damaging the former (Langley 2014:200). Banks that were ring fenced were to hold an additional buffer of equity capital, a measure introduced to increase resilience to both direct financial shocks, but also shocks to confidence in institutional solvency. The ring-fence recommendation became part of the Banking Reform Law that passed through Parliament in late 2013.

Stress testing has a role to play here in capital adequacy because of 'the integration of stress testing techniques into national supervisory assessments of the capital adequacy of banking' as codified in the Basel III agreement (Langley 2014:178). Stress testing involves the running of an anticipatory exercise in which the impact of a hypothetical scenario of three 'low probability-high impact' events is measured on the balance sheets, exposures and reserve capital held across banks in a financial system (Geithner 2014). This overhaul of Basel II addresses the normality assumptions of Value-at-Risk.

Stress testing, then, involves the conceptualisation of a combination of exceptional macroeconomic shocks in an attempt to better understand the existing weaknesses of a financial system (Langley 2014: 158). In this chapter, I introduce the small and non-specialist social science literature on stress testing and establish the contribution this chapter makes in relation to the existing work of stress testing as crisis governance (Langley 2013b, 2014; Geithner 2014). By analysing Bank of England documents and speeches, I infer that the Bank is aware of the weaknesses of Value-at-Risk and the probabilistic risk calculus as early as the 1990s. To situate this chapter in relation to Chapter

Six, due to the ongoing and emergent nature of stress testing, it should be considered an additional technique fused onto VaR and an assemblage in its own right.

Detailed analysis of the financial stability archive suggests that one early understanding that the Bank of England has held is that the more rigorous the stress test, the more effective it will be. Taking this analysis further however, an important theme which emerges is the emergence of language which implies possibilistic imaginings of extreme events. Having said that, the Bank still makes a substantial amount of references to probabilistic calculation. In order to better understand this, I draw on Louise Amoore's (2013) work on the governance of the uncertain futures of terrorist attacks. I make this claim about the coming together of possibility and probability because in Bank documents which draw close analogy to stress testing as 'meteorology', we see the foregrounding of subjective judgement within probabilistic techniques of governing the future through action in the present.

The story does not, however, end here. I go onto interrogate the term "the possible" further than Amoore does at present. I engage with the plausible and hypothetical as distinct modes of risk management of the 'possible', and detail how and why these have changed and developed in stress testing over time since the Subprime Crisis. I make the case that in publications from 2013 there is a marked difference between the conceptions of the *possible* being invoked and acted upon by the Federal Reserve and the Bank of England respectively. While for the Bank of England there is a sense that stress testing involves the projection of extreme, yet plausible circumstances that could be used for forecasting, the Federal Reserve was at pains to insist that stress tests are to be '*deliberately stringent* and conservative assessments under *hypothetical*, adverse economic conditions and... not forecasts or expected outcomes' (Federal Reserve 2013). However, and drawing on analysis of Bank of England financial stability press conferences, I argue that the Bank of England later changes its position on this matter, following the impact on the financial sector that its staff perceive stress testing to have. In other words, when presented with evidence that stress testing has the performative effect of 'altering an ongoing situation' (Christophers 2014), the Governor of the Bank of England is certainly more careful in emphasizing that its 2015 stress scenario of a widespread 'deterioration in global economic conditions' is a 'not a prediction' or a forecast (Carney 2014). Stress scenarios then, are coupled with this caveat that they are hypothetical, because rather than being based on some evidence, they proceed deductively by holding an assumption as being true. This in itself is interesting, because it gestures to yet another different account of performativity. By referring to a speech act, a prediction', Governor Carney is invoking, in the words of Eve Kosofsky Sedgwick, an utterance which is *about* a performative and clusters

around the performative (Sedgwick 2003: 68). This should be considered, with Clarke (2012) and Esposito (2013) an additional layer of performativity and consistent with the arguments and moves made in chapters Two and Four.

7.1. Insiders and Outsiders on Stress Testing as Crisis Governance

At the time of writing, there is little non-technical literature on financial stress testing. The two explicit attempts to address stress testing have the same entry point, governance of the Global Financial Crisis, but take different and distinct analytical perspectives. Paul Langley (2013b, 2014) takes a critical social science approach to the mobilisation of stress testing as part of the SCAP apparatus that emerged and was improvised as a response to the Subprime Crisis in its Anglo-American heartland. Although criticised and maligned at the time (see Geithner 2014), once the immediate dangers of this crisis had passed, the stress testing of financial institutions, and injections of capital for those failing to pass the tests, became viewed as being a turning point in the crisis. And for Langley, the ‘precision’ of the American Stress Tests, and the ‘positive affective charge’ that these generated mobilised one of the emotional, psychological and affective energies at play during the crisis period, namely a feeling of confidence rising from a tumultuous emotional background of trauma (Langley 2013b; Brassett and Clarke 2012). Langley’s approach draws inspiration from both the work of Michel Foucault on apparatuses of security (2007), and the so-called ‘affective turn’⁴⁸ in the social sciences.

If Langley’s perspective is that of the outside academic observer, then Tim Geithner’s account of his experience in the Federal Reserve Bank of New York and the U.S. Treasury is from the perspective of an insider and practitioner. Geithner’s account understandably reads the use of stress testing in the Global Financial Crisis as being less improvised and following a clear and logical rationale. Describing stress testing as ‘the centrepiece of our approach’, Geithner argues that it ‘would be more than a rigorous test’ rather, ‘it would be a mechanism to recapitalize the financial system so that banks would have the resources to promote rather than prevent growth’ (Geithner 2014). Here Geithner differs from Langley because for the former, private capital and public financing by state institutions is at the heart of the efficacy of the stress test. Having said that, later in his account Geithner does concede that ‘perhaps more than anything else’, the ‘brutally tough assumption’ of bank loan losses ‘even worse than during the Great Depression... helped convince investors that the

⁴⁸ See, for example, Clough and Halley (2007) or Gregg and Seigworth 2010 for overviews of this approach within cultural studies.

test was credible.’ And although Langley (2013b) argues that capital alone is not the answer because stress testing by the European Central Bank mobilised capital but was less successful, Langley later argues that there is clearly thought to be a relationship between capital and confidence (Langley 2014:139). Interestingly for both authors, stress testing aims to foster prudent behaviour across the financial system as a whole.

Although I agree with Sarah Hall (2012) and Brett Christophers (2013) - that geographies of money and finance must engage with the Global Financial Crisis - I move beyond this debate about reactive crisis governance. Stress testing does not present itself during the financial crisis as a finished achievement and technique of governance/risk management. I aim to push such research frontiers further by looking at the development of stress testing beyond its initial mobilisation as a reactionary tool within the crisis management apparatus. The consequence of this is that I conceptualise stress testing not as an ‘dispositif’, in Langley’s (2013b) terms and implied in Geithner (2014), that is- as a response to an urgent need (Langley 2014:32). Instead, the developing, emergent and ongoing use of stress testing suggests that stress testing is an assemblage. In cruder terms, although stress testing emerged alongside VaR in private institutions in the mid-to-late 1990s, as a regulatory tool it was bolted onto VaR to account for extreme shocks to financial markets. And, while its public use by the Bank of England since the Global Financial Crisis might suggest it is a one off response to an urgent need, this will not do. Stress testing is the latest attempt to reterritorialize Value-at-Risk, by accounting for and making actionable extreme shocks to the financial system.

7.2. The Emergence of Stress Testing

The case that I outlined in my review of Langley (2014 and Geithner (2014) is that stress testing must be considered to be more than a technique of crisis governance. And, as such, macroprudential stress testing is an ongoing and developing technique. The account of stress testing that I am developing here starts before the picture sketched out by Andrew Baker in his work on the emergence of ‘macroprudential’ ideas⁴⁹ following the Global Financial Crisis (Baker 2013a/b; Baker

⁴⁹My approach differs to Baker because while he squarely focuses on ideas, I am predominantly interested in techniques.

and Widmaier 2014).⁵⁰ On this reading, prominently placed commentators in central banks and governmental organisations, such as Andrew Haldane at the Bank of England, began to publicly promote a set of ideas which challenged previously entrenched views on the private pricing of risk, the efficiency of markets and the possibility of market completion (Baker 2013a: 115). A simple idea lies behind macroprudentialism- ‘that aggregate risk lies in the collective, rather than individual, behaviour of financial institutions ‘(Baker 2013a: 115). For Baker, stress testing emerges out of the macroprudential ideas which hold that (i) diversification by individual institutions using the same model could increase non-diversifiable risk and (ii) linkages between markets and market participants create externalities and unanticipated consequences (2013a:116). Here though, some caution is required. Although Baker contrasts the internal risk management of VaR with a macroprudentialism of stress testing, it is important to remember that stress testing emerged out of and as complementary to, internal risk management practices by firms. In 2000, the Bank of England reports that:

‘the increased volatility of markets, and the changing correlations between instruments, have led risk managers to place increasing emphasis on stress testing rather than value at risk (VaR) models as a measure of maximum potential loss; and to base stress tests on the assumption that many of the benefits of diversification can erode, or even disappear, during times of crisis’ (FSR 2000a:49).

During the early- to- mid 2000s, the Bank of England reports that financial firms did begin to make greater use of stress testing and scenario analyses. For example FSR 2001a reports that ‘within

⁵⁰ The three main ideas that Baker identifies are the procyclical nature of credit, the way uniform use of one system to diversify risks can generate risks, and the ‘complexity’ of the financial system (Cooper 2011:371). For the first idea credit is most available when it is least needed and least available when most needed. Consequently the creation of credit and debt during the upswing phase of a cycle needs to be restricted. We encountered the second of these ideas in the previous chapter, with the argument that widespread use of the same model to diversify risk can actually generate risks that the system is vulnerable to. For the third macroprudential idea, linkages between markets and market participants create externalities and unanticipated consequences (Baker 2013a:116). Furthermore, rather than being a general equilibrium state that returns towards stability if disturbed from it, the financial system is much closer to a complex adaptive system, which has greater potential for radical change and is much more likely to collapse (Smart 2006: 88; Holmes 2014:91; Byrne and Callaghan 2014).

firms, it seems that greater use is being made of risk management tools, with value-at-risk calculations being supplemented more frequently – especially at large global groups – by stress testing’ (FSR 2001a: 12). This point is reiterated in a later FSR that:

‘ it is well recognised that standard measures of VaR should be interpreted with some caution...to address these types of issues, in their internal risk management banks tend to use a range of different VaR assumptions, and supplement VaR analysis with both stress tests and scenario analysis of market prices and market liquidity’ (FSR 2004b:63).

Even so, it is also widely recognised that stress testing has its limitations because:

‘The use of these techniques across firms is uneven, and stress tests are often based on previous episodes of market dislocation, rather than hypothetical events. Also, firm-specific stress tests are unlikely to provide a complete picture across the financial system’ (FSR 2005a:67).

It seems clear then, that macroprudential ideas are circulating prior to the Global Financial Crisis, while the Bank of England is certainly aware of the critique within the financial industry of internal risk management techniques. From the mid-2000s onwards the events surrounding the Subprime Crisis took hold, and state institutions such as the Bank of England, the Federal Reserve and the US Treasury became preoccupied with crisis governance. These advanced liberal societies facing the Global Financial Crisis conceptualised it as a series of problems to which a bricolage of strategic yet improvised apparatuses was deployed (Langley 2014). Alongside this Nassim Taleb’s book *The Black Swan* (2008) came to prominence due to its explanation that in finance low probability/ high impact events do occur and are beyond human abilities to conceptualise them. In 2009 financial stability governance turned to, and fixed, on stress testing.

As Langley (2013b) documents, the stress testing of American commercial banks was a major part of the regulatory response to the Subprime Crisis. Langley’s work on stress testing identifies ‘precision, intelligibility and clarity’, rather than accuracy, as being the most important features for a stress test to foster widespread confidence in a banking sector (Langley 2013b:55, 67). In comparison between the American Supervisory Capital Assessment Programme in spring 2009 and the European Union bank stress tests carried out in Europe in 2010 and 2011, Langley draws on the work of Lorraine Daston (1995) on the ‘positive affective charge’ attached to precision.

This is a significant point when we consider a secondary feature of effective stress tests, identified by the Bank of England as being the idea that effective stress test are those which employ assumptions which are ‘generally more severe’ (FSR 2012a:13). The Bank of England makes the point clear with its inclusion of the following comparative table:

	EBA (July 2011) ^(a)	Federal Reserve (March 2012) ^(a)
Per cent		
US GDP growth ^(b)	0.1	-4
Euro-area GDP growth ^(b)	-0.5	-5
Equity prices ^(c)	-15	-55
House prices ^(d)	-10	-23
Yields on sovereign debt ^(e) (basis points)	+75	-241

Sources: European Banking Authority, Federal Reserve and Bank calculations.

(a) Date of publication.

(b) Rate of output growth in first year of stress period.

(c) Maximum fall in domestic stock market indices relative to scenario baseline during the period covered by the stress test.

(d) Maximum fall in domestic housing indices relative to scenario baseline during the period covered by the stress test.

(e) Maximum change in domestic sovereign debt yields relative to scenario baseline during the period covered by the stress test.

Figure 13: Stress-test Assumptions

This brings to our attentions desirable attribute of scientific research in addition to accuracy and precision, namely rigour.⁵¹ In post-Subprime Crisis speeches and financial stability reports, representatives of the Bank of England have emphasized the fundamental importance of ‘sufficiently severe’ stress tests and scenarios (FSR 2008a:47). In Paul Fisher’s words taken from a 2011 speech, ‘one reason why such risks may not be appreciated *ex ante* is over-reliance on local risk measures such as VaR (Value at Risk) or other historical average correlations, and not enough on severe stress tests over different horizons’ (Fisher Speech 2011d:5).

Reflecting further on the subprime crisis:

‘A lot of the surprise seemed to come from the fact that virtually all risk management had been done within a ‘local’ framework, rather than genuinely extreme stress tests. If regulators, rating agencies or, for that matter, bond and equity investors had demanded analysis based on extreme stress tests, many of the repercussions in the system could have been identified. The main point is that a stress test has to be internally consistent. As an example, if you stress test a 30-40% fall in US residential real estate prices and that shows your institution would be in trouble, you need to make consistent assumptions about the deteriorating credit conditions of your counterparties, anyone that provides reinsurance and general market conditions’ (Fisher Speech 2011d:6-7).

As a Bank of England Financial Stability Paper recommends approximately five years after the Subprime Crisis:

‘ all other Central Counter-parties (CCPs) should maintain additional financial resources sufficient to cover a wide range of potential stress scenarios that should include, but not be limited to, the default of the participant and its affiliates that would potentially cause the largest aggregate credit exposure to the CCP in extreme but plausible market conditions’ (Nahai-Williamson *et al* 2013: 18).

A Financial Stability Report from the same post- subprime crisis period reiterates the case that:

⁵¹ In their practitioner led handbook on stress testing, Siddique and Hasan name ‘analytical rigour’ as being an important ‘benchmark’ for stress testing approaches (Siddique and Hasan 2013:xxxii).

‘The use of a range of scenarios would help ensure that the banking system as a whole does not focus on being resilient to only a single adverse scenario. It would allow the framework to perform a broader risk assessment role for the FPC. There are also benefits to risk management within firms if the exercise is linked with senior managements’ own internal assessment of the risks to which they are most vulnerable’ (FSR 2013a:75).

I use the term ‘rigour’ because this captures the severity that is being required as a technical standard within proposed stress scenarios. That said, it is not immediately clear how much rigour differs from precision. The Bank of England’s emphasis on extremity and severity seem to contrast with their assessment of the ‘seductively precise’, yet also ‘ephemeral’, outputs of stress testing and VaR. This seems to indicate that the two things, precision and rigour, are marginally different (Haldane 2009b:19). For historians of science, such as Loraine Daston, the rigour of precision measurement is the ‘perfection of precision’ (Daston 1995:11-12). As such, the tendency toward supplementing VaR with stress-testing has therefore coincided with a conscious drive towards the perfection of precision.

Stress testing has now become an annual exercise in the UK. In the Bank of England’s recent stress testing exercises from 2013-2015, the Bank decides upon a scenario of macroeconomic shocks, and financial institutions have to project the impact of the shocks on their balance sheets and capital reserves. The Bank of England makes a request for unstructured data relating to audits, balance sheets and methodology from participating financial institutions. This includes ‘internal governance arrangements for approving methodologies and results, reports produced by internal audit or other review functions and ‘methods related to the extrapolation of risk factor shocks.’ Further, the Bank of England also requires ‘an assessment of the key sensitivities of the results and details of how the stress scenarios have been translated into impacts on the income statement and balance sheet’ (*Bank of England- Guidance for participating banks and building societies 2015*). The Bank of England uses this information to assess the rigour of the financial institutions tests and results, while also running its own stress test on the data.

Stress testing, then, is a technique that emerged out of internal practices within financial institutions in the 1990s, which then used the technique to supplement VaR as a measure of market risk. Stress testing was known to the regulatory community in the 1990s and early 2000s but became a major

part of the regulatory tool-kit during the Global Financial Crisis. Regulators identified rigour as an important feature of such stress testing. In the following sections, I develop an account of the development of the Bank of England's understanding of stress testing both in the decade before the Global Financial Crisis and then when put to macroprudential use by regulators in the immediate period after the Global Financial Crisis.

7.3. Bank of England Statements and a Possibilistic Logic

A theme that has emerged through textual analysis of Bank of England communications is that stress tests involve 'such an extreme combination of events' that 'we cannot assign a probability' to them (FSR 1997a: 44-45). The Bank of England points out that even if the 'possibility' of a widespread scenario occurring seems 'remote', this 'reassuring conclusion does not rule out the possibility of an individual lender getting into difficulties' (FSR 1997a: 44-45). Elsewhere, in the most recent Bank of England financial stability publications, there has been a noticeable increase in the language of possibility or contemplation of the 'unthinkable...actually' happening (Fisher speech 2011d: 7). Andrew Hauser's speech provides several examples of this (Hauser Speech 2013a: 7):

'The FSBxi identified a number of potential sources of run risk in repo markets, including:

1. The *possibility* that investors cannot meet sudden margin calls (for a given haircut) if the mark-to-market value of the underlying collateral falls sharply and/or credit downgrades require collateral substitution;
2. The *possibility* that haircuts may be procyclical, particularly for repo against lower-quality or more uncertainly-priced collateral, rising from 'too low' in benign times to 'too high' in periods of heightened risk aversion...
3. The *potential* for collateral re-use to increase system-wide leverage.'

The language of the 'possible' and the 'potential' enter a scenario affecting the money markets, in which liquidity could conceivably become scarce due to difficulties or uncertainty with the pricing

of the underlying collateral which supports loans by acting as a security for the lender (Mehrling 2011: 39). There are also the problems faced by probabilistic risk management tools that rely on normality as a key assumption. Indeed in recent years the Bank of England has become increasingly critical of normal distributions of credit events because:

‘Tails should not be unexpected, for they are the rule. As the world becomes increasingly integrated – financially, economically, and socially – interactions among the moving parts may make for potentially fatter tails... Preventing public policy catastrophe requires that we better understand and plot the contours of systemic risk, fat tails and all. It also means putting in place robust fail-safes to stop chaos emerging’ (Haldane Speech 2012c:17, 20-21).

However and alternatively, there also appears to be substantial evidence of the renewed significance of probabilistic risk techniques, because probabilistic language still remains in Bank of England publications. For example, even when stress testing became a device that regulators were turning to, Andrew Haldane of the Bank maintained that ‘a stress scenario is just one point on a probability distribution’ (Haldane Speech 2009c:5). Moving forward to a consideration of Paul Tucker’s 2011 speech (2011e): ‘those state-sponsored measures reduce the probability of unwarranted failure, but they also increase the private returns to bankers and their shareholders by transferring some risk to the state’ (Tucker Speech 2011e: 2). The Speech also includes appeals to ‘likely consequences’ (Tucker Speech 2011e: 5) and ‘very real risks to stability’ (Tucker Speech 2011e: 6).

These findings can be interpreted by drawing on Louise Amoore’s recent monograph, *The Politics of Possibility*, which is an investigation of the relationship between economy and security following the terrorist attacks on the World Trade Centre in 2001. The derivative logic of dispersal that I employed to analyse credit derivatives is again present in homeland security practices that separate out possible future incidents from their underlying probabilities (Amoore 2011, 2013). On such terms ‘the emerging security risk calculus... distinctively coalesces more conventional forms of probabilistic risk assessment with inferred and unfolding futures’ (Amoore 2013:60).

Historians of mathematics make a distinction between the objective probabilities generated through ‘mathematical reasoning or statistics’, and subjective probabilities which are thought to be less rigorous as they are generated through ‘are personal estimations of probabilities’ (Leclercq

1974:36). This is significant because the Bank of England statements and speeches are suggestive that 'subjective and objective probabilities coexist together' (Gigerenzer *et al* 1989:237). This is because several of Andrew Haldane's speeches about shifts in financial stability governance raise the idea that financial regulators ought to move closer to 'meteorologists' by 'combining empirically-motivated behavioural rules of thumb, and balance sheets constraints' (Haldane Speech 2012c: 19). Indeed, in the same speech⁵² Haldane argues that:

'The evolution of weather forecasting may provide useful lessons on the directions finance might take – and some grounds for optimism. After the Second World War, meteorologists were among the earliest adopters of computing technology.

The processing power of computers has certainly been key to advances in weather forecasting. The main reason for Lorenz's pessimism about forecasting was the problem of collecting and processing data. Modern computers have stretched significantly those data limits. The UK Met Office's computer can handle 100 trillion calculations per second and uses hundreds of thousands of global observations each day.

The results have been striking. Errors in weather-forecasting have been in secular decline. Today's four-day forecasts are as accurate as one-day forecasts 30 years ago. Weather predictions have predictive value well beyond a two-week horizon. Indeed, predictions of climatic patterns are now made out to a horizon of 100 years. Lorenz's pessimism was misplaced.

Finance could usefully follow in these footsteps. There are already steps underway internationally to widen and deepen the array of financial data available to systemic risk regulators, filling gaps in the global network map. As in weather forecasting, this would help improve estimates of the initial conditions of the financial system. And as in weather forecasting, it is important these data are captured in a common financial language to enable genuinely global maps to be drawn' (Haldane Speech 2012c: 18).

Furthermore, elsewhere Haldane has said that 'stress-tests of the impact of extreme financial events on the functioning of the global financial web would play the role of weather warnings' (Haldane Speech 2012b:17). What is at play here then, is the coming together of 'multiple forms of

⁵² This document can be found at <http://www.bankofengland.co.uk/archive/Documents/historicpubs/news/2012/058.pdf>

probability’, in terms of ‘the consideration of past frequencies and personal convictions’ (Amoore 2013:45).

I want to conclude this section by making the case that, as Amoore suggests, the contemporary technique of stress testing meshes together the probabilistic with imaginable possibilities. Possibility and inference do not supplant and make redundant probabilistic techniques, in fact quite the opposite, due to the Bank of England’s agenda in which stress testing would ‘inform judgement’ (FSR 2013a:75). As Andrew Bailey has said:

‘The key message here is that if the banking system is sufficiently capitalised against future losses, it can play a full role in counter-cyclical policy which seeks to respond to and lean against the conditions of the day. That is the essential use of forward-looking judgement, done with the explicit objective in mind of using financial regulation as a counter-cyclical tool’ (Bailey Speech 2013b:7. See also Bailey speech 2011e:4).

The previously encountered analogy with the ‘meteorologist’ and ‘weather warnings’ captures the thought that there is, in this line of enquiry and analysis, a coming together of the objective with the subjective (Amoore 2013: 45). The relationship between finance and security is then, to relate to Marieke de Goede’s typology of finance/security, ‘instrumental’ because a financial technique or logic is put at the service of security (de Goede 2010:106). I say this because, for Amoore, ‘the derivative risk calculus places mobility at the service of security by trading on and through the thriving and teeming details of circulation’ (Amoore 2013: 73).

7.3.1 A Turn to Plausibility

The consequence of having rigour as a target is a demand for stress testing to incorporate ‘severe... yet plausible credit events and market conditions’ into the calculation of a scenario (FSR 2012b: 21; See also Nahai- Williamson *et al* 2013:18). While ‘plausibility and probability have been confused with each other for centuries’, plausibility sits ‘somewhere in the hinterland between objective probability and subjective probability’ (Ramirez and Selin 2014:5; Leclerc 1974:40). As Ramirez

and Selin document: ‘probability- and the likelihood it sought to express- first started to become ‘scientific’ when it could start to be taken as an approximation of fact when evidence was lacking. Plausibility, and its connections with the pliable notion of what can be applauded, quite quickly became ‘something which one could fashion to ends of appearing truthful when actual truth might be wanting’ (Ramirez and Selin 2014:5).

As we heard earlier, whereas objective probabilities are expressed by mathematical reasoning or statistics, subjective probabilities ‘are personal estimations of probabilities’ and are not obtained through a ‘rigorous method’ (Leclerq 1974:36). Plausibility thus is an exercise of creativity which retains rigour, such as analogy. In the words of the Bank of England, the dual-demand of extreme yet plausible requires a ‘necessarily subjective’ inference. This is because ‘*stress-tests are probabilistic and state-dependent judgements... which point to choose – indeed, which distribution to choose – is a matter of judgement*’ (Haldane speech 2009c:5-6). Stress testing therefore sees the foregrounding of subjective judgement within probabilistic techniques of governing the future through action in the present.

7.3.2. The Plausible and the Hypothetical

It has already been noted that the Bank of England has associated extreme but plausible stress test scenarios with being rigorous. The stress tests carried out in America are cited as a paradigm of this when FSR 2012a says that ‘the assumptions used for the US tests were generally more severe than those used for the most recent stress tests for European banks published by the EBA in July 2011’ (FSR 2012a:13). In the case of the recent Federal Reserve stress tests, scenarios included:

‘a peak unemployment rate of 12.1 percent, a drop in equity prices of more than 50 percent, a decline in housing prices of more than 20 percent, and a sharp market shock for the largest trading firms-projected losses at the 18 bank holding companies would total \$462 billion during the nine quarters of the hypothetical stress scenario’ (Federal Reserve 2013).

If we consider what the Federal Reserve says about stress tests being ‘*deliberately stringent* and conservative assessments under *hypothetical*, adverse economic conditions and... not forecasts or expected outcomes’, we can identify a tension that was present between the approaches of two major central banks (Federal Reserve 2013). On the one hand, the Bank of England has the ‘severe

yet plausible', while on the other hand the Federal Reserve has 'stringent yet hypothetical.' Two concomitant questions that arise here is then. Firstly, do these two approaches differ in any significant way? And secondly what is at stake here? The question seems to me to be one of if stress testing is a necessary part of the financial stability tool kit, and rigour is viewed as the most admirable methodological quality, can this economics of the possible be combined with a policy of forecasting scenarios of stress?

As Rene Leclerc argues, forecasting is 'intimately connected with plausible reasoning and (systematic) creativity' (Leclerc 1974: 53). It seems however that this forecasting paradigm lies in tension with the logic of rigour employed in stress testing in America. The question raised by the alternative statements by the Federal Reserve and the Bank of England on whether stress tests can be forecasts, is a question of whether the 'deliberate' and 'hypothetical' are incommensurable within a 'plausible' forecasting paradigm? While plausibility has connotations of being based on some evidence, hypothetical reasoning assumes that some statement is true and carries on until this is falsified. It would appear that the Bank of England is therefore being pulled in a different direction from the Federal Reserve by virtue of its plausibility/forecast model of the stability paradigm.

7.4. Shifting from the Plausible to the Hypothetical

Rather than stopping on a significant ambiguity from 2012-2013, what I instead want to go onto argue is that the Bank of England altered its position on stress testing following its understanding that the 2014 process of stress testing had real economic impacts. When we unpack a debate in a Financial Stability Report press conference, we can see that the central bank believes that it can contribute to a change in the economy, and has to mitigate this.

7.4.1. Not the Bank of Zero but Very Serious

During the June 2014 press conference, in which the Bank of England outlines a loan income cap to dampen a new housing bubble, Paul Mason, a television journalist, asks in an accusatory tone whether the Bank's financial stability policies are ineffective, describing the Bank as the 'Bank of Zero'. In other words, Mason is questioning whether the Bank's attempt to prevent commercial banks from lending more than 4.5 times the income of the borrowers for more than 15% of each bank's mortgage loan book is effective or impactful in a meaningful way. Alongside this, Mason

includes the recently disclosed results of the Bank of England's stress tests. Both Governor Mark Carney and Deputy Governor Andrew Bailey respond to this charge. In particular, the point at issue is Mason's blunt claim that there has been 'zero impact from the stress test.' The responses of Carney and Bailey are as follows:

Mark Carney: The stress test - there's no reason to come to the conclusion that the stress test is zero. As Andrew Bailey just outlined, a 35% house price shock - it's a stress scenario, it's not a prediction, just to be clear. But in conjunction with a 6% increase in the unemployment rate - stress scenario, not a prediction - a sharp increase in interest rates and a three year recession, do banks and building societies in this country have balance sheets today that are resilient enough to withstand that type of stress? And if they don't, the PRA and the FPC will consider actions that those institutions need to take to address them. So it would be a big mistake to look at the stress test, which we're undergoing right now, and conclude that this anything other than a very serious exercise that may have consequences for some banks and building societies.

Andrew Bailey: Can I add one point on the zero impact, to challenge it? A year ago at this press conference we were discussing the FPC's recommendation on capital. Today if you look at the Financial Stability Report, the FPC has essentially closed its recommendation on capital. And the reason it's closed its recommendation on capital is because of the actions that have been taken in the interim period on adjusting and raising capital and adjusting the capital position of the banking system in this country. That is not a zero impact. It is also in my view an essential component of supporting a durable recovery. So I really do push back on this zero impact point.'

(*Questions and Answers*, June, 2014).

So, what Carney and Bailey's respective responses to the question reveal, is that the Bank of England understands stress testing to have a measurable impact and observable consequences. In such a way, stress testing has the *perlocutionary* effect of altering an ongoing situation because as Bailey argues, 'actions... have been taken' to adjust(ing) the capital position of the banking system'.

Critical then, to the impact of bank, is the technical device of the stress test. Another example of this Austinian performativity would be the Bank of England's systemic risk survey included in an FSR, which in collating expectations of future geopolitical risks, is in itself shaping the individual reader's perception of the future and potential macroeconomic shocks. What this again shows is that a performative logic is present in the Bank of England's discursive interventions into the financial system. In other words, the Bank of England believes that its stress testing programme is able to bring about stability, in the form of a better capitalised financial system.

7.4.2. 'Not a prediction' but a Periperformative!

The implication of the previous section is quite simple. If a stress test programme does have performative force, then the Bank of England must confront the distinct possibility that the 'extreme yet plausible' scenarios invoked in the stress test- scenarios, could themselves contribute to the extreme yet plausible scenario coming into being. This is an important scenario and one which the Bank of England seems to encounter during its recent round of stress testing. Governor Carney makes it clear in the June 2014 press conference that a distinction is to be made between a 'stress scenario', and a 'prediction'. Whereas in 2012, Andrew Haldane invokes forecasting with his analogy to meteorology, the Bank of England 2014 news release makes it clear that the stress test is not designed to precipitate deterioration in global economic conditions:

'The 2015 stress test will assess the resilience of the UK banking system to deterioration in global economic conditions. The stress scenario is not a forecast of macroeconomic and financial conditions in the United Kingdom or other countries, nor is it a set of events that is expected, or likely, to materialise. Rather, it is a coherent, 'tail-risk' scenario that has been designed specifically to assess the resilience of UK banks and building societies to a severe shock. '

(Carney June 2014).

In other words, not only is this new scenario 'not a forecast of macroeconomic financial conditions', but it is in-fact defined as a 'coherent tail-risk scenario.' Here I want to tease out what is happening, performatively speaking, if we phrase a scenario as a prediction of the form, 'I predict that Greece will default on its sovereign debt'. What Mark Carney's 2014 clarification that 'it's a stress scenario, it's not a prediction, just to be clear' would be in effect saying, is that '*I do not predict that Greece*

will default on its sovereign debt', but it is a 'coherent tail risk'. The stress scenario is, then, what literary theorist Eve Kosofsky Sedgwick refers to as the 'peri-performative' - that is to say, an example of utterances that are 'not themselves performatives' though 'they are *about* performatives and, more properly, (that) they cluster *around* performatives' (Sedgwick 2003:68). As such peri-performatives often, but not necessarily so, negate performatives by referring to them. For example, 'I will not marry you.' And, a statement refusing a marriage proposal is powerful for Sedgwick precisely because while it 'perpetuates the prestige of the performative' as a 'defining locus of rhetorical efficacy', it 'nonetheless has the property of sketching in a differential and multidirectional surround that may change and dramatize its meanings and effects' (Sedgwick 2003:79). The stress test is performative then, but in this instance not in the 'one off' sense of the prediction. This requires the opening up of performativity, as argued in Chapter Two with reference to authors Clarke (2012) and Esposito (2013). Performative life is dramatic and layered as well as lively. Here, one does not 'predetermine the form of the future' (Anderson 2010:6). This is, as Anderson classifies it, seeing a performance of the future, which rather than calculation or purely imagination (of the plausible), embodies an 'as if' future' (Anderson 2010:11) In this instance the globally facing stress test relies on the almost dramatic performativity of the hypothetical.

7.5 Conclusion

Stress testing has emerged as the most recent technique within the financial stability assemblage and, arguably, is now at the forefront of attempts to govern the global financial system. Stress testing seeks to encourage prudent behaviour across a financial system. In this chapter, I have tried to give an account of stress testing which begins before the 'macroprudential' shift described by Andrew Baker, and simultaneously and account which goes well beyond that offered by Langley (2013b, 2014) and Geithner (2014) in which stress testing is mobilised within the global financial crisis. For these authors, and to borrow from Foucault's terminology, stress testing is an emergency response to an urgent need (Langley 2014: 32). Rather than just being a reactionary apparatus in the context of a crisis, stress testing has been bolted onto VaR calculations in order to measure regulatory capital in the context of extreme tail-risks. In this I attend to the ongoing use of stress testing, thereby treating stress testing as an assemblage. While I agree with Langley (2013b, 2014) and Geithner (2014) that both methodological precision and 'brutally tough assumptions' were

important features of a stress testing programme for which rigour becomes increasingly the normative standard, I try to relate this to wider shifts in risk management.

The financial stability archive that is the focus of this thesis provides examples that the Bank of England is aware of the private development of stress testing by financial institutions in the 1990s. Further, analysis of the archive suggests that one early understanding that the Bank of England has held is that the more rigorous the stress test, consequently the more effective it will be.

Further, I have provided quotations from financial stability documents which can be interpreted as saying that there has been coalescence between subjective and objective probabilities in stress testing, most clearly evidenced by Andrew Haldane's invocation of metaphors from meteorology. It is important to note however, that alongside this, there has been an increase in possibilistic language which fuses together with subjective and objective probabilities. Here then, I have drawn on Louise Amoore's insights in *The Politics of Possibility* (2013) to argue that in financial governance there has been a coming together of the probabilistic and the possibilistic (Amoore 2013:5).

More than this, however, I have aimed to extend Amoore's work on the politics of possibility. I have opened up the category of 'the possible', by reading a distinction in financial stability documents between the hypothetical and the plausible. I have used this distinction between the plausible and hypothetical to identify an important shift within possibilistic thought from the former to the latter. And, the Bank of England's shift from plausible to hypothetical reasoning is deeply political because it is an attempt to negotiate the performativity of the stress test.

I make the case that in 2013 there was a marked contextual difference between the conceptions of the *possible* being invoked and acted upon by the Federal Reserve and the Bank of England respectively. While for the Bank of England there was a sense that stress testing involved the projection of 'extreme, yet plausible circumstances that could be used for forecasting, the Federal Reserve was at pains to insist that stress tests are to be '*deliberately stringent* and conservative assessments under *hypothetical*, adverse economic conditions and... not forecasts or expected outcomes' (Federal Reserve 2013). And, in keeping with the dynamic account of the ongoing development of stress testing as a governmental technique, I argue that the Bank of England has, since 2014, moved closer to the Federal Reserve's position on this.

Using quotes from the June 2014 Bank of England Financial Stability report press conference, it appears that senior Bank of England staff members come to the understanding that stress tests have real (and performative) economic impacts. On this understanding, financial institutions have increased their levels of regulatory capital as a pre-emptive response to the Bank of England's

analysis. The assumption that stress testing is performative has an important implication. If stress tests can alter the economy, can stress scenarios bring about the version of reality they work with? While initially the Bank of England worked with plausible tests, that is to say scenarios which are based on some evidence, by 2014 and 2015 it is aware that if it is to forecast worsening of global macroeconomic conditions, it needs to make it clear that stress scenarios are ‘not predictions’ and are hypothetical- based on assumptions being true, rather than existing evidence. This is an ‘as if’ logic that moves beyond the probabilistic or the plausible (Anderson 2010:10). And, if we are to consider the status of this new utterance by Governor Carney, it requires attention to a further layer of performativity and can be analysed using Sedgwick’s formulation of the *peri-performative*. This is because the Governor’s statement is about a type of performative utterance, the prediction. This means that it is, as Sedgwick has it, an utterance that is both *about* and clusters *around* a performative (Sedgwick 2003:68). The argument, then, is that peri-performative utterances are powerful because while they replicate or mimic the ‘the prestige of the performative’, they may well distort and dramatize meanings and effects. This suggests that the current manifestation of stress testing is grounded in a dramatic force, rather than either the sort of established authority conditions that monetary policy performativity is grounded, or the technical quality of rigour that initially was so important in the development of stress testing. It remains to be seen whether the peri-performative development of stress testing will be as effective as previous versions of this emergent financial stability technique. However, it does suggest that the trajectory of possibilistic reasoning is that of drama rather than ‘science’ as traditionally conceived. In the final empirical chapter of this thesis I introduce one final assemblage, that which employs language and money to act on confidence.

Chapter Eight: Assembling Money, Enunciation and Confidence.

‘Sharp changes in sentiment, confidence, animal spirits – whatever words you care to use – are capable of wreaking havoc on the world and our own economy’ (King Speech 2009b:10).

In the above quotation, the (then) Governor of the Bank of England, Sir Mervyn King, is commenting on the ‘financial turmoil that began in August 2007, led to a financial panic in September 2008, and now to a severe worldwide economic downturn’ (King 2009b:2). Here King does a number of things. First, he identifies the centrality of confidence to the financial system and the global economy. Furthermore, he illustrates the contested nature of claims about what confidence is, whether it is ‘sentiments’ or ‘animal spirits’.

This view of the relationship between confidence and systemic failure is shared, both implicitly and explicitly, by financial stability practitioners such as Andrew Large- for whom ‘financial stability is about identifying and countering risks and threats which could ultimately impact confidence in the banking or wider financial system’ (Large Speech 2003b: 2). If financial stability is about the financial system performing ‘its key functions effectively’, then confidence is ‘at the heart of the financial industry’ (Large Speech 2003b:2). The breakdown of confidence, then, is recognised through a banking system which malfunctions. This is because:

‘It is confidence that permits banks to operate, as matter of course, with gearing many times capital, and with a maturity mismatch between their assets and liabilities, often concentrated in short-term or sight deposits. They are peculiarly vulnerable to a loss of confidence, individually and as a group’ (Clementi Speech 2001f:4).

Much of this thinking owes an intellectual debt to Walter Bagehot’s hugely influential *Lombard Street* (1873). This was a remarkable book in several ways, with its central thesis being a call to arms to the then private company of the Bank of England to take responsibility for the solvency and liquidity requirements of the money markets in London’s financial district (Bagehot 1873: 70). Furthermore, Bagehot gave emotions and ‘sentiments’ such as ‘alarm’, ‘excitement’ and ‘apprehension’ high value in explaining the workings of the financial markets (Bagehot 1873:54, 150,152). Here Bagehot identified structural features of the financial system which rendered confidence crucially important. Day to day financing through bank deposits was vitally important,

as were long term bank loans which were high yielding but relatively illiquid. Because of the importance of short-term commercial credit, trust and confidence were also highly important in the financial district (Bagehot 1873: 22; Mehrling 2011:18). For Bagehot then, alongside excitement and alarm was confidence- something which both underpinned credit relationships and that could be restored by lending 'freely' (Bagehot 1873:22, 64). This much is acknowledged by the contemporary Bank of England, even before the credit crunch which emerged following the Lehman Brothers' bankruptcy, such that:

'As many bankers through the ages have found to their cost, the key objective for the management of liquidity risk is the retention of confidence. A bank may be well-capitalised and profitable with a sound loan book, but if depositors lose confidence in the bank's ability to provide their funds as and when they request them, the crystallisation of liquidity risk can bring down an otherwise viable institution in short order. Once underway, a liquidity crisis can be very hard to stop' (Jenkinson Speech 2008a:2).

Confidence is a great concern of the Bank of England due to the role short term credit plays in the Anglo-American banking system.⁵³ Day to day financing in the repo market, through which short term capital is raised when securities are sold and later repurchased, is a particularly significant feature of the modern 'shadow banking system' (Mehrling 2011:99). The modern system then is prone to what Bagehot saw as the 'economic delicacy' of a traditional system in which credit plays such an overarching role (Bagehot 1873:3). Credit relationships rely in some degree on the faith one person has in the ability of a borrower to service their debt. Confidence in the face of uncertainty then is the adhesive drawing together the social relationship of credit which would otherwise be pulled apart by doubt and uncertainty on both sides of the credit/debtor relationship (Amato and Fantacci 2012:29).

The chapter is comprised of three main sections. In the first part of this chapter I begin by introducing the notion of confidence as an object for governance. This draws on Ben Anderson's (2014) recent concepts through which certain categories can be known through their 'inscription in reality', and that, in addition to this, some mediated thing can be an 'object-target'. Here then, I relate the manner in which the Bank of England seeks to govern (through) confidence, to contemporary work in the social sciences which attempts to grasp and articulate what it is the very nature of confidence. Due to the focus on my financial stability archive, I focus on what the archive

⁵³ See Swedberg (2010:78) for greater detail on this.

tells us about the inscription of confidence as an object-target. I then provide examples from Bank of England texts that at times confidence is spoken about in psychological terms and later in terms of emotions. I go on to present quotations that apparently show that the Bank of England understands confidence as if it has a vitality and materiality. Confidence therefore has a mutable and ambiguous status across the Bank of England's publications.

In parts two and three of the chapter I provide an account of a technique of governance as a Deleuzian assemblage that is, at once both discursive and machinic. Part two of the chapter is concerned with the way in which the Bank describes a relationship between language and confidence and panic. I argue that the Bank both acknowledges the centrality of, and attempts to manage, the panic that can follow concerned central bank statements about institutions or the financial system. I argue that central banks manage this relationship by using rhetorical strategies such as minimalist and ambiguous language. And, although the financial stability archive cannot support this claim, I relate the Bank's work to recent social science research by Sine Norholm Just (2015) on the relationship between language and affect.

In part three I go onto provide quotations that suggest that the Bank of England works with the assumption that there is a relationship between capital and confidence. Again I make the case that the Bank of England understands confidence as having a life of its own, and not only is confidence stimulated by capital, but losses in confidence can lead to capital outflows. Again, whilst recognising the limitations of archival research, I reference recent work by Langley (2014) and Konings (2015) which both point to a relationship between money and affect. I conclude the chapter with an account of how the Bank's main initiative focusing on confidence is to endorse an increased transparency of balance sheets. Here the Bank itself raises the inconsistency across its different approaches to the transparency of money and enunciation.

8.1 Confidence- an Ambiguous Object of Governance

In *Confidence Games* (2004), Mark C Taylor provides a philosophical rationale behind a recurrent view across differing and disparate accounts of confidence in the social sciences-that it is a response to uncertainty. For Taylor, a postmodern crisis of representation renders confidence integral to contemporary finance. The suspension of gold-dollar convertibility in 1973 and the 'Volcker Shock' of 1979 contributed to the emergence of 'virtual capital and digital currencies' (Taylor 2004:2, 127, 136). When signs and symbols are no longer grounded in anything other than themselves,

there can be considered to be a system of representation that hinges on confidence. Greater complexity brings more volatility which in turn feeds back to stimulates uncertainty and insecurity (Taylor 2004: 22, 301). This suggests that a series of ‘confidence games’ lie at the heart of financial practices.⁵⁴ So for example, the practice of credit rating is underpinned by confidence in the rating methodologies of agencies such as Fitch, Standard and Poors or Moodys (Sinclair 2005). Alternatively, the credibility of central bank monetary policy is underpinned by confidence in the bank’s commitment to an inflation target (Hall 2008). Confidence games within finance are spelled out by Bank of England Deputy Governor Paul Tucker, in light of the Subprime Crisis:

‘In significant degree, financial stability is about safeguarding the stability of private money (deposits with the banking system) relative to central bank money. Prosaically, depositors with banks have to be confident that they can exchange their deposits at face value for our money – our notes; or that they can switch to another bank where they can be confident of that. At the level of the system, we need an “exchange rate” of unity for private money and central bank money. And we need wholesale funders of banks to be confident of that too. When that is secured, demand for our money is low, and society reaps the efficiency benefits of the private sector banking system. Absent that confidence, the payments system simply would not work’ (Tucker Speech 2009a:1).

What this telling excerpt reveals is that the clearest way in which the Bank of England discusses confidence is about preventing bank runs by depositors, despite the fact that for nearly ten years the Bank has been producing FSRs in a format that seems targeted at financial market investors. This suggests that confidence is a mutable object and in the following section I introduce two concepts to better understand this.

⁵⁴ Here there is slippage between a game as used by game theoretical applications in political science (e.g. Snidal 1985) and a more Wittgensteinian conception of a language game (1953:156-157). Describing such as ‘games’ suggests interaction between two or more parties or ‘players’, and perhaps also, alludes to a family resemblance between instances where future oriented practices are underpinned by confidence.

8.1.1 Object –Targets and ‘Inscribing in Reality.’

Having reprised arguments that confidence underpins the modern financial system and its web of credit relationships, I now move onto consider more closely how it is that confidence is governed. Here I make use of two conceptual innovations from Ben Anderson’s recent work on encounters with affective life (2014). The first problematic is *object-target*. By this, Anderson seeks to rethink and describe the way that affects are known and become both objects and mediums for forms of intervention that aim to produce and reshape life (Anderson 2014: 19). I use this concept to think about confidence as an ambiguous object-target. I present a section from the FSR of May 2008, in which the Bank of England identifies ‘confidence’ as an object-target for responses to the failure of Bear Stearns:

‘Actions are needed to bolster *confidence*. Central bank measures to address liquidity problems are an important component’ (of a response) (FSR 2008a: 5). As the then Governor of the Bank confirms, ‘central banks are currently at the heart of efforts to restore confidence in the banking system by the provision of liquidity against assets which have proved to be highly illiquid’ (King Speech 2008b:5).

The second conceptual point is something that Anderson reads in Foucault’s *The Birth of Biopolitics* (2008), that is to say, the idea that such object- targets are ‘inscribed in reality’ through apparatuses means that rather than being something we can look for in itself, they are known through the system of relations between heterogeneous forms that seek to utilise, organise, govern and capture them. The argument then, is that the Bank of England governs confidence as a somewhat ambiguous object-target. At times it seeks to govern confidence as a psychological object, at other times it is treated as an emotional thing (Anderson 2014:25). But in addition to this, the Bank of England appears to ascribe a vitality and materiality to confidence.

8.1.2. Confidence as Psychological

The first notable account of confidence which takes a psychological perspective is that in John Maynard Keynes’ seminal macroeconomic treatise *The General Theory of Employment, Interest and Money* (1936). Here Keynes characterises investment in a capitalist and entrepreneurial economy as being driven by ‘a spontaneous urge to action rather than inaction, and not as the outcome of a

weighted average of quantitative benefits'. Instead 'animal spirits' were crucial to understanding present decisions about financial futures (Keynes 1936: 161). For Keynes, uncertainty about the future leads to myopic herd behaviour in markets, and a 'liquidity preference' which is the tendency to hoard liquid capital and assets to mitigate against an uncertain future. As Jocelyn Pixley points out, although Keynes does connect emotions to uncertainty, he does so by starting with individual psychological feelings (Pixley 2012: 16). For Pixley, Keynes' error is to 'impute group characteristics from groups of specific economic individuals' (Pixley 2012:56).

In recent years, aspects of Keynes' work have been rehabilitated by behavioural economists such as Akerlof and Shiller (2009:14) who assume a 'bounded rationality' to human decision making. For behavioural economics, psychological and cognitive factors affect economic decision making. People are said to be cognitively limited and so make decisions by drawing on rules of thumb, emotional drives and stereotypes. Confidence then goes 'beyond a rational approach to decision making' (Akerlof and Shiller 2009:13). Akerlof and Shiller think of confidence in terms of 'trust' and Keynesian 'animal spirits' (Akerlof and Shiller 2009: 12-13).

Indeed, there are certainly times when the Bank of England has conceptualised confidence in explicitly psychological terms. For example, the following (recent) extract appropriates Keynesian terms:

'Let me tackle the confidence channel first. Most likely, this was at its strongest when the Bank first began asset purchases. The novelty of the instrument and the MPC's readiness to act quickly to loosen policy further at a time of ultra-low interest rates no doubt acted to lift "animal spirits". This effect has probably become weaker as QE has become part of the policy landscape' (McCafferty Speech 2013a:7).

Similarly, anthropologist Douglas Holmes provides a quotation from a Bank of England MPC member that suggests that the Bank of England explicitly governs confidence as if it were a psychological phenomenon. And, on this point, Holmes presents an interview with Professor Besley, a Monetary Policy Committee member who travels out to talk to regional business for the purpose of feeding input into monetary policy decisions:

'Professor Besley then made an ethnographic assertion, noting that during his sojourns in the field, what he was able to observe was the ebbs and flows of what he termed "the currency of confidence," a phenomenon which was not fully nor necessarily evident from

his conventional purview as an economist: ‘We hear time and time again the currency of confidence is hugely important to people who run businesses. Something I perhaps learned as an economist, we do talk about animal spirits and we talk about the psychology of confidence but it is something I guess I hadn’t quite appreciated as much as I do now as I go on the road (Besley 2009)’ (Holmes 2014: 18).

Having said this, while this psychological perspective does feature in the Bank of England, it is not possible to say that this is the only conceptualisation of confidence that the Bank of England and its staff are working with. Langley points out nicely that although the 2007-2009 Global Financial Crisis provided psychological behaviourism with an intellectual traction point, governmental interventions which attempted to ‘work on and through’ confidence did not ‘draw on a clear body of (behavioural) economic thought’ (Langley 2014:15). Instead then, we see a second dominant conception of confidence, that of an emotion.

8.1.3. Confidence as Emotional

Economic sociologists, such as Pixley, provide an argument that undermines another behavioural characterisation of confidence, used by figures such as Alan Greenspan and Charles Kindleberger as ‘irrational exuberance’ (Shiller 2000). For Pixley, effective decision making about the future, so important to investments and expectations in finance, requires a combination of what have traditionally been thought of as rationality *and* emotions (Pixley 2012:11). The ‘truly rational’, against which emotions are compared, should therefore be considered to be a chimera. Instead Pixley highlights ‘social emotions’ which are a rational response to ‘Knightian’ uncertainty⁵⁵ thrown up by the future.

While ‘risk’ can be attached to known or expected losses, it differs radically from the unknown and unmeasurable chance of uncertainty (Pixley 2012: 56). As such, uncertainty is a cognitive gap bridged with impersonal trust in the system, based on emotions. On this reading, finance has always involved future oriented emotions (Pixley 2012: 5). Pixley argues that money is based on the social emotions of trust and distrust and the ‘institutionalised emotional reason to act in the absence of contrary evidence’ (Pixley 2012:14, 40).

⁵⁵ This is a radical uncertainty where we cannot assign probabilities to future outcomes of our present actions (See Davidson 1991 or Beckert 1996).

However, it is not clear that the Bank of England attempts to govern confidence in Pixley's terms as a 'social emotion' on a par with trust. Consider (the current) Chief Economist at the Bank of England, Andrew Haldane's thoughts on the impact of the credit crunch following Lehman Brothers' bankruptcy:

'Confidence and trust are subtly different concepts. Confidence derives from observable, authoritative proof. At the time of the failure of Lehman Brothers, people struggled to make sense of the state of the economy and financial system. Without a compass, they lost their financial bearings' (Haldane Speech 2009e:7).

Contra-Pixley, Haldane maintains the distinction between trust and confidence because: 'When authoritative proof is absent, confidence collapses. Trust instead is 'altogether different' because it is said to be based on' beliefs and perceptions rather than evidence and observable proofs'. As Haldane pushes the point further, one can have confidence without trust: 'A clean balance sheet might instil confidence, but it need not repair trust. Because it is a moral judgement, repairing trust can be a slow and painstaking business' (Haldane Speech 2009e:8).

Haldane's invocation of 'authoritative proof' strikes more of a chord with Richard Swedberg's account of confidence in finance (2012). Swedberg, taking his cue from a close reading of Bagehot, makes two important claims about confidence. The first is that although confidence does have the psychological side painstakingly drawn out by behavioural accounts such as Akerlof and Shiller, Swedberg emphasizes that confidence 'also has a distinctly sociological side' (Swedberg 2012:105). While Swedberg concedes that confidence is far from being well understood, he tries to sketch out a definition in the following way:

'Confidence is an actor's readiness to base his or her decision to act not on the best available information about some state of affairs (because this is not available to the actor) but on proxy signs that signal what this state of affairs is' (Swedberg 2012: 74).

'Proxy signs' are important for Swedberg's account and can be official, such as a Financial Stability Reports, or unofficial signs, such as articles in the business press or 'gossip from an acquaintance' (Swedberg 2012:74). Secondly, Swedberg attempts to analyse confidence as having a 'double structure.' If the proxy sign says that the economic situation is negative, while it actually is positive, we have the self-fulfilling prophecy of a distressed institution. Swedberg then argues that if the

proxy sign indicates that the economic situation positive, and also there is a positive economic situation, then there is full confidence and no problems. There are similarly no problems when a proxy sign says that the economic situation is negative and it is negative. Real problems exist, according to Swedberg, when the proxy sign is positive and the economic situation is actually negative. The existence of '*hidden losses*' means that it is not known who has accrued losses and who has not, 'and in which an accident may set off a general panic that endangers the whole financial system' (Swedberg 2012: 75-76). Swedberg then, seems to give us an account of confidence in which panic and confidence are two parts of a binary opposition and there is a link between proxy signs and confidence.

The Bank of England's recent thoughts on housing bubbles have revealed that at times they do work with a seemingly sociological conception of confidence, in which the emergence of hidden losses prompted a 'decline in confidence'. Miles' speech from 2013⁵⁶, discussing housing bubbles in advanced economies, is one such example:

'Housing was at the centre of the financial train wreck of 2007-08 that has seriously damaged most rich countries. In many countries the effects of that crisis on the wider economy have been large, negative and persistent. In some cases sharp declines in house values and steep increases in defaults on mortgages were causal factors behind the problems for banks which then affected credit conditions and confidence more widely. The USA, Spain and Ireland fall into this category. In other countries the fall in house values and the rise in bad debts has been less severe and was more a consequence of the catastrophic decline in confidence that came in the wake of the financial problems and which led to a reduction in incomes and higher unemployment. Perhaps France and the UK fall into this category. Some countries have experienced few problems – house prices have not fallen and arrears and defaults on home loans have not picked up significantly – Canada and Germany are in this group' (Miles Speech 2013e: 2).

Despite previously providing evidence that confidence is governed as a psychological object, Douglas Holmes also goes on to sketch out an account which is closer to the sociological account of confidence. This approach critiques psychological accounts by arguing that:

“‘changing stories’” and “‘thought patterns’” don't reside just in the minds of individuals, as

⁵⁶ See <http://www.bankofengland.co.uk/publications/Documents/speeches/2013/speech694.pdf> for reference.

Akerlof and Shiller would have it, but are wired in, as it were, to vast communicative fields in which ideas and information are malleable, continually configured and reconfigured by networks of interlocutors' (Holmes 2014:29).

Holmes' work is, *prima facie*, difficult to categorise. While previously, Holmes provides evidence that the Bank of England governs confidence as a psychological thing (2014:18), here he is seemingly closer to a sociological account because he describes confidence as 'a *dynamic communicative phenomenon* enlivened by diverse and often contradictory emotions and *not merely or necessarily a psychological disposition that can be abstracted from the settings in which it is articulated*' (Holmes 2014:37). Here I think it is most faithful to the text to characterize Holmes' approach as being within the sociological because, for Holmes, 'confidence' is treated as on a par with 'trust' and 'emotions.' Confidence and trust clearly do have sociological elements such as emotions. However, there is one more characterisation in the financial stability archive that I will now discuss alongside emotions and psychological imperatives.

8.1.4. Depiction as if a Material Object-Target.

So, although there is a strong indication that the Bank of England has at times governed confidence as a psychological and emotional object-target, I make the case that a third conception of confidence is also needed to capture the way in which confidence is inscribed through reality and governed. This, then, is a third manifestation of the ambiguous object-target of governance. As Andrew Large points out during a period of relative stability, confidence is an ambiguous concept but is something that can be encountered "although its (confidence's) definition has been an elusive subject of endless fascination to generations of commentators... it is hard to define, but recognisable when encountered" (Large Speech 2004a:3).

However, that said, there is enough in my financial stability archive to associate confidence with a conceptualisation or understanding in material terms. In 1999, for example, Eddie George uses his high-profile Mansion House Speech to discuss recent global turmoil, namely the impact of the Asian Financial Crisis, and the collapse of LTCM and Russia's sovereign debt default. Governor George makes references to confidence in starkly material terms:

‘In our case, in marked contrast to the Eurozone, and despite the dampening effect of an already exaggeratedly strong exchange rate, we were confronted, in the early part of last year, with the prospect of excess demand an accelerating inflation, and policy had been tightened to head that off. But we, like others, were then hit in the autumn by the renewed turmoil in the global economy. That caused a sharper fall in external demand, but it also caused both business and consumer confidence to plummet- so that prospect of moderate overall slowdown we’d been deliberately trying to engineer quite suddenly threatened to turn into an unnecessarily sharp downturn’ (George Speech 1999i:3).

Likewise, FSR 2003b discusses the impact of a currency and sovereign debt crisis in Argentina at the turn of the millennium on that country’s banking sector and makes the case that:

‘In most systemic banking crises during the 1990s, the central bank has provided liquidity support to problem banks, to offset withdrawals by depositors and other creditors. Central banks have often made losses on this lending for the banks that turned out to be insolvent. Blanket guarantees to depositors and other creditors have also been provided, albeit sometimes temporarily. Confidence in the banking system has usually revived quickly. However, in the more recent Argentinian crisis (2001–2002) a blanket guarantee to liability holders was not given. Such guarantees would not have been credible given that the source of the crisis was the unsustainability of the fiscal position. Instead, to prevent bank runs, a temporary deposit freeze was imposed’ (FSR 2003b:117).

Of interest here, is the remark that confidence can be ‘revived’ because it gives a sense of vitality and energy. I now move on to consider further examples of material terms used to describe confidence.

Spencer Dale, the then Chief Economist at the Bank said the following during the midst of the Global Financial Crisis: ‘Confidence in the very essence of banking- as well as in individual financial institutions, was shaken to its core and measures of financial market risk and uncertainty ballooned’ (Dale Speech 2009a:3).

The ‘shaking’ of confidence presents a materialist conception. Later on, and moving to the context of the Eurozone Sovereign debt crisis, Paul Fisher uses material terms to describe the ‘evaporation’ of confidence and the impact this had on sovereign bond yields:

‘Financial markets have continued to be buffeted by global events over the past year. In particular, the sovereign crisis in the euro area became more acute. It suffered a serious lurch in mid-July when confidence in Italian politics evaporated and Italian and Spanish yields rocketed to record euro area highs’ (Fisher Speech 2012e: 2).

Such terminology is also employed by Fisher to describe the impact of a series of domestic banking scandals on confidence, which is said to be ‘sucked’ out of the financial sector:

‘Financial markets have not just been suffering from external shocks. A series of home-made disasters have also rocked the sector, The UBS ‘rogue trader’, the losses at JP Morgan’s Chief Investment Office, LIBOR manipulation at Barclays...and the mis-selling of PPI. These scandals have helped to suck confidence from the financial sector just when it might otherwise have been recovering’ (Fisher Speech 2012e:3).

Having introduced three understandings of confidence in the financial stability archive, what I now move onto do is to elaborate on two logics through which the Bank of England seeks to target confidence. And, by taking a Deleuzian approach to what I am here calling the ‘Confidence Assemblage’, it is possible to attend to both the ‘machinic’ content of the assemblage, as well as the enunciative or expressive part of it. The assemblage then is one of enunciation, money and confidence.

8.2. The Enunciation – Confidence Relationship

A particularly interesting statement is made in FSR 1999a, which reflects on the 1997 -1999 troubles in emerging market economies. This excerpt makes the argument that: ‘there are ‘limits to the degree of openness that is realistic- the bank must avoid shouting fire in a crowded theatre’ (FSR 1999a: 5. *Box 1*).

This metaphor is interesting on two counts. Firstly, the analogy to 'shouting fire' suggests that a central bank speech act of enunciation can have an effect on an audience, although it is not clear here if the intended audience is everyday depositors or professional investors. Secondly, the Bank of England is invoking panic, a result that is not wanted in either a financial market or at a deposit taking bank. This, then, is an understanding of the performativity of the enunciation, such as 'shouting fire', as leading to the effect of causing panic. And here, a close reading of Sine Norholm Just (2015) draws our attention to the possibility that the relationship between enunciation and confidence may be affective. A concern for affective life attends to the material energies that pass between two or more objects and are felt at an individual level (Norholm Just 2015; See McCormack 2012, 2015). In Sedgwick's terms, affects are manifest as 'free radicals'- attaching to and 'intensifying or changing almost anything' (Sedgwick 2003:62). Norholm Just has as her focus the complex relation between the 'material energy' of signs and their 'rhetorical form' in the context of Bank of International Settlements statements (Norholm Just 2015:31). In other words, the circulation of rhetorical signs within assemblages, and the way in which these 'signs are imbued with affective charge', is said to be important for understanding the outcomes of assemblages (Norholm Just 2015:35). Drawing on Sara Ahmed (2004), it is through the process of circulation that affect is built and becomes 'effective as a social and political force' (Norholm Just 2015:26). And, while the archive I developed cannot support a position on this, I have highlighted its emergence in secondary literature as it is a suggestion that emerges in literature discussing money and confidence. In the following section I consider the way in which the Bank acknowledges this line of flight or propensity for deterritorialization that accurate statements about bank solvency or liquidity can have.

8.2.1. Enunciation and Deterritorialization

As Samuel Knafo (2013) has argued about the Gold Standard in the Nineteenth Century, it is a misunderstanding of liberal economic governance to view the Bank of England's financial stability work as being descriptive or passive, rather than a strategy of active management of the relationship between statements and confidence. The emotions, psychological imperatives and material energies, such as confidence, targeted by Bank of England have the propensity to deterritorialize and escape- becoming something unwanted and unpredictable.

While Holmes argues that monetary policy assessments from central banks are underpinned by transparency, the same cannot be said for FSRs (Holmes 2006: 398). This is because, as the Bank of England recognises, FSR statements can bring about the panic or instability that they name and thereby contribute to deterritorialization. The Bank of England is clearly and explicitly aware that ‘support from the central bank may stigmatise a bank and reinforce a loss of confidence, rather than allay it’ (FSR 2007b: 12-13). The sense of visibility or transparency is reiterated by the metaphor that:

‘unfortunately, the signals provided by the IMF’s involvement are likely to be mixed. Recourse to the IMF generally occurs only when the patient is in need of intensive care. As Radelet and Sachs (1998) suggest, the ‘arrival of the IMF gives all the confidence of seeing an ambulance outside one’s door. So, news that the IMF is willing to provide assistance may be overshadowed by the news that the country needs it’ (Brealey Speech 1999a: 289).

Making it clear that a financial institution is under substantial pressure is clearly recognised to have the potential to add to that pressure further and deterritorialize money and capital.

8.2.2. Mitigating Deterritorialization

This performative force has implications for the accuracy of FSRs and other Bank statements. The way in which material energies can exceed the apparatus is actively managed by the Bank of England through three discernible rhetorical strategies.

Firstly, I argue that to demand accurate forecasts from FSRs is misguided when the Bank is strategically employing minimalist language. The way in which the Bank of England actively manages the potentially undesirable perlocutionary effects of FSRs seems apparent in my analysis of the language used in the overviews of the FSRs.

Hindsight is essential for determining what the central bank was attempting to do with the FSR. So in *FSR 2005b*, a period of relative calm in global markets and increasingly large issuance of structured credit products, financial innovation is described as having ‘facilitated risk diversification, allowing banks to transfer credit risks to a wide base of investors beyond the banking system’ (9). Several pages later, the ‘downside risk’ of financial engineering is described as:

‘With structured products which are engineered from instruments that are already leveraged, are signs that the underlying asset pool may be deteriorating. An abrupt swing in financial market sentiment, or deterioration in the economic climate, could create difficulties for firms and lenders, particularly as they increase their exposure to new and more illiquid financial products’ (FSR 2005b: 11).

The eventual outcome of this, in October 2008, was described as the ‘biggest episode of global financial instability since World War One’ (FSR 2008b). The magnitude of the event is contrast with the deliberation and minimalism of the language in the central bank’s enunciations about the future. Any statement by the Bank could exacerbate the magnitude of the ‘credit event’ (FSR 2001a). Illustrative of this is a 2005 comment on the credit ratings downgrade of General Motors:

‘The recent deterioration in the perceived creditworthiness of General Motors, and the filing for protection from creditors by Delphi and Refco have had a short-lived impact on credit markets (Chart 3). While these episodes highlight the resilience of key markets, they also illustrate some of the channels by which contagion might spread across asset markets and disrupt financial intermediation following shocks’ (FSR 2005b:11).

To relate this to the Sub-Prime Crisis and the Bank of England, undesirable trends are said to ‘merit close monitoring’ or ‘warrant attention’ (FSR 2004a: 10). ‘Abnormalities’, for example in savings rates, are consistently said to cause the Bank ‘concern’ (FSR 2001a: 8). A second example can be found in the first FSR in 2008, in which it is predicted that, ‘the most likely outcome is that market conditions will improve in the period ahead’ (FSR 2008a: 10). It was, however, far from clear that this was the most likely outcome, given that liquidity was becoming a problem following BNP Paribas’ admission that they could not value certain mortgage backed securities.

A further example can be found in FSR 2009a, which is written in the midst of the ongoing Global Financial Crisis. Here the Bank of England is relatively optimistic about the potential losses banks stand to face due to mortgage defaults:

‘Mortgage arrears may generate further losses for the major UK banks, as domestic mortgage lending represents over five times their core Tier 1 capital. But it is not clear

that arrears of even 3% or 4% would necessarily generate substantial losses for banks. Not all cases of arrears will translate into defaults (repossessions). Indeed, the Government has put in place a range of measures to give more protection to households at risk of repossession,⁽⁶⁾ which will tend to reduce the transition from arrears into default. And even in the 1990s, when arrears reached 3.5%, banks' write-off rates on mortgage lending only rose to around 0.3%' (FSR 2009a:15).

This point about language can be further illustrated with a historical example from America. When the 1987 stock market crash⁵⁷, described by Mackenzie and Millo as a moment of 'collective trauma', occurred, the Federal Reserve issued a statement saying that: 'the Federal Reserve, consistent with its responsibilities as the nation's central bank, affirmed today its readiness to serve as a source of liquidity to support the economic and financial system' (Mackenzie and Millo 2003: 135,138; Van Overtveldt 2010: 63). What I want to emphasize here is no reference to the 508 point loss faced by the stock market, or in fact any reference to market distress.

A second rhetorical ploy within enunciation can be identified when thinking about Jacqueline Best's work on the integration of ambiguity into financial governance (2005). For Best, certain ambiguous phrases in the Bretton Woods agreement, such as 'fundamental disequilibrium' allowed governments a flexibility in their policy options (Best 2005: 56). This 'constructive ambiguity' can, I think, be fruitfully modified to a strategic ambiguity.⁵⁸ This is a particular example of Holmes' notion of 'representational labour' and relies on a recognition of the performative nature of speech acts and the perlocutionary effects that they can have (Holmes 2014: 192). This strategic logic at play with the reference to ambiguous 'credit events' (FSR 2001a: 11). To explicitly specify the event may lead to heightened distress should such an event actually occur. This ambiguity then, is a way of managing the often antagonistic relationship between language and affect in central banking communications.

⁵⁷ The Dow Jones Average fell 580 points on one trading day (Greider 1987, 715).

⁵⁸ See Braun (2015:374) for a recent discussion of 'strategic ambiguity' in monetary policy at the European Central Bank. I have since attended a public engagement 'Open Forum' at the Bank of England, which demonstrated a related feature of 'managed transparency' through the screening of previously submitted questions for Bank staff.

FSR 1999b, reflecting on the academic literature on lender of last resort functions of central banks , makes the case for a constructive ambiguity, which underplays risk, within central bank discourse. This document highlights the performative impact of liquidity support:

‘ambiguity regarding whether intervention is actually taking place, which implies that liquidity assistance may be provided covertly, might be desirable... where, due to the bank’s size and operational ramifications, the handling of an individual bank’s problem risks itself triggering systemic repercussions (Enoch, Stella, and Khamis, 1997). The rationale for this type of secrecy, in circumstances where wide-spread panic has not yet occurred, was, for example, set out in a speech by Eddie George, Governor of the Bank of England, where he stated that: “...we usually try to keep the fact that we are providing systemic support secret at the time... If people know that we are so concerned about systemic fragility that we have judged it necessary to provide support, that could lead to a wider loss of confidence. They would wonder how far that support would be extended, and we could rapidly find ourselves in the position where we were in practice underwriting all the liabilities of the banking system” (George, 1994)’ (FSR 1999b:160-161)

A further example can be taken from FSR 2007b, released at a time when a fall in confidence in asset- backed securities was leading to a shortage of money market liquidity, glosses over the potential market distress that was to follow. The Bank of England here uses ambiguous phrases such as ‘some changes’ to ‘bank business models’ having the somewhat ambiguous ‘implications’:

‘The UK and international financial systems have faced a severe test in recent months. Banks heavily reliant on the ‘originate and distribute’ business model have been particularly exposed to disruption in asset-backed securities and wholesale funding markets. The turmoil has also revealed significant weaknesses in the financial system, including inadequate credit and liquidity risk management and an excessive reliance on rating agencies. Banks are likely to make some changes to their business models in light of these events. Their choices will have implications for the rest of the financial system, including for the availability of credit to the household and corporate sectors’ (FSR 2007a: 40).

Similarly, in the second FSR of 2007, we can find further ambiguous language when discussing key ‘vulnerabilities’ to the UK financial sector. This includes ‘uncertainty...over whether both credit and liquidity risks in different markets are appropriately priced’ (FSR 2007b:47). When discussing the ‘possible under-pricing of corporate default risk’ and household credit risk, the Bank of England is non-committal (FSR 2007b:47). The reader is also told that ‘large and complex financial institutions *could have a large, unanticipated* impact on other financial market participants’ (FSR 2007b:47*emphasis added*). Finally, the FSR argues that ‘disruption to the core parts of the financial infrastructure *could have* pervasive effects on the financial system, which owners and users of these systems may not have fully prepared for or insured against’ (FSR 2007b:47). In this FSR then, is the language of uncertainty, possibility and could have.

Two years later, and still during the Global Financial Crisis, there is an example of such constructive ambiguity, in which the Bank of England does not commit itself to any clear estimate of the amount that subprime mortgage arrears will go up by and what the consequences thereof will be for commercial and investment banks:

‘Economic theory suggests that a number of macroeconomic variables are important drivers of mortgage arrears. Unemployment, housing equity, levels of debt and interest rates are all likely to influence the path of arrears. Given the severe economic downturn, it seems likely that mortgage arrears will rise going forward, though *there is uncertainty about by how much and the consequences for banks’ losses*’ (FSR 2009a: 15 *emphasis added*).

A third rhetorical strategy used by the Bank of England is to attempt to draw a distinction between risks and crystallisation of them. One example of this is present in the Bank’s management of the seemingly inevitable default risk of Eurozone Sovereign debts in 2010. In such a way, even though:

‘Banks face a number of risks from fragile international financial markets. Any sustained reappraisal of risk appetite would reduce the valuations of banks’ risky assets, which could impact on solvency positions. Falls in market liquidity could reduce recent buoyant revenues from trading activities. And disruption to key funding markets could heighten the significant refinancing challenge facing banks internationally. But a crystallisation of these risks is not inevitable’ (FSR 2010a:34).

Seemingly here, then, is a distinction between a risk as an assemblage of enunciation, and the crystallisation as the materialisation or enactment of the event. Although some of the risks and vulnerabilities raised by the Financial Stability Reports did ‘materialise’ in subsequent years, in a process consistently referred to in the reports as ‘crystallisation’⁵⁹, the reports explicitly emphasise that their forward looking warnings concern ‘tail risks in the probability curve’ (FSR 2006; FSR 2008b). Such tail risks are outside the normal distribution in a probability curve. I wonder here though, when we push away at it, whether or not this invocation of ‘tail risks’ sees subjective probabilities enter the picture. This is because, as Andrew Haldane argues, ‘which point to choose – indeed, which distribution to choose – *is a matter of judgement*’ (Haldane speech 2009c:5-6). So while 90% of the values lie within the normal distribution, the question is how *confidently* can people assign 1.65 standard deviations to a series of risk scenarios? More philosophically, what is it that counts as ‘normal’? And indeed, academic practitioners argue that when dealing with more qualitative data, ‘no amount of analytical smarts can extract useful information about “true” risk from a series of a few dozens of data points’. Furthermore, ‘tail shape is notoriously difficult to estimate; with a few data points it is even doubtful whether one has *any* tail observations to look at’ (Landoni and Sastry 2013: 2).

To conclude this section on enunciation, it is important to remember that to draw on Deleuze and Guattari’s assemblage thinking, as Norholm Just does, then one must attend to both the assemblages of material content, as well as assemblages of expression. Martijn Konings captures this when he argues about the dollar that ‘money ... commands an extraordinary affective force’ (Konings 2015:131). Indeed, as Norholm Just argues, material incentives are important for explaining support for a particular sign (2015:38). In keeping with Deleuze and Guattari’s conception of the assemblage, I place a greater emphasis on the role of materiality in the assemblage. Here I argue that the Bank of England works with the recognition that the ambiguous concept of confidence targeted by Bank has the propensity to deterritorialize or exceed the state apparatuses that seek to govern them. This is borne out in the way that the Bank employs rhetorical strategies of minimalist language, ambiguity and draws a distinction between risks, and the materialisation of these risks. However, I now move onto the second aspect of the confidence assemblage, the relationship between money and confidence.

⁵⁹ The way the Bank consistently talks about the way that vulnerabilities ‘crystallise’ captures the sense of ‘good circumstances, even luck, that is, on an external reality’ needed for perlocutionary effect (Butler 2010:151).

8.3. The Money – Confidence Relationship.

‘Adequate capital and liquidity including for stressed circumstances, are the essential ingredients for maintaining confidence’ (Tucker 2007c: 9-10).

Paul Tucker’s comment during the emergence of the Subprime Crisis provides a clear example of a significant aspect of the subprime *dispositif* that Paul Langley (2014) draws our attention to most clearly with his invocation of a capital-confidence- life relation. Further, an historical analysis of the FSRs demonstrates that the Bank of England has long worked with the assumption that there is a relationship between capital and confidence. In 1997 for example the Bank of England discusses how a credible stress test would be set up which captures a loss in confidence following widespread capital losses:

‘We find that the circumstances which would create such a substantial decline are a ‘triple whammy’ combining the spread of discounting which features in all our scenarios; a housing market boom and bust; and a substantial erosion of the retail franchise due to increased competition in retail deposit markets...in this case, the total risk weighted capital ratio of our typical lender falls to around 3%. While the lender would still be solvent, such an outcome would severely shake the confidence of depositors and the markets’ (FSR 1997a: 45).

A year later, the very same logic reappears in a speech by Eddie George discussing capital outflows Malaysia during the 1997 East Asian Crisis:

‘Alternative external financing need not come solely from the public sector. Private finance would, in principle, serve the same purpose, and in many situations market price adjustments may be sufficient to stem the capital outflow. But given the extent of the loss of confidence in the present case it would be optimistic to think that other private lenders were queuing up to volunteer to stand in place of those that are rushing for the exit. In practice in the present situation private support means persuading existing creditors that their assets will be better protected if they are prepared to leave them in place. And they may be prepared to do so, if all other major creditors agree to do the same, especially if

official support is being made available in parallel. But in this case, too, difficult judgments have to be made. There is a danger that, if private creditors have to be in effect coerced into staying put, they will immediately cut their positions elsewhere, while they can, adding to the international contagion' (George Speech 1998b: 5).

Here, then, is an unproblematic statement that 'loss in confidence', is linked to 'capital outflow' of investors 'rushing for the exit'. Such a problematization of the global financial instabilities experienced in the mid-1990s were in the terms of a money-confidence relationship. For example, in 1999 the Bank of England makes the case that financial stability 'entails the financial sector as a whole being sound, with *confidence* in its ability to meet its obligations' (FSR 1999a: 5). FSR 1999a also shows that the Bank of England is aware that the loan packages used during the economic turmoil in emerging markets in 1997-1999 stimulated confidence:

'The IMF loan was part of a US\$41bn *package* put together by a range of multilateral organisations. The lending was staggered with some US\$9bn of IMF assistance available immediately. The IMF programme set out detailed projections for Brazilian debt dynamics. These suggested that –if confidence returned- debt would stabilise without the need to draw down on any of the loan *package*' (FSR 1999a: 8).

In this document, 'package' is used repeatedly and is also referred to as a 'buffer.' It would then seem that this capital 'package' is working as an important operator in the 1999 discourse. Moving forward to 2003, the Bank has made it clear that 'one goal of crisis resolution is to reduce the disruption to the payments system and damage to confidence in the financial system as a whole' (FSR 2003b: 109). Likewise, in 2005, the Bank makes the case that the role of central banks is vital in this governmental strategy because 'confidence in the modern financial system is underpinned by the preparedness of central banks to lend against such high quality security without question' (FSR 2005b:79).

If we consider an extended extract from the Global Financial Crisis, we can see a Bank of England analysis in which there is a relationship between asset losses and confidence:

'To begin with, a further rise in defaults in a sub-sector of the US mortgage market prompted a general loss of confidence in asset- backed securities and other structured credit instruments, including those based on unrelated markets. Investment vehicles with exposures to these assets found it much harder to fund themselves in asset-backed

commercial paper markets. These events led to a seizure of international money markets as banks hoarded liquidity in the face of a reduced ability to continue securitising loans and the potential activation of credit lines to their off-balance sheet vehicles' (Bean Speech 2007c:6).

During the Global Financial Crisis, the money- confidence relationship also has implications for setting the mandatory amount of capital aside as buffers against adverse economic conditions:

'Higher capital buffers would improve confidence by increasing banks' resilience to sudden changes in market sentiment and by strengthening their capacity to handle a potential downturn in the macro economy. Some banks have already begun to bolster their capital positions' (FSR 2008a:13).

Furthermore, this thought is reiterated 3 years later in an FSR discussing suggested changes to regulatory capital regimes during a period of concern for Banks in the Eurozone:

'The regulatory capital regime is designed to require banks to fund their assets with sufficient capital to maintain confidence in their solvency. But if investors lose confidence in the design of the capital adequacy regime itself, this can pose risks to the resilience of the financial system (FSR 2011b: 38)...the methods used by banks to calculate risk weights, particularly those calculated using internal models, are opaque to investors. Market intelligence suggests that this opacity has led to a lack of confidence in risk-weighting methods and could be undermining market confidence in the capital adequacy of banks' (FSR 2011b: 50).

This relationship is present in many of the speeches made more recently, for example, Taylor's discussion of bank capitalisation in the UK and Eurozone:

'Some of the banks, while accepting that their past undercapitalisation had been a major cause of the crash, argued that correcting the position too rapidly risked holding back their ability to lend, and thus jeopardised the economic recovery. In general, though one certainly needs to be sensitive to the pace of balance sheet repair, the opposite has proved

to be the case. An undercapitalised bank is in no position to extend credit, while a stronger capital base gives the management of a bank more room for manoeuvre and more confidence' (Taylor Speech 2013a:4-5).

New Governor Marky Carney reiterates this rationality of governance when discussing the role that capital adequacy ratios have in a sustained economic recovery. The point that Carney is making is that the rebuilding of confidence is linked here to the imposition of capital adequacy ratios of 7%:

'We are building confidence in banks so they can serve the needs of the real economy by providing credit to those who can put it to work. In particular, we have required banks to repair their balance sheets so that their capital ratios at least reach a threshold of 7% by the turn of the year. Crossing these two 7% thresholds is necessary to ensure that our economy can withstand the inevitable bumps along the road to full recovery' (Carney Speech 2013b: 3).

To draw on secondary literature to say something about confidence in this relationship, I turn to Paul Langley's (2014) account of confidence as affect in the Global Financial Crisis. As I read it, Langley interprets Hank Paulson's argument to Congress that he needed an 'unspecified... bazooka' of capital to have a quasi-causal effect which would increase 'confidence' (Langley 2014: 137). And, as the Bank of England put it when reflecting on the need to bail-out private banks during the Global Financial Crisis:

'Many banks did not build up large enough capital buffers in benign times to ensure that they could maintain market confidence when conditions eventually reversed. As a result, large-scale injections of capital — often underwritten by the authorities — have been required into banks that had previously been considered adequately or well capitalised' (FSR 2008b:41).

An explicit declaration of Langley's intuition about the relationship between money and confidence is also to be found archived on the Bank of England website, this time in the context of capital adequacy ratios and the stress testing of American and European Banks following the Global Financial Crisis and Eurozone Debt Crisis: 'To increase the numerator, you have to increase capital (equity plus qualifying debt). This is the loss absorbing and confidence-inspiring stuff' (Jenkins Speech 2011e: 2).

Elsewhere, Martijn Konings has argued for the central role of affect within the logic of contemporary capitalism is such that:

‘the dollar has emerged as a fully iconic sign, organizing a paradoxical economy of simultaneous centralization and decentralization ‘endowed with a power that is both centripetal and centrifugal’⁶⁰ (Mondzain 2005,146) and so serving as the pivot of ‘an immense force field of affective power’ (Buck Morss 2007a, 178)’ (Konings 2015: 118).

Alongside this I am mindful of a passage from *A Thousand Plateaus* in which Deleuze and Guattari characterise the role of ‘the number’ at the disposal of the state apparatus which:

‘in developing utilized all the calculation techniques that were springing up at the border between mathematical science and social technology... Thus the number has always served to gain mastery over matter, to control its variations and movements, in other words, to submit them to the spatiotemporal framework of the state- either the imperial *spatium*, or the modern *extensio*’ (Deleuze and Guattari 1987:429).

So, while detailed textual analysis suggests that the Bank claims that there is a relationship between money and confidence, the secondary literature of Langley (2014) and Konings (2015) argues that this is a relationship between capital and affect. And while the archive I developed cannot support me to take a position on this, it is worth noting that this idea has also been suggested in literature discussing discourse and confidence. In the following section, I argue that for the Bank of England, the money-confidence relationship is unpredictable and can move in directions neither wanted nor anticipated.

8.3.1 Money, Confidence and Deterritorialization

Here I want to make the case that as far as the Bank of England is concerned, the relationship between capital and confidence is unpredictable and that the ‘energy of the sign’ exceeds its ‘rhetorical form’ (Norholm Just 2015:32), in this case the numbers or capital. In such a way, confidence is also said to affect levels of capital. In other words- and on this understanding- as a composite part of the assemblage, confidence has a life of its own and can deterritorialize.

⁶⁰ By using earlier using the phrase ‘liquid and solid’ instead of ‘centripetal and centrifugal’, Konings signposts the duality of money, that it is both a ‘complex relational construction’ and ‘a solid objective fact’ (Konings 2015: 17).

Following global economic turbulence of the Asian Financial Crisis, the Bank of England acknowledges that ‘recent theoretical analysis suggests that this catalytic effect (between capital flows and confidence) is fragile and will only work in limited circumstances’ (FSR 2003b: 160-161 *parentheses added*). This fragility is a result of its reliance ‘on part of the financing gap being filled by spontaneous capital inflows induced by the IMF acting as a partial LOLR, but it cannot provide a cast-iron assurance to creditors that they will be repaid and hence may fail to restore confidence and prevent them running’ (FSR 2003b:162).⁶¹

But more than the fragility of the relationship, there is another consequence of holding confidence as an object-target. In this section I use excerpts from financial stability documents to argue that the Bank of England recognises that while the logic between increases in capital leading to an increase in confidence is straightforward, the Bank of England is also attune to situations in which a loss of confidence precipitates a decrease in capital held in financial institutions, consumer spending or investment in assets. For example, in a period in which regulatory powers were being transferred away from the Bank, the then Governor of the Bank of England states that:

‘banks remain of special importance because their balance sheets are still typically dominated by highly liquid deposits financing less liquid assets, which makes banks especially vulnerable *to a rush for the exit if there is a loss of confidence*’ (George Speech 1997b:4 *emphasis added*).

What George is highlighting in the above passage is that a loss of confidence can lead to a withdrawal of more liquid assets, namely cash money in current accounts. As such, in FSR 1999a we find the analysis that:

‘As *confidence* in the Brazilian government’s ability to service its debt fell, capital outflow increased and reserves fell sharply, despite a 20 percentage point rise in interest rates. The collapse in *confidence* was self-fulfilling, as the increase in borrowing cost and capital outflows made it harder for the Brazilian government to service its debt, which in turn reduced the willingness of investors to lend. It is hard to pin down the exact cause of the loss of *confidence*’ (FSR, 1999a: 7 *emphasis added*).

This excerpt shows that confidence can affect capital outflows and that it is hard to specify the ‘exact’ cause of losses of confidence. Confidence, in some sense, seems to have a life of its own.

⁶¹ This important document can be found at <http://www.bankofengland.co.uk/archive/Documents/historicpubs/fsr/2003/fsrfull0312.pdf>

Now I move onto the attempts by the Bank of England to mitigate the material excesses of confidence.

8.3.2. Mitigating Deterritorialization

While both this and the previous chapter make it clear that due to governmental reasoning linking capital to confidence, post-crisis regulation is focusing on capital-adequacy as a means of preventing the absence of confidence, here I want to focus on another emerging and related trend. In 2011, and when facing concerns about the position of a variety of Eurozone banks, the Bank of England argues that:

‘For market discipline to have a chance of enhancing financial system stability, counterparties and investors need to be able to make a reasonably accurate assessment of the financial health of an institution and how that health would be affected as economic and financial conditions change...an accurate gauge of financial health of these institutions – their source of profits, their asset quality, the structure of their funding – is a particularly challenging objective as they, the instruments they hold, and the interconnections among them become more complex (Kohn Speech 2011a: 5).

In such a way transparency is thought to have a disciplining role, in which financial institutions have to post confidence inspiring regulatory capital in reserve. Bank of England staff to emphasize however that ‘although better market discipline may not be sufficient for financial stability, it is essential, and better transparency is a necessary condition for better market discipline’ (Kohn Speech 2011a:4).

Moving forward to a stage where we are not yet fully into Post- Eurozone Crisis era, the Bank of England is focusing on transparency and regulation as a way to augment capital adequacy measures to sustain confidence. For example:

‘To give a specific example where a relatively speedy move to greater *transparency* may help, the FPC has recommended that banks publish leverage ratios from the start of 2013, ahead of the Basel III timetables. These would act as a backstop to capital ratios, which are affected by the risk weights applied to bank assets. In making this recommendation the FPC drew

on market intelligence which suggested that the opacity of the methods used to calculate risk weights has dented confidence in the published data' (Salmon Speech 2012b: 4).

Again, at this point, nearly 5 years after the collapse of Lehman Brothers and 2 years after the height of the Eurozone panic, the Bank of England argues that:

'By improving transparency and, where necessary, prompting balance sheet repair, this has the potential to improve confidence in euro-area banks. Indeed investors drew some comfort from the fact that the ECB would be keen to begin its supervisory role with a credible process; according to surveys, investors typically thought that the assessment would require around €20 billion–€100 billion of new capital to be raised, mainly by German, Italian and Spanish banks' (FSR 2013b:13).

The Bank has by this stage already conceded that 'transparency is not a panacea' (Kohn Speech 2011a: 13), and recognizes that there is an issue with the inconsistency of between this transparency and the Bank's own communication strategy, which can be thought of as ambiguous and as underplaying risks and threats to individual institutions and the system as a whole. As Donald Kohn says:

'To be sure, we need to protect sensitive information about individual institutions, and transparency cannot be allowed to impinge on the give and take of the deliberative process. But the FPC's reporting of its evaluation of systemic risks can play a constructive role in preserving financial stability by shaping private sector perceptions of economic and financial fundamentals' (Kohn Speech 2011a:12).

The Bank then appears to be pulled in two separate directions, with one strategy of ambiguity for its statements about the financial system, and transparency for the levels of regulatory capital held by financial institutions. The Bank's emphasis on transparency then, seems to be arguing for a move which could well expose the performativity of financial instability. To relate to Jacqueline Best's work on the constructive side of transparency, in 2005 she comments that: 'by managing ambiguity judiciously certain financial regimes have thus been able to take advantage of the positive possibilities of ambiguity while mitigating its damaging effects... this is a dynamic and fragile stability' (Best 2005: 149). Transparency threatens to undermine this purportedly fragile stability built on ambiguity.

8.4 Conclusion

A range of statements from Bank of England staff make the case that a functioning financial system is underpinned by confidence. For example, as an extract from a speech by Jenkinson highlights that although ‘a bank may be well- capitalised and profitable with a sound loan book’ a ‘loss in confidence’ in a bank’s ability to produce funds to its depositors ‘can bring down an otherwise viable institution in short order’ (Jenkinson 2008a:2). However, the detailed analysis of statements by Bank of England Staff in which they refer to confidence provides a series of examples that suggest that confidence is an ambiguous object of governance. At times it is discussed as a psychological thing, on other occasions the interpretation is that of emotion. Third and finally, the analogies and metaphors employed to describe confidence apparently ascribe to it a materiality. In the remainder of the chapter I have argued that the Bank of England attempts to influence confidence in the financial system through an assemblage of enunciation, money and confidence. The Bank often suggests that it understands that there are relationships between enunciation and confidence and money and confidence. However, for the Bank, the relationships between enunciation, money and confidence are unpredictable. It can be inferred from statements from Bank of England Staff that ambiguity in Bank statements is, to an extent, desirable, because ‘too much’ transparency can highlight weaknesses at institutions and increase pressures on the financial system. The Bank appears to employ a series of rhetorical strategies to manage this deterritorializing relationship. These include constructive ambiguity and minimalism in language, and the drawing of a distinction between risks and their ‘crystallisation’ (FSR 2010a:34). Here I turned to the claims of Sine Norholm Just (2015) that the relationship between language and confidence is one of affect. While the archive I have studied cannot support this claim, it is worth noting this suggestion as it also appears in secondary literature looking at money and confidence.

By viewing money, enunciation and confidence as a Deleuzian assemblage, it is also important to attend to the relationship between money and confidence. I have presented a series of quotations that demonstrate that there is a line of reasoning within the Bank of England that ‘adequate capital and liquidity...are the essential ingredients for maintaining confidence’ (Tucker 2007c: 9-10). And here I mentioned secondary literature from Langley (2014) and Konings (2015) that this relationship between money and confidence is one of an affective encounter. And again, while the archive cannot show that this is the case, what can be found is suggestive that there also appears to be unpredictability in the relationship between money and confidence. The Bank of England makes

it clear that the 'catalytic effect', between capital flows and confidence, is 'fragile and will only work in limited circumstances' (FSR 2003b: 160-161). While inflows of money can increase confidence, it is also the case that confidence and decrease and in doing so cause capital outflows.

More recently, the Bank of England is focusing on transparency and regulation as a way to augment capital adequacy measures to sustain confidence. The Bank does recognize that there is an issue with the inconsistency of between this transparency and the Bank's own communication strategy (Kohn 2011a:12), which can be thought of as ambiguous and as underplaying risks and threats to individual institutions and the system as a whole. There is, on the Bank's understanding, the distinct possibility that transparency could lead to the deterritorialization the Bank of England seeks to mitigate and avoid.

Chapter Nine -Concluding Reflections on Central Banking and Financial Stability.

9.1 Reflections on Central Banking

This thesis was motivated by the absence of a systematic account of the financial stability functions of central banks because the existing literature focuses on the monetary policy functions of interest rate setting and the shaping of inflationary expectations (Guthrie and Wright 2000; Harvey 2006, 2010; Smart 2006; Krippner 2007; Hall 2008; Holmes 2009, 2014; Mann 2010; McCormack 2012, 2015; Bowman *et al* 2012; Knafo 2013; Braun 2015). Given this relative neglect, both in geography and elsewhere, the thesis makes a straightforward substantive contribution by broadening both theoretical and empirical understandings of central banking.

In following the financial stability reporting of the Bank of England since 1996, it became clear that the thesis would have to mobilize a set of concepts that moved beyond those employed in the aforementioned literature on central banking. Consequently, the thesis drew on the work of Deleuze and Guattari to rework the concepts of performativity and distributed agency, while bringing to the forefront Deleuze and Guattari's insight that both capitalism and the techniques of financial risk management follow an interplay of deterritorialization and re-territorialization (Deleuze and Guattari 1983:250). This interplay means that financial risk techniques secure imperfectly.

In keeping with Elena Esposito's (2013) recent work calling for an extension of performativity to encompass the entire economy, I have broadened the category of performativity to view the performative as instance of an assemblage. Performativity, then, includes lively practices and the purportedly unsuccessful performative utterances described in the literature as 'misfires' (Callon 2010). I have also modified the account of distributed agency provided by existing authors broadly situated in cultural economy, such as de Goede (2012), Langley (2014), Holmes (2014) and Braun (2015). In doing so, I have employed the concept of assemblage, which in the Deleuzian sense is a collection of two interacting segments of enunciation and the machinic. Similarly, and in bringing this concept to the forefront of analysis, I placed great emphasis on Deleuze and Guattari's work on reterritorialization and de-territorialization. I argued that to appreciate the way in which these axes are always present in dynamic tension means that we can only talk of the process of switching

between the two, which I have termed the (in)stability of finance. This (instability) is the continual switching between speculation and hedging inherent in contemporary financial risk management.

The central problematic of the thesis was to explore how the Bank of England publically understood and depicted a range of financial stability techniques, namely FSRs, press conferences, credit derivatives, VaR, stress testing and confidence. This first entailed compiling a financial stability archive of 800 documents, reports and videos from a relatively unstructured collection of 2000 sources on the Bank of England's website. Chapter Four began by concentrating on the changing visuality of financial stability reports during the period 1996- 2005, finding a move towards the calculative and scientific and seemingly aimed increasingly at professional financial investors. Secondly, the chapter argued for a notion of distributed agency because, rather than acting alone in having an impact on financial stability, FSRs tend to work together with other techniques and practices- such as stress testing- as well as in such a way as to consolidate them together and assess their present status as a means for providing financial stability. Thirdly, within this chapter I also documented the way in which the Bank of England holds financial stability press conferences. Analysis of this nature underscores the different layers of performativity at play in central banking. Reiterative practices serve to establish the authority of the Bank Governor and members of the FPC. Further, the analysis of press conferences required a re-working of the concept of performativity in order to account for creativity and improvisation by Financial Policy Committee members when facing questions from journalists. Here I drew on theoretical work from Derrida (1988) and Deleuze (through Thrift and Dewsbury 2000) to give an account of lively practices of disruption, creativity and improvisation in press conferences.

Chapter Five documented the Bank of England's treatment of credit derivatives. It found that during the late 1990s, the Bank of England took a somewhat ambivalent position on credit derivatives by consistently presenting the message that credit derivatives were both an opportunity to make the financial system less prone to collapse and yet were still seen as a potential threat to stability due to a variety of risks. This was interpreted using a critical security studies lens on the dispersive logic of the derivative, and a critical political economy phenomenology of credit risk (Martin 2007; Amoore 2011; Amato and Fantacci 2012). Further, the co-presence of these contrasting views was interpreted as being due to the dual performativity of risk (Wigan 2009). In the early 2000s, this potential danger became predominantly framed as a problem with the complexity of financial innovation. Moving forward to the period in which the Global Financial crisis was fomenting, the Bank of England became increasingly preoccupied with the difficulties that arose in valuing credit derivatives. Following the exceptional government interventions to stave off the crisis, the Bank has

returned to its concern with the complexity of credit derivatives. The Bank's response to this issue has been to argue for greater transparency and standardisation of credit derivatives. I argued that this later discourse followed a logic of reterritorialization and provided support for a final argument that regulatory thinking about credit derivatives followed assemblage thinking.

Chapter Six traced the emergence and development of Value-at-Risk as a proxy measure for the market risk undertaken through trading positions. After initially being sceptical of the ability of VaR to price risk, the Bank later began to champion the accuracy of this probabilistic measure of risk. Financial institutions were encouraged to calculate how much reserve capital they need to held in order to be in a safe and prudent position. In the late-1990s, critics such as *The Economist* magazine criticised the financial industry's use of VaR, blaming widespread use of this device for instability in financial markets. This critique understands VaR as having a destabilizing or deterritorializing effect. In response to this, the Bank of England published an article by an expert on VaR, Phillippe Jorion, in which he argued that there were other desirable attributes besides accuracy. In this article, Jorion used calculations and graphs to argue that the market risk charge derived from VaR did not accurately reflect volatility spikes, but instead had a smoothing effect. However, this was not the only critique of VaR. In the wake of the Global Financial Crisis, the Bank of England itself raised the critique that the problem with Value-at- Risk is its assumption that economic conditions will be normal, rather than extreme. For the Bank, the result of this was a serious under-pricing of risk. This was again analysed as an understanding of VaR as being subject to deterritorialization.

The high profile deficiencies of VaR saw the adoption of macroprudential stress testing of the financial system. This involved the running of a hypothetical scenario of three low probability/high impact events on the balance sheets of the institutions in a financial system. The exercise was supposed to identify existing weaknesses in the system, as well as improving both the quality and levels of reserve capital held in banks. In such a way, stress testing brings imagined and extreme events into provisioning for future instability. The Bank of England's statements on stress testing have suggested an understanding of the stress testing process such that the more rigorous the test, the more effective it will be. Later documents suggested that stress testing development has involved the fusing together of the language of possibility, alongside probability. I analysed this development using Louise Amoore's recent work on the development of risk calculi to include different forms of probabilistic thought, as well as a concern for possible futures. I went onto deepen this inquiry to find in central bank thinking a distinction between hypothetical and plausible stress scenarios used in the tests. In 2013, the Bank of England announced that it initially saw a role within forecasting for plausible stress testing, which was a different position to the Federal Reserve Bank of the USA for

which scenarios needed to be hypothetical. However, the bank of England later changed its position in 2014. In press conferences, senior members of the FPC argued that stress testing had a significant impact on improving reserve capital levels in British banks. In light of the impacts of the test, the Bank said that the stress scenario in place for 2015, of a slowdown in the global economy, was hypothetical and ‘not a prediction.’

Finally, in Chapter Eight I tracked the Bank of England’s statements on confidence. The Bank took what can only be described as an ambiguous position on what sort of a thing confidence is, vacillating between a psychological imperative, an emotion or other times using materialist and vitalist language. During the period of study, the Bank made statements to the effect that confidence can be acted on using two mechanisms, language (or enunciation) and money. The most recent social science literature discussing these relationships (i.e. Langley 2014, Konings 2015, Norholm Just 2015) suggests that this is a relationship between language/money and affect. Here it must be noted that this is not something that the archive allowed me to take a position on. The Bank said that due to the impact that bad news can have on a financial system, it cannot be completely transparent in its reports on the stability of the financial system. Further, the Bank employed ambiguous and minimalist language when discussing financial stability issues. In terms of the relation between money and confidence, the Bank made statements that strongly suggest that its staff think that there is a relationship, repeatedly talking about the impact of injections of capital in raising confidence in the financial system. The Bank also stated that this catalytic effect does not always occur and does not have a specific threshold. The most recent statements on confidence by the Bank seemed to contradict the Bank’s earlier position on the limitations of transparency (Best 2005). The Bank of England made the case that transparency about bank reserve capital can help improve confidence in the banking sector. The Bank acknowledged this issue, but as yet has not been able to reconcile it.

9.2. Reflections on Financial Stability

Investigations into the different techniques from which the financial stability assemblage is comprised have thrown up five different conceptualisations of the term ‘financial stability’. In other words, financial stability is worked on as an object in five different ways. It can be argued that four of these conceptions were in operation before the Global Financial Crisis, with financial stability being both a very public performance by members of the Financial Policy Committee, as well as a fully functioning financial system. In addition to these understandings, two further ways were a dispersal of risk around a market for credit as to make systemic collapse less likely, and something that can be

achieved when individual financial institutions privately price the risks they are holding on their trading books and balance sheets. Following the Global Financial Crisis, the conception of financial stability acted on by stress testing is that ‘aggregate risk’ and therefore stability, ‘lies in the collective rather than individual behaviour of financial institutions’ (Baker 2013a: 115).

Chapter Four’s discussion argued that financial stability is conceived as something that is performed- it is a way of communicating an array of skills and competencies by members the financial policy committee. These officials need to be creative in the light of unexpected challenges, capable of persevering after they make mistakes, as well as understanding the rituals of the central bank as an institution.

As encountered in Chapter Eight, the Bank of England’s statements about confidence suggested that confidence underpins a fully functioning financial system. As Paul Tucker argues in a speech:

‘In significant degree, financial stability is about safeguarding the stability of private money (deposits with the banking system) relative to central bank money. Prosaically, depositors with banks have to be confident that they can exchange their deposits at face value for our money – our notes; or that they can switch to another bank where they can be confident of that. At the level of the system, we need an “exchange rate” of unity for private money and central bank money. And we need wholesale funders of banks to be confident of that too. When that is secured, demand for our money is low, and society reaps the efficiency benefits of the private sector banking system. Absent that confidence, the payments system simply would not work’ (Tucker Speech 2009a:1).

In Chapter Five, I argued that credit derivatives work on financial stability in a way that seeks to disperse and distribute risk around a market for credit. For this conceptualisation, risk can be eviscerated from holding particular assets, chopped up, and moved around, either away from people who are not well placed to bear it, or from areas where risk is becoming too concentrated. In the late 1990s, the Bank of England argued that this ‘this new credit risk management tool should make the global allocation of risk more efficient...the new instruments make *credit markets complete*’ (Goodhart *et al* 1998:94). In other words:

‘Some of the risks previously confined to the banking sector might spread to other economic sectors via credit derivatives, and some commentators question whether this might be undesirable. We think that it would be an advantage, because non-financial

institutions are not a source of systemic risk. If some banking risks can be unloaded onto non-banks, this should decrease systemic risk, rather than increase it. But third parties should be aware of the risks they are taking on' (Goodhart *et al* 1998:96).

The outcome of this technique was hoped to be a financial system in which total collapse was a lot less likely. In Chapter Six, Value-at-Risk was brought into consideration as a technique which worked on financial stability such that it is something that can be achieved when financial institutions privately price the risks they are holding on their trading books and balance sheets. This conception is premised on the hypothesis that 'liquid financial markets are characterised by the efficient processing of all available information, which in turn, would make the actual price of a security a good estimation of its intrinsic value' (Baker 2013b: 420). Value-at-Risk would tell a firm how much they 'would be expected to lose on 12 days out of a year's 250 trading days with a particular set of trades (Triana 2012: xixii).

Following the Global Financial Crisis, staff at the Bank of England begin to publicly criticise Value-at-Risk because 'it is essentially silent about risks in the tail beyond the confidence interval. For example:

'even if a trader's 99% VaR-based limit is \$10 million, there is nothing to stop them constructing a portfolio which delivers a 1% chance of a \$1 billion loss. VaR would be blind to that risk and regulatory capital requirements seriously understated' (Haldane 2012e: 16).

This led to the discussion of Chapter Seven through which it emerged that in order to grasp risks that lie further into 'the tail' of the bell shaped normal distribution of things that could be expected to happen to the economy, the Bank of England began to use macroprudential stress testing. This technique involves the running of a series of extreme scenarios on a simulation of the financial system as a whole. In particular, regulators are interested in the interaction between institutions, following several extreme scenarios. Therefore, stress testing provides a fifth and final conception of financial stability- that 'aggregate risk' and therefore stability, 'lies in the collective...behaviour of financial institutions' (Baker 2013a: 115).

In light of these five different conceptualisations of financial stability, in this conclusion I propose to treat financial stability as not referring to one single thing or state of affairs, but instead as a mutable concept. But, more than this, alongside this mutability we require a term that captures the idea that financial stability is an abstraction of one part of the (in)stability within finance. Stability is isolated

out rather than seen as a process of passing to and from instability, In light of this, and in keeping with the Deleuzian cultural economy I am developing, I make use of the concept of ‘diagram’. As Eugene Young puts it, the diagram refers to ‘that which is invisible and in- articulable but produces visibilities and statements’ (Young 2013:88). In other words, stability is a seemingly ephemeral organising principle. This high level of abstraction of this formulation of the diagram presents the researcher with some methodological problems. Writing about the diagram is extremely challenging, as Rob Aitken outlines in his work on the ‘diagramming’ of fringe finance:

‘the diagram does not refer to any specific configuration of relations—any specific policy or particular practice—but, rather, is a map of abstract relations (‘abstracted from any friction’) which are always taken up in diverse and diffuse ways in practice’ (Aitken 2015: 5).

Perhaps John Rajchman puts it most clearly when he says that the diagram is ‘something at work in many different institutions and situations, spread out in several countries, working in a manner not given in the map of social policies and prescriptions, planned as such by non-one’ (Rajchman 1999:47).

I use the concept of ‘diagram’ to treat stability as system of relations because these five conceptions of stability have only been teased out following empirical analysis of understandings of techniques. So, press conferences allowed me to pull out different conceptions of the way financial stability is performed. Credit derivatives gave an understanding of stability such that risk could be dispersed as to make systemic collapse less likely. Value-at-Risk worked with an understanding that the granular and private pricing of risk would lead to aggregate stability. This idea was challenged by the understanding at play in stress testing, that aggregate and collective behaviour leads to a stable system. Finally, techniques that target confidence are aiming for a tangible state of affairs, the functioning of the financial system. For Deleuze, there is such an intimate relationship between the diagram and the assemblage. In *Foucault*, Deleuze writes that:

‘the diagram acts as a non-unifying immanent cause that is coextensive with the whole social field: the abstract machine is like the cause of concrete assemblages that execute its relations; and these relations between forces take place ‘not above’ but within the very tissue of the assemblages they produce’ (Deleuze 1998: 32).

This, then, means that financial stability is ‘like the diagram of an assemblage. It draws lines of continuous variation, while the concrete assemblage treats variables and organized their highly diverse relations as a function of those lines’ (Deleuze and Guattari 1987: 110-111). The diagram of

financial stability has emerged in the empirical chapters of this thesis (Chapters Four to Eight), within the tissue of each technique that emerges.

9.3. Geographical Significance and Contribution

This thesis makes three distinct contributions to geographical literature on money and finance. Firstly, the thesis modestly contributes to debates within cultural economy itself. So two distinct and often dichotomised approaches to performativity are those widely characterised as Austinian and Generic performativities⁶². By teasing out at least four ways in which financial stability press conferences can be said to be performative⁶³, this thesis provides support for Chris Clarke's (2012) claim that multiple forms of performativity can be co-present and overlapping.

Second, this thesis contributes to cultural economy by adding to work in human geography which seeks to open up cultural economy's agenda to encompass much more than merely a concern with performativity (see Langley 2014). Here my target is political economy oriented authors such as Christophers (2014:12), who apparently make an equivocation between cultural economy and the 'techno-cultural' performativity focus of the social studies of finance. As a modest part of this grander disciplinary project, is the relational approach taken in this thesis. This thesis has opened up the notion of the central bank as a bounded and acting entity to a distributed view of agency and action. And within accounts that do draw on distributed agency and relational thought, such as de Goede (2012), Langley (2014), Holmes (2014) and Braun (2015), the theoretical entry point is more-or-less Foucauldian. What this thesis does then, which is innovative in terms of the existing cultural economy literature, is to draw on Deleuze and Guattari's insight that central banks then are 'defined much more by what escapes them or their impotence than by their zone of power' (Deleuze and Guattari 1987:239). This thesis, then, works with a much more active and influential role of deterritorialization and destabilization than in existing relational work on money and finance.

Third and most substantially, in Chapter One, we saw that the political economy inflected geographical literature has an interest in global and system wide processes and the inherent instability of financial accumulation (Harvey 1982; Aalbers 2008; Dymksi 2009, 2010; Castree 2010). As Christophers (2014:12) points out, the relationship between this literature and cultural

⁶² See, for example the debate in *Journal of Cultural Economy* (2010) between Callon and Butler.

⁶³ through (i) Callon/Mackenzie, (ii) Butler/ de Goede, (iii) Deleuze and (iv) Sedgwick.

economy is one of mutual neglect, if not downright mistrust (Christophers 2014:13). And while Christophers' (2014:12) article does attempt to 'blend' the political economy approach with the 'techno-cultural' consideration of the performativity of markets in order to bring the market into more squarely Marxian accounts, the contribution that this thesis makes is to more systematically connect global capitalist processes to the sort of financial techniques that Christophers identifies as being the preserve of 'techno-cultural' work. In this case, it is the deterritorialization and reterritorialization that Deleuze and Guattari identify within capitalism, that subsequently returns within financial practices and techniques of risk management. In this case, any move, be it territorialisation or deterritorialization, to make future risk actionable will encounter movement in the opposite direction. This manifests itself as the way in which financial risk management secures imperfectly against future problems and therefore such techniques become a constant concern for the regulatory community.

By treating such financial stability techniques as assemblages, and tracing through moments in which the Bank of England recognizes that attempts to remake the uncertain financial future actionable also lose control, I have teased out a process that, for Deleuze and Guattari (1983), is a logic of the capitalist system itself. Capital deterritorializes or destabilizes to seek out profit, but at the same time reterritorialize or stabilize to capture that profit. I read this in the context of modern finance as the dual imperative to hedge against and speculate on future changes in price.

Close analysis of the financial stability archive and what the Bank of England has said about the financial stability techniques of credit derivatives, Value-at-Risk, stress testing and confidence, highlights the recognition or understanding that these techniques involve an interplay of deterritorialization and reterritorialization, or hedging and speculation, with one term constantly passing into the other.

In the example of credit derivatives, we saw that in 1998 derivatives were partly praised for their ability to contribute to financial stability by dispersing risk thereby making both 'the global allocation of risk more efficient and *'credit markets complete'* (Goodhart *et al* 1998:94). However, at the same time the Bank was aware of a number of risks that underpinned the credit-debt relationship on which these credit derivatives were based such as 'the difficulties involved in pricing credit derivatives' (Goodhart *et al* 1998:94). In such a way, the liability structure- that debts have to be paid by someone- was a way of organising structured credit products. During the early 2000s the Bank fixed on to complexity as a way in which credit derivatives escaped attempts to measure and assess risk, for example when it said that:

‘there is specifically a danger that the riskiness of some innovative investment products designed to enhance yield might be underestimated or misunderstood, given the complexity of the payoffs; there is often a small probability of a very large fall in value’ (FSR 2003a:11).

In the middle of this decade, the Bank was facing a global economic slowdown and liquidity squeeze and became more concerned with the valuation of derivatives. Here the Bank reflected that, within the crisis, ‘valuation uncertainty rose sharply, particularly for more complex products where informational problems were most acute, as end-investors lost confidence in credit rating methodologies’ (FSR 2008b: 8-9). This valuation difficulty can be considered to be a deterritorialization (Dodd 2014: 223). Following the aftermath of the crisis, the Bank of England has been preoccupied with the standardisation and transparency of seemingly complex derivative products. With an explicit vocabulary of ‘financial product mark-up Language (FpML) and a “DNA string” for derivatives’ (Haldane Speech 2012a:12) it seems that the Bank is preoccupied with reterritorialization of credit derivatives.

In Chapter Six we saw that at first Value-at-Risk was used in order to measure market risk in a way that allowed risk to be ‘captured accurately’ and with ‘greater sensitivity’ (Clementi Speech 2001b:3). After a period of initial scepticism from regulators, VaR became part of the internal governance mechanisms which financial institutions were allowed to use. In such a way, Value-at-Risk worked with a logic of territorialisation, of organising and stabilizing trading to ‘responsible’ levels of trading. However, in two important ways VaR was viewed as deterritorializing as it territorialised. The financial stability archive provides two clear examples here. The first is that, in the mid-1990s, VaR contributed to global volatility due to its widespread use and the way it effectively prescribed *en mass* cutting of trading positions. The Bank acknowledges but tries to withstand the critique ‘that VaR-based capital requirements experienced sharp increases during the summer of 1998, leading to forced position cutting and increased volatility’ (FSR 2002b:123). So, widespread use of a model can lead to widespread clustering of behaviour in way that leads to bear and bull markets, where investors are either panicking *en mass*, or overconfident and reckless. This threatens the stability or territorialisation. Secondly, and following the Subprime Crisis, Bank of England staff such as Andrew Haldane (2012e:16) acknowledge that VaR’s assumption of normality made it blind to extreme risks- ‘the fatter the tails of the risk distribution, the more misleading VaR-based risk measures will be.’ Widespread use of a model leaves all market participants blind to what

is excluded from the model. Again, vulnerability and instability are argued as being present alongside attempts to stabilize.

Attempts to reterritorialize and fix the flaws in the risk-management technique of VaR led to the introduction of macroprudential stress testing, which incorporates an extreme scenario of three macroeconomic shocks to thinking about future instability. This technique allows regulators to identify weaknesses in the financial system, and to see whether or not individual financial institutions have the reserve capital sufficient to survive such extreme conditions. And, by 2014, staff at the Bank of England were convinced that stress testing has an impact on capitalisation of the financial system as Andrew Bailey argued that:

‘The actions that have been taken in the interim period on adjusting and raising capital and adjusting the capital position of the banking system in this country. That is not a zero impact. It is also in my view an essential component of supporting a durable recovery’ (Bailey Questions and Answers June 2014).

However, here lies a latent process of deterritorialization- if the stress test is performative, that is to say influences behaviour to bring about stability, then it is entirely possible that the extreme scenarios will influence the behaviour of the Bank of England’s audience. People may be alarmed by a scenario of a global economic slowdown. The Bank of England’s current strategy to prevent this from happening is to emphasize that the stress test works with a ‘stress scenario’, that is not ‘a prediction, just to be clear’ (Carney Questions and Answers June 2014). This position may become harder to maintain as the Bank’s scenario for 2015, of a global economic slowdown, did occur.

Finally, Chapter Eight studied the assemblage of money and enunciation that the Bank of England has employed to stimulate confidence. Archival analysis reveals that the Bank publicly reasons there is a relationship between both language and confidence, and money and confidence. However, it is also inferred from the archive that the Bank is aware that statements that are worrying can lead to panic and decrease stability. Here, the Bank said that ‘support from the central bank may stigmatise a bank and reinforce a loss of confidence, rather than allay it’ (FSR 2007b: 12-13). And, when it comes to the relationship between money and confidence, the Bank has said that ‘recent theoretical analysis suggests that this catalytic effect (between capital flows and confidence) is fragile and will only work in limited circumstances’ (FSR 2003b: 160-161). In both of these techniques then, I have argued that the Bank is aware that the emotions, psychological imperatives and energies targeted by the Bank can exceed the Bank’s attempts to govern them. Further, the Bank is aware that transparency of Bank

statements may cause panic, while simultaneously arguing that 'by improving transparency and, where necessary, prompting balance sheet repair, this has the potential to improve confidence in euro-area banks' (FSR 2013b: 13). The Bank is therefore arguing in two different directions. In one sense, transparency is reterritorializing, in the other sense, de-territorializing.

So, what is the consequence of this systematic link between micro techniques and macro processes? Simply put, in this thesis I have argued that finance has, at its heart, a dynamic tension and process of (in)stability, in the continuous dual imperative to hedge and speculate. The thesis can be seen, then, as supporting the somewhat pessimistic argument that any attempt to regulate using the techniques and devices of finance will be prone to the ongoing process of deterritorialization and reterritorialization. And, while we might romanticize about the Keynesian inspired restrictions on certain financial practices that followed the Great Depression and led to a level of stability, Foucault (2008: 68-69) points out that this Keynesian state apparatus eventually restricted the freedoms (i.e. employment and high levels of income and consumption) that it sought to promote. In such a way the stagflation of the mid-to late 1970s can be read as deterritorializing flows of money. Therefore, in keeping with the critical political economy of financial accumulation that the thesis took inspiration from, the (in)stability of finance can only be temporarily managed, rather than fixed (Keynes 1936). What this thesis does share with a Post-Keynesian or Minsky- inspired approach, such as that found in Nesvetailova's (2010a) work, is a healthy scepticism towards the claims of financial innovation to eliminate risk or produce continuously liquid products.

By conceiving of central banks as assemblages of institutions, firms, techniques, technologies and devices, the thesis throws into question the narrative of financial system and regulator as being two separate entities. As Langley (2014) points out, in relation to governance of the Global Financial Crisis, the narrative of sovereign state institutions rescuing finance is a misleading one, especially when we take the Bank of England's own statements, documents and publications at their word. This undermines structural claims about either central bank over finance or vice versa. In sum, geographers need to better understand what David Hudson has called the 'state-market condominium' (Hudson 2005: 65). In other words, geographers and critical social sciences need to say more 'of finance' and devote time and effort to elucidating the sometimes complex but almost always mystifying techniques of financial risk management (See Christophers 2009).

9.4. Avenues for Future Work

In keeping with the final argument of the previous section, I want to propose a research agenda which interrogates financial risk techniques further and through a predominantly geographical lens. Indeed, I would argue that geographers are especially well placed to do this in a way that would extend the scope of the Deleuzian cultural economy that I have started to develop across this thesis. This is primarily because the discipline of Geography has a well-developed tradition for ethnographic research.

Of particular interest would be further research into confidence, of both publics and market investors. For example, while my discussion of the relationships that the Bank of England itself identifies between language, money and confidence did make reference to a growing literature which identifies the affective nature of confidence and finance (McCormack 2012, 2015; Langley 2014; Norholm Just 2015; Konings 2015), it was conceded that archival research alone could not conclusively support or refute these claims. Instead, ethnographic research into the affective life of confidence would be able to push cultural economy in a distinctly Deleuzian direction because it allows one to make materialist claims about energies and atmospheres. I suspect that a re-reading of Deleuze's engagement with the work of Spinoza (Deleuze 1988b, 1990b) could be particularly fruitful here.

Similarly, and again related to the technique of assembling money, enunciation and confidence, it is striking that the Bank of England suggests that it thinks there is a relationship between money and confidence but that 'recent theoretical analysis suggests that this catalytic effect (between capital flows and confidence) is fragile and will only work in limited circumstances' (FSR 2003b: 160-161 *parenthesis added*). Later the Bank of England also makes the statement that:

'As *confidence* in the Brazilian government's ability to service its debt fell, capital outflow increased and reserves fell sharply, despite a 20 percentage point rise in interest rates. The collapse in *confidence* was self-fulfilling, as the increase in borrowing cost and capital outflows made it harder for the Brazilian government to service its debt, which in turn reduced the willingness of investors to lend. It is hard to pin down the exact cause of the loss of *confidence*' (FSR, 1999a: 7 *emphasis added*).

This all suggests that the Bank acknowledges that the relationship between money and confidence is not one of efficient causation, where increasing money always increases confidence. The logical extension of the Bank's very public thinking is that a loss of confidence can similarly have a catalytic

effect on outflows. Now, while it would be exaggerating the claims derived from the financial stability archive to argue that the Bank of England and its staff subscribe to an account of complex causation, I think that future political economy or cultural economy research in economic geography does need to pursue and study how concepts such as ‘resonance’ can be mobilised in our work on money and finance (see Deleuze and Guattari 1987, Connolly 2005 and de Goede 2012).

To turn towards further Deleuzian grounded research into the financial stability techniques I have researched in this thesis, the work on performativity in press conferences in Chapter Four and (peri)performativity in Chapter Eight, have to stop short in making claims about affect precisely because it was not possible to encounter the purported affect in these situations. Therefore, future work could include participant observation in Bank of England press conferences, press-rooms and even newspaper offices, to open up the process of both interactions between media, public institutions and publics (see Velthuis 2015).

A Deleuzian cultural economy has also the potential to contribute to a Deleuzian interrogation of the credit derivative. And while Benjamin Lozano’s (2015) reading of Deleuze as a heterodox political economist attends to the unique materiality of synthetic finance – derivatives formed from derivatives- there are questions to be raised about the materiality of the asset backed security. In particular, there has yet to be a theorisation of what happens to a very material asset, such as a house, when the security is ‘written down.’ Here I would speculate that the Deleuzian category of the ‘virtual’ could be useful. I propose that interviews with derivatives traders would be an initial way to form a theorisation of writing down an asset.

Finally, stress testing is an emerging and developing technique of financial governance and so far has garnered little attention in non-technical social science writing (See Langley 2013b, 2014 and Geithner 2014). In particular, in this thesis I have used the example of stress testing to open up the category of the ‘possible’, which Louise Amoore (2013) has introduced in critical political geography. By opening up two modes of the plausible and the hypothetical, my aim is to carry out future research which asks how do evidence based and premise based security logics relate to money? For example, can the ‘hypothetical’ scenario have as much performative force or propensity to generate material energies as a ‘plausible’ scenario which has money or capital as its underlying evidence? Langley (2014) touches upon this sort of issue in his recent monograph on the governance of the Global Financial Crisis, but as yet this has not been investigated in a systematic agenda.

In short, there is much further work, with a geographical focus, that a Deleuzian cultural economy can add to the study of finance. Further, the agenda that I have proposed promises to take cultural economy in a considerably more materialist, but not deterministic, direction.

Bibliography:

Aalbers, M.B. (2008). 'The Financialization of Home and the Mortgage Market Crisis', *Competition and Change*, Vol. 12, No. 2, June 2008: 148–166.

Aalbers, M.B., Engelen, E & Glasmacher, A. (2011). 'Cognitive closure' in the Netherlands: mortgage securitization in a hybrid European political economy', *Environment and Planning A* 2011, volume 43:1779 -1795.

Ahmed, S. (2004). *The Cultural Politics of Emotion*. (New York: Routledge).

Aitken, R. (2007). *Performing Capital: toward a cultural economy of popular and global finance*. (Basingstoke: Palgrave Macmillan).

Aitken, R. (2011). 'Financializing Security: Political prediction markets and the Commodification of uncertainty'. *Security Dialogue*, April 2011; vol. 42 (2):123-141.

Aitken, R. (2015). *Fringe Finance: Crossing and Contesting the Borders of Global Capital*. (London: Routledge).

Akerlof, G. A. and Shiller, R. J. (2009). *Animal Spirits: How Human Psychology Drives the Economy, and Why It Matters for Global Capitalism*. (Princeton, NJ: Princeton University Press).

Alessandri, P., Gai, P., Kapadia, S., Mora, C. and Puhr, N. (2009). 'Towards a Framework for Quantifying Systemic Stability', *International Journal of Central banking* Vol.5, no.3: 47-81.

Allen, J. (2011). 'Topological twists Power's shifting geographies', *Dialogues in Human Geography*, 1(3), 283-298.

- Allen, J., and Pryke, M. (1999). 'Money cultures after Georg Simmel: mobility, movement, and identity', *Environment and Planning D*, 17: 51-68.
- Ali, R., Haldane, A. G., and Nahai Williamson, P. (2012). 'Towards a Common Financial Language', text of speech to Securities Industry and Financial Markets Association, NY. (London: Bank of England).
- Amato, M., and Fantacci, L. (2012). *The End of Finance*. (Cambridge: Polity Press).
- Amin, A., and Thrift, N. (1994). 'Living in the global', in Amin, A., and Thrift, N. (eds). 'Globalization, institutions and regional development in Europe', (Oxford: Oxford University Press): 1-22.
- Amin, A., and Thrift, N. (2004). *The Blackwell Cultural Economy Reader*. (Oxford: Blackwell).
- Amoore, L. (2005). *The Global Resistance Reader*. (London: Routledge).
- Amoore, L. (2011). 'Data derivatives on the emergence of a security risk calculus for our times', *Theory, Culture & Society*, 28(6): 24-43.
- Amoore, L. (2013). *The Politics of Possibility: Risk and security beyond probability*. (Durham NC: Duke University Press).
- Amoore, L. (2014). 'Security and the Incalculable', *Security Dialogue: Special issue on Preemption, Practice, Politics*, July 7, 2014: 1-17.
- Amoore, L. and de Goede, M. 'Governance, risk and dataveillance in the war on terror', *Crime, Law and Social Change*. 2005; 43: 149-173.
- Anderson, B. (2007). 'Hope for nanotechnology: anticipatory knowledge and the governance of affect', *Area*, 39(2): 156-165.

- Anderson, B. (2010). 'Preemption, precaution, preparedness: Anticipatory action and future geographies', *Progress in Human Geography*, 34(6): 777-798.
- Anderson, B. (2012). 'Affect and biopower: towards a politics of life', *Transactions of the Institute of British Geographers*, 37(1): 28-43.
- Anderson, B. (2014). *Encountering affect: capacities, apparatuses, conditions*. (Farnham: Ashgate).
- Anderson, B., Kearnes, M., McFarlane, C., and Swanton, D. (2012a). 'On assemblages and geography', *Dialogues in Human Geography*, 2(2), 171-189.
- Anderson, B., Kearnes, M., McFarlane, C., and Swanton, D. (2012b). 'Materialism and the politics of assemblage'. *Dialogues in Human Geography*, 2(2), 212-215.
- Arnoldi, J. (2004). 'Derivatives: Virtual Values and Real Risks', *Theory, Culture & Society*, 21(6), 23-42.
- Arrighi, G. (1994). *The long twentieth century: Money, power, and the origins of our times*. (London: Verso).
- Austin, J.L. (1962). *How To Do Things With Words*. (Oxford: Clarendon).
- Axilrod, S. H. (2009). *Inside the Fed: Monetary Policy and its Management, Martin Through Greenspan to Bernanke*. (Cambridge MA: MIT Press).
- Bagehot, W. (1873). *Lombard Street: A description of the money market*. (London: Kegan, Paul & Trench).
- Bailey, A. (Speech 2011e). 'Why Prudential Regulation matters', given at APCIMS Conference

11th October 2011.

Bailey, A. (Speech 2013b). 'The new approach to financial regulation', given at the Chartered Banker Dinner 2013, Edinburgh, 1st May 2013.

Baker, A. (2013a). 'The new political economy of the macroprudential ideational shift'. *New Political Economy*, 18(1): 112-139.

Baker, A. (2013b). 'The gradual transformation? The incremental dynamics of macroprudential regulation', *Regulation and Governance*, 7(4): 417-434.

Baker, A., Hudson, D. and Woodward, R. (eds.), (2005). *Governing financial globalization: international political economy and multi-level governance*. (London:Routledge).

Baker, A., and Widmaier, W. (2014). 'The Institutional Roots of Macroprudential Ideas: Veblen and Galbraith on Regulation, Policy Success and Overconfidence', *New Political Economy*, 19(4): 487-506.

Bank of England:

Financial stability Reviews

<http://www.bankofengland.co.uk/archive/Pages/digitalcontent/historicpubs/fsr.aspx>

Financial Stability Review - Autumn 1996 (a). Available at:

<http://www.bankofengland.co.uk/archive/Documents/historicpubs/fsr/1996/fsrfull9610.pdf>

Financial Stability Review - Spring 1997 (a). Available at:

<http://www.bankofengland.co.uk/archive/Documents/historicpubs/fsr/1997/fsrfull9703.pdf>

Financial Stability Review - Autumn 1997 (b). Available at:

<http://www.bankofengland.co.uk/archive/Documents/historicpubs/fsr/1997/fsrfull9710.pdf>

Financial Stability Review - Spring 1998 (a). Available at:

<http://www.bankofengland.co.uk/archive/Documents/historicpubs/fsr/1998/fsrfull9805.pdf>

Financial Stability Review - Autumn 1998 (b). Available at:
<http://www.bankofengland.co.uk/archive/Documents/historicpubs/fsr/1998/fsrfull9811.pdf>

Financial Stability Review, June 1999 (a). Available at:
<http://www.bankofengland.co.uk/archive/Documents/historicpubs/fsr/1999/fsrfull9906.pdf>

Financial Stability Review, November 1999 (b). Available at:
<http://www.bankofengland.co.uk/archive/Documents/historicpubs/fsr/1999/fsrfull9911.pdf>

Financial Stability Review, June 2000 (a). Available at:
<http://www.bankofengland.co.uk/archive/Documents/historicpubs/fsr/2000/fsrfull0006.pdf>

Financial Stability Review, December 2000 (b). Available at:
<http://www.bankofengland.co.uk/archive/Documents/historicpubs/fsr/2000/fsrfull0012.pdf>

Financial Stability Review, June 2001 (a). Available at:
<http://www.bankofengland.co.uk/archive/Documents/historicpubs/fsr/2001/fsrfull0106.pdf>

Financial Stability Review, December 2001 (b). Available at:
<http://www.bankofengland.co.uk/archive/Documents/historicpubs/fsr/2001/fsrfull0112.pdf>

Financial Stability Review, June 2002 (a). Available at:
<http://www.bankofengland.co.uk/archive/Documents/historicpubs/fsr/2002/fsrfull0206.pdf>

Financial Stability Review, December 2002 (b). Available at:
<http://www.bankofengland.co.uk/archive/Documents/historicpubs/fsr/2002/fsrfull0212.pdf>

Financial Stability Review, June 2003 (a). Available at:
<http://www.bankofengland.co.uk/archive/Documents/historicpubs/fsr/2003/fsrfull0306.pdf>

Financial Stability Review, December 2003 (b). Available at:

<http://www.bankofengland.co.uk/archive/Documents/historicpubs/fsr/2003/fsrfull0312.pdf>

Financial Stability Review, June 2004 (a). Available at:

<http://www.bankofengland.co.uk/archive/Documents/historicpubs/fsr/2004/fsrfull0406.pdf>

Financial Stability Review, December 2004 (b). Available at:

<http://www.bankofengland.co.uk/archive/Documents/historicpubs/fsr/2004/fsrfull0412.pdf>

Financial Stability Review, June 2005 (a). Available at:

<http://www.bankofengland.co.uk/archive/Documents/historicpubs/fsr/2005/fsrfull0506.pdf>

Financial Stability Review, December 2005 (b). Available at:

<http://www.bankofengland.co.uk/archive/Documents/historicpubs/fsr/2005/fsrfull0512.pdf>

Financial Stability Reports:

<http://www.bankofengland.co.uk/publications/Pages/fsr/default.aspx>

Financial Stability Report, 12th July 2006 (a). Available at:

<http://www.bankofengland.co.uk/publications/Documents/fsr/2006/fsrfull0606.pdf>

Financial Stability Report, 26th April 2007 (a). Available at:

<http://www.bankofengland.co.uk/publications/Pages/fsr/2007/fsr21.aspx>

Financial Stability Report, 25th October 2007 (b). Available at:

<http://www.bankofengland.co.uk/publications/Documents/fsr/2007/fsrfull0710.pdf>

Financial Stability Report, 1st May 2008 (a). Available at:

<http://www.bankofengland.co.uk/publications/Documents/fsr/2008/fsrfull0804.pdf>

Financial Stability Report, 28th October 2008 (b). Available at:

<http://www.bankofengland.co.uk/publications/Documents/fsr/2008/fsrfull0810.pdf>

Financial Stability Report, 26th June 2009 (a). Available at:

<http://www.bankofengland.co.uk/publications/Documents/fsr/2009/fsrfull0906.pdf>

Financial Stability Report, 18th December 2009 (b). Available at:

<http://www.bankofengland.co.uk/publications/Documents/fsr/2009/fsrfull0912.pdf>

Financial Stability Report, 25th June 2010 (a). Available at:
<http://www.bankofengland.co.uk/publications/Documents/fsr/2010/fsrfull1006.pdf>

Financial Stability Report, 17th December 2010 (b). Available at:
<http://www.bankofengland.co.uk/publications/Documents/fsr/2010/fsrfull1012.pdf>

Financial Stability Report, 24th June 2011 (a). Available at:
<http://www.bankofengland.co.uk/publications/Documents/fsr/2011/fsrfull1106.pdf>

Financial Stability Report, 1st December 2011 (b). Available at:
<http://www.bankofengland.co.uk/publications/Documents/fsr/2011/fsrfull1112.pdf>

Financial Stability Report, 29th June 2012 (a). Available at:
<http://www.bankofengland.co.uk/publications/Documents/fsr/2012/fsrfull1206.pdf>

Financial Stability Report, 29th November 2012(b). Available at:
<http://www.bankofengland.co.uk/publications/Documents/fsr/2012/fsrfull1211.pdf>

Financial Stability Report, 26th June 2013 (a). Available at:
<http://www.bankofengland.co.uk/publications/Documents/fsr/2013/fsrfull1306.pdf>

Financial Stability Report, 28th November 2013 (b). Available at:
<http://www.bankofengland.co.uk/publications/Documents/fsr/2013/fsrfull1311.pdf>

Financial Stability Report, 26th June 2014 (a). Available at:
<http://www.bankofengland.co.uk/publications/Documents/fsr/2014/fsrfull1406.pdf>

Financial Stability Report, 16th December 2014 (b). Available at:
<http://www.bankofengland.co.uk/publications/Documents/fsr/2014/fsrfull1412.pdf>

Financial Stability Report, 1st July 2015 (a). Available at:
<http://www.bankofengland.co.uk/publications/Documents/fsr/2015/fsrfull1507.pdf>

Bank of England Financial Stability Press Conferences

June 2011- Available at:
Transcript: <http://www.bankofengland.co.uk/publications/Documents/fsr/2011/conf110624.pdf>

June 2012- Available at

Transcript: <http://www.bankofengland.co.uk/publications/Pages/fsr/2012/fsr31.aspx>
Podcast: http://download.world-television.com/boe/boe_20120629.mp3

November 2012-Available at

Transcript: <http://www.bankofengland.co.uk/publications/Pages/fsr/2012/fsr32.aspx>
Podcast: http://download.world-television.com/boe/boe_20121129.mp3

November 2013- Available at

Transcript: <http://www.bankofengland.co.uk/publications/Pages/fsr/2013/fsr34.aspx>
Podcast: http://download.world-television.com/boe/boe_20132811.mp3

June 2014-Available at

Transcript: <http://www.bankofengland.co.uk/publications/Pages/fsr/2014/fsr35.aspx>
Podcast: http://download.world-television.com/boe/boe_20140626.mp3

Bank of England (2015). *Stress testing the UK banking system: guidance for participating banks and building societies*. Available at <http://www.bankofengland.co.uk/financialstability/Documents/stresstesting/2015/guidance.pdf> (Accessed 5th May 2015).

Bank for International Settlements. (May 2009). 'Principles for sound stress testing practices and supervision - final paper'. Available at: <http://www.bis.org/publ/bcbs155.htm> (Accessed 20th January 2015).

Bank for International Settlements. (2013). 'Basel Committee on Banking Supervision

Working Paper No. 24 , 'Liquidity stress testing: a survey of theory, empirics and current industry and supervisory practices'. Available at www.bis.org/publ/bcbs_wp24.pdf (Accessed 10th December 2014).

Bean, C. (Speech 2007c). 'Risk, Uncertainty and Monetary Policy', given to Dow Jones, at City Club, Old Broad Street, 31st October 2007.

Beck, U. (1992). *Risk society: Towards a New Modernity*. (London: Sage).

Beckert, J. (1996). 'What is sociological about economic sociology? Uncertainty and the embeddedness of economic action', *Theory and Society*, 25(6): 803-840.

Bell, S. (2001). 'The role of the state and the hierarchy of money', *Cambridge Journal of Economics*, 25(2), 149-163.

Bennett, J. (2005). 'The agency of assemblages and the North American blackout', *Public Culture*, 17(3), 445-465.

Bergson, H. (1935). *Laughter: An Essay on the Meaning of the Comic*. (London: Macmillan).

Bernanke, B., Laubach, T., Mishkin, F., and Posen, A. (1999). *Inflation targeting*. (Princeton NJ: Princeton University Press).

Best, J. (2004). 'Hollowing out Keynesian norms: how the search for a technical fix undermined the Bretton Woods regime', *Review of International Studies*, 30(03): 383-404.

Best, J. (2005). *The limits of transparency: ambiguity and the history of international finance*. (Ithaca: Cornell University Press).

Best, J. (2007). 'Why Economy is Often the Exception to Politics as Usual', *Theory, Culture & Society* 2007 Vol. 24(4): 87-109.

Best, J. (2008). 'Ambiguity, Uncertainty, and Risk: Rethinking Indeterminacy', *International Political Sociology*, 2(4): 355-374.

Best, J., and Paterson, M. (Eds.). (2010). *Cultural Political Economy*. (London: Routledge).

Bialasiewicz, L., Campbell, D., Elden, S., Graham, S., Jeffrey, A., and Williams, A. J. (2007). 'Performing security: The imaginative geographies of current US strategy', *Political Geography*, 26(4), 405-422.

Blyth, M. (2002). *Great Transformations: Economic Ideas and Institutional Change in the Twentieth Century*. (New York: Cambridge University Press).

Blyth, M. (2013). *Austerity: The History of a Dangerous Idea*. (Oxford: Oxford University Press).

Bowman, A., Erturk, I., Froud, J., and Johal, S. (2012). 'Central bank-led capitalism? ', *Seattle UL Rev.*, 36: 455- 487.

Boy, N, Burgess, J. P., and Leander, A. (2011). 'The global governance of security and finance: Introduction to the special issue', *Security Dialogue* 2011 42: 115-122.

Brassett, J., and Clarke, C. (2012). 'Performing the Sub-Prime Crisis: Trauma and the Financial Event', *International Political Sociology*, 6(1): 4-20.

Braudel, F. (1982). *Civilization and Capitalism. Vol. 2, The Wheels of Commerce*, (Trans. S. Reynolds). (London: Harper & Row).

Braun, B. (2015). 'Governing the future: The European Central Bank's expectation management during the Great Moderation', *Economy and Society* 44 (3): 367-391

Brealey, R. (Speech 1999a). 'The Asian Crisis: lessons for crisis management and prevention' given at The Bank of England, 15th August 1999.

Brigg, M. (2006). 'Disciplining the developmental subject', in Fernando, JL (ed.) *Microfinance: Perils and prospects*. (New York: Routledge): 55-76).

Broome, A. (2014). *Issues and Actors in the Global Political Economy*. (Basingstoke: Palgrave Macmillan).

Bryan, D and M Rafferty. (2006a). *Capitalism with Derivatives*. (Basingstoke; Macmillan).

Bryan, D and M, Rafferty. (2006b). 'Financial Derivatives: The New Gold?', *Competition and Change*, Vol. 10. No.3, September 2006:265-282.

- Bryan, D., and Rafferty, M. (2007). 'Financial derivatives and the theory of money', *Economy and Society* 36(1): 134-158.
- Buckley, A. (2011). *Financial Crisis: Causes, Context and Consequences*. (Harlow: Pearson).
- Burchell, G., Gordon, C., and Miller, P. (1991). *The Foucault effect: Studies in governmentality*. (Chicago: University of Chicago Press).
- Burrows, O., Learmonth, D. and McKeown, J. (2012). 'RAMSI- A top-down Stress-Testing Model'. Bank of England Financial Stability Paper No.17.
- Butler, J. (1990). *Gender Trouble and the Subversion of Identity*. (London: Routledge).
- Butler, J. (1993). *Bodies That Matter: On the Discursive Limits of "Sex"*. (London: Routledge).
- Butler, J. (1997). *Excitable speech: A politics of the performative*. (London: Routledge).
- Butler, J. (2004). *Precarious life: the Powers of Mourning and Violence*. (London: Verso).
- Butler, J. (2010). 'Performative agency', *Journal of Cultural Economy*, 3(2), 147-161.
- Byrne, D., and Callaghan, G. (2014). *Complexity theory and the social sciences: The state of the art*. (London: Routledge).
- Callon, M. (1998). 'Introduction: the embeddedness of economic markets in economics', *The Sociological Review*, 46(S1): 1-57.
- Callon, M. (2005). 'Why virtualism paves the way to political impotence: A reply to Daniel Miller's critique of the laws of the markets', *Economic Sociology: European electronic newsletter*, 6(2), 3-20.

Callon, M. (2006). 'What does it mean to say that economics is performative?' CSI Working papers series 005. 2006 : 1-58.

Callon, M. (2010). 'Performativity, misfires and politics', *Journal of Cultural Economy*, 3(2), 163-169.

Carnap, R. (1952). *The Continuum of Inductive Methods*. (Chicago: University of Chicago Press).

Carney, M. (Speech 2013a). 'Crossing the threshold to recovery', given at a business lunch hosted by the CBI East Midlands, Derbyshire and Nottinghamshire Chamber of Commerce and the Institute of Directors at the East Midlands Conference Centre 28th August 2013.

Carstensen, M. (2013) 'Projecting from a fiction: The case of Denmark and the financial crisis'. *New Political Economy* Vol 18, Issue 4:555-578.

Carter, C., Clegg, S. R. and Kornberger, M. (2008). 'Strategy as practice?', *Strategic Organization*, 6, 83– 99.

Castree, N. (2010). 'The 2007-09 financial crisis: narrating and politicising a calamity', *Human Geography: a new radical journal* 3 (1): 34-48.

Castree, N., and Christophers, B. (2015). 'Banking Spatially on the Future: Capital Switching, Infrastructure, and the Ecological Fix', *Annals of the Association of American Geographers*, 105(2): 378-386.

Christophers, B. (2009). 'Complexity, finance, and progress in human geography', *Progress in Human Geography* (2009): 1–18.

Christophers, B. (2013). 'Geographies of finance I: Historical geographies of the crisis-ridden present' *Progress in Human Geography*, March 12, 2013 Vol. 38(2): 285–293.

Christophers, B. (2014). 'From Marx to market and back again: Performing the economy', *Geoforum*, 57: 12-20.

Christophers, B. (2015a). 'Geographies of finance II: Crisis, space and political-economic transformation', *Progress in Human Geography* 2015, Vol. 39(2): 205–213.

Christophers, B. (2015b). 'Geographies of finance III: Regulation and 'after-crisis' financial futures', *Progress in Human Geography*, December 22, 2014: 1-11.

Chwieroth, J. (2009). *Capital Ideas: Neoliberalism, the IMF, and the Liberalization of Capital Controls*. (Princeton, NJ: Princeton University).

Clark, G.L. (2011). 'Myopia and the global financial crisis, Context-specific reasoning, market structure, and institutional governance', *Dialogues in Human Geography*, March 2011 vol. 1 no. 1: 4-25.

Clarke, C. (2012). 'FINANCIAL ENGINEERING, NOT ECONOMIC PHOTOGRAPHY: Popular discourses of finance and the layered performances of the sub-prime crisis', *Journal of Cultural Economy*, 5(3): 261-278.

Clarke, C., and Roberts, A. (2014). 'Mark Carney and the Gendered Political Economy of British Central Banking', *The British Journal of Politics & International Relations*. Early View.

Clementi, D. (Speech 1999a). 'Recent Developments in securities markets and the implications for financial stability', given to the Euromoney International Bond Congress at the Queen Elizabeth II Conference Centre in London, 21st February 2001.

Clementi, D. (Speech 2001b). 'Recent Developments in securities markets and the implications for financial stability', given to the Euromoney International Bond Congress at the Queen Elizabeth II Conference Centre in London 21st February 2001.

Clementi, D. (Speech 2001f). 'Debt Workouts for Corporates, Banks and Countries: Some Common Themes', given at the INSOL International Sixth World Congress, Hilton Metropole Hotel in London, 19th July 2001.

Cloke, J. (2009). "An economic wonderland: derivative castles built on sand", *Critical Perspectives on International Business*, Vol. 5 Issue: 1-2:107 – 119.

Clough, P.T. and Halley, J. (eds.). (2007). *The Affective Turn: Theorizing the Social*. (Durham NC: Duke University Press).

Cohen, B. J. (1998). *The Geography of Money*. (Ithaca: Cornell University Press).

Collier, S. J. (2009). 'Topologies of Power Foucault's Analysis of Political Government beyond 'Governmentality'', *Theory, Culture & Society*, 26(6): 78-108.

Collier, S.J. (2012). 'Neoliberalism as big Leviathan, or . . . ? A response to Wacquant and Hilgers', *Social Anthropology* (2012) 20, 2: 186–195.

Collier S, J., and Lakoff, A, (2008). "The vulnerability of vital systems: how 'critical infrastructure' became a security problem", in Cavelti M.D. and Kristensen, K.S. (eds.) *The Politics of Securing the Homeland: Critical Infrastructures, Risk and Securitisation*. (Routledge, New York): 17–39.

Connolly, W. E. (2005). 'The evangelical-capitalist resonance machine', *Political Theory*, 33(6): 869-886.

Conaghan, D. (2012). *The Bank: Inside the Bank of England*. (London: Biteback Publishing).

Cooper, M. (2011). 'Complexity Theory after the Financial Crisis', *Journal of Cultural Economy*, 4:4, 371-385.

Cox, R. W. (1987). *Production, power, and world order: Social forces in the making of history (Vol. 1)*. (New York: Columbia University Press).

Crang, M. (2003). 'Telling materials' in Pryke, M., Rose, G., and Whatmore, S. (eds) *Using social theory: Thinking through research*. (London: Sage): 127-162.

- Crotty, J. (1986). 'Marx, Keynes, and Minsky on the instability of the capitalist growth process and the nature of government economic policy', in Helburn, S. and Bramhal, D. (eds) *Marx, Keynes, Schumpeter. A Centennial Celebration of Dissent*. New York: M.E Sharpe): 297-234.
- Dale, S. (Speech 2009a). 'Tough Times, Unconventional Measures', given at the Association of British Insurers Economics and Research Conference, London 27th March 2009.
- Daston, L. (1995). 'The Moral Economy of Science', *Osiris* 1995 10:3-24.
- Davidson, P. (1991). 'Post-Keynesian Perspectives on Uncertainty', *Journal of Economic Perspectives* 5 (1) 1991: 129-143.
- Davidson, P. (2007a). *John Maynard Keynes*. (Basingstoke: Palgrave Macmillan).
- Davidson, P. (2007b). *Interpreting Keynes for the 21st Century. Volume 4; the Collected Writings of Paul Davidson*. (Basingstoke: Palgrave Macmillan)
- Davies, H. (2006). 'Two cheers for financial stability'. William Taylor Memorial Lecture, Group of Thirty, Washington DC, USA. Available at <http://eprints.lse.ac.uk/28917/>
- Davies, H and Green, D. (2010). *Banking On The Future: The Fall and Rise of Central Banking*. (Woodstock OX: Princeton University Press).
- Dean, M. (1995). 'Governing the unemployed self in an active society', *Economy and Society* 24(4):559-583).
- Dean, M. (1999). *Governmentality: Power and rule in modern society*. (London: Sage).
- Dean, M. (2010). *Governmentality: Power and rule in modern society (2nd Edition)*. (London: Sage).
- de Goede, M. (2001). 'Discourses of Scientific Finance and the Failure of Long-Term Capital Management', *New Political Economy*, 6:2:149-170.

- de Goede, M. (2003). 'Beyond Economism in International Political Economy', *Review of International Studies*, 29(01): 79-97.
- de Goede, M. (2005a). *Virtue, Fortune, and Faith: A Genealogy of Finance*. (Minneapolis: University of Minnesota Press).
- de Goede, M. (2005b). 'Carnival of money: politics of dissent in an era of globalizing finance', in Amooore, L. (eds). *The Global Resistance Reader*: 379- 392.
- de Goede, M. (2010) 'Financial security', in Burgess, J.P. (ed.) *The Routledge Handbook of the New Security Studies*. (London: Routledge): 100–109.
- de Goede, M. (2012). *Speculative Security: The politics of pursuing terrorist monies*. (Minneapolis: University of Minnesota Press).
- DeLanda, M. (1999). 'Deleuze, Diagrams and the Open-ended Becoming', in Grosz, E. (Ed.). (1999). *Becomings: Explorations in time, memory, and futures*. (Ithaca: Cornell University Press): 29-41.
- DeLanda, M. (2005). *Intensive Science and Virtual Philosophy* (2nd Edition). (London: Bloomsbury).
- DeLanda, M. (2006). *A New Philosophy of Society: Assemblage Theory and Social Complexity*. (London: Continuum).
- Deleuze, G. (1968 [1994]). *Difference and Repetition*. (Trans. Patton, P). (New York: Columbia University Press).
- Deleuze, G. (1988a). *Foucault* (Trans. Hand, S). (London: Continuum).
- Deleuze, G. (1998b). *Spinoza: Practical Philosophy*. (Trans. Hurley, R). (San Francisco: City Lights Books).
- Deleuze, G. (1990a). *The logic of sense*. (New York: Columbia University Press).

Deleuze, G. (1990b). *Expression in Philosophy: Spinoza*. (Trans Joughin, M). (New York: Zone Books).

Deleuze, G. (1992). 'What is a dispositif?' in Armstrong, T.,J. (eds) *Michel Foucault: Philosopher*. (London: Harvester Wheatsheaf): 338-348.

Deleuze, G. (1994). 'Desire and Pleasure', in Davidson, A. (ed) *Foucault and His Interlocutors*. (London: Chicago University Press): 183-192.

Deleuze, G. and Guattari, F. (1983). *Anti- Oedipus: Capitalism and Schizophrenia*, (Trans. Hurley, R, Seem, M., and Lane, H) (Minneapolis: University of Minnesota Press).

Deleuze, G., and Guattari, F. (1987). *A Thousand Plateaus* (Massumi, B. Trans.). (Minneapolis: University of Minnesota Press).

Derrida, J. (1988). *Limited Inc*, (trans. Weber, S). (Evanston, Ill: Northwestern University Press).

Derrida, J. and Prenowitz, E. (1996). *Archive Fever*. (Chicago: University of Chicago Press).

Dillon, M.G. (2004). 'Correlating Sovereign and Biopower' in *Sovereign Lives: Power in Global Politics* (2004) (London: Routledge):41-60.

Dillon, M.G. (2008). 'Underwriting Security', *Security Dialogue*, April 2008; vol. 39, 2-3: 309-332.

Dodd, N. (1994). *The Sociology of Money*. (Cambridge: Polity).

Dodd, N. (2014). *The Social Life of Money*. (Princeton NJ: Princeton University Press).

Dubois, D and Prade, H. (1996). 'Combining hypothetical reasoning and plausible inference in possibilistic logic', *Journal of Multiple Valued Logic*, 1 (1996): 219–239.

Dubois , D and Prade, H.(2004). ‘Possibilistic logic: a retrospective and prospective view’, *Fuzzy Sets and Systems*. Volume 144, Issue 1, 16 May 2004: 3–23.

du Gay,P., and Pryke, M. (eds) (2002). *Cultural Economy: Cultural analysis and commercial life*. (London: Sage).

Dymski, G. A. (2009). ‘Why the Subprime Crisis is Different: A Minskyian Approach’, *Cambridge Journal of Economics* 2010, 34: 239–255.

Dymski, G. A. (2010). ‘A spatialized approach to asset bubbles and Minsky crises’ in Papadimitriou, D. B and Randall Wray, L. (eds). *The Elgar Companion to Hyman Minsky*, 34: 222-245.

Eatwell, J. (1996). *International Financial Liberalization: the impact on World Development*. (New York: United Nations).

Engelen E., Erturk I., Froud J., Johal S., Leaver, A, Moran, M., Nilsson, A. and Williams, K. (2011). *After the Great Complacency: Financial Crisis and the Politics of Reform*. (Oxford: Oxford University Press).

Erturk, I., Froud, J., Johal, S., Leaver, A., and Williams, K. (2008). *Financialization at work: Key texts and commentary*. (London: Routledge).

Esposito, E. (2011). *The Future of Futures: The Time of Money in Financing and Society*. (Cheltenham: Edgar Elgar).

Esposito, E. (2013). ‘The Structures of Uncertainty: Performativity and unpredictability in economic operations’, *Economy and Society*, 42(1): 102-129.

Federal Reserve. (2013). ‘Dodd-Frank Act Stress Test 2013: Supervisory Stress Test Methodology and Results.’ Available at: <http://www.federalreserve.gov/bankinfo/stress-tests/severely-adverse-scenario.htm> (Page accessed 15th September 2015).

Financial Crisis Inquiry Commission. (2011). *The Financial Crisis Inquiry Report: The Final Report of the National Commission on the Causes of the Financial and Economic Crisis in the United States Including Dissenting Views*. (Washington DC: Government Printing Office).

Financial Services Authority. (no date). 'About the FSA'. Available at <https://www.FSA.gov.uk/about> (Accessed on 30th May 2015).

Financial Services Authority. (2009). *The Turner Review* (London: FSA)
Available at http://www.fsa.gov.uk/pubs/other/turner_review.pdf (Accessed 1st August 2015)

Financial Stability Board. (No Date). 'About the FSB'. Available at <https://www.financialstabilityboard.org/about/> (Accessed on 28th May 2015).

Fischer, S. (2005). *IMF Essays from a Time of Crisis: The International Financial System, Stabilization, and Development* (MIT Books). Available at <https://ideas.repec.org/b/mtp/titles/0262562162.html> (Accessed 10th October 2013).

Fisher, P. (Speech 2011d). 'Tail risks and contract design from a financial stability Perspective', given at Clare College, Cambridge, 1st September 2011.

Fisher,P. (Speech 2012a). 'Policy making at the Bank of England: the Financial Policy Committee', Speech given at University of Warwick, London Alumni Group 12th March 2012.

Fisher, P. (Speech 2012e). 'Developments in financial markets, monetary and macroprudential policy', given at Richmond University, London 25th September 2012.

Flandreau M (2012). 'The vanishing banker', *Financial History Review* 19 (01): 1–19.

Fligstein, N. (1998). The politics of quantification. *Accounting, Organizations and Society*, 23(3), 325-331.

Foucault, M. (1970). *The Order of Things*. (New York: Pantheon Books).

- Foucault, M. (1972). *Archaeology of Knowledge*. (London: Routledge).
- Foucault, M. (1979a). *The History of Sexuality Vol. 1: The Will to Knowledge*. (London: Allen Lane)
- Foucault, M. (1979b). *Discipline and Punish: The Birth of the Prison*. (New York: Vintage Books).
- Foucault, M. (1986). *The History of Sexuality Vol. 3: The Care of the Self*. (New York: Pantheon Books).
- Foucault, M. (1988). 'Practicing criticism', *Politics, Philosophy, Culture: Interviews and Other Writings, 1977–1984*: 152-56.
- Foucault, M., (2003). "*Society Must Be Defended*": *Lectures at the Collège de France, 1975-1976*. (London: Penguin).
- Foucault, M. (2006). *Psychiatric Power: Lectures at the Collège De France 1973–1974*. Lagrange, J. (eds). (London: Palgrave).
- Foucault, M. (2007). *Security, Territory, Population. Lectures at the College de France 1977-1978*. (Basingstoke: Palgrave Macmillan).
- Foucault, M. (2008). *The Birth of Biopolitics. Lectures at the College de France 1978-1979*. (Basingstoke: Palgrave Macmillan).
- Foucault, M. (2014). *Wrong-doing, truth-telling: the function of avowal in justice*. (Chicago: University of Chicago Press).
- Fourcade, M., Steiner, P., Streeck, W., & Woll, C. (2013). 'The economy as morality play, and implications for the Eurozone crisis', *Socio-Economic Review*, 11(3): 601-627.

- French, S. (2002). 'Gamekeepers and gamekeeping: assuring Bristol's place within life underwriting', *Environment and Planning A*, 34: 513–541.
- French, S., and Kneale, J. (2012) 'Speculating on Careless Lives: Annuitising the biofinancial subject', *Journal of Cultural Economy* 5: 391–406.
- French, S., Leyshon, A. and Wainwright, T. (2011). 'Financializing space, spacing financialization', *Progress in Human Geography* December 2011 vol. 35 no. 6: 798-819.
- Froud, J., Haslam, C., Johal, S, and Williams, K. (2000). Shareholder value and Financialization: consultancy promises, management moves, *Economy and Society*, 29:1, 80-110.
- Geithner, T. (2014). *Stress Test: reflections on financial crises*. (London: Random House).
- George, E. (Speech 1997b). 'Speech', given at Lord Mayor's Banquet in the Guildhall London, 12th June 1997.
- George, E. (Speech 1999b). 'Speech', given at the British-American Chamber of Commerce Lunch 22nd January 1998.
- George, E. (Speech 1999i). 'Mansion House Speech', given at Mansion House, London, 10th June 1999.
- Germain, R. (2012). 'Governing global finance and banking', *Review of International Political Economy* 19: 530–535.
- Gigerenzer, G., Swijtink, Z, Porter, T., Daston, L., Beatty, J. and Kruger, L. (1989). *The Empire of Chance: How Probability Changed Science and Everyday Life*. (Cambridge: Cambridge University Press).
- Giddens, A. (1998). 'Risk society: the context of British politics' in *The politics of Risk Society* (Cambridge: Polity): 23-34.

- Gilbert, E., Atia, M., Salter, M. B., and de Goede, M. (2013). 'Reading Marieke de Goede's Speculative Security', *Political Geography*, (32): 52-60.
- Gill, S. (1990). *American hegemony and the trilateral commission*. (Cambridge: Cambridge University Press).
- Gill, S.R. and Law, D. (1989). 'Global Hegemony and the Structural Power of Capital', *International Studies Quarterly* Vol. 33, No. 4 (Dec., 1989): 475-499.
- Girard, V. (1972). *Violence and The Sacred*, (trans. Gregory, P). (London: John Hopkins University Press).
- Glaser, B. G., and Strauss, A. L. (1967). *The discovery of grounded theory: strategies for qualitative research*. (Chicago: Aldine Publishing Co.)
- Goffman, E. (1959). *The Presentation of self in everyday life*. (Garden City NY: Double Day).
- Goodchild, P. (2009). *Theology of Money*. (Durham, NC: Duke University Press).
- Goodchild, P. (2010). 'Philosophy as a Way of Life: Deleuze on Thinking and money', *SubStance*, Vol. 39, No.1, 2010: 24-37.
- Goodhart, C, Hartmann, P., Llewellyn, D., Rojas-Suarez, L., Weisbrod, S. (1998). *Financial Regulation: Why, how and where now?* (London: Routledge).
- Gorton, G. B. (2009). *Slapped in the Face by the Invisible Hand: Banking and the Panic of 2007*. (Oxford: Oxford University Press).
- Graeber, D. (2012). *Debt: the first 5,000 years*. (Brooklyn: Melville House).

- Grahl, J. (2000). 'Review essay money as sovereignty: The economics of Michel Aglietta', *New Political Economy*, 5(2): 291-316.
- Greenspan, A. (2007). *The Age of Turbulence*. (London: Allen Lane).
- Gregg, M and Seigworth, G.J. (2010). *The Affect Theory Reader*. (Durham NC: Duke University Press).
- Greider, W. (1987). *Secrets of the Temple*. (New York: Simon and Shuster).
- Greider, W. (1997). *One World. Ready or Not: the manic logic of global capitalism*. (New York: Simon and Schuster)
- Guthrie, G., and Wright, J. (2000). 'Open mouth operations', *Journal of Monetary Economics*, 46(2): 489-516.
- Hacking, I. (1999). *The social construction of what?* (Cambridge MA; Harvard University Press).
- Haldane, A. (Speech 2009a). 'Why Banks Failed the Stress Test', given at the Marcus-Evans Conference on Stress-Testing, 13th February 2009.
- Haldane, A. (Speech 2009b). 'Rethinking the Financial Network', given At the Financial Student Association, Amsterdam 28th April 2009.
- Haldane, A. (Speech 2009c). 'Small Lessons from a Big Crisis' , Speech given at the Federal Reserve Bank of Chicago 45th Annual Conference, 8th May 2009.
- Haldane, A. (Speech 2009e). 'Credit is Trust', given at the Association of Corporate Treasurers, Leeds, 14th September 2009.
- Haldane, A. (Speech 2012b). 'Towards a common financial language', Presented at the Securities Industry and Financial Markets Association (SIFMA) "Building a Global Legal Entity Identifier Framework" Symposium, New York, 14th March 2012

Haldane, A. (Speech 2012c) 'Tails of the unexpected', Given at "The Credit Crisis Five Years On: Unpacking the Crisis", conference held at the University of Edinburgh Business School, 8th June 2012.

Halford, S. and Savage, M. 1995: 'Restructuring organisations, changing people: gender and restructuring in banking and local government', *Work, Employment and Society* 9: 97-122.

Hall, R.B. (2008). *Central Banking as Global Governance: Constructing Financial Credibility*. (Cambridge: Cambridge University Press).

Hall, S. (2009). 'Financialised elites and the changing nature of finance capitalism: investment bankers in London's financial district', *Competition and Change*, 13(2), 173-189.

Hall, S. (2010). 'Geographies of money and finance I: Cultural economy, politics and place', *Progress in Human Geography*, vol. 35 no. 2: 234-245.

Hall, S. (2011). 'Geographies of money and finance II: Financialization and financial subjects', *Progress in Human Geography*, vol. 36 no. 3: 403-411.

Hall, S. (2013). 'Geographies of money and finance III Financial circuits and the 'real economy'', *Progress in Human Geography*, 37 no.2: 285-292.

Hardie, I., and MacKenzie, D. (2007). 'Assembling an economic actor: the *agencement* of a Hedge Fund', *The Sociological Review*, Volume 55, Issue 1: 57–80.

Hardie, I, and MacKenzie, D. (2014). 'The Lemon-Squeezing Problem: Analytical and Computational Limitations in CDO Evaluation.' *Competition and Change* 18 (2014): 383-401.

Hardt, M. and Negri, A. *Empire*. (Cambridge MA: Harvard University Press).

Hardy, C. and Thomas, R. (2015). 'Discourse in a material world. *Journal of Management Studies*. Volume 52, Issue 5: 680–696.

Harvey, D. (1982). *The Limits to Capital*. (Oxford: Blackwell).

Harvey, D (1985). *The Urbanization of Capital*. (Oxford: Blackwell).

- Harvey, D. *The condition of postmodernity*. Vol. 14. (Oxford: Blackwell).
- Harvey, D. (2005). *A Brief History of Neoliberalism*. (Oxford: Oxford University Press).
- Harvey, D. (2006). *The Limits to Capital*. (2nd Ed). (London: Verso).
- Harvey, D. (2010). *The Enigma of Capital and the Crises of Capitalism*. (London: Profile books).
- Hauser, A. (Speech 2013a). 'The future of repo: 'too much' or 'too little'?' Speech given at the ICMA Conference on the Future of the Repo Market, London, 11th June 2013.
- Held, D. (1999). *Global transformations: Politics, economics and culture*.(Chicago: Stanford University Press).
- Holmes, D. (2009). 'Economy of Words', *Cultural Anthropology*, Vol. 24, Issue 3: 381–419.
- Holmes, D. (2014). *Economy of Words: Communicative Imperatives in Central Banks*. (Chicago: University of Chicago Press).
- Holmes, D and Marcus, G. (2005). 'Cultures of Expertise and the management of Globalization: Towards The Re-Functioning of Ethnography', in Ong, A, and Collier, S.J. (eds).(2005). *Global Assemblages: Technology, Politics and Ethics As Anthropological Problems*: 235-252.
- Hudson, D. (2005). "Locating and understanding the marketplace in financial governance." In Baker, A., Hudson, D., and Woodward, R. (eds.) (2005). *Governing Financial Globalization*: 62-84.
- Hutter, B., and Power, M. (Eds.). (2005). *Organizational encounters with risk*. (Cambridge: Cambridge University Press).
- Ingham, G. (2004). *The Nature of Money*. (Cambridge: Polity).

Isin, E.F. (2012). *Citizens Without Frontiers*. (New York: Bloomsbury Publishing USA).

Jenkins, R. (Speech 2011e). 'Why banks must think carefully before they shrink their assets'
Article published in The Times on 14th December 2011.

Jenkinson, N. (Speech 2008a). 'Strengthening Regimes for Controlling Liquidity Risk: Some Lessons from the Recent Turmoil', given at the Euromoney Conference on Liquidity and Funding Risk Management, Hyatt Regency London, 24th April 2008.

Jessop, B. (2000). 'The Crisis of the National Spatio-Temporal Fix and the Tendential Ecological Dominance of Globalizing Capitalism', *International Journal of Urban and Regional Research* Volume 24, Issue 2 :323–360.

Jessop, B. (2006). 'Spatial fixes, temporal fixes and spatio-temporal fixes', in Castree, N and Gregory, D (eds) *David Harvey: a Critical Reader*, (Oxford: Blackwell): 142-166.

Jessop, B. (2010). 'The 'Return' of the National State in the Current Crisis of the World Market', *Capital and Class*, 34(1), 38-43.

Johnson, L. (2013). 'Catastrophe bonds and financial risk: Securing capital and rule through contingency', *Geoforum* 45: 30–40.

Jones, A. (2008). 'Beyond embeddedness: economic practices and the invisible dimensions of transnational business activity', *Progress in Human Geography*, Vol. 32(1): 71–88.

Jorion, P. (2002). 'Fallacies about the effects of market risk management systems' in Financial Stability Review 2002b: 115-127.

Kalb, D. (2013). 'Financialization and the Capitalist Moment: Marx versus Weber in the anthropology of global systems', *American Ethnologist*, Vol.40 no.2: 258-266.

- Kerslake, C. (2015). 'Marxism and Money in Deleuze and Guattari's Capitalism and Schizophrenia: On the Conflict Between the Theories of Suzanne de Brunhoff and Bernard Schmit', *Parrhesia* Number 22: 38-78.
- Keynes, J. M. (1936). *The General Theory of Interest, Employment and Money*. (London: Macmillan).
- Kindleberger, C. P. (1976). 'Systems of international economic organization', in Calleo, D.P., Cleveland, H.V.B, Kindleberger, C.P and Lehman, L. *Money and the Coming World Order* (New York: New York University Press): 15-39.
- Kindleberger, C.P. (1987). *International Capital Movements*. (Cambridge: Cambridge University Press).
- Kindleberger, C. P., and Aliber, R. Z. (2011). *Manias, panics and crashes: a history of financial crises*. (Basingstoke: Palgrave Macmillan).
- King, M. (Speech 2007a). Speech given at the Bank of England, 23 January 2007.
- King, M. (Speech 2008b). 'Extract from a speech', given at the Bank of Israel, Jerusalem 31st March 2008.
- King, M. (Speech 2009b). 'Finance: A Return from Risk', given to the Worshipful Company of the International Bankers at Mansion House, London, 17th March 2009.
- Knafo, S. (2013). *The Making of Modern Finance: Liberal Governance and the Gold Standard*. (Abingdon: Routledge).
- Knights, D. and Murray, F. (1994). *Managers divided: organisation politics and information technology management*. (Chichester: Wiley).
- Knorr Cetina, K., and Bruegger, U. (2002). 'Global microstructures: the virtual societies of financial markets', *American Journal of Sociology* 107: 905–50.

- Knorr Cetina, K. and Preda, A. (eds.) (2005). *The Sociology of Financial Markets*. (Oxford: Oxford University Press).
- Kohn, D. (Speech 2011a). 'Enhancing financial stability: the role of transparency', given at London School of Economics, 6th September 2011.
- Konings, M. (2011a). 'Money as icon.' *Theory & Event* 14, no. 3 (2011).
- Konings, M. (2011b). *The Development of American Finance* . (Cambridge : Cambridge University Press).
- Konings, M. (2015). *The Emotional Logic of Capitalism: What Progressives Have Missed*. (Stanford CA: Stanford University Press).
- Krippner, G.R. (2005). 'The financialization of the American Economy', *Socio-Economic Review* (2005) 3: 173-208.
- Krippner, G. R. (2007). 'The making of US monetary policy: Central bank transparency and the neoliberal dilemma', *Theory and Society*, 36(6): 477-513.
- Landoni, M., and Sastry, R. (2013). 'Tales of Tails: Quantifying Extreme Downside Risk', draft available at <http://citeseerx.ist.psu.edu/viewdoc/download?doi=10.1.1.363.1820&rep=rep1&type=pdf> (Assessed 20th February 2015).
- Langley, P. (2002). *World Financial Orders: An Historical International Political Economy*. (London: Routledge).
- Langley, P. (2004). 'In the eye of the 'perfect storm' the final salary pensions crisis and financialisation of Anglo-American capitalism', *New Political Economy*. 2004; 9:539-558.

Langley, P. (2005). 'The everyday life of global finance: A neglected "level" of governance', in Baker, Hudson and Woodward (eds.) *Governing Financial Globalization: IPE and Multi-Level Governance*. (London: Routledge): 85-101.

Langley, P. (2006). 'Securitising Suburbia: The transformation of Anglo-American mortgage finance', *Competition and Change*, 2006; 10: 283-299.

Langley, P. (2007). 'The uncertain subjects of Anglo-American financialization', *Cultural Critique*. 2007; 6566-6591.

Langley, P. (2008a). *The Everyday Life of Global Finance: Saving and Borrowing in Anglo-America*. (Oxford: Oxford University Press).

Langley, P. (2008b). 'Sub-prime mortgage lending: A cultural economy', *Economy and Society*. 2008; 37: 469-494.

Langley, P. (2010). 'The performance of liquidity in the subprime mortgage crisis', *New Political Economy*. 2010; 15: 71-89.

Langley, P. (2013a). 'Toxic assets, turbulence and biopolitical security: Governing the crisis of global financial circulation', *Security Dialogue*. 2013; 44: 111-126.

Langley, P. (2013b). 'Anticipating uncertainty, reviving risk? On the stress testing of finance in crisis', *Economy and Society*, 2013; 42: 51-73.

Langley, P. (2014). *Liquidity Lost: The Governance of the Global Financial Crisis*. (Oxford: Oxford University Press).

Large, A. (Speech 2003b). 'Convergence in Insurance and Banking: Some Financial Stability Issues', given at the Bank of England, 12th June 2003.

Large, A. (Speech 2003c). 'Financial Stability: Maintaining Confidence in a Complex World', given at City of London Central Banking Conference, National Liberal Club, 17th November 2003.

Large, A. (Speech 2004a). 'Financial Stability Oversight, Past & Present', given at the London School of Economics 22nd January 2004.

Law, J. (2004). *After method: Mess in social science research*. (London: Routledge).

Lazzarato, M. (2012). *The Making of Indebted Man: Essay on the Neoliberal Condition* (Trans. JD Jordan). (Los Angeles: Semiotext (e)).

Leclerq, R (1974). *The Logic of the Plausible*. (London: Plenum).

Leidner, R. (1993). *Fast food, fast talk: service work and the routinization of everyday life*. (Berkeley, CA: University of California Press).

Leyshon, A, (1995). 'Geographies of Money and Finance I', *Progress in Human Geography*, vol. 19 no. 4: 531-543.

Leyshon, A. (1997). 'Geographies of Money and finance II', *Progress in Human Geography*, vol. 21 no.3: 381-392.

Leyshon, A. (1998). 'Geographies of Money and Finance III', *Progress in Human Geography*, vol.22 no. 3: 433-446

Leyshon, A. and Thrift, N. 1997: *Money/space: geographies of monetary transformation*. (London: Routledge).

Leyshon, A. and Tickell, N. 1994: 'Money order? The discursive construction of Bretton Woods and the making and breaking of regulatory space', *Environment and Planning A* 26: 1861-1890.

Lipietz, A. (1987). *Mirages and miracles: the crises of global Fordism* (trans. Macey, D). (London: Verso).

LiPuma, E. and Lee, B. 'Financial derivatives and the rise of circulation', *Economy and Society*. v. 34. no. 3. 2005: 404 - 427.

Lobo-Guerrero, L. (2010). *Insuring security: biopolitics, security and risk*. (London: Routledge).

Lobo-Guerrero, L. (2012). *Insuring War: Sovereignty, Security and Risk*. (London: Routledge)

Lobo-Guerrero, L., and Dillon, M.G. (2008). 'Biopolitics of Security in the 21st Century: an introduction', *Review of International Studies* 34(02): 265-292.

Loxley, J. (2007). *Performativity*. (London: Routledge).

Lozano, B. (2013). *Of Synthetic Finance: 3 Essays of Speculative Material*. Available at <http://speculativematerialism.files.wordpress.com/2012/12/of-synthetic-finance-complete-text.pdf>

Lozano, B. (2015). *Of Synthetic Finance: Tree essays of speculative materialism* (New York: Routledge).

Luhmann, N. (1995). *Social Systems*. (Stanford, CA: Stanford University Press).

MacKenzie, D. (2001). "Physics and Finance: S-Terms and Modern Finance as a Topic for Science Studies", *Science, Technology, & Human Values* 26 (2001): 115-144.

MacKenzie D. (2003). 'An equation and its worlds: bricolage, exemplars, disunity and performativity in financial economics', *Social Studies of Science* 33: 831–868.

MacKenzie, D. (2004). "The Big, Bad Wolf and the Rational Market: Portfolio Insurance, the 1987 Crash and the Performativity of Economics", *Economy and Society* 33 (2004): 303-334.

MacKenzie, D. (2005). "Opening the Black Boxes of Global Finance", *Review of International Political Economy* 12 (2005): 555-576.

MacKenzie, D. (2005). "Mathematizing Risk: Models, Arbitrage and Crises," in Hutter, B. & Power, M (eds), *Organizational Encounters with Risk*. (Cambridge: Cambridge University Press): 167-189.

MacKenzie, D. (2006a). "Is Economics Performative? Option Theory and the Construction of Derivatives Markets", *Journal of the History of Economic Thought* 28 (2006): 29-55.

MacKenzie, D. (2006b). *An Engine, Not a Camera: How Financial Models Shape Markets*. (Cambridge, MA: The MIT Press).

MacKenzie, D. (2007). "The Material Production of Virtuality: Innovation, Cultural Geography and Facticity in Derivatives Markets," *Economy and Society* 36 (2007): 355-376.

MacKenzie, D. (2011). "The Credit Crisis as a Problem in the Sociology of Knowledge", *American Journal of Sociology* 116 (2011): 1778-1841.

MacKenzie, D. (2012). "Knowledge Production in Financial Markets: Credit Default Swaps, the ABX and the Subprime Crisis," *Economy and Society* 41 (2012): 335-359.

MacKenzie, D., and Millo, Y. (2003). "Constructing a Market, Performing Theory: The Historical Sociology of a Financial Derivatives Exchange", *American Journal of Sociology* 109 (2003): 107-145.

MacKenzie, D., Muniesa, F., and Siu, L. (2007). *Do Economists Make Markets? On the Performativity of Economics*. (Princeton, NJ: Princeton University Press).

MacKenzie, D. and Spears, T. (2014). "'The Formula That Killed Wall Street': The Gaussian Copula and Modelling Practices in Investment Banking", *Social Studies of Science* 44 (2014): 393-417.

- Mallard, A. (2007). 'Performance testing: dissection of a consumerist experiment', *The Sociological Review*, 55(s2), 152-172.
- Mann, G. (2010). 'Hobbes' redoubt? Towards a Geography of Monetary Policy', *Progress in Human Geography* 34(5):601-625.
- Manoff, M. (2004). 'Theories of the Archive from Across the Disciplines', *Libraries and the Academy*, 4(1), 9-25.
- Marrazi, C. (2008). *Capital Language: From the New Economy to the War Economy*. (Los Angeles: Semiotext(e)).
- Marrazi, C. (2010). *The Violence of Financial Capitalism*. (Los Angeles: Semiotext(e)).
- Marshall, N., Pike, A., Pollard, J., Tomaney, J., Dawley, S., Gray, J. (2011). 'Placing the run on Northern Rock', *Journal of Economic Geography*. (2011): 1–25
- Martin, R. (2002). *The Financialization of Daily Life*. (Philadelphia: Temple University Press).
- Martin, R. (2007). *An Empire of Indifference: American War and the Financial Logic of Risk Management*. (Durham, NC: Duke University Press).
- Martin, R. (2013). 'A precarious dance, a social derivative', Paper presented at the 'Fifth Critical Studies of Finance Conference.' The School of Business, Stockholm University, 15th August 2013. Available at <http://speculativematerialism.files.wordpress.com/2013/10/r-martin-a-precarious-dance-a-derivative-sociality.pdf> (Accessed 23rd August 2013)
- Martin, R., Rafferty, M., and Bryan, D. (2008). 'Financialization, risk and labour', *Competition and Change*, 12(2): 120-132.
- Marx, K. (1894) [1991]. *Capital Volume 3: Critique of Political Economy*. (Harmondsworth: Penguin).

- Mata, T., and Medema, S. G. (2013). 'Cultures of Expertise and the Public Interventions of Economists', *History of Political Economy*, 45(suppl 1), 1-19.
- Maurer, B. (2002). 'Repressed futures: financial derivatives' theological unconscious', *Economy and Society*. v. 31. no. 1. 2002: 15 - 36.
- Maxfield, S. (1997). *The International Political Economy of Central Banking in Developing Countries*. (New Jersey, Princeton University Press).
- May, T. (1997). *Reconsidering Difference: Nancy, Derrida, Levinas, and Deleuze*. (Pennsylvania: Penn State Press).
- McCafferty, I. (Speech 2013a). 'Monetary policy in a changing economy', given at Bloomberg, London, 18th January 2013.
- McCormack, D.P. (2012). 'Governing economic futures through the war on inflation', *Environment and Planning A* 2012, vol. 44: 1536-1553.
- McCormack, D.P. (2015). "Governing inflation: Price and atmospheres of emergency", *Theory, Culture & Society* (2015). *Special Issue: Governing Emergencies: 1-24*.
- McDowell, L. (1994). 'Social justice, organizational culture and workplace democracy: cultural imperialism in the City of London', *Urban Geography* 15, 661-680.
- McDowell, L. (1997). *Capital Culture: gender at work in the city*. (Oxford: Blackwell).
- McCloskey, D. N. (1983). 'The Rhetoric of Economics', *Journal of Economic Literature*, Volume 21 Issue 2: 481-517.
- Mehrling, P. (2011). *The New Lombard Street: How the Fed became the dealer of last resort*. (Princeton NJ: Princeton University Press).

Miles, D. (Speech 2013e). 'Housing, leverage and stability in the wider economy', given at the Housing, Stability and the Macroeconomy: International Perspectives Conference, Federal Reserve Bank of Dallas, Thursday 14th November 2013.

Miller, D. (2002). 'Turning Callon the right way up', *Economy and Society*, 31(2): 218-233.

Miller, P., and Rose, N. (1990). Governing economic life. *Economy and Society*, 19(1), 1-31.

Millo, Y., and MacKenzie, D. (2009). "The Usefulness of Inaccurate Models: The Emergence of Financial Risk Management", *Accounting, Organizations and Society* 34 (2009): 638-653

Minsky, H. P. (1982). *Can it happen again? Essay on instability and finance*. (New York: ME Sharpe).

Minsky, H. P. (1986). *Stabilizing an Unstable Economy*. (New Haven: Yale University Press).

Muniesa, F., 2014. *The provoked economy: Economic reality and the performative turn*. (London: Routledge).

Muniesa, F., and Callon, M. (2007). 'Economic experiments and the construction of markets', in MacKenzie, D., Muniesa, F., and Siu, L. (eds) (2007), *Do economists make markets? On the performativity of economics*: 163-189.

Nealon, J.T. (2008) *Foucault beyond Foucault: Power and its intensifications since 1984*. (Chicago: Stanford University Press).

Nesvetailova, A. (2007). *Fragile finance*. (Basingstoke: Palgrave MacMillan).

Nesvetailova, A. (2008a). 'Three Facets of Liquidity Illusion', *German Policy Studies*, 4(3), 83-132.

Nesvetailova, A. (2008b). 'Ponzi Finance and Global Liquidity Meltdown: Lessons from Minsky' (Report No. CUTP/002). London, UK: Department of International Politics, City University London. Available at <http://openaccess.city.ac.uk/1286/1/CUWPTP002.pdf> (Accessed 2nd July 2015).

- Nesvetailova, A. (2010a). *Financial Alchemy in Crisis: The Great Liquidity Illusion*. (London: Pluto).
- Nesvetailova, A. (2010b). 'The crisis of invented money: Liquidity illusion and the global credit meltdown', *Theoretical Inquiries in Law*, 11(1): 125–147.
- Nietzsche, F. (1887) [1996]. *On the Genealogy of Morals* (trans Smith, D.). (Oxford: Oxford University Press).
- Nordhaus, W.D. (1975). 'The Political Business Cycle', *The Review of Economic Studies*, Vol. 42, No. 2 (Apr., 1975):169-190.
- Nørholm Just, S. (2015). 'The Negotiation of Basel III: Postliberalism in the making?', *Journal of Cultural Economy*, 8(1): 25-41.
- O'Grady, N. (2014). 'Securing circulation through mobility: milieu and emergency response in the British fire and rescue service', *Mobilities*, 9(4): 512-527.
- O'Malley, P. (1996) 'Risk and Responsibility' in Barry, A., Osborne, T., and Rose, N. (eds.) *Foucault and Political reason: Liberalism, Neo-liberalism and rationalities of Government*. (Chicago IL University of Chicago Press): 189-208.
- O'Malley, P. (1999). 'Consuming risks: Harm minimization and the government of drug users', *Governable places: Readings on government mentality and crime control*. (Aldershot: Ashgate).
- O'Malley, P. (2000). 'Uncertain Subjects: Risks, Liberalism and Contract', *Economy and Society* 29(4):460-484.
- O'Malley, P. (2004). *Risk, Uncertainty and Government*. (London: Glasshouse Press).
- Palan, R and Nesvetailova, A. (2013). 'The Governance of the Black Holes of the World Economy: Shadow Banking and Offshore Finance', *CITYPERC Working Paper Series No. 2013/03*, Available at http://papers.ssrn.com/sol3/papers.cfm?abstract_id=2216795.

Palmer, D., E. (2013). 'Governance over Stress Testing', in Siddique, A., and Hasan, I. (eds.) (2013). *Stress Testing: Approaches, Methods and Applications*. (London: Risk Books): 1-14.

Pauly, L. W. (2014). 'The political economy of international financial crises', in Ravenhill, J. (ed.) (2014), *Global Political Economy*. (Oxford: Oxford University Press): 198-222.

Paudyn, B. (2014). *Credit ratings and sovereign debt: the political economy of creditworthiness through risk and uncertainty*. (Basingstoke: Palgrave Macmillan).

Peck, J. and Tickell, A. (1992). 'Accumulation, regulation and the geographies of post-Fordism: missing links in regulationist research', *Progress in Human Geography*, June 1992 vol. 16 no. 2: 190-218.

Peirce, C.S. (1901). "Abduction and Induction," in Buchler, J. (eds.) *Philosophical Writings of Peirce*, (1945). (New York: Dover).

Phillips, N., and Hardy, C. (1999). *Discourse analysis: Investigating processes of social construction* (Vol. 50). (London: Sage).

Pike, A. and Pollard, J. (2010). 'Economic Geographies of Financialization', *Economic Geography* Volume 86, Issue 1: 29–51.

Pixley, J. (2012). *Emotions in finance: Booms, busts and uncertainty*. (Cambridge: Cambridge University Press).

Pollock, G. (2007). *Encounters in the virtual feminist museum: time, space and the archive*. (London: Routledge).

Poon, M. (2007). 'Scorecards as devices for consumer credit: the case of Fair, Isaac and Company Incorporated', *Sociological Review* 55: 284–306.

Popper, K. R. (1935). *The Open Society and Its Enemies. Vol. II*. (London: Routledge).

Power, M. (2005) 'The Invention of Operational Risk', *Review of International Political Economy*, vol.12. No. 4 (Oct, 2005): 577-599.

Power, M. (2007). *Organized Uncertainty*. (Oxford: Oxford University Press).

Preda, A. (2006). 'Socio-technical agency in financial markets: the case of the stock ticker', *Social Studies of Science* 36: 753–782.

Pryke, M. (2010). 'Money's eyes: the visual preparation of financial markets', *Economy and Society*, 39:4: 427-459.

Pryke, M and J., Allen. (2000). 'Monetized time-space: derivatives money's 'new imaginary'?', *Economy and Society*. v. 29. no. 2. 2000: 264 - 284.

Pryke, M., Rose, G. and Whatmore, S. (eds.). (2003). *Using social theory, Thinking through Research*. (Maidenhead: McGraw- Hill Education).

Rajchman, J. (1999). 'Diagram and Diagnosis', in Grosz, E. (ed.). (1999). *Becomings: Explorations in time, memory, and futures*. (Ithaca: Cornell University Press): 42-54.

Ramírez, R., and Selin, C. (2014). 'Plausibility and probability in scenario planning', *Foresight*, 16(1), 54-74.

Rotman, B. (1987). *Signifying nothing: The semiotics of zero*. (London: Macmillan).

Ruggie, J. (1982). 'International regimes, transactions, and change: embedded liberalism in the postwar economic order', *International Organization*, 1982, Vol.36(2): 379-415.

Salmon., C. (Speech 2012b). 'Three principles for successful financial sector reform', given at 'City Week 2012: The International Financial Services Forum, The Queen Elizabeth

Conference Centre, London 7th February 2012.

Samman, A. (2012). 'The 1930s as Black Mirror: Visions of historical repetition in the global financial press, 2007-2009', *Journal of Cultural Economy*, 5(2): 213-229.

Saw, R. (1944). *The Bank of England 1694-1944*. (London: George G. Harrop & Co).

Sedgwick, E. K., (2003). *Touching feeling: Affect, pedagogy, performativity*. (Durham N: Duke University Press).

Selin, C., and Guimarães Pereira, Â. (2013). 'Pursuing plausibility', *International Journal of Foresight and Innovation Policy*, 9(2-3-4), 93-109.

Shiller, R. J. (2000). *Irrational Exuberance*. (Princeton NJ: Princeton University Press).

Siddique, A., and Hasan, I. (2013). *Stress Testing: Approaches, Methods and Applications*. (London: Risk Books).

Sinclair, T. J. (2004). *The New Masters of Capital: American Bond Rating Agencies and the Global Economy*. (Ithaca: Cornell University Press).

Smart, G. (2006). *Writing the Economy: Activity, Genre and Technology in the World of Banking*. (London: Equinox).

Snidal, D. (1985). 'The Game Theory of International Politics', *World Politics*, 38(01), 25-57.

Stenfors, A. (2014). 'LIBOR as a Keynesian Beauty Contest: A Process of Endogenous Deception', *Review of Political Economy*, Volume 26, Issue 3 (2014):392-407.

Strange, S. (1986). *Casino Capitalism* (Manchester: Manchester University Press).

Strange, S. (1998). *Mad Money*. (Manchester: Manchester University Press)

Strange, S., and Palan, R. P. (1994). *From Bretton Woods to the Casino Economy*. (Basingstoke: Palgrave).

Swedberg, R. (2012). 'The role of confidence in finance', in Knorr-Cetina, K and Preda, A (eds) *Handbook of the Sociology of Finance*. (New York: Oxford University): 529-545.

Taleb, N.N. (2008). *The Black Swan: The Impact of the Highly Improbable*. (London: Penguin).

Taylor, M. (Speech 2013a). 'Remarks' given at the joint Black Country Reinvestment Society and Black Country Diners Club networking lunch, Wolverhampton Monday 21st October 2013.

Taylor, M. C. (2004). *Confidence games: Money and markets in a world without redemption*. (Chicago: University of Chicago Press).

Tett, G. (2009). *Fool's Gold: The Inside Story of JP Morgan and How Wall St. Greed Corrupted Its Bold Dream and Created a Financial Catastrophe*. (New York: Free Press).

Thompson, G. (1998). 'Encountering economics and accounting: Some skirmishes and engagements', *Accounting Organizations and Society*, 23(3): 283-323.

Thrift, N. (2000). 'Performing cultures in the new economy', *Annals of the Association of American Geographers*, 90(4): 674-692.

Thrift, N., and J.D. Dewsbury. (2000). 'Dead Geographies: and how to make them live', *Environment and Planning D: Society and Space* 2000, volume 18: 411- 432.

Tickell, A. (2000). 'Dangerous derivatives: controlling and creating risks in international money', *Geoforum*, 31(1), 87-99.

Triana, P. (2012). *The Number That Killed Us: A Story of Modern Banking, Flawed Mathematics, and a Big Financial Crisis*. (Hoboken NJ: John Wiley & Sons).

Tucker, P. (Speech 2007c), 'Money and Credit: Banking and the Macroeconomy', given at the Monetary Policy and the Markets Conference, London 13th December 2007.

Tucker, P. (Speech 2009a). 'Remarks', given at the Turner Review Conference, The Queen Elizabeth II Conference Centre, London, 27th March 2009.

Tucker, P. (Speech 2011e). 'Macro and Microprudential supervision' Speech given at the British Bankers' Association Annual International Banking Conference, London, 29th June 2011.

Underhill, G.R.D. (1994). 'Introduction: conceptualising the changing global order'. In Stubbs, R. and Underhill, G.R.D. (eds), *Political economy and the changing global order*. (Basingstoke: Macmillan): 17-44.

Valdez, S and Molyneux, P. (2010). *An Introduction to Global Financial Markets (Sixth Ed.)* (Basingstoke: Palgrave Macmillan).

Van der Pijl, K. (1998). *Transnational classes and international relations* (Vol. 1). (New York, NYC: Psychology Press).

Van Overtveldt, J. (2009). *Bernanke's Test: Ben Bernanke, Alan Greenspan, and the Drama of the Central Banker*. (Evanston, Ill: Agate Publishing).

- Velthuis, O. (2015). 'Making monetary markets transparent: the European Central Bank's communication policy and its interactions with the media', *Economy and Society*, (ahead-of-print): 1-25.
- Wacquant, L. (2005). 'Habitus'. *International Encyclopedia of Economic Sociology*, in Becket, J. and Z. Milan (eds). (London: Routledge):316.
- Wainwright, T. (2013). 'Finance's outsiders?: networks, knowledge and power beyond the City', *Journal of Economic Geography* (2013): 1–18.
- Walters, W. (2006). 'Border/control', *European Journal of Social Theory*, 9(2), 187-203.
- Watson, M. (2007). *The Political Economy of International Capital Mobility*. (Basingstoke: Palgrave Macmillan).
- Wigan, D. (2009). 'Financialisation and Derivatives: Constructing an Artifice of Indifference', *Competition and Change* 13, no.2 (2009): 157-172.
- Wigan, D. (2010). 'Credit Risk Transfer and Crunches: Global Finance Victorious or Vanquished', *New Political Economy*, Vol. 15, No. 1, 2010: 109-125.
- Williams, J. (2013). *Gilles Deleuze's difference and repetition: A critical introduction and guide*. (Edinburgh: Edinburgh University Press).
- Wittgenstein, L. (1953 [2001]). *Philosophical Investigations*. (Oxford: Blackwell).
- Woodward, R. (2005). 'Globalization and the City of London's financial markets: The Emergence of multi-level governance in principal financial sectors', in Baker, A., Hudson, D., and Woodward, R. (eds.) (2005). *Governing Financial Globalization*: 154-170,
- Wray, L. R. (2004). 'The Credit Money, State Money, and Endogenous Money Approaches: A Survey and Attempted Integration.' working paper, available at <http://cas.umkc>.

edu/econ/economics/facuhy/wray/papers/CREDIT&STATE% 2 0 MONEY% 20JOIE%
20revised, doc. (Accessed 9th July 2015)

Yeung, H.W.C. (2005). 'Rethinking relational economic geography', *Transactions of the Institute of British Geographers*, 30: 37–51.

Young, E. B. (2013). *The Deleuze and Guattari Dictionary*. (London: A&C Black).

Zelizer, V.A.(1997). *The Social Meaning of Money: Pin Money, Paychecks, Poor Relief, and Other Currencies*. (Princeton NJ: Princeton University Press).

Zelizer, V. A. (2011). *Economic Lives: How culture shapes the economy*. (Princeton NJ: Princeton University Press).