



Durham E-Theses

Exploring Legal, Regulatory and Shari'ah Compliance Issues in Islamic Financial Instruments: Derivatives and Sukuk

RATTU, MUHAMMAD,UMER

How to cite:

RATTU, MUHAMMAD,UMER (2013) *Exploring Legal, Regulatory and Shari'ah Compliance Issues in Islamic Financial Instruments: Derivatives and Sukuk* , Durham theses, Durham University. Available at Durham E-Theses Online: <http://etheses.dur.ac.uk/7349/>

Use policy

The full-text may be used and/or reproduced, and given to third parties in any format or medium, without prior permission or charge, for personal research or study, educational, or not-for-profit purposes provided that:

- a full bibliographic reference is made to the original source
- a [link](#) is made to the metadata record in Durham E-Theses
- the full-text is not changed in any way

The full-text must not be sold in any format or medium without the formal permission of the copyright holders.

Please consult the [full Durham E-Theses policy](#) for further details.

Academic Support Office, Durham University, University Office, Old Elvet, Durham DH1 3HP
e-mail: e-theses.admin@dur.ac.uk Tel: +44 0191 334 6107
<http://etheses.dur.ac.uk>

Exploring Legal, Regulatory and *Shari'ah* Compliance Issues in
Islamic Financial Instruments:
Derivatives and *Sukuk*

BY

MUHAMMAD UMER RATTU

STUDENT ID:000027647

Supervised by Dr. MEHMET ASUTAY

**Thesis submitted in Fulfilment of the Requirements for the Degree of Doctor of
Philosophy at Durham University, UK**

School of Government and International Affairs

Durham University

ABSTRACT

In general derivatives, futures, options and swaps are considered against the principles of *shari'ah* for various reasons, such as the absence of asset-backed deals, dealing in prohibited transaction of debt, presence of element of *gharar* (uncertainty), gambling, absence or non-existence of subject matter, Short-Selling, sale of subject-matter without prior acquiring of possession or constructive possession, *ghabn* (market price manipulation), *'ina* (sale and buy-back), *tawarruq* (multiple buy-back sales involving no actual asset transfer), amongst others. In the recent past there have been attempts to find and explore Islamic hedging products having same functions as that of derivatives having link with real economy growth.

Financial transactions either linked with economic activities or they are pure financial instruments known as 'synthetic' transactions having no contribution to the real economy. Due to Muslim investors' demand and excess saving due to oil wealth in the Gulf Cooperation Council, there is a demand for Islamic financial transactions. Therefore, derivatives in compliance with *shari'ah* principles were developed. *Sukuk* are fine and popular example of such financial products and emerged as a strong substitute to conventional derivative products.

Sukuk are considered *shari'ah* compliant but at the same time ethical and hence fits into the requirements of financial products to overcome the adverse effects of the financial crisis. This research, hence, explores and analyses *sukuk* as an Islamic securitization product. In addition, this research also investigates whether or not *sukuk* meet the standards and criteria of conventional securitization structures in order to safeguard the interests of different parties involved in it and the public at large. Furthermore, this research examines *sukuk* structures whereby it identifies further *shari'ah* and ethical underlying principles for further product development, design under *shari'ah*.

In responding to the research aims, this research attempted to peruse through original sources of both *shari'ah* and English Common law on *sukuk* and the application of *wa'ad* (undertaking) particularly in the context of *sukuk* and derivatives. While discussing the identified research aims in terms of determining the key legal, regulatory and *shari'ah* compliance issues in the development of *sukuk*, the focus remained on the United Kingdom (UK), which attempts to become one of the leading centers of Islamic finance.

After foundational and exploratory research, this study concludes and answered the research questions that: (i) *sukuk* are based on *shari'ah* principles; (ii), derivatives are allowed under *shari'ah*; (iii) *sukuk* as Islamic derivative instruments are as efficient as that of conventional derivative products and apply the similar securitization principles; (iv) *wa'ad* has the same authority as that of *'aqd* (contract) and can be compared with 'promise' and 'promissory estoppel' in Common law; (v) use of *wa'ad* in equity-based *sukuk* is against the *shari'ah*; (vi) usage of *wa'ad* in derivatives like Foreign Currency Forward Options, Total Return Swaps and Short-Selling is inappropriate, and (vii) UK is an attractive country for promotion and growth of *sukuk*. For this purpose the results of the sub-research questions were: (a) UK has sufficient legislative and regulative infrastructure to entertain *shari'ah* compliant products such as *sukuk* in the future (b) UK so far is impartial in the debate on *shari'ah* compliance approval process of products (c) there is confusion about whether *sukuk* are categorised as debt instruments or Collective Investment Schemes. This study came with an extensive research and analysed growth of *sukuk* and its structures in UK with legislative and regulatory developments and concludes UK is a place where development of *sukuk* is phenomenal for the strategic significance of London Stock Exchange in the global market. Though not many *sukuk* are being issued in UK but it is a place where most of the *sukuk* are listed.

ACKNOWLEDGMENT

All praises to Allah that He has enabled me to achieve this stage, which without His help was not possible.

I owe many people in the process of my PhD.

First of all, let me thank Dr. Mehmet Asutay who spared his time and sincere devotion in guiding me during my research. There are no words for his efforts in supervising me.

Professor Rodney Wilson always remained a source of inspiration for me.

My friends always provided me with a great moral support.

My parents' prayers were always there and their encouragement remained with me throughout during my research. My sister Dr. Asia Majeed always encouraged me and set an example by completing her PhD. before me.

My special gratitude goes to my wife Mrs. Sidrah Ul-Haq for her invaluable support.

In the end, this research could not be possible without the support of my elder brother Mr. Muhammad Usman Rattu who not only motivated me but also raised his hand whenever I asked for his help. His support was priceless.

TABLE OF CONTENTS

| | |
|--|------|
| ABSTRACT | II |
| ACKNOWLEDGMENT | III |
| TABLE OF CONTENTS | IV |
| LIST OF FIGURES..... | VII |
| LIST OF TABLES | VIII |
| LIST OF CASES | IX |
| LIST OF ACRONYMS..... | XI |
| DECLARATION | XIV |
| STATEMENT OF COPYRIGHT | XV |
| CHAPTER 1 INTRODUCTION | 1 |
| 1.1 INTRODUCTION..... | 1 |
| 1.2 THE BASIC PRINCIPLES OF ISLAMIC FINANCE | 5 |
| 1.3 AIMS AND OBJECTIVES OF THE STUDY | 11 |
| 1.4 RESEARCH QUESTIONS..... | 12 |
| 1.5 RESEARCH STATEMENT AND RATIONALE..... | 14 |
| 1.6 SIGNIFICANCE OF THE STUDY | 15 |
| 1.7 RESEARCH METHODOLOGY | 15 |
| 1.7.1 <i>General Research Methodologies</i> | 18 |
| 1.7.2 <i>Research Strategy</i> | 20 |
| 1.8 ORGANIZATION AND CONTENTS | 22 |
| CHAPTER 2 ISLAMIC FINANCE, <i>SUKUK</i> AND SECURITISATION: LITERATURE REVIEW | 24 |
| 2.1 INTRODUCTION..... | 24 |
| 2.2 TRADITIONAL ISLAMIC FINANCE MODES | 25 |
| 2.3 SECURITISATION AND FINANCIAL SYSTEMS | 30 |
| 2.4 BENEFITS OF SECURITISATION | 33 |
| 2.5 <i>SUKUK</i> AND ISLAMIC SECURITISATION | 49 |
| 2.6 <i>SHARI'AH</i> FRAMEWORK | 61 |
| 2.7 HIGHER OBJECTIVES OF ISLAMIC FINANCE | 63 |
| 2.8 <i>SUKUK</i> STRUCTURES | 68 |
| 2.9 <i>SUKUK AL- IJARAH</i> | 75 |
| 2.9.1 <i>Sukuk al- musharakah</i> | 79 |
| 2.9.2 <i>Sukuk al- mudarabah</i> | 83 |
| 2.9.3 <i>Sukuk al-murabahah</i> | 87 |
| 2.9.4 <i>Sukuk al-salam</i> | 89 |
| 2.9.5 <i>Sukuk al-istisna'</i> | 92 |
| 2.9.6 <i>Hybrid Sukuk</i> | 95 |
| 2.10 GROWTH OF <i>SUKUK</i> AND ITS IMPACT ON EMERGING MARKETS | 100 |
| 2.10.1 <i>Growth of Sukuk</i> | 100 |
| 2.10.2 <i>Market Behaviour</i> | 106 |

| | |
|---|-----|
| 2.10.3 The Global Sukuk Market..... | 107 |
| 2.11 CONCLUSION | 113 |
| CHAPTER 3 LEGAL AND SHARI‘AH COMPLIANCE ISSUES IN RELATION TO DERIVATIVES AND SUKUK..... | 117 |
| 3.1 PRODUCT DEVELOPMENT IN ISLAMIC FINANCE..... | 117 |
| 3.2 EVOLUTION OF PRODUCT DEVELOPMENT AND ITS PROCESS | 121 |
| 3.3 SUKUK AND DERIVATIVES..... | 124 |
| 3.4 SUBJECT-MATTER AS COUNTER-VALUES | 125 |
| 3.4.1 The Subject-Matter | 126 |
| 3.4.2 Sale of An Object not Present at the Time of Contract | 129 |
| 3.4.3 Deliverability of the Object (<i>Maqdur al-Taslim</i>) | 133 |
| 3.5 DEFERMENT OF THE COUNTER-VALUES | 135 |
| 3.5.1 A Glance at Modern Law..... | 141 |
| 3.5.2 A Review of the Qur’anic Ayah <i>Al-Mudayannah</i> | 142 |
| 3.6 SHORT-SELLING..... | 147 |
| 3.7 SALE PRIOR TO TAKING POSSESSION..... | 152 |
| 3.8 DEBT-CLEARANCE SALE | 158 |
| 3.9 SPECULATION AND GAMBLING | 164 |
| 3.9.1 A Market Analysis of Speculation..... | 165 |
| 3.9.2 <i>Qimar and Maysir</i> | 168 |
| 3.9.3 Application of Above Interpretation to Futures | 172 |
| 3.10 CONCLUSION | 173 |
| CHAPTER 4 CRITICAL LEGAL AND SHARI‘AH CONCERNS IN THE SUKUK MARKET | 176 |
| 4.1 CURRENT SHARI‘AH CONCERNS | 176 |
| 4.2 OWNERSHIP..... | 177 |
| 4.3 PURCHASE UNDERTAKING..... | 178 |
| 4.4 ISSUES PERTAINING TO SUKUK <i>AL-IJARAH</i> | 180 |
| 4.5 INTERNATIONAL ELEMENTS OF SUKUK REGULATION..... | 183 |
| 4.6 SPECIFIC SUKUK LEGAL REQUIREMENTS..... | 187 |
| 4.7 SHARI‘AH CONFLICT WITH LEGAL CODES | 188 |
| 4.8 PRICING SUKUK..... | 190 |
| 4.9 RATING SUKUK..... | 192 |
| 4.10 RISK PROFILE OF ISLAMIC FINANCIAL PRODUCTS WITH SPECIAL REFERENCE TO SUKUK..... | 197 |
| 4.10.1 Financial Risks | 201 |
| 4.10.2 Treasury risks | 211 |
| 4.10.3 Governance Risks | 213 |
| 4.11 CONCLUSION | 217 |
| CHAPTER 5 THE USE OF WA ‘AD IN SUKUK/DERIVATIVES | 220 |
| 5.1 PROMISE IN ISLAMIC FINANCE..... | 220 |
| 5.2 PROMISE IN SHARI‘AH..... | 221 |
| 5.3 DIFFERENCE BETWEEN PROMISE AND CONTRACT (WA ‘AD AND ‘AQD) | 224 |
| 5.4 JURISTS’ VIEW ON WA ‘AD..... | 226 |

| | |
|---|-----|
| 5.4.1 <i>First view</i> | 226 |
| 5.4.2 <i>Second view</i> | 228 |
| 5.4.3 <i>Third view</i> | 229 |
| 5.5 PROMISE IN THE EYES OF PRESENT DAY SCHOLARS | 230 |
| 5.6 PROMISE AND THE COMMON LAW | 232 |
| 5.7 CASE LAWS ON THE MATTER OF PROMISE | 234 |
| 5.8 PROMISSORY ESTOPPEL AND WA 'AD | 237 |
| 5.9 WA 'AD IN EQUITY-BASED <i>SUKUK</i> | 240 |
| 5.10 WA 'AD AND DERIVATIVES | 247 |
| 5.11 USE OF WA 'AD IN FX OPTION | 248 |
| 5.12 WA 'AD IN TOTAL RETURN SWAPS (TRS) AND SHORT-SELLING | 249 |
| 5.12.1 <i>TOTAL RETURN SWAPS</i> | 249 |
| 5.12.2 <i>SHORT-SELLING</i> | 252 |
| 5.13 SUMMARY AND CONCLUSION | 254 |
| CHAPTER 6 A CRITICAL ANALYSIS OF THE UK REGULATORY STRATEGY TOWARDS <i>SUKUK</i> ISSUANCE: LEGAL, REGULATIVE AND FINANCIAL ISSUES | 258 |
| 6.1 INTRODUCTION | 258 |
| 6.2 EMERGENCE OF THE UK AS AN ISLAMIC FINANCIAL CENTRE | 259 |
| 6.3 THE PRESENT POSITION OF LSE | 262 |
| 6.4 <i>SUKUK</i> AND THE AREAS OF CONCERN IN THE UK REGULATORY FRAMEWORK | 265 |
| 6.4.1 <i>Sukuk's Regulatory Definitions</i> | 266 |
| 6.4.2 <i>Shari'ah Compliant Regulations in UK</i> | 269 |
| 6.5 UK LEGAL BACKGROUND TO <i>SUKUK</i> | 270 |
| 6.6 UK TAXATION OF <i>SUKUK</i> | 274 |
| 6.7 THE STRATEGIC POSITIONING OF THE LSE FOR <i>SUKUK</i> | 281 |
| 6.8 REVIEW OF UK CONSULTATIONS AND DEVELOPMENTS ON <i>SUKUK</i> | 287 |
| 6.9 2011-PRE-BUDGET PROPOSALS | 289 |
| 6.10 UK AND THE SOVEREIGN BOND-LIKE <i>SUKUK</i> | 290 |
| 6.11 REFLECTIONS AND CONCLUSIONS | 294 |
| CHAPTER 7 CONCLUSION | 301 |
| 7.1 SUMMARY OF THE RESEARCH | 301 |
| 7.2 REFLECTING ON THE RESEARCH FINDINGS | 301 |
| 7.3 CONTRIBUTIONS OF THE STUDY | 308 |
| 7.4 RECOMMENDATIONS | 309 |
| 7.5 LIMITATIONS OF THE RESEARCH | 312 |
| 7.6 EPILOGUE | 313 |
| APPENDIX: LIST OF LIVE INSTRUMENTS | 314 |
| GLOSSARY | 317 |
| BIBLIOGRAPHY | 327 |

LIST OF FIGURES

| | |
|--|-----|
| Figure 2.1: Key Drivers of Conventional Securitisation Growth | 40 |
| Figure 2.2: The Conventional Securitisation Process | 41 |
| Figure 2.3: Parties to a <i>Sukuk</i> Transaction..... | 51 |
| Figure 2.4: Types of Bonds..... | 58 |
| Figure 2.5: Possible <i>Sukuk</i> Issues under AAOIF Standards | 69 |
| Figure 2.6: The Evolution of <i>Sukuk</i> Structures in the GCC..... | 70 |
| Figure 2.7: Use of Funds by Islamic Banks | 74 |
| Figure 2.8: <i>Sukuk al-Ijarah</i> Structure | 76 |
| Figure 2.9: <i>Sukuk al-Musharakah</i> Structure | 80 |
| Figure 2.10: <i>Sukuk al-Mudarabah</i> Structure | 84 |
| Figure 2.11: Dubai Ports (DP) World <i>Sukuk</i> structure | 86 |
| Figure 2.12: <i>Sukuk al-Murabahah</i> Structure | 88 |
| Figure 2.13: <i>Sukuk al-Salam</i> Structure | 91 |
| Figure 2.14: <i>Sukuk al-Istina'</i> | 94 |
| Figure 2.15: Hybrid <i>Sukuk</i> | 96 |
| Figure 2.16: IDB <i>Sukuk</i> Structure | 98 |
| Figure 2.17: Diminishing <i>Musharakah</i> Structure | 99 |
| Figure 2.18: Global <i>Sukuk</i> Issuance (in all currencies)..... | 101 |
| Figure 2.19: Underlying Economic Conditions in GCC & MENA..... | 104 |
| Figure 3.1: Issues Pertaining to Subject-Matter..... | 126 |
| Figure 4.1: The Qatar Global <i>Sukuk</i> | 181 |
| Figure 4.2: SEC <i>Sukuk</i> : Illustration of <i>Sukuk Al-Istithmar</i> Structure | 183 |
| Figure 4.3: Pan Islamic National Regulators | 187 |
| Figure 4.4: <i>Sukuk</i> Raiting Analysis..... | 194 |
| Figure 4.5: Risk Profile Islamic Financial Institutions | 200 |
| Figure 5.1: Usage of <i>Wa'ad</i> in Equity-based <i>Sukuk</i> | 244 |
| Figure 5.2: Purchase Undertaking by A Third Party | 246 |
| Figure 5.3: Use of <i>Wa'ad</i> in FX Option | 248 |
| Figure 5.4: Swap Structure Using Double <i>Wa'ad</i> | 250 |
| Figure 5.5: Use of Two Double <i>Wa'ad</i> in Combination with <i>Murabahah</i> Replicating Conventional Short-Selling..... | 252 |
| Figure 6.1: UK Offers a Good Platform for Private Placement..... | 259 |
| Figure 6.2: LSE's Strategic Positioning for <i>Sukuk</i> | 262 |
| Figure 6.3: <i>Shari'ah</i> Banks in the UK Market | 265 |
| Figure 6.4: A Basic <i>Sukuk</i> Structure | 267 |
| Figure 6.5: <i>Sukuk</i> Listings at LSE..... | 283 |
| Figure 6.6: Value chain for <i>Sukuk</i> | 298 |
| Figure 6.7: Key Parameters for the Success of <i>Sukuk</i> | 299 |

LIST OF TABLES

| | |
|--|-----|
| Table 2.1: Strategic Value Added | 39 |
| Table 2.2: Islamic Securitisation Key Characteristics | 48 |
| Table 2.3: Comparisons Between <i>Sukuk</i> and Bonds..... | 59 |
| Table 2.4: Comparisons between <i>Sukuk</i> and Shares | 60 |
| Table 2.5: Comparative Analysis of Main Islamic Finance Contracts | 75 |
| Table 2.6: DP World <i>Sukuk</i> on the LSE | 87 |
| Table 4.1: Legal Issues in GCC Domiciles..... | 189 |
| Table 5.1: Comparison between Asset-based and Asset-backed Structures..... | 241 |
| Table 6.1: Islamic Banks in UK..... | 260 |
| Table 6.2: Islamic Banks in the UK as of 31 st Dec. 2010..... | 261 |
| Table 6.3: <i>Sukuk</i> Listing at London Stock Exchange | 264 |
| Table 6.4: Expired and Cancelled Instruments | 264 |
| Table 6.5: UK Legislation Addressing Islamic Finance | 271 |
| Table 6.6: Listing Requirements for <i>Sukuk</i> on LSE Markets | 281 |

LIST OF CASES

- Alhusen v. Prest* (1851) 6 Exch 720
- Argy Trading Development Co. Ltd v. Lapid Developments Ltd* [1977] 3 All ER 785
- Bailey v. Croft* (1812) 4 Taunt 611
- Balfour v. Balfour* [1919] 2 KB 571
- Barclays Bank plc. v. Fairclough Building Ltd.* [1995] IRLR 605
- Birmingham and District Land Co. v. London and North Western Rly Co.* (1888) 40 ChD 268
- Burton v. Brook* (1956) 6 DLR (2d) 464
- Carr v. London and North Western Rly Co.* (1875) LR 10 CP 307
- Central London Property Trust Ltd v. High Trees House Ltd* [1947] KB 130
- Collin v. Duke of Westminster* [1985] QB 581.
- Combe v. Combe* [1951] 2 KB 215
- Curie v. Misa* (1875) LR 10 Ex 153
- Davis v. Dodd* (1812) 4 Taunt 602
- De La Bere v. Pearson Ltd.* [1908] 1 KB 280
- Dent v. Bennett* (1839) 4 My & Cr 269
- Durham Fancy Goods Ltd v. Michael Jackson (Fancy Goods) Ltd* [1968] 2 QB 839
- Evenden v. Guildford City Association Football Club Ltd* [1975] QB 917
- Four Oaks Estate Ltd v. Hadley* (1986) 83 Law LS Gaz 2326
- Gilbert Steel Ltd v. University Construction Ltd* (1976) 12 OR (2d) 19
- Hamer v. Sidway* (1891) 2 AC 234
- Hartley v. Hymans* [1920] 3 KB 475
- Hedley Byrne & Co. Ltd. v. Heller & Partners Ltd* (1964) AC 465
- Henderson v. Merrett Syndicates Ltd* (1995) 2 AC 145
- Hughes v. Metropolitan Rly Co* (1877) 2 App Cas 439
- James v. Heim Gallery (London)* [1980] 2 EGLR 119
- Jorden v. Money* (1854) 5 HL Cas 185
- Joscelin v. Shelton* (1557) 3 Leon 4
- Kelner v. Baxter* (1866) LR 2 CP 174
- Lampleigh v. Brathwait* [1615] Hob 105

Lark v Outhwaite [1991] 2 Lloyd's Rep. 132
Lyle-Meller v. A Lewis & Co. (Westminster) Ltd [1956] 1 All ER 247
Marrie v. Misa (1875) LR 10 Exch 153
Midland Bank Trust Co. Ltd. v. Hett, Stubbs & Kemp [1979] Ch 384
Mitas v. Hyams [1951] 2 TLR 1215
Peeke v. Redman [1552] 2 Dyer 113a
Pinnel's Case (1602) 5 Co Rep 117a
Plymouth Corp'n v. Harvey [1971] 1 All ER 623
Rann v. Hughes (1778) 7 Term Rep 350n
Ross T Smythy & Co. Ltd v. T.D. Bailey, Son & Co. [1940] 3 All ER 60
Saltzberg and Rubin v. Hollis Securities Ltd (1964) 48 DLR 344
Savage v. Uwechia [1961] 1 All ER 830
Shamil Bank of Bahrain E.C. v Beximco Pharmaceuticals Ltd. (No.1) [2004] 4 All ER 1072
Slough Estates Ltd v. Slough Borough Council (No. 2) (1967) 19 P & CR 326
Taylor v. Brewer (1813) 1 M & S 290
Thomas v. Thomas [1842] 2 QB 852
United Dominions Trust (Commercial) Ltd v. Eagle Aircraft Services Ltd [1968] 1 All ER 104
Vallance, Re; Vallance v. Blagden (1884) 26 ChD 353
Walsh v. Westpac Banking Corp'n (1992) 104 ACTR 30
Waltons Stores (Interstate) Ltd v. Maher (1988) 76 ALR 513
Whitaker, Re; Whitaker v. Palmer [1901] 1 Ch 9
White v. Jones [1995] 2 AC 207
Wigan v. English and Scottish Law Life Assurance Association [1909] 1 Ch 291
WJ Alan & Co. Ltd. v. El Nasr Export and Import Co. [1972] 2 QB 189
Wyvern Developments Ltd, In Re [1974] 2 All ER 535

LIST OF ACRONYMS

| | |
|-------------|--|
| AAOIFI | Accounting and Auditing Organisation of Islamic Financial Institutions |
| ABB | Asset-Backed Bond |
| ABS | Asset-Backed <i>Sukuk</i> |
| AFIBs | Alternative Finance Investment Bonds |
| BCBS | Basel Committee for Banking Supervision |
| BIB | Bahrain Islamic Bank |
| BLME | Bank of London and Middle East |
| CAs | Capital Allowances |
| CISs | Collective Investment Schemes |
| CREST | Central Securities Depository |
| DIB | Dubai Islamic Bank |
| DIFX | Dubai International Financial Exchange |
| DMO | Debt Management Office |
| DPs | Dubai Ports |
| EU | European Union |
| FA | Finance Act |
| FDI | Foreign Direct Investment |
| FSA | Financial Services Authority |
| FSMA | Financial Services and Markets Act |
| FTSE | Financial Times Stock Exchange |
| FX | ForeignCurrency Exchange |
| GB | Great Britain |
| GBP | Great Britain Pound |
| GCC | Gulf Cooperation Council |
| GDP | Gross Domestic Product |
| GDR | Global Depository Receipt |
| HL | House of Lords |
| HM Treasury | Her Majestys Treasury |
| HMR&C | Her Majestys Revenue and Customs |
| HSBC | The Hong Kong and Shanghai Banking Corporation |
| IBP | International Business Publications |
| IDB | Islamic Development Bank |

| | |
|--------|--|
| IFA | Islamic Fiqh Academy |
| IFEG | Islamic Finance Experts Group |
| IFIs | Islamic Financial Institutions |
| IFSB | Islamic Financial Services Board |
| IFSL | International Financial Services London |
| IIFM | International Islamic Financial Market |
| IIRA | International Islamic Rating Agency |
| IMF | International Monetary Fund |
| KFH | Kuwait Finance House |
| LIBOR | London Interbank Offered Rate |
| LSE | London Stock Exchange |
| LTCM | Long Term Capital Management |
| MENA | Middle East and North Africa |
| MTNs | Medium Term Notes |
| N.D. | Not Dated |
| OBG | Oxford Business Group |
| ODS | Object Deferred Sale |
| OPDS | Object and Price Deferred Sale |
| OIC | Organization of the Islamic Conference |
| PDS | Price Deferred Sale |
| PEBs | Panel of Economists and Bankers |
| PLS | Profit and Loss Sharing |
| PS | Profit Sharing |
| PSM | Professional Securities Market |
| QFC | Qatar Financial Centre |
| QGS | Qatar Global sukuk |
| QIB | Qatar Islamic Bank |
| RAM | Ratings Agency Malaysia |
| RAO | Regulated Activities Order |
| REMICs | Real Estate Mortgage Investment Conduits |
| RM | Malaysian Ringgit |
| SABIC | Saudi Basic Industries Corporation |
| SDLT | Stamp Duty Land Tax |
| SDRT | Stamp Duty Reserve Tax |

| | |
|--------|--|
| SEC | Saudi Electricity Company |
| SPC | Special Purpose Company |
| SPV | Special Purpose Vehicle |
| SS | Short-Selling |
| SSB | <i>Shari'ah</i> Supervisory Board |
| STSL | Solidarity Trust Services Limited |
| SWT | <i>Subhanahu wa ta'ala</i> |
| TCs | Trust Certificates |
| TRS | Total Return Swaps |
| UAE | United Arab Emirates |
| UK | United Kingdom |
| UKLA | United Kingdom Listing Authority |
| UN | United Nations |
| USA | United States of America |
| USD | United States Dollar |
| WestLB | Westdeutsche Landesbank, i.e., Western German State Bank |

DECLARATION

I hereby declare that no portion of the work that appears in this study has been used in support of an application of another degree of qualification to this or any other university or institution of learning.

STATEMENT OF COPYRIGHT

The copyright of this thesis rests with the author. No quotation from it should be published in any format, including electronic and the internet, without the author's prior written consent. All information derived from this thesis must be acknowledged appropriately.

CHAPTER 1

INTRODUCTION

1.1 INTRODUCTION

Commercial banking has become an essential sector of the modern economy. In developed countries with formal economy prevailing, practically every government department, business organisation, institution and private individual needs a bank account. With further financialisation and modernisation, the former dual economy countries of the developing world have also adopted the same pattern in banking. Muslims, who form nearly one fifth of the world's population and live in all parts of the world, are in one way or the other have to use the banking services. However the Muslim individuals have a problem with the conventional banking system, as interest or *riba* is prohibited by Qur'an.

Beyond the *riba* prohibition, Islam presents an economic system, which is based on fair and equitable distribution of wealth, on charity and on prohibition of *riba* (Nyazee 1995). Therefore, Islamic finance depicts that social justice and morality can go hand-in-hand with one's pursuit of attaining wealth. However, despite being a religious, ethical and socially responsible type of financial intermediation, Islamic finance is not immune from setbacks, which recent financial crisis has exposed the fundamental deficiencies of the conventional banking system. Therefore, it has offered an opportunity to the Islamic financial industry to reflect on its practices (Qayyum 2010:4). Though the Islamic finance sector has been less affected by the crisis and part of the problem is attributable to its infancy. This is a fact that Islamic finance first emerged during the life of the Prophet Muhammad (peace be upon him) over 1400 years ago, but the modern world witnessed its existence in the 1970s. Therefore, the challenge is now to develop Islamic finance into a viable and competitive type of financial intermediation.

With the recent institutionalisation in Islamically oriented banking and finance alternatives, it is stressed that the Muslims should not blindly adopt the conventional system of money, banking and finance. They, rather, should purge themselves of prohibited interest and modify it to suit the just and poor-friendly economic system of Islam. Professional Muslim economists and *shari'ah* scholars, bankers and business people joined in the task of developing a workable model of Islamic banking and finance. Efforts are made to put the idea into practice in several Muslim and non-Muslim countries and a variety of Islamic modes of financing have been developed by Islamic scholars, economists and bankers that may serve as a better alternative to interest.

Islamic finance is an ethical, indigenous and equitable mode of finance, which is based on *shari'ah*. *Shari'ah* derives its principles from the Qur'an, tradition of the Prophet Muhammad (peace be upon him) namely *sunnah*, *qiyas* and *ijma'* (Khan 2001:6-9). As the principles derived from these sources indicate, there is a reluctance to hand over the funds to banks and financial institutions that invest in companies engaged in unethical and socially harmful activities (ibid).

It should be noted that the emerging Islamic banking scene has succeeded in achieving general acceptance (IBP2010:10). Today, clientele of Islamic banking and finance are not confined to Muslim countries but are spread over Europe, United States of America (USA) and the Far East. Islamic banking has now established itself as a serious business segment in the eyes of financial institutions, businesses, consumers and regulators. In responding to the increasing demand and sophistication in financial engineering, Islamic bankers, keeping pace with sophisticated techniques and latest financial developments have evolved investment instruments that are not only efficient and profitable but are also ethically motivated (Imeson 2008).

In searching for the historical roots of Islamic finance, it should be noted that the history of Islamic finance practices, in modern sense, dates back to 1963 and 1967 with the establishment of Mit Ghamr Islamic social bank in Egypt and Tabung Haji Malaysia, an investment institution, respectively (El-Ashker 1987:155;IDB 1995). In 1975, the Dubai Islamic Bank (DIB) was established as the first Islamic commercial bank mandated to

operate in adherence to *shari'ah* rules and principles (Warde 2000:75). Since then, Islamic banking has made significant progress worldwide, particularly in South Asia and in the Gulf Cooperation Council (GCC) region (Barazi 2009:270).

The Islamic Financial Services Industry (IFSI) and its institutional infrastructure comprises of the following:

- (i) Islamic commercial banks including full-fledged Islamic banks and Islamic windows and subsidiaries of conventional banks, asset management institutions including investment banks, mutual funds, and brokerage houses;
- (ii) Islamic non-bank financial institutions like *ijarah* and *mudarabah* companies, Islamic finance companies, Islamic housing cooperatives, Islamic venture capital firms, microfinance companies, credit sale subsidiaries of trading companies and similar other institutions including *zakah* funds and *awqaf*;
- (iii) Islamic insurance (*takaful*) services;
- (iv) Islamic capital markets; and
- (v) Islamic financial architecture and infrastructure.

For the provision of Islamic financial services, jurisdictions have either the approach of reforming policy framework by reforming legal or introducing distinct licensing criteria or some jurisdictions within the existing legal licensing regime introducing *shari'ah* compliant products based on demands in the market (Rasul 2010a:180).

In the former approach, the popular course so far is the introduction of mixed or dual banking systems in which Islamic banking co-exists alongside conventional banking. The GCC region and the South Asia have this approach (Aldohni 2011:16). On the other hand, Iran and Sudan, where the public sector has a larger share in the banking system, have adopted the strategy of complete transformation of their banking systems into totally *shari'ah* compliant ones without any room for conventional banking (Ibid). In this framework, the Islamic banking services take three types of governance structures, full-

fledged Islamic banks either newly licensed or transformed; Islamic banking windows of conventional banks, and Islamic banking subsidiaries of conventional banks (ibid).

IFSI provides various financial services relating to banking, non-banking, insurance, capital markets and money markets (Askari et al. 2009:4; Baba 2007:392). It offers significant potential in achieving financial stability as its resilience against the current financial crisis indicates, but also it aims to contribute to the goals of sustainable economic development and just social progress which is supported by sound and stable financial institutions and markets (Venardos 2010:10; Muhamad et al. 2011:250). However, the industry is also facing some significant problems. For example, it is being operated in a tax, legal, and regulatory environment that are designed for conventional financial services, which creates challenges in achieving its potential being an alternative and developmentalist proposition.

IFSI, hence, is facing *inter alia* the following main issues:

(i) Unresolved *fiqh* issues

Lack of standard financial contracts and products may cause ambiguity resulting in dispute and cost. In addition, the nature of *shari'ah* scholarship, using intentional argument as opposed to 'consequentialist' approach making injunctions resulting in the gap between aspirations and realities of Islamic banking and finance.

(ii) Legal framework

An appropriate legal, institutional and tax framework is a basic requirement for establishing sound financial institutions and markets. Commercial, banking and company laws appropriate for the enforcement of Islamic banking and financial contracts do not exist in many countries.

(iii) Regulatory framework

Besides legal framework there is also a need to regulate Islamic financial industry effectively. This is important to save the interests of the depositors and the customers.

(iv) Excess liquidity

Islamic banks mainly due to the oil wealth in the GCC have excess liquid funds, which cannot be properly utilized due to non-availability of *shari'ah* compliant products and instruments. Islamic banks urgently need *shari'ah* compliant products to meet a number of pressing needs (El-Gamal 2008).

(v) *Shari'ah* compliance

Users of Islamic financial services assign primary importance to *shari'ah* compliance of the services they use. It is understandable that *shari'ah* non-compliance entails a serious operational risk and can result in withdrawal of funds from and instability of an Islamic bank, irrespective of its initial financial soundness. *Shari'ah* compliance is hence a serious matter for an Islamic bank, in addition to its compliance with other regulatory requirements.

1.2 THE BASIC PRINCIPLES OF ISLAMIC FINANCE

Islam allows revenue generation through the principal of ownership and the entitlement to profit through the principle '*al-kharaj bi al-daman*', that is 'revenue through the corresponding obligation and liability for loss' (Khan and Porzio 2010). Ownership and participation by the investor constitutes an entitlement to profit accrued by the respective company or corresponding loss in that event (Ayub 2007). Profit is to be achieved through a legitimate stake of risk. The Islamic preference is for asset-backed financing and risk-sharing mechanisms that create stability and safeguards that protect institutions, individuals and society at large (ibid).

Additionally, Islam allows trade but prohibits *riba* or all forms of usury and interest-based as narrated in the Qur'anic verse (2:275) and in many '*ahadith*' (or narrations) of the Prophet Muhammad (peace be upon him). Trading in money or debt as a commodity is hence prohibited except at par value.

The Islamic law of contracts generally forbids the following (Al-Zuhayli 2003; Iqbal and Khan 2005): *riba* or usury, *gharar* (defined as uncertainty or arguably as risk) along with *al-maysir* or gambling and *al-qimar* or games of chance (Usmani, 2005). The trade must also be in permissible goods and activities; for example commerce in alcohol for drinking purposes is forbidden. These characteristics (not an exclusive list) have important connotations for all commercial and relevant legal obligations.

Gharar is prohibited by the *hadith* in Muslim, narrated by Abu Hurairah “*the Prophet (peace be upon him) prohibited the pebble sale and the gharar sale*” (Sahih Muslim, 2009: Book 10:Hadith 3614). There is an agreement that excessive *gharar* in objects of sale makes the transaction invalid and on the contrary trifling *gharar* makes the transaction permissible. (Ibn Taymiyyah 1899:224). Ibn Juzay (1975:268) also stated that *gharar* is prohibited by *sunnah* except where it is trifling. It is therefore the degree of uncertainty in rendering a transaction invalid owing to the element of *gharar*. Therefore a *gharar* may be classified into excessive *gharar* which makes the transaction invalid; trifling *gharar* which may be tolerated and finally average *gharar* which falls between the two categories.

The average *gharar* is difficult to determine whether or not it makes a transaction valid or invalid (Ibn Rushd 1982:148; Al-Sanhuri 1956:51; Al-Ba’li n.d:113-114). Therefore *gharar* classified into two categories: substantive and trivial. Substantive *gharar* is prohibited outright. However, *gharar* may be brought about by undue complexity in contracts (for example two sales in one), lack of adequate value-relevant information, or by the possibility of deceit or fraud. Activities such as conventional insurance fall under the issue of *gharar*, which could also arise from the underlying contract containing uncertainties and due to inefficiencies in external information.

Whilst dealing with and in *riba*, is a categorical exclusion according to *shari’ah*, *gharar* on the other hand is a best-effort exclusion (Farooq 2007; Visser 2009). There will always be some *gharar* in relation to economic activities. A transaction is prohibited in line with four conditions of *gharar*: it should be substantive, should be in an exchange contract (such as sales, rent or partnership), it must affect the principal object of the

contract and the need can be met otherwise (El-Gamal 2006b as cited by Darir 1997). A *gharar* transaction is a zero-sum game with uncertain pay-offs and it can be tolerated when the risk is negligible, inevitable and unintentional (Hassan and Mahlkecht 2011).

In general, contractual commitments are encouraged in Islam within a well-refined Islamic jurisprudence of contracts (Al-Zuhayli 2003). A well-known *hadith* in Al-Tirmidhi states

“Muslims are bound by the conditions of their contracts except a condition that makes something permissible as forbidden or something forbidden as permissible” (Al Tirmidhi 1974:626).

Contractual choices are arguably more demanding for Islamic trading activities compared to conventional activities. The scope of requirements is more onerous. Transaction and search costs are relatively higher in the current short-term for Islamic investments. However, the advantage is that there is more clarity within the contract that is intended to evoke fewer disputes over the longer term. Time-frames for establishing Islamic investments in respect of subscription and redemption are higher and more demanding. Standardisation across banks and products could help reduce such costs and timeframes.

There is a general position that derivatives, futures, options and swaps are generally not allowed according to *shari‘ah* for a variety of reasons (Jobst and Solé 2012). The grounds for this include; not being asset-backed deals, dealing in debt which is prohibited, *gharar* for example goods or contract not being clearly defined, gambling, non-existent assets, goods not being owned (short-sales), goods not in possession or constructive possession (forward sales-exceptions are *salam* and *istisna’*), *ghabn* (market price manipulation), *‘ina* (sale and buy-back), *tawarruq* (multiple buy-back sales involving no actual asset transfer), amongst others (ibid). There are, however, recent *shari‘ah* attempts to find Islamic alternatives to determine Islamic hedging products or equivalents to derivatives (Iqbal and Mirakhor 2007).

Additionally, honesty and fairness in trade, disclosing faults (opposite to *‘caveat emptor’*), avoiding misrepresentation, having two contracts linked to one sale, not selling

under duress are critical factors towards the acceptance of a sale Islamically (Pock 2007; IBPUSA 2010; Venardos 2005). Hoarding of wealth and goods is also not permitted (Usmani 1998).

There is an increasing tendency to accept the concept of limited liability, which is a novel concept amongst *shari'ah* scholars (Hitti 2007). In the event of insolvency of a limited liability company, the creditors may be liable only to receive the liquidated value of the assets of the company and have no recourse to its shareholders for the rest of their claims. The concept of such a *shari'ah* (or partnership company) based on a permissible equity profit and loss mode is acceptable as no *shari'ah* is perpetual, there is a specific objective as for Islamic Financial Institutions (IFIs). Limited liability could apply beyond traditional *musharakah* structures.

The issue of limited liability for the members of the corporation is very important from the point of view of Islamic law. The report of the Panel of Economists and Bankers (PEBs) that was submitted to the Council of Islamic Ideology, Pakistan states that: "the modern financial institutions cannot conceivably function on the basis of limited liability" (PEBs 1980:12). Muslim scholars and Islamic Fiqh Academy of the Organisation of the Islamic Conference (OIC) have written in support of the limited liability in Islamic law (IDB2000:130, Resolution 7/1/63).

Hens Kelsen states that the concept of limited liability arises from the concept of legal personality (Kelsen 1945:92). This means a corporation is an independent legal person, distinct from the shareholders, is dealing independently with the creditors. It is neither an agent for shareholders nor have the shareholders provided any kind of surety for the debts of the corporation. The money that shareholders have paid to the corporation in the form of share capital is attached to the *dimmah* or the corporation. It is to be repaid like the insolvent, like any other natural person all that the creditors can take or lay claim to are the assets of this corporation. As the shareholders have no relationship with their assets, nor are they sureties for the corporation, the creditors cannot satisfy their debts from the personal assets of the shareholders. In fact, the shareholders themselves stand at the end of the line of creditors with a claim on the assets of the corporation. It is for this reason

that we say that there is no liability here for the shareholders, and the term 'limited liability' is not an accurate description of the legal status of the shareholders. The shareholders have no liability; they are merely creditors sharing profits on the basis of the money they have advanced. In case there are huge losses and the corporation becomes bankrupt, everyone loses money whether shareholder or bondholder: to the extent of the amount paid.

Dias, in his well known book Jurisprudence, makes the statement that the concept of limited liability can be created without legal personality (Dias 1985:254).

Production of goods and services drives an economy to its success (Gitman and Mcdaniel 2008). For this economic actors involved in the production of goods and services such as business organizations mobilize their resources and arrange funds through different sources. They either borrow funds or use their own equity and fulfil their financing needs (Siddaiah 2011). Therefore the success of an economy is based on how it gets financed. Financial sector transactions are of two kinds: the first kind is driven by economic activities and the others are financial transactions known as 'synthetic' transactions and do not contribute to the real sector economy (Kothari and Kothari 2009). However, financial transactions linked with real sector growth are emerging very rapidly due to religious motivation and their contribution to the real economy and in popular terms is known as Islamic finance (Gannon 2009).

Since Islamic finance has to establish a link with real economic activities and cannot exist independently, therefore, pure money transactions and bonds are not allowed as they cause *riba*. The opposite is true for conventional financial institutions by dealing in money transactions and instruments based on debt hence involved in *riba* related activities. Therefore, IFIs are linked with real asset trade in either on the basis of Profit and Loss Sharing (PLS) basis, on mark-up based trade, or on commercial activities based on rental income. Besides IFIs have to comply with conventional regulations and *shari'ah* principles.

As mentioned before IFIs have to comply with international financial regulations and with the *shari'ah* principles. The *shari'ah* standard setting bodies are Accounting and

Auditing Organisation of Islamic Financial Institutions (AAOIFI) and Islamic Financial Services Board (IFSB). The international regulations may include the minimum capital requirement to safeguard the financial system and the interested parties therein, which is propagated by the Basel Committee for Banking Supervision (BCBS) through its consultative reports, and these are known as Basel I (dated July 1988), Basel II (June 2004) and Basel III. The Basel I and Basel II consultative reports of BCBS prescribe minimum capital requirements for the banks and provide for criteria to assess the risk profile of a financial institution risks involved in the development of a financial product.

This research focuses on derivatives and specifically a derivative product namely *sukuk*. Derivates are financial instruments whose returns are derived from those of other financial instruments. That is, their performance depends on how other financial instruments perform. Derivatives serve a valuable purpose in providing a means of managing financial risk. By using derivatives companies and individuals can transfer, for a price, any undesired risk to other parties who either has risks that offset or want to assume that risk (Chance and Brooks 2008:1). *Sukuk* are defined by Standard 17 of the AAOIFI as: "Investment *sukuk* are certificates of equal value representing undivided shares in ownership of tangible assets, usufruct and services or (in the ownership of) the assets of particular projects or special investment activity..."AAOIFI 2008: Standard 17). *Sukuk* are a kind of derivative product introduced by Islamic finance, are documents of ownership or leasing and usage rights exercisable by the *sukuk* holders.

In this research *sukuk* as an Islamic securitization product will be analysed with a specific focus that whether or not it is *shari'ah* compliant. In securitisation, an asset-backed security is made up of a number of separate, distinct assets that have been aggregated together into a single security. In doing so, all the individual assets are used to "back" the cash flows of the resulting security. The security is then sold to investors in pieces known as tranches. This process of packaging several assets into a single security is also known as securitisation and the assets are said to have been securitised (Klein and Iammartino 2010:226).This research will investigate the compatibility of *sukuk* with the *shari'ah* objectives of AAOIFI. Further an analysis will also be provided whether or not *sukuk* meets the standards and criteria of conventional securitization structures in order to

safeguard the interests of different parties involved in it and the public at large. The answers to these questions determine the *shari'ah* compatibility of *sukuk*. This research, hence, throws light on *sukuk* structures and provides opportunity for further product development, design and *shari'ah* standards in the light of *shari'ah* principles.

Financial products are developed on the basis of investors' needs and to perform efficiently in existing regulatory and legal regime giving best return to the interested parties by diversifying risk at all levels. Regulators make sure that no one should beat the regulations and their objectives by devising new products. Similarly *shari'ah* compliant products must be regulated in a manner that these should not defeat the objectives of *shari'ah*. Financial products involve people money and interests therefore it is important to study the financial products in detail and issues involved in these products such as regulatory and *shari'ah* issues and *sukuk* is one of those products which need a thorough study.

1.3 AIMS AND OBJECTIVES OF THE STUDY

This research aims to explore and analyse *sukuk* as financial and economic instruments in the legal regime of *shari'ah* mainly implemented through AAOIFI *shari'ah* standards. One of the aims of this study, therefore, is to identify these problems amongst others, which are being faced by the Islamic financial industry such as legal, regulatory issues with reference to *sukuk* and derivatives. Another aim of the research is to examine different devices used in *sukuk* such as *wa'ad* (promise) in the light of *shari'ah*. This study aims also to determine the key legal, regulatory and *shari'ah* compliance issues to the Islamic financial industry in UK with special focus on derivatives (*sukuk*), in particular, and to the Islamic financial industry as a whole in general. After highlighting the issues with a critical analysis, this research will end with recommendations in accordance with the injunctions of the Qur'an and *sunnah*.

Therefore, the following objectives are developed to be examined:

- (i) the *shari'ah* compatibility of *sukuk*;

- (ii) the *shari'ah* concerns related to derivatives such as Short-selling (SS), existence of subject-matter at the time of contract, possession of subject-matter before conclusion of contract, debt-sale and speculation may be removed with careful considerations;
- (iii) the *sukuk* as a securitised product and its comparison with conventional derivative products;
- (iv) the *wa'ad* and its comparison with *'aqd* (contract), and with Common law concepts of 'promise' and 'promissory estoppel', their usage in equity-based *sukuk*, and derivative products such as Foreign Currency Forward Options; Total Return Swaps (TRS) and SS; and
- (v) the *sukuk* related issues in United Kingdom (UK).

These aims and objectives are responded in detail through discussing the literature surveys. However, primary research is also conducted on these issues in the case of UK to generate original research.

1.4 RESEARCH QUESTIONS

On the basis of above objectives following research questions were examined and answered in this research:

R_{q1}: *Sukuk* are *shari'ah* compliant. The *shari'ah* compliant nature of *sukuk* is determined in the light of standards set by AAOIFI, which is a standard setting body for *shari'ah* compliant products. AAOIFI does not have a standardized master contract which may be adopted by the parties for issuing *sukuk* rather *sukuk* instruments are devised, issued and contracts are drafted to meet the needs of investors and issuers. In the absence of a standardized contract, *sukuk* may not be complying with *shari'ah* principles and this may be settled in the discussion and analysis which this research will present.

In order to test whether *sukuk* are *shari'ah* compliant or not, the underlying asset, ownership in the underlying asset, the nature of the contract, risk-return profile of the product, undertakings and their influence on the concerned parties will be examined.

R_{q2}: Derivatives may be allowed under *shari'ah*. *Shari'ah* concerns such as SS, existence of subject-matter at the time of contract, possession of subject-matter before conclusion of contract, debt-sale, speculation may be removed with careful considerations.

R_{q3}: *Sukuk* as Islamic derivative instruments are as efficient as that of conventional derivative products and apply the similar securitization principles. *Sukuk* represent a process of securitization and securitization is selling the asset portfolios to investors in the form of securities. Their growth may be witnessed by exploring development in UK.

The process of securitization involved in *sukuk* is same as that of conventional securitization. An originator presents its assets for securitisation when it needs financing. The Special Purpose Vehicle (SPV) acquires ownership of the assets and packages them into different tranches for sale to investors. Upon maturity of the *sukuk*, SPV gets dissolved and *sukuk* holders are returned with their amount and the originators get their assets back. The process is similar to conventional securitisation but in *sukuk* securitisation the process must be *shari'ah* compliant. For example, when *sukuk* holders invests by purchasing *sukuk* certificates and gets ownership in the assets, they must also bear the risk in the assets even if the buyer has not paid the full price. In *ijarah* contract for example the risk stays with the lessor and a lessee only assumes risk where usage of the property is involved. For risk analysis of *sukuk*, the underlying contract; guarantee for safeguarding the periodic payments; repurchase undertaking to guarantee the principal; collateral; and put or call options as provided by the contract *etc.* will be analysed.

R_{q4}: *Wa'ad* has the same authority as that of *'aqd* (contract).

R_{q5}: *Wa'ad* can be compared with 'promise' and 'promissory estoppels' in Common law.

R_{q6}: Use of *wa'ad* in equity-based *sukuk* is against the *shari'ah*.

R_{q7}: Usage of *wa'ad* in derivatives, Foreign Currency Forward Options, TRS and SS is inappropriate.

R_{q8}: UK is an attractive country for promotion and growth of *sukuk*.

R_{q8(i)} In UK *sukuk* have received positive legislative and regulatory response on its securitisation development;

R_{q8(ii)} Whether or not the desire of AAOIFI that *shari'ah* boards should have more operational powers is welcomed by UK?; and

R_{q8(iii)} *Sukuk* are not treated as debt-instruments in UK.

1.5 RESEARCH STATEMENT AND RATIONALE

This research aims to study and thereafter to examine the foundations of banking and finance in Islam, its concepts, precepts and laws, with some reference to its roots in early Islamic history with the objective of exploring the contemporary scene and the challenges facing Islamic finance today especially in UK. In addition, this study also aims to explore various products such as derivatives (*sukuk*), which the IFIs are offering to the market with a comparison of these products with conventional products.

This research focuses on UK's Islamic banking industry, its prospects of growth and the problems within legislative, regulative and *shari'ah* board frameworks. It also compares UK Islamic banking industry with the other contemporary jurisdictions in terms of legislative, regulative and *shari'ah* board roles to come up with a conclusion that which of the industries is strictly *shari'ah* compliant and best fulfill the needs of the Muslim society in particular and the whole society in general. Therefore, this study is motivated by the need to fulfill the needs of the Muslim investors by indicating problems in the way of Islamic finance especially by focusing on *sukuk* and to remove confusions among different masses of Muslim communities on investing their hard-earned monies Islamically and ethically.

1.6 SIGNIFICANCE OF THE STUDY

Due to increase in economic activities and to achieve efficiency, new forms of businesses and products are being emerged in the business world. To regulate economic and business activities, regulations are formulated in order to save the interests of the relevant parties. In the case of *sukuk*, not only national and international regulations are involved but compliance with the *shari'ah* principles is also a requisite.

Since the *sukuk* is a latest development in the financial world, there are not many analyses of *sukuk* structures. Therefore, there is a need to highlight hurdles in devising *sukuk* so that the true spirit of *shari'ah* is observed which benefits the society. The study will contribute in new and efficient *shari'ah* compliant product development, stability of the financial system with a just financial environment in the society. The research is primarily based on the Islamic socio-economic system. Refinement and improvement is a continuous process, which is achieved through correcting the previous mistakes and providing solutions for the problems. This research is equally beneficial for investors, academics and professionals in the field of trade and finance. The research provides a framework for these interest groups in order to practically involve in the area of Islamic finance. The research is unique for it provides an analysis of current Islamic financial products in the light of classical *fiqhi* literature by raising concerns if the current practice goes against the settled and accepted *shari'ah* principles.

1.7 RESEARCH METHODOLOGY

This research is mainly based on documents and textual analysis. In doing so, relevant material in the form of secondary data collected from books, articles, reports, and position documents were collected. The data are analysed through an interpretative method in the sense of critically investigating how the data and material would respond to the questions raised in this study.

In the case study on the UK, a number of official and semi-official documents from the various UK institutions were collected. These documents were analysed through

deconstruction method to identify the underlying ideas, opinions and positions of the various institutions in the UK.

It should be noted that an attempt was made to collect primary data through a structured interview schedule with the *shari'ah* scholars and leading Islamic finance professionals. However, the response from such stakeholders were too less and too slow due to time constraints further time could not be allocated; and hence primary data could not be used to verify some of the issues raised in this study.

In terms of philosophical paradigm of the research, this particular legal research will draw on more than one paradigm as the nature and extent of it is such that it cannot disregard either one of positivist, interpretive or constructionist models. The term paradigm originated from the Greek word *paradeigma* which means pattern and was first used by Thomas Kuhn (1962) to denote a conceptual framework shared by a community of scientists which provided them with a convenient model for examining problems and finding solutions (Kuhn (1962) as cited by Didsbury (2004:43)). Kuhn defines a paradigm as: "an integrated cluster of substantive concepts, variables and problems attached with corresponding methodological approaches and tools..."(Kuhn (1962) as cited by Anderson and Burns (1989:21)). According to him, the term paradigm refers to a research culture with a set of beliefs, values, and assumptions that a community of researchers has in common regarding the nature and conduct of research (Kuhn 1977). A paradigm hence implies a pattern structure and framework or system of scientific and academic ideas, values and assumptions (Olsen et al. 1992). According to TerreBlanche and Durrheim (1999), the research process has three major dimensions: ontology, epistemology and methodology. Ontology is about the existence of objects and epistemology or theory of knowledge is linked to nature, sources and limits of scientific knowledge (Yeganeh and Su 2005). Epistemological orientations shape and determine a researcher's particular view of the world and of reality and provide him with guiding principles upon which he may found his research methodologies (Lincoln and Guba 1985).

Ontological and epistemological aspects concern what is commonly referred to as a person's worldview which has significant influence on the perceived relative importance of the aspects of reality. Two possible worldviews are: objectivistic and constructivist. Their different ways of seeing the world have repercussions in most academic areas; yet none of these views is considered to be superior to the other.

Both may be appropriate for some purposes and insufficient or overly complex for other purposes. Also a person changes his/her view depending on the situation. Research paradigms inherently reflect our beliefs about the world we live in and want to live in (Conrad 1993:132). Based on this belief, Guba and Lincoln (1994) distinguish between positivist, post-positivist and postmodernist enquiry, grouping postmodernism and post-structuralism within 'critical theory' (Guba and Lincoln (1994) as cited by Hassard et al. (2008:144)). The nature of the positivist approach is relevant since, from an ontological perspective, the topic comprises of stable external realities of laws and legislative mechanisms which means that the research adopts an objective and detached epistemological stance towards that reality and as such the methodology would test the theory accordingly (Kapner and Marshall 1990).

Real existence of objects known in experience is the subject of Realism. If viewed ontologically, realism implies an external reality of objects independent of human investigations and cognition. But epistemologically a researcher gets the external reality through cognitive investigations (Johnson and Duberley 2000) which generally lead to positivistic approach.

The realists or positivists recognize this world as real but the idealists regard this world not as a true reality independent of our minds but take it as a construction of these minds. Therefore, one doesn't know this world in its real existence rather he views this world under the influence of his mental approach. Perceiving is not the passive reception of a reality independent of human minds but it is a creative process in which minds produce those objects (Kant). Therefore, the reality being an external structure is imposed by the internal forms of our mind (Delanty 1997).

Therefore in constructivism reality cannot be independent of its observers and players hence objectivity is created by people and can therefore be changed by them (Arbnor and Bjerke 1997).

Having said that, since the *shari'ah* laws of promise have been interpreted and applied in various ways in *sukuk*, the interpretive approach is also applicable. This is because the topic ontologically consists of internal reality of subjective experience which implies a need for an inter-subjective or international epistemology and thus a legal methodology is required that explains the subjective reasons and underlying meanings (Bryman 2004).

Still further, to iron out the apparent ambivalence between inter-related legal principles of English and *shari'ah* laws and to establish ways of accommodating *wa'ad* products under the English and *shari'ah* laws, the significance of constructivist approach is obvious too. This is because, from an ontological perspective, both sources of law involve certain formally constructed realities. This denotes the epistemology as being one of statutory and textual construction which leads to a methodology of deconstruction as it essentially entails textual and discourse analysis (Biggam, 2008).

1.7.1 GENERAL RESEARCH METHODOLOGIES

Regarding the general research methodology, since this legal research mainly involved textual analysis, the qualitative method helped to facilitate attending to the legal issues as a whole instead of quantifying them into separate variables. The black-letter law methodology proved to be significant for analysis of both English common law and *shari'ah* law sources.

There are relative merits of both qualitative and quantitative methodologies and as such many mixes the two but in the present research only the former will be utilised (Blaxter et al. 2006). The aim is to trace the legal argumentation and to rigorously analyse deviation between theory and practice. Qualitative methods allow data to be understood in a broader contextual manner by immersing the research into the wider setting (Sherman and Webb 1988). Since this legal research will mainly involve textual analysis, the qualitative method will facilitate attending to the legal issues as a whole instead of

quantifying them into separate variables, which is also referred to as contextualism and holism (Gibbs 2002).

In relation to legal research methodology, since the research is legal, there are certain methodologies which are more specialised. Essentially there are two approaches, namely 'black-letter law' and 'law in context' (McConville and Chui, 2007). The former focuses on "the law itself as an internal self-sustaining set of principles which can be accessed through reading court judgments and statues with little or no reference to the world outside the law" (McConville and Chui, 2007). It is a traditional approach which assumed on the existence of independent legal universe as the object of study. It is the establishment of knowledge of the specific legal rules that regulate social activity by restricting it to the legal rules only and without having any reference to the social activity to which these rules are related to (Slapper and Kelly 2010:17).

There is another new approach which is being widely used by the academia to study the law is the contextualist or the law in context approach. Under this approach law is considered as a social phenomenon and it operates within a social context. There are different tasks which law performs in a society such as the maintenance of order or the regulation of economic activity (ibid).

This shift from the black-letter law approach to the contextualist one has important impact. The law is no longer seen "[a]s simply a matter to be explained and justified in its own terms. It no longer constitutes its own discrete universe, but is analysed and perhaps more importantly it can actually be assessed within its socioeconomic context and its performance can be evaluated in relation to the supposed purposes within that socioeconomic context" (ibid).

The contextualist approach has advantage over the black-letter law approach because it also takes into consideration the human behaviour in the real world (ibid).

This 'doctrinal research' is undoubtedly significant for analysis of both English Common law and *shari'ah* law sources.

However, doctrinal analysis may be criticised for being intellectually rigid and inflexible. Therefore, since the issues of *wa'ad*, promise, *sukuk* and derivatives have wider context the need for the latter approach is equally useful. This 'socio-legal' method concentrates initially on problems where the "law itself [can become] problematic both in the sense that it may be a contributor to or the cause of the [stated] problem and in the sense that whilst law may provide a solution..., other non-law solutions... are not precluded and may indeed be preferred" (McConville and Chui, 2007). Although *wa'ad* and promise undertakings can be rendered in a manner which is compliant from the perspective of English Common law and *shari'ah* law, the overriding objective of the *shari'ah* principles particularly may still be lacking. This implies that the law is not the only solution but there is a need for an 'inter-disciplinary' or 'socio-legal' solution (Gordon 1993; Banakar and Travers 2005).

1.7.2 RESEARCH STRATEGY

1.7.2.1 HISTORICAL RESEARCH AND CASE STUDIES

As for the best research strategy to meet the objective, one can argue in favour of survey, experimental strategy, grounded theory, historical research or case study. However, "what matters is not the label that is attached to a particular strategy, but whether it is appropriate for [the] particular research" (Saunders et al. 2000). Without going into detail, the advantages of the historical research are obvious for this legal research.

Historical research is necessary in identifying and analysing primary and secondary sources of *shari'ah* law and English Common law which have historical background especially the classical texts.

As regards the sources of research, English Common law sources and *shari'ah* law sources were consulted. Both English Common law and *shari'ah* law data can be divided into primary and secondary sources. As for the former, the primary sources are statutes, statutory instruments and case laws. The secondary sources tend to include journal articles, law commission publications, textbooks and legal databases. Lord Goff summed up the coherence of these sources when he remarked that "the prime task of the jurist is to

take the cases and statutes which provide the raw material of the law on any particular topics and to build up a systematic statement of the law on the relevant topic in a coherent form” (Goff 1987).

As for *shari‘ah* law, the primary sources are the holy Qur’an (which is the divine book of God) and the *sunnah* (which is the collection of the sayings, acts and tacit approvals of the Prophet Muhammad (peace be upon him) (Kamali 1991). The secondary sources incorporate *ijma‘* (consensus of juristic opinion) (Hassan 1978), *qiyyas* (analogical deduction) (Hassan 1986) and *ijtihad* (inferential and deductive reasoning by juristic endeavours in light of the Qur’an, *sunnah* and *ijma‘* (Zahrah, 1958). Whilst *fiqh* is the law itself, these sources (also known as *usul al-fiqh*) are the methodology of that law. As such *usul al-fiqh* is that mechanism which “provides the criteria for the correct deduction of the rules of *fiqh* from the sources of *shari‘ah*” (Kamali 1991; Nyazee 2000). In addition, there will be reference to the rationale and objectives of *shari‘ah*, known as *maqasid al-shari‘ah* (Raysooni 2005).

It is paramount to distinguish between the *usul* and the maxims of *fiqh* which are known as *al-qawa‘id al-kulliyyah al-fiqhiyyah* (Kamali 1991; Nyazee 1994). The legal maxims are abstract rules and theoretical guidelines which are extracted from the study of *fiqh* itself. These maxims are independent of the *usul* and are frequently employed in legal pronouncements.

Therefore, these sources of English Common law and *shari‘ah* law will be the target data for this particular research and they will undergo the following analysis.

1.7.2.2 FRAMEWORK FOR DATA ANALYSIS

Qualitative analysis of this research can employ ‘categorising’ or ‘contextualising’ strategies (Maxwell 1996:78). The former is referred to by some as coding whereby the data is ‘fractured’ and rearranged into categories which allows the data to be compared in terms of groupings (Strauss 1987). Even though this form of analysis is mainly used inductively and part of the ‘grounded theory’, “some coding categories may be drawn

from existing theory” (Maxwell 1996:78). This form of analysis may therefore be applied to this deductive research.

However, the alternative strategy is more suitable. This entails a process of contextualising by attempting to understand data in its context through various ways of establishing connections between numerous aspects of text (Mishler 1986). One form of this analysis is referred to as discourse analysis which is “the act of showing, how certain discourses are deployed to achieve particular effects in specific contexts” (Blanche *et al.*, 2006). This form appears to be more suitable for this research as essentially there will be textual analysis of legal content as part of a larger body of primary and secondary sources of *shari‘ah* and English Common law. This will mean that “in addition to engaging in detailed readings of pieces of text, many different texts [will need to be examined] to show patterns of variation and consistency in discourse” (Blanche *et al.*, 2006). There are particular rules known as statutory construction and *stare decisis* to distinguish statutes and precedents in the context of English Common law. Similarly in the case of *shari‘ah* law, there are rules of interpretation to distinguish *zahir* (manifest text) from *nass* (explicitly ordained text), *‘aam* (general text) from *khaas* (specific text) and *haqiqi* (literal text) from *majazi* (metaphorical text) to name but few (Kamali 1991).

1.8 ORGANIZATION AND CONTENTS

This research is organized as follows. Chapter one provides an introduction to the subject, its aims and objectives, scope, research methodology and organisation and scheme of the chapters of the project.

Chapter two presents an overview of the Islamic banking and finance with literature review. It provides an introduction to the traditional Islamic finance modes; securitisation in the contemporary financial world and in Islamic finance and the need of securitisation. During the course of discussion, *sukuk* are compared with the concept of bond, their growth is considered and different structures are analysed.

Chapter three shed light on the *shari‘ah* issues in Islamic finance in the financial instruments such as derivatives (*sukuk*). It gives an introduction to product development

in Islamic finance and its evolutionary stages with principles involved in it. *Sukuk* are discussed as an Islamic financial product. Thereafter, it discusses the major *shari'ah* issues involved in derivatives and *sukuk* such as issues pertaining to subject-matter, possession of subject-matter, SS, sale of debt, speculation, gambling and *gharar*.

Chapter four is about the contemporary legal and *shari'ah* concerns in the *sukuk* industry like risk profile of Islamic finance as a system, *sukuk* ratings, *sukuk* pricing, difficulty in implementing *shari'ah* compliant products with current legal codes, regulations pertaining to *sukuk* both at domestic and international level, issues pertaining to ownership and purchase undertaking.

Chapter five analyses the critical issue of the usage of *wa'ad* in *sukuk*, comparison of *wa'ad* with promise in Common law, *wa'ad* in the eyes of classical scholars and present day scholars, case-laws on promise under the Common law system, comparison of *wa'ad* with promissory estoppel and usage of *wa'ad* in derivatives.

Chapter six provides the history of Islamic finance in UK and discusses the development of *sukuk* industry in UK with future growth prospects. It deeply discusses issues involved in the development of Islamic finance in UK. UK *sukuk*'s legislative and regulatory developments on securitisation will be presented. The discussion also focuses on the Financial Services Authority's (FSA) legislative and regulative infrastructure for *shari'ah* compliant products. *Shari'ah* boards' appointment is part of *shari'ah* compliance process in UK. A discussion will be made on the appointment of *shari'ah* boards in UK. Chapter will also focus on the definition of *sukuk* in terms of regulations whether these are treated as debt-instruments or Collective Investment Instruments (CIS). This is important for tax consequences.

Chapter seven concludes with analytical approach the whole discussion and present recommendations and suggestions.

CHAPTER 2

ISLAMIC FINANCE, SUKUK AND SECURITISATION: LITERATURE REVIEW

2.1 INTRODUCTION

Banks, as financial intermediaries, have significant role in the economic development of a country (Isard 2005). The Islamic way of banking has received scant scholarly and public attention in recent years, the roots of which can be traced back to the life of the Prophet Muhammad (peace be upon him), more than 1400 years ago (Vogel and Hayes, 1998; Wilson and Baldwin 1988; Wilson 2002a; 2002b and 1995). It is however, revived into the modern commercial meaning in the 1970s with an unprecedented growth rate of 15 per cent per annum for the last decade (Vogel and Hayes 1988; Latif 2006; Solé 2007; Tacy 2006).

Islamic financial system is based on *shari'ah* which in turn is based on Qur'an and *sunnah*. *Shari'ah* lays principles pertaining to not only this world but also the hereafter. As such, *shari'ah* safeguards human beings' "faith, life, intellect, posterity, and wealth" (Al-Ghazali (n.d) as cited by Saleh (1992:2)) which encompass the welfare of the people in this world and in the hereafter, with the welfare dispensed with "complete justice, mercy, well-being, and wisdom" (Ibn Qayyim (1992) as cited by Hassan (2012:824)). Hence, an exploitation-free Islamic finance, based on *shari'ah*, seeks to balance one's pursuit of obtaining wealth with religious, moral and ethical considerations. *Shari'ah* prohibits *riba* (interest or usury) and *gharar* (risk and speculation).

Since Islam aims at developing spiritual values and social justice, therefore, these values are the focus of Islamic finance. Currency should have some value and unequal exchange of currencies is not allowed because it may pose a threat to social order and morality. Islamic monetary exchanges should be tied to actually existing objects. Therefore,

Muslims are not permitted to pay or receive interests, take out interest-bearing mortgages, carry balances on credit cards and invest in fixed income securities with guaranteed return (Kettell 2010a). Investments should be asset-based rather than debt (Askari et al. 2009). Further to the above, trade related to non-permissible activities like alcohol, tobacco, pornography is not allowed (Visser 2009).

2.2 TRADITIONAL ISLAMIC FINANCE MODES

Traditional Islamic finance modes are the underlying basis of *sukuk* forms (Gannon 2009). Although they merit detailed study in themselves but for the purposes of this research they are summarised and relevant details are highlighted. AAOIFI *shari'ah* standards (2008) specify more details regarding each. Profit Sharing (PS) *mudarabah* in addition to PLS *musharakah*, activities are preferred over fixed-return modes such as *murabahah* (known cost plus mark-up)-particularly those linked to interest benchmarks (Khorshid 2009).

A fixed return on a loan is not permitted as a loan is considered to be a means of ownership transference (Thomas and Hussain 2005). Only the principal can be accepted to be returned-unless it is a fully benevolent loan (*qard-e-hasan*) where the principal may not even be expected back (Ahmad 2010a). *Mudarabah* and *musharakah* are the two partnership forms most commonly used from others available in Islamic finance (Hooker 2008).

The two primary parties in a *mudarabah* are the managing partner or *mudarib* and the investor or *rabb al-mal* ('owner of the capital'). The *mudarib* is a trustee and will not share in losses (Adam and Thomas 2004). The *mudarib* alone is empowered to make and manage business decisions (Saedd 1996). Arguably, the *mudarib* may earn a wage under the investment agreement for performing specific tasks (Udovitch 1970). Typically, the *mudarib* expects to recover his or her expenses from the ordinary proceeds of the *mudarabah* (Saedd 1996). The two forms of *mudarabah* are *mudarabah al-muqayyadah*, or 'Restricted *mudarabah*', and *mudarabah al-mutlaqah*, or 'Unrestricted *mudarabah*' (El-Tiby 2011). The former is for a specific business or place and it is contractually

limited by time and place, partner and deal type. The latter is one in which the manager is free to act within traditional *shari'ah* parameters (ibid).

There are two general forms of *musharakah*: *shirkah al-'aqd* and *shirkah al-milk*. *Shirkah al-'aqd* is the most common application of *musharakah* (Hassan and Lewis 2007). Although capital contributions may be in kind or by services provided, they are typically cash and valued at an agreed par value. With all methods of *musharakah*, the capital quantified and specified by mutual agreement (Thomas and Thofeek 2005). As with *mudarabah*, *musharakah* profits must be shared in the same proportion as set down in the contract (Kettell 2011a). Losses are borne by partners according to their share in the capital. The profit cannot be structured to give a guaranteed rate or yield to one party (ibid).

Shirkah al-milk is a partnership of two or more owners of a property held in common (Chapra 1985). This form of partnership may be established without a specific contract, as in the case of inherited property (Al-Harran 1993). There are optional and compulsory forms (Abu Ghuddah 2007). But the method's primary limitation is that the object of the partnership, the underlying property is not divided or unitised (Usmani and Zubairi 2002). This creates restrictions for the use or specific division of the property, and further problems using this sub-form in the banking and financial sectors, unless it is the engine for a declining balance partnership (often known as Diminishing *musharakah*) (Khorshid 2009).

Wakalah is an agency contract and is widely applied by IFIs and their clients (Fitsell and Williams 2007). The concept ranges from brokerage services in permissible activities to serving as the agent (*wakil*)-buyer or seller on behalf of a contractor (usually a bank) in several transactions (ibid). There are two types of contracts. One contract is one in which all the rights and obligations pass to the agent from the contractor. The other contract is one in which rights and obligations remain with the contractor (Aldohni 2011).

PLS investments are given more weight to the profitability of the investments (Iqbal 2011:81). They are participatory by nature. PLS activities also realise more stability in the economy in event of loss than there would be in the case of a conventional loan

default (Hassan and Mahlkecht 2011). This is more so as transactions are based on real assets rather than those that are nominal transactions (Al-Jarhi 2005). It is preferred that most activities are more akin to equity-based PLS as this is less reliant on debt-type investments such as *murabahah* (Warde 2000).

In addition to the highlighted partnership contracts, there are exchange contracts (Iqbal and Mirakhor 2007). These exchange contracts are categorised into three predominant forms based upon a deferred trading principle; Price Deferred Sale (PDS), Object Deferred Sale (ODS), and Object and Price Deferred Sale (OPDS) (ibid). All exchange contracts have a common obligation, which is the result of the contract or the transfer of ownership of the underlying object from one party to another. There are several different types of exchange contracts complying with the rules of Islamic finance. These are identified as they also have relevance to derivatives and *sukuk* forms (Iqbal and Mirakhor 2007).

The contract *bay' musawamah* refers to a normal sale in which both parties to the contract barter the selling price. The percentage/amount of profit in this contract is not disclosed to the buyer. The cost price of the object is unknown to the buyer. In contrast, *bay' murabahah* (a PDS) is a contract referring to a normal sale in which the selling price of the object is defined according to the cost price. The latter is known to both the seller and the buyer. This is a cost plus profit credit sale that is applicable for many retail transactions performed by Islamic banks in favour of private customers (car financing, equipment financing etc.). The selling price is payable on an instalment basis, according to a predetermined schedule. *Bay' mu'ajjal* is the term applied in Malaysia in place of *bay' murabahah*.

Bay' murabahah is the most commonly used financing instrument by IFIs. Although strictly speaking it is not being used in the manner it should be. However as a consequence of moral hazard and adverse selection, Akerlof (1970) identified issues between IFIs and their customers arising from the partnership modes, this mode was referred to. Additionally, the principle-agency problem arose. The use of *murabahah*

limits this further although in many transactions this is still a valid concern. There are several constraints of *murabahah* for example trading is limited as it is a debt instrument.

Two important Islamic finance modes are *salam* and *istisna'* and are to be considered exceptions to normal rules of Islamic Finance and for special contexts. *Bay' salam* is a contract of an ODS involving a form of forward sale in which payment is at spot while the delivery of the good is deferred to a future date. This contract is a trade contract and not a loan. *Bay' istisna'* (progressive financing) refers to a derivative of *bay' salam* in which goods are sold before they come into existence. It is basically an OPDS in which an order is placed by the buyer to the manufacturer to manufacture a product or object. The payment is deferred and made in instalments subject to the manufacturing progress of the object. The delivery of the object is made upon completion. This contract refers to the acquisition of a product or a property in which the payment is made progressively in line with the progress of the manufacturing or building of the asset. A basic *istisna'* contract includes a bank or entrepreneur that makes progress payments to a builder or manufacturer, according to a defined plan of work (Thomas et al. 2005a).

Bay' al-'urbun contract is similar to a covered call option contract where the buyer makes a non-refundable deposit against the price. The buyer has the right, at a later stage, either to confirm or rescind the purchase, but loses his deposit if he does not conclude the purchase (Vogel and Hayes 1998).

Bay' muqayadah in English is known as the barter sale, which is the exchange of one specific non-fungible for another such as the exchange of a dress for an animal (Ayub 2007:124; Muhammad 2007).

Last but not least is *ijarah*. *Ijarah* is the Arabic word for providing goods or services for temporary use against a wage. Literally, one sells 'usage' or 'usufruct' for a period of time, but the asset ownership remains with the lessor (Usmani 1998). Sub-leases are permissible with the consent of the lessor. The asset or service must have value. Certain consumables like money, food, or fuel may not be leased (ibid).

Ijarah is an Islamic lease as more like an operating lease, but redemption features may be structured to make it similar to a financial lease (Schoon 2009a). The rental may either be fixed for the life of the lease or adjusted periodically by agreement. Rent may only commence when the property has been delivered or made available to the lessee at a specific time and place agreed by the lessee (Usmani 1998).

The traditional Islamic concept requires the lessor to pay for the ownership costs and the lessee to maintain the asset in good order (ibid). In debatable practice, the lessee usually agrees to insure and maintain the property in commercial deals through a side agreement that specifies duties (ibid).

Most *ijarah* transactions have a formal redemption feature whereby the lessee will take possession of the object at the end of the lease. This form of transaction is termed both, *ijarah muntahiah bi al-tamleek* ('lease ending in ownership') or *ijarah wa iqtina'* ('lease with acquisition') (ibid). Ideally, the lease itself is not contingent on any promise to sell or buy, but such promises may be executed at the closing to avoid violating the principle of two sales in one. In this lease contract there is not a stipulated transfer, rather a unilateral promise of transfer may be made by the lessor at a pre-negotiated price. The purchase price for the asset transfer may be either a market value purchase or at a nominal value. In the event of lease termination the decision must be mutual (ibid).

The traditional Muslim jurists are unanimous on the point that *bay' al-dayn* with discount is not allowed in *shari'ah* (Vogel and Hayes 1998). The overwhelming majority of the contemporary *shari'ah* scholars are also of the same view (ibid). Some from Malaysia have allowed referring to the ruling of the *Shafi'i* school. However, they did not consider the fact that the *Shafi'i* jurists allowed it only in a case where a debt was sold at its par value. Rosly and Sanusi (1999) have observed that, "the trading of Islamic bonds at a discount using *bay' al-dayn* has been found unacceptable by the *Jumhur ulama'*, including *al-Shafi'i*. As such, the position of Malaysian Islamic bonds remains unacceptable among the Middle Eastern jurists although some Malaysian jurists found this the opposite." OIC Islamic Fiqh Academy (IFA), which has the representation of all

Islamic countries including Malaysia, has also approved the prohibition of *bay' al-dayn* unanimously without a single dissent (Ayub 2005).

Many *sukuk* issues are subject to severe criticism due to involvement of *bay' al-'inah*, *bay' al-dayn* and other non-*shari'ah* compliant traits that make the *sukuk* as good or as bad as interest based bonds (Saeed and Salah. 2012:52). *Bay' al-'inah* (sale and buy-back) is a double sale by which the borrower and the lender sell and then resell an object between them, once for cash and once for a higher price on credit, with the net result of a loan with interest (Krichene 2013). As such, it is a legal device to circumvent the prohibition of *riba*. Rosly and Sanusi (1999) comment, “the use of legal device is therefore an evidence that the *niyyah* (or intention) factor is undermined or made secondary in the securitization process of Islamic bonds in Malaysia. To retain the basic structure of traditional bonds in Islamic finance, that is providing fixed return to investors, practitioners and the relevant *shari'ah* experts may have wrongly applied *shari'ah* laws, which implies now that the legitimacy of Islamic bonds issued using *bay' al-'inah* is suspect.”

2.3 SECURITISATION AND FINANCIAL SYSTEMS

Conventional securitisation practices have been commonplace within Western markets since their innovation in the 1970s and 1980s. Securitisation has arisen from the evolution of traditional market and national boundaries converging catalysed by technological innovation that has brought about dynamic adjustments to competitive financial markets (Singer 2001b). Lockwood defines securitisation as ‘an originator to obtain financing through the capital markets based upon the quality of the assets rather than the originator’s overall credit (Lockwood et al. 2001). Conventionally, asset securitisation transforms private debt into marketable securities or public debt.

Asset securitisation describes the process and the result of issuing certificates of ownership as pledge against existing or future cash flows from a diversified pool of assets (reference portfolio) to investors. It registers as an alternative capital market based refinancing mechanism to diversify external sources of asset funding in lieu of intermediated debt finance based primarily on the risk assessment of securitised assets.

As a form of disintermediation it transforms traditional asset classes to new asset classes with improved risk-return profiles. For securitisation to be contextualised, an understanding of the marketplace and its functions requires to be elaborated upon that is relevant for ensuing discussion also on derivatives and *sukuk*.

Most of the literature research on securitisation is found to be primarily USA-biased. There was considerably less available sources for the UK context and regulatory bodies in comparison within the public domain. This was most probably due to the USA market for securitisation being more developed.

The securitisation phenomenon has been accompanied by the rise of structured finance or financial engineering (where a financial contract or product is customised) and its associated derivation of derivatives (for example tools such as futures forwards, swaps and options) (Sinkey Jr. 2001). The objective of all these activities involves the transformation of cash flows as well as risk-return characteristics. There are generally two forms of conventional securitisation; true sale asset-backed (off-balance sheet structure) or synthetic securitisation (on-balance sheet structure).

A financial system functions to channel funds from surplus units to deficit units (Fell 2000). It creates liquidity and money and provides financial services vital for resource allocation and economic growth. Further, it also offers asset and risk transformation adjustments (Avgouleas 2012). Within the financial system, financial markets are organisational frameworks within which financial instruments can be bought and sold (Mishkin and Eakins 2009:17). Financial markets are featured with the factors such as that the intermediary finance is being used as opposed to direct finance in the channelling of funds from primary lenders (investors) to ultimate borrowers (investees), mostly the banking system; that the financial markets are among the most heavily regulated sectors in the economy; and that debt rather than equity is the predominant means of funds raising in financial markets (Croushore 2007; Ritter and Silber 1974; Lilienthal 2009; and Madura 2001:182). Two economic factors seem to have yielded the structural features of financial markets: the problem of information asymmetry in the theory of financial

contracts and the role of transaction costs as implied in the theory of economies of scale (Khan and Hildreth 2004; Jong and Rindi 2009).

A financial intermediary is an organisation, which borrows funds from lenders as liabilities and lends them to borrowers as assets on terms that are better for both parties than if they dealt directly with each other. Due to transaction costs and imperfect information distribution between parties and differing objectives, matching lenders with borrowers directly is complicated. Small investors are less likely to be involved as commissions and charges are too large and diversification is difficult. Financial intermediaries transform assets e.g., in terms of their maturities as well as transform the risk profiles of securities for participants through leveraging their economies of scale, specialisation and enhanced information advantages. These lead to cheaper information costs and lower transaction costs for borrowers and lenders. For example, banks borrow short and lend long.

However, securitisation acts through disintermediation by creating new asset classes where suppliers and buyers can interact and create market linkages directly rather than indirectly traditional administrative linkages through financial intermediaries. This return to the earliest form of trade relationships has been brought about by the market forces of supply and demand. Securitisation is characterised by pooling of individual financial assets, combining them into a single pool and then issuing securities on that pool.

Interestingly, the similar reasons for intermediation now apply to disintermediation as in the form of securitisation. Securitisation reduces risk through diversification, risk is reduced of information asymmetries, and transaction costs are reduced. Securitisation also allows for increased leverage and securities can be tailored to meet the needs of specific investor classes (Singer 2001b). Existing regulatory structures or corporate rulings prevent investments in less than investment grade securities such as junk bonds. Securitisation can transform underlying assets to have higher ratings when pooled. It also allows smaller organisations to compete with larger organisations by pooling their resources into the asset pool.

Traditionally banking has performed four functions (Sinkey Jr. 2001). These are originating (making a loan), funding (holding the loan on the balance sheet), servicing (collecting the payments) and monitoring (to ensure borrower is maintaining the loan). However, securitisation sells assets on a bigger scale and eliminates the need for funding and monitoring. The securitisation lending function has only three steps; originate, sell and service. If servicing rights are sold, then securitisation lending has only two steps involved.

The underlying premise of subprime securitisations within the USA markets identify two limiting characteristics; subprime assets by definition have higher credit risk and hence require higher levels of credit support in comparison with prime-quality assets. Subprime assets also have higher yields than prime assets. Hence, with the current credit crunch arising from 2007, as the subprime assets are remote from real assets, Islamic commentators argue with the use of *sukuk* and Islamic finance principles, such a situation would not occur.

2.4 BENEFITS OF SECURITISATION

The benefits of securitisation are many. In taking the decision to securities an outstanding pool of receivable loans or other assets, the issuer is often motivated by various possible motives. Generally, issuers may find asset securitisation attractive because of an improved access to funds and lower capacity constraints (Jobst 2007). This can be the desire to raise finance at the least possible cost of funds as well as complement or offer an alternative funding source (Watson and Carter 2006). It could be simply to remove a specific pool of assets from the firm's balance sheet with a view to improving returns on debt or equity (Mantysaari 2010). Another advantage is to free up working capital for further core business (Kothari 2006). Additionally, the balance sheet is restructured and capital leverage reduced in the way of conforming to regulatory capital adequacy requirements such as Basel I, II & III (Rhodes 2006). At this point, an introduction to Basel Accords is given.

In 1975 the central bank governors of the Group of Ten countries established the BCBS (Lambrecht 2005:9). Basel I, Basel II and Basel III is a risk-based regulatory treatment

for international banks proposed by the BCBS by virtue of which on-balance sheet and off-balance sheet activities of financial institutions are recorded for the purpose of capital adequacy requirement. Financial regulators of most of the countries have incorporated this financial regulatory regime in the form of prudential regulations.

Basel I and II are the consultative reports presented in 1988 and 2004 respectively and these are known as The International Convergence of Capital measurement and Capital Standards. While the Basel III are the latest regulatory standards for the capital adequacy and liquidity of banks presented by BCBS in 2010.

Basel I is a framework of the regulatory convergence for strengthening the soundness and stability of the international banking system in the member countries (Greuning and Bratanovic 2009:123). The report was aimed at the fair and to minimize competitive inequality among international banks (Prakash 2008:85). It prescribed the minimum capital requirements for international financial institutions but national regulators were free to impose higher levels (ibid). A definition of capital was given by distinguishing between core and supplementary capital. Core Capital was defined as the primary equity capital which was freely available reserves while the Supplementary Capital was defined as the combination of reserves and hybrid debt/capital instruments and any subordinated debt (Burton and Brown 2009:263). Reserves were defined as the deposits undisclosed on financial statements but disclosed otherwise to the regulators, revaluation reserves arising from formal valuation of company assets, and general provisions or general loan-loss reserves that are created against any potential losses. The minimum capital level requirement was set at 8% with at least 50% core capital and supplementary capital not to exceed core capital. Hybrid debt capital instruments were the instruments having close similarity to capital and especially it contains property to “support losses on an on-going basis without triggering liquidation” BIS (1988:6). Subordinated term debt was not to exceed 50% of tier 1 capital (ibid).

Goodwill was excluded from the tier 1 capital and in order to avoid the “multiple uses of the same capital resources in different parts of the group” the investment, made in

subsidiaries engaged in banking and financial activities, was excluded from the total capital (ibid).

The committee introduced a weighted risk ratio for capital measurement. The risk weights were used to relate capital to “different categories of assets and off-balance sheet exposures” which were “weighted according to broad categories of relative riskiness” (ibid).

The weighted structure contained credit risk, i.e. the risk of failure of counterparty and its extension in the form of country transfer risk. Other risks such as interest rate risk, exchange rate risk, investment risk, and concentration risk were also recognized (ibid).

Basel I introduced organized capital regulation and helped in creating a level playing field among member countries. However, to control the multi-dimensional activities of complex banks having vast operations around the globe, the Basel I regulatory regime was inadequate (Ferguson 2003).

Basel II was introduced in 2004 where the focus of regulation was securitisation (Gluder 2006:254). Three pillars namely the Minimum Capital requirement as Pillar One, Supervisory Review Process as Pillar Two and the Third Pillar of Market Discipline were introduced (Prakash 2008:97). The Minimum Capital requirement calculations take into account the credit risk through standardized approach or/and through internal ratings based approach and also the credit risk for the securitisation framework, as the case may be (ibid:98). The Minimum Capital requirement also discusses operational risk and its weighting and trading book issues reflecting market risk, where applicable (ibid:99). Basel II covers the assessment of almost every sort of risk within the regulatory net, a much broader approach than the Basel I.

Credit risk assessment of the securitisation framework particularly focuses on and all products that have securitisation features (Markus 2006:27). Underlying pool of assets subject to securitisation may contain a variety of products ranging from pure loans and commitments to asset-backed and mortgage-backed securities, corporate bonds as well as equity securities and private equity investments (BIS 2004: Para 542).

On Capital Adequacy requirements, Basel Accord requires from the banks to maintain a minimum level of core equity and supplementary equity which acts as a base and buffer to absorb shocks from their cycle of creating assets out of debt portfolio (Prakash 2008:99-100). The assets created through securitisation are debt-based portfolio and in case of any delay or default in payments due from these asset portfolios cause problems for the bank in paying its obligations to depositors. Where majority of the borrowers default, the 8% core and supplementary equity total cannot sufficiently cover the losses and the central banks have to bail out these banks, as lenders of last resort.

In order to cover the drawbacks of Basel I and Basel II, Basel III was introduced which is a comprehensive set of reform measures, developed by the BCBS, to strengthen the regulation, supervision and risk management of the banking sector (Goyal n.d). Basel III aims to (i) improve the banking sectors ability to absorb shocks arising from financial and economic stress, whatever the source could be; (ii) improve risk management and governance; and (iii) strengthen bank's transparency and disclosures (ibid).

Basel III framework focuses on macro-prudential regulations in order to create a more stable banking sector (ibid). Capital defined under this framework has higher loss-absorbing capacity. Basel III requires from the banks to hold a capital conservation buffer of 2.5% to ensure that banks maintain a cushion of capital that can be used to absorb losses during periods of financial and economic stress (ibid).

A Countercyclical Buffer has been introduced to control the banking activity (ibid). For example it can control an overheated banking activity by increasing the capital requirement and decrease the capital requirement besides encouraging lending to bring the activity back to the normal i.e., to increase banking activity. The buffer will range from 0% to 2.5%, consisting of common equity or other fully loss-absorbing capital (ibid).

Basel III has increased the Minimum Common Equity and Tier 1 capital requirements from 2% to 4.5% of total risk-weighted assets. The overall Tier 1 capital requirement, consisting of not only common equity but also other qualifying financial instruments, will also increase from the current minimum of 4% to 6%. Although the minimum total

capital requirement will remain at the current 8% level, yet the required total capital will increase to 10.5% when combined with the conservation buffer (ibid).

The Basel III has also introduced leverage ratio to serve as a safety net which is the relative amount of capital to total assets (not risk-weighted) (ibid). This aims to put a cap on swelling of leverage in the banking sector on a global basis. 3% leverage ratio of Tier 1 will be tested before a mandatory leverage ratio is introduced in January 2018 (ibid).

Basel III has proposed to introduce a new Liquidity Coverage Ratio and Net Stable Funding Ratio in 2015 and 2018, respectively for better liquidity risk management (ibid).

Basel III requires from the systemically important banks to have loss-absorbing capability beyond the Basel III requirements, as part of the macro-prudential framework. For example measures such as capital surcharges, contingent capital and bail-in-debt (ibid).

Securitising assets can reduce credit and interest rate risk for the institution originating the loans. Hence, securitisation is also a risk management tool. Probably the most important characteristic is that securitisation allows for off-balance sheet financing (Lockwood et. al. 2001). Securitisation alleviates credit constraints of asset originators and places asset exposures with entities that are more willing and able to hold them, such as insurance companies, mutual funds or other institutional investors via off-balance sheet asset sale or synthetic risk transfer. Securitisation can also be viewed in terms of beneficial processes of commoditisation, integration, differentiation, deconstruction of an entity that results in a marketable security.

Securitisation also allows for diversification not only of financing but also of altering portfolios for example of geographical concentrations to be mixed more with those of another area to reduce risk. The impact of having additional revenue through securitisation with fewer assets (as they are removed from the balance sheet) also helps accounting parameters such as Return of Assets and Return on Equity. Hence, the underlying exposure to client balance sheets is also reduced. By shifting assets off-balance sheet, capital constraints can be overcome. Capital can also be conserved. As small and medium size firms find it difficult to obtain new equity at low cost, they are

good candidates to pool resources for securitisation. Further, liquidity constraints can be helped, if for example an institution is 'loaned up', it can securities existing loans or assets and turn their illiquid assets into liquid securities and cash.

Three barriers to securitisation are size, resource and risk (Sinkey Jr. 2001). The cost involved issuing of securities requires smaller sized firms to syndicate their resources towards an issuance. If the structuring has been inappropriate and a true sale is not affected, recourse in the event of defaults may leave investors short-changed. The ability of the investor to assess the quality of the assets within a securitisation is limited. Consequently, the risk of purchasing a 'lemon' or less qualitative asset is a possibility, the quality of the participants may not be well known and there may be for example, reputational risks from being associated with less creditworthy firms.

As capital markets become more complete, the traditional role of financial intermediate is evolving. The evolution of efficient securitisation markets serves to mitigate disparities in the availability and cost of credit in primary lending markets by linking singular credit facilities to the aggregate pricing and valuation discipline of the capital markets. Securitisation can also facilitate the market entry of new finance companies, whose specialisation on assets that are easily securitisable helps break up traditional money markets that have been dominated by a few large players exerting control and limiting the availability of credit.

Table 2.1: Strategic Value Added

| Characteristic of Underlying Asset | Characteristic of Securitized Asset | Beneficiary |
|--|--------------------------------------|---------------------------------------|
| Illiquid | Liquid | Originators, investors, borrowers |
| Valuation lacks continuity and precision | Market values more efficient | Investors, originators |
| Credit analysis and monitoring by lender | Third parties assess risk | Originators, investors, third parties |
| High operating expenses | Lower operating costs | Originators, borrowers |
| Limited rates and terms offered to borrowers | Wider range of rates and terms | Borrowers and originators |
| Local market for investors | National and global investor markets | Investors, Originators, third parties |

Source: Adapted from Sinkey Jr (2001)

Originators benefit particularly from (i) the market-based valuation of securitized assets and the prospect of an enhanced credit rating; (ii) better asset-liability management, as cash flows from securitized assets can be perfectly matched to the repayment of investors until redemption; (iii) the active management of designated asset portfolio; (iv) increased competition of financial institutions in traditional credit markets; and (v) the capacity to create new end products for the consumer. Securitisation helps financial institutions to meet credit demands through the creation of new financial products that disaggregate, customize, repackage and distribute asset risk if suitable hedging instruments are absent. Figure 2.1 provides a summary of the key benefits of securitisation.

Figure 2.1: Key Drivers of Conventional Securitisation Growth

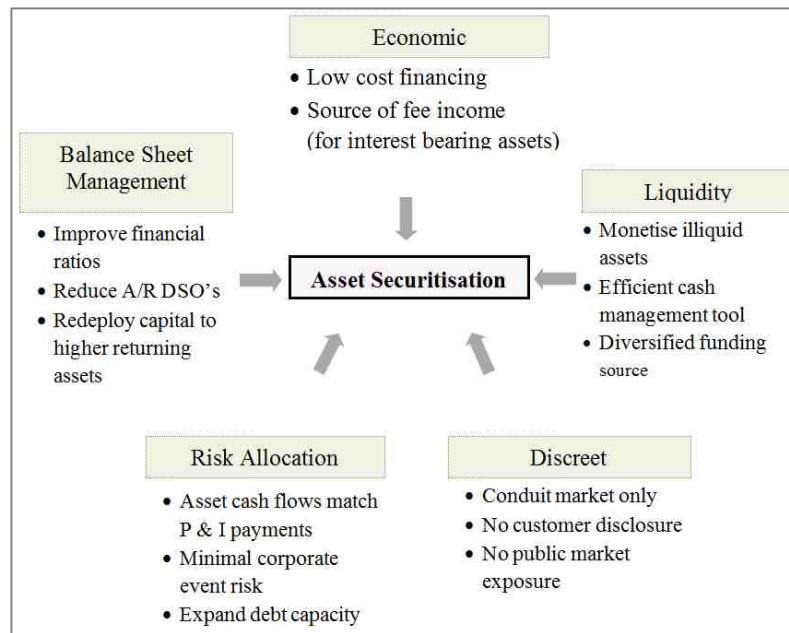

Source: ABN AMRO, 2003

The securitisation process generically follows the process identified in Figure 2.2. There are six main parties involved in the conventional securitisation process: the Originator, the SPV, the underwriter, the guarantor, the rating agencies and the investors. A variety of different institutional categories can initiate or act as originators.

Figure 2.2: The Conventional Securitisation Process

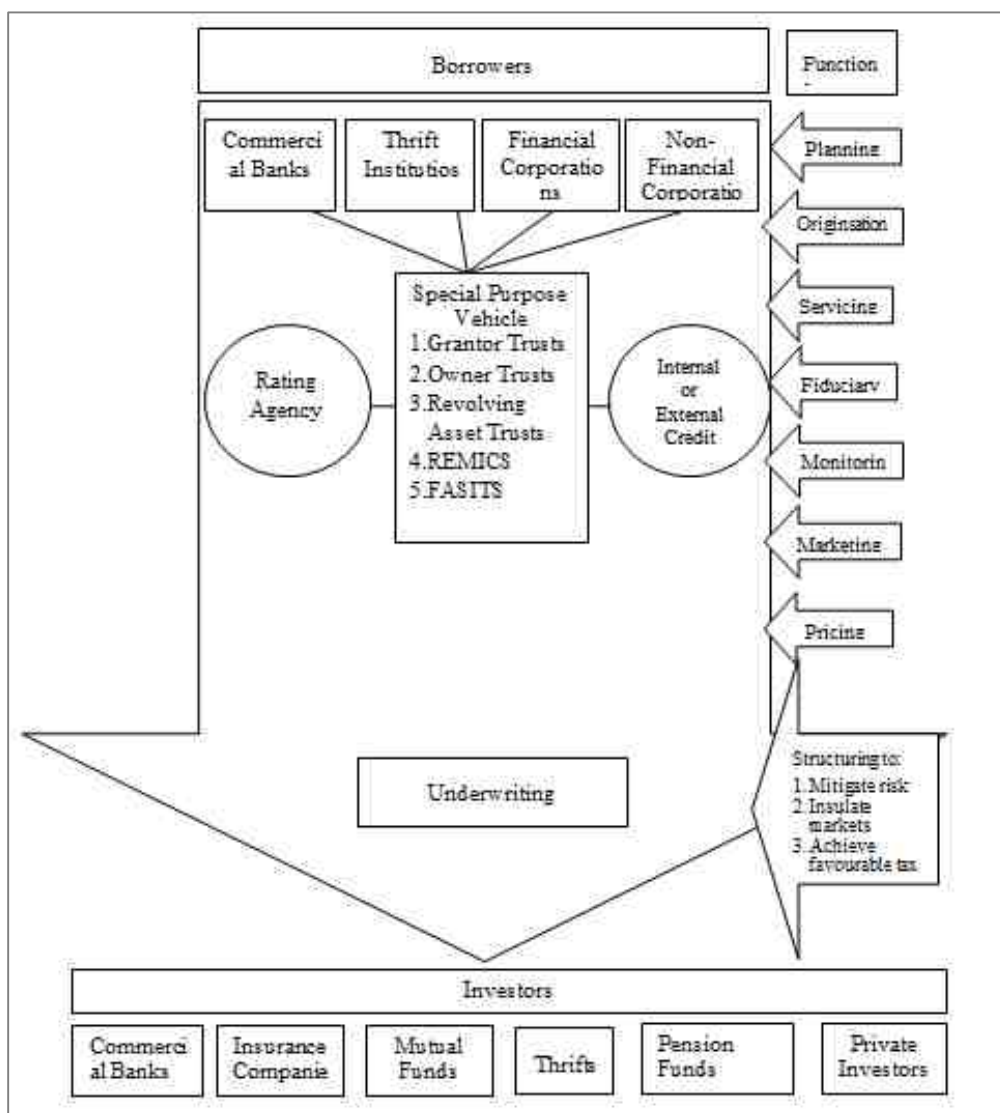

Source: Singer, 2001b

Assets are identified and pooled. Traditional asset classes include mortgage loans, leases, automobile loans and credit card balances. These assets are transferred from the Originator to a SPV (also known as a Special Purpose Entity (SPE) or Special Purpose Company (SPC), which normally takes the form of a trust. The trust depends on the type of assets going into the trust and the purpose of the securitisation. The trust then issues securities that are rated, underwritten and sold to investors. A SPV is the operating mechanism for a securitisation. It should be constructed to receive a favourable tax

treatment also and hence, another reason why a trust structure is used. The trustee has a fiduciary responsibility to the certificate holders (beneficial owners). Its responsibilities will be delineated in the trust agreement.

The transfer of the assets to the SPV from the originator may be as a true sale or as a financing mechanism. When it is a true sale, the SPV has no recourse to the originating institution as it has removed the assets from its balance sheet. Under a financing arrangement, the assets remain on the balance sheet with the SPV having recourse to the assets. It is also important that the SPV is constructed as having 'perfected' interest towards a 'bankruptcy remote' structure where there is a true sale and not just a transfer of assets. The receiver in the event of the originator going bankrupt will not be then able to claim those assets-hence, reducing the risk for investors. The three key legal criteria of rated asset-backed securities involve issues of 'bankruptcy remoteness', 'substantive consolidation' and 'true sale'.

Bankruptcy remoteness is intended to keep the SPV isolated from any bankruptcy proceedings either voluntary or involuntary. The mechanisms taken to minimise this involve minimising the number of potential creditors, requiring other participants to agree not to put the SPV into bankruptcy and making use of for example independent directors to avoid voluntary election of insolvency. The robustness of the transaction to bankruptcy proceedings requires that securitised assets have been absolutely transferred from the originator to the SPV, so that they are detached from the bankruptcy estate. If the transaction involving assets is not a true sale and is either a 'disguised loan' known as a secured transaction then a security interest within the SPV has been created. Hence, there is recourse to the assets of the SPV. Additionally, the originator and SPV are separate entities so that the assets and liabilities of the latter would not be substantively consolidated with the originator in the event of insolvency proceedings (commonly referred to as substantive non-consolidation). A substantive consolidation combines the assets and liabilities of the originator with that of the SPV, negating the benefit of the true sale.

For true sale, important legal conditions are (McMillen 2006): (i) the payment of fair consideration for the assets by the SPV (i.e., the purchaser of assets) to the originator (i.e., the seller); (ii) the SPV bears the risk of loss on the transferred assets; (iii) the SPV has no recourse to the originator for losses on the transferred assets; (iv) the intent of the parties (i.e., do the transferor and the transferee explicitly intend for the transfer to be as sale); (v) the accounting treatment (i.e., does the originator treat the transfer as on or off-balance sheet); (vi) asset control (i.e., does the originator have the obligation or option to repurchase the securitised assets); and (vi) the servicing of the transferred assets (i.e., does the originator continue to act as servicer by collecting debtor repayments on the assets) (Dorris and Potenza 2004).

Factors that are used in the analysis of whether the originator and the SPV should be substantively consolidated include: (i) the degree to which the affairs of the originator are distinguishable from those of the SPV; (ii) the reliance of third parties on assets of the SPV to satisfy obligations of the originator and vice-versa; and (iii) the liability (or guarantee) of the originator to pay the liabilities of the SPV and vice-versa (ibid).

There are a number of common structures used to securities certain assets. A ‘wrapped’ issuance is underwritten and sold within the capital markets (Robbé et al. 2008). A ‘warehouse’ facility is funded by banks (Watson and Carter 2006). In the wrapped term structure, the originator establishes a bankruptcy remote subsidiary or SPV, which acquires a fixed liquidating pool of assets to sell the receivables to a trust. The trust then issues asset-backed notes to an underwriter for resale directly to investors. A monoline insurer issues a guaranty policy – known as a ‘wrap’ – guaranteeing repayment of principal and interest (Robbé 2008). In the warehouse facility, the warehouse acquires receivables from time to time. Rather than selling them to a trust, the warehouse borrows directly from banks to fund its acquisitions (Watson and Carter 2006).

The SPV can issue securities in several basic forms; the most common there are the pass-through security, the pay through and the collateralised obligation (Din 2008; Dualeh 1998; Singer 2001b). With pass-through securitisation, the SPV upon acquiring the assets in a true sale as ‘bankruptcy-remote’ will then utilise the acquired pool of assets to issue

investment bonds (Agarwal 2013). A pass-through payment structure conveys direct ownership of investors in a reference portfolio of off-balance-sheet assets, which are similar in maturity and quality (Jobst 2007). The originator services the portfolio, makes the collections and passes them on, less servicing fee, to investors without reconfiguration of the cash flows (ibid).

Investors will have pro-rata share in the cash flow generated by the securitised assets so that all cash receivables are passed directly by the SPV to the investors (less servicing charges and third party expenses) (Jomo 2010). The advantage is that the original issuer can raise lump sum money while being isolated from any future repayment claims in relation to this transaction (Robbé 2008). Investors' recourse is only to the trustee who assumes a fiduciary responsibility to protect the interest of investors against a fee payable by the issuer, or from the pool of assets (Khan 2008). It is a simpler business structure for the investors. A grantor trust in the USA is most often used for pass-through securitisations as it is passively managed and must not issue multiple classes of securities (Effros 1992). Certificate holders are treated as beneficial owners (Singer 2001a).

In a collateralised (sometimes known as an Asset-Backed Bond (ABB)) securitisation, the pool of assets is not sold to the SPV and the investors will only have a fractional interest in the cash flow generated by the pool of assets (Haan et al. 2009). The assets remain in the originator's balance sheet and are used as collateral for a further debt obligation by the issuer without having to sell the debt assets (ibid.). An ABB is a debt obligation collateralised by a reference portfolio of on-balance-sheet assets of the originator. ABBs are over-collateralised as a form of credit enhancement, i.e., the value of securitised assets exceeds the notional value of issued debt obligations (Jobst 2007). The collateralised obligation also takes a multi-class format where the pool is divided into a number of different creditor classes more commonly known as tranches (ibid). Collateralised bond securitisation makes it possible for example, mortgage companies to raise further capital in order to make further loans without having to wait until the existing receivable debt has been recouped (Kothari 2006). Owner Trusts allow more active management and treats the multiple classes of holders as partners without paying income tax (Singer 2001b).

With the pass-through structure the SPV only stands ready to re-direct collected cash flows of the original pool through securitised bonds to the investors (ibid). The pay-through securitisation is a variant of the pass-through (Kothari 2006). It places an additional obligation to the pass-through structure on the SPV to guarantee a stream of income to bond holders irrespective of collections dates of the original pool of assets. Hence with the pay-through structure, the certificates represent a debt obligation of the SPV rather than ownership of the underlying pool as with pass-through(ibid). In order to avoid possible fluctuations in collection dates and hence smooth out payments to bond holders, the SPV uses guaranteed investment contracts or credit enhancements through third parties. The pool of assets remains within the balance sheet of the originator, but the SPV reconfigures the cash flow to suit payment obligations to various classes of investors, hence combining features of pass-through and collateralised bonds (Kothari 2006).

With collateralised obligations, cash flows can be passively structured (termed the 'waterfall') to have regular predictable returns or administratively managed that is actively managed to provide less predictable yields (Singer 2001b). In the former passive structure, credit enhancements (internal and external), guaranteed by investment-rated third parties, senior subordinated tranches and cash reserves are used to smooth payments (ibid). Active management involves pooling a variety of assets perhaps including those that are more speculative with their cash flow dependent on how they are managed and how the asset value changes overtime (ibid). Revolving asset trust allows assets, which do not have a fixed amortisation schedule to be sold to a trust. It permits active management, pass-through tax protection and multiple asset classes (ibid). A co-operative is a flexible structure used to facilitate the business interests of its members (ibid). Dividends can be deducted tax-free from its revenue although corporation tax has to be paid. Real Estate Mortgage Investment Conduits (REMICs) in the USA is not an SPV but is a tax status applied to a qualified SPV whose assets are mortgages. It provides favourable treatment to investors and is the most common securitisation for multiple class mortgage backed assets (Wiedemer 1977; Deacon 2004). Financial Asset Securitisation Investment Trust is similar to a REMICs but covers other asset classes (Davidson 2003 and Deacon 2004).

Credit enhancement is inherent in the process of creating multiple asset classes and may be further augmented through a variety of internal or external measures (Hsu and Moahebbi 2001). Splitting into several homogenous asset classes allows credit risk to be more effectively predicted (Singer 2001b). A variety of internal credit enhancement measures can be implemented. Some of these include; a senior/subordinated class structure, over collateralisation, excess spread and cash collateral accounts (Johnson 2013).

The tranches of a securitisation will be ordered from the less risky (for example, investment grade) to the more risky with each associated with the claim on the cash flows (Singer 2001b). Tranches may be structured to be interest only or principal only format. A 'Z' tranche operates similar to a zero-coupon bond and accrues interest (at a rate equal to the bonds yield) only on the unpaid principal amount (ibid). A residual tranche may exist to 'clean up' any residual profits from the pools or absorb unexpected losses. Issuers commonly subordinate investor claims into a three-tier transaction structure of junior, mezzanine, and senior tranches, which concentrates expected losses in a small junior tranche ('first loss position') (Jobst 2007). While capital market investors receive the mezzanine and senior tranches as subordinated debt-like notes, the issuer commonly bears most of the asset exposure and shifts most unexpected risk to larger, more senior tranches by retaining the junior tranche as a residual equity-like class to avert ex-ante moral hazard and possible adverse selection (ibid). A senior/subordinated tranche structure allows ownership of senior classes to receive an investment grade rating with subordinated classes more expose to credit risk (Singer 2001b). The lower the class, the more priority is given to it to pay off any losses. Consequently, more yield is demanded from lower rated tranches (Fraser and Simkins 2010). Alternatively, issuers (or servicers) of transactions could set aside some of the cash flow generated by securitised assets to fund a "reserve account" or "first loss pool" as a form of self-insurance (Singer 2001b).

Over collateralisation can occur where an asset pool is sold to the trustee/SPV at a value in excess of the nominal value (Goddard and Marcum 2012). The resulting residual tranche remain (wholly or in part) with the originator to serve as a buffer in defaults (Singer 2001b). An excess spread arises from the yield of the pool exceeding the coupon

(including servicing charges and reserves) and is retained against deficits in expected cash flows. Cash collateral accounts are segregated accounts at initiation to cover deficits. At termination of the SPV, residual amounts will be returned to the original funder of the account (ibid).

External credit enhancement measures involve a third party having sufficient credit standing to support a prospective credit rating (ibid). For a fee, the performance of a certain amount of assets in the pool is guaranteed with the third party absorbing any loss. They could also be a third party letter of credit, insurance (commonly referred to as monoline insurance/wrap) or commonly a corporate guarantee. The rating agencies decide on the creditworthiness of the insurance provider and upon the extent of the guarantee to determine the credit rating of the security (ibid). The disadvantage to this form of credit enhancement is even risky. If the enhancement provider is downgraded then the securities are typically downgraded. Internal credit enhancement do not have this third party event risk as the assets in the pool provide the credit support and investors are at risk only due to the performance of those assets (ibid).

An important aspect of the securitisation process is the servicing activity (Caselli and Gatti 2005). This is frequently profitable for the originator. The servicer monitors the performance of the pool and fulfils reporting obligations for example to rating agencies. Often an approved backup servicer will also need to be specified within the agreement (Procter and Leedham 2004). When a purchaser buys a pool collateral, it needs some assurance that the assets purchased have been fairly represented (Lockwood et al.2001). This assurance is provided by an underwriter. Underwriting is the process of selling securities by an investment bank that purchases the securities and resells them (Mayo 1991:47). The investment bank is compensated by a variety of fees and the spread between buying and selling of the securities (Smart et al. 2004). The investment bank bears the risk for the time-lag between its purchase and sale of the securities. In the USA this function of underwriting was separated from that of commercial banks by the Glass-Steagall Act (The Banking Act of 1933) until it was repealed in 1999.

Table 2.2: Islamic Securitisation Key Characteristics

| Islamic Securitisation Characteristics | |
|---|---|
| 1 | There should be a real purpose behind raising funds via securitisation, and the type of collateral assets realising the securitised revenues must be clearly identified and cannot be consumed. Under Islamic law the transaction must involve the funding or the production of real assets rather than the purchase of financial securities. |
| 2 | Any gains from Islamic fixed-income securities are related to the purpose for which the funding is used. |
| 3 | Each transaction participant should share in both the risk and return; and investor should receive positive pay-off from profitable ventures only. |
| 4 | Collateral assets must not be debt, cash or prohibited as <i>haram</i> and must not be associated in any way with unethical or exploitative operations or with speculation and uncertainty (<i>gharar</i>) from non-productive investment. |
| 5 | The structure should provide investor compensation for business risk from direct participation in securitised assets and should not imply an exchange of debt for interest-generating investment return. |
| 6 | Investors should hold an unconditional/unsecured payment obligation not a guaranteed promissory note. Islamic scholars have allowed the underlying obligor to promise or undertake to buy the assets of a <i>sukuk</i> issuance from the <i>sukuk</i> holders under certain circumstances, typically those that relate to default. The <i>shari'ah</i> perspective is that the promise or undertaking is not contractual in the same way as a guarantee. |
| 7 | A sufficient element of ownership must be conveyed to investors. Any subscriber is considered not only as having a financial right to any revenues but also as an owner of part of the underlying asset. Islamic securitisation must confer upon investors clearly identifiable rights and obligations in securitised assets in order to ensure direct participation in any distribution of risk and reward between lenders and borrowers with limited risk mitigation and (or) indemnification through credit enhancement. |
| 8 | The contribution from investors in the form of proceeds from issued notes cannot be reinvested in short-term cash investments or interest-bearing debt. |
| 9 | The underlying assets and securitised obligations must not be employed for speculative purposes, and turnover should be kept low. |
| 10 | Because conventional insurance violates <i>shari'ah</i> provisions, <i>takaful</i> should be employed instead. |
| 11 | Any form of credit enhancement and (or) liquidity support and limitations of prepayment risk must be in permissible form. |
| 12 | The <i>sukuk</i> holder (investor) incurs all the costs and charges resulting from their ownership of the assets underlying the <i>sukuk</i> whether these are investment costs, basic maintenance costs or simply a decrease in asset value. |
| 13 | In contrast, operational and periodic costs relating to a lease or business operation could be incurred by the beneficiaries of the assets. Ownership taxes are incurred by the <i>sukuk</i> holders, while other taxes are incurred by the assets' beneficiaries. |
| 14 | In addition, none of the investors is allowed to guarantee another investor as an inducement to make the investment. The effect of this is that preference shares and units in the |

| | |
|----|---|
| | traditional sense, if any, are prohibited by the <i>shari'ah</i> since they require that the company or issuer, representing the totality of investors (or shareholders), guarantee the holders of a preference share or unit. |
| 15 | The investors can dismiss the manager with the on-going management or administration contract as opposed to the underwriting and issuance process. |
| 16 | The process is different in conventional securities. In fact, the issuer of conventional securities has the absolute right to dispose of subscription amounts as he wishes, although they remain part of his financial liability. The holders of the securities have no control over the manager's investment activities, they are only concerned with the periodic coupon (regular interest payment) received and the redemption of their proceeds when the issue matures. |

Source: Author's own

2.5 SUKUK AND ISLAMIC SECURITISATION

This section examines the background to *sukuk*, their origins and forms of *sukuk*. This is followed by a critically analysis of the requirements for Islamic securitisation and comparison with conventional securitisation practice.

Securitisation is a popular method of structured finance that is gaining increasing grounds in Islamic finance particularly in relation to *sukuk*. In Arabic terminology, securitisation (*tawreeq*) is known in terms of issues (*taskeek*) and securities (*tasneed*). The word *sakk* (singular of *sukuk*) literally means 'to strike' or 'to hit' as to imprint a seal on a document (Al-Afriqi 1985). The use of *sukuk* can be found acceptable from the narration reported by Abu Hurairah of a saying of the Prophet Muhammad (peace be upon him) warns against taking the *sukuk* of a ruler (in the form of a written debt instrument) because it is related to selling what one does not possess. This did not exclude the selling of *sukuk* with assets in possession or with ownership. A second *hadith* narrated also by Abu Hurairah and again involving Marwan prohibits the selling of *sukuk* before goods are possessed also. This involved trading in effect debt for debt. This was also prohibited as it involved food (consumables), where such an increase or decrease is tantamount to *riba* as per money.

“Cheque” is actually derived from this Medieval Islam term *sakk*. *Sukuk* were extensively used by the Muslim societies of the Middle Ages as papers representing financial obligations originating from trade and other commercial activities. However, the present

structures of *sukuk* are different from the *sukuk* originally used and are akin to the conventional concept of securitisation.

The Fiqh Academy of the OIC in 1988 ruled on the basis of the verse in the Qur'an (2:282) concerning the encouragement of writing up transactions (OIC 1988). They declared under decision number 5 of 1988 that "any collection of assets can be represented in a written note or bond and that this bond or note can be sold at a market price provided that the composition of the group of assets, represented by the security consists of a majority of physical assets and financial rights, with only a minority being cash and interpersonal debts." (IDB 2000:60-63, Resolution 4/5/30).

This ruling was a response by Islamic scholars to reap fruits of a liquid Islamic financial market through a sufficiently wide range of Islamic instruments. The challenge was not only to structure an Islamic bond or certificate, but to also make it 'negotiable' in the sense of being freely bought and sought in the secondary market. For example in the case of a legitimate *murabahah* contract as the subject matter of an Islamic bond, the jurist problem arises that the *murabahah* bond cannot be freely bought and sold without violating the *shari'ah* ruling about the sale of debt. Basically, because the *murabahah* bond underlies a receivable debt from the sale of a commodity, it cannot be traded except at par value. *Sukuk* are an evolutionary stage of the Islamic finance industry.

Sukuk are new innovation in Islamic finance by using which governments raise finance through sovereign issues and companies through corporate issues (Wilson 2004; Anwar 2009). Mokhtar, Rahman, Kamal and Thomas consider *sukuk* as one of the most significant *shari'ah* compliant method for raising finance in the international capital markets (Mokhtar et al. 2009). In the international market, issuers are taking international *sukuk* issuance as an alternative to syndicated financing (Damak et al. 2009). At the same time investors are being benefited from a *shari'ah* compliant investment opportunity through which they can invest in large enterprises (Mohamad et al. 2009).

Figure 2.3: Parties to a Sukuk Transaction

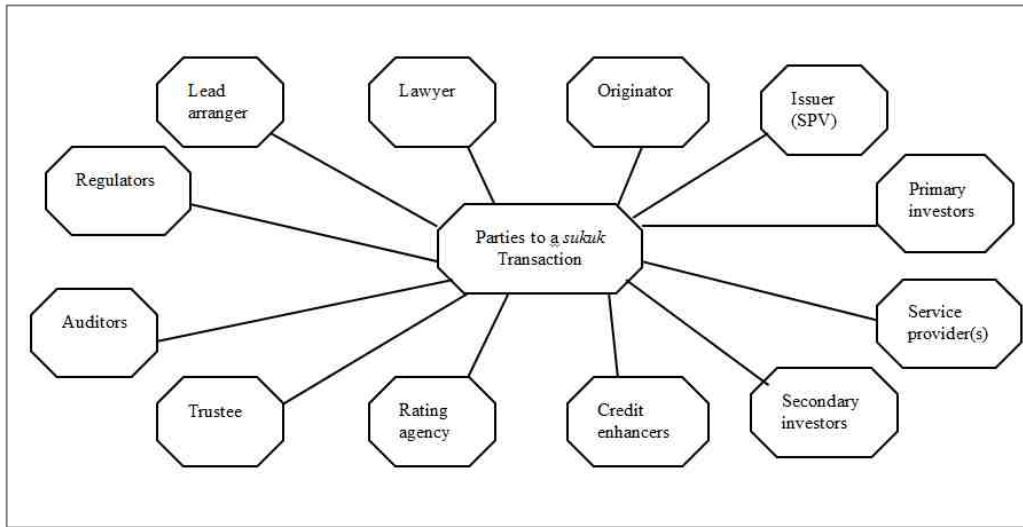

Source: Author's own

Figure 2.3 above presents the possible parties to a *sukuk* transaction. According to AAOIFI (*Shari'ah Investment Sukuk Standard 17*) securitisation “is a process of dividing ownership of pooled tangible assets, usufructs or both into units of equal value and issue securities as per their value” (AAOIFI 2008: Standard 17). Conventionally, it is used primarily as a means of securitising debt, but securitisation is not limited to debt. The Islamic alternative is mostly the securitisation of real capital assets and property leasehold interests. Originators sell existing or future revenues from a portfolio of Islamically acceptable assets to a SPV, which refinances itself by issuing unsecured securities to market investors, who are the capital market corollary to a singular lender in Islamic finance. The investors assume the role of a collective financier. *Sukuk* in itself are a form of securitisation through the underlying asset backing or asset-based mechanism.

Since most Islamic financial products are based on the concept of asset-backing, the economic concept of asset securitisation is particularly amenable to the basic tenets of Islamic finance. Convergence between conventional securitisation and requirements for *sukuk* securitisation has been recognised by Jobst (2007). This has led to the growth in *sukuk* markets. Islamic securitization transforms bilateral risk sharing between borrowers and lenders in Islamic finance into the market-based refinancing of one or more underlying Islamic finance transactions. Islamic securitisation offers generally the same

economic benefits conventional structured finance purports to generate, such as the active management of designated asset portfolio due to greater control over asset status, as well as the isolation of certain assets in order to make them self-financing at a fair market rate.

Islamic securitisation is not a field that can exist in isolation of conventional forces including in the UK. It must adapt to utilise conventional securitisation vehicles without compromising its necessary *shari'ah* principles. It should also look to provide alternative structures as it evolves given its unique characteristics. There are few academic attempts at stipulating the Islamic requirements of securitisation. The majority of these have surprisingly been attempted by conventional experts for example, Jobst (2007) and Wilson (2008) amongst other Muslim commentators on this topic are rare and provide a limited or basic perspective include Ayub (2005) and Thomas (2007). These are critically appraised. Jobst (2007) provides a good attempt in providing a derivation of the principles of Islamic securitisation in relation to conventional securitisation towards a valuation model.

General information regarding *sukuk* structures based on AAOIFI forms above is available with some case studies but these are not substantively in depth (Adam and Thomas 2004). Some effort in this regards on a general basis has been provided by conventional legal firms through their 'Islamic windows' such as Norton Rose and Lovells.

There are as indicated, a few Islamic commentaries on securitisation. One different approach is Iqbal and Khan's (2005) proposal of the 5 'C's towards the financial engineering of Islamic financial products including *sukuk*. This is a principles-led approach that attempts to align the objectives of Islamic economics to that of the securitisation process. The first C refers to compliance with *shari'ah*; so that no condition violates the basic rules of *halal* and *haram* (including *riba* and *gharar*). The second C denotes Consciousness where the companies should agree to mutually trade without being under duress or compulsion-otherwise the contract is not valid. Clarity is the third C, the parties need to be fully informed of the implications of the contract and that there is no substantive *gharar* inherent in the agreement. This is followed by Capability and

ensuring that all parties are able to deliver on their obligations so that for example, there is no *gharar* in relation to not being able to deliver goods that are not in possession. The final C refers to Commitment towards the terms and conditions of the contract without seeking to manipulate its requirements. This set of principles is lacking in depth and the range of activities involved in the financial engineering of *sukuk* transaction lifecycles.

Bespoke Islamic approaches to research methodology are lacking (Asutay 2007). Obaidullah (2005) approaches financial engineering from a conventional perspective. Examination of conventional practices is albeit arguably a necessary first-step in examination of controversial topics such as derivatives, options etc. However, arguably these perspectives appear to be putting Islamic structures into conventional boxes and thereby altering some of the objectives sought by Islamic economics. Often it is argued the inherent properties of the Islamic structures are also altered to force 'fit' into a conventional product. The controversies are identified and critically analysed.

The key success of a securitisation lies in the ability to predict the performance of the underlying pool of assets. This is true for both conventional and Islamic securitisation. However, for the latter there is the requirement of a direct link to assets for the investors. Singer (2001) states that conventional ownership of participations in securitised asset pools issued by special purpose entities is not the same as owning the underlying financial assets. For *sukuk* and Islamic securitisation, securitised asset pools must signify real ownership of investors. This is clearly specified within the *shari'ah* definition of *sukuk*.

Much depends on the nature of the cash flow generated by the pool of receivable assets that needs to be securitised if it is simply debt-tenable to *shari'ah*. Otherwise, if for example, the cash flow represents lease payments generated from a pool of rented property or equipment, it then becomes tenable to *shari'ah*-compliant securitisation.

A temporary use of the assets by the lender in conventional lending is replaced within Islamic finance by a permanent transfer of funds to the borrower as a source of indebtedness. Retained asset ownership constitutes entrepreneurial investment and direct participation. Consequently, the concept of asset-backing is particularly amenable to

sukuk. Islamic securitisation transforms bilateral risk sharing of the Islamic modes of finance with market-based refinancing. Hence, Islamic securitisation is characterised by conversion of uncertain business-related proceeds of direct investment in religiously sanctioned real economic activity. The participants share in both the risk and the return through direct participation. They hold unsecured payment obligations and not guaranteed promissory notes.

This is known as *sukuk al-ijarah* where asset is transferred from the originator to the SPV and those assets are then leased to the originator. Upon maturity, the assets are resold to originator by SPV. However, in other structures of *sukuk al-salam*, *sukuk al-istisna'* and *sukuk al-murabahah*, transfer of assets between the originator and SPV does not take place but different mechanism works. The stages of conventional securitisation are subject to religious scrutiny for the purposes of Islamic securitisation. Consequently, there is a *shari'ah* lifecycle of *sukuk* governing the *sukuk* transaction lifecycle. Originators sell Islamically acceptable assets to an unaffiliated SPV (alternatively the asset originators can issue notes themselves). The assets have to be clearly specified and cannot be consumables. The assets may be existing assets or future assets as contained within *shari'ah* Investment *Sukuk* Standard 17 and other accompanying *shari'ah* standards. Similarly any collateral assets cannot be debt, or cash. Assets, activities and contracts cannot be unethical or associated with speculation or *gharar* (uncertainty). These assets would be for example the forms of *sukuk* as specified by AAOIFI whose basis is the traditional Islamic finance products. The SPV issues unsecured securities to market investors (who in effect act as collective financiers). The *sukuk* certificate holders are pro-rata owners of the SPV. The investment is not guaranteed nor interest based and complies with the other relevant stipulations of Islamic finance. Returns are based upon the performance of the underlying assets and only from profitable ventures. Each participant is *pari-passu* ranked; there is no preference or tranches in line with the Islamic objectives of equality.

The gains from instruments have to be related to the purpose for which the funding is used. The purpose of the funding has to be for the production of the real assets rather than the purchase of financial securities, which would be akin to lending for example for

derivatives (Dualeh 1998). Any associated financing or surpluses must also be invested in Islamically acceptable instruments. Any credit enhancement, liquidity support, underwriting, servicing and insurance must be in permissible forms.

In the current experience of Islamic securitisation it has been possible to adopt various versions of securitisations subject to specific *shari'ah* provisions. The conventional pass-through structure (equity-based) involves transferring a level of ownership to the certificate holders is the closest traditional securitisation process to Islamic principles (Jobst 2007; Din, 2008). A true sale satisfies in this context, exclusive dedicated cash flow from the underlying asset to the owner, irrevocable but unsecured repayment from the assets and a transaction structure that does not involve interest. Conveyance of legal title in pass-through and ownership attributes are critical discussion points from a legal and *shari'ah* perspective. These are often complicated further in domiciles where there are restrictions on foreign ownership. Pay-through bonds involving collateralisation and interest payments are dedicated but not suitable securities.

Shari'ah Investment standard No.17 on *sukuk* also specifies rules and guidance for issuance and securitisation. In respect of the prospectus towards issuance of *sukuk*; it must not include a statement by the issuer to compensate the certificate owner up to the nominal value of the certificate except for in tort and negligence. It is permissible for the issuer to purchase at market value after the issuance. Income from securities must be related to the purpose for which funding was obtained. The prospectus is considered as an offer and the subscription as an acceptance. This is on the basis that valid contracts can take place upon indication of consent without specifying a particular form of expression.

The issuer is also allowed to guarantee a fixed percentage of profit. However, an independent third party can guarantee free of charge this (in line with AAOIFI *Shari'ah* Standard (No. 5) on Guarantees). The *sukuk* standard permits the use of an underwriter based on a binding promise. The underwriter should not receive any commission in lieu of this underwriting. *Sukuk* can be issued for fixed-term periods or without specifying a period (dependent on the nature of the contract.) a profit equalisation reserve is permitted

or *takaful* (Islamic insurance) donations arising from the incomes of the *sukuk* shares or through donations by the holders.

The conventional securitisation process involves the functions of asset selection, originator sale to SPV, SPV issues to investor. These assets are credit enhanced, rated with liquidity provisions. The stakeholders within this process from the examination conducted are identified as; the originators, SPV, investors, rating agencies, underwriters, credit enhancement providers, guarantors and liquidity enhancement providers with appropriate legal support. The issue of *sukuk* also includes many preliminary steps, usually called 'regulating the issue' or 'arranging the issue'. However, for Islamic securitisation there are additional stakeholders for example, there are *shari'ah* boards that must be involved in the process.

The *shari'ah* boards which not only approves the product but for IFIs are an integral part of their operations. This is true irrespective of the dominions the IFIs reside. This is an issue of debate within conventional regulator authorities that is currently to be developed further, particularly in the UK. A *shari'ah* board is comprised of at least three or more scholars versed in Islamic jurisprudence particularly with a focus on financial transactions. This might be directly employed within the structure of an organisation or sourced externally (given the scarcity of appropriately qualified scholars skilled in the English language amongst other requirements). It is important that the board is independent of the originator in the fulfilment of its duties of all including the investors. The actual role of the board varies dependent on transaction but in additions to transaction approvals, *shari'ah* audit reviews, segregating of conventional funds, preparation of offer documentation and contractual development require to be conducted on an on-going basis.

Some argue that *sukuk* are not Islamic bonds rather these are Islamic investment certificates. This is because unlike bond, in *sukuk* the *sukuk*-holders own an undivided beneficial ownership in the underlying assets (Ali 2009; Schoon 2009b). This makes them entitled to share in the profits of the business concern (Moody's 2008).

In the conventional capital market, there are two instruments which are used to raise money namely (i) bonds and (ii) shares. With bonds, bonds holders are promised with fixed interest return and principal amount is also guaranteed. This makes bonds un-Islamic for the reason it involves *riba* therefore these are regarded as non-*shari'ah* compliant (Mokhtar 2010; Mokhtar and Abdullah 2010). Further, any return to the bondholder is actually a percentage amount of the capital and not of the profit. As mentioned above at the time of maturity of bond the principal is guaranteed regardless of any profit of the enterprise. While using *sukuk* or the usage of *wa'ad* in *sukuk*, one must concentrate on the fact that whether or not the characteristics of bonds are present in equity-based *sukuk* (Usmani 2008). *Sukuk* are not based on interest neither are they entirely equity-like. *Sukuk* although can be structured to be 'fixed' payment instruments by their nature more akin to variable payments such as floating rate notes. Indeed *sukuk*-holders may have to pay asset-related expenses dependent on the underlying structure. In contrast with bonds, this would not occur. The issuance, trading (sale and purchase) and endorsement of conventional interest-linked bonds is prohibited (AAOIFI *Shari'ah* Standard No. 21-Financial Paper, Shares and Bonds).

The *shari'ah* objection is obvious with coupon bonds where interest rate payments are promised in addition to the face value at maturity. But this is also true of zero-coupon bonds as they are issued at discount rates means in the sense of holders paying less money today for more money tomorrow, and this is the prohibited interest rate lending. Nonetheless, an Islamic *sakk* can be so structured as to yield predictable cash flows, as in the case of *ijarah*-based bonds, but no legitimate Islamic bond can guarantee payment of pre-determined amounts at maturity in addition to other stream of payments. The only situation where an Islamic bond can guarantee payment of par value to holder is the *qard-e-hasan* (benevolent) bond which ought to be issued at par as well as retired at par.

Thus, Islamic bond used as a description for *sukuk* is a misnomer. Indeed many attempts to categorise *sukuk* within this restrictive box. The plain vanilla *sukuk al-ijarah* is often structured in this manner to have interface parameters for capital markets similar to a bond.

Sukuk may have features of a debt instruments but it cannot rely on or involve interest such as *murabahah*. Ownership is not transferred to the bond-holder in the business concern rather he is technically a lender of the business concern. *Sukuk* represent ownership stakes in real assets or services. *Sukuk* are based on legitimate *shari'ah* nominated Islamic financial instruments. *Sukuk* sales are sales of shares of an asset. Bond sales are the sale of a debt. Bonds also represent pure debt obligations due from the issuer to the investor or holder. Bonds may be issued for any purpose that is legal. However, *shari'ah* based *sukuk* would be only appropriate for Islamically acceptable activities.

Sukuk prices are market driven and derived from the underlying performance of the assets. Bondholders do not have knowledge of, nor do they have a direct performance link to the underlying assets of the bond. The creditworthiness of the issuer is of paramount importance so that in the event of default, the assets can be seized. Bonds however, may be related to possible Islamically acceptable underlying assets such as asset-backed properties (similar to that possible for *sukuk*). Figure 2.4 below elaborate different bond types.

Figure 2.4: Types of Bonds

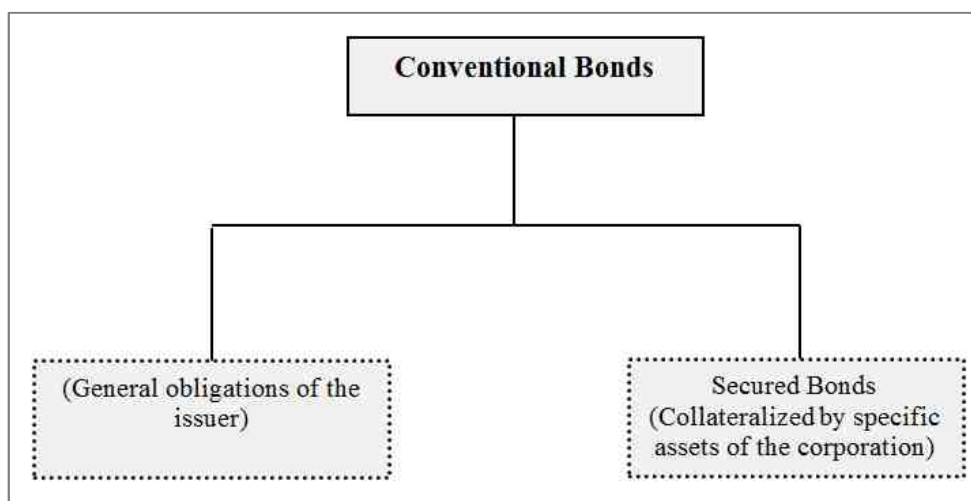

Source: Authour's own

Adams and Thomas state several similarities between *sukuk* and bonds (Adam and Thomas 2004). They are both marketable commodities that can be traded. *Sukuk* can also

be rated by recognised rating agencies a crucial factor towards their wider acceptance. The versatility of *sukuk* arising from the variety of structures makes them compatible with global bond regulations such as International Organisation of Securities Commission (IOSCO) Regulations S. *Sukuk* have characteristics simultaneously closely aligned with those bonds and of shares.

Table 2.3: Comparisons Between Sukuk and Bonds

| Parameter | <i>Sukuk</i> | Bond |
|------------------------|--|---|
| Nature | Not a debt of issuer but undivided ownership in specific well-defined assets, projects and/or services. | Debt obligation of issuer. |
| Contract | Underlying contract is permissible. | Contract is purely a loan of money to earn interest. |
| Tenure | Fixed for most cases but can also be unspecified. | Fixed |
| Assets | Underlying assets must be Islamically acceptable | Can be issued for any legal purpose |
| Asset-backed | A minimum of 51 per cent tangible assets (or their contracts are required to back issuance of <i>sukuk al-ijarah</i>). (Tag El-din, (2008) references 30% as the minimum required.) | Generally not required |
| Asset related expenses | May be attached to <i>sukuk</i> holders | Not concerned with asset expenses |
| Claims | Ownership claims on the specific underlying assets, projects, services. | Creditors claim on the borrowing entity and in some cases liens on assets. It is purely the financial debt of the issuer. |
| Security | Secured by ownership rights in the underlying assets or projects in addition to any collateral enhancements structured. | Generally unsecured debentures except in cases such as first mortgage bonds, equipment trust certificates and so on. |
| Principal and return | Not guaranteed by issuer. | Guaranteed by issuer. |
| Purpose | Must be issued for Islamically permissible (<i>halal</i>) purposes. | Can be issued for any purpose. |
| Trading of security | Sale of an ownership interest in a specific asset/project/service, etc. | Sale of a debt instrument. |
| Value | <i>Sukuk</i> pricing depend on market value of underlying asset in addition to obligor's creditworthiness. | Dependent wholly on credit-rating or creditworthiness of issuer. |

| | | |
|---------------------------|--|--|
| Responsibility of holders | Responsibility for defined duties relating to the underlying assets/projects/transaction limited to the extent of participation in the issue. | Bondholders have no responsibility for the circumstances of the issuer. |
| Issuer | A <i>sukuk</i> issuer shall be engaged in <i>shari'ah</i> -compliant business activities | An issuer of conventional bonds is not limited in its business activities. |
| Investor base | Enjoys a wider investor base from both Islamic and conventional investors. | Conventional bonds can only tap the conventional investors. |
| Contractual relationship | The subject of the contract in <i>sukuk</i> is a contract based on lease or a defined business undertaking between the <i>sukuk</i> -holders and the originator. | Bonds basically create a Lender/Borrower relationship i.e., a contract whose subject is purely earning money on money (<i>Riba</i> -Usury). |
| Assets | The underlying <i>sukuk</i> assets, business or project must be of a nature that their halal (permissible) use is possible. | Such a condition does not apply under bonds. |
| Administrative cost | Additional fees in terms of legal and <i>shari'ah</i> advisory fee. | No additional administrative costs associated with conventional bond issues. |
| Financing cost | A larger pool of <i>sukuk</i> investors creates more demand, hence may help to achieve slightly more competitive pricing. | A comparatively smaller pool of conventional bond investors suggests that there is less demand for the paper. |

Source: Securities Commission Malaysia (2009)

Table 2.4 provides differences between *sukuk* and shares.

Table 2.4: Comparisons between Sukuk and Shares

| Parameters | <i>Sukuk</i> | Shares |
|--------------|---|-------------------------------------|
| Nature | Not a debt of issuer but undivided ownership in specific well-defined assets, projects and/or services. | Ownership share in a corporation. |
| Contract | Underlying contract is permissible. | Can be permissible or not. |
| Tenure | Fixed for most cases but can also be unspecified. | Permanent – unless company is sold. |
| Assets | Underlying assets must be Islamically acceptable | Can be issued for any legal purpose |
| Asset-backed | A minimum of 51 per cent tangible assets (or their contracts are required to back issuance of <i>sukuk al-ijarah</i>). | Not required |

| | | |
|---------------------------|---|--|
| | (Tag El-din, (2008) references 30% as the minimum required.) | |
| Asset related expenses | May be attached to sukuk holders | Operational matter, not directly associated with share. |
| Claims | Ownership claims on the specific underlying assets, projects, services. | Ownership claims on the company. |
| Security | Secured by ownership rights in the underlying assets or projects in addition to any collateral enhancements structured. | Unsecured |
| Principal and return | Not guaranteed by issuer. | Not guaranteed by company. |
| Purpose | Must be issued for Islamically permissible (<i>halal</i>) purposes. | Can be offered for any purpose. For Islamically permissible (<i>halal</i>) purposes. This is subject to applying appropriate Islamic screening and filtering criteria. |
| Trading of security | Sale of an ownership interest in a specific asset/project/service, etc. | Sale of shares in a company. |
| Value | <i>Sukuk</i> pricing depend on market value of underlying asset in addition to obligor's creditworthiness. | Not necessarily dependent on business performance. |
| Responsibility of holders | Responsibility for defined duties relating to the underlying assets/projects/transaction limited to the extent of participation in the issue. | Responsibility for the affairs of the company limited to the extent of holding in the company. |

Source: Information collected from different sources by the Author

2.6 SHARI'AH FRAMEWORK

The role and discussion of *sukuk* must emanate from *shari'ah* stipulations. The statutory Islamic requirements and associated moral legitimacy of *sukuk* as a financial instrument provide the basis for its structuring and issuance (Adam and Thomas 2004). This includes the *shari'ah* framework upon which Islamic economics (Asutay 2007) and hence, Islamic finance is based. There has to be *shari'ah* legitimacy for the entire *sukuk* transaction lifecycle from structuring through to its operations and trading as well as its impact in society. Ideologically, *sukuk* is intended to be a moral tool as Islamic Finance ought to be. *sukuk* are a means for the equitable distribution of wealth allowing investors to benefit from true profits on a pro-rata basis and preventing concentration of wealth (Usmani 2008). The role of *sukuk* instrumentation within this context has been neglected by most

commentators. It is necessary to avoid a universe of Islamic financial products that are in effect mirror images of conventional systems. An epistemology of Islamic Finance in addition to being aligned with Islamic Economics from the perspective of an Islamic Research Methodology is perhaps called for as an additional avenue for developing *sukuk*. Additional issues will be identified where relevant in subsequent sections.

In consideration of the impact of *sukuk*, it is necessary to examine further, the why of *sukuk*. The drivers for *sukuk* and their success are extensive and shall be elaborated upon in detail by the research. Prior to *sukuk*, in contemporary times there were few tools available for Islamic institutions to compete and develop against conventional banks in a *shari'ah* acceptable manner. *Sukuk* appeal to the entire range of capital market institutions (and beyond), be they Muslim or not for a variety of reasons. Their flexible structure allows them to meet short-term and long-term investor objectives. They are attractive to governments as tools of development allowing capital to be raised and mobilised in primary markets and through trading in secondary markets. At a corporate or Islamic financial institutional level, *sukuk* help to raise project finance or manage risk and liquidity aspects for both cash-strapped and asset-rich institutions. Borrowing is now also possible through *sukuk* as an alternative to conventional debt-financing through prohibited interest or *riba* (Adam and Thomas 2004). They are viewed as cost-effective risk management tools transforming asset and risk/return profiles that also replicate the benefits of securitisation.

Usmani (2008) argues that *sukuk* are among the best ways of financing large enterprises that are beyond the ability of a single party to finance. *Sukuk* provide an ideal means for investors seeking to deploy streams of capital and who require, at the same time, the ability to liquidate their positions with ease whenever the need should arise. Additionally, *sukuk* represent an excellent way of managing liquidity for banks and IFIs. When these are in need of disposing of excess liquidity they may purchase *sukuk*; and when they are in need of liquidity, they may sell their *sukuk* into the secondary market.

2.7 HIGHER OBJECTIVES OF ISLAMIC FINANCE

Conventional and mainstream approaches to Islamic finance are preoccupied it seems by regarding it as a process of synthesising close equivalents to products in conventional finance (Jobst 2007). Many do not consider the fulfilment of the aims and objectives of Islamic economics in their treatises and hence accusations of Islamic finance as a purely profit motivated process arise (El-Gamal 2006a and Asutay 2007). Even although there may well be overlap of substance between Islamic finance and their conventional equivalents, they differ in legal form requiring different valuation techniques and treatment.

The objectives of Islamic economics are to be aligned with those of the *shari'ah* as set out by Al-Ghazali; as acting to protect five necessities (*al-dharurat al-khams*): religion, life, reason (mind), progeny, and property. Al-Shatibi set out in his *al-muwafaqat* an elaborate set of postulates and propositions to clearly explain the underlying wisdom of *shari'ah* as a perpetual vehicle of utility (*maslahah*) generation and disutility (*mafsadah*) aversion. The concept of *istislah* also includes the concept of protecting people from harm. Asutay (2007) incorporates the views of Naqvi (1994) in setting out the fundamental axioms of Islam including those of the *shari'ah*.

Islam seeks to bring about justice and fairness. Islamic economics is one avenue for this and is concerned with bringing *falah* or well-being for the whole of mankind amongst other factors. The concepts of economics as denoted by Muslim economists are broader than those in conventional economics (Ahmed 1992; Chapra 1992). The concept of *istislah* also includes the concept of protecting people from harm. However, it should be noted that contemporary conceptualisation of Islamic economics is a nascent field (Ashker and Wilson 2006).

The embodiment of moral values or policy to address such behavioural concerns within economic and financial activities both as a driver for growth and as an outcome of such success cannot be understood (El-Din 2008). Moral policy as an issue has been raised also in conventional economics (Sen 1985). The questioning of, and extent to which, morality should play a part in conventional economics is a separate debate (Smith 1776).

Islamic finance is intended as a process to establish the objectives of another process that is Islamic Economics (Ahmed and Awan, 1992). Hence, the objectives of Islamic Finance activity are aligned to those of Islamic Economics. It is suggested that these are disregarded within the profession that is essentially profit-motivated (El-Gamal 2006a; Asutay 2007). Consequently, the aims of Islamic economics as those set out by Asutay (2007) amongst a few lone voices, are arguably not being achieved through the current Islamic Finance activity. However, it should be noted that contemporary conceptualisation of Islamic Economics is a nascent field (Ashker and Wilson 2006).

Hence, many sovereign transactions are more guaranteed obligations than non-recourse, secured obligations of more conventional transactions. Although these transactions were linked to underlying assets, investors were mainly enticed by buying sovereign credit quality and appeared to have paid little heed to the actual source of servicing and underlying asset exposure. This has been reflected events like *sukuk* summits at London and Saudi Basic Industries Corporation (SABIC) chairman cited that ‘investors will look at the economics first before the religious issues’.

Ayub, in a rare academic critique from an Islamic perspective highlights some of these issues in relation to *sukuk* (Ayub 2005). He questions at a macroeconomic level the long term effects on integrity of the Islamic financial system as return rates on most of the *sukuk* are conclusively pre-agreed even without any provision for the third party guarantee. The returns of most *sukuk* are absolutely fixed or unmodified. There is no risk-sharing or event accounting of expenses as within certain *ijarah* issuances. This aspect encompasses systemic risk of non-*shari‘ah* compliance which nullifies the very basis of the Islamic financial system and contravenes the investors’ aspiration based on their belief.

Islamic finance should bring about change and was visualised as a means for correcting the imbalances caused by working of the conventional interest-based system which is considered to cause inequality both in developing as also developed countries. Islamic financial structure has to be developed with the objectives of achieving balanced growth of financial and real sectors to achieve the socio-economic objectives of development

with broad-based distribution of income. Ayub claims that mechanisms used in *sukuk* today, however, strike at the foundations of these objectives and render the *sukuk* exactly the same as conventional bonds in terms of their economic results (Ayub 2005). IFIs maintain the status quo of the conventional, *riba*-based market and have now begun competing with all the same characteristics of the conventional, interest-based marketplace, rather than open up sectors guided by social justice. Further the quality of a product from a *shari'ah* perspective depends upon the sharing of risk and the equitable distribution of profits between investors and should not be aligned to the requirements of international ratings agencies that are not necessarily Islamically oriented.

According to El-Gamal (2004), the real question is whether “Islamic principles” should continue to be judged purely on juristic grounds for Islamic finance. He argues that the Islamic finance industry’s emphasis on the forms of financial transactions rather than their substance, may result in Islamic financial practices violating the spirit of Islamic Law. Focus on form rather than function flies in the face of a famous Islamic juristic dictum: “What matters in contracts is substance and not wording and form” (Ibn Qayyim, 1968). According to El-Gamal (2004), this *shari'ah* arbitrage-based Islamic finance threatens to cause religious harm, by subverting Islamic Law and exposing the industry to abuse and scandal. El-Gamal (2004) provides a different perspective on Islamic finance in practice that has relevance to current *shari'ah* controversies over *sukuk*.

Arbitrage opportunities occur when discrepancies exist between prices of the same product in different markets or within the same market and is not being traded at its ‘fair’ value allowing exploitation. Regulatory arbitrage, wherein the arbitrageur attempts to generate a profit based on certain financial practices being disallowed for example, within the legal system of one country or but allowed in *shari'ah* arbitrage is a particular form of regulatory arbitrage with dual characterisation of a Financial dealing, one for jurists and one for regulators (El-Gamal 2004:3-4). A captive market of pious Muslims voluntarily choose not to use certain financial products. Lawyers, in partnership with bankers and jurists, strive to provide them a re-engineered version of those products. Indeed, by approving and eventually codifying (through AAOIFI, IFSB, OIC Fiqh Academy, etc.) legal stratagems to replicate conventional financial practices, jurists and bankers

eventually drown the substance of Islamic law and classical jurisprudence. For the *sukuk* industry there is a need for a more principles-based approach rather than rules-based approach to *shari'ah* compliance. The profit motive of *shari'ah* arbitrage drives the movement towards conventional financial practice, and thus away from strict adherence to Islamic principles.

Shari'ah arbitrage also relies to the addition of one or more degrees of separation between Islamic finance clients and the underlying conventional financial product (El-Gamal 2004). This is a mechanism underlying many of the jurist stratagems (*hiyal*) for circumventing prohibitions to make impermissible transaction permissible used in *bay' al-'inah* and *bay' al-dayn* and *tawarruq*. By continuously adding breaking down transactions into a level that are permissible at an individual basis, collectively the same objective as conventional finance is achieved. El-Gamal (2004) contends that an SPV is a degree of separation used for issuances of *sukuk*. He argues that *sukuk al-ijarah* issuances by governments and corporations have recently opted for a variation on *'inah*, which also incorporates lease-financing in a manner similar to leveraged buyout methodologies of conventional finance. He also considers the use of London Interbank Offered Rate (LIBOR) as a benchmark is also a 'bending of the rules' and a form of arbitrage (ibid).

Perhaps a better example would be that of *sukuk* issues of Malaysia which are mostly based on the concepts of *bay' al-'inah* of underlying asset and the concept of *tabarru'* while their trading in secondary market took place through *bay' al-dayn* using the label (*bay' bithaman 'ajil*). Malaysian Islamic bonds based on *bay'al-'inah* and *bay' al-dayn* principles are not acceptable to mainstream juristic opinion and majority of *shari'ah* experts. According to a research study undertaken by Rosly and Sanusi (1999), there is no significant *shari'ah* justification of *bay' al-'inah* for issuance of *sukuk*. Similarly, trading of *sukuk* at a discount using *bay' al-dayn* has been found unacceptable by the majority of scholars including Shaafi'i (commonly cited as providing permissibility).

Chowdhury (2008) uses the example of *tawarruq*, which is used to generate cash on a deferred payment obligation. The underlying commodity is never intended for use. Each of the individual component transactions is legitimate and validly executed. However,

shari'ah engineering has achieved the same objective of a prohibited *riba* transaction that would have not used any underlying goods. *Tawarruq* is permitted in certain instances but it is not desirable.

Chowdhury (2008) criticises the changing of nature of profit and loss equity-type transactions that have been through *shari'ah* engineering adopted debt-type characteristics. This refers to for example the use of *musharakah sukuk* structures having similar characteristics to bonds without the interest.

El-Gamal's (2004 and 2006a) questioning the actions of scholars within Islamic finance is rare and to be heralded. Usmani (2007 and 2008) who himself is not above question by El-Gamal (2004) also criticises the matter in a more traditional manner. The 'corporate' governance of those responsibilities for the 'corporate governance' of Islamic finance that is the *shari'ah* scholars is a critical element that is neglected. Usmani (2008) states the example of *shari'ah* arbitrage where certain contemporary scholars have attempted to justify a capital guarantee by saying that while it may be prohibited in a partnership of contract, (*shirkah al-'aqd*), it is not prohibited in a partnership of property, (*shirkah al-milk*). When the purpose of a partnership is investment or earning, regardless of whether that is to take place by means of commerce, or by means of leasing, the partnership will be a partnership of contract. As the purpose of *sukuk* is investment or earning by means of leasing assets, it is impossible to call *sukuk* a partnership of property. Therefore, it is not lawful for one partner to guarantee the capital of another partner either directly or indirectly. This is because the purpose of the partnership in *sukuk* is not merely to own physical assets for the purpose of consumption or personal benefit (as in a partnership of property) but for the purpose of joint investment.

In the AAOIFI (2008) *fatwa*, it calls for *Shari'ah* Supervisory Boards (SSB) to abide by the *Shari'ah* Standards issued by the *Shari'ah* Council. It also calls for a more operational role of the SSBs who must not consider their responsibility to be over when they issue a *fatwa* on the structure of *sukuk* that must involve reviewing all contracts and documentation related to the actual transaction,. Further the *fatwa* argues that they must actively oversee the ways that these are implemented in order to be certain that the

operation complies at every stage with *shari'ah*. IFIs are also encouraged to increase their operations based on true partnerships and the sharing of risk and reward and thereby achieve the higher purposes of the *shari'ah* (Usmani 2008).

A *shari'ah* scholar seeking to rule on the compliance with the *shari'ah* would not look to the manner in which the product is classified or described from a secular or conventional, i.e., non-Islamic point of view. For the *shari'ah* scholar, conventional labels or descriptions are likely to be viewed as irrelevant.

However, there are certain errors contained with Jobst's basic understanding of Islamic finance (Jobst 2007). This includes for example his definition of *mudarabah* where a *mudarib* may repay the original amount invested 'or borrowed' from the *rabb al-mal* (investor) and also his assumption that *salam* finance (which is an exception to the general rules of Islamic finance) lies within the remit of *murabahah* finance (ibid). This is not so; *salam* is an exception to the standard role of financing that apply to *murabahah* sale agreements. Jomadar (2007) also cites the latter. These issues of misunderstanding although may appear trivial are found in many conventional approaches.

Jomadar (2007) criticises Ibn Khaldun as not giving rise to an independent discipline of economics. Many conventional Muslim and non-Muslim commentators would disagree. Further, he regards Islamic economics as a response to contemporary grievances of the Muslim as well as due to ideological allegiances of an imagined harmonious paradigm that is willing to increasingly accept economic realities. He seems also suggests that the buy and hold positions of Islamic banks are as consequence of Islamic law. This is more due to the shortage of acceptable liquid instruments.

2.8 SUKUK STRUCTURES

Most references states that there are 14 categories of *sukuk* specified within the Investment *Sukuk* Standard No. 17 (2003). Investment *Sukuk* Standard No. 17 when specifying the details of the various *sukuk* categories also references out to other AAOIFI standards. It is further complemented by a forma 2008 ruling from AAOIFI and comments by Usmani in 2007. These are to be discussed later. Possible *sukuk* structures

are given in Figure 2.5 and the *sukuk* structures issued so far are given in Figure 2.6 below.

Figure 2.5: Possible Sukuk Issues under AAOIF Standards

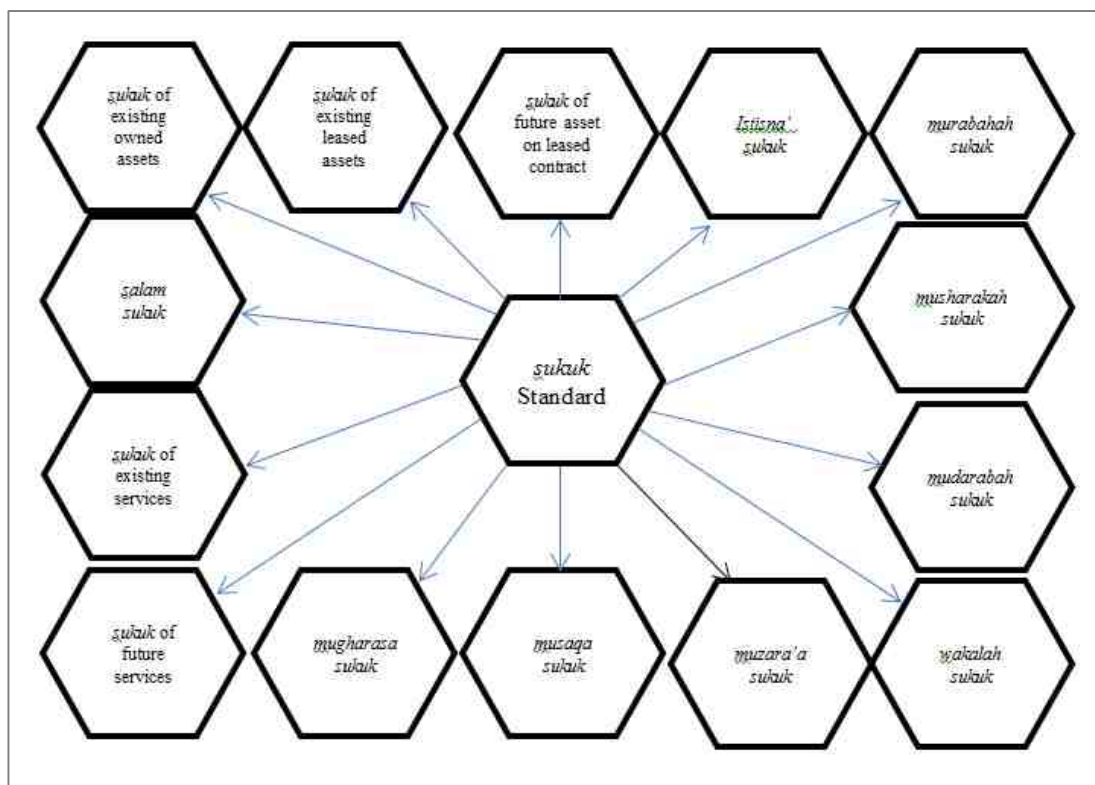

Source: Author's own

Figure 2.6: The Evolution of Sukuk Structures in the GCC

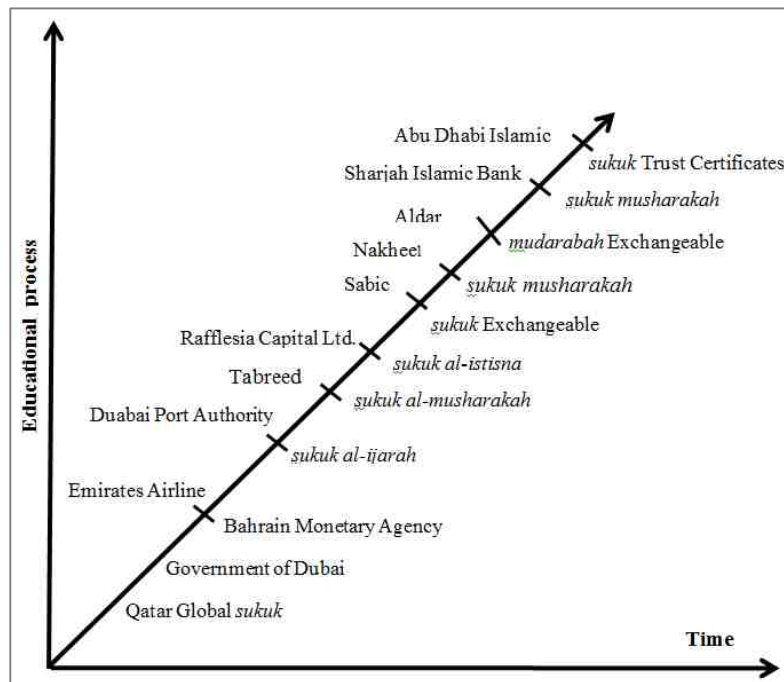

Source: CIMB Islamic Fixed Income Sukuk Research (2007)

Other forms of certification for Islamic financial instruments do exist based upon the OIC ruling of 1988 (IDB 2000:60-63). These are primarily certifications of the Islamic modes of finance directly without the involvement of securitisation. They are also in many instances being replaced by the predominance of *sukuk* forms, which through the securitisation process are more marketable, enhanceable and versatile. *Sukuk* are tradable *shari'ah* compliant capital market liquid instruments providing medium to long-term fixed or variable rates of return. They have also been used as short-term instruments. Regular periodic income streams during the investment period with easy and efficient settlement and a possibility of capital appreciation of the *sukuk*. *Sukuk* can be assessed and rated by international rating agencies, which investors use as a guideline to assess risk/return parameters of a *sukuk* issue.

Ayub (2005) allows *sukuk* freely traded in the market subject to compliance with the following *shari'ah* rules:

- (i) Instruments representing real physical assets and usufructs are negotiable at market price. Certificates or *sukuk* issued by *musharakah*, *mudarabah* and *ijarah* are covered under this category.
- (ii) Instruments representing debts and money are subject for their negotiability to the rules of *hawalah* (assignment of debt) and *bay' al-sarf*. These include *sukuk al-salam*, *sukuk al-istisna'* (and *murabahah*) (as qualified above).
- (iii) Instruments representing a pool of different categories are subject to the rules relating to the dominant category. If cash and debts/receivables are relatively larger, the rule of *bay' al-sarf* would apply, and if real/physical assets and usufructs are overwhelming, trading would be on the market price (AAOIFI 2003).

Sukuk al-ijarah that have a good potential for trading, would be issued at par value while subsequent trading in secondary market could be conducted at any price above or below the face value. Another suggestion is that the respective central bank may purchase the entire issue from the SPV at face value.

Jobst (2007) argues that *sukuk* notes convey equity interest to (capital market) investors in the form of a call option on partial or complete ownership of underlying reference assets. Debatably Jobst (2007) continues to extend this characterisation of *sukuk* by including this right to a calculable rate of return as a share of profit (secondary notes) and the repayment of the principal amount (primary notes). What is due on the secondary notes requires to be qualified in the event of a profit being generated. The repayment of the principle could well be construed as a discount on issued bonds equated to interest returns and that the guaranteed ex-ante profit from a discounted offer does not expose investors to investment risk.

The *sukuk* are by conventional commentators sometimes categorised into three general categories; debt-based (such as *murabahah*, *ijarah*), equity-based (*musharakah* and *mudarabah*) and asset-based (Jobst 2007). Dar (2006) categorises *sukuk* by their applications; project, asset and balance sheet specific. He cites the example of the *ijarah* based Qatar Global *Sukuk* (QGS) (2003) towards the construction of Hamad Medical city

as project specific. *Sukuk al-ijarah* are also used as case examples by Dar to identify asset specific examples towards Malaysian (2002) and Bahraini government *sukuk* (2004) where the land was sold to a trust to retain beneficiary rights for investors. IDB (IDB 2003) performance of pooled assets for resource mobilisation is categorised as balance sheet specific. Ravalia (2008) grades the categories of *sukuk* in terms of their actual issuance profiles rather than on underlying nature of the *sukuk* forms. This is more likely to be consistent with a regulatory approach. His designation is (i) Fixed-income *sukuk* (credit risk of originator as the *sukuk* is ‘asset-based’ requiring some form of guarantee or ‘purchase undertaking’ similar to a conventional debt security), (ii) Asset-Backed *Sukuk* (ABS) (risk related to performance of underlying asset) and (iii) Hybrid *sukuk* (combination of originator credit risk and underlying assets). The originator cannot issue *sukuk* if it does not have sufficient tangible assets to meet the demands of investors, the hybrid *sukuk* emerged in the market.

In a hybrid *sukuk* structure, the underlying pool of assets can comprise an *istisna*’ contract, which allows for a greater mobilisation of funds. Hence the hybrid *sukuk* gives the possibilities to financing contracts for refinancing means: it is a refinancing tool. It even shows similarities to a securitisation structure, whereby debt receivables are sold to a SPV over which the SPV issues conventional bonds (Saeed and Salah 2012).

In the hybrid structure, the originator transfers tangible assets with underlying *ijarah* deals as well as *murabahah* and *istisna*’ deals from the originator to the SPV (ibid).

The *sukuk* market seemed to deviate from the strict requirement of tangible assets in *sukuk* transactions.

Since *murabahah* and *istisna*’ contracts cannot be traded in the secondary market because they create debt as the result of the *istisna*’ and *murabahah* based sale. Prohibition of *riba* does not allow trade in debt receivables. Therefore, at least 51% of the pool in a hybrid *sukuk* must comprise of tangible assets, which means the presence of *ijarah* contracts in hybrid *sukuk* (ibid).

IFSB (2007) identify three categories of *sukuk* towards capital adequacy rules (i) asset-backed *sukuk* (ii) *Sukuk* with a binding promise (purchase undertaking) by the originator (iii) “pass-through” *sukuk*.

Several of the broad range of *sukuk* defined by AAOIFI have yet to be realised in contemporary industry and are more traditionally related to agricultural modes of finance. The range of *sukuk* defined by AAOIFI is not an exclusive list and could be over time innovatively expanded upon. Further hybrids and combinations are being continuously derived. Other structures cannot be neglected and indeed are being used in combinations for the purposes of securitisation (Adam and Thomas 2004).

The entire transaction and operational lifecycle of *sukuk* has to be Islamically acceptable, from its nature, to its trading, its objective and its impact. The ethical, structural and operational aspects are different. Indeed this is also reflective of other Islamic financial instruments.

The design of a *sukuk* is very similar to the process of securitisation of assets in conventional markets where a wide range of asset types are securitised. The most prominent form of *sukuk* issuance and most relevant to current UK regulatory discussions is that of *sukuk al-ijarah*. *Sukuk al-ijarah* are examined and critically analysed in this section along with an alternative hybrid *sukuk*. As the universe of investors becomes more diverse, so too will their appetites, and with these there will be issuances beyond the currently prevalent *ijarah* contracts into more profit-and-loss sharing contracts and alternative hybrids. This exhibits perhaps the simplest *sukuk* issuance and most commonly known to that of the other end of the spectrum where considerable developments are occurring and how exchangeable and convertible *sukuk* are being arrived at.

Not all of the 14 *sukuk* identified within the AAOIFI *Shari'ah* Investment Standard No.17 *sukuk* are considered here due to constraints and because several forms have not been realised in current practice. *Sukuk al-wakalah* is based on agent operating on a fiduciary basis (AAOIFI 2008: Standard 17). It is commonly used and is similar to *sukuk al-mudarabah* but on a less complex principal-agent relationship. These pertinent forms

of *sukuk* are summarised and their particular requirements and securitisation mechanisms are compared.

Different *sukuk* structures have been emerging over the years but most of the *sukuk* issuance to date have been *sukuk al-ijarah*, since they are based on the undivided prorate ownership of the underlying leased asset, it is freely tradable at par, premium or discount. Tradability of the *sukuk* in the secondary market makes them more attractive. Although less common than *sukuk al-ijarah*, other types of *sukuk* are also playing significant role in emerging markets to help issuers and investors alike to participate in major projects, including airports, bridges, power plants etc. Figure 2.7 explains the ways Islamic banks use funds through different *shari'ah* contracts.

Figure 2.7: Use of Funds by Islamic Banks

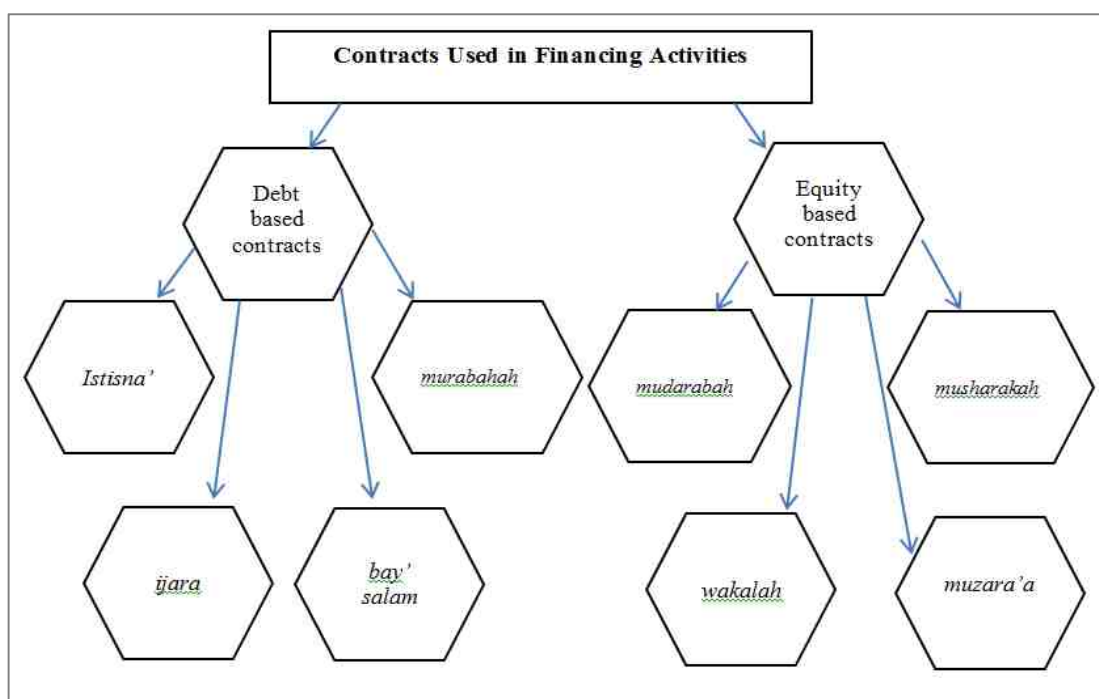

Source: Author's own

Musharakah sukuk (based on a partnership and equity with profit and loss-sharing) is the size-dominant *sukuk* structure. The *sukuk al-ijarah* (finance and lease-back) however, is more frequently issued. *Ijarah* based *sukuk* can provide a variable return similar to a floating rate note. *Mudarabah* based *sukuk* are also similarly used as a bond offering a

fixed return like a bond. As with conventional debt securities *sukuk* are issued for a fixed time period rather than in perpetuity as in the case of equity. The time period can vary from three months in the case of *sukuk* that are similar to treasury bills, to five or even ten years for those that resemble conventional notes.

Table 2.5: Comparative Analysis of Main Islamic Finance Contracts

| | Uses of Contract | Types of Financing | Main Risk(s) | Can financier(s) take Collateral? |
|-------------------|-------------------------|---------------------------------------|---------------------------------------|---|
| <i>murabahah</i> | Trade Finance | Deferred sale “ <i>Dayn</i> ” | Default | Yes |
| <i>ijarah</i> | Leasing | Lease finance “ <i>Dayn</i> ” | Default and destruction | Yes |
| <i>bay‘ salam</i> | Pre-production finance | Forward sale “ <i>Dayn</i> ” | Default | Yes |
| <i>istisna’</i> | Construction finance | Instalment sale “ <i>Dayn</i> ” | Default | Yes |
| <i>mudarabah</i> | Equity financing | Business (Entrepreneurship) financing | Fraud, negligence, Moral hazard, etc. | Yes, but to be exercised only for non-business failures |
| <i>musharakah</i> | Equity financing | Joint venture | Fraud, negligence, Moral hazard, etc. | Yes, but to be exercised only for non-business failures |

Source: Author’s own

2.9 SUKUK AL- IJARAH

Asset-based *ijarah sukuk*s are the most common form of Islamic securitisation. *Ijarah* (lease) is a contract according to which a party purchases and leases out equipment required by the client for a rental fee. *Sukuk al-ijarah* are securities representing the ownership of well-defined existing and well known assets, that are tied up to a lease contract. *Sukuk al- ijarah* are sometimes termed inappropriately as a vanilla *sukuk*. This is due to their common usage and structuring to represent bond-like characteristics for example rental payments are treated as coupon payments and redemption at maturity and return of principal at face value is associate with repurchasing of the property. It was also the *sukuk* form of choice considered by both the UK FSA and HM Treasury (2008)

towards the issuance (and origination) of a UK *sukuk* as a treasury bill. It can be issued by the owners of:

- (i) Existing leased assets;
- (ii) Existing assets to be leased on contract;
- (iii) Assets to be constructed/manufactured subject to lease;
- (iv) Assets held on the basis of a head lease;
- (v) Services acquired; and
- (vi) Services to be acquired.

The leased assets are the responsibility of the lessor (issuer) throughout the duration of the *ijarah*. Services such as major maintenances may be maintained by the lessee on behalf of the lessor. This may be done through a service agency agreement. Where there is a variable rate *sukuk* is envisaged, a Master Lease Agreement will be ideal.

Figure 2.8: Sukuk al-Ijarah Structure

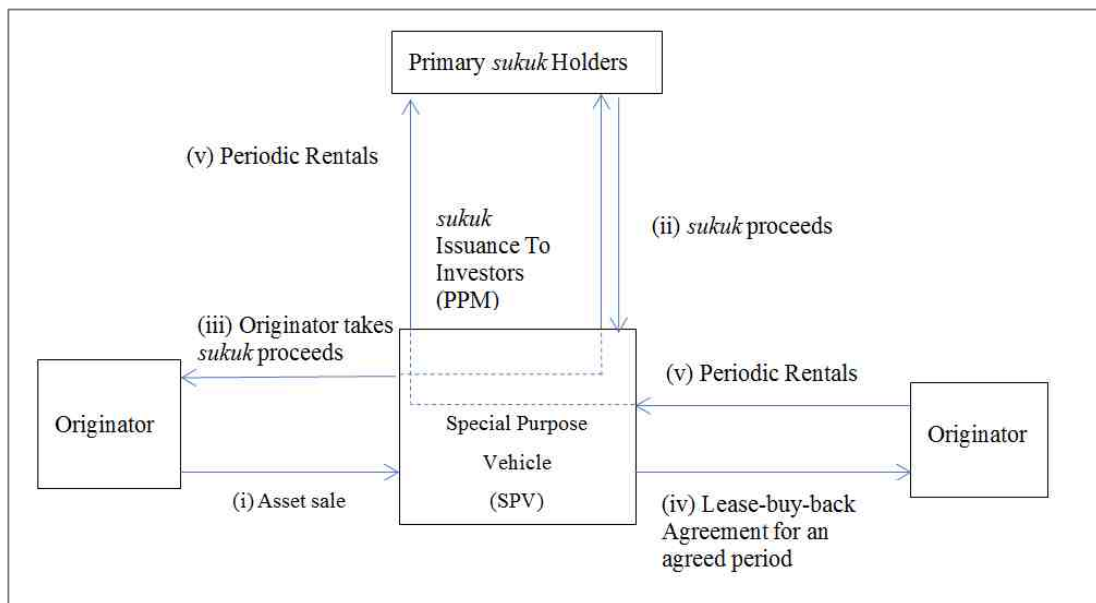

Source: Dar al-Itithmar, 2006

Sukuk al-ijarah offers a high degree of flexibility from the point of view of their issuance management and marketability.

The stages of the transaction lifecycle in relation to the structure of the *sukuk al-ijarah* (Figure 2.8) are:

- (i) After asset selection, the SPV buys from the ultimate obligor the beneficial title to the selected asset (usually a tangible asset with a low depreciation rate) at a nominal value. The SPV is a restricted independent entity established in an off-shore tax efficient jurisdiction such as Labuan, Malaysia or the Cayman Islands. The title to the asset is held by the SPV after the assets are sold by the originator (or obligator), as the cash provided by the investors is used by the SPV to pay for the title from the Originator. The prime function of the SPV is the management of the *sukuk*, in particular the receipt of rent from the client for the leased asset and the payment to *sukuk* investors. When the *sukuk* matures the SPV no longer has a role, and consequently it is wound up and ceases to exist as a legal entity. The SPV has no other obligations apart from those involved with the specific *sukuk*; hence, the SPV is bankruptcy remote. This is attractive to both the originators and the investors, justifying the relatively high legal costs of establishing the SPV.
- (ii) The SPV issues *ijarah sukuk* with a fixed maturity date. The *sukuk* proceeds from investors to purchase the certificates are paid to the SPV.
- (iii) The SPV pays the Originator for purchasing the assets.
- (iv) The SPV leases the asset to the ultimate obligor.
- (v) The obligor pays periodic rentals. The rental might be fixed or variable (in association with, LIBOR +) to be distributed to the *sukuk* holders. The duration of the rental and the fee are agreed in advance and ownership of the asset remains with the lessor.

The expected net return on some forms of *sukuk al-ijarah* may not be completely fixed and determined in advance, since there might be some maintenance and insurance expenses that are not perfectly determined in advance. *Sukuk al-ijarah* holders, as owners, bear full responsibility for what happens to their property. They are also required to maintain it in such a manner that the lessee may derive as much usufruct from it as possible. In theory, as owner of the project underlying the asset, the *sukuk* holders (lessors) are responsible for the asset maintenance, whereas the obligor (lessee is

responsible for the ordinary maintenance. In practice, all these responsibilities are passed to the lessee through a service agency agreement. It can be agreed, however, between the parties that the rentals would consist of two parts, one for payment to the lessor and the other as 'on account' payment, to be held by lessee for any costs relating to ownership of the asset (AAOIFI 2010).

Sukuk al-ijarah instruments are completely negotiable and can be traded in the secondary markets at a price determined by market forces. *Sukuk al-ijarah* are subject to risks related to the ability and desirability of the lessee to pay the rental instalments. Moreover, these are also subject to real market risks arising from potential changes in asset pricing and in maintenance and insurance costs. The rating of the *ijarah sukuk* will depend on the rating agency's evaluation of the ability of the originator to honour these commitments. If the financial circumstances of the originator change during the leasing period this may result in an accorded adjustment in the rating.

Immediately after the funding date, the ultimate obligor signs a unit purchase undertaking agreement to buy back, at maturity, the beneficial title of the assets. At maturity, or on a dissolution event, the SPV sells the assets back to the seller at a predetermined value. That value should be equal to any amounts still owed under the terms of the *sukuk al-ijarah*. However, in practice it is equivalent to the original price at which the asset was sold and from a *shari'ah* perspective, controversial. The originator also redeems to the SPV all the funds raised from investors at maturity. This is in addition to the final rental payment.

In the case of any litigation or default, the SPV is dissolved and the assets are transferred back to the obligor. The *sukuk* holder ranks *pari-passu*: equally with any other senior, unsecured foreign currency debt obligations issued by the Originator. Often, the *sukuk* holders are not entitled to claim the assets as a security for reimbursement of the Islamic bank's obligation. This is as opposed to a conventional mortgage loan. Wilson (2008) states that in practice "There can in other words be no capital gain or loss for the SPV or the issuer. It is the buy-back by the issuer that provides the funds for the reimbursement

of the investors of the sum they originally invested, also without capital gains or losses”. This is also controversial from an Islamic perspective.

Sukuk al-ijarah are typically medium-long term issued (Kettell 2011b). However, the UK treasury is seeking to use the *sukuk* for a period similar to that of a Treasury Bill (GB HM Treasury 2007). In practice, for longer periods of at least five years it is usual for the investors to receive a direct guarantee from the originator in respect of the ability of the SPV to fulfil its commitments by passing on the rental payments made by the originator (Das 2009). There are numerous examples of *sukuk al-ijarah*. Here the case of the sovereign *sukuk al-ijarah* structure towards the Qatar Global *Sukuk* (QGS) is highlighted in the following pages (ROBBÉ 2005).

The issues of purchase undertaking, the repurchase price of the asset, the avoidance of loss or risk of the parties, and entitlement to the asset under recourse or default will be shown to be common controversial themes in other *sukuk* forms (Saw and Wang 2008; Al-Amine 2012). They are to be discussed in depth from a scholarly perspective in later parts of this research.

2.9.1 SUKUK AL- MUSHARAKAH

Musharakah means a relationship established under a contract by the mutual consent of the parties for sharing of profits and losses in the joint business. All providers of capital are entitled to participate in management, but not necessarily required to do so. The profit is distributed among the partners in pre-agreed ratios, while the loss is borne by every partner strictly in proportion to respective capital contributions (El-Tiby 2011).

The *ijarah* structure is well tried and tested as the majority of *sukuk* are issued in this form, which reduces the legal costs and structuring fees involved with new issues (Adam and Thomas 2004). However, partnership structures based on *musharakah* are much closer to the traditional forms of business organisation and financing long practiced in the Muslim World (Wilson 2008). Hence, they are of fundamental interest to Islamic financial engineers.

Sukuk al-musharakah is tradable at market prices on any stock exchange and is listed in the same way as conventional bonds (Al-Khalifa 2007). *Sukuk al-musharakah* are documents of equal value issued with the aim of using the mobilised funds for establishing a new project or developing an existing one or financing a business activity on the basis of one of partnership contracts (Hassan and Irfan 2006). The certificate holders become the owners of the project or the assets of the activity as per their respective shares (Hassan and Irfan2006). These *musharakah* certificates can be traded as negotiable instruments and can be bought and sold in the secondary market (Al-Khalifa 2007).

Immediately after the funding date, the obligor signs controversially a unit purchase undertaking agreement to buy back at maturity the *sukuk* and to redeem to the SPV all the funds raised from investors in addition to the last periodic return (coupon). This agreement could also be executed before maturity in the case of default or dissolution of the *musahrakah* agreement. In this case the obligor must be kept liable for all the *sukuk* proceeds but without having any recourse to the underlying asset. The ultimate obligor's liability is considered as a senior unsecured debt obligation.

Figure 2.9: Sukuk al-Musharakah Structure

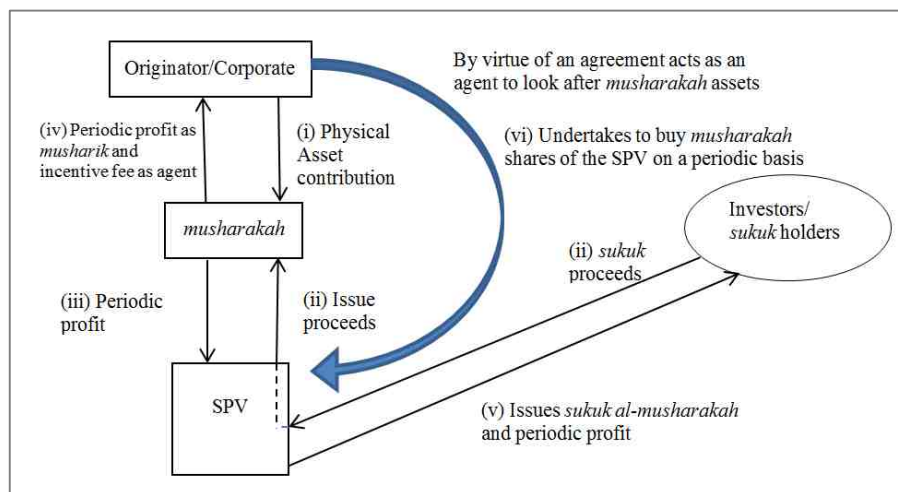

Source: Adapted from Dar al-Istithmar, 2006

The Corporate (technically the Originator or Obligor) seeking partners and the SPV enter into a *musharakah* Arrangement for a fixed period and an agreed profit-sharing ratio. Also the corporate undertakes to buy *musharakah* shares of the SPV on a periodic basis. The stages of the *sukuk al-musharakah* structure are as follows:

- (i) Corporate (as *musharik*) contributes land or other physical assets to the *musharakah*. The *musharik* or obligor, being in practice an Islamic bank, that contributes, usually in kind by providing land or buildings, to the *musharakah*. It is, therefore, a partner in the project. In practice, the *musharik* is appointed as a management agent to the *musharakah* project.
- (ii) The SPV issues *musharakah sukuk* with a fixed maturity date to raise funds from investors. SPV (as *musharik*) contributes cash i.e., the issue Proceeds received from the investors to the *musharakah*. The issuing vehicle, the SPV, collects the proceeds from the Islamic investors. This vehicle is a partner in the *musharakah* agreement acting on behalf of the *sukuk* holders. The SPV is completely owned by investors (*sukuk* holders) and is in charge of entering into a *musharakah* agreement with the obligor. As a partner in the underlying *musharakah* project, the SPV owns, in the name of the *sukuk* holders, shares in the project as specified in the *musharakah* agreement between the SPV and the obligor. In accordance with the terms and conditions of this contract, the SPV on behalf of the investors provides cash whereas the ultimate obligor may contribute in cash or in kind. The SPV acts as a trustee in respect to the trust project for the benefit of the *sukuk* holders.
- (iii) The *musharakah* appoints the Corporate as an agent to develop the land (or other physical assets) with the cash injected into the *musharakah* and sell/lease the developed assets on behalf of the *musharakah*. When managing a *sukuk* on the basis of *musharakah*, the manager is in charge of the *sukuk*, either in his capacity as a partner or as an authorised party on behalf of the other partners. When managing the *sukuk* on the basis of *musharakah*, partners to the *musharakah* agreement may participate in the management process of the underlying

musharakah project without interfering excessively with the underlying project managers.

- (iv) In return, the obligor/corporate as agent will get controversially a fixed agency fee plus a variable incentive fee (Dar Al Istithmar 2006). Although according to *shari'ah*, the obligor should not be allocated a separate share in profits in consideration for his work.
- (v) The profits are distributed to the *sukuk* holders. The profit is distributed among partners (the *sukuk* holders and the ultimate obligors or *musharik*) according to the initial contribution of each partner.

When issuing the *sukuk*, the SPV usually commits itself to share profits at a fixed ratio based on gross turnover or revenues of the underlying assets. A specific periodic return to investors (*sukuk* holders) is often sought by investors and may be limited to a traditional fixed or variable (linked to LIBOR + x basis points) yield to be paid semi-annually.

When the periodic profit generated from the project exceeds the targeted predetermined fixed return (LIBOR + x basis points), the issuing vehicle effectively receives only what it is liable to pay to the *sukuk* holders and the remaining profit is paid to the management agent (obligor) as a performance fee.

In the event that the project does not generate enough profits to pay the coupon to the *sukuk* holders, the SPV has the possibility to exercise a sale option or execute the purchase under an undertaking or promise of part of its units. The obligor is asked to buy these units and mitigate this shortfall therefore providing the SPV with enough cash to pay the periodic return (coupon) promised by the SPV to the *sukuk* holders.

The Corporate irrevocably undertakes to buy at a pre-agreed price the *musharakah* shares of the SPV on say semi-annual basis and at the end of the fixed period the SPV would no longer have any shares in the *musharakah*.

Musharakah sukuk appears to be gaining in popularity and there have been several recent issues in both Malaysia and the Gulf (Wilson 2008). One of the largest *musharakah sukuk* to is a seven year deal for Emirates Airlines (2005) at \$550 million, to finance a new

engineering centre in Dubai to service its aircraft. The SPV designated 'Wings', entered into a *musharakah* partnership arrangement with Emirates. The *musharakah* or joint venture was set up to develop a new engineering centre and a new headquarters building on land situated near Dubai's airport which will ultimately be leased to Emirates. Profit, in the form of lease returns, generated from the *musharakah* or joint venture will be used to pay the periodic distribution on the trust certificates.

2.9.2 SUKUK AL- MUDARABAH

Mudarabah is an agreement between two parties according to which one of the two parties provides the capital (capital provider) for the other (*mudarib*) to work with on the condition that the profit is to be shared between them according to a pre-agreed ratio. *Sukuk al-mudarabah* in form can also be referred to *sukuk al-muqharadah*.

Mudarabah sukuk gives its owner the right to receive his capital at the time the *sukuk* are surrendered, and an annual proportion of the realised profits as agreed. They play a vital role in the process of development financing, because it is related to the profitability of the projects. The issuer of these certificates is the *mudarib*, the subscribers are the capital providers, and the realised funds are the *mudarabah* capital.

The certificate holders own the assets of *mudarabah* and the agreed upon share of the profits; losses, if any, are borne by capital providers only. *Mudarabah sukuk* neither yield interest nor entitle owners to make claims for any definite annual interest. This shows that *mudarabah sukuk* is like shares with regard to varying returns, which are accrued according to the profits made by the project.

Mudarabah sukuk must represent a common ownership and entitle their holder to shares in a specific project for which the *sukuk* have been issued to fund. A *sukuk* holder is entitled to all rights, which have been determined by *shari'ah* upon his ownership of the *mudarabah* bond in matters of sale, gift mortgage, succession and the like. On the expiry of the specified time period of the subscription, the *sukuk* holders are given the right to transfer the ownership by sale or trade in the securities market at his discretion. These

sukuk are considered as shares without management participation rights and are similar to limited partnerships. Figure 2.10 depicts the transactions within a *mudarabah sukuk*.

Figure 2.10: Sukuk al-Mudarabah Structure

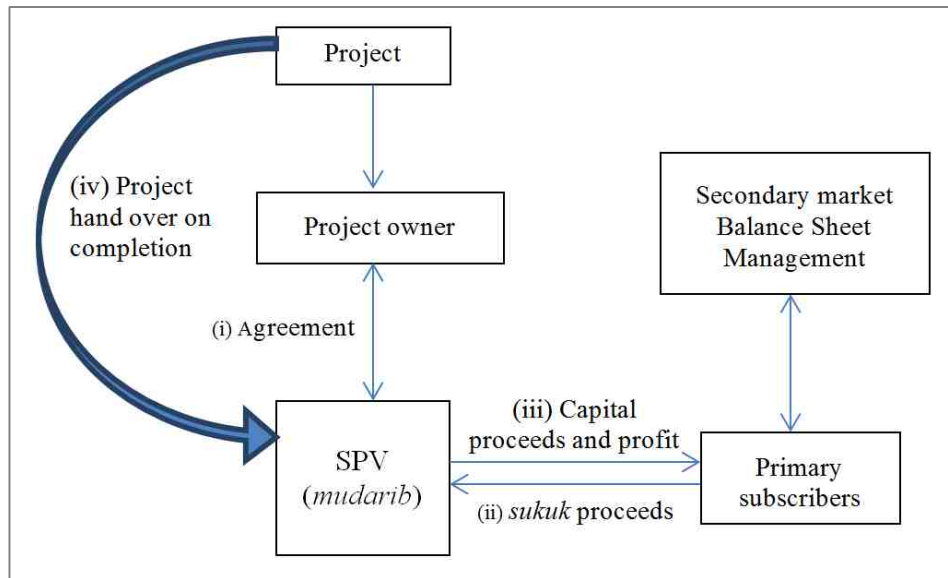

Source: Adapted from Dar al-Istithmar, 2006

- (i) *Mudarib* enters into an agreement with project owner for construction/commissioning of project. Usually the *mudarabah sukuk* is managed according to a restricted *mudarabah* contract, that is, the *sukuk* subscription prospectus includes the terms and conditions defining the field and method. This specifies what the *mudarabah* is permitted to invest in and whether it will be a lease, direct investment or other investments directed in the bye-laws set up by the *mudarib* who also expresses his readiness to abide by them.
- (ii) SPV issues *sukuk* for a specific period of time to raise funds from Islamic investors. This vehicle plays the role of *rabb al-mal* (the investor) on behalf of the Islamic investors and is, therefore, a partner in the *mudarabah* agreement. The SPV is completely owned by the investors (*sukuk* holders) and is in charge of entering into a *mudarabah* agreement with the *mudarib*. As a main partner in the underlying *mudarabah* project, the SPV owns, in the name of the *sukuk* holders, shares in the project as specified in the *mudarabah* agreement between the SPV

and the *mudarib*. The SPV acts as a trustee in respect to the trust project for the benefit of the *sukuk* holders.

- (iii) *Mudarib* collects regular profit payments and final capital proceeds from project activity for onward distribution to investors. The *mudarib* that manages the proceeds is therefore the second partner to the *mudarabah*. He is the manager whose responsibility is to manage the proceeds received from investors in accordance with the conditions provided in the subscription prospectus. In consideration for his work, the *mudarib* (manager) is paid an agreed share of the *sukuk* profits. Where a *mudarib* is appointed, investors do not get involved in the administration and management of the *sukuk* unless otherwise stated by the instructions and constraints of the bye-laws.
- (iv) Upon completion, *mudarib* hands over the finished project to the owner. In accordance with the terms and conditions of this contract, the SPV, on behalf of the investors, provides the cash whereas the *mudarib* provides his time and effort.

The *shari'ah* rules of trading *sukuk al-mudarabah* are similar to that of other fiduciary *sukuk al-musharakah* and *sukuk al-wakalah*. If the *mudarabah* capital, before the operation of the specific project, is still in the form of money, the trading of the *mudarabah sukuk* would be exchanged of money for money and it must satisfy the rules of *bay' al-sarf* and the principles of debt-trading in Islamic jurisprudence.

The prospectus should not contain a guarantee, from the issuer or the manager of the fund, for the capital or a fixed profit, a specific amount or a profit based on any percentage of the capital. The profit is to be divided by applying rules of *shari'ah*; that is, an amount in excess of the capital, and not the revenue or the yield. The Profit and Loss Account of the project must be published and disseminated to *sukuk* holders.

It is permissible to create reserves for contingencies, such as loss of capital, by deducting from the profit a certain percentage in each accounting period. The prospectus can also contain a promise made by a third party, totally unrelated to the parties to the contract, in terms of legal entity or financial status, to donate a specific sum, without any counter benefit, to meet losses in a given project, provided such commitment is independent of

the *mudarabah* contract. However, it is not permissible for the issuer to guarantee the capital of the *mudarabah* (IFA 2000).

The Dubai Ports (DPs) World *sukuk* is a prominent global *sukuk* based on a *mudarabah* structure. On 2 July 2007, the DPs World Group issued a 10 year Islamic Bond (*sukuk*) for the value of \$1.5 billion and 30 year Conventional Bond (Medium Term Note), value \$1.75 billion, listed on the Dubai International Financial Exchange (DIFX) and the LSE. Ahead of these debt issues, the Company received a credit rating of A1/A+ from Moody's and Standard & Poor's respectively. The DPs World *sukuk* is structured. Details of the *sukuk* are summarised and provided in this research.

Figure 2.11: Dubai Ports (DP) World Sukuk Structure

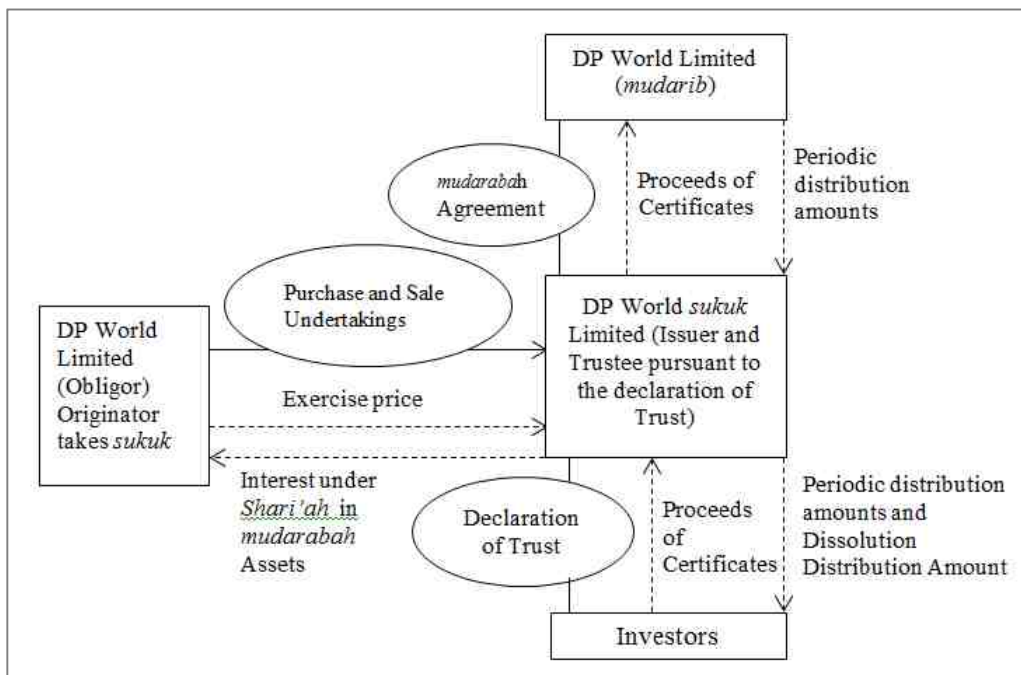

Source: Dubai DP World

At the LSE, this *sukuk* is formed between four certificates either as Medium Term Notes (MTNs) for UAE originated debt and Eurobond Warrants for the Cayman Island registered debt (Table 2.6) – as per the details of the offer.

Table 2.6: DP World Sukuk on the LSE

| | | | | |
|-------------------|--|--|--|--|
| Last Date | 02/07/2007 | | 03/07/2007 | |
| Company | DP World Ltd | | DP World <i>sukuk</i> Ltd | |
| Stock Name | 6.85% NTS 02/07/37 USD 100000 '144A' | 6.85% NTS 02/07/37 USD100000 'REGS' | Trust Certs 2/7/17 USD100000 144A | Trust Certs 2/7/17 USD100000 REGS |
| ISIN | US23330JAA97 | XS0308427581 | US23330NAA00 | XS0307408152 |
| Stock Description | Medium Term Notes (Company issue) | | Eurobond Warrants | |
| Money Raised (£m) | 0 | 877,4898931 | 0 | 751,0350999 |
| Country of Origin | UAE | | Cayman Islands | |
| World Region | Rest of World | | | |
| Market Segment | CWNR | | | |
| Description | Corp Wholesale Debt-Regulated Mkt-Non Reportable | | | |
| Market Sector | NIDW | | | |

Source: Adapted (author)

2.9.3 SUKUK AL-MURABAHAH

Murabahah is basically the sale of goods at a price comprising the purchase price plus a margin of profit agreed upon by both parties concerned (Jamaldeen and Friedman 2012). *Sukuk al-murabahah* are certificates of equal value issued for the purpose of financing the purchase of goods through *murahabah* so that the certificate holders become owners of the *murabahah* commodity (ibid). The issuer of the certificate is the seller of the *murabahah* commodity, the subscribers are the buyers of that commodity, and the realised funds are the purchasing cost of the commodity. The certificate holders own the *murabahah* commodity and are entitled to its final sale price upon the re-sale of the commodity (ibid).

The possibility of having legally acceptable *murahabah*-based *sukuk* is only feasible in the primary market (ibid). The negotiability of these *sukuk* or their trading at the secondary market is not permitted by *shari'ah*, as the certificates represent a debt owing from the subsequent buyer of the commodity to the certificate-holders and such trading amounts to trading in debt on a deferred basis, which will result in *riba* (ibid). Despite being debt instruments, the *murahabah sukuk* could be negotiable if they are the smaller part of a package or a portfolio, the larger part of which is constituted of negotiable instruments such as *mudarabah*, *musharakah*, or *ijarah sukuk* (ibid).

Murabahah sukuk have, however, become popular in Malaysian market due to a more liberal interpretation of *fiqh* by Malaysian jurists permitting sale of debt (*bay' al-dayn*) at a negotiated price. The term more commonly used in Malaysia is *bay' bithaman 'ajil*. The Securities Commission of Malaysia has similar rules refined for the investment and securities market. The result is commercial paper and bond issuances that are based upon the sale of *murabahah* receivables. These products are not accepted outside of Malaysia.

The transactions involved in a *murabahah sukuk* structure in Figure 2.12 are:

- (i) A master agreement is signed between the SPV and the borrower.
- (ii) SPV issues *sukuk* to the investors and receive *sukuk* proceeds.
- (iii) SPV buys commodity on spot basis from the commodity supplier.
- (iv) SPV sells the commodity to the borrower at the spot price plus a profit margin, payable on instalments over an agreed period of time.
- (v) The borrower sells the commodity to the commodity buyer on spot basis.
- (vi) The investors receive the final sale price and profits.

Figure 2.12: Sukuk al-Murabahah Structure

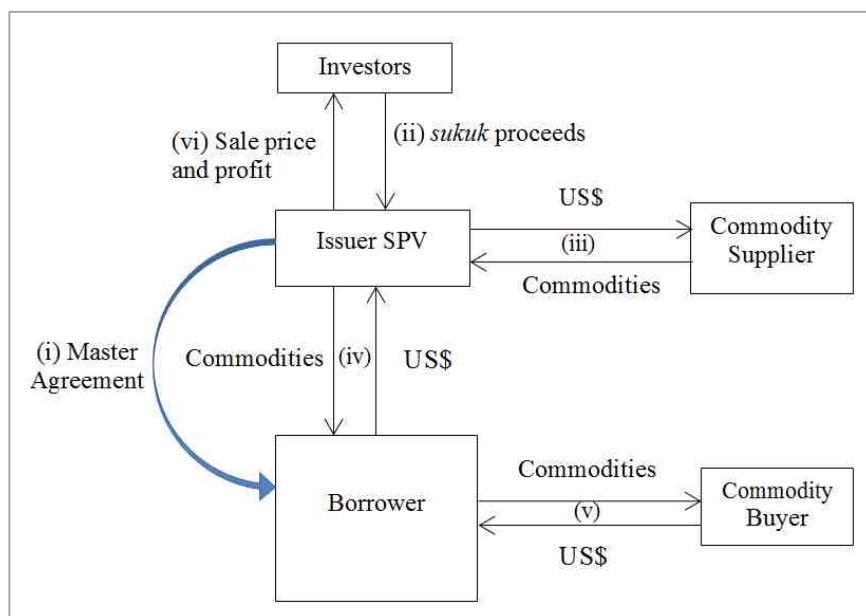

Source: Adapted from Dar al-Istithmar, 2006

An example of *sukuk al-murabahah* is Arcapital Bank, a Bahrain-based investment firm has mandated Bayerische Hypo-und Vereinsbank AG (HVB), Standard Bank Plc and WestLB AG, London Branch (WestLB) (together the “Mandated Lead Arrangers”), to arrange a Five Year Multicurrency (US\$, € and £) *murabahah*-backed *sukuk*. *Sukuk* will have a five year bullet maturity and proposed pricing three month LIBOR + 175bps (Stensgaard 2005).

2.9.4 SUKUK AL-SALAM

Sukuk al-salam is used as a short-term liquidity instrument by the Bahrain Monetary Agency (VISSER 2009). This is similar to the objectives of what the UK is seeking to achieve in its decision to work towards a Treasury Bill *sukuk* (albeit based on *sukuk al-ijarah*) (GB HM Treasury 2007a). In practice *salam* (or *bay' al-salam*) structures have proved more popular for short run financing *sukuk* than *murabahah* as the latter usually involves commodity trading, the finance of which is not the aim of most *sukuk* issues (Wilson 2008). The *sukuk al-salam* is similar to zero coupon bonds and categorised as futures as well (Deloitte 2012).

Salam simply refers to a sale in which payment is made in advance by the buyer, and the delivery of the asset is deferred by the seller (Al-Amine 2012). *Salam* is the sale of a specified commodity, well defined in its quality and quantity, which will be delivered to the purchaser on a fixed date in the future against an advanced full payment of price at spot (Shanmugam and Zahari 2009). All standard *shari'ah* requirements that apply to *salam* also apply to *sukuk al-salam*, such as, full payment by the buyer at the time of affecting the sale, standardized nature of underlying asset, clear enumeration of quantity, quality, date and place of delivery of the asset and the like (Nisar 2000),

One of the *shari'ah* conditions relating to *salam*, as well as for creation of *sukuk al-salam*, is the requirement that the purchased goods are not re-sold before actual possession at maturity (ibid). Such transactions amount to selling of debt. This constraint renders the *salam* instrument illiquid and hence somewhat less attractive to investors. Thus, an investor will buy a *salam* certificate if he expects prices of the underlying commodity to be higher on the maturity date (ibid).

Sukuk al-salam are certificates of equal value issued for the purpose of mobilising *salam* capital so that the goods to be delivered on the basis of *salam* come to the ownership of the certificate holders (Gannon 2009). The period involved is usually short, as with *murabahah*, three months being typical (Schoon 2009a). In practice a *salam sukuk* can be considered as a *shari'ah* compliant substitute for a conventional treasury bill issued for three months short term financing by governments, as the return and the period to maturity are fixed when the offer is made (QFC 2009). Such *salam sukuk* have been issued by the Bahrain Monetary Agency at three monthly intervals (Thomas et al. 2005b).

Aluminium has been designated as the underlying asset of the Bahrain Government *salam* contract, whereby it promises to sell aluminium to the buyer at a specified future date in return of a full price payment in advance. One bank, namely the Bahrain Islamic Bank (BIB), has been nominated to represent the other banks wishing to participate in the *salam* contract. BIB has been delegated to sign the contracts and all other necessary documents on behalf of the other banks in the syndicate. At the same time, the buyer appoints the Government of Bahrain as an agent to market the appropriate quantity at the time of delivery through its channels of distribution. The Government of Bahrain provides an additional undertaking to the representative (BIB) to market the aluminium at a price, which will provide a return to *salam* security holders equivalent to those available through other conventional short-term money market instruments (Ayub 2007).

Salam-based securities may be created and sold by an SPV (as depicted in Figure 2.13) under which the funds mobilised from investors are paid as an advance to the company SPV in return for a promise to deliver a commodity at a future date. SPV can also appoint an agent to market the promised quantity at the time of delivery perhaps at a higher price. The difference between the purchase price and the sale price is the profit to the SPV and hence to the holders of the *sukuk* (Nisar 2000).

Figure 2.13: Sukuk al-Salam Structure

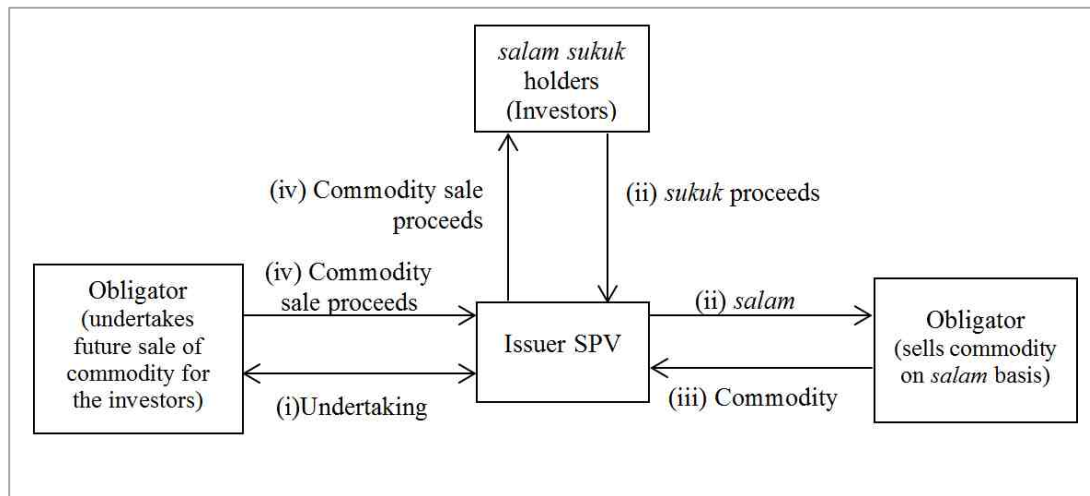

Source: Adapted from Dar al-Istithmar, 2006

The issuer of the certificates is a seller of the goods of *salam*, the subscribers are the buyers of the goods, while the funds realised from subscription are the purchase price (*salam* capital) of the goods. The holders of *salam* certificates are the owners of the *salam* goods and are entitled to the sale price of the certificates or the sale price of the *salam* goods sold through a parallel *salam*, if any (El-Tiby 2011). The steps in the transaction are;

- (i) SPV signs an undertaking with an originator/obligator to source both commodities and buyers (Nisar 2000). The title is transferred to the assets of the SPV. The obligor (usually an Islamic bank) contracts to buy, on behalf of the end-*sukuk* holders contracts to deliver, in the future, specific goods or assets (the asset underlying the *salam* agreement) at a predetermined spot price for the profit of the *sukuk* holders (Adam and Thomas 2004).
- (ii) *Salam* certificates are issued to investors and SPV receives *sukuk* proceeds. The certificates of participation represent an undivided right to an interest in the assets, which means that the assets cannot be sold to another party for the duration of the *sukuk*. In return for the certificates of participation the investors make an up-front payment which entitles the investor to a future refund of the investment plus a

- fixed mark-up agreed in advance. It is because the initial payment is in advance, or upfront, that designates the structure as *salam* (Jamaldeen and Friedman 2012).
- (iii) The *salam* proceeds are passed onto the obligator who sells commodity on forward basis (ibid). The initial cash provided by the investors and collected by the SPV is used to make a payment to the originator (Obligator) in return for an undertaking to deliver the asset at maturity (DIFC and Clifford Chance 2009).
 - (iv) SPV receives the commodities from the obligator (Nisar 2000). At that stage, typically after three months, the SPV takes delivery of the asset, but sells it back to the Obligator. This is the parallel *salam* part (DIFC and Clifford Chance 2009).
 - (v) Obligator, on behalf of *sukuk* holders, sells the commodities for a profit (Alchaar and Sandra 2009). The proceeds from this sale are then used to reimburse the cash provided by the Islamic investors, and provide them with the pre-agreed mark-up return in relation to their investment (Adam and Thomas 2004). The underwriter is usually an entity linked to the ultimate obligor (Islamic bank) that underwrites (underwriting agreement or a parallel *salam*) to buy at maturity the delivered good or asset at a predetermined price. The latter usually consists of the initial cash money received by the obligor plus a margin (Adam and Thomas 2004; Jamaldeen and Friedman 2012).
 - (vi) *Sukuk* holders receive the commodity sale proceeds. Before obtaining the return of their cash and the mark-up the investors have to surrender their certificates of participation to the SPV, implying they have no further right to an interest in the assets. At maturity, the *sukuk* holders receive their proceeds in addition to the margin paid by the underwriting entity (ibid).

2.9.5 SUKUK AL-ISTISNA'

Istisna' is a contractual agreement for manufacturing goods and commodities, allowing cash payment in advance and future delivery or a future payment and future delivery. A manufacturer or builder agrees to produce or build a well described good or building at a given price on a given date in the future. Price can be paid in instalments, step by step as agreed between the parties (Usmani 1998). The contract involves investors who agree to buy the commodity before its completion (Kettell 2010b). *Istisna'* can be used for

providing the facility of financing the manufacture or construction of houses, plants, projects, and building of bridges, roads and highways (ibid). The *istisna'* contract is similar to project finance contracts in conventional finance (Pock 2007). *Istisna'* is a sale where a commodity is transacted before its completion (that is, during its development phase) (Thomas and Kraty 2005). This is increasingly important in Muslim states where governments put greater emphasis on private-public partnerships rather than fund new infrastructure schemes from their own budgets (Wilson 2008).

The suitability of *istisna'* for financial intermediation is based on the permissibility for the contractor in *istisna'* to enter into a parallel *istisna'* contract with a subcontractor (Khorshid 2009). Thus, a financial institution may undertake the construction of a facility for a deferred price, and sub contract the actual construction to a specialised firm (ibid).

Sukuk al-istisna' is often combined with *sukuk al-ijarah* towards for example project financing of Build Operate Transfer ventures (Adam and Thomas 2004; Kettell 2010b). In 2006, *Tabreed sukuk*, a five-year global corporate *sukuk* (on behalf of the National Central Cooling Company, UAE) provided a fixed coupon of 5.50%. It is a combination of *ijarah*, *istisna'* and *ijarah mawsufah fi al-dhimmah* (or forward leasing contracts). The issues was launched to raise funds to retire some existing debt, which totals around USD136 million, as well as to finance expansion (Adam and Thomas 2004).

Investors are not obliged to pay all the investment in advance, but to pay gradually before the beginning of each stage of the manufacturing process of the commodity (Kettell 2010b). It is necessary, for the *shari'ah* validity of *istisna'*, that the price of the commodity is fixed with the consent of the parties, and that the necessary specification of the commodity (intended to be manufactured) is fully settled between them (ibid).

In comparison with *sukuk al-salam*, the totality of the investment is paid in advance whereas with *istisna'*, it can be paid during the manufacturing process (Kettell 2011b; Kettell 2010b). For *istisna'*, the delivery time can be variable unlike for *salam* where it has to be fixed (Usmani and Zubairi 2002; Tusi 2008). Contract cancellation can only occur with *istisna'* providing it is before the start of the project (Kettell 2010b). The underlying asset is always a manufactured good with *istisna'* – with *salam* it can relate to

other non-fungible goods also (Kettell 2010b; Thomas 2005). However, for both *sukuk al-salam* and *istisna'*, *shari'ah* prohibition of *riba* precludes the sale of these debt certificates to a third party at any price other than their face value (QFC 2009; Zarqa 1997). Clearly such certificates, which may be cashed only on maturity, cannot have a secondary market (Khorshid 2009). The AAOIFI standard permits trading within the period of the *istisna* if the funds have been converted to assets owned by certificate holders (Usmani 2007). Otherwise if the price has been paid immediately as in a parallel *istisna'*, then trading is subject to the rules of debt disposal (*ibid*).

Figure 2.14: Sukuk al-Istina'

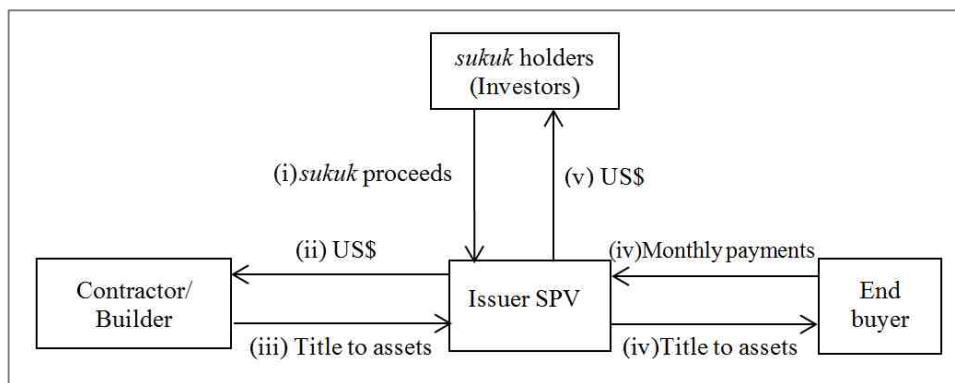

Source: Adapted from Dar al-Istithmar, 2006

The transactions involved within the *istisna'* structure are as follows:

- (i) The SPV enters into an *istisna'* agreement with the obligor to manufacture the commodity (assets). The obligor could be the manufacturer. The Issuer, the SPV, issues *sukuk* to the investors (Mannan (2008) as cited by Gurulkan (2010)). SPV issues *sukuk* certificates to raise funds for the project. *sukuk al-istisna'* are certificates that carry equal value and are issued with the aim of mobilising the funds required for producing products that are owned by the certificate holders.
- (ii) *Sukuk* issue proceeds are used to pay the contractor/builder to build and deliver the future project (*ibid*). The *sukuk* proceeds from the investors are transferred by the SPV to the ultimate obligor – the manufacturer. The issuer of these certificates

is the manufacturer (supplier/seller), the subscribers are the buyers of the intended product, while the funds realised from subscription are the cost of the product. The certificate holders own the product and are entitled to the sale price of the certificates or the sale price of the product sold on the basis of a parallel *istisna'*, if any.

- (iii) The manufacturer delivers the commodities when completed. Title to assets is transferred to the SPV (ibid).
- (iv) Property; project is leased or sold to the end buyer. The end buyer pays monthly instalments to the SPV. At maturity, the SPV sells the commodities to the ultimate obligor (ibid).
- (v) SPV reimburses the commodities proceeds to investors. The returns are distributed among the *sukuk* holders (ibid).

2.9.6 HYBRID SUKUK

Considering the fact that *sukuk* issuance and trading are important means of investment and taking into account the various demands of investors, a more diversified *sukuk*-hybrid or mixed asset/mixed portfolio *sukuk* is emerging in the market (ibid). Chowdhury states that Islamic institutions should perhaps think beyond equity instruments; and that perhaps hybrid instruments may be most suitable (Chowdhury 2008).

There is an interest in innovation in *sukuk* from originators, partly because of the prestige involved in being first in the field with a new innovative product (Wilson 2008). Innovative financial engineering leading to *sukuk* is also leading to additional forms of *sukuk* with labels that are more readily understood in conventional terms (Askari et al. 2010). For example, *sukuk* can exist convertible, subordinated and be issued for a multitude of Islamically purposes such as Real Estate Investment Trusts (REITs) (Moody's 2008a). These can be of course within sovereign or corporate issuances. The hybrid *sukuk* represents the potential of new structures and benefits to the investors (Khorshid 2009).

In a hybrid *sukuk*, the underlying pool of assets can comprise of *istisna'*, *murabahah* receivables as well as *ijarah* (Tariq 2004). Having a portfolio of assets comprising of different classes allows for a greater mobilisation of funds (ibid). However, as *murabahah* and *istisna'* contracts cannot be traded on secondary markets as securitised instruments at least 5 percent of the pool in a hybrid *sukuk* must comprise of *sukuk* tradable in the market such as an *ijarah sukuk* (Chowdhury, 2004). Due to the fact the *murabahah* and *istisna'* receivables are part of the pool, the return on these certificates can only be a pre-determined fixed rate of return (Tariq 2004). Dar al-Istithmar (2006) provides a perspective of one form of hybrid *sukuk* (Figure 2.15).

Figure 2.15: Hybrid Sukuk

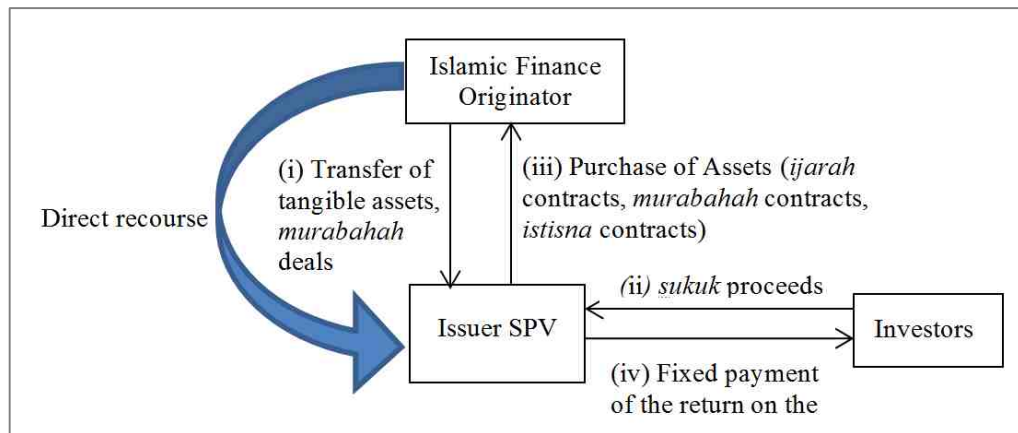

Source: Dar al-Istithmar, 2006

The transactional stages involved typically in this hybrid form are (Saeed and Salah 2012):

- (i) Islamic finance originator transfers tangible assets as well as *murabahah* deals to the SPV.
- (ii) SPV issues certificates of participation to the *sukuk* holders and receives funds. The funds are used by the Islamic finance originator.
- (iii) Islamic finance originator purchases these assets from the SPV over an agreed period of time.
- (iv) Investors receive fixed payment of return on the assets.

The hybrid *sukuk* was the basis of the IDB *sukuk* (2003). Islamic Development Bank (IDB) issued the first hybrid *sukuk* of assets comprising 65.8% *sukuk al-ijarah*, 30.73% of *murabahah* receivables and 3.4% *sukuk al-istisna'* (Nisar 2000). This issuance required the IDB's guarantee in order to secure a rating and international marketability. The USD400 million Islamic *sukuk* was issued by Solidarity Trust Services Limited (STSL), a SPC incorporated in Jersey Channel Islands (Ayub 2007). The Islamic Corporation for the Development of Private Sector played an intermediary role by purchasing the asset from IDB and selling it to the STSL at the consolidated net asset value (Al-Amine 2012). In June 2005, IDB issued USD500 million floating rate *sukuk* under its USD1 billion MTNs programme based on mixed portfolio comprising assets leased by IDB, not less than 30 per cent of total value, and instalment payments under *murabahah* and *istisna'* contracts which the IDB has entered into with some of its clients (Ayub 2005 and Al-Amine 2012).

Figure 2.16: IDB Sukuk Structure

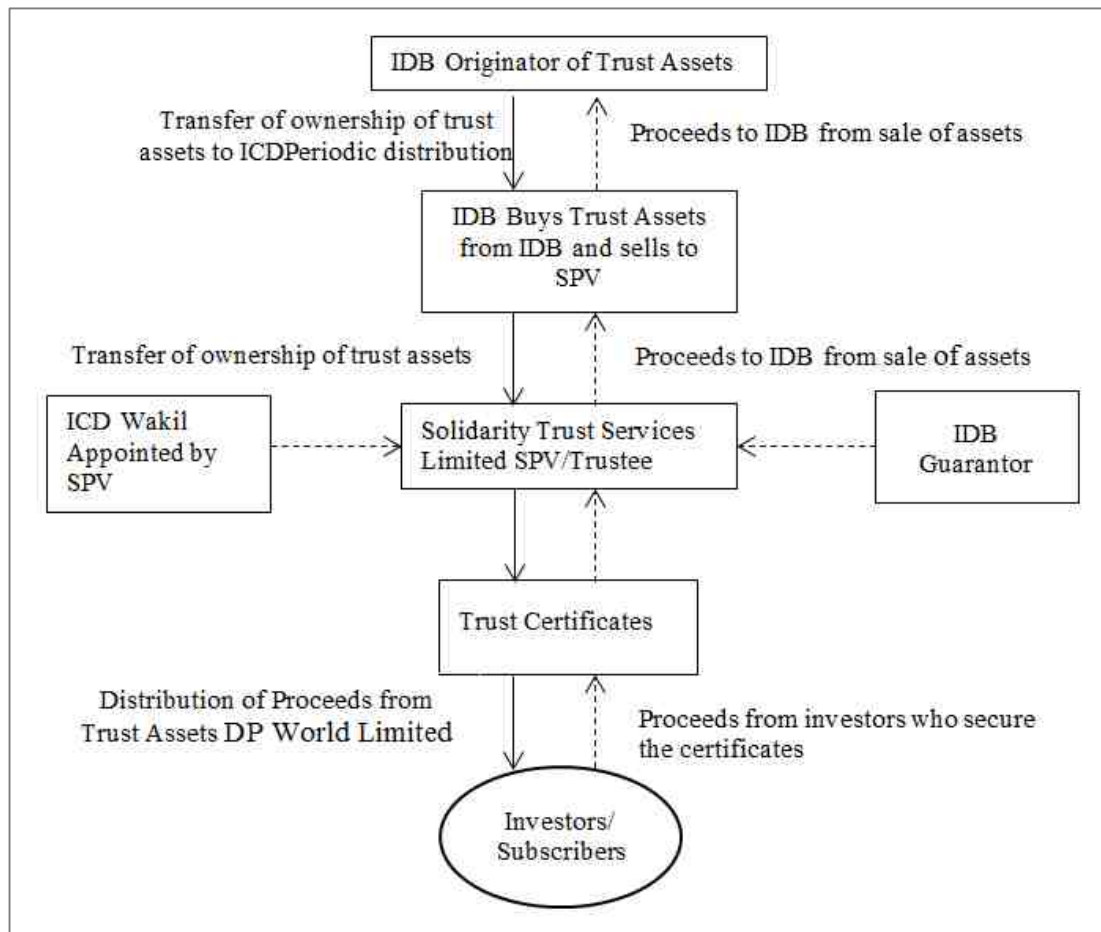

Source: IDB

The IDB *sukuk* as such, provides IDB's guarantee (for the rate on the certificates). It does not comprise a guarantee of payments in respect of the Trust Certificates (TCs) but represents a guarantee, *inter alia*, of the amount scheduled as being payable by the obligors of the underlying transactions in respect of the assets. In case of any shortfall in return on the *sukuk* assets the IDB has agreed to meet the shortfall. On the basis of the 'Purchase Undertaking Deed' between IDB and the Trust, the IDB will purchase the *sukuk* assets on the earlier of the maturity date or the dissolution date (Al-Amine 2012).

Profit on *sukuk* assets, net of expenses of the trust, would be used to give periodic return to the certificate holders. Certificates would be redeemed at 100% of their principal value. On the basis of a separate undertaking, IDB has guaranteed payment in respect of

assets owed by the Trustee by reference to the schedule of payments given by IDB at the time of sale of assets to the Trustee.

Diminishing *musharakah* is a popular form of hybrid Islamic financing mode combining aspects of both *ijarah* and *musharakah* forms particularly for purchasing mortgages. It is becoming increasingly popular within the UK and elsewhere. As a *sukuk* it has not currently been realised on a large scale. According to Wilson (2006), the diminishing *musharakah* structure has the most potential for *sukuk*. The investors receive the return of their capital at the end of the period in a *salam*, *ijarah* or *musharakah sukuk*. A diminishing *musharakah* structure returns the capital investment in instalments, with the final instalment terminating the partnership. Hence, the payments are different from a pure *ijarah sukuk* structure.

Figure 2.17: Diminishing Musharakah Structure

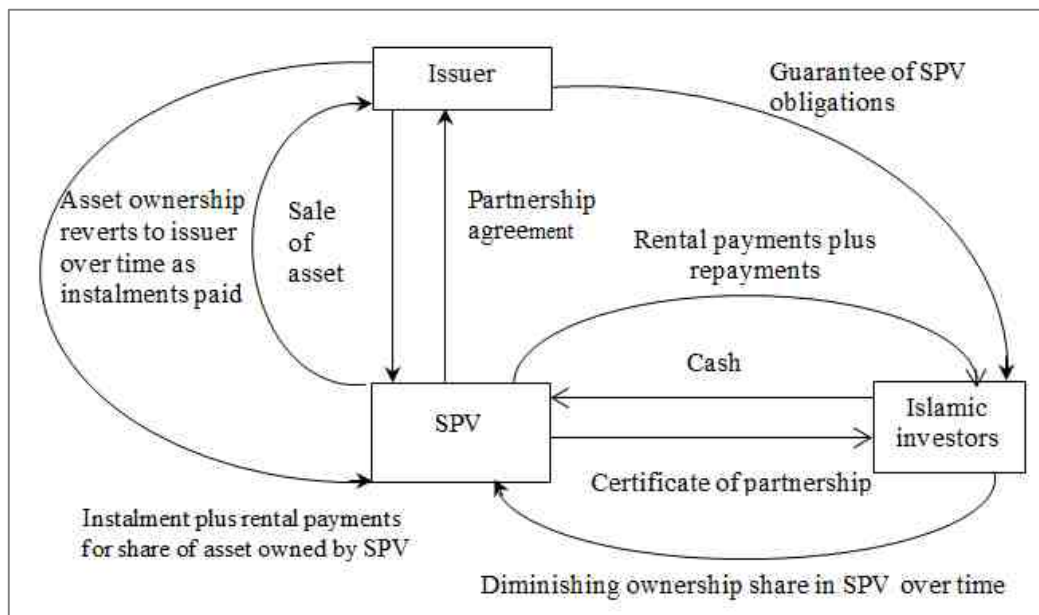

Source: Wilson 2008

Structure in Figure 2.17 is similar to an *ijarah sukuk*. The originator sells an asset to the SPV while entering a partnership rather than a leasing agreement. The Islamic investors pay cash but receive certificates of partnership rather than certificates of participation. The legal implication is that both the investors and the issuer are partners in the SPV but

that the share of the investors in the SPV will diminish over time as instalment payments are made by the issuer to repurchase the asset. It is these repayments, plus the rental paid by the issuer for the use of the asset, that provides the income stream for the investors.

2.10 GROWTH OF SUKUK AND ITS IMPACT ON EMERGING MARKETS

2.10.1 GROWTH OF SUKUK

The first ever *sukuk* was issued in 1990 in Malaysia by a foreign owned company namely Shell MDS. The *sukuk* issue was in Malaysian Ringgit (RM) of the volume of RM 125 million. It was a *bay' bithaman 'ajil sukuk*. In 2000, the Sudanese government issued a domestic sovereign short-term Government *Musharakah* Certificates of a value of Sudanese Pound (SDG) 77 million (Sudan, Central Bank of Sudan 2009).

In the year 2001, the first international *sukuk* was issued, which was a United States Dollar (USD) denominated sovereign *sukuk al-ijarah* of USD 100 million with a five year term. In the same year, the then Bahrain Monetary Agency which is now known as the Central Bank of Bahrain issued a different sovereign *sukuk* based on *sukuk al-salam* for a term of one year. In 2001, Malaysian based company Kumpulan Guthrie Berhad or Guthrie Group Limited issued for the first time an international corporate *sukuk* based on *sukuk al-ijarah* of USD 150 million for tenure of five years. This opened a door for many countries and corporates to tap investors' fund willing to invest in *shari'ah* compliant manner and they issued corporate and sovereign *sukuk* both domestically and internationally. As a result *sukuk* became a main financing mode for Islamic finance with new inventions and techniques in the product development using structures of *ijarah*, *musharakah*, *mudarabah*, hybrid, exchangeable and convertible.

Preceding financial crisis the growth rates of Islamic finance has been phenomenal especially in 2007 the global *sukuk* issuance remained about USD49 billion. The year 2008 and 2009 witnessed a decline in the growth of *sukuk* issuance which was USD18.6 billion and USD25.7 billion for the years of 2008 and 2009, respectively (IIFM *sukuk* Issuance Database, 2001-2010). The following Figure (2.18) displays the total value of global *sukuk* issues during the period of 2001-2010.

Figure 2.18: Global Sukuk Issuance (in all currencies)

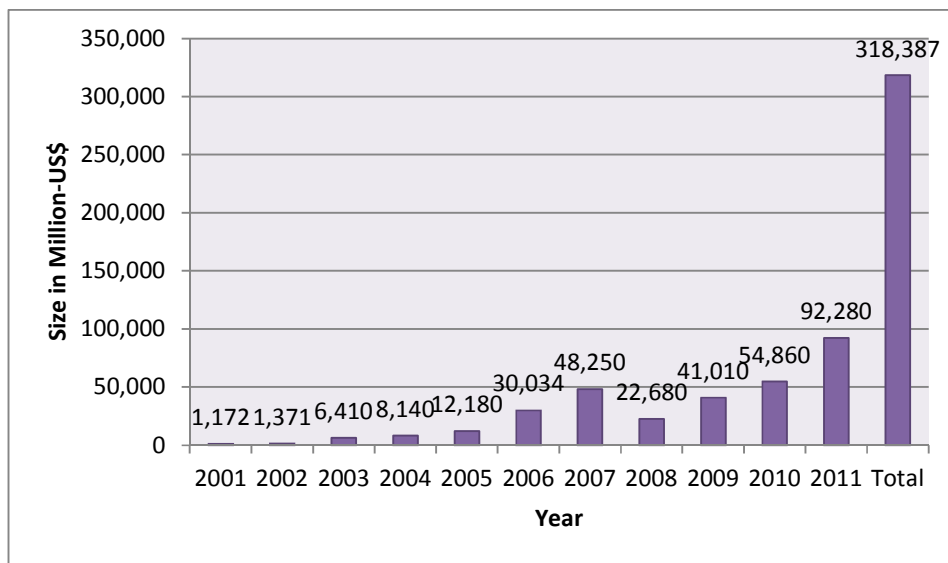

Source: IIFM Issuance Database, 2001-2010

The year 2010 witnessed global *sukuk* issues of over USD 45 billion (IIFM Sukuk Issuance Database, 2001-2010) mainly due to Malaysian domestic *sukuk* issuances but the international *sukuk* market is trying to regain its momentum.

Jain (2001) promotes the use of securitisation within emerging economies arguing securitisation has yet to reach its potential. He rightly points out that emerging economies are bank centric systems with banks primary originators of loans with no competition and are generally associated with weak institutional infrastructure. The links between traditional banking sector and financial markets is weak. Contrasting this with the situation, the USA economy's structure and also the UK's is very much stock market centric characterised by strong institutional infrastructure. Jain (2001) argues that concentration of systematic risk through heavy intermediation by the banking system has eroded the underlying fundamentals of economic growth.

Conventional securitisation is virtually absent in Islamic countries, where Islamic home finance and *sukuk* provide a potentially untapped market for structured finance. Islamic securitisation complements the conventional ABS universe as an alternative and more diversified funding option that broadens the pricing spectrum and asset supply as high demand for alternative investment products causes' greater lending width amid a low

yield market environment. *Sukuk* is an Islamic financial tool that is revolutionising emerging markets in Islamic countries. In the Gulf co-operation countries and Malaysian experiences there is an explosion of growth in the *sukuk* arena. There are considerable benefits and needs being met by *sukuk* at different levels of institutional, governmental and investor. Singer (2001) suggests that among the advantages for emerging economies from securitisation include the benefits of origination capacity within the banks, furthering liquidity from almost any asset class, increasing disintermediation within the financial system and encouraging additional investor participation (Singer 2001). Jain (2001) identifies additional reasons for securitisation in emerging countries. As there is usually a shortage of traditional lenders, deficiencies in credit quality and a desire for yield amongst investors, securitisation's ability to create liquidity through new product innovation benefits all market participants. Originators have the ability to sell assets easily and increased capacity to provide funds. Investors have access to high-yield securities, liquidity and diversification.

For IFIs including *sukuk* it addresses short and long-term liquidity management amongst other benefits. For governments, *sukuk* is also viewed as a developmental tool and an avenue for raising and attracting Foreign Direct Investment (FDI) through sovereign and corporate *sukuk* issuance arising from difficult macro-economic conditions. It is also a product that is attractive and understandable to conventional institutions. A conventional bond is well-known concept and area of practice for global financial systems.

Globalisation from an economic perspective is associated with international financial integration, increased financial liberalisation, reduced barriers to trade liberalisation, FDI, amongst other aspects (Agenor 2004). Globalisation is seen as a vehicle for capitalism (Wallerstein 2001).

They primarily advocate the positive economic aspects of globalisation. Less emphasis is placed on the social impact. An immediate issue in this regard is that of financial regulation and the challenges it presents at a national and international level with financial market liberalisation and integration, removal of trade barriers and the political strength of the multi-national corporations. A key issue and not just at the

macroeconomic level, is that of the governance of globalisation. Some argue that a world-government dominated by hegemonistic Western powers should be resisted (Hart and Parakash 2000). The economic, political, cultural and technological factors of globalisation operate simultaneously in parallel, each influencing the other and redefining its scope and depth. The intensity to which is reflected by the context. Complex forces are at work. It is a dynamic process of shifting concepts incorporating predictive uncertainty. Globalisation is a collective series of processes of multi-faceted phenomena, that are arguably not to be considered functionally nor in isolation from each other (Giddens 1999). Some of globalisation's characteristics include integration of economies, blurring of the boundaries of nation-states, developments in technology, redefinition of processes and crucially that of homogenisation of values. However, paradoxically it can also lead to a simultaneous characterisation of the opposite for example, the heterogenisation of values that are local. Figure 2.19 provides a sketch of economic conditions in GCC and Middle East and North Africa (MENA) countries.

Figure 2.19: Underlying Economic Conditions in GCC & MENA

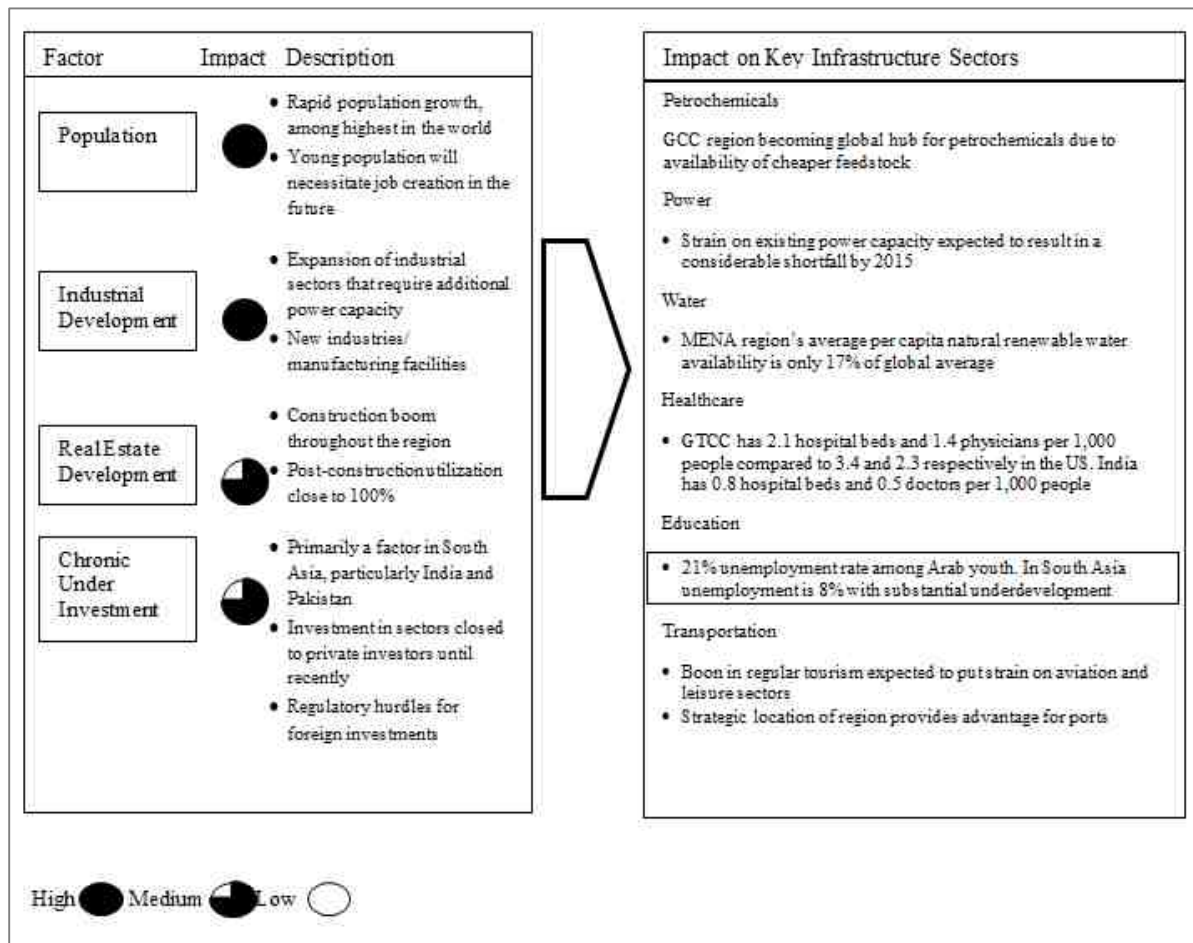

Source: Abraaj, 2008

Muslim countries have not been experiencing transformational changes in Gross Domestic Product (GDP)/Gross National Product (GNP) or indeed in terms of industrial diversification and structure. Their growth rates are reflective of global averages. The distribution between agriculture, industry and services sectors (as well as between public and private sectors) remains generally consistent. The services sector remains weak compared to developed countries and the OIC-LC economies are particularly agriculture based. Hence, if these factors are associated with spill-over effects of capitalism and globalisation, then it clearly has not occurred to date.

Jobst (2007) comments on the underdeveloped debt markets in Islamic countries and finds that, securitisation is at a modest level due to (i) deficient legal frameworks and

accounting standards for structured finance; (ii) regulatory rigidities; (iii) poor market practice, standards of origination, trading, and investor protection; as well as (v) an under-developed local institutional investor base.

In emerging markets, securitised issuance and investment activity is generally hampered by problems of limited and narrow asset supply, light prudential standards in terms of disclosure and transparency requirements, and the absence of enabling regulation. In many countries, these characteristics have prevented the emergence of a mature investor base, a sound credit culture and market practice, established standards of investor protection, and the equitable tax treatment between structured finance and conventional investment products. Also problematic is a lack of data on corporate defaults in emerging markets, which hinders issuers from deriving reliable estimates for default probabilities and recovery rates from the structuring of transactions. Also high execution costs, structural complexity and the potential principal-agency problems between issuers and investors as well as administration, collection and fraud risks have tempered the growth of securitisation in underdeveloped capital markets.

Investors' tolerance for risk from emerging economies is relatively low. By addressing structural issues in capital market development, investor confidence could be raised. In addition to creating supply and demand through the stakeholders or securitisations such as originators, investment bankers, rating agencies and investors require enabling conditions. These include a strong legal framework (to ensure enforcement mechanisms), stable currencies, favourable tax treatment, credible ratings, strong corporate governance and institutional infrastructure. This also includes appropriate levels of support for primary markets to allow for innovations and the creation of secondary markets (Jain 2001). Securitisation helps accommodate a growing investor base, particularly pension and insurance fund investors with the need of long-term, highly-rated local currency bond investments to match their liabilities. Thus, it improves risk diversification within the financial sector; increases overall financial sector sophistication and contributes to the development of a more liquid yield curve in poorly developed financial systems.

2.10.2 MARKET BEHAVIOUR

The *sukuk* industry is characterised by buy and hold strategies of investors. This is due to the shortage of assets available to investors that have been permitted by *shari'ah* scholars. Consequently, whatever is available is normally oversubscribed and retained to identify the quality of an asset pool for other investors (if for example, held by banks and other IFIs).

These buy and hold strategies as well as the excess short-term reserves (also from the lack of sufficient long-term reinvestment opportunities), have inhibited efficient financial intermediation and capital-market deepening (Rosly and Sanusi 1999). Malaysia is the most liquid market for *sukuk*. In the GCC there is limited secondary trading for *sukuk* as investors buy to hold.

Wilson (2008) suggests that empirical evidence from Malaysia indicates that financial factors are more important than religious factors in determining the choices between Islamic and conventional securities, even for Muslim dealers. This is correlated by Ernst and Young (2007) where only 20% of the possible investor base is likely to purchase Islamic only products out of ideological allegiance.

Important decision-making criteria involving behavioural traits have been empirically shown to have an adverse impact in the sphere of Islamic finance (Dar 2002). Iqbal and Llewellyn (2002) recognise several behavioural problems within Islamic financial systems. These include the problem of information asymmetry and high costs to reduce it, adverse selection in verifying intentions and the impact of moral hazard.

Adverse selection in equity contracts may occur before the contract, whereby the potential entrepreneurs who are most likely to produce an undesirable outcome are the ones who most actively seek out a contract and thus more likely to be selected. Equity contracts are subject to moral hazard after the contract takes place and refers to the hazard that the agent has an incentive to engage in activities that are undesirable or not in the best interest of the contract.

Moral hazard and adverse selection issues have hindered the use of PLS activities in Islamic Finance (Dar 2002). Informational asymmetry to those seeking finance or acting as managers has been recognised as a problem. It has also driven banks to promote short-term fixed return selling. Dar argues rational economic agents everywhere will try to exploit the loopholes in a legal and regulatory regime and not just because it is Islamic.

The nature of the *sukuk* investor base is increasingly diverse. The first Islamic sovereign securitisation in Malaysia was issued in February 2005 by Pasir Gudang local Authority as a *mudarabah sukuk* on RM80 million (USD18 million) of future property tax revenues. Although it was widely assumed that Muslim investors had bought most of the *sukuk* bonds, non-Islamic institutional investors turned out to drive most of the demand of the heavily oversubscribed issues. This has been the case for many other *sukuk* issuances also.

For the success of *sukuk* to occur, the high demand and supply forecasts amongst Muslims will need to appeal to non-Muslims (DiVanna and Strategies 2007). The positioning of Islamic Finance as ethical funds might be of further benefit needs to be examined (Wilson 2008).

It is recognised that financiers wish investors to regard the *sukuk* as identical to their equivalent conventional asset classes rather than being distinctive from a financial perspective. This simplifies risk assessment as investors prefer a security with a familiar structure rather than being unknown and untried.

2.10.3 THE GLOBAL SUKUK MARKET

The *sukuk* is revolutionising the field of Islamic finance and global markets *sukuk* funds are increasingly occupying central importance in the current experience of many Muslim governments and IFIs including Islamic banks. The global *sukuk* market issuance has exhibited phenomenal growth. It has increased from USD1billion a year in 2001 to USD 92.2 billion in the 2011 (IFIS, 2011)

Year 2011 had a constant supply of *sukuk* and year 2012 is following the pursuit. The fact that there is a Eurozone crisis still going, *sukuk* supply remained increasing while trying

to regain its momentum which was disturbed due to the financial crisis (Khan 2011). In the year 2011 its supply reached to USD36.3billion which was USD17.5 billion in 2010 (ibid). The first quarter of 2011 remained strongest in terms of *sukuk* supply with Malaysian USD 1.6 billion; Kuwait USD 200 million; Saudi Arabia USD 266 million and UAE USD 500 million of *sukuk* supply (ibid).

In 2010, the improvement in the performance of *sukuk* gained momentum after Dubai World *sukuk* restructuring and unexpected hikes in oil prices and market saw *sukuk* issuance of various maturities which is a sign of improvement in their maturity profile (ibid). Malaysia is still taking the lead. *sukuk* from financial and government sector with a remarkable share from real estate is on the rise (ibid).

Due to better yield on offer, *sukuk* is likely to have advantage over conventional bonds. There is a strong demand of *sukuk* from Islamic and conventional investors which is evident from the recent oversubscribed *sukuk* issues and impressive issuance amounts on sovereign *sukuk* (ibid).

Though political unrest in the Middle-East, USA debt downgrade and Eurozone financial crisis is problematic which may affect *sukuk* growth in 2012 but recent *sukuk* issues especially from Bahrain is a positive sign from the market (ibid).

Since the first quarter of 2011, there was a sign of substantial decline in *sukuk* yields, which shows high demand for *shari'ah* compliant instruments. Hence, *sukuk* returned a healthy 3.18% in the 2nd Quartal 2011, up 2.3% year on year (ibid). since reaching a recent record lows in early August, *sukuk* yields jumped again on the back of a more general market risk aversion and the Eurozone crisis with yields have hitting a four-month high in early October 2011 (ibid). Hence, over the Quarter three *sukuk* have only returned 0.4%, down 4.5% year on year (ibid).

In 2011 there was a record issuance of *sukuk* of the amount USD 92.2 billion as compare to the year 2010 which was USD 54.86 billion which means 68.2% increase over 2010. In 2011 *wakalah* structure *sukuk* was issued as a new structure entry in the market with the issuance of Malaysian government sovereign *sukuk* denominated in

USD of USD 2 billion and the practice was followed in the Gulf by Kuwait's Gulf Investment Corporation with the issuance of *sukuk al-wakalah bi al-istithmar* of RM 3.5 billion for a term of 20 years.

As stated earlier due to unrest in the Arab countries there was negative effect on the financial markets. For example in the first quarter of 2011, *sukuk* issuance was dropped from USD12.7 billion in January to USD10 billion in February and finally to USD8.2 billion in March.

Despite the financial instability in the world there comes the question whether Islamic finance is a solution to such situations and can it survive as an industry? Due to the change of governments in the Arab countries, conservatives are taking the control of the governments who will tend more towards Islamic financial system. Further, countries in need of investment are trying to attract investors from the Middle-East and to achieve that goal these countries are offering Islamic financial instruments. Boom in oil price is another reason for the popularity of Islamic finance and investors from the troubled countries suffering from financial crisis like Eurozone countries' investors would go for safer investment opportunities, which these countries lack and the alternate is Islamic finance.

After the financial crisis *sukuk* market has shown a sign of recovery. This may be evident from the latest intention of the Hong Kong and Shanghai Banking Corporation (HSBC) Holdings to issue USD5 billion *sukuk* which it planned three years earlier but could not transform the idea into practice due to financial crisis (Shah 2011). HSBC Bank Middle East has issued the biggest *sukuk* by any non-Islamic financial institution in last June (ibid). The *sukuk* issuance is worth USD500 million for five years which are priced to yield an expected 3.575 percent (ibid). Similarly, in May, 2011, Sharjah Islamic Bank, issued USD400 million of *sukuk* yielding 4.75 percent (ibid). IDB issued *sukuk* worth USD750 million at 2.35 percent (ibid). The Palestine Monetary Authority had in the pipeline to issue *sukuk* worth USD50 million (ibid).

This recovery in the economy is due to the reduced cost of capital which is matched with the financial growth rates (ibid). Further, small number of *sukuk* issues during the

financial crunch caused some demand for investment opportunities such as *sukuk* and this lack of issuance decreased the yields for borrowers (ibid). Despite some of the major defaults in the *sukuk* market, it is gaining its upward momentum and restoring its investors' trust (ibid). One of the major defaults in the recent past were the USD100 million *sukuk* default of Investment Dar, Kuwait in 2009; Saad Trading Contracting and Financial Services Co., Saudi Arabia defaulted on its USD650 million *sukuk*; and Dubai World is also recovering from its debt crisis which is evident from its recent intention of restructuring its Nakheel *sukuk* and after getting credit injection from Abu Dhabi (ibid).

Better supply of credit and the market developments as discussed are helping in building investors' confidence (ibid). There are various *sukuk* maturities that are coming up this year and next (ibid). There is a dearth of supply and Dubai credit is in better shape following the Dubai World resolution (ibid). There is a feeling amongst banks that the worst of the provisioning is behind them (ibid).

HSBC-Nasdaq Dubai GCC *sukuk* index, those *sukuk* issuances in the GCC which are denominated in dollar were yielding about 4.6 percent in early June, down from about 6 percent three months earlier (ibid). On the contrary the GCC conventional bond index was yielding 4.9 percent in June (ibid). From January, 2011 to June, 2011 the whole *sukuk* issuance has gain the unprecedented height of USD40.9 billion which was USD14.2 a year before (ibid).

Malaysia is main contributor of Islamic finance growth industry and its share of the *sukuk* market is enormous so far (ibid). The share of GCC *sukuk* till June 2011 is USD12.8 billion which is far greater figure than the figure for the whole year of 2010 i.e., USD6.9 billion (ibid). The most significant of *sukuk* issuances was a three years term *sukuk* issue of the Qatar Central Bank of USD9 billion (ibid).

The market recovery in GCC makes it significant unique despite political situation in the Middle East such as Tunisia, Egypt, Bahrain and Yemen etc (ibid). The Arab Spring protest movement has shaken regimes across the region but it has not impeded a recovery in the *sukuk* market (ibid).

Muslims as a matter of belief are inclined towards Islamic banking but conventional investors are also attracted to invest in Islamic financial products and *sukuk* being the most popular of these products (ibid).

A major problem in the course of *sukuk* issuances were faced by *sukuk* investors was the transfer of assets from borrower to *sukuk* holders (ibid). Most of the *sukuk* issuances in GCC were based on a sale of assets from borrower to a SPV which issues *sukuk* to investors representing their entitlement to the *sukuk* assets. The SPV in order to generate income from *sukuk* assets lease these assets back to the borrower/originator for a periodic rent payment payable to *sukuk* holders (ibid). But in the event of default when recourse was made to these properties it was revealed that the transfer of these assets in the name of *sukuk* holders was not registered with UAE land registry, which was a requirement in order to make a sale effective and enforced without which the sale is void (ibid).

In addition most of the *sukuk* in the market (about 90 percent in 2011) were sovereign or quasi-sovereign *sukuk* with a small portion of corporate *sukuk* (ibid). In order to get the full benefit of the market there is a need to develop an efficient market and it is possible with the involvement of the corporate sector (ibid). Therefore, there is a need to encourage corporate *sukuk* in the market (ibid). Creating larger banks may be proved helpful in this regard (ibid).

In order to save cost on *sukuk* deals standardisation is emphasised (ibid). Every time a *shari'ah* product is introduced in the market, *shari'ah* scholars have to issue *fatwa* on that product which undermine the efficiency of the product by increasing its cost (ibid). Therefore, for efficiency in terms of cost standardisation is highly encouraged as is the case in Malaysia (ibid). The Hawkamah Institute for Corporate Governance, Dubai in collaboration with International Islamic Financial Market (IIFM) is working to standardise *sukuk al-ijarah* for the obvious reason of reducing cost and bringing efficiency (ibid).

As stated earlier Malaysia has good *sukuk* market and as on June 2011, it has raised USD 24.95 billion from the issuance of *sukuk* (ibid). Malaysia, through its central bank Bank Negara Malaysia, has already standardised documents pertaining to Islamic finance products such as *sukuk al-ijarah* leaving no space for negotiation (ibid). On top of that,

shari'ah Advisory Council, a centralised body, grants approval whether or not a product is *shari'ah* compliant (ibid).

Standardisation is important for reducing cost of a deal but it has not much role in attracting potential investors e.g., recent *sukuk* issues in GCC were oversubscribed despite lack of standardisation (ibid).

Credit rating of a corporate issue is important which in GCC is most of the time is being conducted by investors on their own unlike Malaysia where credit rating agencies conduct this rating on behalf of investors through a standard setting procedures (ibid). The difference between Malaysian and Gulf *sukuk* is the currency denominator, Malaysian *sukuk* are in their local currency while most of the Gulf *sukuk* are in dollar, which make them attractive internationally (ibid).

Bahrain has a strong centre for Islamic finance market due to the fact it has IIFM and the AAOIFI (ibid). Besides its Central Bank has a very strong regulatory regime ensuring investors' protection. Bahrain presented with a USD 530 million sovereign *sukuk* in April 2011 (ibid).

The Kingdom of Qatar, which has raised about USD 1 billion *sukuk* in 2011, has stopped conventional banks' Islamic window operations for the reason of mixing of Islamic funds with that of interest-based funds. This will definitely help in strengthening of Islamic finance there (ibid).

Oman, another country on Arabian sea, in May 2011 permitted Islamic banking and finance operations in the country for the first time (ibid).

Egypt is the fifth most populous Muslim country with a population of 50 million people, is also opening doors for Islamic finance after the regime change there last year (ibid). In the mid of the nineteenth century Egypt took an initiative towards Islamic banking but unfortunately it was banned in later years. Islamic banking in Egypt comprises 4% of its total banking industry of USD 193 billion (McKinsey & Co, 2009) and its share in the UAE banking market is 46 percent (ibid).

Egypt can provide portfolio diversification with more choices to the Islamic investors (ibid). Egypt has already a link with the Gulf as Abu Dhabi Islamic Bank has the ownership of National Bank for Development, Cairo and it is being converted into an Islamic bank (ibid). In June 2011, Financial Supervisory Authority, Egypt showed its willingness to amend its laws to accommodate *sukuk* (ibid). There is a need to amend tax laws in order to avoid double taxation in the course of a *sukuk* transaction such as *sukuk al-ijarah* or *murabahah* structure (ibid). This will bring *sukuk* into an equal footing with other conventional products and commercially more viable (ibid). Indonesia has already made amendments in its tax laws in order to remove double taxation from *sukuk* (ibid).

That holds true for other places hoping to grab a piece of the Islamic investing pool, including Russia and West African countries such as Senegal (ibid). VTB Bank, Russia's second-largest lender, plans to come to market later this year with a USD 200 million *sukuk*, bankers say, while Gazprombank, the lending arm of the giant Russian oil and gas producer, is in discussions with about ten Moscow companies to arrange *sukuk* and plans to meet with investors in the Gulf in September. In more-remote countries, originators or industries want to tap the Muslim wealth from the GCC (ibid). Even a company in Russia or Australia, is trying its best to attract the huge amounts of wealth, by issuing *sukuk* (ibid).

2.11 CONCLUSION

This chapter describes securitisation both in conventional and Islamic finance and defines *sukuk*. Under *shari'ah* how *sukuk* are structured are given in detail with comprehensive literature survey. Besides giving structures of *sukuk*, it provides current market situation of *sukuk* as well. The chapter strongly develop the argument in favour of *sukuk* securitisation.

The Islamic banking and finance has received popular public attention since its revival in the 1970s. Islamic financial system is based on *shari'ah* principles encompassing the welfare of the people in this world and in the hereafter based on a just society. To achieve the objective of a just society, it prohibits *riba* (interest or usury) and *gharar* (risk and speculation). It provides an ethical system where trade related to non-permissible

activities like, alcohol, tobacco, pornography is not allowed. PS (*mudarabah*) and PLS (*musharakah*) are preferred modes of finance over fixed-return modes such as *murabahah* etc. In addition, there are exchange contracts based upon a deferred trading principle such as PDS (*salam*), object deferred sale (*istisna'*) and OPDS. These have relevance to Derivatives and *sukuk* forms leading to an effective securitisation mechanism in Islamic finance.

The benefits of securitisation are many such as, it provides an improved access to funds at the least possible cost of funds; it removes a specific pool of assets from the firm's balance sheet with a view to improve returns on debt or equity; and it frees up working capital for further core business.

Securitisation is a popular method of structured finance that is gaining increasing grounds in Islamic finance through its popular securitisation instrument known as *sukuk*. *Sukuk* may have features of a debt instruments but it cannot rely on or involve interest. *Sukuk* are only appropriate for Islamically acceptable activities. *Sukuk* are among the best ways of financing the large enterprises that are beyond the ability of a single party to finance. *Sukuk* provide an ideal means for investors seeking to deploy streams of capital and who require, at the same time, the ability to liquidate their positions with ease whenever the need arises. For governments, *sukuk* is viewed as a developmental tool and an avenue for raising and attracting FDI through sovereign and corporate *sukuk* issuance.

Sukuk is a securitisation instrument but in the Muslim world securitisation is at a modest level due to certain reasons such as: (i) deficient legal frameworks and accounting standards for structured finance; (ii) regulatory rigidities; (iii) poor market practices, standards of origination, trading, and investor protection; and (v) an under-developed local institutional investor base.

However, the economically and financially developed world and the world in general, the *sukuk* industry is witnessing some of the hurdles. For example there is a buy and hold strategy by the investors because of the shortage of assets available to investors. Consequently, whatever is available is normally oversubscribed and retained till maturity. A major problem in the course of *sukuk* issuances were faced by *sukuk* investors was the

transfer of assets from borrower to *sukuk* holders. In the event of default when recourse was made to these assets by the *sukuk* holders, it is revealed that the transfer of these assets in the name of *sukuk* holders is not registered with the land authorities, which is a requirement in order to make a sale effective.

In the market the most of the *sukuk* are sovereign or quasi-sovereign with a small portion of corporate *sukuk*. Therefore, there is a need to encourage corporate *sukuk* in the market. Islamic financial industry is lacking standardisation with which cost may be saved on *sukuk* deals. For example every time a *shari'ah* product is introduced in the market, *shari'ah* scholars have to issue *fatwa* on that product which undermine the efficiency of the product by increasing its cost. Therefore, in Islamic finance factors like these inhibit an efficient financial intermediation and capital-market deepening.

Despite all these drawbacks, Islamic finance is growing in the world such as in Bahrain, Qatar, Dubai and Saudi Arabia are good examples from GCC and UK is good example from the West. Malaysia has already a proven pioneer in Islamic finance. Further, Oman has permitted Islamic banking and finance operations in the country for the first time. Egypt is also opening doors for Islamic finance after the regime change. Indonesia has already made amendments in its tax laws in order to remove double taxation from *sukuk*. That holds true for other places hoping to grab a piece of the Islamic investing pool, including Russia and West African countries such as Senegal. Australia, is trying its best to attract the huge amounts of wealth, by issuing *sukuk*.

As stated earlier, Islam seeks to bring about justice and fairness. Islamic economics is one avenue for this and is concerned with bringing *falah* or well-being for the whole of mankind. Islamic finance is visualised as a means for correcting the imbalances caused by working of the conventional interest-based system which is considered to cause inequality both in developing and developed countries. But mechanisms used in *sukuk* today, however, drift away Islamic finance of its objectives and render the *sukuk* exactly the same as conventional bonds in terms of their economic results. The Islamic finance industry's emphasis on the forms of financial transactions rather than their substance may result in Islamic financial practices violating the spirit of Islamic Law. For the *sukuk*

industry there is a need for a more principles-based approach rather than rules-based approach to *shari'ah* compliance.

CHAPTER 3

LEGAL AND SHARI'AH COMPLIANCE ISSUES IN RELATION TO DERIVATIVES AND SUKUK

3.1 PRODUCT DEVELOPMENT IN ISLAMIC FINANCE

Financial Engineering is defined as: “design, development and implementation of innovative financial instruments and processes, and the formulation of creative solutions to problems in finance.” (Finnerty 1988 and 1994) Financial engineering involves to attain best results with the least possible transactions costs (Merton 1992). All innovations through financial engineering employ some sort of techniques and these are more important than the innovation itself. These techniques and strategies may be termed as “lateral thinking” (D. Bono, 1973). Now financial engineering may be amended to define as tools and techniques for developing new products and instruments (Mason et al.1995).

In Islamic finance, *shari'ah* principles are followed for product development in the process of strategy and technique formulation but it does not close creativity in the society Allah (S.W.T) provides opportunities to the mankind for creativity by inviting them to think on the signs of truth. In this creativity process *shari'ah* comes with some restrictions and some checks which limits the choices. Therefore, there arises need to devise new techniques (Elster 2000) and few choices turns into many (Gigerenzer et al.1999; Sibling 1983). This approach is solution based approach, which solves the problem and it comprises processes, instruments, or products and involves low cost with efficient results (Merton 1992). Therefore, for financial engineering economic efficiency is important rather than mathematical designs. (Mason et al. 1995).

With the involvement of increasing number of global agents in economics, new laws were formulated to regulate these activities. As a consequence, these economic agents

tried to devise new techniques and products to escape from the effects of these regulations (Miller 1986). This leads to new product development such as derivatives in order to avoid the consequences of these regulations. Derivatives are innovation in financial world and experts including academics consider these as harmful inconsistent with Schumpeterian view of creative destruction which it may be asserted that requires the change in techniques and strategies (Leathers and Raines 2004). But free-market advocates think these innovations are to make markets efficient which were being disturbed by different sorts of regulations (Partnoy 1997). Benefits of regulations cannot be denied as financial markets have witnessed many disastrous financial crises in the recent past such as 2008 financial crisis and crisis at Enron are few examples. Therefore, not following *shari'ah* principles or avoiding these principles through different devices will definitely harm the society in both moral and financial sense.

The financial-services industry is on the decline now because there is no financial innovation rather these are involved in a “zero-sum game,” which one’s gain at the cost of the other (Drucker 1999). Derivatives are the only invention in the recent past, which according to him are allegedly scientific and not more scientific than systems used in Monte Carlo or Las Vegas. “As a result, the industry’s products have become commodities and increasingly both less profitable and more expensive to sell.” There are three possible course of actions: (i) to keep the system as it is, which definitely leads at some point to collapse; (ii) a new system by newcomers and outsiders; and (iii) the industry should itself bring a change and become innovators themselves and their own ‘creative destroyers’. Islamic industry at this point can come forward with its economic and financial philosophy to fill the gap as the second option suggests.

Islamic financial engineering may be based on four principles: principle of balance; principle of integration; principle of acceptability; and principle of consistency. Principle of balance is based on cooperation unlike a capitalist society based on self-interest (Askari et al. 2010). For example Islamic economics’ principles of payment of *zakah* and prohibition of *riba* are based on cooperation and not on the principle of self-interest (Suwaillem 2007). Hansmann (1996) suggests that in fact societies are mostly based on

cooperative activities rather than on profit-oriented activities. Humans relations may be divided into three stages namely dependence, independence and inter-dependence (Covey 1990). In dependence a human being survives with the help of others and in independence, he does not need anybody to survive while being inter-dependent members of a human society work together in cooperation with each other to achieve some targets, which they cannot achieve individually. This is what Islam stresses on besides accepting dependent and independent behaviour in a society.

Then there comes the principle of acceptability, which is based on the maxim that all business transactions are permitted until unless prohibited by the *shari'ah* (Suwaillem 2007). Regulations become active where a business activity unnecessarily benefits someone by harming any member of the society. Regulations prevent those who cause harm (ibid). At the same time a beneficial activity is encouraged in the eyes of *shari'ah* such as an act of charity. Therefore, the principles encourage creativity and all sorts of product development and business transactions are allowed unless there is a prohibited element in such a product or business transaction (ibid).

Examples of harmful activities may include prohibited activities of *riba* and *gharar* (ibid). *Riba* is purely a financial transaction having no connection with real transactions and growth in real wealth can only occur through real transactions. *Riba* is the cost of time and is a debt creation activity, which grows faster than the real economy at the cost of the real economy (ibid). Therefore, in *shari'ah* financial transactions are part of real economic transactions and in *shari'ah* there is no pure financing instrument (ibid). For example, in deferred sale and *salam* debt is integrated with real economic activity of sale and any cost of debt is immaterial since real transaction control the cost which consequently control the debt growth on its own (ibid). Difference between an interest on a loan and mark-up in credit sale may be elaborated by highlighting the fact that interest is a time value of money, which creates debt out of debt while mark-up is time value integrated into the real transaction in which debt is not self-replicated (ibid). Therefore, it is not the time value but debt creation without the growth of real wealth is the problem,

which harms the society. For the reasons mentioned above, it is important to regulate the financing transactions.

The principle of integration is also important in Islamic finance. Individuals for their own wealth creation through *riba* and *gharar* and these two factors drag an economy from real wealth creation to the individual wealth creation. It costs much more to the real sector for keeping these two factors apart from it making the transaction costly and inefficient. *Shari'ah*, therefore, attempts to create a balance by integration rather having a separation for efficient economic growth. Thus according to the principle of integration a loan transaction or where the counter-values are same, if performed for gain, is not allowed unless it incorporates a real component like goods, utilities or services. Despite the inclusion of this real component, there needs something more to be done. Sometime real component is used to play a trick to make a transaction valid. Therefore, this sort of integration though is legal in form but in substance lacks the real spirit of integration serving the same purpose as that of an unacceptable transaction. This is known as artifice (*hila*) in which real components are used to serve the pure financing contracts which should be, in reality, the vice versa. Such a manipulation creates controversy and leads to the debate on the tension between the letter and the spirit of the law, between form and substance of the financial product. This manipulation and debate is also found in conventional financial markets but *shari'ah* has an edge over the former for it has moral dimension. If a prohibited transaction or product is made legal using artifice, which negates Allah (S.W.T)'s commandments then this amounts to a sin deserving to be punished.

In order to make a product permissible both form and substance must be in compliance with *shari'ah*. According to Ibn Taymiyyah (1997) the companions of the Prophet (peace be upon him) were in agreement to condemn *hiyal*. According to Ibn al-Qayyim (1968) not a single Islamic jurist acknowledged all kinds of artifices. Thus, form or means cannot supersede substance or end. Further, there is an agreement of Muslim scholars that good intentions cannot justify a transaction meaning thereby ends do not justify means. This may be concluded from the above that scholars are in agreement that there should be

a balance between form and substance however they differ on the degree of consistency and not on the attainment of consistency.

Principle of consistency requires that while devising Islamic products, form and means should conform to substance and ends respectively. The principle is based on the *fiqh* maxims of “actions are based on objectives,” and “meanings supersede letters” (Ibn al-Qayyim 1968). Therefore, on the basis of this an Islamic financial product must examine the purpose or end result of the product. Thereafter, if found acceptable then one should proceed with the product development. If found not conforming to *shari'ah*, then re-work on the product to make it *shari'ah* compliant. So work on substance of a product is done prior to the work on its form.

3.2 EVOLUTION OF PRODUCT DEVELOPMENT AND ITS PROCESS

The above principle may be explained through an example. *Murabahah* and *tawarruq* are two contracts. One involves the sale of goods on deferred price. In *tawarruq*, the end result is the attainment of liquidity though it is done through the sale and purchase of real goods but in substance it is a *ribawi* loan transaction. Therefore, *murabahah* is a valid contract and *tawarruq* is controversial.

Now, as it is seen in substance *murabahah* is a valid permitted contract, it must also be processed through permitted means according to the rulings of *shari'ah* like selling without owning it etc. In *tawarruq* no matter what the process is followed according to *shari'ah*, if the end is not legitimate the legitimacy of process will not help at all in labelling the contract legal and *shari'ah* compliant.

A product may be developed by imitation, mutation or satisfaction. In imitation an Islamic financial product is developed by copying a conventional product with the same result as that of a conventional one. This may also be called as reverse engineering. Examples of imitation are a financial call option has its equivalent in Islamic finance is *'urbun*; interest rate swap has its Islamic counterpart as reciprocal *tawarruq* and reversed *tawarruq*, with different mark-up structures; a conventional interest loan may be

replicated in Islamic finance into *tawarruq* or *'inah*; and time deposits has their replication in Islamic finance as reversed *tawarruq* etc.

This strategy is not recommended because this promotes form over substance and means over ends policy and not benefiting from the true spirit of the *shari'ah*. Further, imitation is actually the adoption of conventional economy products serving their objects and *shari'ah* is observed in form without its substance. This makes *shari'ah* subservient to conventional without any innovation and creativity which is the essence of financial engineering. Another disadvantage of this policy is that *shari'ah* is observing the objectives of conventional finance with its additional constraints without any improvement in the value of the objective function of the conventional product. It would be more beneficial if objective function is derived from the *shari'ah* rules and devising a financial product with optimal function. In the last, this replication of conventional products by the Islamic financial industry would bring in the same problems as that of conventional financial industry.

In mutation acceptable products are developed based on *shari'ah* principles. Thereafter based on their usefulness superior products are retained and the poor ones are abandoned and this process continues until a perceived perfection is achieved. This phenomenon is known as 'genetic algorithms'. An 'evolutionary algorithm' maintains a population of solution candidates and evaluates the quality of each solution candidate according to a problem-specific fitness function, which defines the environment for the evolution. New solution candidates are created by selecting relatively fit members of the population and recombining them through various operators. Specific evolutionary algorithms differ in the representation of solutions, the selection mechanism, and the details of the recombination operators (Allen and Karjalainen 1999). A 'genetic algorithm' starts with a population of randomly generated solution candidates. The next generation is created by recombining promising candidates. The recombination involves two parents chosen at random from the population, with the selection probabilities biased in favour of the relatively fit candidates. The parents are recombined through a 'crossover' operator, which splits the two genetic structures apart at randomly chosen locations, and joins a

piece from each parent to create an 'offspring' (as a safeguard against the loss of genetic diversity, random 'mutations' are occasionally introduced into the offspring). The algorithm evaluates the fitness of the offspring and replaces one of the relatively unfit members of the population. New genetic structures are produced until the generation is completed. Successive generations are created in the same manner until a well-defined termination criterion is satisfied. The final population provides a collection of solution candidates, one or more of which can be applied to the original problem (Allen and Karjalainen 1999).

The last strategy is based on customer satisfaction. In this strategy, products are developed according to the wishes and satisfaction of the customers. This strategy and strategy of mutation are opposite to each other their methodology but both complement each other. This strategy shows how customers determine the market and market evolve naturally and economic progress is measured by satisfying customers' needs. Here it can be seen that ends determine means. For example if a customer needs cash and apply for it to a bank but his ultimate desire or need is to buy a car. Here is real need is to buy a car and Islamic finance which, links pure finance with real financial transaction will go for the purchase of car rather than giving the customer cash. Similarly, if need of the customer is to pay an existing debt, the Islamic bank would go for the payment of debt by paying to the creditor rather than giving cash to the customer and satisfy his real needs.

It has been argued that money is a veil. Thus, eliminating money will lead one to the reality and ultimate objective of economic transaction, which is the real transaction. In present day society electronic money (Shiller 2003) is being used leading one directly to the real transaction removing the middle step of obtaining cash, which is a step forward to integrate financial sector with the real sector, This is in compliance with *shari'ah* principles proving that Islamic finance is potentially more efficient than conventional finance (Al-Jarhi 2002). In other words, financing real transactions of customers is the ultimate alternative for lending and *tawarruq* products alike.

The argument is that credible Islamic instruments are likely to be more efficient than conventional ones. The Islamic industry however needs to review applied strategies for

product development to take full advantage of such efficiency. After arguing in favour of product development in Islamic finance, the following paragraphs will discuss the legal and *shari'ah* related issues with reference to derivatives and *sukuk*.

3.3 SUKUK AND DERIVATIVES

Derivatives are innovation in financial engineering and these are financial instruments, whose value is dependent on the value of another instrument or underlying asset. For example, stock option is a derivative whose value is dependent on an underlier namely a stock. In derivatives, a derivative may further be the cause of creation of other derivative products or exotic instruments through unbundling it. For example, a bond instrument may be unbundled into credit tranches, principal strips, interest-only strips, interest differential strips and the interest strip may be swapped against another interest index. Therefore, products are multiplied and a primary product gives rise to as many derived product as could be derived and making the gap wider and wider between the primary product and the last derived product. Primary and its derived products are traded separately in the market. Derivatives may be comprised of rights or claims or notional assets such as a stock option or warrant is a right whereby a stock can be acquired if it suits to the party concerned like price and demand etc. In derivatives, actually a risk is transferred from the risk seller to the risk taker in the hope of gaining some profit out of the deal like price risk (Bruyère and Cont 2006). How they transfer risk is complicated and frequently misinterpreted (Williams 2011). Derivatives have also been associated with some spectacular financial failures and with dubious financial reporting (Choudhry and Landuyt 2010 and Stich 2008).

Derivatives imply speculation (*maysir*), uncertainty and ambiguity (*gharar, jahalah*), exploitative - Zero sum game - (*zulm*), and high leverage - interest - (*riba*) (Mohamad and Tabatabaei 2008). Derivatives are criticised for their association and link with some of the major financial crisis in the recent history (Bruyère and Cont 2006). Failures like Baring bank in 1995 and in 1998, the derivatives' speculative activities caused the fall of the Long Term Capital Management (LTCM) capital from USD4.8 billion to about USD 600 million (Salvatore 2004). As a result of the LTCM's failure the world stock

markets fell by 11% and FED has to sponsor a rescue plan by offering about USD3.6 billion into the company by a consortium of banks (Federal Reserve Bank of Chicago 2006;IMF 1998). Enron is another example in 2001 which was hit by the financial crisis and the main blame lies on derivatives and concerns were raised about counterparty (credit) risk and financial reporting (Sterling 2002and USA 2010). And now finally the current financial crisis is another example of the consequence of use of derivatives imprudently (GB HL 2010).

Sukuk are instruments, which also derive their value from an underlying tangible asset so these are derivative like instruments (Marcinkowski et al. 2011). *Sukuk* are different from Bonds, shares and conventional derivatives but these are the same as conventional securitization hence may fall under the definition of derivatives with some unique qualities (Omar et al. 2013;Gannon 2009). It may be important to determine whether or not *sukuk* may be regarded as equal to "Securitisation" as it is understood in the conventional meaning. Securitisation is the packaging of loans into pools and converting these into marketable securities representing ownership in the pool and which are offered for sale in the public (Chandra 1984). In the process of securitisation, following issues pertaining to *shari'ah* are important.

3.4 SUBJECT-MATTER AS COUNTER-VALUES

This part will explain the importance of the existence of the subject-matter of sale at the time of contract. This is an accepted rule that the object of sale must be deliverable (Iqbal 2009). A discussion will be made on the seller's liability to deliver the object of sale and on and on the sale of the unseen (*bay' al-gha'ib*). Similarly, we will reflect on other related areas such as deferred sales (*bay' al-mu'ajjal*), debt clearance sale (*bay' al-kali bi al-kali*)¹ in the light of the Qur'anic evidence on deferred contracts of exchange. The topic of subject-matter has three issues to be discussed vis-à-vis., the existence of the subject-matter of a sale; the sale of the unseen; and the seller's ability to deliver the object of the sale (Iqbal 2009).

¹Detailed discussion on *bay' al-kali bi al-kali* is given under the heading Debt Clearance Sale at page 159.

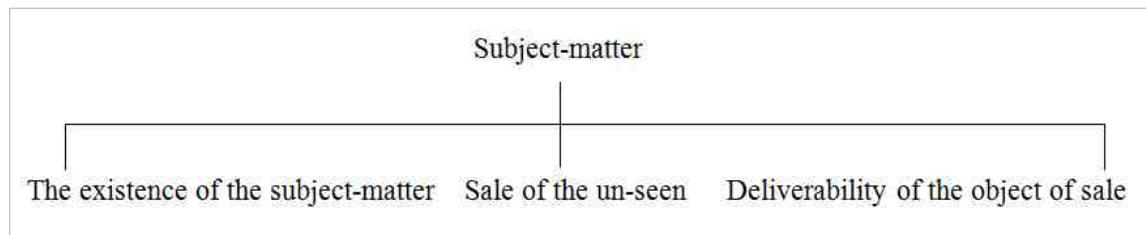
Figure 3.1: Issues Pertaining to Subject-Matter

Source: Author's own

3.4.1 THE SUBJECT-MATTER

Muslim scholars have held that one of the elements of a valid contract is the existence of the subject-matter at the time of contract (Iqbal 2009). Therefore any sale of a non-existent object (*bay' al-ma'dūm*) is not allowed and if so held will be declared null and void without considering the fact whether this non-existence is temporary or permanent (Cizakca 2012). Similarly, the sale of a subject-matter of whose existence is in doubt, is also invalid (Ibn al-Humam 1970; Ibn Qudamah, 1969). For example, milk in the udders of a cow or the sale of fruit on a tree prior to its actual existence and hence appearance (Hassan1997; Vikør 2005). In the case where subject-matter is not existed, the effect of a sale i.e., the transfer of ownership, is abstract and invisible. Therefore, at the time of conclusion of contract of sale, its effect must be attached to something already existed or existed at the time of the conclusion of the contract. However, where the subject-matter of a sale comes into existence in future (e.g., usufruct in the case of *salam* and labour in the case of *istisna'*), sale is allowed. Majority of the jurists consider the contract of *salam* and *istisna'* are anomalous and are exception to the general rule and these are allowed through juristic preference (*istihsan*) and subsequently through *ijma'*. For instance, in the case of *istisna'* contract, services of an architect cannot exist at the time of the contract. But there is a different view mainly presented by the Hanbali scholars Ibn Taymiyyah, his disciple, Ibn Qayyīm and also the Shafi'i jurist 'izz al-din 'bd al-salam, who have held that *salam* and *istisna'* are not exceptions and these are normal (*mūwāfiq al-qiyas*) contracts. Before them, contrary to the majority opinion, the existence of the subject matter is not a prerequisite of a valid contract. Therefore, it was held that an object may be regarded fit for a valid sale contract if it may be recognized, at the time of contract,

without any conflict and uncertainty i.e, there should not be any *gharar* (Ibn Qayyīm, 1968).

Imām Malik has distinguished between contracts of exchange (*'qūd al-mū'āwaḍat*) and contracts for gift (*'uqūd al-tabarru'*). According to him in charitable contracts there is no exchange of counter values hence the existence of subject-matter at the time of contract is not a requirement. Therefore, a gift of what is in the womb of an animal is allowed but it will not be valid to sell the same for a price.

Ibn Taymiyyah only disallows a sale of non-existent subject-matter where there is an element of gambling or someone's property is being misappropriated (*muqamarah wa 'akl al-mal bi al-batil*), but it is otherwise lawful. Ibn Taymiyyah further counter the argument of those forbidding the sales of non-existent subject-matters, by stating that their view is not supported through text of the sources and there is no consensus of scholars on the matter. Further to the above, there are examples of sales of non-existent subject-matter permitted by the *shari'ah* such as the contract of lease and hire, and also the sale of unripe fruit after it has emerged. Therefore, according to Ibn Taymiyyah the issue for the invalidity of a contract of sale is not the existence or non-existence of the subject-matter rather the question if there involves any misappropriation and gambling (IbnTaymiyyah, 1899).

Ibn Qayyīm also prohibits such sales on the ground of *gharar* and on the existence or non-existence of its subject-matter (Ibn Qayyīm, 1968). Therefore, Ibn Qayyim tried to elaborate difference between the existence and non-existence of subject-matter of a contract of sale and uncertainty over the delivery of that subject-matter, which is *gharar*. Thereafter, he makes it clear that the object of *shari'ah* is to prohibit a sale where there is a risk of uncertainty on the deliverability of the subject-matter.

There could be three situations in contracts of sale where subject-matter is not present at the time of contract with the possibility of the future availability of the subject-matter, which are as under:

In the first situation, though the subject-matter partially exists, it completes afterwards. For example standing crops and un-ripen fruits on the trees, which ripe later on or produce which ripen in consecutive waves. In this situation, there is a possibility of *gharar* or uncertainty but it is more probable that in the absence of any event beyond human control the subject-matter may be available for delivery. There is, however, a difference among the jurists on the time of validity of contract as some regard contract absolutely valid at the time of the contract and others regard it valid only when the crop or fruit is plucked and delivered. Some have stipulated that the produce should be left in situation until it ripens and that this should naturally be with the permission of the seller, others have differed (Ibn Qayyim 1968).

The Malikis have permitted the sale of consecutive yield and argue that in this situation the *gharar* is not excessive. Further to the above they have permitted it for the welfare and need of the people. The majority of Shafi'is and Hanbalis have permitted the sale of the yield that has already emerged and not the yield which has no signs of existence at all. The majority of the Hanafis hold the same view with some of the minority of them permitting the sale of consecutive waves of yield on the grounds of necessity and custom (Kasani 1910). Article 206 of the *Mejallah* validates consecutive waves of yield, and this is based on the Maliki *ijtihad*.

Now we will consider the second situation in which the subject-matter does not exist at the time of contract but it is certain that it will exist later on. Majority of the scholars have held that this form of sale is not valid. However al-Sanhuri (1956) criticizes and stress for the permissibility of such sales because earlier the prohibition was due to *gharar* and not non-existence and in the present times *gharar* is most of the cases is not present hence permissibility.

According to al-Sanhuri (1956) there is need to cope with the present day needs of commerce and trade and to get away from the irrational rigidity for the sake of public welfare. Further, he refers to Ibn Taymiyyah and Ibn Qayyim who have allowed the sale of non-existent objects devoid of *gharar* (Al-Sanhuri 1956). Applying above examples on futures-trading in the present day world of trade and commerce, specifically in

agricultural commodities, one will notice that the subject-matter of the sale is non-existent at the time of contract. However, at the end of the contract, the availability of commodities in the future is guaranteed through the exchange and clearing houses therein. The practice is that usually the goods are not delivered but due to the clearing-house, a buyer may ask for delivery, during the delivery month. Therefore, applying Ibn Taymiyyah, Ibn Qayyim and al-Sanhuri's view futures trading is allowed. At the same time futures-trading is highly regulated and there is no possibility of *gharar* or uncertainty causing any dispute between the parties. These fears admittedly still exist in conventional contracts of sale, but not in futures.

In the third situation, the subject-matter does not exist at all without any guarantee that it will exist in the future. Ibn Qayyim and al-Sanhuri have mentioned this situation in the context of *bay' al-ma'dum*. According to them in this sale there is an element of *gharar*, excessive uncertainty and risk and therefore impermissible. Therefore, 'milk in the udders' or an unborn animal cannot be sold for the reason of having *gharar* (Al-Sanhuri 1956; Al-Sarakhsi 1986).

This discussion may therefore be concluded that the *shari'ah* has forbidden any *gharar* and uncertainty on the existence of subject-matter at the time of delivery and it is not necessary the subject-matter be existed at the time of contract and there is no *gharar* or uncertainty if the subject-matter does not exist at the time of contract.

3.4.2 SALE OF AN OBJECT NOT PRESENT AT THE TIME OF CONTRACT

In Islamic commercial law, the subject-matter should be definite and precise. There could be only two possibilities regarding the subject-matter's inspection at the time of contract: either it is present for inspection of the parties at the time of contract or it is not present but it may be identified through defining its specifications, essence, quantity and value and the knowledge of these at the time of contract must be such that it precludes material ignorance (*al-jahalah al-fahishah*) that could lead to a dispute (Kasani 1910). And the buyer may decide on these identifications to purchase the subject-matter. The first

possibility is without any doubt accepted by all the scholars to regard a contract valid. But scholars differ in the second possibility to render a contract valid.

The concept of *bay' al-gha'ib* is relevant to futures trading because in futures trading is conducted on the basis of the description of the subject-matter (commodity). For example in a commodity exchange crops and foodstuff is traded and these are fungible agricultural commodities. These are determined and standardized through measurement, weight, quality, grade and on delivery terms. To comply with these commitments is enforced through a mechanism and clearing houses of the exchanges. Therefore, it is very difficult to deviate from the agreed terms of a contract in relation to the subject-matter. If a party does so, he or she has to compensate the other party, which would be a buyer in our case.

There is disagreement among Muslim jurists on the validity of a contract of sale concluded in absence of the subject-matter and the buyer is not granted any opportunity to view it. The reason behind the prohibition of this contract is the issue of *gharar* which could arise if a contract of sale is concluded in the absence of subject-matter and the subject-matter may not be clearly identified (Kasani 1910).

Muslim jurists here have debated on the extent of *gharar* whether it is a trivial (*gharar al-yasir*) or exorbitant (*gharar al-kathir*). There are four significant views on this. Imām Malik on the other hand considers it to be trivial *gharar*. According to Malikis *bay' al-gha'ib* is only allowed if the subject matter is precisely identified leaving any room for uncertainty and *gharar*. If later on, upon delivery subject-matter appears to be different from the description, the buyer has right to refuse the delivery. Ibn Juzay, a Maliki jurist, a seller can not change the object of sale if contract is concluded in its absence. However, if there is any fear of any change in the object of sale, this will cause an exorbitant *gharar* and hence making the contract invalid (Al-Sanhuri 1956). There are two views quoted from Imām Shafi'i. The earlier view from Imām al-Shafi'i is from the *Kitab al-Umm*, where he validates not just *bay' al-gha'ib*, but also the deferred payment of the price in *bay' al-gha'ib* to a future date. He further entitles the buyer if the subject-matter does not match the description at the time of the contract. Al-Shirazi, a Shafi'i School jurist further elaborates that if both the genus and type of the subject-matter are identified, the sale is

valid and the buyer is entitled to the option of viewing. For example when A says to B sell him a '10 kg of Pakistani rice' instead of saying '10 kg of rice', the sale will be considered valid devoid of *gharar*. Al Sharbini, another Shafi'i jurist, is also in line with the majority view and also Al-Shirazi (Al-Shirazi 1976; Al-Sharbini 1958).

The majority of Shafi'i jurists did not validate *bay' al-gha'ib* and came to the conclusion that this was al-Shafi'i's later ruling repealing the earlier one. Al-Shirazi's commentator, al-nawawi, also supports this view (Al-Nawawi, 1925). In his later view, Imām al-Shafi'i regarded that in *bay' al-ma'dum* there is exorbitant *gharar*, which cannot be removed anything less than direct observation of the subject-matter and a genus or its type or both together cannot be specified through description (Al-Shafi'i 1901). They base their arguments on the *hadith* which simply proclaims, as Abu Hurayrah transmits, that 'the Prophet (peace be upon him), prohibited *bay' al-gharar*', and also on account of the *hadith* 'sell not what is not with you'.

Imām Abu Hanifah comes with some technical view. According to him a buyer is granted right of view (*khiyar al-ru'yah*) of the subject-matter even after the conclusion of the contract. This renders that the Hanafi School accepts *bay' al-gha'ib* as valid contract which may be confirmed upon the viewing of the subject-matter and thereafter acceptance of the buyer.

Here a difference of opinion arises between the Maliki School and the Hanafi School. Malikis says if there is an option of viewing the subject-matter then there is no need for the description of the subject-matter. Similarly, if a subject-matter is clearly stated and identified by describing the genus, type and quantity; option of viewing is not needed. But Hanafis give the option of viewing on top of description of the subject-matter where subject-matter is absent.

The Hanabali school also validates *bay' al-gha'ib* subject to two conditions: (i) the subject-matter of the sale should fulfill the criteria for forward sale (*salam*); (ii) only fungible commodities which can be measured and weighed can be the subject-matter of *bay' al-gha'ib*; (iii) the specifications and description of the subject-matter must be firm

and predictable; (iv) the seller should be able to make delivery according to the agreement, regardless of the distance or time it might take to view the goods; and (v) like the Malikis, the Hanabalīs also entitle the buyer to the option of cancellation in the event of variations in the stated quality. Ibn Taymiyyah while answering those who does not allow the sale of the unseen, states that the Prophet (peace be upon him) only prohibited the sale containing *gharar* involving misappropriation of others' property. There is also evidence that the Companions bought and sold unseen objects, and none of them declared such sales to be unlawful (Ibn Qudamah, 1969).

Therefore, it may be concluded that majority of scholars have permitted *bay' al-gha'ib*. Their argument is based on the Qur'anic verse (2:275) on the general legality of all sales unless otherwise prohibited by *sunnah* and/or *ijma'*. In addition they rely on the *hadith* reported by Abu Hurairah (RA) from the Prophet (peace be upon him) which is:

“one who buys something he has not seen shall have the option of [cancellation] when he sees it”.

There is conflict on the authority of this *hadith* as some regard it one which has a disconnected chain of narrators (*mursal*) and others oppose this contention and regard its chain of narrators as un-broken (*musnad*). Al-Sarakhsi, a Hanafi jurist, in signifying its importance held that the Hanafīs follows this *hadith* because of Ibn 'Abbas and Hasan al-Badri as its narrators though it is a *mursal* one. Further to the above, Imām Malik and Ahmad Ibn Hanbal have followed it (Al-Sarakhsi 1986). In addition *bay' al-gha'ib* is further supported by the legal maxim that the norm in respect of trade and transactions is permissibility (*'ibahah*). In validating *bay' al-gha'ib* in principle, the scholars have also given due consideration to public interest (*maslahah*), and the smooth running of business transactions in the community. The criteria set by scholars permitting it is so clear that any element of *gharar* may hardly be found like the right to inspect the subject-matter before taking delivery and if found not compatible with the specifications prescribed at the time of contract to cancel the deal.

3.4.3 DELIVERABILITY OF THE OBJECT (*MAQDUR AL-TASLIM*)

Majority of the scholars are in agreement that the subject-matter must be in a deliverable position. Any contract where a seller has no power to deliver the subject-matter is invalid such as sale of fish in a river or of birds in the sky. Imām Malik has made an exception to this and held that in the charitable contracts (*'uqud al-tabarru'*) there is no exchange of promises or values and it is a unilateral promise without any element of *gharar* for example gift of a runaway camel by one person to another (Al-Sarakhsi 1986). Kasani (1910) states that a contract is not accomplished unless its basic benefit (*al-fa'idah*) is served which is the ability to convey the subject-matter to the buyer. In the above two examples if the fish or the birds can easily be accessed and caught then there is no question of *gharar* and uncertainty.

Here, following conclusions may be drawn: The sale is void (*batil*) where the seller is unable to deliver the subject-matter at the time of contract. The contract will be voidable (*fasid*) and not void (*batil*) if a seller becomes unable to deliver the object of sale after the conclusion of the contract. By the term delivery it is meant that the seller's control over the subject-matter to deliver it to the buyer or where he is not in full control of the subject-matter, to deliver it through the force of law. Where the delivery is made through the force of law, the sale is considered as a valid sale but is suspended (*mawquf*) till the actual delivery takes place. For example the delivery will be accomplished through the intervention of court where a legal owner, dispossessed of his property illegally, sells his property (*bay' al-maghsub*). The sale will be considered valid but *mawquf* until the object of sale is delivered through the intervention of court. A voidable (*fasid*) sale can be distinguished from a valid (*batil*) sale where delivery is possible only by incurring harm to the property, such as the sale of a fixed object in a building, which could not be extracted without causing structural damage.

The source of the above conclusion is the following *hadith*, which states that:

"harm may neither be inflicted nor reciprocated".(Ibn Majah 1981: Hadith 2340)

Therefore, no sale is allowed which is intentionally harmful for the seller but where the seller voluntarily agrees to such sale and accept to deliver the goods with a harmful consequences to him, the sale will be a valid one at his own risk. But the sale of an object, as discussed above, delivery of which is beyond seller's control, is null and void (*batil*).

It is worth to mention here another sale which is the sale of a debt (*bay' al-dayn*) to a third party and this is not allowed and will be invalid. However, the same is allowed to the debtor himself. In the event of sale of debt to the third party, the seller is not able to deliver the object of sale and the same is a charge on the debtor. For example A gives rice to B on credit which he later on sells to C. The sale will be void because the subject-matter is in B's possession and he will be unable to deliver the same to C. However, the same sale is valid if it is made to B because here the delivery is out of question (Hasan 1986).

The majority of the scholars have agreed that in all sales immediate transfer ownership and delivery should be made except the sale of *salam* and *istisna'*, otherwise the purpose of the sale is frustrated (Kasani 1910; Al-Sanhuri 1956). But Ibn Taymiyyah and Ibn Qayyīm have contrary opinion (Ibn Qayyīm, 1968). Ibn Qayyīm explains as:

“In response to the assertion that the effect of contract materialises by immediate delivery, it must be stated that the effect of a contract is either specified by the Lawgiver, or by the contracting parties, neither of which is proven in this assertion. The Lawgiver has nowhere stipulated that the subject matter of sale must in all cases be delivered immediately after contract, nor would the contracting parties always want immediate delivery (Ibn Qayyīm, 1968).

According to Ibn Qayyīm (1968), in a contract of sale the parties may agree either to defer payment of sale or delivery of the subject-matter. An example may be quoted here when Jabir sold his camel to the Prophet (peace be upon him). He requested to postpone the delivery until Jabir reached Medina. The Prophet (peace be upon him) agreed to Jabir's request. Explaining further, Ibn Qayyīm (1968) argues that if there were no

reference from the *sunnah*, it is rational to allow so and it may get its permission from analogy as well. Referring to Imām Ahmad ibn Hanbal (1985), he asserts that the Imām and his followers allowed deferred delivery in line with the custom of the society and time. Therefore, delivery of a large amount of goods can be delayed because for delivery of such a quantity there needs to arrange the resources such as carriages etc. According to Ibn Qayyīm (1968), there is no such provision in *shari'ah* that all the beasts of the town should be hired to carry and deliver the goods at once. While arguing against the majority of the scholars that delayed delivery in terms of prevailing custom is exception to the general rule of sales, he strongly denies that this is an exception. He continues that if both the parties agreed to delayed delivery in addition to the prevailing custom, this amounts to a permitted transaction before *shari'ah* as a matter of principle and not that of exception (Ibn Qayyīm, 1968).

Comparing above situations with the futures-trading, here the delivery in open contracts is delayed but guaranteed through the mechanism of clearing-houses in the exchanges. In a normal contract of sale, a delivery is not always guaranteed and rules of *fiqh* still apply on these sales. In futures, delivery is guaranteed through clearing-houses over and above the level of guarantee in a normal contract of sale. However, in normal practice the buyer instead of taking delivery offset his position by entering into a reverse transaction. This has no concern with our present discussion of the deliverability of the subject-matter rather this is the choice of the buyer not to take it and he has no obligation to take it. The seller who wishes to deliver gives notice of delivery to the clearing-house, and the rest of the delivery procedure takes its course within days.

3.5 DEFERMENT OF THE COUNTER-VALUES

Unless otherwise agreed by the parties, immediate enforceability and effectiveness is the significance of contracts under Islamic law (Madkur 1955). Therefore, contract of sale according to Muslim scholars should be enforced immediately with all its consequences. These are transfer of ownership and the immediate delivery of the subject-matter. The parties to a contract are free to prescribe and stipulate terms of a contract, which has some

limitations too. The most common of all these limitations almost present in every contract is that no stipulation should frustrate the main purpose of a contract.

There are two definitions of sale one specific and the other is general. The general definition of sale is “a contract of exchange which is binding on the parties”. The specific definition of sale is the “exchange of a tangible object (*a'ayn hadirah*) that is present for a price that is assigned to the person (*dhimmah*) of the buyer” (Kasani 1910). This definition includes a normal sale and barter exchange where the counter-values are some tangible goods and in the case of currencies both sides involve currencies. In both situations, delivery will be immediate otherwise it may be regarded as debt on the other side. The general definition of sale also include forward sale (*salam*). In *salam* sale the price is paid at the time of contract with a deferred delivery of the subject-matter. A majority of scholars are of the view that *salam* is an exception to a contract of sale where immediate exchange of the counter-values in physical form is the requisite (Ibn 'Abidin 1966).

Maliki School has permitted deferred sales (*buyu' al- 'ajal*) if there is no element of *gharar*, with many restrictions and excluding many forms. Reason for this restrictive approach is blocking the means of making illegal, the legal (*sad al-dhara'*) and for the fear of involving in *ribawi* transactions. Al-Qaradawi remained critical to the Maliki School by stating that these prohibitions are not based on the injunctions of the Qur'an or *sunnah*, but is rather based on juristic *ijtihad*, and this is why many different views have been recorded on the subject (Al-Qardawi 1987).

The Shafi'is have permitted the deferred sale as an independent category subject to the condition that the period of deferment is precisely stipulated in order to avoid *gharar*. The source of Imām Shafi'is argument is based on the Qur'anic text where deferred liability contracts are permitted (2:282), which is discussed below. On same evidence, Imām al-Shafi'i has permitted the sale of *'inah*. *'Inah* may be elaborated through the following illustration e.g., A sells an object to B for a deferred price of Great Britain Pound (GBP) 100, and buys it back from B for an immediate lower price say for instance GBP90, or deferred for a lesser period (al-Shafi'i 1901).

The Hanbalis has also allowed deferred sale if devoid of usury and *gharar*. The views of Ibn Taymiyyah and his disciple Ibn Qayyim have already discussed earlier.

Therefore, it may be concluded that the scholars have permitted deferred sale with some reservations. But Ibn Qayyim (1968) has accepted it without any conditions as an independent form of sale. The coming part will discuss now some of the types of deferred sale as allowed by the *shari'ah*.

Forward sale contract (*salam*) and deferred manufacturing contract (*istisna'*) are two deferred contracts which are allowed by the *shari'ah*. In both of these contracts the delivery is postponed to the future date. In *salam* the seller is paid the price immediately at the time of contract and at the time of contract though not having the goods in his possession but guarantees the delivery after having possession over the goods. In nutshell it is a promise to deliver in exchange of immediate price payment. The goods to be delivered must be determined precisely in terms of quantity and quality. The date of delivery must also be determined at the time of the contract. There is an agreement of scholars that *salam* is allowed in fungible goods but some of the scholars have extended it to all the commodities except gold and silver in which case deferment may amount to *riba* (Rahim 1977; Saleh 1990). Scholars have dealt with *salam* and *istisna'* with exceptional caution for the fear of indulgence in *gharar* and *riba*.

The Hanafis have asserted that the goods must exist at the time of contract and the date of delivery be ascertained at the time of the contract. The Shafi'is, relax the requirement of the fixation of delivery date which they consider need not to be fixed. While devising rules for sales and allied issues, the scholars remained concerned about the public interest and society's situation at that particular era.

In contract of manufacturing (*istisna'*), price is paid in advance in exchange of promise to manufacture and deliver the desired good in a definite future date. *Salam* has its authority from the *sunnah* while *istisna'* has its permission through *ijma'*, custom (*'urf*) and business needs (Rahim 1977). *Istisna'* is a good example, which is a deviation from the general rule of immediate exchange of counter-values and existence of the subject-matter

at the time of contract. There is a difference of opinions on the binding nature of *istisna'* contract. Some of the scholars including Imām Abu Hanifa regard it a mere exchange of promises (*tawa'ud*) therefore non-binding. However, the majority of the scholars and Imām Abu Yusuf, a leading Hanafi Scholar, regard it a binding contract (Al-Qardawi 1987; Saleh1990).

It is agreed that the basic purpose of a contract of sale is the immediate transfer of ownership of the object of sale like immediate delivery of the counter-values at the time of contract. But *shari'ah* has permitted *salam* and *istisna'* contract as an exception to this rule but scholars have reservations on the permissibility of these sales because this may destroy the purpose of contract of sale which is immediate transfer of ownership of the subject-matter at the time of sale. Therefore, a restriction has been made that only deferment of one of the counter-values is allowed and not of both at the same time. Either the payment of price or delivery of the subject-matter may be postponed to a future date. A contract with both the counter-values deferred to a future date is invalid. If both the counter-values are deferred then it is not really a sale contract but a promise and an agreement to sell. This deferment if not handled with care may cause uncertainty, *gharar* and also unlawful gain which is *riba*. The *gharar* that is apprehended here relates to price changes over the course of time, changes that might affect the subject-matter of sale, and the question of whether the parties might consequently dispute the terms of their agreement (Al-'Attar 1978).

For a deferred sale two conditions must be fulfilled: (i) the counter-values must not comprise usurable items lest it may lead to usury. To determine if a commodity or counter-value is usurable or not the *fiqh* schools have determined the criteria, which differs from that of the other school and they base their argument on the famous *hadith* about *riba*.

In a barter exchange if the counter-values are of the same genus and both are measurable and weighable, the scholars have different views on the validity of such a transaction. The Hanafis regards it a usurable transaction. Before the Shafi'is the '*illah* to regard a transaction usurable is unity of genus and edibility. The Malikis have added storability to

the unity of genus and edibility as identified by the Shafi'is . A barter exchange [with deferment] is thus valid for items that fall outside these combinations. (ii) the counter-values to be deferred must clearly be identified without any ambiguity and terms of delivery with the precise delivery date be mentioned (Al-'Attar 1978).

A deferment period (*'ajal*) must be determined specifically by referring to a particular date, day, month and year. If this period is dependent of an event, which is uncertain or probable; or vague then it is not acceptable. Example of uncertain period could be: 'whenever the rain falls' or example for a vague period as: 'the month of Ramadan' or 'the harvesting time', it pertains to the first of that month or period. If period is specified as 'three months', this signifies the end of that period.

There is some disagreement on the period of deferment. For example Imām Malik has allowed deferred sales for very long periods, for instance for ten or even twenty years or longer. But majority of the scholars oppose the idea of long period for the fear of indulgence in *gharar*.

Should there be compensation in the form of a higher price or some other consideration for deferring the delivery of the subject-matter to a later period, there are different views of the scholars. Majority of the scholars view this increase as usury. But there is an example from *sunnah* in favour of such an increase. The *hadith* is reported by Ibn 'Abbas wherein a discount was granted to the debtor for repaying the loan before the maturity period. On account of analogy (*qiyyas*), it is concluded that if a discount be granted for repaying a loan prior to the stipulated period, likewise, a deferment in paying the price entitles payee for an increase as such.

Deferment has nothing to do with the validity of a contract. Therefore, a deferment does not affect obligation to pay in a contract of debt (Al-Sarakhsi 1986).

A contract may be divided into three types with reference to time of completion: (i) prompt (*al-'aqd al-munajjaz*), which is effected straight away; (ii) contingent (*al-'aqd al-mu'allaq*), is contingent to a condition attached; and (iii) deferred (*al-'aqd al-mudaf*) i.e., a deferment to a future date. Whether or not a contract is prompt, contingent or deferred,

can be inferred from the language used in making a contract and that is again a question of fact. All the contracts are prompt and immediately performed except two, which are: (i) bequest and (ii) executor ship (*isa'*). These contracts are affected and performed after the death of the testator and not before.

As stated earlier a contingent contract (*al-'aqd al-mu'allaq*) is contingent to the fulfillment of a condition or an event. For example, if A says to B if you pass the exam I will give you this car or A tells B: if you give a loan to my brother, I will be his guarantor (*kafil*). Where a condition is already fulfilled, the contingent contract turns into a prompt contract. There are two requirements for a valid contingent contract viz., the condition must relate to a future time and the condition is one which can be fulfilled and not one which cannot be performed by a normal rational person (Madkur 1955).

A deferred contract (*al-'aqd al-mudaf*) is one which is concluded in the present and performance is delayed to a future time. This contract is permitted by the Hanafis and Malikis and becomes binding the moment it is concluded, however, the performance or its enforcement is only effective in a future date specified in the contract. The Shafi'is do not see any difference the contingent and deferred contracts. According to them in both the contracts are concluded earlier while performed in a later date. The Hanafi and the Maliki differentiate contingent from the deferred contracts by referring to the distinction between cause (*sabab*) and consequence (*hukm*). In deferred contracts performance to a deferred date only have an effect on its consequence and not the cause. While in contingent contracts, the conditions upon which a contract is contingent affect the consequences of a contract (Madkur, 1955). In a deferred contract either the payment of price or performance of the contract be postponed at a time but both the payment and the performance cannot be postponed at the same time.

The contracts may be divided into three categories if their deferment comes into question. (i) Contracts which can only be enforced in the future e.g., executorships and bequests. (ii) Contracts which may either be instant or delayed and scholars have mentioned about fourteen of such category. Lease and hire; agency (*wakalah*); *mudarabah*; charitable endowment (*waqf*) and divorce are to name few of these types of contracts. (iii) Contracts

where deferment is not acceptable at all and these are the contracts in which there is a transfer of ownership e.g., sale, gift, partnership (*shirkah*), release of debt (*ibra' al-dayn*) and mutual reconciliation (*sulh*). In these contracts performance is prompt and ownership is transferred without any deferment. There is no need for deferment, for deferment in such contracts is also likely to lead to indulgence in gambling (*muqamarah*) (Al-'Attar 1978).

The above three types are, however, based on juristic *ijtihad* that deals with the prevailing conditions of a particular time. The different categories were evidently designed to foreclose the avenues leading to *gharar* and uncertainty that imperiled the integrity of contracts.

3.5.1 A GLANCE AT MODERN LAW

This is in the Qur'an while addressing believers:

“Devour not each other's property in vain, but let there be lawful trade by your mutual consent.” (4:29).

In *shari'ah* every contract is deemed valid unless it is clearly prohibited. In many Muslim and Arab states parties' freedom is preserved to conclude a transaction and even many have allowed transactions where subject-matter is not existed at the time of transaction but which is sure to be existed in future.

In terms of Article 131 of the *Egyptian civil law 1948* 'the subject-matter of an obligation may be a future thing'. Article 132 regards a contract void where subject-matter does not exist. In terms of Article 133 and Article 134 the subject-matter of a contract must be lawful and clearly identifiable.

Article 129.1 of the *Civil Code of Iraq 1951* states that the subject-matter of an obligation may be non-existent at the time of contracting, provided its future existence is possible and provided it is determined in a way which dispels the want of knowledge (*jahl*) and risk (*gharar*).

Article 33 of the *Qatar Civil and Commercial Law of 1971* has the same concept as that of Iraqi Civil Code. *Jordan's Civil Code of 1976* in Article 160.1 mentions that a subject-matter may be non-existent at the time of contract provided it will exist in future without any apprehension of *gharar*. *Gharar* is defined in Article 161 as an exorbitant want of knowledge.

Article 30 of the *Kuwait's Commercial Code (Law No.68 of 1980)* also allows sale of the non-existent subject-matter. Further, Article 124 and 125 of the Code permits a contract if price is not specified with a stipulation that the market price will be used or it will be fixed by a third party. Article 168 of the *Civil Code of Kuwait (Law No. 67 of 1980)* also permits sale of non-existent subject-matters. In terms of Article 36 and 37 of *Dubai Law of Contract 1971* contracts conditional upon future events are allowed.

Article 125 of the *United Arab Emirates Federal Civil Code of 1987* provides room for a stipulation in a contract which is not prohibited by law, and is not contrary to public order and morality. In terms of Article 2 of the *Commercial Code of Bahrain (Law No. 7 of 1987)* commercial matters are regulated by the agreement of the contracting parties provided that such agreement does not conflict with mandatory legislative provisions. Further, Article 2 of the *Qatar Civil and Commercial Law* has similar context as that of *Commercial Code of Bahrain*.

3.5.2 A REVIEW OF THE QUR'ANIC AYAH AL-MUDAYANAH

Whether or not Qur'an permits deferred transactions with future obligations may be inferred from the following verse:

“O you who believe! When you deal with each other in transactions involving future obligations for a fixed period (idha tadayantum bi-daynin ila 'ajalin musamman), reduce them into writing. Let a scribe write down faithfully as between the parties.” (2:282).

The verse shows permissibility of future transactions. The following verse also emphasizes on documentation. Further, these transactions should be for fixed period and details such as rights and obligations of the parties must be clearly written and the

document be witnessed. The question is whether 'transactions involving future obligations for a fixed period' should also include futures trading.

We will reflect on the two important words in the text namely '*dayn*' and '*tadayantum*'. The word *dayn* means a deferred liability arising from a contract in which there is exchange of values (Al-Amine 2008a). This is the case where price or delivery of the subject-matter is postponed to a future date (Kettell 2010b). The liability or obligation is known as *dayn*, which is different from a liability arisen out of a loan because there is no exchange of values (Kettell 2010a). A loan is a charitable event where charging interest is prohibited and values are not exchanged (Khan 1994).

Contracts of exchange with one of the counter-values deferred to a future date were practiced in early Islamic era. These were deferred sale (i.e., *bay' al-mu'ajjal* or *bay' bi-thaman al-'ajil*); *bay' al-murabahah* (cost plus profit sale); *al-ijarah* (leasing); *al-salam* (forward sale); and *al-istisna'* (manufacturing order). The deferred liability is known as *dayn*. The following *hadith* indicates permissibility of deferred sales:

"Ibn 'Abbas narrated that when the Prophet (peace be upon him) arrived in Medina, he found that the people had been practising forward sales (i.e., salam) in fruits for one or two years (the sub-narrator is in doubt whether it was one or two years or two to three years). The Prophet (peace be upon him) said: Anyone who pays money in advance for dates (to be delivered later) should pay it for a specified measure and a specified weight and a specified period". (Al-Bukhari 2009: 503)

Tadayantum is a verb and it is derived from *dayn* and it is being used here to mean exchange of goods and services with delays or deferment in obligation. The verb *tadayantum* is followed by *bi al-dayn*, which implies future obligation stressing the importance of the subject that is future obligation. According to Ibn Kathir, the verse is all about to regulate deferred transactions, which were being practiced at that time (Ibn Kathir 1988).

The following discussion will embark on the difference between *dayn* and '*ayn*'. A *dayn* is a future obligation i.e. to say object of sale or one of the counter-value delivery of which is deferred to a future date, which is an obligation on the person who is obliged to fulfill it

(Vogel and Hayes 1998). While *'ayn* is an object of sale which is present at the time of the conclusion of the contract with an immediate delivery (ibid). As such future contracts are *dayn* contracts and creates personal liabilities. Therefore, the verse is concerned about the deferment in the payment of price or the object of sale is a *dayn* or liability on the party concerned (ibid).

The verse while differentiating deferred sale from spot sale, makes it clear that for a deferred sale documentation and witnessing is a requisite (*bi al-daynin ila 'ajalin musamman*). The subsequent portion of the same verse reads 'unless it be a spot trade which you carry among yourselves' (*illa an takuna tijaratan hadiratan tudirunaha baynakum*), which is exempted from the requirement of precise documentation and witnessing.

The scholars meant here by deferred sale the deferment of payment of price to a future date by their mutual consent (Siraj 1989). This principle that only one counter-value is deferred to a future date and not the both is said to be inferred from the narration of Ibn 'Abbas (peace be upon both of them) because the verse addresses the contract of *salam* only (Al-'Attar 1978). According to Imam Razi (1978) this verse is concerned with a sale in which the payment of price is deferred and becomes a debt on the buyer (i.e., *bay' al-'ayn bi al-dayn*). He further states that the *hadith* also include the sale of *salam* in which the delivery of the object of sale is deferred as a debt obligation on the seller (i.e., *bay' al-dayn*).

This verse does not apply on the barter sale (*al-muqayadah*), which is sale of one commodity/goods with another commodity/goods. The reason for that is in the barter sale both the counter-values are exchanged immediately (*taqabud*) without any delay. In addition this verse does not apply to sale of currencies (*bay' al-sarf*) because it requires immediate delivery of both the counter-values (i.e., *bay' al-'ayn bi al-'ayn*) (Al-'Attar 1978).

Based on the above, scholars have concluded that in transactions involving real and tangible goods (*al- a'yan*), deferred sale contracts from either sides are not allowed.

Therefore, in a spot sale of a car which is *al-'ayn*, to defer delivery of the object to a future date is not permitted. However, in such transactions, the price may be deferred to a later date (Al-'Attar 1978).

The above view, by some, is challenged on the authority of the narration by Jabir. He sold his camel to the Prophet (peace be upon him) with a permission to defer its delivery till the next day in Madina. The Prophet (peace be upon him) permitted that deferment. By referring to this narration Imām Ibn Qayyīm states that Imām Ahmad ibn Hanbal and his disciples allowed deferred delivery in tangible or real goods, if parties are in agreement or custom allows it (Ibn Qayyīm, 1968).

Imam Razi on the sale of debt for another debt (*bay' al-dayn bi al-dayn*) (futures trading is based on this contract), states that it is a form of deferred sale and it is not allowed. Because in the verse (*idha tadayantum bi-daynin*), deferment is only from the one side only and not from the both sides. Therefore, debt-clearance sale is not intended in the verse and deferment is only allowed in the following two types of sale: (i) sale in which payment of price is deferred; and (ii) sale where there is deferment of a counter-value from one side only and not from both sides (Al-Razi 1978).

On the contrary, Imām al-Shafi'i has held that the verse includes deferment in general in which deferment may be possible from both sides of a contract, which may include debt-clearance contract. Ibn 'Abbas has restricted the meaning of *bay' al-dayn* to *bay' salam* only, however, by using analogy it could extend to all transactions of the kind with same purpose (*qulna bihi fi kull dayn qiyyasan 'alayh li-annahu fi ma'nah*) (Al-Shafi'i 1901). Ibn Kathir agrees with this view and adds that the 'deferred transactions' (*mu'amalat mu'ajjalah*) are permitted in the verse and these should be in writing (Al-Razi 1978). This indicates a difference of opinion among scholars on the interpretation of word *dayn*: some have restricted its meaning and apply only to certain transactions while the others apply the term generally on all deferred transactions. The Qur'an takes the meaning of *dayn* in broad terms including all the deferred transaction and does not restrict it to certain specified transactions. Al-'Attar has the same view while discussing in his book on *Nazariyyah al-'ajal* (Theory of Deferment) in *shari'ah* (Al-'Attar 1978).

Concluding the above discussion, general meaning of the text should be taken in its general meaning. In *usul al-fiqh*, there is a rule that a text though revealed addressing a particular topic (*sha'n al-nuzul*) will have effect on that specifically and beyond that it does not affect i.e., it does not necessarily restrict the general purpose and ruling of the text (Zahrah 1958). Applying this principle in the present case, it may be said that the reason for revelation (*sha'n al-nuzul*) of the verse is linked to Ibn 'Abbas' narration. So though the verse is specific to *salam* transactions, but its language is general and applicable to all debts permitting all deferred transactions which is subject to the prohibitions of usury, gambling and *gharar* (Zahrah 1958).

Qur'an allows sale and prohibits usury:

“Allah permitted sale and prohibited usury” (Qur'an, 2:275).

According to *fiqhi* interpretation the meaning of the word *bay'* in the verse is general, which is applied to each and every sale unless there is something to the contrary specifying this general meaning. This brings an exceptional case to the general one. As per the above verse all sales are permitted like as barter (*al-muqayadah*); currency sale (*al-sarf*); a spot sale i.e., the exchange of goods for money; the forward sale of *salam*; sale at cost price (*al-tawliyah*); sale at cost plus profit (*al-murabahah*); sale at lesser price than its cost (*al-wadiyah*); absolute sale in which no reference is made to the cost price (*al-musawamah*); and sale by auction (*al-muzayadah*) and many more like this (Al-Qardawi 1987). All of the above sales are permitted if devoid of *riba*, *gharar* or if not prohibited otherwise through the authority of *sunnah* or through the injunction of a permitted authority acceptable in *shari'ah*. Besides, in the absence of any prohibitive injunctions, all sales are permitted through the well known maxim in *fiqh* i.e. the original state of every transaction is permission (*Al-asl fi al-ashiyai ibaha*) (Al-Qardawi 1987). The Prophet (peace be upon him) made exception to the general permissibility by specifically forbidding certain types of sales which were practiced in the pre-Islamic Arab society but did not reflect on permissible sales because of the principle of being permitted in originality (Al-Shafi'i 1901). It may therefore be said that Qur'an permits all sales which includes deferred sales. Futures are one of those and there is no particular text on their

prohibition or impermissibility, therefore these will be permitted if devoid of *gharar*, usury and gambling. A discussion whether there is any element of *gharar* or not in the futures has already been discussed in the above pages, which concluded that these are devoid of these prohibitions in the prevailing trading system.

Further to the above, futures are also devoid of *riba* because it does not involve any predetermined fixed profit without the risk of loss. Margin money which is deposited with a broker or agent does not give rise to interest and are returned to the depositor/customer in full if there is no loss. Further there is no unwarranted gain from either side which may amount to *riba* because both the parties exchange their counter-values on a fixed future date and none of the parties enjoy the benefit of the stuff of the other without paying the price for that enjoyment. Hence no interest is earned by either party between the moment of contract and the final conclusion of the round turn transaction. Speculation and gambling will be discussed in the following pages.

3.6 SHORT-SELLING

"Sell not what is not with you" (Abu Dawud 1984, Hadith No. 3496)

SS is based on the above quoted *hadith* which is interpreted by different scholars with different interpretation. SS is an instrument which allows investors to make money without actually owning any shares. It is a sale of a security by an investor who is not owner of it at the time of transaction. The investor borrows a stock through his broker and thereafter sells it in the market. (Dusuki and Abozaid 2008) Subsequently the investor buys a stock from the market at a lower price to return it to the lender. In *fiqh* it is a condition that the object of sale must be existed and it must be owned by the seller at the time of contract otherwise the contract will be invalid (*al-fasid*) (Al-Zuhayli 2003).

SS, therefore, may be regarded as in conflict with the *fiqh* and one of the *hadith*:

"Do not sell what you do not possess" (Al-Tirmidhi 1974:525).

Connecting from the previous discussion where it is stated that existence of subject-matter is necessary at the time of contract, this portion is all about ownership which is the seller must own the object of sale before selling it further. In futures-trading normally a seller sells before he owns a commodity and that makes this contract in contravention of the teaching of the present *hadith*. The following discussion will analyse this *hadith* and futures trading will be discussed in the light of teaching and interpretation of this *hadith* with a view whether or not futures-trading is allowed. The discussion will be made on this *hadith* with reference to the conventional sale. Thereafter, in the light of this *fiqhi* discussion, futures trading will be analysed.

Some scholars have challenged the authenticity of this *hadith* in terms of its text and the chain of its narrators. This *hadith* is not recorded in al-Bukhari and not in al-Muslim but can be found in the *hadith* collection of Abu Dawud and al-Tirmidhi (Al-Qardawi 1987).

It has already been mentioned earlier that there are doubts in the chain of its transmitters. Abu Dawud (1984, Hadith No. 3496) and Ahmad ibn Hanbal (1985) have described about the *hadith* to have been narrated by Ja'far ibn Abi Wahshiyah, from Yusuf Ibn Mahak from Hakim Ibn Hizam. In other collections, a fourth name of 'Abd Allah ibn 'Ismah comes between the names of Yusuf and Hakim which to some is not known at all (*la yu'raf*). Some of the *hadith* scholars even challenge the credibility of the main narrator of this *hadith* namely Hakim Ibn Hizam.

On the basis of above discussion on the authenticity of both the *hadith*, it may not be taken as authentic (*sahih*) *hadith* but as *hassan* (good) *hadith*, which is a lower status than an authentic (*sahih*) *hadith*.

The *hadith* is narrated as:

'Narrated Hakim ibn Hizam: Hakim asked (the Prophet): Apostle of Allah, a man comes to me and wants me to sell him something which is not in my possession. Should I buy it for him from the market? He replied: Do not sell what you do not possess.' (Abu Dawud 1984, Hadith No. 3496).

This *hadith* may have different interpretations according to different method of interpretations. It may call for a total ban (*tahrim*), or abomination (*karahiyyah*), or just some guidance to the public. Muslim scholars agree that all of these convey the meaning of negation i.e., to avoid to do some certain act. An order having the force of total prohibition (*nahi*) may only be enforced if preceded by a warning (*wa'az*). As stated earlier, this *hadith* has a deficient chain of narration and also the prohibition here is not preceded by any warning, therefore, the prohibition here is just for abomination (*karahiyyah*) only. According to Al-Khatib (1976) this *hadith* has just a moral guidance (*irshad*) and not the prohibition.

The meaning of the *hadith* 'Sell not what is not with you' is to stop someone from selling which he does not own (*ya'ni ma laysa fi milkik*) at the time of the contract. Kasani (1910) requires that the seller must own the object of sale at the time of contract with an exception of *salam* sales. In *salam* contracts ownership may be acquired after the contract is concluded and he refers to the above *hadith*). Ibn al-Humam (1970) and Ibn Qudamah (1969) have added that this sale is not allowed even if the seller after the conclusion of contract buys and supply the good.

On the ownership of the object of sale at the time of contract, the Hanafis do not take it as a condition for the validity of contract (*shart al-sihhah*) but take it as a condition of the effectiveness (*nifadh*). Therefore if a seller who acquires ownership of the object of sale after the contract of sale, it will not be an invalid (*batil*) sale but will be an in-effective sale. Thus they have allowed sale by a person who does not own the object of sale but sells it with good intention and reason and the sale will be a valid one but will be effective subject to the consent of the owner. This sale is known as the sale by the unauthorised (*bay' al-fuduli*) (Kasani 1910).

Some scholars like al-Baghawi (1974), and many others are of the view that the *hadith* under discussion is concerned with the sale of specified and unique objects (*al-a'yan*) and not with the fungible goods which may be specified and hence sold through descriptions (*buyu' al-sifah*). This is because that the fungible goods are easily substituted. *Salam*

sale's object of sale is fungible goods and their sale is valid despite the fact that the owner does not own them at the time of contract (Al-Baghawi 1974; Al-Khattabi 1949).

Imām al-Shafi'i also allows the sale of an object not owned by the seller at the time of contract provided it is not an object of special specifications guarantee of whom is not possible (*al-a'yan*) (Al-Shafi'i 1940). Al-Khattabi (1949) has the similar view and further states that the prohibition is only related to specific goods (*al-a'yan*) in order to avoid *gharar* e.g., sale of a runaway camel, sale prior to taking possession and the sale of someone else's property without his permission (Al-Khatib 1976).

Ibn Qayyīm (1968) and Al-Mubarakfuri (1965), the commentator of Sunan Abu Dawud and the commentator of Jami' al-Tirmidhi, respectively have held that the *hadith* is about specific goods and not with fungible goods. According to Ibn Qayyīm (1968), if fungible goods were also included, the *salam* sale would also be impermissible because *salam* sale deals in fungible goods and these are non-existent at the time of sale (Ibn Qayyīm 1968).

Applying above argument to futures trading, it may be concluded that futures-trading is allowed because of their dealing in fungible commodities only.

The meaning of the 'what is not with you' is interpreted differently by different scholars. Ibn Taymiyyah (1899) and his disciple Ibn Qayyīm (1968) have held that it is the sale of something, which one cannot deliver at all and gives rise to *gharar* and uncertainty. Ibn Taymiyyah (1899) and Ibn Qayyīm (1968) states that by completely invalidating such sales through the application of this *hadith*, would invalidate some sales which are allowed e.g., *salam* and a variety of other sales. Therefore prohibiting Hakim Ibn Hizam could be either he did not own the object of sale i.e., he would be selling the property of others or it was uncertain whether he would be able to deliver the goods which seems more likely could be the case (Al-Shafi'i 1901; Ibn Taymiyyah 1977; Ibn Qayyim 1968).

Imām al-Shafi'i having similar view states that by 'what is not with you', means the goods which cannot be delivered by the seller and sale of such goods involve *gharar* and harm. But if the seller is sure of delivering such goods which he does not have at the time of contract, such sale is permitted on the analogy of *salam* sale. Quoting 'Abd Allah ibn

'Umar, Imām al-Shafi'i it is allowed to sell food-stuff, not in his possession at that time, by setting its qualities, price and date of delivery. Al-Baji (1914), a Maliki jurist, has held that the prohibition through "what is not with you" is the prohibition of sale of objects of specific description which is beyond the seller's ability to deliver. There could be cases where someone though own an object of sale but cannot deliver or where though he possesses but does not own and these are the cases the *hadith* is addressing to. Thus it may be concluded that the purpose of the *hadith* is to prohibit a sale where a seller is not certain to deliver the goods and ownership and possession of the goods is out of question. Therefore, the effective cause ('*illah*) of the prohibition is *gharar* on account of inability to deliver. Ibn Qayyim (1968) is also of the view that the purpose of this *hadith* is the avoidance of *gharar* from such transactions which is same of the *hadith* in which *gharar* is prohibited. According to him the sale of a thing which is not with the seller could be prohibited because he is not certain about its delivery and further he does not have possession of the good hence effective control and the good is not charge on his person (*dhimmah*) i.e., liability.

The question of liability of goods, if lost, only comes when someone has possession of the goods. In futures trading one acquires liability when a contract is concluded and question of possession is immaterial.

Further to the above, in support of futures trading, scholars like Yusuf al-Qardawi (1987) argued that the market of Madina, at that time, had a small volume of trade comparing to the modern world, that assurance as to supply of goods was not definite. *Hadith* therefore came to prohibit such sales where subject-matter was not present, in order to avoid *gharar* and uncertainty. The present day markets are arranged in such manner that there is a regular and systematic supply of goods desired. Therefore, present day markets are well-equipped and there is no uncertainty as to the delivery of the goods and this was the cause of the main prohibition in the *hadith* (Al-Qardawi 1987). According al-Darir (1997), the *hadith* is related to the sales of certain goods in which deferent is not allowed but in other cases it is allowed like in the case of *salam* sales (Al-Darir 1997).

If we analyse the current futures market, it is evident that there is SS of commodities in the market but at the same time there is certainty devoid of *gharar* about the delivery of the same. In the futures market identical contracts are always available to be purchased and hence sold promptly concerning the desired commodity. A seller can easily offset his position by finding an equivalent contract or he can find easily a contract to purchase the desired commodity where he is required to deliver that commodity. The function of the clearing-house make it possible that buyer is guaranteed performance of the futures contract in favour of both sides; seller and the buyer. This is a peculiarity of futures trading, which provides systematic guarantees regarding delivery and payment that is something an open market does not provide.

3.7 SALE PRIOR TO TAKING POSSESSION

The following pages will reflect on another important concept in Islamic commercial and that is a purchaser of an item may not resell it unless he gets possession over it. This principle is based on *hadith* of the Prophet Muhammad (Peace be upon him), which will be discussed and analysed with reference to normal sale contracts and also with reference to derivatives/futures trading. The question in discussion is whether or not futures and derivatives trading is permissible in the light of the above *hadith* and is there any difference between a normal sale and a future sale or they be treated in the same manner when applying above *hadith*.

The literal meaning of possession is *qabd* in Arabic language, which means holding something in someone's hand. In legal sense it means to have possession in the eyes of law regardless of the fact if there any physical possession or not. With reference to a contract of sale, it means to have possession of the counter-values by both the parties; by the seller possession of the price and by the buyer possession of the object of sale which seller is obliged to deliver. Thus delivery and possession are two corresponding concepts where a seller delivers goods and buyer takes possession and the vice versa a buyer deliver price and the seller takes possession of the price. The same is applied to evacuation (*takhliyah*) and *qabd* in which case seller is obliged to evacuate the property for delivery and possession for buyer. Though a seller is obliged to deliver the object of

sale but at the same time a buyer is not obliged to take possession (*taqabud*). (Al-Mawsu'ah 1987)

In futures trading, there is a practice that delivery of the object of sale and its possession does not take place but parties offset their positions instead. Financial futures are exception where delivery and corresponding possession is not a requirement and both occur by debiting and crediting of accounts (Rebell et al. 1984). Though delivery in practice delivery is not the norm in futures, still all measured are taken to make the delivery possible. What is deliverable and when it can be delivered influences the price relationships between cash and futures, and between different contract months. Delivery element makes it possible to distinguish between different future contracts and if a trader holds his position till the last day of delivery then option of offsetting becomes impossible. Thus unless a trader does not closes his position by entering into a reverse transaction he has to deliver the goods (Rebell et al. 1984). There are three *'ahadith* on the issue of possession which are as under:

- (i) 'Abd Allah ibn 'Umar has reported that the Prophet (peace be upon him) said:

“He who buyes foodstuffs should not sell it till he has received it.”

(Al-Bukhari 1986:482).

- (ii) 'Abd Allah ibn 'Umar reported from the Prophet (peace be upon him) that:

“He who buys foodstuffs should not sell it unless he is satisfied with the measure with which he bought it.” (Al-Bukhari 1986:481).

- (iii) Ibn 'Abbas has also reported the following *hadith* from the Prophet (peace be upon him) as:

“He who buys foodstuffs should not sell it until he has taken possession of it. Ibn 'Abbas said: I think it applies to all other things as well.” (Al-Bukhari 1986:483).

More or less all three narrations have same meanings. For possession, word '*yaqbidahu*' is used and for in the later two reports word '*yastawfih*' is used which means 'obtain full

measure'. The meaning, which these three reports convey is the prohibition of sale prior to take possession. It is interpreted that this prohibition is concerned with the food-stuff only.

The legal analysis of possession is important for its understanding in relation to different commodities, its effect on transactions and in relation to the custom and commercial practice of the society. Concept of *qabd* is widely discussed by scholars with reference to commodities like precious metals and foodgrains, which have relevance to usury (*riba*).

According to the author of the *Hidayah* the Prophet (peace be upon him) prohibited the sale of commodities with an emphasis on perishable ones and their remains uncertainty about their delivery if seller does not possess the commodity. This doubt or uncertainty about delivery could be the result of perishment of the commodity or due to other circumstances. Therefore, the purpose of the *hadith* is to avoid uncertainty regarding the availability of the object of sale and to protect the buyer from any harm. Therefore, all majorities of the scholars are in agreement about the prohibition of sale of foodstuff prior to obtaining possession. Imām al-Shafi'i makes this prohibition general by including foodstuffs, land and gardens sale of which is not allowed before their possession. Imām Ahmad ibn Hanbal, however, excludes from this prohibition the sale of real property because there is no probability of any destruction and loss in such properties contrary to foodstuff which are more prone to destruction (Al-Marghinani 1982).

Food-stuff which are sold through measurement and weight are considered having possessed upon their measurement or weight. Imām al-Shafi'i (1901) further asserts that in lump sum (*juzafan*) sale, possession is established by physical hold of the commodity concerned. If the ownership of something is transferred regardless of the fact whether it is a foodstuff or not such as transfer through gift, inheritance or other charitable ways, the commodity or goods concerned may be sold prior to taking possession. This is because the recipient of the property is not financially obliged to pay the price hence is free to sell it.

Possession may be differentiated in movable and immovable properties; in movable properties it is done by physically removing that object and in the case of immovable property it is established by vacating it by the seller. Therefore a house cannot be sold by its buyer without its prior evacuation (Al-Shirazi 1976). This view of Imām al-Shafi‘i is supported by the most of the jurists and this is also the custom.

IFA has resolved via a resolution that the effective cause (*'illah*) in the *hadith* for the prohibition of sale prior to possession of the property. It states that the effective cause of prohibition is *gharar* i.e., uncertainty about the delivery of goods buyer/subsequent seller if the original seller could not deliver the object of sale on time or does not deliver at all. In addition, it further goes, if the object of sale is foodstuff, there could be another element of *gharar* which is its perishability (*ja'ihah*) due to natural decay or diseases (The Fiqh Academy Resolution No. 7, 1989).

In Hanafi School, possession is not an element (*rukn*) of the contract of sale but it is a condition upon which the effectiveness of a contract rests (*shart al-nafadh*). Kasani (1910) states that a valid contract of sale is concluded with taking possession but remain conditional upon taking the possession. According to al-Sarakhsi (1986) possession regulates the effect or outcome of the contract hence a contract is still valid and concluded without prior possession of the goods with an exception of contracts in which currencies are involved which are known as contracts of currencies (*buyu' al-sarf*).

Imām Malik has restricted the application of *hadith* to foodstuff only. According to Malikis, in foodstuff, the requirement of taking possession prior to sale is only required where there is exchange of counter-values hence excludes contracts of loan and gifts. Therefore, all goods and commodities may be sold prior to take possession with an exception to usable food grains and foodstuff where exchange of values is taking place (Ibn Juzay 1975). Imām Malik has permitted the sale of foodstuff in lump sum (*juzafan*) which takes place without weighing and measuring and this sale takes place without prior possession of the food-stuff because in this particular sale the object of sale comes under the liability (*daman*) of the buyer as soon as the contract is concluded.

The Hanbalis have lenient view than the Shafi'is. Ibn Taymiyyah (1977) is against the majority's view and tries to determine the meanings of possession which according to him may be determined through the prevailing custom. According to him it cannot be restricted to holding and retention (*habs*) or evacuation (*takhliyah*) and *takhliyah* may occur differently in different situations in different objects and properties (Ibn Taymiyyah 1977). Ibn Qudamah has more or less the same view. He adds further that the possession is necessary for all fungible goods that are sold by weight, measurement or number. In these goods liability is only transferred to buyer after possession and possession is considered complete when these goods are weighed and measured. For other goods, which are not sold through measure or weight like clothes, possession is not required because in these goods buyer becomes liable once contract is concluded (Ibn Qudamah 1969).

Ibn Hazm Zahiri (1988) has held that the only commodity meant in the *hadith* is wheat in which prior possession is necessary before sale because the word '*ta'am*' in the *hadith* refers to wheat only. Further there is no difference whether the wheat is acquired through sale, gift, loan or inheritance, in all cases prior possession is necessary before further sale by the buyer. Besides wheat anything may be sold prior to obtain the possession (Ibn Hazm 1988; Al-Jundi 1988).

Possession remained open to different interpretations depending upon the commercial needs and customs as prevailed in the market. It could mean evacuation, taking into custody, separation, measurement, identification (*ta'yin*, or *tamyiz*) and viewing (*mushahadah*). The Zahiris have adopted the most liberal approach and according to them possession (*qabd*) means literally to hold and to retain and they have made the requirement of possession prior to sale a requisite in terms of only a single commodity which is wheat. The Zahiris' approach of interpreting the textual sources of *shari'ah*, as one can understand, is to take the prohibitive orders in the narrow sense and should not be applied and generalized, via analogy, beyond the specific situation to which such prohibition is related to.

Only the Shafi'is has made possession a condition prior to the sale of immovable properties. The Malikis has confined the requirement of possession to foodstuff only. In the case of fungible commodities possession is accomplished when these are measured or weighed for delivery. The principle of measurement and weight for fungible food items as found in different schools of *fiqh* is in order to conform to the teachings of *hadith*. This conformity has a devotional (*ta'abbudi*) aspect which is not rationally comprehensible (Al-Qadir 1982). The evidence on this point is more specific in at least two other *hadith* as follows:

“Abu Hurairah (Allah be pleased with him) reported Allah's Messenger (may peace be upon him) as saying: He who bought foodgrain should not sell it until he had measured it.” (Sahih Muslim 2009:914)

The second *hadith* on this theme simply proclaims:

“Measure your foodstuffs and it will be blessed for you.” (Al-Bukhari-1986:481)

Forwards sale (*salam*) and forward manufacturing contract (*istisna'*) are two exceptions to principle of taking possession prior to sale, which are allowed for the convenience of the people.

In view of the foregoing discussion on the *hadith* and opinion of the majority of the scholars, it may be concluded that a sale in futures trading, may be made prior to take possession where the object of sale is not food-grains like cotton, rubber and tin. Before the Zahiri besides non-food items, the rule may extend to any food item except wheat such as palm oil.

In foodstuff measurement and weight to furnish possession is required in the bulk sale of commodities or consecutive sales of the same commodity and this is only in the first transaction in the series. In futures trading food commodities are traded in standard weights and measurement in packaged form. These packages are properly sealed and labeled. Therefore, once they are packed in packages after measuring and weighing them, there is no need to repeat the process again and again, each time these are sold.

Warehouse provides receipts as evidence of their specifications including weights and measurement and this is a customary practice now. Their possession is assumed in such commodities by obtaining warehouse receipts as a proof of their measurement and that measurement is conducted once in the beginning, which is not repeated every time a contract is concluded for the sale of those commodities.

In the above paragraphs it is shown that requirements of possession in the light of *shari'ah* requirements may be determined through customary practices if these are devoid of *gharar* and uncertainty. This need not necessarily require physical possession. In the prevailing banking transactions account records (*al-qayd al-hisabi*) are maintained which determine liabilities and credit in banking transactions and are taken as actual *qabd* (*al-qabd al-haqiqi*) (Hamoud 1981).

Only two percent of the futures transactions involve actual delivery and possession of commodities but delivery and possession is still an important factor in *shari'ah* compliant transactions. As for the bulk of futures contracts in which the contracting parties close out their position by entering into a reverse transaction, this is an issue which needs to be addressed separately. Since the *shari'ah* validates in principle the sale of physical objects (*bay' al-'ayn*) as well as the sale (involving exchange) of debts (*bay' al-dayn*) which become a charge on the person (*dhimmah*) of the debtor, and because offsetting in futures contract tend to fall in the category of *bay' al-dayn*, we need to address this subject in further detail. Delivery and *qabd* in *bay' al-dayn* are no longer a matter of physical delivery or retention of an actual asset, but of appointment (*ta'yin*) and computation of a debt that is established on the person (*dhimmah*) of the bearer of that debt.

3.8 DEBT-CLEARANCE SALE

An offsetting transaction in futures trading essentially consists of a sale in which two parties transact over a debt that one owes to the other, and settle their debts through the modality of sales and purchases. There is not a single consistent view on this subject by the *shari'ah* scholars. In *shari'ah* debt sale is known as *bay' al-dayn* or *bay al-kali' bi al-*

kali' and scholars have difference of opinion that which sale contract falls under this category. Debt sale contracts may be illustrated in the following paragraphs:

'A' buys wheat from 'B' on credit with a commitment to pay the price on a fixed date. But on the day of payment B finding himself unable to pay asks the A to grant him some more time as: 'Sell it to me on credit for a further period, for something additional', and A agrees to that. Imām Malik discusses this situation in *al-Muwatta'* and does not allow it. But in futures trading offsetting does not always involve 'something additional'. A seller may make a profit, sell at cost price, or make a loss—which means that *riba* is not involved, and it has no resemblance with example as set out above which Imām Malik has prohibited (Malik 1978).

'A' gives wheat to 'B' on credit to be returned within three months. During this three months period 'A', without re-possessing wheat from 'B', sells the wheat to 'C' for a price. The sale involves exchange of debts and it is not permitted due to uncertain nature of delivery of wheat which is in the possession of 'B'. 'A' need to have possession first after the expiry of three months period in order to sell the wheat to 'C' (Al-Darir 1997; Hamoud 1981)

'A' lends 'B', who owns a house, £5,000 for a period of one year but before the repayment. 'A' asks 'B' to rent his house to 'A' and the outstanding loan may be settled towards the payment of rent. This subsequent transaction would involve sale of debt for another debt and is impermissible for the reason of generating *riba* if a parties benefits from it unwarrantly (Hamoud 1981).

'A' owes 'B' 30 ounces of gold and 'B' owes 'C' 150 ounces of silver. In this scenario 'A' cannot pay his debt to 'C' instead of paying to 'B' and thereby settling debt with 'B' and consequently settling 'B's debt against 'C'. If 'A' and 'C' settle the debt in the above manner, this will be a situation of a prohibitive sale of debt for another debt and A is personally liable to 'B' and 'B' is personally liable to 'C'. The Hanbalis forbid such a settlement of debts if the two commodities are different. The Shafi'is forbid such a settlement in either case without distinguishing whether or not the commodities are

identical or different and if they are settlement in identical commodities with same genus and quantity, it would be a simple clearance of mutual debts (*al-maqasah*) (Hamoud 1981). Futures sales are not in the nature of simple *maqasah* of mutual debts because of the likelihood of differences in the respective prices of the sale and purchase of the same contract, and the consequent profit or loss that may be made.

'A' sells a shirt to 'B' for a price of £40, which 'B' has to pay in a month. Thereafter, 'A' buys from 'B' the same shirt or a similar one for £50 which he is liable to pay after two months. Actually 'A' is borrowing £40 with an addition of £10 to it which amounts to *riba*. The sale given in the above example is called *al-'inah*. *al-'inah* is permitted by the Shafi'is but majority of the scholars have ruled against it. Take another example where 'A' sells the shirt to 'B' for £50 to be payable in six months and 'B' immediately re-sells the same shirt to 'A' for a price of £40 to be payable immediately. In reality 'B' is borrowing £40 with an interest of £10 which he is liable to payback in six month time. Jurists have differed on the reason of the prohibition of this kind of sale, some regard *riba* to be the reason for prohibition and some regard the reason of prohibition is the debt clearance sale (Qardawi 1987; Hamoud 1981).

Mughni al-Mauhtaj has stated two opinions on the issue of the sale of a debt; according to one opinion a debt cannot be sold to a third party and will be treated as void, but a second opinion permits it with the following conditions: i) the debtor acknowledges his debt and agrees to repay it, ii) the debt is still overdue, and iii) that both parties take into possession what is due to them before they part each other's company (Al-Sharbini 1958). Maliki view is expressed in al-Mudawwanah, which allows the sale of debt to a third party on the following conditions:

- (i) that the debtor is present and acknowledges the debt;
- (ii) that the object is not foodstuffs;
- (iii) that the buyer of is not hostile to the debtor;

(iv) that the price is not of the same genus as the object of sale, as it may otherwise amount to *riba*; and

(v) that the price is paid promptly.

Some of these conditions are evidently concerned with the barter rather than the monetary sale. In the absence of a debtor, according to the Maliki School the sale of a debt is allowed. This is known as the change of mortgage (*qabl al-rahn*). In this situation, the mortgagee can sell the mortgage prior to the maturity of the loan if he needs money, to a third person who then becomes the mortgagee into the shoes of the original mortgagee. This change of mortgagees should be recorded in the mortgage register (Mahmassani 1983). *Hawalah* transaction is another example in which the credits are exchanged i.e., another person repays in the place of original debtor (*bay' al-dayn bi al-dayn*). It may be therefore, be concluded that the reason for the avoiding of sales of debt is (*bay' al-dayn bi al-dayn*) to remain on the safer side in order to avoid uncertainty and *gharar*.

Ibn Qudamah (1969) is of the view that a creditor who gives foodstuff on credit to someone, cannot sell it to another party unless he repossess the commodity. There is a remote and rare view that prohibition of debt sale, referred in the *hadith*, could be a reference to forward sale (*salam*), which a buyer cannot sell unless he acquires possession beforehand. Therefore, in a *salam* sale of foodstuff, a buyer cannot sell the commodity prior to acquiring possession. Renowned Maliki scholar, Ibn Rushd (1982) has opined on *salam* sales and has held that in *salam* sales delivery of the commodity is deferred but according to him price should be paid instantly or without any delay otherwise this may amount to a debt sale (*bay' al-kali' bi al-kali'*). Ibn Taymiyyah expressed the views of Imām Ahmad ibn Hanbal that he allowed the sale of the object of sale prior to delivery, by the buyer. As far as spot sales of specified tangible foodstuffs (*al-ta'am al-mu'ayyan*) are concerned, there is a prohibition of sale prior to taking possession. A debt is normally proven on the *dhimmah* of the debtor and when a debt is repaid it discharges the debtor's obligation no matter to whom it is supposed to be paid and by whom it is paid (Ibn Taymiyyah, 1977; Hamoud 1981).

It is claimed that there is a consensus (*ijma'*) on the prohibition of *bay' al-kali' bi'l-kali'*. Imām Ahmad Ibn Hanbal (1985) has stated that there is consensus (*ijma'*) on *bay' al-kali' bi'l-kali'* that it is not permitted. However, there is disagreement on the definition of *bay' al-kali' bi'l-kali'* and on its various forms. This difference among scholars is contrary to the claim, which suggest of consensus over the issue (Al-Shawkani 1975).

There is a narration from Musa ibn 'Ubaydah who reported from 'Abd Allah ibn 'Umar that the Prophet (peace be upon him) prohibited *bay' al-kali' bi al-kali'* (Al-Shawkani 1975).

There is a confusion on the exact meaning of word '*kali*' because this word was not known to the Arabs. However, it generally means the sale of one debt for another. The scholars of Islamic jurisprudence have doubted the authentic value of the *hadith* and this *hadith* is found in not many books of *hadith*. For example writer of al-Daraqutuni has quoted this *hadith*. In Nayl al-Awtar, Imām al-Shawkani (1975) has made a reference to this *hadith* from Daraqutuni and raised doubt its reliability and goes further by stating that Musa ibn 'Ubaydah al-Radbhi is the only narrator. According to Imām Ahmad Ibn Hanbal (1985) only Musa ibn 'Ubaydah al-Radbhi has quoted this *hadith* and there is no other *hadith* which he is aware to be quoted from Musa ibn 'Ubaydah al-Radbhi (Al-Shawkani 1975). Imām al-Shafi'i also considers this *hadith* to be a weak *hadith*. Ibn Qudamah (1969) and Ibn Taymiyyah (1899) do not find any other *hadith* on the subject and the *hadith* under discussion, according to both the scholars, is a broken one (*munqati'*). Majd al-Din 'Azzam also considers this *hadith* a weak one so that it cannot have a binding effect to be considered a binding rule in *shari'ah*.

There is view that debt sale is allowed if it is sold to the debtor himself and not to the third party because in the third party's involvement there are chances of uncertainty of delivery. Another view favours the sale to third parties as well. Some Hanafi, Maliki and also Ibn Taymiyyah (1899) have permitted this sale if the debtor acknowledges the debt as a liability on him. Ibn Taymiyyah (1899) further states that this acknowledgement of liability amounts to a tangible asset (*al- 'ayn al-hadirah*) which makes the transaction quite valid. Therefore, according to Ibn Taymiyyah (1899), a debt liability on one's

person may cancel a similar debt liability upon another person and none of the sources of *shari'ah* has prohibited this. Al-Darir (1997) goes for the permissibility of *bay' al-dayn* if it is devoid of *riba*; no matter what it is a sale to the debtor himself or to a third party, either on cash or either on credit. According al-Darir (1997), uncertainty is out of question if debtor admits his liability of debt (Al-Darir 1997).

It is therefore concluded that there is no general consensus on the prohibition of *bay' al-dayn* and in the absence of any consensus on its prohibition the maxim of permissibility in things will prevail (*al-asl fi al-ashya'-i-ibahah*) if free of *riba* and *gharar*.

In futures-trading offsetting amounts to debt clearance sale. For example 'A' purchases a commodity from the clearing house and subsequently sells to the clearing-house same commodity. 'A' need not make an agreement each time because offsetting and reversing a transaction is a set norm and practice in the exchanges performed by the clearing houses. Hence there is no uncertainty and unlawful gain involved because there is a proper mechanism of recording agreements. Buying from the clearing house by 'A' means, 'A' owes the clearing house the price to be paid which was later on offset by selling the same commodity to the clearing house and now the clearing house also has to pay the price to 'A'. Both 'A' and the clearing-house cancel their debts towards each other by selling and re-selling to each other. Further, the uncertainty is also out of question for there is no third party involvement over clearance and delivery.

A clearing-house acts like a guarantor on behalf of both the parties and becomes a principal party in reality. Identity of the original parties is out of question. In reality parties transact with each other with the help of clearing-house but technically each party actually transact with the clearing-house and then clearing-house becomes responsible for the delivery of the commodity and payment of the price. Therefore there is no uncertainty involved. Further to the above parties in futures-trading takes risk of loss by buying a commodity and makes profit if markets goes in their favour, therefore *riba* is also out of question.

We may therefore conclude that the *bay' al-dayn* which is incurred in futures transactions is in the nature of the fulfillment of an obligation and the repayment of a debt by the debtor. This is in line with the basic Qur'anic norm (5:1) in respect of the fulfillment of contracts.

3.9 SPECULATION AND GAMBLING

Human life is full of risks and uncertainty which is a reality on this earth. A man driving a car on a busy road is actually taking a risk to have an accident at any time either due to his own fault or due to the fault of another driver or even when nobody is at fault the car's brakes may get fail causing an accident. It may be said that future is related to our present day decisions and activities; whatever a man does today bears its fruit in the future and the relationship of present and future has effects from the surrounding reality, past experience and custom. A man, realistically, likes to strive for his betterment of future and anything he foresees as damaging, tries to eliminate or avoid it. So his knowledge of past and present helps him to perceive the future and in the light of this information takes measures to get the desired results. The future predictability could be possible through different techniques such as through scientific knowledge and experimental measures etc. For example a present day farmer could have better and more crops than a farmer of the past by using better irrigation system, medicine for plant diseases, better storage facilities etc. But despite all these facts our life is still cannot be claimed as risk-free and risk may be avoided in any manner without sticking to some specific techniques but surely there need to follow some rules and limitations. Risks are changing in the changing world; technology in the present day commerce is not only bringing benefits but it is also resulting in some new forms of risks. Therefore, human quest for self-development and growth is also generating new kind of risks. Indeed, a risk-free existence, however comforting an idea, has hardly held a great appeal for the imaginative side of the human intellect, nor has it ever been realistically attainable. Therefore, any development and novelty in commerce must be addressed by the law and these must be regulated with a flexibility to absorb any change in order to accommodate such changing commercial realities and custom.

3.9.1 A MARKET ANALYSIS OF SPECULATION

Speculation and gambling are mistakenly considered the same things but having different names. But at the same time there are others who think both are different phenomenon with any resemblance between the two. It is said that futures-trading has element of speculation in it which may be acceptable if not excessive but gambling without any doubt is impermissible. The coming paragraphs will analyse both the concepts and the permissibility of futures-trading is dependent upon the result of this analysis.

One of the distinguishing determinants between the two is the element of risk and its expected contribution to the social good of the society. Gambling involves the creation of a risk for the sake of risk, which serves no social good to the society. For example horse racing and poker games are the sources of risk creation and a gambler in his own capacity either creates a risk or assumes an already existed risk which has no concern with him, through betting and wagering. Therefore, it is upon the gambler not to get involved in the risk business. Thus a financial risk in which a loss could occur, may be avoided by the gambler because it is him who either creates it or get into it despite having no concern with it. On top of that as stated earlier gambling is not beneficial for the society.

Investing is a different phenomena in which one who invests capital in a business expects some profit out of that. The commitments in terms of capital that are longer than several months qualify as investment, regardless of whether the commitment is in securities, real estate or commodities (Teweles and Jones 1987; Fink 1988; Siddiqi, 1985).

Speculation is not easy to define. One of the accepted definitions of speculation is 'the purchase and sale of an asset in the expectation of a gain from changes in the price of that asset' (Cootner 1968). The reason for difficulty to define speculation lies with the difficulty in differentiating the three concepts of investment, speculation and gambling. A slight variation in any of them may eliminate the differentiating line in these concepts. This may better be explained through examples:

(i) 'A' and B both buys and sells a commodity in future respectively in order to benefit themselves from this deal. Here A is speculating the rise of prices in future so that he may

earn some profit in the future by selling it and B is speculating a price drop in future therefore B is selling the commodity.

(ii) In the above example if both A and B having no concern whatsoever with the concerned commodity and both are not involved in selling or buying it, just bet on the price of that commodity whether it rises or it is going to fall in the future. In this situation both are gambling which has no benefit to the society in any manner.

(iii) A is a football enthusiast. He meets a young player and decides that with some expert training, he could become a champion. He offers to contribute £50,000 toward one year's training and promotional expenses in return for thirty per cent of the player's earnings, which he believes could be £1 million. Is A a gambler, a speculator or an investor? What if instead he gave the player £50,000 per year job as a part-time chauffeur and bet one each of his prize-winning games? What if the player became an incorporated company and A bought thirty per cent of the stock for £50,000?

From the above examples, it is difficult to distinguish between investment, gambling and speculation, but difference lies in the economic results in each situation involving one of these. These may be differentiated from each other by looking into the motives of the parties and economic effects of the transactions (Fink 1988).

Speculation is something present inherently in a commercial activity of a commodity, goods or services. A person has to speculate on any item prepared for commercial purposes. For example a producer of a car speculates whether the car is good for sale or not and then produce it. A car dealer will buy the stock of that particular on speculation of that being sold at a good profit margin than other cars. Finally a buyer buys that car with speculation of that the said car will perform better than others in the market. So speculation is very much there regardless of the fact that market is future or not. If not the speculators then there are others who may be willing to speculate. Now, the point of concern is to determine whether only the producers and consumers are going to bear this risk of rise and fall of the price of a commodity or this risk may also be spread to other parties through market functions such as investors, governments etc.

There may still persists a confusion between gambling and speculation in futures trading. This confusion may be cleared by highlighting a very delicate distinction that in speculation in futures, risk is shifted from one party to another who is willing to take it, which may turn into a profit or the vice-versa but it has beneficial economic facts to the society. So speculator is one who forecasts, wisely, the future trend of prices based on his observation, evidence and knowledge of the past and existing environment of the market (Fink 1988). Therefore, a speculator, in order to prove his stance on price movements, risks his capital either by buying it or recovers his invested capital by selling the commodity. Thus a speculator in commodities assumes a genuine commercial risk, different from a gambler's one, which is created by the rules of the games (Courtney and Bettelheim 1986).

One of the main criticisms on futures trading is the violent price movements, which damage the market stability and hence genuine producers and consumers. However with the introduction of new regulatory and punitive legislative measures, such manipulative practices have been discouraged and hence stopped (Teweles and Jones 1987). Further, speculators are not the major market players (Teweles and Jones 1987; Courtney and Bettelheim 1986) and any price fluctuation is the result of supply and demand in the future market. On the contrary, a research suggests that speculation helps in smoothing the price movements rather than violently increasing it (Teweles and Jones 1987; Courtney and Bettelheim 1986). Therefore, speculators cannot be said to artificially manipulate pricing of commodities (Courtney and Bettelheim 1986). Further to the above, in comparing to stock exchanges, commodities are less prone to price fluctuations due to two limitations: the 'daily limit' and the 'daily range' (Gup 1986). There could not be established any link which suggests that speculative activities in futures cause price fluctuations in the cash commodity market. This is due to the fact that there are other factors in the cash market which affects the commodity prices which is supported by some empirical research (Relly 1985). Statistical analysis shows that the volatility of futures prices is approximately the same as that of equity prices (Gup 1986). Actually, opposite to the stock exchange, in the futures market, low margin requirement, which is

the cause of provision of high degree of leverage and that results in speculative risk-taking activities.

Speculative trading practices may be seen in other areas such as land, precious stones and metals, oil, stocks and bonds, and rare items such as stamps and paintings. There need to have some trading skills due to some of their unique characteristics. These are all motivated by profit earning and similar is the case in futures trading. In futures trading, market players or in other words speculators get help from the information on the price trends of commodities, which is affected by important political economic factors. This information is available through different media such as print-media, multi-media and internet etc. The futures speculator must in the long run be primarily concerned with the real forces of supply and demand, whereas speculators in stocks must know about both the markets of the companies in whose stocks they are speculating and the market for the stocks themselves. High market liquidity, for example, through offsetting, causes motivation for speculation in futures (Teweles and Jones 1987).

3.9.2 QIMAR AND MAYSIR

Gambling and games are related to each other from the ancient times. Gambling is known as *qimar* in Arabic which may be defined as 'a combative relationship between two contracting parties, each of whom undertakes the risk of loss and that loss of one means gain for the other' (Al-Misri 1993). Gambling may be termed as a robbery with mutual consent or it may be taken as a violation of the law of equivalence. Gambling is a game of chance, which in turn arbiter one's conduct by subverting the moral order and stability of life. Gambling motivates one to material gain and unwarranted reward via impulsiveness and takes him away from the pursuit of worthier activities in life (The Encyclopaedia of Religion and Ethics 1908). Gambling is actually harmful for the society, which does not bring any positive change in the society or co-operation in business community. It promotes combativeness and the desire to win against each other, which is harmful for a civilization process (Waliyullah 1936).

Gambling has clear prohibition in the Qur'an and is characterized as a morally unclean activity which sows the seeds of enmity and hatred among fellow human beings, creates barrier to piety, spiritual awareness and the remembrance of Allah (SWT) (5:90-91). According to Ibn Taymiyyah (1977) the damages of gambling are more than *riba* because it is a product of two evils vis-à-vis., unwarranted gain and unlawful game and both are *haram*.

The word *maysir* derives from *yasira* means 'to be easy', and *yassara* means an easy success over something of value without any labour. There are only three permitted ways of acquiring properties vis-à-vis., by gift, inheritance, and by exchanging counter-values. Therefore, gambling cannot be included within the legitimate modes of acquisition of properties and it is against the concept of equal distribution of wealth. Ibn Qayyim has regarded *maysir*, which the Qur'an has forbidden, equal gambling. In *maysir* there are two competing parties, who play a game of chance and the winner is paid by the loser (Ibn Qayyim, 1990:123). Gambling is called *maysir* because the gambler acquires wealth without any effort. It is synonymous with *qimar* and defined by Abu Jayb as 'every game over property which the winner then takes from the loser' (Abu Jayb 1988). Al-Jurjani (1909) has more or less the same definition of *qimar*, which is 'taking one thing after another from one's partner in a game', or 'a game with the condition that the winner (*ghalib*) of two contestants gets something from the loser (*maghlub*)'. According to Al-'Arabi (n.d) 'each one of two contestants seeks to defeat his partner in an action or statement in order to take over property that is set aside for the winner.'

Rosenthal (1975) has defined *qimar* as 'a contact among two or more persons involving the exchange of money or other valuables depending upon the uncertain outcome of a staged event'.

The *maysir* based on the Qur'anic principles may be elaborated as an apparent agreement between the two parties having immoral motive of gain to be paid by the person who loses. Siddiqi (1985) has stated that the present day gambling is similar to the *maysir* in pre-Islamic Arabia. In gambling the parties create a risk together and one wins on the expense of the other in an event not a necessary part of any of the normal activities of

life. In an insurance contract there is also a risk upon assuming that a party gains but that is associated with the normal activities of life, and that insurance serves a useful purpose in that.

There is a difference of opinion about whether or not *maysir* in the Qur'an covers all kinds of gambling. In *hadith* it seems that *maysir* is any gambling activity, which could be the throw of arrows or through the usage of some sources. In primitive Arab society, arrows were used to distribute the portions of a cattle among a group of ten persons. The person responsible for distribution was known as *yasir* and arrows used for such division were used to bear the names of the recipients to be drawn at random out of a bag. The game was considered a pagan practice and the Qur'an forbade it along with wine and idols as a major sin. Among other devices of gambling were dice which people used to throw for gambling. Throwing dice was prohibited through a *hadith* which indicates *maysir* is applied also to dice: 'These accursed dice are the *maysir* of Persia (*maysir al-'ajam*).' According to Rosenthal (1975), the dice (*fass, ka'b, ka'bah*) used in games were usually two in number and that the word *qimar* is used for dice playing. Horse racing was very popular in the Arab world and during the rule of Abbasids, non-participatory betting on horse races was also practiced.

Rihan, in the Qur'an (2:283) means security deposit for a loan. But it means betting and is related to *maysir* and in the *hadith* it is used in the meaning of betting. *Rihan* is similar to *qimar* and *maysir* and each one of these is forbidden. *Rihan* differs from the two in that in *rihan* unlike *qimar* and *maysir*, parties do not participate in the activity rather bet from the outside on the results of an event, activity or game which may be a sporting activity such as running, wrestling, or a horse race. It may be an event, for example, between Abu Bakr and the pagans of *Mecca* on the Romans' victory over the Persians (Qur'an Chapter 22). Therefore, in betting there are two kind of parties, the actual players and the betters outside of the game or event. Further, contrary to gambling, betting is not necessarily a zero-sum game because the gain and loss of the parties are not reciprocal which means the gain of one party may or may not be the same as the loss of the other party. There is another technical difference between *qimar* and betting that in betting, betters have no

concern in the betting event or activity which is not the case in *qimar* where parties cause the event or activity. For example holder of a lottery ticket is out of control of the activity. Besides these differences *rihan* is not allowed like *qimar* because it being a game of chance between two parties in which one gains at the expense of the other's loss (Rosenthal 1975). There are some exceptional cases of *qimar* and *rihan* which were granted acceptance for example permission in the case of military need or permission of the throwing of lots (*al-qur'ah*) in certain legal situations where no better alternative can be found to determine the position. In certain Muslim states a lottery for national charitable purposes has also been allowed (Rosenthal 1975).

According to Ibn Taymiyyah (1899) a contract of sale with the element of *gharar* is like 'devouring the property of others illegally' (*'akl al-mal bi al-batil*), and in that case it is like *qimar* and *maysir*, which are clearly forbidden. A party to a contract who does not receive his part of the due contracted item in addition to a risk denying his rights then the contract involves both *gharar* and gambling at the same time. According to Ibn Taymiyyah (1899), the Prophet (peace be upon him) forbade such sales of *gharar*, which lead to gambling. Allah (SWT), in the Qur'an, has forbidden the unlawful devouring of the property of others, and it in the usury and gambling (*riba* and *maysir*) and the *sunnah* is an interpretation of the Qur'an.' Therefore according to Ibn Taymiyyah (1899) misappropriation of the property of others is common in *gharar* and gambling which makes both of them impermissible.

Ibn Taymiyyah has referred to a Qur'anic verse which is:

"Devour not each others' properties unlawfully unless it be through trading by your mutual consent (al-Nisa', 4:29)."

'Unlawful devouring' may include gambling, fraud, usurpation, bribery and profit gained from unlawful transactions. The verse under discussion is with reference to some kinds of sales of pre-Islamic Arab society, such as, *bay' al-mulamasah wa al-munabadhah*, the sales of cloth when the buyer touch it, or throw it in a certain direction, and sale of an unborn animal (*habal al-habalah*). In view of Ibn Taymiyyah (1899) if sales is

accomplished prior to buyers viewing of the object of sale, it contains risk and gambling (*mukhatarah wa qimar*) because nobody is certain about the quality or other specifications of the object of sale. If a sale accomplished in this manner and buyer has to accept it, it amounts to gambling and gambling unanimously prohibited by the scholars. However, if a party get chance to see the object of sale and the seller informs the buyer about it, the sale will be conditional i.e., *bay' al-mu'atat* (give and take sale) and in such sales there is no question of gambling. Ibn Taymiyyah (1899) analyses the sale of the unseen (*bay' al-ma'dum wa al-majhul*) and the sale in which delivery is not possible with the situation stated above, with a focus on the question whether or not there is any element of unlawful appropriation (*'ak al-mal bi'l-batil*). If there are any traces of unlawful appropriation (*'ak al-mal bi'l-batil*), this will amount to gambling. And gambling is found when one party takes his due while leaving other at risk and uncertain about his share in the contract.

3.9.3 APPLICATION OF ABOVE INTERPRETATION TO FUTURES

In light of the above discussion, it is perceived that Ibn Taymiyyah regards that according to Qur'an, *maysir* contains the element of risk-taking leading to the unlawful gain of one party at the expense of another. Now applying this understanding on futures trading that whether risk and speculation involved in futures leads the other party prone to unlawful gain and misappropriation of his property. In futures trading there is no dishonest intention of any part to gains the others property unlawfully. Risk-taking is very much inherent in the commercial transactions and the only form of risk forbidden are *qimar* and *maysir* and one must determine first whether futures contain these elements. Whenever a party involves in a commercial transaction he gets ready for both profit or loss, which depends on market conditions and other factors but it is the excessive *gharar* and *qimar* which is forbidden. Risk-taking becomes gambling if created for its own sake without a beneficial economic activity or trade (Al-Misri 1993). Speculation if made based on knowledge and market conditions about the future course of the market then it is not against the *shari'ah*. To see whether a speculation is genuine or not, intent of the parties must be looked at; or its fair intention could be established, which distinguishes

speculation from investment from the fact that whether an investor holds his investment for a certain length of time (Khan 1988).

As stated earlier *maysir* and *qimar* involves two parties in a game of chance which aims at winning one at the expense of the other. This form of gain is not permitted because it is harmful and there is no productive commercial activity. Speculation in futures different and is based on commercial risk-taking, which is permitted and not on *maysir* and *qimar*. This also involves profit or loss without any intention to gain at the expense of the other. The profit or loss in futures is realized at the time of offsetting or maturity but not at the time the contract is concluded. In futures-trading, a party hedge the risk of loss by taking positions and this is not a creation of him or them but the risk already exists unlike gambling. Further the risk in futures is not a risk which is un-warranted but a commercial risk which involves trading and one may gain and the other may loose but this all takes place according to normal trading practices with the mutual consent of the parties, which is permitted. Therefore, in futures element of devouring the property of others is absent which makes it gambling.

Speculation is part of commercial activity but excessive speculation may lead a permitted transaction to *gharar* and therefore to gambling. The dividing line between the speculation and gambling is very delicate and thin and these are the regulations and laws, which help in keeping this division. For example imposition of quantitative restrictions on daily trading volume and position limits the speculation within permitted zone. Further to the above, with the advancement in technology, new products and techniques are being introduced in the market and it is not possible to check the authenticity and legality of a product or process unless one tests through experiments and verifies these products through practical application. Islamic financial products must be given and deserve the same opportunity.

3.10 CONCLUSION

Financial Engineering is defined as tools and techniques for developing new products and instruments. In Islamic finance, *shari'ah* principles are followed for product

development. With the involvement of increasing number of global agents in economics, new laws were formulated to regulate these activities. As a consequence these economic agents tried to devise new techniques and products to escape from the effects of these regulations. This leads to new product development such as derivatives in order to avoid the consequences of these regulations. Islamic instruments are likely to be more efficient than conventional ones. But these have to follow certain principles set out by *shari'ah*.

Derivatives like futures and options are subject to different laws than the laws applicable to conventional sales. Futures, forwards and options are devoid of *gharar* and do not fall under prohibition due to the prohibitive principles on speculation and sale without possession. Qur'anic verse of *mudayanah* (2:282) supports transactions with future obligations for a specified period of time. Derivatives trading may be allowed if adequate steps are taken to ensure that the transaction is a genuine trade transaction without any unnecessary element of speculative risk-taking. Derivatives are actually is the name of risk managing tool hence these are involved in risk taking activities too. For avoiding excessive risk taking and speculative activities regulations are promulgated.

In the current situation derivatives are being blamed for financial crisis. But the reality is, these are not the derivatives but the mismanagement in derivatives trading which lead the world into a financial crisis for every body was using derivatives for speculative purposes rather than hedging purposes. Speculation related to genuine hedging and that protects a trading position may be regarded as prudent and reasonable, especially when the underlying trade involves goods that are susceptible to price volatility. Speculation purely based on profit motive without the intention of protecting a real trading position against the risk of financial loss is actually prohibited. Therefore, commercial speculation can not be compared with gambling.

Shari'ah has forbidden any *gharar* and uncertainty on the existence of subject-matter at the time of delivery and it is not necessary the subject-matter be existed at the time of contract. In all sales immediate transfer of ownership and delivery should be made except in the sale of *salam* and *istisna'*. According to Ibn Qayyim, in a contract of sale the parties may agree either to defer payment of sale or delivery of the subject-matter. In

futures-trading, the delivery in open contracts is delayed but guaranteed through the mechanism of clearing-houses in the exchanges hence no *gharar* and uncertainty. In futures-trading one acquires liability when a contract is concluded and question of possession is immaterial.

A purchaser of an item may not resell it unless he gets possession over it but sale in futures derivatives may be made prior to take possession where the object of sale is not food-grains like cotton, rubber and tin. Further it is said futures involve *bay' al-kali' bi al-kali'* or *bay' al-dayn* but there is no general consensus on the prohibition of *bay' al-kali' bi al-kali'* or *bay' al-dayn* and in the absence of any consensus on its prohibition the maxim of permissibility in things will prevail (*al-asl fi al-ashya'-i-ibahah*) if free of *riba* and *gharar*. *Bay' al-kali' bi al-kali'* or *bay' al-dayn* which is incurred in futures transactions is in the nature of the fulfillment of an obligation and the repayment of a debt by the debtor.

CHAPTER 4

CRITICAL LEGAL AND SHARI'AH CONCERNS IN THE SUKUK MARKET

4.1 CURRENT SHARI'AH CONCERNS

It is important to be aware that *shari'ah* rulings on the same matter can be adjusted over time for a variety of reasons. Sometimes or rather often within Islamic finance, many aspects are permitted out of a concept called '*dharoorah*' or necessity whereby certain element of dubiety is accepted for the greater good on what is intended to be a short term basis. For example *murabahah* as a financing mode rather than purely a trade transaction is argued by some scholars to be a temporary acceptable measure. At other times, if the impact of even an acceptable practice is giving rise to consequential harm for example at a macroeconomic level, then permissibility of this activity may be withdrawn. This is also relevant for Islamic finance as to whether or not it is achieving the objectives of Islamic economics. It is being argued that the industry may be giving rise to inequality and concentrating wealth in the hands of the few rather than distributing across the many. Hence, within a *shari'ah* lifecycle, a *fatwa* given at one time can be withdrawn at another time or context. It should also to be noted that the aspect of an individual's intention in Islam is of the highest importance when conducting any transaction or any activity in life according to *shari'ah*. It must be for the right reasons and legitimate transaction. Although intentions by nature not necessarily provable in law-this highlights the religious nature of the *sukuk* lifecycle.

Usmani's paper and official Accounting and Auditing Organisation for Islamic Financial Institutions (AAOIFI) *fatwa* (2008) (judicial sentence) summarise certain concerns over *sukuk* issuance. Eight key issues have been identified from the 2007 commentaries and AAOIFI 2008 *fatwa* by Taqi Usmani. Tradable *Sukuk* must represent real ownership and

cannot represent financial streams or debt bar (except when selling of all assets or when they have been indirectly incidentally incurred). Incentivisation of managers has to be on an expected profit-basis and not cost-basis. Credit enhancement cannot be met through loans. Nor can purchasing of the assets be guaranteed or conducted at nominal value upon maturity except when the purchaser as a lessee is not a partner or agent. *Shari'ah* boards must oversee operational matters in addition to issuing *fatwas* on compliance. The failure of current *sukuk* practice and Islamic finance industry efforts as a whole in realising social justice as a higher objective of Islamic economics are also identified.

This chapter, thus, provides a critical analysis on the legal and *shari'ah* concerns in the *sukuk* market by referring to the actual *sukuk* structures available in market.

4.2 OWNERSHIP

Sukuk must ensure that *sukuk* holders have complete ownership in real assets. This is again emphasised in the AAOIFI *fatwa* of February 2008. A true sale is called for. "Tradable *sukuk* must represent ownership for *sukuk* holders, with all of the rights and obligations that accompany ownership, in real assets, whether tangible or usufructs or services, that may be possessed and disposed of legally and in accordance with the *shari'ah*" (AAOIFI 2008). Assets in the *sukuk* may be shares of companies that do not confer true ownership but which merely offer *sukuk* holders a right to returns. Such *sukuk* are no more than the purchase of returns from shares; and this is not lawful from a *shari'ah* perspective.

In *sukuk al-ijarah*, the lessee sells the asset to the lessor and leases it back. Therefore, an Islamic financial institution as lessor acquires the underlying asset. At the conclusion of *ijarah sukuk* leased assets are sold back to the original owner i.e., lessee. The ownership of the underlying asset in *Ijarah* lies with the lessor, hence, the lessor should bear all repair costs, other than routine maintenance and damage caused by lessee abuse or negligence. (Warde 2000; Vogel and Hayes 1998; El-Gamal 2002; Jobst 2007:1).

There is no specific definition of ownership in the AAOIFI (2008) *Shari'ah* Standard 18 – *Qabd* (possession) pertinent to *sukuk*. To add further confusion, the Securities

Commission Malaysia applies *sukuk* to all securities including shares, notes, unit trust and bonds (Bossuyt 2008). The *sukuk* must have an intrinsic value (Adam and Thomas 2004). The *sukuk* may represent debt obligations and may be issued for a pool of receivables – loosely defined as Islamic bonds or Islamic securities in Malaysia (Osman n.d).

It should be noted that the common label associated to ownership of the usufructs of assets uses term 'beneficial ownership'. Most commentators agree that Islam allows rights to benefits as form of ownership and use this as a basis of permissibility of *sukuk* issuance (Chowdhury 2008). However, this is clearly at odds with AAOIFI (2008) statement requiring representation of clear title to *sukuk* holders. Both current and future purchases of financial benefits subject to a lease or time-share as a subset of a leasehold estate are permitted under AAOIFI rules. But, there must be a clear acquisition of financial benefits and risks, and not merely the benefits in order to comply with Islamic rules. Full title in any form of entity or any person owning clear title to eligible assets, those assets which are not explicitly susceptible to *riba* may be documented as an eligible *sakk* for sale.

Discussions of True sale and bankruptcy remoteness are premised around asset ownership consequently, they are closely associated with issues of whether structures and transactions are asset-based or asset-backed. Ownership is interminably linked to pool's as a form of self-insurance. Indeed what is to be encouraged is the use of Islamic *takaful* (mutual pooled cooperative insurance) that is non-interest based.

4.3 PURCHASE UNDERTAKING

Virtually all of the *sukuk* issued guarantee by indirect means the return of principal to the *sukuk* holders at maturity, in exactly the same way as conventional bonds. This is accomplished by means of a binding promise from either the issuer or the manager regardless of their true or market value at maturity. To clarify Wilson's suggestion (2008), the 'guarantee' on respect of a purchase undertaking; it cannot include two contracts in one and the 'guarantee' of purchase has to be a binding promise according to Islamic law.

The AAOIFI *fatwa* of 2008 stipulates it is unlawful for a manager, whether a *mudarib* or a partner or an agent, to commit to repurchase of assets at face value or nominal value upon maturity (AAOIFI 2008). This is effectively in relation to fiduciary *sukuk* such as *sukuk al-musharakah*, *sukuk al-mudarabah* and *sukuk al-wakalah* (Lahsasna and Idris 2011). Instead, their resale must be undertaken on the basis of the net value or market value of the assets, or at a price that is agreed upon at the time of purchase (AAOIFI 2008). Purchasing at the face value can only occur in cases of negligence or non-compliance of stated conditions (AAOIFI 2008). Repurchase does not allow it to be at the original value as this would alter the *sukuk* to be tantamount to a *riba* contract. In true commercial enterprises, where the *shari'ah* is concerned, the return of investors' capital cannot be guaranteed (Lahsasna and Idris 2011). In *shari'ah* compliant dealings, reward always follows after risk (Thomas 2006a).

However, in the case of *sukuk al-ijarah*, AAOIFI allows the lessee to agree to purchase the leased assets when the *sukuk* are extinguished for their face (nominal) value, as long as the lessee is not also an investment partner, *mudarib*, or agent. The sale-and-lease-back technique does not create any *shari'ah* related problem as considered by some writers on the subject. Assets leased under this technique can again be sold to the original owner as in case of most of the sovereign *ijarah sukuk* issued so far. *Shari'ah* scholars suggest, however, that in such cases the client should purchase back the asset at least after one year of sale. It is to ensure that the technique is not used as back-door to interest (Ayub 2005).

The famous Gold *sukuk* from the Dubai Metals and Commodities Centre Authority issued a USD200 million *musharakah sukuk* (joint venture) backed by the sale of three residential tower complexes was guaranteed by originator would be required to purchase *musharakah* units from the issuer and not the commercial property.

Moody's (2007) also points out that if *sukuk* holders benefit from a purchase undertaking there are several consequences; they are unlikely to be able to realise asset value independently, they are not protected from originator insolvency and they have an

unsecured claim on the originator (like conventional borrowing). Credit risk is hence, comparable to conventional debt.

4.4 ISSUES PERTAINING TO SUKUK AI-IJARAH

The major criticism of *ijarah sukuk* is that the return is usually benchmarked to the LIBOR on USA dollar funds or the equivalent local rate in the case of issues in Malaysian ringgit. This interest rate, although it is only used for pricing, and the payments associated with the *ijarah* can be regarded as rents, the close link of the interest based pricing with *riba* worries many *shari'ah* scholars (Wilson 2008). The mainstream *shari'ah* experts have permitted the benchmarking with any interest rate reference, although it is not an ideal practise to them (Usmani 2005:168-171).

All sovereign *ijarah sukuk* issued so far carry the guaranteed and benchmarked fixed rate. In addition there is also no third party guarantee or any provision for the lessor to bear any ownership related liabilities (Ayub 2005). Further, sovereign *ijarah sukuk* transaction as a whole normally involves five or six Agreements all of which have been made as integral parts of the main contract (Ayub 2005). The bearing on *shari'ah* compliance from the sequencing of these agreements is not known. Payment of rentals has been guaranteed in the contract itself in the form of contractual obligation of the sovereign to pay the rent. The majority of experts in *shari'ah* related finance are concerned that sovereign *sukuk* are fixed income instruments equivalent to interest based bonds (Ayub 2005).

Here the case of the sovereign *ijarah sukuk* structure towards the QGS is highlighted in. The asset is a parcel of land is intended for the proposed development of the Hamad Medical City in Doha, Qatar. The QGS was issued by the Government of Qatar in 2003. A joint venture SPV, the QGS, was incorporated in Qatar with limited liability. This SPV acquired the ownership of land parcel that was registered in the name of Halal Monitoring Committee. The land parcel was placed in trust and *ijarah*-based TCs were issued worth USD700 million due by October 2020 at an annual floating rate of return of LIBOR plus 0.4 percent. The QGS issued on Sep 30, 2003 over 7 year for USD700M with coupon payments at 6m Libor+0.40 and rated by Standard & Poors at AA.

Figure 4.1: The Qatar Global Sukuk

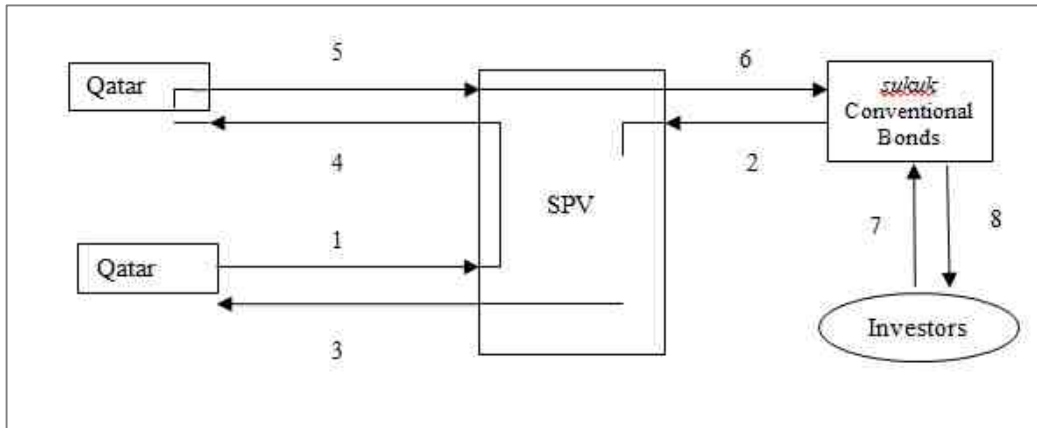

Source: IFQ Investors

- (i) The Government of Qatar sells land parcels valued at USD700 million. The *sukuk* issuer, the SPV, is established to buy one of the parcels of land.
- (ii) Proceeds from the *sukuk* issuance fund the SPV, which is then able to contract with the Government. The SPV undertakes to sell the property to the Government at the end of the term or subject to specific redemption conditions.
- (iii) Following the signing of the purchase agreement, the issuer, the SPV, pays a purchase price of USD700M to the Government, which sells it a specific land parcel (free from all claims and encumbrances and with all attached or accrued rights).
- (iv) The SPV leases out the land parcel under a Master *Ijarah* Agreement to the Government of Qatar, effectively a ground lease. Under the terms of the ground lease, the Government agrees that the Issuer shall not, under any circumstances, be liable to expense of any kind or nature caused directly or indirectly by, or out of, the use of any part or the whole of the land parcel. The Government controversially agrees to indemnify the issuer against all and any such costs, claims, demands, losses, damages and expenses. In effect the issuer is not concerned with the construction of the hospital, its success or failure, or whether or not the Government ever uses the site for any purpose.

- (v) The Government of Qatar pays semi-annual lease rentals under the Master *Ijarah* Agreement, which are calculated by reference to (i) LIBOR plus the margin (ii) beginning in April 2006, and Amortisation Payment. The two amounts equal the periodic distribution amounts payable on the periodic distribution date coinciding with the rental payment date for such rental. Rentals will be recalculated semi-annually based on LIBOR.
- (vi) The SPV disburses semi-annual distribution payments equal to the Government's rental payments.
- (vii) Investors (both Islamic and conventional) purchase the *sukuk* instruments.
- (viii) The investors are reimbursed periodically by the distributions from the SPV funded by the Government rental payments on the land parcels. The investors enjoy the irrevocable undertaking of Qatar to buy the land parcel.

It should be noted that the predominant form of *sukuk al-ijarah* used by many issuers has not been accepted by Saudi Arabian scholars. They consider this a purchase combined with a resale at fixed price rather than two unilateral undertakings (MEED 2007). This has led to the SABIC (a multi-national Saudi conglomerate) innovating in conjunction with HSBC, a new *sukuk al-istithmar* (MEED 2007). It is characterised by investment in intangible rights (operating business), coupon payments are derived solely from income generated by the business (DIFC and Clifford Chance 2009). There is no guarantee or liquidity facility-risk remains and one unilateral undertaking (no call option) (Al-Sudairy 2008). This *sukuk* was also used for Saudi Electricity Company (SEC) in its issuance for servicing meter readings (Al-Sudairy 2008). *Sukuk al-istithmar*'s structure is provided in Figure 4.2.

Figure 4.2: SEC Sukuk: Illustration of Sukuk Al-Istithmar Structure

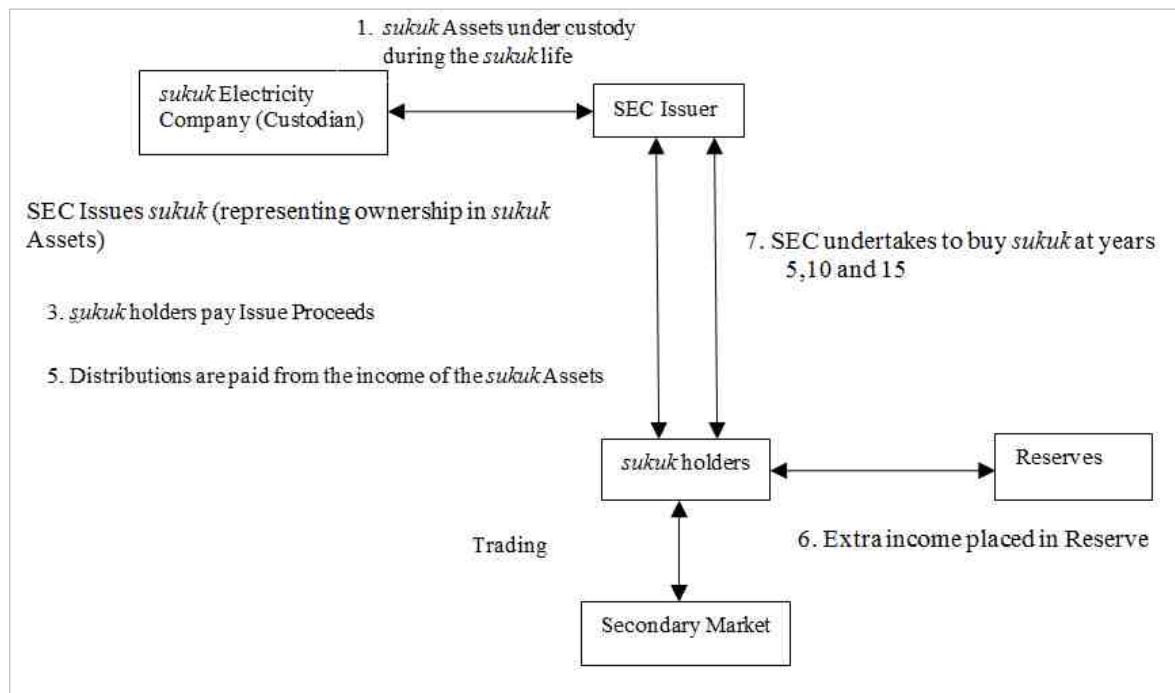

Source: HSBC, 2008

4.5 INTERNATIONAL ELEMENTS OF SUKUK REGULATION

There are loopholes in the regulatory regime to regulate the financial institutions and their managers, which led to the subprime crisis. Regulations may be fixed by focusing on “paradigms” through which one sees finance. There are three paradigms: (i) the agency paradigm (ii) the collective welfare paradigm; and (iii) collective cognition paradigm.

In the agency paradigm, managers with ill intent get advantage of the less informed and keep the best for themselves while leave bad for others (moral hazard). In the collective welfare paradigm, managers have no ill intent but focus only on their private costs and benefits regardless of the costs and benefits of the society. The *collective cognition paradigm* exists where owing to certain difficulties and hurdles one cannot understand the dynamics and internal workings of the system as a whole. (Torre and Ize 2009:1-2).

This researcher argues that there is perhaps evolving a fourth paradigm shift in regulation is evolving to cater for global influences. Certain elements of financial markets are

already being catered through the Bank of International Settlements (BIS) through the Basel Accords (1988 and 2001) for capital adequacy requirements and IOSCO amongst other matters. However, it is on a disparate segregated basis. As the examination of regulation towards Islamic finance will highlight, it may not be possible to accommodate or legislate for all developments within a particular financial sector by a single nation state. There is a need for co-operation and perhaps trust within an increasingly international focus to deal with the inter-dependency of financial institutions and products. This is a relevant consideration for Islamic financial products such as *sukuk*. The IOSCO (2004) provides global guidelines and international regulatory standards for securities issuances. The key issues identified for Islamic capital markets and products (in both conventional locations and elsewhere) are:

- (a) the regulatory framework governing Islamic capital markets;
- (b) *shari'ah* compliance and convergence;
- (c) the range of products in this market segment;
- (d) cost factors involved in transactions (including tax-related issues affecting Islamic capital market transactions);
- (e) development of market professionals;
- (f) investor education; and
- (g) knowledge sharing.

To what extent the UK Financial markets are in a position on these key issues will be explored by the research. The first three issues seen as risks and challenges by the FSA (2007) are shown to be pertinent for further study below. A risk management framework for UK *sukuk* regulation is seen to be necessary along with mitigation for provision (Zaidi 2007).

European Union (EU) legislation is increasingly important for member countries. Consequently, there may well arise a pan EU regulator for financial systems in the future. The Initial Report of the Committee of Wise Men on the Regulation of European Securities, saw no current need for regulation to integrate on a pan-European basis at

present (Lamfalussy 2003). It did encourage the co-operation and co-ordination of regulators between different member-states.

The FSA is required to take into account the internationalisation of markets and the consequential impacts for regulations. Globalisation impact on financial systems, and institutions for example arising from derivatives and currency speculation on a global stage has increased the likelihood of volatility and instability. The role of the International Monetary Fund (IMF) and World Banks or institutions that have similar objectives may well become increasingly important.

However in the USA there is complex dual system of Federal and State authorities responsible for regulation with multiple bodies catering for different aspects of the financial system. This is similar to the UK approach following the Big Bang² between 1986 and 1997. The main federal agencies are the Federal Reserve System, the Federal Deposit Insurance Corporation (FDIC) and the Comptroller of the Currency. Historically, there have been numerous market failures within the USA. One such more recent example is the Savings and Loan Crisis in the USA during the 1980s. This arose from financial deregulation, increased competition and the availability of deposit insurance (Demetriades 2003). This is not likely to change imminently argues Briault quoting Alan Greenspan (Briault 2000).

There are several Islamic supra-national organisations that have also evolved over time that are focused on the development, corporate governance and regulation of the industry. These carry increasingly considerable weight and influence of the *sukuk* industry and Islamic Finance in general. They are identified in Figure 4.3. The most prominent of these is the IFSB inaugurated in Malaysia on November 3, 2002 initiated by central banks and national monetary authorities together with the support of the IDB, the AAOIFI and the IMF. It is an international standard-setting body of regulatory and supervisory agencies with the aim to ensure stability and soundness of IFSI by developing new, or

²The day of deregulation for the securities market in London. On that day LSE become a private limited company and it was revitalized with the allowance of outside corporations to enter its member firm and with the establishment of automated price quotation.

adapting existing, international finance standards consistent with *shari'ah* principles and harmonisation of practices within the Islamic finance service industry.

The IFSB comprises of 187 members, which includes 53 regulatory and supervisory bodies, 8 international inter-governmental organisations and 126 market players, professional firms and industry associations operating in 43 jurisdictions. It does not appear that the UK government has any direct representation itself on the IFSB. In March 15, 2005, the IFSB issued exposure drafts of prudential standards on risk management and capital adequacy for the Islamic financial service industry. In 2006, it issued standards on corporate governance. In April 2005, the IFSB also started preparing standards on the supervisory review process as well as transparency and market discipline.

In 2007, it issued standards on Disclosures to Promote Transparency and Market Discipline for Institutions offering Islamic Financial Services; and Guidance on Key Elements in the Supervisory Review Process of Institutions offering Islamic Financial Services. In 2008, IFSB issued Guiding Principles on Governance for Islamic Collective Investment Schemes (CISs) and in 2009 on Capital Adequacy Requirements for *Sukuk*, Securitisations and Real Estate investment; Guiding Principles on Governance for *Takaful* (Islamic Insurance) Undertakings; Guiding Principles on Conduct of Business for Institutions offering Islamic Financial Services; Guiding Principles on *Shari'ah* Governance Systems for Institutions offering Islamic Financial Services. In 2010 it issued Standard on Solvency Requirements for *Takaful* (Islamic Insurance) Undertakings and in 2012 it issued Guiding Principles on Liquidity Risk Management for Institutions offering Islamic Financial Services and Guiding Principles on Stress Testing for Institutions offering Islamic Financial Services

Figure 4.3: Pan Islamic National Regulators



Source: Adapted

4.6 SPECIFIC SUKUK LEGAL REQUIREMENTS

For *sukuk* issuance careful examination is required of (1) the transfer of the assets from the originator to the SPV and (2) the priority, perfection and enforceability of the security interests granted in the securitised assets provided as collateral (McMillen 2006). McMillen (2006) identifies the following primary areas addressed by legal opinions concerning *sukuk* issuance:

- (a) True sale of the securitised assets: whether the SPV issuer owns the transferred assets pursuant to a valid transfer, with perfected or perfectible title in the issuer, that cannot be re-characterised by a court as a secured loan or otherwise avoided in bankruptcy (such as pursuant to fraudulent transfer doctrines) and in a transfer

- that is unaffected by the bankruptcy of the originator for example ensuring a lien-free transfer, free and clear of all prior overriding liens;
- (b) Non-consolidation of the transferred assets into the bankruptcy estate of the originator and the issuer in the case of their bankruptcies;
 - (c) Bankruptcy remoteness protections to minimise the likelihood of an issuer bankruptcy and related mandatory distribution including limitation of recourse to the securitised assets;
 - (d) The collateral security structure, focusing on whether the security interests are first priority and perfected (or perfectible), and addressing the nature of the security interest, the enforceability of the security interest against third parties, perfection requirements (such as notices, registration and recordation), and the effects of bankruptcy on perfection;
 - (e) Enforceability of the transactional documents including contractual payment priorities and the extent to which they are enforceable in a range of circumstances; and
 - (f) Choice of law and whether the choice will be upheld as valid by enforcing authorities in at least (a) the jurisdiction whose law has been chosen as governing the transactional documentation, (b) the jurisdiction(s) whose law governs the formation of each of the entities involved in the transaction, and (c) the jurisdiction in which the assets are located.

4.7 SHARI'AH CONFLICT WITH LEGAL CODES

In Muslim countries, there are issues arise from whether Islamic law governs securitisation transactions by substance or by form. If Islamic law is treated as a matter of substance and upholds commercial law it would not exclude investor claims for example in bankruptcy remoteness. If the transaction is governed solely by *shari'ah* law as a matter of form, Islamic courts can override commercial legal concepts. These issues have relevance for structuring and issuance of global *sukuk*. However, bankruptcy and dispute resolution incidences from defaults are currently rare and legal processes remain untested. Much depends on the extent to which the *shari'ah* is or is not incorporated into the secular law of the jurisdiction.

For example in GCC the clerics sitting in judgement over a dispute will consider the national laws, but first and foremost they will be concerned to ensure that any dispute is by reference to *shari'ah* law. Furthermore, remedies for breach of contract are at the discretion of the *shari'ah* court and compensation will normally be limited to the amount of any direct loss, rather than allowing for punitive or consequential losses. The local courts are unlikely to regard decisions in previous cases as a precedent unlike in western Courts. Many Islamic jurisdictions will not enforce foreign judgments and, even where they will enforce foreign arbitral awards, may infuse the *shari'ah* into a review of that award pursuant to public policy doctrines. McMillen (2006) highlights the great degree of discretion in a court in these jurisdictions as well as the uncertainty of remedies within these jurisdictions. Additionally the time frame for enforcement of contracts in a specific jurisdiction and whether inability to enforce within a compressed time frame will effectively not help proceedings for remedies.

Islamic jurisdiction is not bound by precedent and legal opinions may deviate from previous decisions made by other *shari'ah* scholars even within the same juristic schools contractual uncertainty. The complexities summarised by Fitch (2005) did not differentiate between conventional securitisation and *sukuk* structures. The issues presented depict the concerns as these between western legal systems and the local laws. However, the issues themselves give rise to even *shari'ah* concerns of the validity of the structure itself for example regarding asset ownership. Correlating the opinions of McMillen (2006), Norman (2004) and Fitch (2005) the following table summarises the legal concerns of *sukuk* within primarily Muslim countries:

Table 4.1: Legal Issues in GCC Domiciles

| | |
|-----------------------|--|
| Choice of Law | Offshore structures can be used. Contracts can be drafted to select a western governing law. Where significant assets are physically located in the <i>shari'ah</i> jurisdiction the uncertainty remains high. |
| True Sale | None of the draft legal opinions viewed to date contain a clear statement that a perfected transfer of title has been achieved. |
| Non-Consolidation | In reference to a multi-tier SPV <i>sukuk</i> , it is difficult where a parent company rather than an orphan SPV structure is adopted. |
| Bankruptcy Remoteness | Fitch had not seen a legal opinion confirming that non-petitioner limited-recourse clauses are enforceable. |

| | |
|--------------------|---|
| Security Structure | Problems exist confirming that investors will have first priority security interest over the collateral. If a <i>sukuk</i> structure is used, by definition the investors should have first priority over the assets. |
| Enforceability | To date, the rating agencies and the lawyers who have been asked to provide enforceability opinions have been of the opinion that there is insufficient predictability and certainty to permit the rendering of sufficient enforceability opinions in these jurisdictions. Fitch has significant reservations about uncertainty of enforceability in <i>shari'ah</i> jurisdictions. |
| Taxation | Lovells (2007) argues that tax regimes of the GCC and MENA are generally unstable. Hence, a case-by-case approach is required. |

Source: Collected from different Sources by the Author

4.8 PRICING SUKUK

The salient issue of competitive pricing for *sukuk* (Jobst 2007) is dependent on several aspects such as taxation and ratings. Market behaviour for *sukuk* is different; current patterns of investors buying to hold are predominant unlike those trading volumes for conventional bonds. This will impact upon the element of the pricing mechanism of *sukuk*. Due to the complexity of *sukuk* and inertia arising from *shari'ah* compliance in the face of a lack of standardisation, there are unduly high transaction costs. However, the desire for standardisation should not be limiting the innovativeness and breadth of *sukuk* arrangements.

The key determinants of value; time, cash-flow and risk are relevant for *sukuk*. It should be noted that a key aspect of inclusion in the pricing element is understanding the time element of value from an Islamic perspective. Contemporary Islamic scholars accept the discounting of cash flows but not towards the lending of money. The *sukuk* will have definite maturities as per bonds if set up as an *ijarah sukuk*. There will be a risk uncertainty trade-off. Equity based floating rate *sukuk* are likely to be more risky with higher returns than fixed-rate *ijarah sukuk* structures.

Standard & Poor's (2008) highlighted that from an issuer's perspective, there appears to be a pricing gap-albeit small and narrowing-between *sukuk* and conventional debt instruments. There are two key reasons for this. The first relates to issuance costs, with

sukuk requiring somewhat more complex legal structures and consequently entailing higher advisory fees. The second is that investors may demand higher rates of return from *sukuk* to compensate for their relatively illiquid nature, their smaller market size, and the lack of proven legal and bankruptcy systems in issuers' jurisdictions.

The implications of linking practice of global sovereign *sukuk* coupon payments to LIBOR although currently pre-dominant may not be categorically acceptable by *shari'ah* at a future point in time when Islamic Capital markets are developed further.

A country is recognised through its currency and the country of issuance of a *sukuk* through the currency may be known through the currency which denominate *sukuk*. The Malaysian ringgit is dominating *sukuk* issuance which reflect Malaysia is leading the world in *sukuk* issuance. The market for *sukuk* in Malaysia where mainly currencies are pegged, although there has been a recent tendency to issue in local currencies to avoid the decrease in value of the USA dollar. It is also to develop local secondary trading market in *sukuk* with the introduction of a new unified currency for the GCC countries. This could result in the new Gulf currency becoming the denominator of choice for *sukuk* issuance (Wilson 2008). It is also thought that anti-USA sentiment that is prevalent within the GCC and Malaysia is driving *sukuk* issuances increasingly towards other currencies.

Wilson (2008) highlights that *ijarah sukuk* typically pay at least 200 basis points over base interest rates. These basis points represent the sovereign or originator's risk factor (Jabeen and Javed 2007). Risk averse investors in *ijarah sukuk* are likely to also prefer lower volatility. He identifies that an *ijarah sukuk* with inter-bank rates used as the benchmark is like a floating rate note, where the market value of the note seldom varies from the maturity value, unlike a fixed rate bond. *Sukuk* yields are 10 to 20 basis points lower than conventional mainstream bonds (Zaidi 2007).

Wilson (2008) argues for sovereign *sukuk* pricing to be based on real macroeconomic variable such as GDP growth performance in addition to interest benchmarks. Hence, *sukuk* holders would be taking on some of the sovereign risk. By sharing risk with

governments and reducing their obligations, the risk of default with *sukuk* would be reduced and hence, they would be more favourably rated.

IMF report shows that in a rare empirical analysis of *sukuk*, that diversification by including *sukuk* in the investment portfolio could significantly reduce the portfolio's VaR (Value-at-Risk) compared to a strategy of investing only in conventional bonds of that issuer (Cakir and Raei 2007). The VaR approach measures the downside risk of a portfolio position as the maximum loss that can materialize at a future prescribed date with a given probability due to adverse changes in relevant asset and liability prices. The reduced VaR is not just due to the inclusion of an extra instrument in the portfolio but rather is a result of the very different behaviour of *sukuk* prices in the secondary market compared to conventional bonds. For example, they show empirically that in the case of Bahrain, where *sukuk* and conventional bonds have similar durations, the correlation of returns is still close to zero.

4.9 RATING SUKUK

Rating determines level of risk inherent in a transaction and helps in the pricing of the transaction. Further, it helps in the marketability of the *sukuk*. It may be noted that the rating is assigned to the *sukuk* and not on the lessee. Market activity of *sukuk* is closely associated with the involvement and attribution of credit ratings from the conventional rating agencies to the issuances. The rating reflects current opinion of the likelihood that debt service payments will be made on a timely basis in accordance with the terms of the rated instrument that is normally referred to as credit risk. Issuers of *sukuk* have attempted to align their products, structures and characteristics akin to that of replicating conventional bonds. Conventional practice in relation to bonds is built upon rating agencies. Hence, risk rating agencies are willing to rate *sukuk* because of their familiar structures to provide assurance for investors. The most commonly known rating agencies are Moody's, Standard & Poor's, Fitch. There has been increased activity and involvement with the subject-matter of Islamic Finance in general from the agencies. In addition to rating activities, each agency has produced an analysis or opinion in respect of

securitisation and *shari'ah* including relatively thorough market analysis of Islamic Finance since 2005.

Process of rating securitisation traditionally is based upon the required legal opinions which international ratings agencies rely on in making ratings determinations. Legal uncertainties as regards *shari'ah*-compliant securitisation structures and unresolved issues that are inherent in all Islamic jurisdictions, such as true sale, collateral security that are sufficiently supported by government guarantees. Higher ratings are rare without additional risk-mitigating features, such as sovereign guarantees, or secured repayment obligations that conform to the principles of *shari'ah* law. The consequence is that capital market and secondary market growth is markedly constrained. A rating analysis process for *sukuk* is given in (Figure 4.4).

Figure 4.4: Sukuk Raiting Analysis

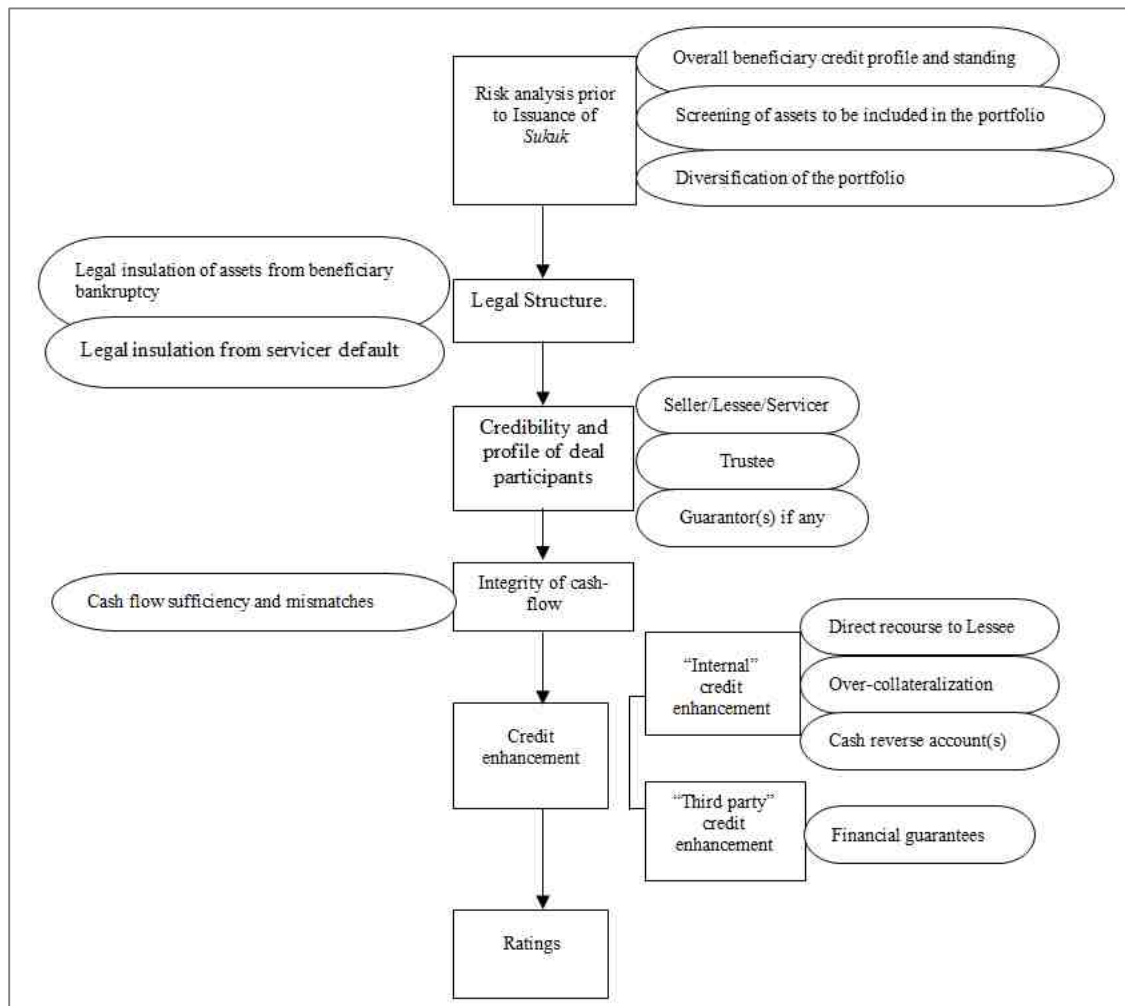

Source: Adapted Kahf, 2007

Moody's (2008b) approaches rating securities in new markets through the evaluation of various risk layers in order of priority; assets, structure, system (legal and political), convertibility. These are assessed in combination with regulatory issues, legal issues, data collection, originators/servicing rating, local market depth, issuer's motivations investors' concerns, country risk. In another study specifically on IFIs, it states that the key distinction Moody's makes when looking at corporate and bank *sukuk* is whether they are asset-backed (risk analysis is based on the assets), or asset-based via a repurchase undertaking (riskiness of the borrower/originator) (Moody's 2008b). They also examine

the strength of the underlying purchase obligation considering it to be the backbone of the *sukuk*'s principal repayment.

Standard & Poor's approach in rating *sukuk* is relatively similar. It is dependent on the performance risk of the assets backing the transaction. Standard & Poor's categories *sukuk* into three types: with full-credit enhancement mechanism (asset-based and dependent on credit-worthiness of 3rd party guarantor); no credit-enhancement mechanism (asset-backed with performance of underlying assets); and with partial credit-enhancement mechanism (combining features of the former two).

Each rating agency cites that they are only concerned with credit aspects and all declare they neither pronounce on the suitability of a particular obligation from the perspective of *shari'ah* compliance nor review the validity of a *shari'ah* board's recommendations and decisions (For example reports of Moody's 2008b; Standard & Poor's 2008; Fitch 2005).

Legally, ratings reflect solely the compliance of any transaction with applicable commercial law, i.e., the resultant investment risk from the degree of legal enforceability of investor claims. Against this background, certain *shari'ah*-compliant transactions have disavowed the *shari'ah* governing law (although they may satisfy the *shari'ah* as a matter of substance) in favour of English law.

The subject of rating *shari'ah* compliance is one of interest. Surprisingly no rating agency rates *shari'ah* compliance on the grounds they believe that it has no impact on ability of issuer to make payments. Emphasising the credit risk aspect only as justification for this position is misplaced. If *shari'ah* risk presents a credit risk particularly for investors if not implemented correctly, this should be considered a *shari'ah* risk. Rating agencies contend that they evaluate risk from all perspectives. Rating *shari'ah* compliance from the basis of investor risk is a credible and legitimate concern. Investors in *sukuk* seek verification of the extent to which *shari'ah* compliance is claimed by the issuers. The approach taken by many conventional institutions seems to be like 'burying one's head in the sand' as they are understandably lacking in the skills nor wishing to get themselves immersed in controversies. To avoid not taking into

account the fundamental premise of the existence of *sukuk* that is the extent of *shari'ah* compliance is a glaring omission of the process of *sukuk* issuance.

Usmani (2007 and 2008), contends that issuers should avoid having their primary focus on rating agency approvals when seeking to issue *sukuk* and rather focus on *shari'ah* legitimacy. Usmani also calls SSBs to abide by the *Shari'ah* Standards issued by the *shari'ah* Council and become more operationally involved post *fatwa* of product approval. The concerns of *shari'ah* arbitrage have been highlighted in this academic effort. This recognises the need to resolve discrepancies in the *shari'ah* element of *sukuk* issuance. The lack of *shari'ah* harmonisation and increasingly *sukuk* complex structures are impediments to growth. Hence, this aspect should be welcomed through regulatory support. Increased transparency is required. *Shari'ah* experts should be willing to disclose their '*fatwas*' or juristic reasoning, in order to gain wider acceptance of *shari'ah* decisions given the implications these opinions will have on cross-border transactions (Zaidi 2007).

The key parameters of *shari'ah* acceptance for such a rating process of *sukuk* would not be discussed here. The agency involved would need to have scholars themselves enable to do this evaluation. Further, they will need to co-ordinate with the respective SSB of the issuances. Practical controversies arise from varying jurisprudence judgements from a variety of schools of thought or *madhahib*. Hence, if scholars disagree who is right, *shari'ah* compliance is also a matter of expert opinion not objective facts. There are also only a limited number of scholars who can pass *fatwa* regarding *sukuk* issuance and so independence of this panel might be difficult. Consultation at a level with the Islamic International Rating Agency (IIRA), IFSB or AAOIFI may well be necessary to establish such a process.

A dedicated Islamic *sukuk* rating agency has been established by the IDB, the IIRA. It is worth noting that a substantial number of issued *sukuk* go unrated. Unlike Malaysia, GCC countries do not require issuers to seek ratings either before or after the *sukuk* launch forcing investors to do the required due diligence and research themselves. IIRA argues it is well-placed to step in and meet the capital market requirements by providing the

requisite *sukuk* ratings (Zaidi 2007). However, it does not rate *shari'ah* compliance. The Rating Agency of Malaysia (RAM) has acquired much experience of *sukuk* evaluation, but these use similar criteria to other rating institutions.

4.10 RISK PROFILE OF ISLAMIC FINANCIAL PRODUCTS WITH SPECIAL REFERENCE TO SUKUK

The systemic differences and unique characteristics of Islamic financial instruments require innovative risk management techniques that are acceptable to *shari'ah* (Kettell 2010b). The Islamic economic system increases stability brought about by not having activity linked with interest (and its rates) and egalitarian intentions (Jamaldeen and Friedman 2012; Rasul 2010b). Indeed, the inherent nature of Islamic finance is built upon risk-sharing and could be developed towards these techniques (Askari 2010). Co-operation is a key characteristic throughout Islamic trading approaches and indeed promoted through other activities from rites such as congregational prayer and charity to engaging in society (Khan 1994; Venardos 2005). At a trading level co-operation in partnerships such as *musharakah*, requires a level of trust and indeed consequently moral values (Brown et al. 2007).

Minimising common behavioural problems and the associated risk management of those involved with IFIs as financiers or investors needs to be a paramount concern in line with Islamic business ethics. Risk-aversion is natural and risk-sharing requires trust. Iqbal and Llewellyn (2002) also highlight issues of incentivisation, agency costs and monitoring are recognised concerns within the industry. It may well be that trust in conventional banks and systems may be higher when it comes to behavioural issues for example, of insider trading. Levels of trust in Muslim societies are recognised being low (Iqbal and Mirakhor 2007).

Further, as the nature of Islamic finance being asset-backed is closer to the real economy, Islamic financial markets should be less affected by volatility within conventional markets where derivatives and intangible assets dominate the industry. This is reflected by current issues within the sub-prime market where a debt based industry collapsed lacking tangible assets to realise investor claims. As additional Islamic principles also

build further safeguards and safety-nets for systems and institutions for example, they do not allow selling what one does not own; that is selling short. SS has been suspended in September 2008 in both the UK and the USA as large sound institutions collapsed as a consequence of this practice.

As globalisation is leading to increased integration and interdependency of financial markets, there are enhanced systemic and contagion risks arising from market volatility. Financial innovations and shifts in banking practices within an increasingly competitive world market are adding to the complexities and nature of risk. Risk management techniques from conventional financial industries to measure, manage and control risks allow them to effectively transfer and mitigate risk in a variety of manner to protect systems, institutions and individuals.

Risk can be managed but not eliminated from economic activities, nor can economic progress be made without assuming risk. Hence, risk-taking and risk-sharing are essential moral values Islamically (Suwaillem 2006). The objective of risk management is to extract optimum reward from an acceptable risk exposure whilst minimising cost (Monjoo 2007). However, Islamic finance in comparison with conventional finance has not well-established mechanisms and practices of risk management both at an institutional and product level. Weak risk management practices undermine the potential contribution that IFIs can make to the communities that they aim to serve and lead to weak global strategic positions (Graiss and Klathunga, 2007). Globally, additional regulatory requirements such as Basel II Accords require capital adequacy measures to mitigate different risk categories.

Iqbal and Mirakhor's analysis (2007) of risk profiles of IFIs is a rare academic effort to analyse this under-developed area in association with IFSB (2005) recommendations. Graiss and Kulathunga (2007) also approach risk management for Islamic finance from the perspective of Islamic banks in relation to capital adequacy and Basle II requirements. There are risks specific to IFIs arising from the different nature of the intermediation, products, and balance sheet constitution.

The approach of Iqbal and Mirakhor (2007) is significant in combination with that of Grais and Kulathunga (2007) who employ less numerous risk criteria. Application of these risk profiles is complicated by both Iqbal and Mirakhor's (2007) and Grais and Kulathunga's (2007) approaches being in relation to IFIs and financial intermediaries in particular banks, whereas *sukuk* are products based on securitisation and disintermediation. The examination by this research will tailor the above approaches to IFIs in relation to *sukuk* in the UK and to include also a risk management profile of the underlying nature and structure of *sukuk* instruments. Each AAOIFI *sukuk* category has its own inherent distinct risk-profile based on its underlying nature. Upon issuance of *sukuk*, there is further increased idiosyncrasy. Hence, instead of examining each *sukuk* category, general *sukuk* risks should be analysed and contextualised; references to specific *sukuk* categories are highlighted where necessary. Risk mitigating determinants are also suggested.

The specific challenges of risk management implementations within IFIs are identified by Iqbal and Mirakhor (2007) to be at several levels. These include the establishment of support institutions such as lender of last resort, deposit insurance schemes, liquidity management, secondary markets and enforceable legal infrastructure for Islamic products. Additionally, the harmonisation and uniformity of *shari'ah* standards across markets and borders is required. This might well be achieved through the establishment of a national/centralised *shari'ah* board that would perhaps be more cost effective and less resource intensive than individual SSBs. For the UK, this could be set-up by the industry itself and the FSA. This has been established in Malaysia and central reference point would also be an effective co-ordinator with the other internationally recognised *shari'ah* authorities.

Development of customised risk management systems may be hampered through lack of scale of IFIs. Integration with global financial markets would be more possible with sound risk management. Risk Management requires highly skilled human resources that are currently in short supply for IFIs. These sentiments are echoed by Garis and Klathunga (2006). However, risk measurements techniques and monitoring systems used in the conventional space could well be adapted by IFIs. For example, 'economic capital'

is an emerging framework practice for measuring and reporting all kind of risk across a financial organisation in relation to economic conditions rather than in relation to regulatory or accounting rules. It attributes a probability to risk events that may result in losses. These risks in IFIs could be offset through *takaful* funds. Large corporations can benefit from the due diligence process by either demonstrating operational excellence and/or by identifying operational risk.

Figure 4.5: Risk Profile Islamic Financial Institutions

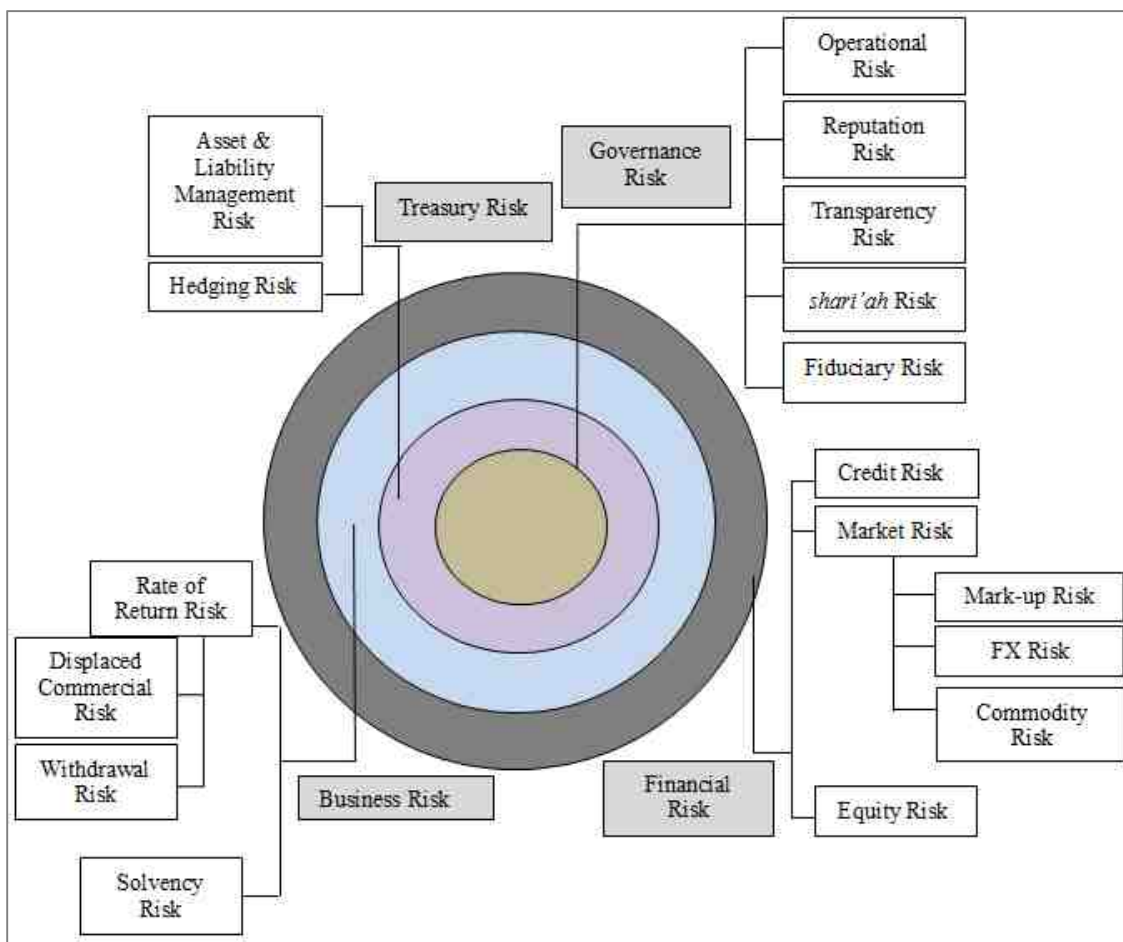

Source: Adapted Iqbal and Mirakhor, 2007

Risks are grouped into four broad categories by Iqbal and Mirakhor (2007) that are applicable to both conventional and Islamic institutions: financial, business, treasury and governance risks. Each of these analysed in turn with their corresponding scopes and relevance to this research.

Grais and Kulathunga (2007) use a different risk profile criteria with some different definitions. Four categories are also presented; financial risk, operation risk, business risk and event risk. Under financial risk, Grais and Kulathunga (2007) identify credit risk, interest rate risk (similar to mark-up risk), market risk (systemic risk common to entire asset class), liquidity risk, settlement risk (counterparty not delivering security or cash as agreed) and prepayment risk (loans being prepaid before maturity due to interest rate decrease). They identify the scope of business risk to include, legal and regulatory risk, volatility risk (exchange rates fluctuations), country risk (foreign asset placement risk) and equity risk (due to stock market dynamics). Operational risk and event risk (due to unforeseen exogenous events for example, contagion) are identified by Grais and Kulathunga (2007) as stand-alone categories. In addition, they consider certain particular risks of importance to IFIs; commodities and inventory risk (arising from holding assets in inventory), rate of return risk (arising from fixed-return commitments links with benchmark interest rates), legal and *shari'ah* compliance risk, equity positioning risk (associated with *mudarabah* and *musharakah* ventures).

A number of risks are evident in both the conventional and Islamic banking industries. Risk mitigation techniques are similar to conventional banks however, only where there are no *shari'ah* non-compliances. However, risk mitigation techniques are less evident and more complex with Islamic banks and products. Specific *sukuk* risk arising from structural and issuance may be categorised as market-risk prevalence under Commodities risks. These include UK specific discussions regarding bond-like *sukuk* issuance.

4.10.1 FINANCIAL RISKS

Financial risks are exposures that result in a direct financial loss to the assets or liabilities of an institution (Iqbal and Mirakhor 2007). Islamic institutions are also exposed to equity investment risk. Credit risk is the potential risk that a counter-party will fail to make payments on its obligations in accordance with the agreed terms. The different nature of Islamic instruments including *sukuk* being asset-backed brings distinct issues compared to conventional credit risks. Such risks include payment defaults for example, concerning *murabahah* (deferred price sale) contracts if a client refuses to pay or accept

the commodity. In the event of market volatility the agreed price cannot be altered. Defaulting delivery of goods as in the cases of *salam* or *istisna'* also exposes the bank to risk. Mitigation is usually through pledges and collateral as well as a due diligence investigation of the credit-worthiness of counter-parties. For *ijarah sukuk*, it could be a default on rental payments. There is increased likelihood of defaults and increased credit risks with fixed rate structures.

Credit risk on fixed rate *sukuk* should also be factored in by investors given the possibility of external counterparties defaulting on rent payments to the underlying asset. Counterparties will be more willing to default as debt rescheduling at higher interest rates is not permissible under Islamic laws. Credit risk of the SPV and originator will need to be assessed independently especially if the lender has access to recourse and the underlying assets fail to cover creditor losses.

To avoid practical and accounting uncertainties regarding the nature of the payment obligation, and to ensure that issuers meet their debt service schedule, *sukuk* can be structured to include payments to charity that fall due when periodic payments are delayed. Nevertheless, although this provides an incentive for the issuing entity to pay on time, it does not compensate investors for the delay. Other protection measures allow *sukuk* holders to declare an "event of dissolution" when scheduled payments are delayed. The declaration entitles *sukuk* holders to dissolve the trust and receive a distribution of their share of the trust and its assets (in conventional terms to recall their principal).

According to Standard and Poor's (2008), repayment of initial funds invested (that is, principal) normally takes the form of a stand-alone pre-set sale or purchase undertaking, or a call or put option whereby *sukuk* holders have the right to reclaim either the use of the *sukuk* allocated assets or the value of the assets themselves on termination of the *sukuk*, or on an event of dissolution. However, as is also the case for unsecured debt, this mechanism neither guarantees the full recovery of initial funds invested nor gives *sukuk* holders the right to claim any shortfall from the issuer if the latter is incapable of paying back the full amount of principal. One way to address this risk is through the use of

guarantees. In the JAFZ *sukuk* transactions, an external guarantee was used to support the *sukuk* structure (Standard & Poor's 2007).

Credit risk considerations of rating agencies examine whether the issuer have cash balances, reserves or standby access that will assure timely payment in the event of a cyclical or unexpected interruption of cash flow (Siddaiah 2011). They will also seek to determine the nature, history and consistency of the issuer's cash flow and what coverage this provides for future obligations (Siddaiah 2011). Some conventional credit and counter-party risk management mechanisms from a *shari'ah* perspective are not however, acceptable or at the very least controversial for example, to some, the use of derivatives (Rizvi and Lahsasna 2012).

Markets risks arise in the form of unfavourable price movements, which have potential impact on the volatility of the value specific assets (Greuning and Iqbal 2008). These include mark-up risks (for example in relation to LIBOR), price risks, and Foreign Currency Exchange (FX) (or foreign exchange) risks (Greuning and Iqbal 2008). Mark-up risks are closely associated with interest rate risks (Grais and Klathunga 2007). Market risks are also identified with commodities risks such as leased asset value risk in relation to *ijarah* contracts where there is for example a reduction in the residual value of the leased asset (Greuning and Iqbal 2008).

International financial markets are susceptible to ebbs and flows (Schinasi 2000). *Sukuk* are likely to be no different. Currency issues particularly pegging with the dollar in many countries is an issue (Graham et al. 2010). Foreign exchange rate risk is another worry particularly if the underlying asset in a *sukuk* is generating returns in a foreign currency (Zaidi 2007). Originators themselves may need to act as guarantors by assuming FOREX risk exposures thereby shielding investors from unfavourable exchange rate movements (Zaidi 2007). The IDB *Sukuk* used the concept of an Islamic Dianr (ID), equivalent to one Special Drawing Right (SDR) of the IMF that is weight-composed of 45% in USD 29% in Euro, 15% in Japanese Yen and 11% in GBP (Ahmed 2011). However, the *sukuk* certificates are denominated in USD creating an inherent mismatch (Ahmed 2011). Any appreciation of the USD against the ID will invariably result in a currency loss (Ahmed

2011). Ideally, the underlying asset pool would need to be well-diversified generating multiple currency returns to completely offset the foreign exchange impact for both originators and investors. The term of maturity of *sukuk* also matters given that smaller maturity *sukuk* will be less exposed to long-term exchange rate changes (Zaidi 2007).

Commodity risk for the purpose of this exercise is scoped to include asset, price and issuance related risks particular to *sukuk*. Price risk is asset-specific risk given that there will be differences in the fair-market and reported values of the underlying asset. The underlying tangible assets are likely to depreciate and maintenance will surface as an issue. *Ijarah sukuk* will be considerably vulnerable to such risk exposure as depreciation of the leased asset will likely cause asset values to fall below prevailing market values. The liquidity of the *sukuk* can offset this risk. *Salam sukuk* does face price risks, but such risk can be mitigated with investors entering into parallel contracts with third parties. Asset loss prevention or depreciation could be performed through *takaful*. For UK sovereign issuance of *sukuk*, 'pricing risk' was considered to be higher for 'bond-like' *Sukuk* than 'bill-like' *sukuk* because of the greater importance placed on liquidity of longer-dated instruments (GB HM Treasury 2008). There is also the securities price risk in relation to *sukuk* where the price exposure from investors is exposed to current yields and there is distortion arising from an illiquid market.

The determination of the asset-quality risk is a key requirement for *sukuk*. Whereas the underlying asset base is difficult to assess for conventional securitisation, there is more transparency necessary for *sukuk* issues. However, description and specification of assets from originators who are not so well-known may be an issue particularly for corporate *sukuk*. Not all issuances are likely to be guaranteed by sovereigns or equivalents globally or within the UK. If the asset-backed issuance is properly employed then, the asset quality would also dictate revenue from its actively managed performance. If it is asset-based then the rating agencies would need to assess if the issuer has cash balances, reserves or standby access that will assure timely payment in the event of a cyclical or unexpected interruption of cash flow instead of viewing asset quality.

The servicing risk is a key element of securitisation. Servicing can benefit from economies of scale. Problem assets will require more servicing. *Shari'ah* issues are also involved if the originator is involved. Take for example, the originator within an *ijarah sukuk* needs to ensure compliance for maintenance of property. The rating agencies examine several aspects in relation to servicing. These include determining whether the originator service collections relate to the underlying and also if the originator is skilled and competent to do this. If the originator fails, there is the requirement to have a backup servicer known to the investing community been identified and already contracted to step in and replace the original servicer without harm to the investor (IFQ 2006). The process of the rating agencies will be to determine also security risk aspects such as whether the underlying is sufficient to secure repayment in the event of servicer (party collecting monthly payments), issuer, or originator related problems including default. Otherwise an assessment to provide additional security including extra assets, reserve funds or guarantees is necessary to arrive at an attractive rating. The development of a third party servicing provider industry for *sukuk* is to be encouraged. This may be achievable through conventional servicing companies may be able to open up 'windows'. Regulatory changes may well be needed.

Prepayment risk for *sukuk* could arise in the future. If mortgage backed securities are likely to be involved for *sukuk* structures within the UK. LIBOR changes are likely to impact on prepayment characteristics of borrowers. This is true for other asset-based *sukuk* linked to LIBOR. A possible mitigation could be to use a *sukuk* index to have a benchmark that is non-LIBOR based. This will also likely to help develop Muslim participation within financial markets globally through having non-interest associated benchmark involved.

Sukuk in the UK have an associated new product risk. Their nature and substance alone with other aspects of Islamic products requires to be understood for all stakeholders-current and future. The financing and pay-off characteristics require to be understood by conventional participants and stakeholders. The FSA needs to be actively involved in the promotion of education of Islamic finance. The broad range of *sukuk* and their true nature rather than just being associated with 'debt' characteristics is also necessary for the

industry. The development and establishment of market-leading 'debt' formatted *sukuk* indices align with other Islamic product benchmarks should be a key priority for the LSE. As the *sukuk* market is also a nascent market it requires to be cultivated to ensure that conventional players when competing do not harm the development of the *sukuk* market. The regulatory authorities are required to play their part. Also the LSE needs to undertake and be involved in a full market assessment and strategic evaluation of *sukuk* to understand and develop economic plans.

Asset protection and structural seniority/subordination/collateral risks are two distinct controversies associated with *sukuk* from a *shari'ah* perspective. The *shari'ah* requirement that investors fund operating assets, coupled with the equity-like nature of their investment, means that *sukuk* holders may expect to acquire indirect legal ownership in the allocated *sukuk* assets rather than true ownership. *Sukuk* structures witnessed so far, however, have been mostly asset based rather than asset-backed. This does not offer direct legal claim over the allocated *sukuk* assets, thereby resembling unsecured lending. As tranching is not an equitable process, even if permitted by certain *shari'ah* scholars it is not a practice to be encouraged as it violates the principles of engineering. This justification is arguably invalidated overtime and this time has arrived. The fundamental nature of *sukuk* as being asset-backed with full ownership presiding on a risk-sharing basis with the *sukuk* certificate holders is being challenged. Most *sukuk* have been asset-based with originators ensuring that ownership is not fully transferred to investors. The question of the *sukuk* structure being asset-backed or asset based nature permeates this research topic. It is of paramount importance at all-levels- at *shari'ah*, regulatory and market levels. Interestingly, each perspective is realising asset-based *sukuk* only. This is even at *shari'ah* gauge where many scholars permit asset-based ventures to the detriment of asset-backed *sukuk*. At a regulatory level, the UK is driving an asset-based *sukuk* agenda from its consultation responses and documents. The UK regulations should cover both asset-backed and asset-based *sukuk*. At a market level, sovereigns and corporate originators do not wish to give over full ownership rights. This is perhaps strange when conventional securitisation efforts do undergo true sale and bankruptcy remote structures and issuances. Competitive advantage could be gained through issuance of asset-backed

sukuk. Admittedly, the structures and hesitancy or inertia due to the lack of regulatory and market desire may necessitate more development for this to occur.

It is expected that *shari'ah*-compliant securitisation will expand going forward and asset-backed *sukuk* sponsored by IFIs and other corporations will grow materially in number and size. For IFIs, these structured *sukuk* would play the roles of both attractive funding mechanisms and powerful balance-sheet and risk management tools.

Regulatory arbitrage in the UK has been brought about through the FSA, HM Treasury, HMR&C essentially confining *sukuk* to be within the debt market space and providing tax relief when technically they do not fall within this arena and are more akin to the definition of CISs. HM Treasury (2007) focus and default position on *ijarah sukuk* as the reference *sukuk* although understandable as an evolutionary first step, it is perhaps limiting in their pursuit of 'bond'-like or 'bill-like' *sukuk* issuance. Regulatory arbitrage is occurring as the regulators seek to contrive a strategy of fitting *ijarah sukuk* into the 'debt' box and in practice following a 'one-size fits all' approach for all *sukuk*. Arguments of economics substance over than legal form are being cited. However, both need to be consistently aligned. Nevertheless, the *ijarah sukuk* is a welcome first step. However, it is a limited approach given the broader range an aspect of rate of return risk is the displaced commercial risk identified by AAOIFI where depositors are paid returns higher than what they should be paid under the actual contract for example, when they have underperformed. This has led to mitigation through the establishment of Profit Equalisation Reserves (PERs) (portion of gross income set aside before deductions) and Investment Risk Reserve (IRR) funds (income of investors is set aside after deductions) to dampen future losses.

Another aspect of business risk is withdrawal risk resulting from competitive pressures leading to a loss of customers. This may become an issue if *sukuk* are not cultivated and protected at the onset from competitive pressures, particularly given that a critical mass of *sukuk* are required for both sovereign and commercial *sukuk* to allow secondary trading at fair values. Malaysia has foreseen this and brought in measures to protect the *sukuk* industry.

At a macroeconomic level, the FSA (2007) regard the risk of contagion or systemic not to be significant. In the UK, the risk of contagion to the wider economy and financial markets through a failure of an Islamic financial institution is limited as the market is currently relatively small. In countries where Islamic institutions have a larger share of the market the impact would be wider.

Accounting standards and the treatment of *sukuk* risks exist for *sukuk* and different accounting standards are identified for different *sukuk* products. There are also *sukuk* differences in relation to conventional product differences. Also geographical differences in understanding global *sukuk* are an issue. This was also a key reason for the existence of AAOIFI. It should be noted that AAOIFI (2008) Financial Accounting Standard 17 regarding Investments (as opposed to the *shari'ah* Investment *sukuk* Standard 17) provides little guidance specifically for the accounting treatment of *sukuk*. Section 6/2 (Special requirements) requires disclosure of the nature of the *sukuk*, the face value of *sukuk*, the percentage acquired of issuance by each party and classifications according to maturities. The standard only requires a further two elements to be known for *sukuk*, that is the nature of the guarantee and the nature of the relationship between issuers and *sukuk* holders.

Conventional international accounting standards offer some leeway under which *sukuk* can be classified as debt or equity, with their outflows following accordingly. The classification of a particular *sukuk* is readily determined from an issuer's balance sheet. If the *sukuk* is treated as debt, periodic payments will be classified as conventional interest payments as part of financing costs. If the *sukuk* is treated as equity, however, periodic payments can be reported as dividends and appear directly in the statement of changes in equity without passing through the income statement. This makes calculating interest coverage ratios more challenging. Nevertheless, it is essential to ensure that ration calculations fully capture an issuer's financial obligations for comparability with other conventional debt issuers. Standard & Poor's (2008) adjust calculations to take into account the treatment of *sukuk* remuneration. However, Standard & Poor, AAOIFI provide little guidance for the accounting treatment of the assets of a hybrid *sukuk*.

HMR&C (2008) categorically state that *sukuk* must be treated as a liability for accounting purposes.

Islamic banking products and systems are unique and their operational modes are distinct (Elfakhami et al.2007 and El-Tiby 2011). The regulatory and supervisory requirements for conventional banks are different in scope (Wilson 2006). Regulation concerns of IFIs are of vital importance to the success and trust of the system within which Islamic investment funds operate (Llewellyn 1999as cited by Belouafi and Belabes 2010:40). There is an established tradition of monitoring the market in Islamic tradition from the time of the Prophet Muhammad (peace be upon him). Scholars such as Ibn Taimiyyah elaborated principles further regarding regulation and supervision that is also an inherent part of Islamic finance (Ashraf 2012).

Regulatory risk is a considerable factor for *sukuk* in UK. This is also a considering factor to the UK from global *sukuk* traded and listed on the LSE or to be traded abroad eventually (GB HM Treasury 2008). Definitions are required for the broad range of *sukuk*-not just a single definition of debt (FSA 2007). The *sukuk* asset class has to be viewed as a commodity class in its own right (GB HM Treasury 2008). Treatment on a case by case basis although understandable is perhaps not considering the broader picture of *sukuk* as a particular class (FSA 2007). The appreciation of range of *sukuk* and applications is currently being avoided by the UK authorities. Further, hybrid *sukuk* are developed that have a variety of debt/equity/project financing characteristics (Casey 2012). Current emphasis on viewing the economic substance of the *sukuk* although laudable, needs to be aligned with that of its legal form (GB HM Treasury 2008). It clearly is not as a *sukuk* should be categorised as a CIS but is treated as debt (FSA. 2007). Regulatory arbitrage by the FSA itself is also perhaps occurring as trying to fit equity like *sukuk* all into single box of 'debt' like bonds. Hence, regulatory arbitrage exists in the UK approved by the regulators (Clifford Chance 2010). These current regulatory, as well as the taxation applications, may well be challenged at some time. However, current approach to treat *sukuk* as bond is clearly limiting (Cakir and Raei 2007). Regulatory rules across different countries for *sukuk* may well be a concern for market development and trading for example even if issuing *sukuk* in Europe (OBG 2008; Thomas 2006b).

Regulatory evolution will take time. *Shari'ah* boards and opinions for sovereign issuance are needed (Cakir and Raei 2007). An accompanying legal review is required to encompass the breadth of Islamic finance if the UK truly wishes to establish itself as a global hub (Askari et al. 2010).

The UK's HM Treasury (2008) consultation also recognised the process of issuing *sukuk* is not straightforward and could be time consuming, resource intensive and less flexible than the UK Government's current method of financing via gilt and treasury bill ('bill') issuance. Respondents to the consultation questioned whether *sukuk* issuance could reduce gilt issuance and the impact on the interaction between UK Government *sukuk* issuance and wider UK Government financing through gilts and bills. It is also thought issuance could be more costly than conventional issuance, either as a result of up-front structuring costs or because investors would charge a premium to invest in *sukuk*. Further, it was appreciated that demand for AAA-rated sterling denominated *sukuk* issuance is untested and may be limited, due to either the currency and/or the relatively low yield it could offer. The transfer of government assets to a SPV also required to be addressed as sensitive.

Legal risks are also important to tackled with. Lord Woolf's (2007) call for the Law Commission to undertake a full review of legal issues regarding Islamic Finance is necessary. His comments that current approaches being piecemeal and beyond the scope of purely regulatory authorities are pertinent. Legal risk could also include SPV Specific Risks. The SPV is generally designated to be a standalone institute that is bankruptcy remote from the originator. For UK sovereign *sukuk* issuance, this will need to have asset distinguished from government ownership.

Technology risks for adequate systems catering for the range of *sukuk* possible are not adequate and needing development. Further, as the *sukuk* market is small, there is inadequate originating systems for *sukuk*, as the volume of trade has been insufficient to justify spend on development. Current technology systems are bespoke or in-house from Islamic finance products and generally being developed in emerging countries (Al-Jarhi

2009). *Sukuk* in the UK also require adjustments to CREST settlement system coordinated with the Euroclear platform.

4.10.2 TREASURY RISKS

Treasury risks are risks associated from the management of the financial resources of financial institutions for example in terms of cash, equity, liquidity and assets/liabilities management. Any inability to manage risks in itself is a risk. Liquidity risk for IFIs arises from a constraint of trading illiquid assets and not having access to acquire funds at reasonable cost when needed. This can also give rise to mismatches between asset and liabilities and an inability to manage portfolios.

Liquidity risk is one of the key reasons for the existence for *sukuk*. The limited growth of the shallow secondary market poses its own challenges to those investors seeking to trade/liquidate their *sukuk* holdings. Pricing, market depth and volume issues add to the real concerns investors have with selling their *sukuk* certificates. The buy and hold culture as well as decentralised secondary trading prevent investors from seeking an efficient transfer of *sukuk* certificate ownership without loss of value. At a global level, the IIFM and Liquidity Management Centre (LMC) of Bahrain seek to address the issues of liquidity. The Central Bank of Malaysia has also established the Islamic Inter-bank Money Market (IIMM).

The primary assets created by *istisna'* and instalment purchase/sale contracts would create debt obligations that can be termed as fixed rate zero coupon *sukuk*. These zero coupon *sukuk* are a *shari'ah* compatible debt finance instrument. *Salam sukuk* and Zero Coupon *sukuk* are themselves entirely non-tradable. Scholars opine that because *salam sukuk* contracts are based on underlying grains (and other food commodities) trading of such securities may result in speculation or undue exploitation. However, unlike traditional zero-coupons, Zero Coupon *sukuk* such as *sukuk al-istisna'* and *sukuk al-murabahah* do lead to debt ownership; trading of debt securities being incompatible with Islamic *shari'ah*. Hence, liquidity risk is more pronounced for non-tradable *sukuk*.

When a bond is bought by a bond holder at a lower price than its face value but he is fully repaid its face value at the time of maturity is known as zero-coupon bond. (Mishkin 2007:70)

In Islamic finance, funds are needed to create new assets on the balance sheet of a company and this asset creation may be done through *istisna'* or *murabahah sukuk*. Since a debt obligation is created in these *sukuk*, hence these can be in the form of non-tradable debt certificates that are similar to zero-coupon bonds. The certificate on these debt arrangements can be termed as fixed rate zero coupon *sukuk* (Tariq 2004:19).

These instruments cannot be adjusted to the variations in market conditions such as prices, interest rates and exchange rates. Hence, investors in these assets are exposed to serious market risks and challenges in competing with conventional bond markets. Consequently, there is a demand for tradable *ijarah sukuk* for liquidity management. In addition to the restriction on the sale of debt, Islamic banks rely on current accounts that are withdraw-able on demand. Due to the slow development of Islamic financial instruments and lack of inter-bank money markets, liquidity issues arise.

The *sukuk* certificate holder is rendered to several risks pertinent to *sukuk* structures categorised as Investor Specific Risks. These are primarily regarding liquidity issues. The *sukuk* structures, as welcome as they are in dealing with liquidity management issues in Islamic finance, are exposed to a liquidity risk because there currently does not exist a well-structured and sufficiently liquid secondary market due to volume and as most of the certificates tend to be held until maturity.

For UK *sukuk* issuance, there is a general lack of liquidity in the *sukuk* market, the 'buy and hold' nature of the investor base and the need for large repeated issuance of *sukuk* to achieve any liquidity. Hence, it could be more difficult for 'bond-like' *sukuk* issuance to achieve a price that is the same, or close to, their conventional equivalents.

Shari'ah scholars as of a wholly Islamic firm require all transactions within the firm to be in compliance with *shari'ah*, including risk management. Many of the commonly used conventional tools and practices are not acceptable (for example, certain types of

derivatives which are used for hedging against currency, interest rates and other risks). Liquidity management has also been a challenge because of the lack, or limited availability, of *shari'ah*-compliant instruments. Two of the instruments widely used by conventional banks, namely inter-bank deposits and government and corporate bonds or notes are interest bearing, so are viewed as non-*shari'ah* compliant by scholars hence, the need for instruments such as *sukuk*.

Assets and liabilities mismatch risk arises from differences in maturity terms and conditions between its assets and liabilities. In theory, there should not be such mismatches for IFIs. However, in practice distortions exist. Professional portfolio management could provide better investment guidance for Muslim investors as they are more informed and able to understand the Islamic investment fund requirements better (Wilson 2004). It could reduce transaction costs as fund managers buy and sell stock in large amounts for pooled investors. Risk management could be provided through portfolio diversification and through market knowledge of unlisted companies. Certain Islamic portfolio protection of fund performance is performed for example through the use of down payments (*'urbun*) and a *murabahah* transaction (Cox 2002).

Hedging risk is the failure to mitigate and manage risks and hence increasing overall exposure. The general non-availability of hedging products such as derivatives increases hedging risk. Risk management techniques for IFIs and products are limited although there is current on-going research into developments of Islamic hedging products. Islamic insurance or *takaful* may well be useful for this purpose.

4.10.3 GOVERNANCE RISKS

Governance risks arise from a failure in governing the institution including negligence. It is also associated with weak corporate governance, internal and external institutional environment leading to contracts not being enforced, reputational risks, and *shari'ah* risks as well as other systemic risks.

Accountability of IFIs to their shareholders, finance providers and other stakeholders have important implications for the industry (Iqbal and Mirakhor 2007). There is a lack of

corporate governance and accountability both historically and culturally in the operational environments of many IFIs at an institutional and political level. Ownership of IFIs is highly concentrated to a few giving monopolistic concerns. Investment depositors and equity providers have little representation on boards encouraging unapproved risk-taking. The deposits are in the nature of loans to the banks and Islamically this means that ownership has been transferred to the banks. Hence, current deposit holders are exposed to more risk than in the case of conventional banks.

Operational risk is closely related to governance risks and results from the inadequacy of internal processes as resulting from people and systems and their risk of failure. Specific operational risks that could arise with IFIs are cancellation of non-binding elements that is the 'promise' element in contracts. Additional operational risks arise from, internally weak processes and structures, inability to enforce contracts and an inability to manage commodity inventories. Infrastructure rigidities play an important part in operational risk in certain less developed contexts. Khan and Ahmed (2001) show for a survey of Islamic banks, that mark-up risk is the most-critical risk perceived followed by operational risk. Operational risk is lower in fixed income contracts involving *murabahah* and *ijarah* and one of the highest in deferred sale contracts such as *salam* and *istisna'*. The implication is that banks find the latter contracts complex and difficult to implement.

Fiduciary risks arise from an institution's failure to perform in accordance with fiduciary standards which may lead to legal recourse in respect of those failings (Greuning and Iqbal 2008). As fiduciary agents, IFIs are to act in the best interests of clients and shareholders who deal with them on a trust basis (for example, in contracts such as *mudarabah*, *musharakah*, *wakalah*) (ibid). Failures to perform due diligence and mismanagement are other symptoms (ibid). This relationship of trust is a distinguishing characteristic from conventional banking practice with both legal and moral implications and is the sole justification for the existence of Islamic banks (ibid). Breaches of trust within Islamic communities could lead to institutional collapses and have systemic effects (ibid).

Most Islamic funds are of an agency type. The agreement of the management relationship would need to be resolved at the outset of a fund (El-Gamal 2006b). The *mudarib* operates on the basis of *yad e amanah* (hand of trust) – best effort not on a *kifalah* or guarantee approach as is the expectancy for most conventional funds (Gurulkan 2010). The agent or *mudarib* is also most likely to be held accountable to a *shari'ah* board (Schoon 2011). If he violates the terms of his trust through negligence or mismanagement, he is liable to penalties (Usmani 1998). It is clear from fund practice that there are principal-agent problems (Sarkar 1999). With the functions and relationships of SPVs and other third party agents for *sukuk* these have yet to be researched. Clearly the increasing complexity of *sukuk* and the lack of doubts concerning *shari'ah* integrity may well give issues of marketability risk as it is closely tied into other factors such as informational efficiencies as well as the number of traders in the market (Krichene 2013). In the incidence of a *wakil* (agent) the guarantor and *wakil* have to be separate entities to negate any conflicts of interest and moral hazards for *sukuk* (Tariq 2004).

Reputation risk or 'headline risk' is the risk that the trust of the clients of IFIs is damaged due to the irresponsible actions of management such as negative publicity (Greuning and Iqbal 2008). This can arise from failings in other risks, as well as fiduciary risks impacting negatively on the market's price of the IFI and possibly insolvency if the bank is unable to meet its demands (Greuning and Iqbal 2008; Archer and Abdel Karim 2007). IFIs could suffer also from a 'run on the banks' and will not be necessarily immune to financial systems being based on consumer confidence that is contagion (Greuning and Iqbal 2008). The industry is still very young and it is still building its reputation and credibility (FSA 2007). Additionally, in some countries, Islamic finance and its various business models (which have so far tended to be conservative) have not yet been tested in a severe economic or market downturn. Given these factors, a significant failure now in the Islamic market might have a damaging impact on the future development of this sector. El-Gamal (2006a) identifies Egypt as a classical example where nascent Islamic finance businesses turned out to be pyramid schemes of exploitation. Consequently, the industry has not recovered to date.

Many new entrants such as originators and issuers are likely to arise with a variance in quality of corporate governance standards. With large sums involved, assessment techniques crucially required for gauging particularly those from less well developed regulatory regimes. Rating agencies will seek to determine the historical aspects including originator history; what is the originator, their asset class and underlying obligor payment history? What is their business history? Does the prior history of each component (the originator, asset class and obligor) meet a standard that gives a reasonable prediction of future payment? This also leads to possible warranty risks.

Transparency risk arises from the lack of public disclosure of reliable and timely information to allow accurate assessments of its condition, performance, activities and risk management profile. This may lead to bad decisions based on inaccurate or incomplete information. Transparency also requires standardised practices in relation to products and financial reporting of Islamic finance. UK and conventional practices of reporting set out by for example by the FSA are not necessarily aligned to those of Islamic finance for example in respect of *sukuk* or their different accounting structures.

Accounting for Basel II capital adequacy requirements for *sukuk* is still in development for both the UK and elsewhere. The new Basel II capital risk management framework has been recently introduced in the UK, in the form of the EU Capital Requirements Directive. The FSA is in the process of developing this approach into practice across the firms it regulates. The FSA's approach to both Islamic and conventional financial institutions for capital adequacy will develop over time. Basel II preparation is lacking for Islamic banks. Islamic investors have a right to information more so than in conventional contracts as the *shari'ah* stipulates this. In addition, disclosure of *shari'ah fatwas* and details of how the decisions are arrived at in respect of *sukuk* contracts and their permissibility is also an imperative.

Shari'ah risk is identified in relation to the structure and functioning of the *shari'ah* boards at the institutions and systemic level. Iqbal and Mirakhor (2007) identify two categories; the first is non-standardised practices of contracts and rulings in different jurisdictions as well as the second, the risk of non-compliance with *shari'ah* rules. It

should be noted that the *shari'ah* aspects and consideration underlie most risks identified above with *sukuk*. *Shari'ah* arbitrage has clearly been identified that involves the exploitation of *shari'ah* rules to provide or *shari'ah* engineer *fatwas* for the market place for *Sukuk* issuances. *Shari'ah* concerns and *shari'ah* complexities have been identified within other areas of this research as well as their association with national legal systems.

The requirements of a *shari'ah* rating system are advocated to minimise *shari'ah* compliance risk. As seen with the Malaysian debt-backed *sukuk*, a great deal of standardisation and awareness of *shari'ah* rulings is needed. Given the tremendous growth in *sukuk* markets the non-compliance of *sukuk* structure with *shari'ah* rulings remains a possibility. Muslim investors will need to be particularly careful to ensure selection of those *sukuk* that are of the highest *shari'ah* quality and are conforming to widely accepted *shari'ah* standards. There are concerns about the *shari'ah* risk associated with structuring *sukuk* issuance that could affect the extent to which any *sukuk* issuance is acceptable to a wide range of Islamic investors given the lack of standardisation in the market. They also acknowledge there is a risk that, due to the evolving nature of Islamic jurisprudence, a *sukuk* issuance that was initially deemed *shari'ah* compliant could subsequently be deemed not to be *shari'ah* compliant sometime after issuance. This also puts more emphasis on the need to have a *sukuk* that is true-sale and asset-backed.

The FSA (2007) identify the complexities of *shari'ah* risk management between wholly Islamic firms and Islamic windows of conventional firms. For banks with 'Islamic windows', the industry practice is that the risks arising from Islamic business and products are often pooled with risks from conventional business. In short, the constraints in risk management for Islamic firms are due mainly to lack of availability of suitable products and the relatively small size of the markets.

4.11 CONCLUSION

This section of the thesis provides practical and current concerns in the *sukuk* market which provides an insight into the issues being faced by market players in the market. This will help us in identifying problems and leads us towards a solution to these problems.

The rating processes and transparency of gauging *shari'ah* compliance is a glaring requirement. McMillan (2006) amongst others advocates transparency and agreement on, applicable *shari'ah* standards. Complete *shari'ah* consistency and homogenisation is not likely to occur. The lack of consistency is creating *gharar* in itself for the industry and in contracts. Although to obtain a majority consensus of scholars should be achievable with considerable effort. Advocating global *shari'ah* rating compliance is a necessary aspect despite the apparent difficulties.

No conventional rating agencies wish to make *shari'ah* judgements themselves. However, the failure of an asset transfer to be defined as true sale, may result in the voiding of the sale and the transfer of the asset back to the original owner. This would compromise investor protection under substantive non-consolidation. Hence, this standard practice becomes also a *shari'ah* compliance factor. This is an area for necessary development that the International Islamic Rating Agency (IIRA) along with its Malaysian Counterpart RAM is attempting to do for the different nature of *sukuk*.

In the absence of standards, al-Jarhi (2005) highlights that shareholders of Islamic banks are appointing individuals to *shari'ah* boards without regards to their qualifications. Further, and more importantly, there are apparently not many *shari'ah* scholars versed in the field of Islamic finance and with the appropriate skills globally. This lead to extensive lead-times for approvals, difficulty in monitoring and supervising the ensuring responsibilities of fatwas is difficult due to resourcing shortages. He also notes that two economists dominate *shari'ah* boards all across the globe who have no qualifications in *shari'ah*. There is a danger that a lemons problem (Akerlof 1970) arises where good *shari'ah* scholars advocating *sukuk* structures nearer to the essence of Islamic finance for example asset-backed compliances may be driven out of business by *shari'ah* scholars who are willing to produce fatwas for asset-based *sukuk* issuances.

Further, there is a requirement to have an update to AAOIFI *Shari'ah* Standard Investment *sukuk* 17 (AAOIFI 2008). The two supplements from 2007 and 2008 by Usmani do not go far enough. Further, this needs to be accompanied with the AAOIFI

Accounting standard 17 for Investments to bring about consistency in dealing with *sukuk* in addition to IFSB's capital adequacy requirements for *sukuk*.

The comprehensive risk management profile provided has examined at all three levels, the interdependent risk issues and possible mitigations for *sukuk*. Global practice for example, IFSB guidelines for risk analysis, needs to be considered as *sukuk* are of a different nature to existing conventional structures (Wilson 2008 and 2007). Hedging issues require development from an Islamic perspective.

.

CHAPTER 5

THE USE OF WA'AD IN SUKUK/DERIVATIVES

5.1 PROMISE IN ISLAMIC FINANCE

Islam encourages trade and for this purpose it allows its followers to enter into transactions. For example in the Qur'an it is mentioned:

“Allah has made trade lawful” (Qur'an, 2:275)

It is also mentioned in the Holy Qur'an that:

“let there be among you traffic and trade by mutual goodwill” (Qur'an, 2:29).

From this, the principle of general permissibility is allowed, which is known as *ibahah*. Under this principle trade is allowed and until unless it is not breaching principles of *shari'ah*. Therefore, in order to promote trade, in Islam innovation and product development may be allowed.

Sheelan describes innovation is inevitable for growth and lack of innovation in a society may lead to a slow death (Majid (2003) as cited by Sheelan (2007). Chapra (2007) considers innovation as a “necessary” tool for development and progress in the society which is helpful in order to avoid inactivity and degeneration in the society. We can quote here Islamic position on the issue by quoting a legal maxim which states that: “something without which an obligation cannot be fulfilled is also obligatory” (Al-Zarqa 1967) Here, again it is mentioned that any freedom to contract or any innovation in the course of trade and business must be in accordance with the principles of *shari'ah* or in other words *maqasid al-shari'ah* (the overriding objectives of *shari'ah*).

In the financial world, in order to maximise profits and to minimise risk of loss, parties to a transaction use different techniques and instruments. In Islamic financial engineering

wa'ad or its English translation “promise” is being emerged as an instrument to hedge risks.

The *wa'ad* instrument is being used in permitting banking, *tadaful* and other capital market products, which are otherwise not permitted under *shari'ah*. As per se the general understanding in the market is that the *wa'ad* is a device in developing new Islamic products or such products which mimic the conventional ones. Supporters of *wa'ad* instrument rely on the principle that things are permissible until unless are prohibited under *shari'ah* and they also rely on the principle that parties have free choice to do contract. The opponents consider promise as a tool in order to avoid the requirements of contract under *shari'ah* (Iqbal and Molyneux 2005).

5.2 PROMISE IN SHARI'AH

In the present section definition and analysis of the term *wa'ad*, its literal and technical meanings in the light of Qur'an and *sunnah* will be given. Then difference between *wa'ad* and *'aqd* will be highlighted. This will followed by classical juristic view and the contemporary view of the *shari'ah* scholars.

The translation of the term promise in Arabic is *'ahd* or *wa'ad* these are used interchangeably. Some of the most common meanings of *wa'ad* are promise and pledge (Lane, 2003). It is also used in the meaning of giving notice or news of either good or bad. On the other hand, *wa'ad* is used for warnings and bad news only (Kuwait, *Al-Mausuah al-Fiqhiyyah* (n.d) as cited in Abdullah (2010); Abul-Hasan 2001). There is another word *muwa'adah* which means a bilateral promise and that is derived from *mi'ad* and *'idah* which also means promise. *'idah*'s plural is *'idat* but there is no plural form for *wa'ad* (Ibn Manzuur1955).

Encyclopaedia of Islam defines *'ahd* as an “injunction command; thence obligation, engagement thence agreement, covenant, treaty” (Schacht 1964). It is also stated that, while initially *'ahd* was synonymous with another related concept known as *'aqd*, in later usage the latter began being employed for civil engagements and contracts and the former for political enactments and treaties (Schacht 1964).

We can conclude for the word *wa'ad* that in the current scenario it is being used in the meaning of promise, however, there may be lexical differences in terms of morphological roots of the various connected words.

There is paramount significance to the word promise in the light of Qur'anic verses and *sunnah* of the prophet (peace be upon him). There are several verses in the Qur'an enjoining believers to guard their trusts and to keep their promises and covenants (Qur'an, 23:8; 70:32; 76:7). It may be noted that there is a running theme in the Qur'an that promises are associated with truth (Qur'an, 4:122; 7:44; 9:111; 11:45; 11:65; 14:22; 16:38; 17:108; 18:21; 18:98; 21:104; 28:13; 30:60; 31:9; 31:33; 35:5; 36:52; 40:55; 40:77; 46:16; 51:5) but the promises of *Satan* are distinguished from the above and these are associated with deceit (Qur'an, 4:120; 17:64).

In a saying of the Prophet Muhammad (peace be upon him) as narrated in Sahih Muslim, three qualities of hypocrite are mentioned and one of them is when he promises he breaks. The translation of the tradition is given as:

“The signs of a hypocrite are three: when he speaks he lies; when he promises he breaks his promise; and when he is entrusted he betrays the trust.”(Muslim 2009: 91)

Further another tradition adds that:

“even if he fasts, performs prayer and claims to be a Muslim”

(Ibn Hanbal, 2012)

There is a similar tradition in *Bukhari*, which is as follows:

Narrated 'Abdullah bin 'Amr: "The Prophet said, "Whoever has the following four (characteristics) will be a pure hypocrite and whoever has one of the following four characteristics will have one characteristic of hypocrisy unless and until he gives it up.

- 1. Whenever he is entrusted, he betrays.*
- 2. Whenever he speaks, he tells a lie.*

3. *Whenever he makes a covenant, he proves treacherous.*
4. *Whenever he quarrels, he behaves in a very imprudent, evil and insulting manner."* (Al-Bukhari2009:19)

Therefore, hypocrisy is to deviate from the right way. Thus, in Islamic law a promise generates an obligation against promisor and this obligation is derived from the divine command. Therefore, it cannot be regarded as a social practice defined by certain social norms and rules.

In Islamic law lexically the word *wa'ad* means willingness of a person or a group of persons on a particular subject matter. The technical definition builds on the lexical definition. Therefore, technically "*wa'ad* is a declaration that good will be done to someone in the future" (Al-'Ayni n.d). It is further said that "*idah* (which is synonymous with *wa'ad*) is a declaration that the declarer intends to perform a good act in the future" ('Ulaysh 1985). In a commercial transaction, such a promise carries dual connotation whereby the offeror is known as the promisor and the offeree as the promisee. In the practical sense, *wa'ad* has no specific definition of its own. However, it may be defined as a commitment made by one person to another to undertake a certain action beneficial to the other party.

Muwa'adah is the two reciprocal promises in which promisor promises to perform certain act or offer something and the promisee in return promises to perform certain act too. *Malikis* have used this term more often and clear example of *muwa'adah* is contract of marriage where each parties exchange reciprocal promises with each other. The term *muwa'adah* necessitates two parties acting in relation to one another. If only one of them makes a promise, it is called '*idah*'" (Al-Hattab 1969). We may, therefore, define *muwa'adah* as a declaration made by two parties that they will enter, in the future, into a contract and this contract will bind both the parties. Through analogy application of *muwa'adah* may be extended from marital context to bilateral commercial transactions. This research will explore this point in the later pages.

Therefore, promise is a self-imposed declaration (*iltizam al-wa'ad*) to do an act for the benefit of the other person irrespective of whether it entails adversity. *Shari'ah* requires

from the promisor to discharge his self-imposed obligation being a religious duty and also as a personal and social duty. As far as the legal consequences of a promise are concerned, jurists have different views. Scholars have mutually agreed that a promisor should act upon his or her promise to perform certain act, which is not prohibited. However, there still need clarification about whether or not fulfilling his or her promise is obligatory (*wajib*) or is it merely praiseworthy (*mustahab*)?

5.3 DIFFERENCE BETWEEN PROMISE AND CONTRACT (WA'AD AND 'AQD)

Despite the literature of Islamic law has clearly stated the differences between a *wa'ad* (promise) and an '*aqd* (contract), exact definition of *wa'ad* from the treatises of the law is still missing (Chehata 1968). The early jurists except *Malikis* have regarded '*aqd* as a legally binding contract but this is not the case for a *wa'ad*. In a promise, a promisor bears no liability to fulfil his promise despite his acceptance of the promise. However, if the promise is made under an oath, a promisor may be forced to fulfil his promise. In this *wa'ad*, a promisor is morally bound and not legally (Al-Masri 2002). Further to the above, a *wa'ad* cannot be binding on the promisor to fulfil even if all the jurists regards its non-completion as morally reprehensible. Let us focus on this point that why the earlier jurists did not regard *wa'ad* legally enforceable? In canon law, for instance, a promise was enforceable whereby the *ratio eccati* was added to the *ration delicti* and thus the obligation of conscience resulting from a promise was converted into a legal obligation (Chehata 1968). This point will be further explored in later discussion.

According to Qaradaghi (1985), before *shari'ah* jurists, '*qud* (contracts) are very important form of promises which are enforceable in the eye of law. In other words, we can say that all promises are not enforceable except few and those are which get the status of '*qud*. The crux of the above discussion is that classical jurists are agreed that an '*aqd* is legally binding on the parties and *wa'ad* is not so binding.

One of the key differences between a *wa'ad* and an '*aqd* is the timing, an '*aqd* is effected in the present whereas a *wa'ad* is in the future. By way of a promise, nothing is performed in actual except creation of a moral obligation on promisor. Therefore, Islamic law does not recognise an '*aqd* which has as its object a future thing, or an agreement to

agree, or the exchange of an obligation for an obligation for an obligation (Mallat 1996). Therefore, under Islamic law in a transaction exchanging two counter-values (should be *riba* free and that could be *riba al-nasi'ah* (*riba* by way of deferment)), should be concluded immediately. On top of that these counter values must be in existence, in their essence at least, and known to the contracting parties (Mallat 1996). Therefore, *shari'ah* requires that all exchanges must have *'iwadh* (an equivalent counter value). Ibn al-'Arabi (543/1148), regards every increase without an *'iwadh* or an equal counter value as *riba* (Rosly 2005). Therefore, the basic trait or condition *sine qua non* of a lawful (*halal*) sale is *'iwadh* and sale as such an exchange of a value against an equivalent value (Rosly 2005).

If we further differentiate between *wa'ad* and *'aqd*, we can see that *wa'ad* comes under *tabarru'at* which may be translated in English as voluntary offers. On the other hand *'aqd* falls under *mu'awadat* and its English translation could be commutative contracts. Since *tabarru'* and *mu'awadat* belong to two different categories therefore both can't replace each other. But is there a way that *wa'ad* could be used in place of *'aqd* changing *wa'ad*'s legal effect to that of an *'aqd* but in substance they be same that there is no difference? On this question scholars are divided with different opinions. Scholars favouring binding nature of *wa'ad* believe in form over substance and the other group of scholars who says *wa'ad* is not binding favours substance over form. The former group of scholars draws analogy between legally binding promises and *tabarru'at* and tries to justify the same in *mu'awadat* (Al-Zarqa 1984). The opponents argue that "if a contract is proscribed in a given case, then a binding unilateral promise (*wa'ad*) is equally proscribed therein... [as it would otherwise] turn that which is prohibited or unlawful (*haram*) into that which is lawful (*halal*)" (Masri 2002; Razali 2008). From the above discourse we may conclude that there is no agreed upon answer to the issue and this all depends on the answer whether or not it is a question of form over substance or the otherwise.

5.4 JURISTS' VIEW ON WA'AD

Scholars have different views regarding the binding nature of *wa'ad* but three of these are prevailing: (i) acting upon *wa'ad* is *mustahab* (praiseworthy) only but not *wajib* (obligatory); fulfilling *wa'ad* is always *wajib*; and (iii) fulfilling *wa'ad* is *wajib* in certain circumstances with some formalities.

5.4.1 FIRST VIEW

Majority of *fuqaha* support this juristic view like Imam Abu Hanifah, Imam Shafi'i, Imam Ahmad bin Hanbal, some of the Malikis and the Zahiri school (Al-Ghamrawi). According to these *fuqaha* though fulfilling *wa'ad* is *mustahab* and any failure to act upon a *wa'ad* is disliked act which does not amount to sin (Al-'Ayni n.d; Ulaysh n.d; Ibn Hazm 1988). In case the promisor makes a promise with the intention to cheat the promisee and to harm him, it may amount to sin (Qari 1994). Therefore, it may be concluded that if the resultant harm is unforeseeable, the promisor cannot be apprehended unless a wilful commission of a tort such as negligent misstatement is proved.

Supporters of this view provide evidence from *sunnah* and from the scholarly statements of the classical jurists. In a tradition recorded in *al-Muwatta'* it is stated that:

A person enquired of the Prophet (peace be upon him). "...[can] I make promises to [my wife] and tell her [things to make her happy]?" The Prophet (peace be upon him) replied, "it would not be held against you" (Al-Baji 1999).

Another tradition is recorded in *Sunan Abu Daud*:

"when a person promises his brother, intending to keep his promise, but then does not keep it and does not come to the appointed meeting, there is no sin upon him." (Abu Dawud 1984, Hadith No. 4977)

On the basis of above traditions, the jurists supporting this view prove the *mustahab* status of fulfilling *wa'ad*. Some can differ from this view by differentiating between social promises and financial or commercial promises. In this particular division social

promises may be regarded as *mustahab* and financial or commercial promises may be regarded as binding otherwise party to a financial promise may suffer financial loss which these traditions may not be intended for.

The supporters of current view make an analogy to the *hibah* (gift) contract. In *hibah* contracts, the donor may withdraw from his or her offer prior to completion or taking possession of the property by the donee and donee has no legal recourse against the donor to enforce his promise. Situation is quite similar in charitable transactions. The jurists argue that since a charitable act cannot be made binding prior to completion, a promise to perform a charitable act has even more arguments for not being made binding.

Regarding above statements by the jurists, Al-Muhallab states that “all [jurists] agree that keeping promises is commended and encouraged [by the *shari'ah*] but it is not obligatory based on their consensus that a person who was made an unfulfilled promise cannot contend with the creditors [or the promisor for his assets in case of bankruptcy]” (Al-'Asqalani 1988). Ibn Battal asserted that “none of the *salaf* [predecessors] have transmitted the absolute obligation to keep a promise. It has only been reported from Malik that it is obligatory to keep that for which there is a [special] reason” (Al-'Asqalani 1988). Hattab while explaining Malik's view states reasons for making the promisor duty bound to fulfil the promise are the losses which a promise has to borne for an unfulfilled promise (Al-Hattab 1969). Al-'Asqalani (1988) challenges that the fulfilment of *wa'ad* is *mustahab* and substantiate his stance on the basis of a minority dissenting view (Al-'Asqalani 1988). According to him Ibn 'Abd al-Barr and Ibn 'Arabi described that 'Umar ibn 'Abd al-'Aziz regarded fulfilment of *wa'ad* as *wajib* (Al-'Asqalani 1988).

Ibn Hazm (1988) came with a rational argument and states that a promisor who promises without qualifying with the statement [if *Allah* wills] has disobeyed *Allah*, the Exalted, in his promise. In addition, one can not force a promisor to perform such promise if he is not willing to do so and one does, it will amount the disobedience [of *Allah*]. Thus, if he says, if *Allah* wills, or something similar that makes fulfilment contingent upon the will of *Allah*, he has not breached his promise if he does not do [the act]. That is because...it means that *Allah* did not make it happen” (Ibn Hazm 1988). This shows that Ibn Hazm

(1988) supports the view that the fulfilment of *wa'ad* is *wajib* but it is not where it is qualified with the statement [if *Allah* wills].

5.4.2 SECOND VIEW

The second view is the fulfilment of a *wa'ad* is *wajib* and this view is attributed to Samurah ibn Jundub, a companion of the Prophet (peace be upon him), Umar ibn 'Abd al-Aziz, Hasan al-Basri, Sa'id ibn al-Ashwa', Ishaq ibn Rahwaih and Imam al-Bukhari (Al-'Asqalani 1988). The same is the view of Ibn al-'Arabi, Ibn Shubrumah and al-Ghazali (Al Qurtubi 1967; Ibn Hazm 1988; Al-Ghazali 1996). Al-Qarafi states that it is absolutely obligatory to fulfil promises. Then he says that it is necessary to interpret any contradictory evidence in a way that reconciles it with the ruling (Al-Qarafi et al. 2001). According to Ibn Rajab (2007) some Zahiri jurists also hold this position. The supporters of this view present following evidence:

The verse of Qur'an:

“O you who believe, why do you say what you do not do?” (Qur'an 61:2)

This verse is used as evidence that should someone make a promise has to fulfil it. The logic thus follows that fulfilling a promise is obligatory (Al-Qarafi et al. 2001). Imam Abu Bakr al-Jassas (1985) on this verse says that it is obligatory on a promisor to fulfil it irrespective of it being a matter of worship or a contract.

A number of Qur'anic verses describe how important promise was in the lives of prophets and *Allah* describes Himself as the One who keeps promises and asks people to do the same. These verses are:

“And Ibrahim, who fulfilled [his promises, covenants]” (Qur'an, 53: 37);

“And remember Ismail in the Book. He was true to his promise, a messenger and a prophet” (Qur'an, 19: 54);

“[It is] the promise of Allah. Allah does not break His promise” (Qur'an, 39: 20); and

“Allah’s promise is true” (Qur’an, 31: 9).

Therefore, Al-Qurtubi (1967) and Al-Jassas (1985) regard it necessary for one to keep his promises otherwise he will be disregarding these Qur’anic verses, which is a sin. Hence, it may logically be said that any breach of a promise is prohibited and avoiding prohibitions is *wajib*.

Similarly, a number of traditions reported from Prophet (peace be upon him) stress on the fulfilment of promises. These are:

“the signs of a hypocrite are three: when he speaks he lies; when he promises he breaks his promise; and when he is entrusted he betrays the trust” (Al-Asqalani 1988);

“He made me a promise and he kept it” (Al-Asqalani 1988); and

“the promise of a Muslim is a binding obligation” (Ibn Hazm 1988).

Scholars supporting this view hold that it is *wajib* to fulfil promises if one breaks he is liable for the punishment, which a hypocrite deserves on the day of judgement and that is hell-fire.

5.4.3 THIRD VIEW

This view is attributed to some of the Maliki scholars. They argue that promise is not binding on the promisor but where a promise incurs expenses relying on the promise then it is upon the promisor to execute it (‘Ulaysh n.d). This view is attributed to Ibn al-Qasim recorded in al-Mudawwanah (‘Ulaysh, n.d). Asbagh and many other Maliki scholars regard it obligatory to execute a promise without any regard to the fact that a promise has incurred some expenses relying on the promisor’s commitment (‘Ulaysh, n.d).

Ibn Hazm (1988) criticised this view of Maliki by stating that there is no evidence, neither from the Qur’an nor from the *sunnah* nor from a statement of a companion and nor from *qiyas*. He further presents the view of Ibn Shubrumah, which states that all promises are binding, and the promisor is to be legally compelled [to fulfil his promise

(Ibn Hazm 1988). *Wa'ad* becomes legally binding in certain circumstances and conditions attached to it. Legal maxim, “promises in conditional form become binding”, supports this view (Tyser et al. 1967).

5.5 PROMISE IN THE EYES OF PRESENT DAY SCHOLARS

Contemporary *shari'ah* scholars have ruled that a *wa'ad* becomes binding where it gives rise to a tort. These are listed below.

In 1979 at the First Conference of Islamic Banking in Dubai, *wa'ad* was discussed in the context of *murabahah*. It was agreed upon that where a promise relying on the promise of a promisor does certain act which makes him vulnerable to loss if that promise is not fulfilled then promise becomes binding (Laldin 2009). This decision relied on the Maliki view explained above.

Kuwait Finance House (KFH)'s *shari'ah* board, in 1979, held that a *wa'ad* is a binding phenomena (Al-Qaradawi 1995). The ruling was based on Ibn Shubrumah's view on promise (Ibn Hazm 1988). But in a currency transaction the *shari'ah* board of KFH rejected use of *wa'ad* (KFH 1979). The reason of the rejection was based on the argument that currency transactions should be spot and *wa'ad* relates to future transaction (KFH1979). This is extremely important for FX transactions.

A *shari'ah* ruling was issued on *muwa'adah* in 1981 at the First Dallah Al-baraka Symposium. The ruling was issued on the use of *muwa'adah* for buying certain currencies at the price fixed on the day promises were made with the payment to make on a later date. The ruling states that if the *muwa'adah* is considered binding then this can't be allowed because it will amount to the prohibited trading of debt for debt. But it is allowed where the *muwa'adah* is considered non-binding on either party then it is allowed (Al Baraka 2002: *Fatwa* No. 13 of 1981).

In 1983 at the Second Conference of Islamic Banking in Kuwait was held wherein both *wa'ad* and *muwa'adah* were approved for *murabahah* financing which was subject to the approval of individual *shari'ah* boards with certain conditions. These are: (i) the ownership and possession of goods lies with the financier; (ii) the sale is completed at a

rate of profit in line with the previous promissory agreement; (iii) till the delivery of the goods to the customer, the financier bears the risk of any damage etc.; and (iv) in case of any defect to the goods, the goods will be returned to the financier (Al-Qaradawi 1995). AAOIFI also issued a *shari'ah* Standard concerning *murabahah* financing and concerning the various promises employed (AAOIFI 2010: Standard 8).

A *shari'ah* ruling was issued in 1986 at the Sixth Dallah AlBaraka Symposium (Al-Baraka 2002). In 1988 the Council of the IFA of the OIC in essence reiterated the contents of the 1983 Second Islamic Banking Conference in Kuwait (IDB 2000). It was held that *wa'ad* can be enforced legally against promisor if promisee upon the promisor's promise incurs expenses. In case of promisor's failure to carry out his promise, the promisee will be compensated and claim for damages (AAOIFI 2010: Standard 8). This kind of promise or *wa'ad* cannot be said to be a gratuitous one rather it would be commercial one as is under English law. This point will be discussed in detail in later part of this research.

In 1988, the Council of the IFA of the OIC has also allowed the *muwa'adah* for *murabahah* financing with a condition that either one or both the parties have obtained approval from the *shari'ah* board (IDB 2000).

In 2004, the Council of the IFA of the OIC approved the use of *wa'ad* in *musharakah mutanaqisah*. It held that it uniquely incorporates a binding promise from only one of the two parties to effect multiple purchase contracts whereby one person gains complete possession of every portion of the other's stake. AAOIFI, further has held in its *shari'ah* standard that any promise to buy the assets of the partnership should be at the market price but not at the nominal price (AAOIFI 2010: Standard 12).

In 2006 the Council of the IFA of the OIC on *muwa'adah* and mutual agreements issued five rulings which are as follows: (i) *muwa'adah* is not legally but morally binding. (ii) any transaction that involves a collusion to transact an *'inah* sale or any *muwa'adah* to engage in a sale which is combined with a loan is strictly prohibited. (iii) in case if it is not possible to effect a sale for lack of possession of the commodity and there are circumstances making it necessary to effect the sale to oblige both the parties then a

forward contract is allowed. The promises in this situation may be made legally binding through either legislation or mutual agreement of the parties. (iv) the binding *muwa'adah* in the third scenario does not take the ruling of sales. (v) if a party does not fulfil its obligation by carrying out his promise, the other party can have a legal recourse against the defaulting party and can claim compensation or damages but there is no liability for loss of opportunity (Seventeenth Session, Jordan). The 2006 Council rulings regarding *muwa'adah* are qualified with clear stipulations and as such they will not take effect as general rulings of sale.

The above discussion about *wa'ad* and *muwa'adah* has shown that under *shari'ah* they may be enforceable due to any 'detriment' being suffered by the promise. In other words, *wa'ad* would be legally binding should it be rendered conditional upon the fulfilment of an obligation and the promise has incurred expenses as a result. However, this will only be the case where there are commercial promises and not social promises as the latter are not legally binding due to lack of *'iwadh* (consideration) but merely gratuitous promises.

5.6 PROMISE AND THE COMMON LAW

There are two characteristics present in *wa'ad* namely: (i) its unilateral nature; and (ii) ability of the other party to seek compensation from the unilateral promisor. Therefore, Uberoi, Chanerji and Bidar regard *wa'ad* similar to the doctrine of promissory estoppels (Uberoi et al.2009).

Abdullah (2010) has discussed the salient features of promissory estoppels by referring to the case of *Combe v. Combe*, 1951

- (i) A promise is made from one person to another.
- (ii) It is made with the intention to create legal relations.
- (iii) The promisee acts by relying on the promise.
- (iv) Once a promisee acts by relying on the promise, the promisor cannot deny such a promise and must accept the legal implications.
- (v) Promisor may be held liable despite the promise lacks consideration.

Abdullah (2010) presents a legal judgment in the case of *Central London Property Trust Ltd. v High Trees House Ltd* (1947) supporting English common law position. The court held that despite the lack of consideration, the court would not allow a promisor to back out from his promise (Abdullah 2010). However, the court did not grant damages. Abdullah (2010) summarise the whole discussion as follows:

- (i) The promise is required to be clear and un-equivocal.
- (ii) There is a pre-existing legal relationship between parties.
- (iii) It must be inequitable for the promisor to deny his promise.
- (iv) The promise must have acted in reliance on the promise.

Similarities between *wa'ad* and promissory estoppel, Uberoi, Chanerji and Bidar (2009) mention a difference between the two which makes *wa'ad* and promissory estoppel not alike. Explaining this difference, Uberoi, Chanerji and Bidar (2009) mention that the English promissory estoppel cannot be taken as an independent claim rather as a defence. This difference is based on findings of the legal cases of *Combe v Combe* and *Lark v Outhwaite* [1991] 2 Lloyd's Rep. 132. Therefore, *wa'ad*, according to them may not prove as an effective tool if it is limited to a defensive claim. Razali (2008) presents differences between the civil law and common law systems with regards to enforcement of promises. He refers to James Gordley's work, "The Enforceability of promises in European contract Law" (Razali 2008). As per his research, he finds out that the promise is enforceable under civil law but it may not be enforced before common law without any consideration (Razali 2008).

Rosly (2005) writes on the contracts of exchange and contracts of gratitude. Contracts of exchange are valid if the following three elements are found: (i) effort (*kasb*); (ii) liability (*gharm*); and (iii) risk (*daman*). This is exactly what the theory of profit is. As per this theory, parties promise to exchange counter values (*'iwadh*) and this is similar to the concept of consideration in common law.

Uberoi, Chanerji and Bidar discuss commonalities between the promise and *wa'ad* and conclude that both lack the essential element of consideration. In order to be enforceable, a *wa'ad* has to be recorded in the form of a deed poll (Uberoi et al. 2009). In this situation

no consideration is required because in the light of *Thomas v. Thomas* case, English law does not allow gratuitous promises (Uberoiet al. 2009).

Razali (2008) says that forbearance can be regarded as consideration. In “Contract as Promise: A Theory of Contractual Obligation”, Charles Fried cites the case of *Hamer v. Sidway* in which forbearance is considered as a valid consideration (Fried 1981). The facts of the case are as follows. An uncle promises to pay his nephew a certain amount of money where nephew quit smoking. Despite his nephew’s quitting smoking, his uncle refuses to pay promised amount on the ground of lack of consideration. The court held that the nephew’s forbearance was sufficient consideration.

The above issues of English common law related to *wa'ad* will be researched in a separate chapter in thorough detail so as to ascertain the correct English legal stance on enforceability.

5.7 CASE LAWS ON THE MATTER OF PROMISE

To understand parallel system of promise in English common law, an understanding of promise and promissory estoppel is necessary. These concepts may best be explained in the context of legal and equitable principles of contract and equity.

English contract requires basic elements to be fulfilled in order to get legal force behind it. There must be two or more separate parties (*Hamer v. Sidway* (1891) 2 AC 234 at 193) and these must be definite one (*Kelner v. Baxter* (1866) LR 2 CP 174 at 185); those parties must be in agreement which is sometimes known as ‘consensus ad idem’ (*United Dominions Trust (Commercial) Ltd v. Eagle Aircraft Services Ltd* [1968] 1 All ER 104 at 108); there must be intention of the parties to have legal relations. This makes promises enforceable as contractual promises (*Taylor v. Brewer* (1813) 1 M & S 290; *Balfour v. Balfour* [1919] 2 KB 571); there must be consideration in exchange of promise (*Thomas v. Thomas* (1842) 2 QB 851). Generally speaking the law does not enforce a bare promise (‘*nudum pactum*’) but only a bargain (*Four Oaks Estate Ltd v. Hadley* (1986) 83 Law LS Gaz 2326). *Wa'ad* may be compared with a bare promise (‘*nudum pactum*’) due to lack of consideration.

But since *wa'ad* is being used in commercial transactions, therefore, these promises may not be regarded as gratuitous promise neither under *shari'ah* nor under English law rather these may be known as commercial promise under English law (Atiyah 1986). The doctrine of consideration also includes a benefit to the promisor or something detrimental to the promise (*Curie v. Misa* (1875) LR 10 Ex 153 at 162). Therefore sufficient consideration is required in order to enforce the promise like a contract in English law (*Thomas v. Thomas* (1842) 2 QB 852 at 859).

So consideration constitutes an important element for the enforceability of promise. A right, interest, profit, or benefit accruing to one party or some forbearance, detriment, loss, or responsibility given, suffered, or undertaken by the other at his request, are considered as valuable considerations (*Marrie v. Misa* (1875) LR 10 Exch 153 at 162). In order to constitute a valid consideration, it is not necessarily to benefit the promisor but even anything beneficial to a third party may also constitute a valid consideration (*Bailey v. Croft* (1812) 4 Taunt 611; *Alhusen v. Prest* (1851) 6 Exch 720). Whether any consideration is beneficial or detrimental, it must be linked to a promise in order to constitute a consideration (*Wigan v. English and Scottish Law Life Assurance Association* [1909] 1 Ch 291). This is a key difference as *wa'ad* is by nature unilateral as discussed before.

For a promise a consideration should be in the future that is to say it may be executed or executory. A consideration is executory when there is a promise either to do or forbear from doing some act in the future. An executed consideration includes some act or forbearance prior to binding of a promise (*Peeke v. Redman* (1552) 2 Dyer 113a; *Joscelin v. Shelton* (1557) 3 Leon 4). In past consideration, a promise does some act before the promise (*Lampleigh v. Brathwait* (1615) Hob 105; *Dent v. Bennett* (1839) 4 My & Cr 269). Whether the consideration is executed or executor is a question of fact and not of law (*Walsh v. Westpac Banking Corpn* (1992) 104 ACTR 30). The burden of proving that the consideration was not past is on the party seeking to enforce the promise (*Savage v. Uwechia* [1961] 1 All ER 830). In commercial *wa'ad*, the promise is related to a future act or forbearance. Therefore, the consideration will be executor in nature as provided

under English law. Further the promise will only be enforced if the promisee has suffered a financial loss in response to the promisor's promise.

In order to understand the legal framework of *wa'ad* it is important to understand the concept of consideration. A promise without consideration has no legal value unless it is done under a deed poll (*Rann v. Hughes* (1778) 7 Term Rep 350n; *Davis v. Dodd* (1812) 4 Taunt 602; *Saltzberg and Rubin v. Hollis Securities Ltd* (1964) 48 DLR 344; *Gilbert Steel Ltd v. University Construction Ltd* (1976) 12 OR (2d) 19). We can conclude that *wa'ad* can't be enforced under the English law if it is gratuitous i.e., without consideration (*Thomas v. Thomas*, 1842).

However, *wa'ad* may still be enforceable under English law because consideration is required where a promise is made through a deed which is binding on the executor (*Pinnel's Case* (1602) 5 Co Rep 117a at 117b; *Re Vallance, Vallance v. Blagden* (1884) 26 ChD 353; *Re Whitaker, Whitaker v. Palmer* [1901] 1 Ch 9). The above principle has been translated into a rule of law that a deed imports a consideration on account of the solemnity with which it is executed. In early law a written document was important and was treated as a valid proof about the intention of a person. Later on it was also became a requirement to have seal of the person executing the document besides his signatures. In the present times since the oral agreements are common have legal effect where valid consideration is given in return of the promise (*Mitas v. Hyams* [1951] 2 TLR 1215 at 1217, per Denning LJ; *Plymouth Corp'n v. Harvey* [1971] 1 All ER 623).

Coming to conclusion, *wa'ad* is a parallel concept of gratuitous promise in English law and it may be enforceable under English law through a deed poll or if the element of forbearance can be proved as a valid consideration. Whether a deed poll in *wa'ad* be regarded as '*aqd al-mu'awadhah*? We will explore this point later in this research.

Where a promisor without consideration promises to fulfil an existing contract (promissory estoppel), the same may be enforced by the promisee (*Combe v. Combe* [1951] 2 KB 215; *Argy Trading Development Co. Ltd v. Lapid Developments Ltd* [1977] 3 All ER 785; *Burton v. Brook* (1956) 6 DLR (2d) 464). Promissory estoppel will be discussed in the later sections of this research.

A promise and *wa'ad* without any consideration and having not been recorded in a deed poll can't be legally enforced. There is still an alternative course where a *wa'ad* or a promise is not enforced. A promise made without consideration may give rise to liability in tort. In the past there have been an action in courts under contract law for careless statements (*De La Bere v. Pearson Ltd* [1908] 1 KB 280), which now has been replaced by an action under tort of negligent misstatement (*Hedley Byrne & Co. Ltd. v. Heller & Partners Ltd* (1964) AC 465). An action under tort of negligent misstatement may be initiated where a promisor though intended to perform his promise but failed to perform his promise with reasonable care (*Henderson v. Merrett Syndicates Ltd* [1995] 2 AC 145 at 182, per Lord Goff; *Barclays Bank plc. v. Fairclough Building Ltd.* [1995] IRLR 605). It may be concluded from the Henderson case that a promise may easily bring a case for damages for non-performance against the promisor. Further, in the cases where the promisor is under an already existing contractual duty to a third party to act, the tort principle has been extended to encompass liability in tort for omission (*Midland Bank Trust Co. Ltd. v. Hett, Stubbs & Kemp* [1979] Ch 384; *White v. Jones* [1995] 2 AC 207). However, it is unlikely that the tort liability be extended to liability for pure economic loss because this would tantamount to a '*nudum pactum*' agreeing to be liable for economic loss (*Midland Bank Trust Co. Ltd. v. Hett, Stubbs & Kemp* [1979] Ch 384; *White v. Jones* [1995] 2 AC 207).

It is, therefore, in the light of above discussion, legal principles and case laws particularly *Thomas v. Thomas*, concluded that *wa'ad* is not an enforceable phenomena under English common law (*Thomas v. Thomas* (1842) 2 QB 852 at 859.). It may however be enforced if it is executed through a deed poll or there is an element of forbearance which can be proved or alternatively a party can bring action in tort.

5.8 PROMISSORY ESTOPPEL AND WA'AD

Promissory estoppel is another phenomena in English legal system having some similarities with *wa'ad*. Firstly, in both *wa'ad* and promissory estoppel, promise is made unilaterally. Secondly, for failure of promisor to perform his promise, the promisee can seek compensation. An understanding of the equitable principle is given below before the

extent of the analogous application is discussed between a promissory estoppel and *wa'ad*.

Promissory estoppel is an extension of common law estoppel through the principles of equity (Burn 2000). Another name for common law estoppel is estoppel by representation (*Carr v. London and North Western Rly Co.* (1875) LR 10 CP 307 at 316-7 per Brett J). Common law applies only to statements of existing facts and not on representations of future promises (*Jorden v. Money* (1854) 5 HL Cas 185; *Lyle-Meller v. A Lewis & Co. (Westminster) Ltd* [1956] 1 All ER 247). Therefore it seems that *wa'ad* is more closer to the equitable doctrine.

The English doctrine may be compared with the doctrine of *istihsan* (juristic preference) under Islamic jurisprudence. Both have the principles of fairness and both can depart from strict rules of positive law where its enforcement leads to unfairness (Kamali 2004). On the basis of this *wa'ad* may be treated as commercial promise.

According to the doctrine of promissory estoppel if someone through his words or conduct makes a clear and unequivocal promise to another person and this promise amounts to create a legal relationship. Once the other person relying on this promise does some act, the promisor will be liable to fulfil his promise (*Combe v. Combe* [1951] 2 KB 215 at 220, per Denning LJ). The same is also true of *wa'ad*. The above principle was developed in 1877 in a decided case (*Hughes v. Metropolitan Rly Co* (1877) 2 App Cas 439 at 448, per Lord Cairns LC). This principle was first applied in *Central London Property Trust Ltd v. High Trees House Ltd* in 1944 (*Central London Property Trust Ltd v. High Trees House Ltd* [1947] KB 130 at 134, per Denning J). The doctrine has since been described as the 'High Trees' doctrine and the comments of Denning have been regarded as obiter dicta (*Slough Estates Ltd v. Slough Borough Council (No. 2)* (1967) 19 P & CR 326 at 362, per Megarry J).

Promissory estoppel has following differences from its common law promise: (i) promissory estoppel applies to promises and not on representations of existing facts (*James v. Heim Gallery (London)* [1980] 2 EGLR 119 at 120, per Buckley LJ; *Collin v. Duke of Westminster* [1985] QB 581 at 595, per Oliver LJ). The same is true for *wa'ad*.

(i) Further a promissory estoppel is suspensory in operation and it has the effect of suspending promisee's obligations to the promisor (*Birmingham and District Land Co. v. London and North Western Rly Co.* (1888) 40 ChD 268, per Bowen LJ). In *wa'ad* there is a difference which is in the light of 1988 IFA Ruling the promise can either compel the promisor to fulfil the promise or alternatively can seek compensation for consequential losses. *Shari'ah* standard 8, Para 4/2 of AAOIFI has also incorporated the same principle.

(iii) In promissory estoppel it is not necessary that any breach of promisor should cause any detrimental effect. Even in some of the decided cases it was difficult to ascertain any detrimental effect (*WJ Alan & Co. Ltd. v. El Nasr Export and Import Co.* [1972] 2 QB 189 at 213, obiter per Lord Denning MR). According to 1988 IFA ruling, in *wa'ad* in order to get legal force to bind the parties there should be detrimental reliance.

Owing to the above differences, the equitable doctrine is dissimilar to the common law doctrine (*Ross T Smythy & Co. Ltd v. T.D. Bailey, Son & Co.* [1940] 3 All ER 60 at 70, per Lord Wright). Further to the above, it is not similar to *wa'ad* as well. The equitable doctrine does not create new causes of action where one existed before (*Combe v. Combe* [1951] 2 KB 215). This point is sometime doubted or ignored in later dicta (*Re Wyvern Developments Ltd* [1974] 2 All ER 535 at 542-543, per Templeman J; *Evenden v. Guildford City Association Football Club Ltd* [1975] QB 917 at 924, per Lord Denning MR and at 926 and 275 per Browne LJ). The fundamental reason for this is that in English law consideration is usually required to create new rights. But consideration is not necessarily needed for the modification or discharge of these rights (*Combe v. Combe* (1951)).

The above position of English law is contrary to the American legal stance. In American legal system a promise which the promisor should reasonably expect to induce action or forbearance on the part of the promisee or a third person and which does induce such action or forbearance is binding if injustice can be avoided only by enforcement of the promise (American Law Institute 1981); *Waltons Stores (Interstate) Ltd v. Maher* (1988) 76 ALR 513).

It has been said that the High Trees doctrine operates as a shield and not as a sword (*Combe v. Combe* (1951)). This means that it cannot be used as a separate legal cause of action but only as a defence to prevent the enforcement of a claim by suspending the promise's legal obligations to the promisor, thus ensuring that a concession is not withdrawn (*Durham Fancy Goods Ltd v. Michael Jackson (Fancy Goods) Ltd* [1968] 2 QB 839 at 847, per Donaldson J). This distinction of promissory estoppel that it can only be used as part of a defence is another key difference with *wa'ad*. If *wa'ad* was treated like promissory estoppel, then it would mean that no independent claims for compensation can be filed by the promise which would neutralise the efficiency of *wa'ad* as a structuring tool in *shari'ah*-compliant transactions (Uberoiet al. 2009).

It may not be true to say that the English equitable doctrine can never operate except as a defence. But it might act as a necessary foundation of an independent claim. Thus, for instance, if a buyer of goods due for delivery on a specific date agrees at the request of the seller to accept delivery on another date instead, the buyer would be liable to be sued for damages for non-acceptance if he refused to take delivery on the other agreed date (*Hartley v. Hymans* [1920] 3 KB 475). There is no consistent judicial precedent on this point and most commentators argue that the position is yet to be finalised. Therefore it is submitted that while at present *wa'ad* should not be construed as equivalent to the English equitable doctrine, there may be opportunity in future to do so should the English courts allow the doctrine to operate as an independent claim.

In light of the above case law analysis, it is submitted that *wa'ad* has some resemblance with promise and promissory estoppel. However in order for it to be legally enforceable as such it must either be executed under a deed poll, which by legal convention does not require any consideration but still has the effect similar to a legally binding contract, or the element of forbearance needs to be proven or it should form part of a tortious legal action.

5.9 WA'AD IN EQUITY-BASED SUKUK

It is expected that *sukuk* have different features as that of bonds but still, in *sukuk*, certain mechanisms have been employed which differentiate them from conventional bonds in

order to avoid certain issues from arising. In addition, application of these mechanisms is important to obtain a required rating of *sukuk* (McMillen 2007; Mokhatar 2008; Moody's 2009). Al-Masri (2002) draws attention towards the AAOIFI's recommendations which were aimed at to bring the *sukuk* practices in line with the *shari'ah*.

Al-Amine (2008b) and Haneef (2009) provides the study of the developments in *sukuk* structures and describe the issues which are being faced in those structures. Moody's (2009) mentions about the development of *sukuk* structures and state that these evolved from the asset-based structure³ of pre-AAOIFI standards back to asset-backed structure⁴ of post-AAOIFI standards. The table below provides a comparison between the two structures. The *wa'ad* is used in the first category:

Table 5.1: Comparison between Asset-based and Asset-backed Structures

| Sukuk category | Analytical characteristics |
|--|--|
| Unsecured asset-based <i>sukuk</i> | The issuance principal is effectively "guaranteed", in most cases by the originator, via a purchase undertaking agreement, i.e., a commitment to buy back the underlying assets at the <i>sukuk</i> maturity at original or pre-agreed price. The coupons (periodic distribution amounts) are protected by a liquidity provision, i.e., the commitment of the originator/guarantor to provide sufficient liquidity to make up for any shortfall between asset returns and periodic distribution amounts. |
| Secured asset-backed <i>sukuk</i> (Islamic securitisation) | Neither the principal nor the coupons are subject to formal guarantees. <i>Sukuk</i> performance is asset driven and the effective legal transfer of assets to investors (true sale) is critical. |

Source: Moody's (2008c)

While mentioning issues in equity-based *sukuk*, Usmani (2008) states that it is not permissible to agree by way of a *wa'ad* to repurchase the assets at par value from the *sukuk* holders at the maturity or upon an early dissolution of the *sukuk*. He, however, allows the agreement where agreement to repurchase the *sukuk* from the *sukuk* holders at

³ In asset-based *sukuk*, *sukuk* holders rely on the obligor for repayment of the principal and return and rank *paripassu* with unsecured creditors where the obligor defaults as they have no legal recourse to the underlying assets and the requirement of having tangible assets is almost non-existent.

⁴ In asset-backed *sukuk*, *sukuk* holders have ownership rights over the underlying assets by relying on the assets of the *sukuk* issuer for security.

net value, market value or for a price agreed at the time of the repurchase in accordance with the rules of *shari'ah*.

Abdel-Khaleq and Crosby (2009) in relation to *musharakah sukuk*, Kapetanovic and Becic (2009) in *mudarabah*-based *sukuk* and Naim and Hussain (2009) in *wakalah sukuk* hold the same view that any agreement to repurchase *sukuk* from the *sukuk* holders at par value at maturity is not permissible. Mokhtar and Thomas (2009) permit to agree using *wa'ad* to repurchase the leased assets at maturity or upon an early termination of the lease at par value with the condition that the lessee is not a *sharik*, *mudarib* or *wakil* of the lessor.

Status of *wa'ad* in equity-based *sukuk* can be found in AAOIFI *shari'ah* standards. AAOIFI Standard 17 states that where the manager acts as a *sharik* [or a *mudarib*] with the *sukuk* holders, it is unlawful for him to guarantee the return of capital to them as it would interrupt the partnership in the event of losses or in the sharing of profits (AAOIFI 2010: Standard 12: Para. 3.1.5.7). AAOIFI Standard 12 allows a promise to repurchase the assets at market value or at an agreed price at the time of repurchase (AAOIFI 2010: Standard 12: Para. 3.1.6.2).

Usmani (2008) denies the argument of those who allow the use of *wa'ad* in equity-based *sukuk* on the ground that *sukuk* is actually a partnership in property (*shirkah al-milk*) and that the use of *wa'ad* is prohibited in partnership of contract (*shirkah al-'aqd*) only. He argues that in reality a *sukuk* is a partnership of contract (*shirkah al-'aqd*) because both have same qualities. In partnership of contract, partners joins together as agent of each other and carry out business activities for their collective benefits and share profit or loss according to the ratios agreed among them. The same is the mechanism of *sukuk*. Mustafa al-Zarqa (1984) also argues that whenever the purpose of a partnership is investment or earning, regardless of whether that is to take place by means of commerce or leasing, the partnership will be one of contract. Therefore, according to Usmani (2008) *sukuk* are not partnership of property (*shirkah al-milk*) because the object is earning either by way of investment or leasing and this renders *sukuk* partnership of contract (*shirkah al-'aqd*) hence the usage of *wa'ad* is unacceptable in equity *sukuk*.

Usmani (2008) also held the use of *wa'ad* in *mudarabah sukuk* as unlawful. AAOIFI Standard 13 provides the reasoning by stating that if the loss is greater than the earnings, the losses ought to be deducted from the capital provided that there is no negligence or *mala fide* on the part of the manager (AAOIFI 2010: Standard 13: Para. 7.8). The Standard continues that if the costs are equal to the earnings, the *sukuk* holders will receive their capital back and the manager will earn nothing (ibid). Conversely if there is profit, it will be distributed among the *sukuk* holders and the manager in accordance with the pre-agreed ratio (ibid). Therefore, Usmani (2008) concludes that no such undertaking is acceptable. He also refutes the argument that in some *sukuk* the manager actually gives such an undertaking in another capacity. He states that this is clearly illogical because the *mudarib* has no other capacity in such a venture.

Use of *wa'ad* by the manager who acts as a *wakil* in *wakalah sukuk* is not permitted (ibid). *Wakalah* contract is based on trust where any guaranteed return is not allowed except where the *wakil* is either negligent or acts with *mala fide* (ibid). AAOIFI Standard 5 states that “a guarantee by an investment agent will transform the operation into a loan with *ribawi* interest, guaranteeing [the return of] principal while offering returns from the investment” (AAOIFI 2010: Standard 5: Para. 1.2.3). In addition any use of *wa'ad* by the *wakil* in *wakalah sukuk* may convert the transaction into an *'inah* transaction because the *wakil* undertakes to repurchase the *sukuk* (Usmani 2008).

Haneef (2009) suggests that asset-based *sukuk* must contain a purchase undertaking. An asset-based *sukuk* is a “*sukuk* where the underlying assets offer fairly predictable returns to the *sukuk* holders, such as in the case of *salam*, *istisna'* and *ijarah'*” (IFSB 2005: Guidelines No. 2). Majority of asset-based *sukuk* structures do not reflect the true ownership of the *sukuk* holders in the underlying assets (Dusuki and Mokhtar 2010) hence the IFSB criteria is not complied with. In 2009 this lead to the introduction of a new standard which is IFSB Standard 7. According to Dusuki and Mokhtar (2010) the standard elaborates two types of asset-based *sukuk*: the first category of *sukuk* contains a purchase undertaking from the originator and the second category contains an undertaking from the issuer in the event the originator defaults.

In *shari'ah* innovations are allowed but not at the expense of compromising to *shari'ah* principles hence *wa'ad* should not be used in compromise to the *shari'ah* principles. In 2008, the AAOIFI pronounced that the use of *wa'ad* in the form of purchase undertaking at par value in equity-based sukuk, namely *musharakah*, *mudarabah* and *wakalah*, is not allowed. The usage of *wa'ad* in equity-based sukuk is illustrated in the below figure. Thus the then chairman of AAOIFI, Taqi Usmani declared that 85% of the sukuk in the market are not *shari'ah* compliant (Reuters 2007).

Figure 5.1: Usage of Wa'ad in Equity-based Sukuk

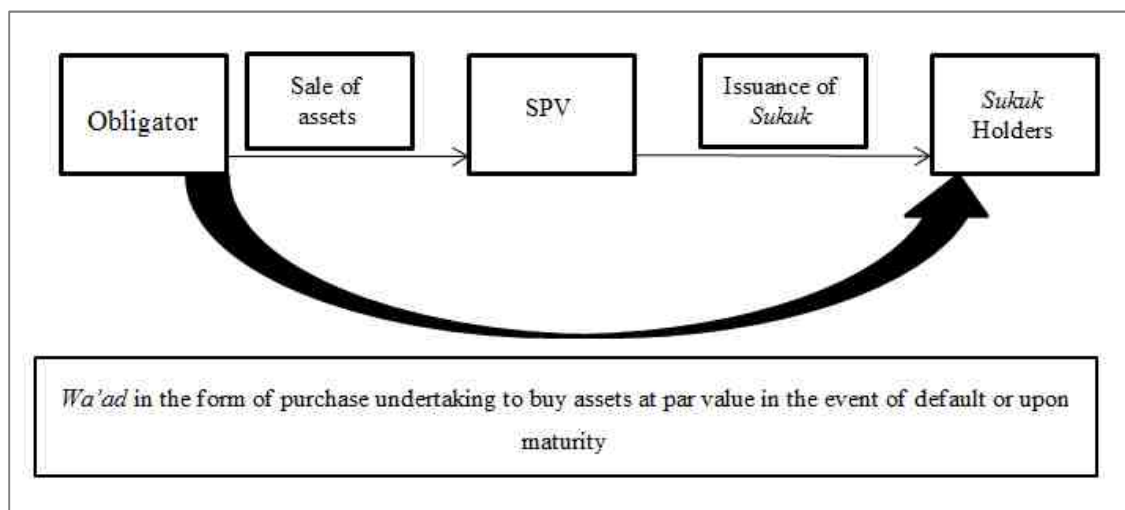

Source: Author's own

The AAOIFI pronouncement highlighted two issues in equity-based *sukuk*. One is the use of liquidity facility and the other is purchase undertaking at par in acquiring the *sukuk* (AAOIFI 2008). AAOIFI broadly refers only to asset-backed *sukuk* structure but IFSB refers to an asset-backed and two asset-based structures (IFSB 2009: Standard 7). In the first IFSB asset-based structure a purchase undertaking in the form of *wa'ad* is used from the originator and this structure is also known as pay-through *sukuk*. In the second asset-based structure a guarantee is given by the issuer in case the originator defaults. This structure is also known as pass-through *sukuk*. Our discussion will be limited to all AAOIFI asset-based *sukuk* and to those IFSB asset-based *sukuk* that involve *wa'ad*.

AAOIFI regards the usage of *wa'ad* against the spirit of equity-based *sukuk* because the usage of *wa'ad* in a *sukuk* structure guarantees return or the principal amount to the *sukuk* holder which is against the principles of *shari'ah* (AAOIFI 2010: Standard 12: Article 3/1/6/2). In *shair'ah* any guarantee of return of investment and any proceed thereof by a *sharik* or *mudharib* or a *wakil* makes the transaction a prohibited interest based transaction of loan (AAOIFI 2010: Standard 5: Articles 2/2/1 and 2/2/2). The classical *shari'ah* scholars are in agreement to prohibit a guarantee clause in a contract but they differ on the status of the contract (Bank Negara Malaysia 2009). The Hanafis and Hanbalis allow the contract and the Malikis and Shafi'is regard the contract void (*ibid*). Thus AAOIFI permit a guarantee clause in contracts if a *sharik*, *mudharib* or a *wakil* behaves negligently or in violation of the terms of the contract (AAOIFI 2010: Standard 5: Article 1). Thus usage of *wa'ad* and any guarantee as discussed above in equity-based *sukuk* make a transaction similar to an interest based fixed income securities.

Use of purchase undertakings in *sukuk* is not impermissible in every case. For example in *ijarah*-based *sukuk*, a lessor can undertake to repurchase the underlying assets from the lessee where *sukuk* are dissolved or matured, for a price equivalent to outstanding rental payments. The outstanding rental payments represent the net value of the assets.

The effect of AAOIFI pronouncement was strongly felt in the *sukuk* market where purchase undertaking at par guarantees the principal in the equity-based *sukuk*. Islamic Finance Information Service (IFIS) database shows that equity based *sukuk* based on purchase undertaking guaranteeing the principal were in majority. But this number was declined significantly post-AAOIFI pronouncement.

Nakheel *Sukuk* is an example of asset-based *sukuk* while the East Cameron Gas *Sukuk* is an example of an asset-backed *sukuk* (IFIS *Sukuk* Database). On 31.03.2010, a USA court supported the asset-backed *sukuk* structure (IFIS *Sukuk* Database), which was the first decided case whereby it was held that the asset-backed structure can protect *sukuk* holders in the event of default.

The *shari'ah* board of the IDB *Sukuk* (2005) allowed the purchase undertaking and held that it acts as a guarantee of capital and return. They allowed this mechanism on the

grounds that the obligor (IDB) and the issuer were viewed as independent parties (IFIS *Sukuk Database*).

There have been alternative structures used in the market where a purchase undertaking is given by a third party. This is possible through the formation of two special-purpose vehicles. Like RM1.5billion *sukuk al-musharakah* issued by Seafield Capital Berhad in May 2009 for 20 years (RAM, *Sukuk Focus* 2010). This is given in the Figure 5.2 below.

Figure 5.2: Purchase Undertaking by A Third Party

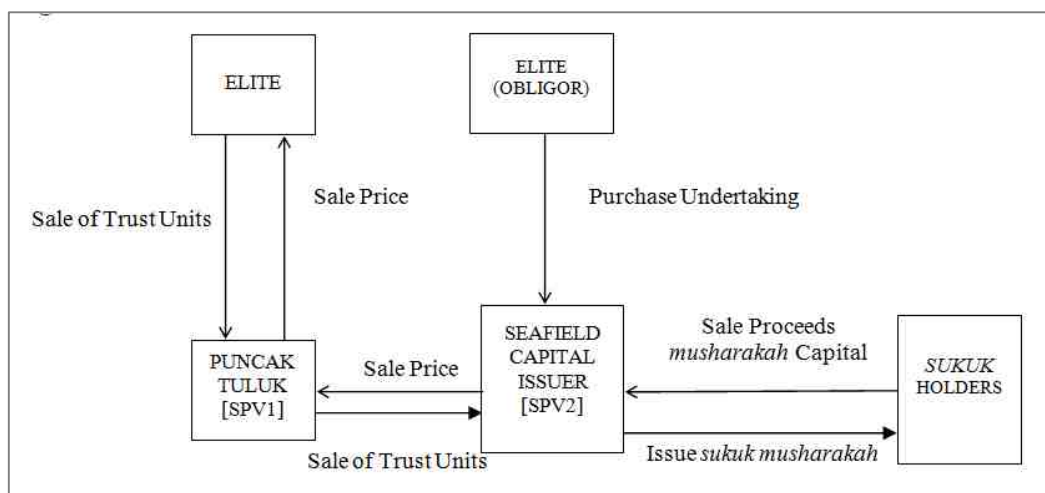

Source: RAM *Sukuk Focus*, 2010

There are two SPVs independent of purchase undertaking provider in the above *sukuk* structure. Elite is the provider of the purchase undertaking, which is a third-party guarantor and is independent of any party to the *sukuk* transaction namely *sukuk al-musharakah* (RAM, *Sukuk Focus* 2010). There is no link between Elite and the party to whom it has given guarantee because it sold the trust units to another party and gave guarantee to the other. This guarantee structure was in accordance with *Shari'ah* Standard 5 and 12 of the AAOIFI (AAOIFI 2010).

It is clearly understood that the purchase undertaking in an equity-based *sukuk* is to guarantee the principal to the *sukuk* holders without giving regard to the *sukuk* assets' value whether it increases or decreases. This guarantee of principal or return is against the spirit of equity financing. In reality *wa'ad* turns an equity-based *sukuk*, based on variable

returns, into a mode of financing based on fixed return. Any guaranteed fixed income amounts to *riba*, which is impermissible in the eyes of *shari'ah* but guaranteeing principal is a market practice and both approaches are opposite to each other. *Sukuk* holders prefer the guaranteed fixed income structures because the *sukuk* holders get their original capital even where there is a loss (Dusuki and Mokhtar 2010).

5.10 WA'AD AND DERIVATIVES

Derivatives are important in mitigating risks through the hedging mechanism. In derivatives, there are some *wa'ad*-related *fiqhi* issues mainly in three areas of FX forward transactions, TRS and SS transactions.

Derivatives in Islamic finance are not very common as they are in conventional finance (Bacha 1999; Kamali 1999; Elgari 2006; Alsayyed 2009; Dusuki 2009). Mohamad and Taatabaei (2008) state that *wa'ad* plays the role to “plug the hole” to abstain from the issues that stem from the use of forward contracts. But notwithstanding the use of *wa'ad* issues are still there such as non-existence of assets, lack of ownership and or possession, mutual deferment in performance and excessive uncertainty or speculation.⁵ Mutual deferment in performance results in definite certain results which turn a derivative contract into a beneficial debt-sale contract. They also cause enormous uncertainty or speculation that a transaction becomes a gambling transaction, which promotes zero-sum game (ibid).

Since derivatives are beneficial in abating various risks through the hedging mechanism, there are some *wa'ad*-related *fiqhi* issues which need to be addressed. *Wa'ad* can also replicate a call option but at the same time there involve some issues (Hasan 2007). A call option gives the buyer ‘right’ to buy by paying a ‘premium’ to the seller and the seller is obliged to sell by giving an ‘undertaking’ to the buyer. *Wa'ad* is a unilateral promise, which demands no consideration from the other side (ibid). Thus the use of *wa'ad* similar to a call option is only possible where it is made unilaterally without any consideration i.e., the party exercising ‘right’ should not pay any premium. Alternatively a *wa'ad* can

⁵ These issues have been discussed in detail in chapter 3.

be used by way of call option if there are two independent unilateral promises: a promise by the buyer to buy by offering a premium and a promise by the seller to sell (ibid 2007).

The *fiqhi* issues may be specifically discussed in FX forward transactions, TRS and SS transactions.

5.11 USE OF WA'AD IN FX OPTION

A *wa'ad* can be used in currency option (Kamali 1997; Obaidullah 1999; Smolarski et al.2006; and Al-amine 2008b). Option trading without any accompanying purchase or sale of underlying tangible assets may lead to speculative gain resulting in *gharar* hence it cannot be allowed (Al-Suwailem 2006).

Uberoi, Chatterji and Bidar (2009) have presented a structure of an option. In this structure, the client promises to the bank to buy or sell a fixed amount of a particular currency in consideration of another amount of a particular currency at a pre-determined rate on a pre-determined settlement date. The bank in turn acknowledges the client's promise and pays a non-refundable fee to the client for having right to exercise an option to enforce the client to fulfil his promise (*wa'ad*). The bank can either exercise the option based on client's *wa'ad* or serve a cancellation notice of the *wa'ad* (Uberoi et al. 2009).

Figure 5.3: Use of Wa'ad in FX Option

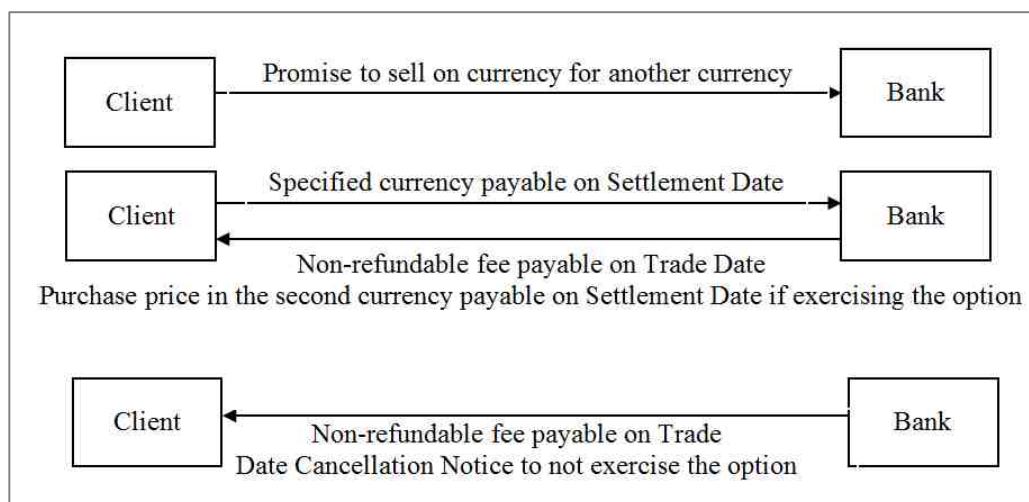

Source: Uberoi, Chatterji and Bidar, 2009: 3

In its seventh session OIC Fiqh Academy, did not allow these sorts of transactions neither for the purpose of speculation nor for hedging purposes (IDB 2000: Resolution No. 7/1/65). The OIC's Resolution was based on the unanimous ruling of the scholars on *sarf* (currency exchange) transactions that these must be on the spot without any deferment and currency exchange on a forward basis is contrary to this ruling (Al-Zuhayli 2003; Abu Ghuddah 2007). Therefore, instrument of *wa'ad* is devised wherein parties can 'agree' to sell currencies on one date while their delivery is agreed on another date. Each part to this currency transaction promises to sell or to buy on a unilateral promise basis and the agreement does not amount to a contract. AAOIFI has also approved this structure (AAOIFI 2010: Standard 1 and Appendix B of the Standard; Al-Zuhayli 2003). The OIC Fiqh Academy has imposed certain conditions so that unilateral promises can be used in line with the values of *shari'ah* (IDB 2000).

5.12 WA'AD IN TOTAL RETURN SWAPS (TRS) AND SHORT-SELLING

5.12.1 TOTAL RETURN SWAPS

Wa'ad can also be used in swaps (Al-Suwailem 2006 and 2007; Elgari 2008; and Hammad 2008). A double *wa'ad* structure gives economic advantages similar to a conventional total return swap (Uberoi et al. 2009). Swaps are arrangements between counterparties to exchange cash flows over time with a great degree of flexibility (Kapner and Marshall 1990; Dattatreya et al. 1994). Interest-rate swaps and currency swaps are prevailing in the market because of their usefulness in the management of balance sheets and risk profiles (Coyle 2000 and 2001).

Uberoi, Chatterji and Bidar (2009) and Dusuki (2009) have discussed a double *wa'ad* structure in which a SPV raises investment by issuing certificates and acquires a pool of *shari'ah* compliant assets by way of a *shari'ah*-compliant contract such as *salam* or *murabahah* (Dar 2005). In order to enhance the return, the bank arranges to swap the returns from the *shari'ah*-compliant transaction with returns from another investment by way of a *wa'ad* (ibid). The counterparties undertake by way of *wa'ad* to swap their returns either at maturity or at the end of a certain period of time (ibid). Uberoi, Chatterji and Bidar (2009) argue that this swap of investment between the issuer and the bank is

based on two mutual promises (*wa'ads*). In first (*wa'ad*) the issuer undertakes to sell *shari'ah* compliant assets to the bank at a certain price. This price is dependent on the performance of the other investment and is known as *wa'ad* sale price. The second *wa'ad* is made by the bank wherein it promises with the issuer to buy the *shari'ah* compliant assets from him at the *wa'ad* sale price. Out of the two *wa'ads*, only one is executed. They argue that if the *wa'ad* sale price is greater than the return from the other investment, the issuer will enforce the second *wa'ad*, which is similar to a conventional put option. However, if the *wa'ad* sale price is less than the return from the other investment, the bank will enforce the first *wa'ad*, which is similar to a conventional call option (Uberoi et al. 2009).

Figure 5.4: Swap Structure Using Double Wa'ad

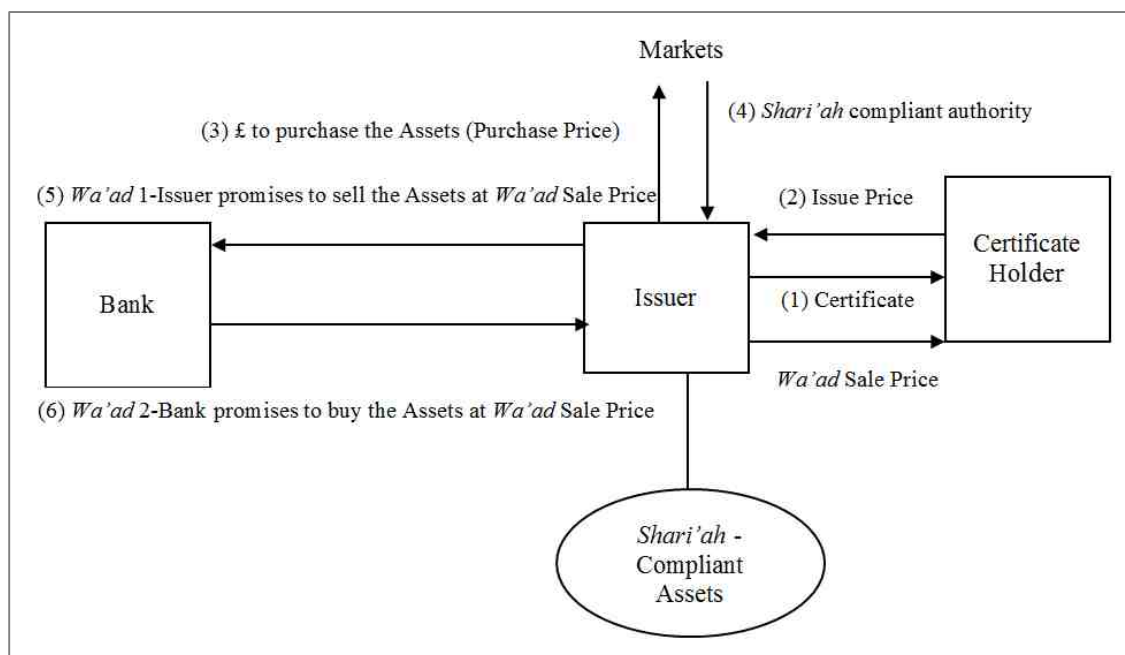

Source: Uberoi, Chanerji and Bidar, 2009:5

From the Islamic investor's perspective, the investment is used to purchase *shari'ah*-compliant commodities by way of a *shari'ah*-compliant contract such as *salam* or *murabahah* (Dar 2005). Delorenzo (2007) regards it a perplexed situation in which the returns come out of *shari'ah* compliant contracts. According to him the situation gets problematic where the returns from the other investment (which is not *shari'ah*

compliant) is exchanged by means of the artifice of a *wa'ad* and the bank considers those returns as compliant even if the investment is non-compliant itself (ibid). The double *wa'ad* structure provides the result similar to hedge funds for Islamic investors. In fact Muslim investors invest in *shari'ah* compliant investments and their return is swapped with the returns from non-compliant investments, by using a *wa'ad* structure. Thus hedge funds, cross-currency swaps, exotic products, gambling stocks, liquor and all prohibited investments may be delivered to *shari'ah* compliant investors by the employment of a double *wa'ad* structure. This structure provides the *shari'ah* compliant Muslim investors compliant returns while receiving financial and gaming speculative exposures (Dar 2007).

Delorenzo (2007) and Firoozye (2009) disapprove the double *wa'ad* structure because the yields under such structures are determined by the performance of non-*shari'ah* compliant funds which may invest in *haram* assets or securities. Thus, though an Islamic investor invests directly in a *shari'ah* compliant investment but the double *wa'ad* structure profits him from the *haram* assets or securities indirectly. The promise to exchange for the *haram* returns establishes a direct link between the *haram* assets or securities and the investor. For example the cash-flows in a total return swap based on *wa'ad* structure indicate that the investment by an Islamic investor operates as a trigger for a series of transactions which are not necessarily *shari'ah*-compliant (DeLorenzo 2007).

The performance of non-compliant assets actually is employed in order to determine the price and the promised exchange is only for the value of returns which is determined through the performance of such non-compliant assets (Deutsche Bank n.d.). The mechanism is similar to the mechanism where LIBOR, an interest benchmark rate, is used to establish the price for a *murabahah* or an *ijarah*.

According to Delorenzo (2007) analogy cannot be drawn between the use of LIBOR for pricing and the use of the performance of non-*shari'ah*-compliant assets for pricing because the former is an indication of return and the latter is the provision of actual return.

The use of *wa'ad* on the line of the conventional total return swap structure is not very much laudable and it is regarded as inappropriate both in form and substance. The structure is neither in line with the *shari'ah* nor with the objectives of *shari'ah*. Though there are some economic benefits of both the structures but any innovation should not come at the expense of authenticity.

5.12.2 SHORT-SELLING

SS has already been defined in chapter 3 which is the sale of a security not owned by the investor at the time of contract (Fabozzi et al. 2002). In *shari'ah*, acquiring ownership of an object is necessary for its onward sale by the seller. As a consequence he bears the risk in the object of sale. Uberoi, Chatterji and bidar (2009) state that in order to replicate the economics of a conventional short-sale in a *shari'ah*-compliant structure the seller has to actually own the securities which form the basis of the transaction. Therefore, two double *wa'ads* are used in SS structure in combination with a *murabahah* (ibid). This replicates the cash-flows under the conventional SS structure and generates a similar economic profile (ibid). The structure is as follows which can be seen explicitly from the figure 5.5 below:

Figure 5.5: Use of Two Double Wa'ad in Combination with Murabahah Replicating Conventional Short-Selling

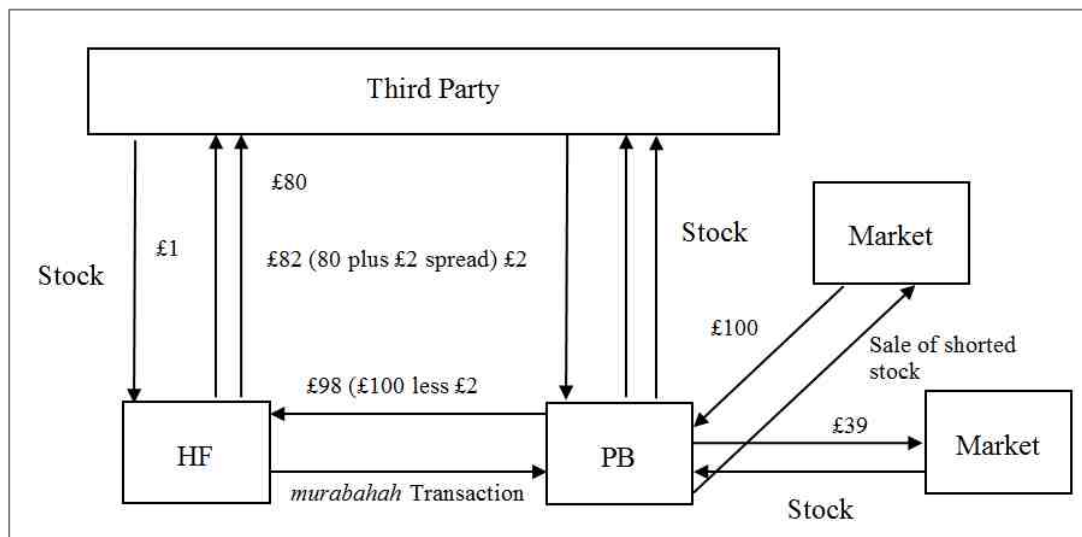

Source: Uberoi, Chanerji and Bidar, 2009: 6

A Prime Broker (PB) purchases the stock from an Islamic Hedge Fund (HF) through a *murabahah* for a particular *murabahah* sale price of £100 for instance payable on a deferred basis at a future date. PB then on-sells the stock in the market for the prevailing spot price of £100 for instance, thereby generating a certain cash reserve. Simultaneously, a Third Party (TP) enters into two double *wa'ad*, one with PB, whereby PB unilaterally promises to sell and TP unilaterally promises to buy the stock for a pre-specified price of £82 for instance (Double *Wa'ad* 1). The other double *wa'ad* is with HF, whereby HF unilaterally promises to buy and TP unilaterally promises to sell the stock for a pre-specified price of £80 for instance (Double *Wa'ad* 2). TP is paid a fee (DW1 Fee) by PB of £2 for instance for entering into Double *Wa'ad* 1 and a fee (DW2 Fee) by HF of £1 for instance for entering into Double *Wa'ad* 2 (Uberoi et al. 2009).

Assuming that the stock price falls to £80 at any subsequent date, PB uses its cash reserves to buy shares from the market at the spot price of £80 and triggers Double *Wa'ad* 1 with TP, whereby PB on-sells the stock to TP for £82 (£80 plus PB's £2 spread). HF then triggers Double *Wa'ad* 2 with TP, whereby HF purchases the stock for £80 from TP. Under the terms of the *murabahah* transaction between HF and PB, PB pays HF £98 (£100 minus PB's spread of £2) (ibid).

Commentators have criticised the use of *wa'ad* in SS and regard it inappropriate because the structure involves two sets of double *wa'ad* to swap the return from the *shari'ah* compliant basket of assets for returns from a non-*shari'ah* compliant basket of assets. (Firoozy 2009). In addition, there is another issue of the involvement of *riba*. In SS the lender of stock stipulates a gain, without a counter value, in return for lending the stocks and this amounts to *riba*.

Lastly, in both TRS and SS, the use of two unilateral *wa'ads*, one promisor unilaterally promises upon the understanding that the other party will also unilaterally give a similar undertaking. This is an accepted *shari'ah* principle that two transactions cannot be combined together which means that the entering into one is made a precondition for the other. This removes the criteria of an independent promise, therefore, this usage of *wa'ad* is not suitable, too.

5.13 SUMMARY AND CONCLUSION

In this chapter it was attempted to peruse through original sources of both *shari'ah* and English common law on the application of *wa'ad* particularly in the context of *sukuk* and derivatives. The research endeavoured to illustrate the essentiality and amplitude of the concept of *wa'ad* in both classical and contemporary Islamic jurisprudence with general implications in the context of *sukuk* and derivatives. In addition, the research explored the issue of enforceability of *wa'ad* in English common law jurisdiction with reference to equivalent legal concepts of promise and promissory estoppels in light of relevant case law. The overall aim was to ascertain the correct *shari'ah* position for validity purposes and the precise legal standpoint for enforceability purposes in the application of the tool.

Although *wa'ad* and promise can be rendered in a manner which is compliant from the perspective of English common law and *shair'ah* law, the overriding objective of the *shari'ah* principles particularly proved to be lacking especially in the context of equity-based *sukuk* (by referring to some key case studies) and in the usage of double *wa'ad* in derivatives. Hence the law is not necessarily the only solution but there is a need for an 'inter-disciplinary' or 'socio-legal' solution by utilising the law in context method, which can be based on the wider objectives of Islamic macroeconomics.

It is clear from the research that *wa'ad* falls into the category of *tabarru'at* (voluntary offers) whereas *'aqd* comes within the ambit of *mu'awadat* (commutative contracts). Given that one category is not a substitute for another, *wa'ad* should not be used in place of *'aqd* in a manner that changes the legal effect of *wa'ad* to that of an *'aqd* so much so that in substance there is no difference. However, the advocates of both sides argue differently. The proponents of the currently-practised, legally binding *wa'ad* argue in favour of form over substance while the opponents contend that substance over form is key.

The research considered various juristic opinions regarding the binding nature of *wa'ad* and found that there are three prevailing views. Fulfilling *wa'ad* is *mustahab* only but not *wajib*; fulfilling *wa'ad* is always *wajib*; and fulfilling *wa'ad* in certain situations is *wajib* with provisions and exceptions. All of these positions have their own set of evidences but

the latter one appears to be adopted by a number of contemporary *shari'ah* rulings of various bodies of scholars.

As for the English common law stance on *wa'ad*, it was important to consider the alternative legal concepts of promise and promissory estoppel. However these concepts are best understood in the context of legal and equitable principles of contract and equity. On the basis of the legal principles and case law regarding promise, it can be concluded that while *wa'ad* would not be enforceable in its pure and simple form under English contract law, it may be justifiable if either forbearance is established or it is executed by way of a deed poll or alternatively it forms part of a tortious legal action.

In addition, *wa'ad* seemed to mirror the English equitable doctrine of promissory estoppel on two grounds. Firstly, there is a unilateral promise requirement in both. Secondly, the promise can seek compensations for any failure on the part of the promise. However, the distinction of promissory estoppel is that it can only be used as part of a defence and not as a separate legal action. This means that no independent claims for compensation can be filed by the promise which neutralises the efficiency of *wa'ad* as a structuring tool in *shari'ah* compliant transactions.

With reference to relevant case law, it is submitted that *wa'ad* has some resemblance with promise and promissory estoppel. However, on the whole, in order for it to be legally enforceable as such it must be executed under a deed poll, which by legal convention does not require any consideration but still has the effect similar to a legally binding contract or the element of forbearance needs to be proven or it should form part of a tortious legal action. However, would a deed poll have certain *shari'ah* implications? Would that turn the *wa'ad* into an '*aqd al-mu'awadhah*? This issue could be the subject of further research in this area.

Following the *fiqhi* and legal discussion above concerning *wa'ad*, it is clear that any arguments against the extreme usage of *wa'ad* are not per se but rather to avoid any *shari'ah* contraventions that are prevalent in the industry. Whilst innovation is laudable, it should not come at the expense of authenticity.

On the whole, the function of *wa'ad* in an equity-based *sukuk* has proven to be one of guarantee whereby the principal is assured regardless of any variations in market value of the assets in question. Such a guarantee goes against the very nature of equity financing as the *sukuk*-holders are not liable vis-à-vis the principal amount, which is against the consensus of classical jurists. In essence this inappropriate usage of *wa'ad* defaces the equity-based *sukuk* from variable return to fixed return mode of financing. The conclusion can rightly be drawn that if *wa'ad* is used inappropriately in this manner, then no return is permissible on the principal amount since the guarantee would turn the transaction into an interest-base loan and any proceeds on investment would amount to *riba*.

As for derivatives, *wa'ad*-related issues are prevalent in mainly in three areas, namely FX forward transactions, TRS and SS transactions. A binding promise from only one party (*wa'ad mulzim min taraf wahid*) is not deemed as a contract and as such this mechanism can facilitate forward foreign exchange. This point was endorsed by AAOIFI *Shari'ah* Standards. The OIC Fiqh Academy has rendered unilateral promises in commercial dealings binding with certain conditions. Therefore, provided the conditions are adhered to, usage of *wa'ad* will be regarded as appropriate in FX forward transactions.

In the structure of TRS one set of double *wa'ad* is used whereas in the SS structure two sets of double *wa'ad* are being used. It is conceded that both structures have some potential economic benefits but there are some glaring flaws which compromise the authenticity of the products. Besides the few scholars who approved the TRS structure, the majority of the scholars have not entertained it, hence no views recorded at any of the *shari'ah* scholar platforms such as OIC Fiqh Academy and AAOIFI. The main crux of the criticism is that the double-*wa'ad* structure in TRS potentially allows the return from the *shari'ah*-compliant basket of assets to be swapped for returns from a non-*shari'ah*-compliant basket of assets which the proponents have accepted as permissible.

As for the SS structure, ownership is a condition of sale which is problematic. The structure adopted is through the inappropriate usage of two double *wa'ad* which is done in combination with a *murabahah* to replicate the cash-flows under the conventional SS

in order to generate a similar economic profile. Since SS is inherently problematic, even if the usage of *wa'ad* is accepted temporarily, there is another perpetual problem which is difficult to overcome, namely the involvement of *riba*. It is well known that in the application of SS the lender of stock stipulates a gain, without a counter value, in return for lending the stocks, which is nothing but *riba*.

In addition, even from the point of view, the two so-called unilateral *wa'ad* actually function as a bilateral *wa'ad* in both TRS and SS structures which is clearly not acceptable. It is one of the principles of the *shari'ah* that two transactions cannot be tied together in the sense that entering into one is made a precondition for the other. Thus, both parties are in essence signing their respective undertakings with the understanding that there is a similar undertaking from the other side. This removes the criteria of an independent promise.

This research has highlighted the importance of ensuring total compliance with both the letter and spirit of *shari'ah* law. In the alternative, there would be no justification for having an Islamic paradigm, critics would argue that it is merely nomenclature and semantics when it comes to the elaborate usage of *wa'ad* in both equity-based *sukuk* and derivatives, while there are deep *fiqhi* and contractual repercussions as well as potential litigation that cannot be overlooked. Our assessment is that not all *wa'ad*-based products will be entertained in an English court based on the doctrines of consideration and promissory estoppel.

CHAPTER 6

A CRITICAL ANALYSIS OF THE UK REGULATORY STRATEGY TOWARDS *SUKUK* ISSUANCE: LEGAL, REGULATIVE AND FINANCIAL ISSUES

6.1 INTRODUCTION

Middle East countries in the past were engaged in businesses and trade in accordance with the teachings of *shari'ah* and still in the modern era this *shari'ah* compliant finance gained popularity in GCC countries and in the Asia especially in Malaysia. In the West, UK is the leader in taping Muslim investors by offering Islamic financial services and by incorporating laws facilitating Muslim investors such as facilitating in issuing and listing of *sukuk*. It should be noted that the recent developments and trends demonstrate that corporations and governments are alike are raising demand for *sukuk* for financing their needs.

Among OECD member countries, the UK has taken the lead to become the first country by coming up with tax laws for; alternative finance; and strengthen its strategic position in Islamic finance. There are about two million Muslims living in UK, which shows the desire of UK to introduce legislation for Islamic finance in order to fulfil the financing needs of its Muslim population. The UK governments have taken this lead despite the fact its Muslim population is lesser in number than its competing economic rival among European countries, *e.g.* Germany with 4.5 million and France with 3.5 million Muslims but are far behind the UK. The UK strategy has also been related to develop national interest for financial development and economic growth through facilitating Islamic finance services in the UK (Davies 2002). Consequently, the UK is now known as one of the centres for Islamic finance and is the leading centre in the West. As part of this process, London Stock Exchange (LSE) has acquired the status to be the main exchange for listing international *sukuk*, and the UK court remains the main institutions for dispute resolution.

After identifying, explaining and measuring the potential of the UK to become an Islamic financial hub, this chapter explains the phases in the development of regulatory regime for the issuance of *sukuk* in the UK and its effects on the securitisation process of *sukuk*. This chapter will also provide a critical analysis on the consultation documents and any subsequent finding of the FSA (FSA 2007), HM Treasury (2007) through the Debt Management Office (DMO), HM Revenue & Customs (2008) for sovereign and corporate *sukuk*. In addition issues will be brought to the spotlight such as legal and *shari'ah* issues and their conflict with each other. Any mismatch with the regulatory regime in the course of issuance of Islamic financial instruments will also be explored.

6.2 EMERGENCE OF THE UK AS AN ISLAMIC FINANCIAL CENTRE

As mentioned above, the UK has been an important centre for Islamic finance since later 1980s. However, London has always been a centre for GCC financial activity for many decades. Since 1997, the governments in response to the growing global Islamic finance have provided the necessary legal, regulative and financial arrangements for Islamic finance in the UK. Since the UK offers a good platform for private placement in general, as explained in Figure 6.1, this has been an important facilitator for Islamic finance developments in the UK.

Figure 6.1: UK Offers a Good Platform for Private Placement

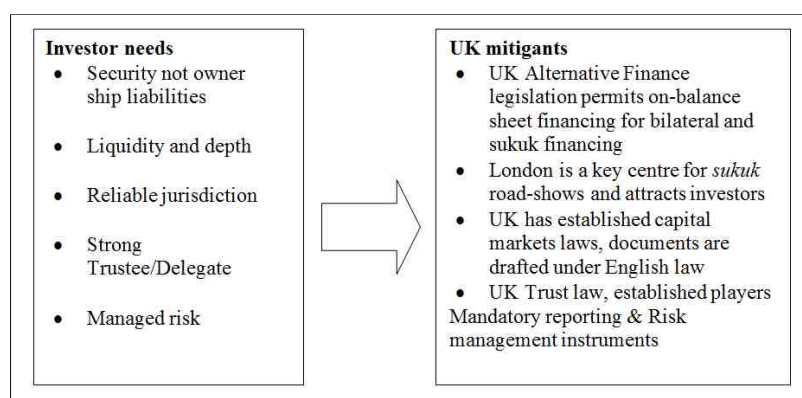

Source: Bank of London and the Middle East, 2012

In the UK due to its investor friendly environment and policy, Islamic finance expanded rapidly, and a range of Islamic financial products were introduced by various IFIs by taking lead in European financial markets, which, as a result, has the

largest number of Islamic finance institutions operating in any western country. To date the FSA has authorised five full-fledged Islamic banks, one *shari'ah*-compliant hedge fund manager, one dedicated *takaful* and there are over 20 conventional banks providing Islamic financial services through Islamic 'windows'. These are detailed in Table 6.1.

Table 6.1: Islamic Banks in UK

| Fully Shari'ah compliant | Islamic windows |
|------------------------------------|--------------------------|
| Bank of London and The Middle East | Ahli United Bank |
| European Islamic Investment Bank | al-Buraq |
| Gatehouse Bank | Bank of Ireland |
| Islamic Bank of Britain | Barclays |
| QIB UK | BNP Paribas |
| | Bristol & West |
| | Citi Group |
| | Deutsche Bank |
| | Europe Arab Bank |
| | HSBC Amanah |
| | IBJ International London |
| | J Aron & Co. |
| | Lloyds Banking Group |
| | Royal Bank of Scotland |
| | Standard Chartered |
| | UBS |
| | United National Bank |

Source: LSE (2012)

Table 6.2. depicts the asset base of the UK Islamic banks as of 31st December 2010. Over the years, the UK Islamic banks have shown gradual development.

Table 6.2: Islamic Banks in the UK as of 31st Dec. 2010

| £m | Equity | Total Asset |
|-------------------|--------------|--------------|
| Gatehouse Bank | 19.5 | 31.5 |
| QIB (UK) | 17.0 | 60.1 |
| BLME | 249.3 | 706.5 |
| EIIB ⁶ | 143.1 | 181.5 |
| IBOB | 26.2 | 218.2 |

Source: The Banker (2010)

The developments in the UK evidence that the LSE has been recognised as encouraging innovation that has led to its depth and breadth in Islamic financial development (Wilson 2007). On its way to become an Islamic financial market leader, it has to counter and compromise to various challenges. This research will therefore analyse its capability in terms of infrastructure whether or not it has the capacity to become a leader in Islamic finance as per UK government's desire for which the *sukuk* issuance play an important place. Towards this end LSE's process and procedure will also be analysed. A detailed analysis of the LSE's strategic positioning in terms of listed *sukuk*, private placed *sukuk*, and syndicated/club facility is presented in Figure 6.2, which shows the advantages and disadvantages of the LSE in these three categories of *sukuk* related activity.

⁶ European Investment Islamic Bank.

Figure 6.2: LSE's Strategic Positioning for Sukuk

| | <u>Advantage</u> | <u>Disadvantage</u> |
|-----------------------------|---|---|
| Listed <i>sukuk</i> | <ul style="list-style-type: none"> • Offers Liquidity/ tradability • Price benchmark • Attracts new investors | <ul style="list-style-type: none"> • Difficult sell in absence of rating, or market track record • No flexibility |
| Private Placed <i>sukuk</i> | <ul style="list-style-type: none"> • No listing / managed distribution • Better for negotiating covenants • Fits with segregated / off balance sheet asset structure | <ul style="list-style-type: none"> • Smaller market: US\$50 m to US\$60m • Still requires the <i>sukuk</i> trust arrangements • Best efforts |
| Syndicated Club Facility | <ul style="list-style-type: none"> • As private placement • Simplified structure and security package • Minimum hold from MLAs | <ul style="list-style-type: none"> • Less liquid than <i>sukuk</i> • Tighter control over security |

Source: Bank of London and the Middle East, 2012

6.3 THE PRESENT POSITION OF LSE

The UK has potential to become pioneer in Islamic finance and to establish itself as its primary global gateway which it can achieve through LSE (FSA 2007). Towards this end the *sukuk* have significant role to play which is evident from the FSA's references to *sukuk* in the document Regulations and Challenges (FSA 2007), as *sukuk* has emerged as a major asset class (Zin et al. 2011). The fact that *sukuk* is causing the LSE to emerge a market leader in Islamic finance over its competitors, demands for a complete investigative study, which is presented in this chapter. In order to devise various *sukuk* structures, the prevailing regulatory regime of FSA has to incorporate various *shari'ah* requirements (Iqbal and Khan 2005).

One of the main steps taken by the UK governments has been undertaking regulatory reviews to accommodate Islamic Financial instruments (FSA 2007). There has been public consultation by the UK DMO of HM Treasury department on the issuance of sterling sovereign *sukuk* (GB HM Treasury 2007), either in 'bond-like' form (having a maturity of greater than one year) or 'bill-like' form (a maturity of less than one year). The reason for this was to minimise the differences between *sukuk* issuance and bonds and bills. As a result of consultations, it was decided to initially issue a Bill-like *sukuk* (GB HM Treasury 2008). In the consultation public view was sought on structure, taxation, regulatory, listing, registration and liquidity management (Macfarlane 2011). However, HM Treasury postponed its first sovereign *sukuk*

issuance, mainly due to the impact of the financial crisis and change in the political will (GB HM Treasury 2007). It should be noted that France was about to take the lead in issuing first of its sovereign *sukuk* in 2011, and to establish Paris as world's Islamic financial hub but owing to Eurozone crisis it has to postpone it.

Sukuk are new to the UK, and therefore the country need special legal and regulatory environment. To develop such a favourable regulatory regime, a deep and through research is insisted. For that there is need to develop expertise for getting conversant with the principles of Islamic finance, its goals and objectives (GB HM Treasury 2007).

National Savings and Investment is intended to conduct a search to explore the future prospects of retail Islamic finance products which is a continuation of an already undertaken research on pertaining to the problems and issues of retail Islamic finance products (GB HM Treasury 2008). These efforts may contribute to the progress of corporate *sukuk* with a more developed secondary market in the UK (Wilson 2008).

Global financial regulators and financial markets' regulations and guidelines are reference for FSA and LSE for *sukuk* regulations. These include conventional institutions such as the IMF, IOSCO (2004), United Nations and World Bank (Iqbal and Tsubota 2006) and these also include the Islamic regulatory institutions, such as the IFSB (2009), IIRA, Ratings Agency Malaysia (RAM), Islamic Research and Training Institute, AAOIFI and various other institutions. Instances may include the Basel II Accord's influence on capital adequacy ratios (IFSB 2009) with reference to *sukuk* is the area which need further exploration and work by IFIs (IFSB 2005) which would have not been omitted (Ayub 2005). Basel III is the next in line where IFIs should work on, and therefore Wilson (2007) considers this are to be worked carefully because the applicability of Basel II accords for *sukuk* indicates mismatch.

In order to provide an understanding as to the potential capacity of *sukuk*, it should be noted that just over USD26.65 billion has been raised through 46 *sukuk* issues on the LSE, more than any other global exchange. GE Capital Sukuk was the first *sukuk* to be issued by a major USA corporate issuer in November 2009. In addition, Central Bank of Bahrain was the first sovereign *sukuk* listed in London in March 2008. Furthermore, Alder Funding issued first *sukuk* worth USD2.53 billion, on the

Professional Securities Market (PSM) in March 2007 (LSE website). Attractiveness of UK market for Islamic finance products is shown through tables and figures below.

Table 6.3. provides total *sukuk* listing at the LSE since 2006; while the impact of global financial crisis can be seen immediately with sharp decline in 2008.

Table 6.3: Sukuk Listing at LSE

| Year | Amount \$ bn | Number of issues |
|---------|--------------|------------------|
| 2006 | 1.19 | 3 |
| 2007 | 9.77 | 13 |
| 2008 | 1.73 | 3 |
| 2009 | 3.94 | 6 |
| 2010 | 1.77 | 5 |
| 2011 Q1 | 0.50 | 1 |

Source: LSE (website)

Attractiveness of UK for *sukuk* is evidenced through Appendix, which demonstrates a List of Live Instruments at the LSE. It shows LSE's strong position for *sukuk* market. Though there was a decline in 2008, growth was regained in the later years. Table 6.4. shows the Expired and Cancelled Instruments in the LSE. The Table shows market positioning of LSE.

Table 6.4: Expired and Cancelled Instruments

| Instrument Name | Money Raised £(million) |
|--|-------------------------|
| Adib <i>sukuk</i> Co Ltd Trust Certs 12/12/11 Usd100000 | 417.72 |
| Aldar Funding Ltd Trust Cert 10/11/2011 Usd100000 | 1295.68 |
| SIB <i>sukuk</i> Co Trust Certs 12/10/2011 Usd100000 | 118.62 |
| Tabreed 06 Financing Corp Trust Certs 20/7/2011 Usd100000 | 109.38 |
| Tabreed Financing Corp Trust Certs 19/05/11 Aed500000 | 235.11 |
| Rakia <i>sukuk</i> Co Ltd Trust Certs 05/12/2012 Usd100000 | 158.06 |
| DIB <i>sukuk</i> Company Limited Trust Certs 22/03/12 \$ | 384.09 |
| EIB <i>sukuk</i> Company Ltd Trust Certs 12/06/12 | 176.33 |
| URC <i>sukuk</i> Limited TST Certs 13/06/12 \$ | 50.38 |

Source: LSE (website)

Figure 6.3 gives a picture of Islamic banks and their *shari'ah* compliant operations in the UK.

Figure 6.3: Shari'ah Banks in the UK Market

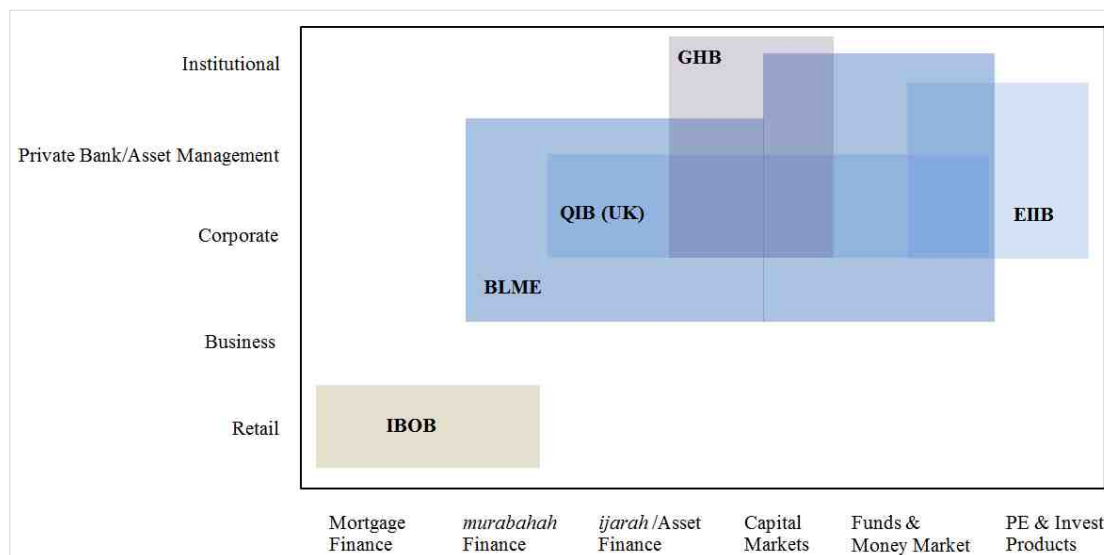

Source: Bank of London and the Middle East, 2012

6.4 SUKUK AND THE AREAS OF CONCERN IN THE UK REGULATORY FRAMEWORK

Three main areas of concern have been pointed by the FSA (2007) where it may have regulatory problems pertaining to *sukuk* and similar Islamic financial instruments, which are (a) *sukuk's* regulatory definitions; (b) the role of *shari'ah* scholars; and (c) financial promotions. The first two areas are relevant to present discussion and will be dealt with in the later section of this thesis. The discussion will critically explore the differences if any on these areas and it will further explore the consequences of these controversies. A detailed analyses of legal, regulatory and *shari'ah* issues such as international regulation aspects, uncertainties relating to legal aspects, taxation issues, conflict of laws and enforcement of decision issues will be presented. As far as financial promotion is concerned, it relates to the fair advertising practices without any deception with the aim to protect consumers.

6.4.1 SUKUK'S REGULATORY DEFINITIONS

In order to regulate *sukuk* instruments, it is important to define exactly their nature and characteristics, which may only be possible if their legal structure is understood. After the analysis of *sukuk* on the above lines, there could be three possible *sukuk* categories in the UK and these could be (a) a debt category under the Regulated Activities Order (RAO); (b) a CIS; and (c) an asset-backed instrument. Secondary markets have different listing requirements depending on the type of instruments. Therefore, it is important to determine the exact nature of *sukuk* in the UK context. The consultation paper of HM Revenue & Customs (2008) regards *sukuk* as a debt instrument. However, the FSA has not formally concluded the exact category of *sukuk*, but technically *sukuk* could be categorised as CIS.

Owing to *sukuk*'s unique features, regulators consider them instead of debt instruments as CIS. This brings *sukuk* under a completely separate regulatory regime than a regulatory regime, which regulate debt instruments. This classification of *sukuk* into a different regulatory setup is claimed to be inconsistent with the underlying economic rationale of these instruments and the need to be onerous regulatory requirements for such instruments (Ravalia 2008). As it is understood from the structure of *sukuk*, their performance depends on the performance of an underlying asset, which will cause the United Kingdom Listing Authority (UKLA) to consider these instruments as an 'asset-backed security' with the burden of more extensive regulatory disclosures. In summary, the *sukuk*, in the UK context, may be defined as a financial instrument structured upon a *shari'ah* compliant underlying assets generating *shari'ah* acceptable income, which is later distributed to its holder. The regulatory definition of *sukuk* in the UK, thus, can be summarised as in Figure 6.4.

Figure 6.4: A Basic Sukuk Structure

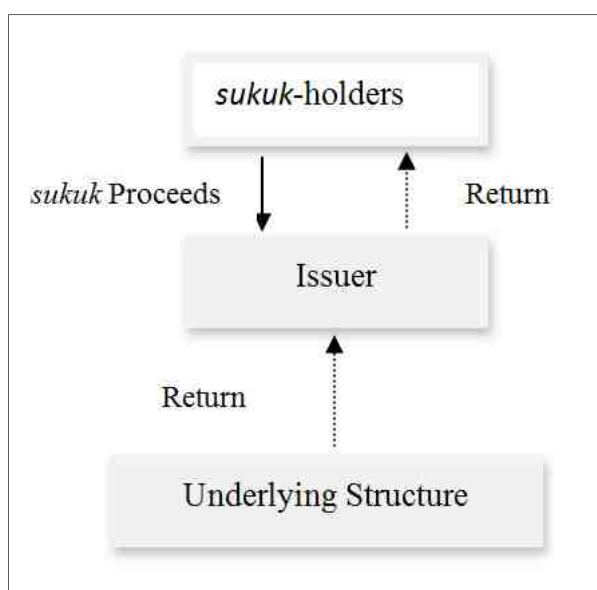

Source: Author's own

Sukuk have not any single recognised definition, but it is understood that these are *shari'ah* compliant instruments and any feature unacceptable to *shari'ah* will make them unacceptable. This is due to their structural patterns which make them difficult to define in order to bring them under regulations. Some *sukuk* have debt like and some have equity like features which are determined on case to case basis. Though in economic terms *sukuk* are similar to conventional bonds but *sukuk* have totally different underlying structures. A certain category of *sukuk* may have a totally different legal structures, contract terms and risks from other *sukuk* categories. Therefore, a single overarching regulatory definition for all types of *sukuk* is not possible but these instruments have to be examined on a case-by-case basis.

Ravalia (2008) provides a practical definition of a debt instrument, according to which any instrument that does not contain an arrangement such as a 'purchase undertaking' or similar arrangement that retains an enforceable right for the *sukuk* holder to claim money due from the *sukuk* issuer or originator, does not amount to a debt-like instrument. The purchase undertaking (or similar arrangement) he proposes, could act as the dividing line. This type of approach is consistent with focusing on the underlying 'economic substance' rather than the 'legal form' of the instrument. However, this would probably mean that true *ijarah sukuk* issuances that should be asset-backed will not fall within this arrangement as debt instruments as purchase

undertakings would not be relevant as returns are based on underlying asset performance.

Currently all *sukuk* listed in the UK are treated as guaranteed debt (Miller 2008). If the performance of the *sukuk* is directly related to the performance of the underlying asset then the UKLA will treat the Listing as an ‘asset-backed security’ and the application would be subject to more onerous disclosure requirements (Miller 2008). There are additional tax implications as ownership of assets being transferred under an *ijarah sukuk* for example is likely to incur Stamp Duty (Schoon 2009a).

In order to come across a certain definition of *sukuk*, Ravalia (2008) and FSA (2007) stress to consider the economic substance over the legal form of a *sukuk*. This may however require changes to the existing legal structure. *Sukuk* may not have the same definition as that of its equivalent products under the RAO. This may result in two consequences: (i) an applicant must have known that which regulated activity they are going to undertake and apply for the exact permission under RAO and certain Islamic products may not be covered by these regulated activities; and (ii) the regulatory definition determines the framework in which products can be sold. If a product falls outside the FSA’s regulatory framework, there may be restrictions on to whom the product can be sold to. Therefore a regulatory definition for the purposes of certainty is requisite.

Though FSMA has classified *sukuk* as CIS, but is silent on their classification for listing and prospectus regulation purposes. *Sukuk* at present since its inception have been treated as debt instrument and their treatment as ‘asset-backed’ instrument is viewed as problematic. Considering *sukuk* as asset-backed instrument may take the security away for investors who get guaranteed periodic payments along with the principal amount in the case of asset-based structures. The FSA may not consider it as a collective investment scheme for listing and prospectus purposes, because of *sukuk* are issued for a single project rather than various investment opportunities.

In order to understand the UK case, other country examples can help with this. For example, Dubai Financial Services Authority treats *sukuk* as debt instrument as they exclude *sukuk* from the Collective Investment Rules. Thus, a concise definition of

sukuk has not yet been provided by the Dubai authorities, which may cover all types of *sukuk* structures.

McMillen (2006) considers that *sukuk* having same results as that of debt like instruments do not bring any financial innovation except different innovative legal structures. However, in a separate research it was held that *sukuk*, despite their being asset-based, have distinct features than conventional bonds and provide additional risk protection to portfolio diversification. The research was based on an empirical analysis of the value at risk (Cakir and Raei 2007).

6.4.2 SHARI'AH COMPLIANT REGULATIONS IN UK

For the growth of Islamic finance in a western jurisdiction or non-Islamic jurisdiction, it is required that regulations must be drafted in such a way that these should not come in the way of *shari'ah* compliance. A number of *sukuk* issuances in their offering documents go for English law as the governing law and well established English Courts to adjudicate upon the matters of dispute. The FSA (2007:13, 16), and UK Treasury (amongst many others) so far are impartial in the debate on *shari'ah* compliance of products and avoid to take any particular position.

For any Islamic product to get approval in order to get launched may have four different strategies. The first is the approval of the product from in-house SSB. The second is through a regulatory *shari'ah* authority. The third is the use of an independent board of scholars. The fourth approach could be the seeking of guidance or assistance from an international standard setting organisation such as AAOIFI or IFSB. A response to the Treasury document (2008) suggests for the appointment of *shari'ah* scholars by the government in any board formed for the approval of a *sukuk* issuance. Malaysia has a central SSB, which is appointed by the government, while Dubai has rules on the appointment, governance and role of SSBs.

The UK regulation stipulated that exact powers and limitations of a SSB should be stated to the FSA (FSA 2007:13). AAOIFI in its ruling prescribes for a more operational involvement of a board in IFIs (AAOIFI 2008) clearly call for a more operational involvement on part of these boards. This potential conflict requires to be managed.

The key point from the FSA's perspective is that IFIs have to show that the role and responsibilities of their SSB are advisory and it does not interfere in the management of the firm. The FSA does need to know, exactly what the role of the SSB is in each authorised firm. It is interested in identifying whether and if so how the SSB affects the running of the firm. The FSA has to be clear as to whether the *shari'ah* scholars have an executive role or one that is simply advisory (FSA 2007). If, *shari'ah* scholars are seen to have a directorship role, it is possible that some of them may not meet the competency and capability requirements nor have relevant experience. This matters for two reasons. First, in the UK, any person acting as a Director of an authorised firm must be registered under the FSA Approved Persons rules. To assess the suitability of a person, the FSA has a standard known as the 'Fit and Proper test for Approved Persons'. Second, their role is more likely to resemble that of an Executive Director than a non-Executive Director as it might involve active participation in the firm's business. In such cases, it would be very difficult to justify multiple memberships of SSBs of different firms because of significant conflicts of interests. Therefore, SSB's should be of advisory nature in order to avoid any conflict of interests.

6.5 UK LEGAL BACKGROUND TO SUKUK

We may elaborate UK legislative development in introducing Islamic finance in UK in an attempt to understand that legal background for *sukuk* in the UK, which is summarised in Table 6.5:

Table 6.5: UK Legislation Addressing Islamic Finance

| | |
|---|---|
| Finance Act 2003 | Removes the levy of Stamp Duty Land Tax (SDLT) for <i>murabahah</i> and <i>ijarah</i> -based home financings |
| Finance Act 2005 | Clarifies tax treatment of payments made under <i>murabahah</i> and <i>mudarabah</i> contracts. Removes the levy of SDLT for Diminishing <i>musharakah</i> based home financings. |
| Finance Act 2006 | Clarifies tax treatment of payments made under Diminishing <i>musaharakah</i> -based financings and <i>wakalah</i> contracts. Extends benefit of relief from the levy of SDLT in <i>murabahah</i> , <i>ijarah</i> and Diminishing <i>musharakah</i> -based real estate transactions to all entities including companies. |
| The Financial Services and Markets Act (FSMA) 2000 (Regulated Activities) (Amendment) No. 2) Order 2006 | Diminishing- <i>musharakah</i> and <i>ijarah</i> -based home financings now regulated by the FSA. |
| Finance Act 2009 | Clarifies treatment of <i>sukuk</i> . |
| The FSMA 2000 (Regulated Activities) (Amendment) Order 2011 | to reverse the unintended effects of the Order i.e., the Financial Services and Markets Act 2000 (Regulated Activities) (Amendment) Order 2011. This order ensures that the correct regulatory treatment applies on or after 16 February 2011 |
| The FSMA2000 (RegulatedActivities) (Amendment) Order 2010 | Published on 19 January 2010 but comes into force on 24 February 2010, aligned the regulatory treatment of a certain type of <i>shari'ah</i> compliant financial instrument Alternative Finance Investment Bonds (AFIBs) with conventional debt securities to which they are economically equivalent. It created a new regulatory category for AFIBs, Article 77A, corresponding to Article 77 under which conventional securities are regulated. |
| The Stamp Duty Land Tax (Alternative Finance Investment Bonds) Regulations 2010 | The Regulations treat paragraph 11(3) of Schedule 17A as if including Schedule 61 to the Finance Act 2009 in the list of provisions (reliefs/exemptions) that apply for the purpose of dis-applying paragraph 11(2), and allow the AFIB relief to operate as intended, and will bring Schedule 61 in line with other reliefs. The aim is to ensure that the SDLT relief available for alternative finance investment bonds (AFIBs) operates as intended. |
| Finance Act 2011 | The government has announced that it will make regulations to introduce direct tax rules for <i>shari'ah</i> -compliant variable loan arrangements and derivatives in 2011. The government will formally consult on this measure. |

Source: Author's own

This section identifies certain legal consideration of securitisation and issuance of *sukuk* for and within the UK in practice. *Shari'ah*-compliant securitisation requires two layers of assessment. From an investor's perspective, both the underlying

reference assets and the transaction structure need to satisfy two legal regimes: applicable commercial law as well as Islamic law. There are considerable legal implications of structuring and offering such *shari'ah* compliant investment products given also that there needs to be consideration of *shari'ah* aspects within non-*shari'ah* juridical frameworks of the West (Abdel Khaleq 2004).

Examination of global issuances of *sukuk* impact upon the UK by way of English law being the predominant law of choice due to weak legal infrastructure and as conceptually adjustments are required to legal systems particularly in the GCC to accommodate securitisation requirements. These legal uncertainties are manifested in also several other ways. There are inherent possible conflicts with *shari'ah* requirements and Western legal systems. Indeed, conflicts between local courts in Muslim countries with *shari'ah* courts are also possible issues that have yet to be tested. Different jurisdiction legal processes may well have different judicial outcomes in the event for example of a default-particularly important as many *Sukuk* are multi-jurisdictional. There is a need for legal certainty particularly for dispute resolution involving complex structuring.

The most prominent example to date concerning Islamic Finance is that of the case contested '*Shamil Bank v Beximco*' (*Shamil Bank of Bahrain E.C. v Beximco Pharmaceuticals Ltd. (No.1)* [2004] 4 All ER 1072) in 2004. The English legal system decided by concession in this case, that law is the law of England and not both English law and the *shari'ah*. In 1995 Shamil Bank of Bahrain, a bank which applies Islamic principles in its banking business, lend money to Beximco Pharmaceutical Ltd and other borrowers. The loan was in the form of working capital facility based on the principles of *murabahah*. The *murabahah* agreements contained the following governing clause: "subject to the principles of the Glorious *shari'ah*, this Agreement shall be governed by and construed in accordance with the laws of England".

Subsequently the borrowers defaulted and the bank started court proceedings against the defaulters. The borrowers in their defence maintained that construction of the governing law clause demands that the finance agreements should be enforced in line with the principles of *shari'ah* and also in line with the English law. They further claimed that the *murabahah* agreements were invalid because it contained the prohibited element of *riba*.

The Court of Appeal ruled in favour of the bank and held that the principles of *shari'ah* did not apply to the financing agreements and this was not the borrowers' intention to apply those principles to the agreements. The Court further held that there could not be two separate systems of law governing a contract. Reference was made to the Rome Convention, which provides that parties should choose the governing law of a contract. It further explained that by the governing law means the law of a country and not a non-national system of law. The *shari'ah* according to the Court belongs to the latter category. The Court further determined that the general reference to principles of *shari'ah* in the governing law clause is silent on which *shari'ah* aspects it is intended to include. In the present case if the governing law clause had sufficiently incorporated the principles of *shari'ah* in the agreements, the borrowers' would have been likely to succeed.

In the opinion of the Court, the *shari'ah* defence was a 'lawyer's construct' and the borrowers never intended to apply the principles of *shari'ah*. The court ruled against the borrowers' interpretation of the governing clause and if that interpretation was accepted it would have defeated the commercial purpose of the documents. The Court held that the English law was the law of the contract and not the *shari'ah* and had the relevant *shari'ah* principles been validly incorporated in this case, the borrowers might have succeeded in their application.

Concerning matters more specific to the UK, there have been several developments in legislation within the UK to accommodate Islamic financial products including *sukuk*. The Finance Acts of 2003, 2005, 2006, 2009, 2010 and 2011 in conjunctions with that of the FSMA Act 2000/2006 deal with tax related aspects of essentially retail UK Islamic Finance products. The Finance Act (FA) 2007 clarified tax treatment for *sukuk*. Essentially it allows *sukuk* profit to be treated akin to interest gained from conventional bonds.

The Rt. Hon. the Lord Woolf (2007) as Chairman of the Financial Markets Law Committee called for an urgent comprehensive review from the Law Commission regarding Islamic Finance Market. He considered the UK legislative initiatives in this arena to have been 'piecemeal' as the sheer range of English laws affected, goes well beyond the remit of the financial services regulatory authorities and these issues cannot be addressed through regulatory initiatives alone. Additionally, there are

accompanying regulatory developments and further taxation consultations also that are highlighted within this research.

Legal issues specifically in relation to *sukuk* are highlighted below with additional concerns over multi-jurisdiction and conflicts between *shari'ah* and codes of commercial law are contained. Ahmed (2006) considers the development of Islamic jurisprudence as a combination of the procedures found in the civil law and common law systems. According to him recent history of Islamic finance indicates that the *shari'ah* has the adaptability feature in order to create financial contracts from traditional nominate contracts to meet the modern day needs of financial markets and intermediaries (Ahmed 2006). He further suggests that the adaptability feature of Islamic law can be complemented with the strengthening of the legal infrastructure to ensure the development of a comprehensive Islamic financial sector (Ahmed 2006). Addressing the need for homogenisation or consistency of *sukuk* to allow inter-operation with conventional legal systems, particularly, for multi-jurisdiction *sukuk* is still quite far-off. Ahmed's academic attempt to examine the basis of the issues is laudable.

Important discussions over *sukuk* definitions regarding legal forms are important and require to be clarified. From a UK legal perspective the economic substance is important that of the legal form. Hence, there is a broader need for the Islamic *sukuk* issues in the UK to be contained with any Law Commission Review.

Thomas (2007) contrasts legal objectives of true sale in the UK and USA. Within the USA, legally the originator has transferred bona fide control of the asset to a third party in exchange for consideration. However, for the UK, the objective is to ascertain whether or not such a transfer substantially moves all of the risks and rewards of ownership of the asset from the originator to the buyer. UK's approach is more aligned with the *shari'ah* approach.

6.6 UK TAXATION OF SUKUK

Islamic finance needs asset transfer to achieve a financing return. Stamp Duty Land Tax (SDLT), Capital Gains Tax and VAT exist in most OECD countries but the UK Finance Acts treat Alternative Finance Return to have same tax treatment as interest and permit relief in event of transfer of assets for purpose of alternative finance.

murabahah (financing) and *ijarah* (leasing) contracts are now well established in the UK. However more precedent for capital market products (Alternative Finance Bonds or *sukuk*) is needed.

The UK is developing a favourable tax and regulatory environment for Islamic Finance. The removal of double stamp duty on Islamic mortgages and the extension of tax relief on Islamic mortgages to companies, as well as to individuals are recent changes. Tax reform of arrangements for issuances of debt has also been made so that returns and income payments of *Sukuk* can be treated as interest in the Finance Bill 2007. This makes the LSE more attractive for issuing and trading *sukuk*.

The UK tax process involves interest payments before the calculation of tax. However, the distribution of profit is usually calculated after tax. This profit is sometimes subject to further taxation before reaching the beneficiaries. In the Middle East, this is generally overcome by not having taxes. Malaysia overcomes this by providing specific exemptions for Islamic Private Debt Securities. The UK Government is currently working on a number of structuring, regulatory and taxation issues that need to be resolved before *sukuk* issuance can proceed. There is a range of taxation impacted at an investor and wholesale level.

From an investor perspective, income tax is liable if the income arose from the certificates is directly or indirectly bought in the UK. Both a disposal of certificates or of the underlying assets could be chargeable under capital gains; the rate depending on whether there is a disposal by the certificate holder or by the trustee. Inheritance tax arises upon the death of an individual or from a lifetime gift of certificates only in relation to assets in the UK.

In Budget 2007, the UK Government announced the introduction of a specific tax regime for *sukuk*. The FA 2007 introduced two new sections in FA 2005, 48(A) and 48(B), dealing with 'debt-like' *sukuk*, which are referred to as Alternative Finance Investment Bonds (AFIBs). The legislation set out a number of conditions that must be satisfied.

If *sukuk* meet the conditions in FA 2005/s48A, conferring on them the status of alternative finance investment bonds, and 'interest-like' payments made or received under the bonds are treated as an alternative finance return. For the purposes of

corporation tax, alternative finance investment bonds are taxed under the rules on loan relationships (FA 2005/s50). For income tax purposes, alternative finance return received on such bonds is taxed as if it were interest (FA 2005/s51). For the purposes of capital gains tax, alternative finance investment bonds are taxed as qualifying corporate securities to be qualifying corporate bonds.

There are certain tax consequences for an *ijarah sukuk* following the passing of the UK Finance Bill 2007. The *sukuk* or AFIB is regarded as security for tax purposes and treated as a loan relationship for the corporate investor. For the individual investor the *sukuk* is an interest bearing debt. The issue discount is taxable as if interest. The *sukuk* is effectively a debt for issuer taxation with the issuer being taxed as if it beneficially owned the assets and the periodical payments treated as deductible interest. There is no Capital Gains Tax if the issue is in sterling and not convertible.

The HMR&C consultation document (2008) on commercial *sukuk* proved an overview of the particular difficulties faced by the alternative finance industry and details the measures the UK Government introduced in order to provide a level playing field to alternative finance products. The UK Government sought comments on the provision of tax reliefs, the associated range and costs arising on the issuance of a commercial *sukuk* and set out the proposed legislation framework under which commercial *sukuk* issuance could be introduced in the UK for future development of the market. The objective was to introduce legislation in the Finance Bill 2009 to provide relief from SDLT for alternative finance investment bonds. The scope also considered the amendment of legislation to classify alternative finance investment bonds as loan capital for the purposes of Stamp Duty and Stamp Duty Reserve Tax (SDRT).

The Government has already introduced legislation enabling the provision of alternative methods for individuals or business to finance a property purchase, deposit money in a bank and borrow money from a financial institution. The focus has now moved to the issue of alternative finance investment bonds based on real property.

Interests in land or property as the underlying asset may often back bonds. In a normal securitisation, the investor does not have a direct ownership in the underlying asset but merely an interest-bearing certificate. With alternative finance investment bonds,

however, the investors own part of the underlying asset. This necessary change in ownership of the underlying asset may involve SDLT, Capital Gains Tax and Capital Allowances (CAs) issues.

To provide similar tax outcomes for alternative finance products to their equivalent conventional finance products, no SDLT or tax on capital gains should be charged when the land is sold to the issuer of the alternative finance bonds and no SDLT or tax on capital gains charged on the sale back of the property to the originator at the end of the bond term. In addition the position of alternative finance bond-holders will be clarified to ensure that SDLT does not arise on the acquisition or transfer of an alternative finance bond certificate. The originator should also be able to claim any CAs on the asset during the term of the bond.

These new provisions address certain tax barriers to ensure that the cost of issuing an asset based alternative finance investment bond is equivalent to conventional equivalent financial product.

Therefore, in terms of Section 123 and Schedule 61 facilitate the issue of AFIBs based on real property. They ensure that disposals and acquisitions of real property in connection with such bonds do not incur liabilities to SDLT or tax in respect of chargeable gains and entitlements to CAs are preserved. They have effect from the date of Royal Assent.

SDLT is a charge on the acquisition of a chargeable interest whether or not evidenced in writing. UK stamp duty does not apply on an issue of conventional securities. The issuance of a conventional bond secured on a building does not cause any SDLT payment to arise. However, in a *sukuk* structure, the originator, in order to ensure *shari'ah* compliance, must transfer an asset to an SPV, so that the investors can own part of the underlying asset. The SDLT would, therefore, be charged if a chargeable interest, such as a building, is transferred to an SPV that issues *sukuk*, and is charged again when the originator buys back the building or land at a rate of four per cent (assuming that the asset is valued at more than £500,000) for each transfer. The *sukuk* certificate buyers would be liable to SDLT as the certificate will evidence their interest in an underlying chargeable asset.

The legislation introduced in Finance Bill 2009 provided specific relief included the SDLT exemptions proposed for the following *ijarah sukuk* transactions: i) the transfer from originator to the SPV, ii) the transfer back from the SPV to the originator and iii) the issue and resale of *sukuk* bonds. In order to obtain the relief the *sukuk* must fall within requirements of s48A of FA 2005 (AFIBs).

SDRT also acts as a barrier to issuance and secondary market transfers. Stamp duty is a tax payable on the transfer of certain types of documents/instruments, which transfer certain kinds of property. 'Property' mainly consists of stock or marketable securities, but also includes transfers of interests in partnerships. Stamp duty or SDRT may be charged at the rate of 0.5 per cent on the transfer of an instrument. A higher rate of 1.5 per cent is applicable when the documents/instruments are transferred into a 'depository receipt scheme' or a 'clearance service'. These are special arrangements in which the documents are held by a third party.

Under the then tax legislation, the issue and/or transfer of the *sukuk* was likely to give rise to an SDRT payment on the basis that the *sukuk* would probably constitute chargeable securities as non-exempt loan capital or possibly 'units in a unit trust scheme', which would cause them to fall within the definition of 'chargeable securities' and thus within the scope of SDRT. By contrast, the transfer of a 'plain vanilla' bond would be generally exempt from stamp duty and SDRT. This differential taxation treatment placed the *sukuk* at a competitive disadvantage vis-à-vis conventional debt instruments.

However, the provisos are the asset must be defined and returned to the originator within the same period as the bond issuance. Additionally, the *sukuk* issuer would need to identify a UKI agent who would become liable for SDLT should the asset not return to the originator. A charge would be held on the asset by HMRC for the period it is held by the SPV. To provide for asset substitution, no relief will be granted on a substituted asset until the original underlying asset had been returned to the originator.

In February 2010, HM Treasury made an Order the Financial Services and Markets Act (FSMA) 2000 (Regulated Activities) (Amendment) Order 2010 to amend the FSMA Act 2000 (Regulated Activities) Order 2001 (S.I. 2001/544). This change

brought the AFIBs on equal treatment with the conventional debt securities. It created a new regulatory category for AFIBs, Article 77A, corresponding to Article 77 under which conventional securities are regulated.

Later it appeared that the terms of the first order caused many regulatory and tax problems. Not purposely, it had the effect of creating a category of financial instruments which neither fall under Article 77 (where such instruments are not listed or traded, or where the interest on them exceeds a commercial rate of return) nor within Article 77A. As a consequence, such instruments do not qualify for the stamp duty loan capital exemption under section 79(4) of FA 1986, and companies issuing such securities are unable to benefit from the special tax regime for securitisation companies.

In January 2011, HMT made a second order (the FSMA 2000 (Regulated Activities) (Amendment) Order 2011), to reverse the unintended effects of the first order. This order ensures that the correct regulatory treatment applies on or after 16 February 2011. Finance Bill 2011 will provide that for all tax purposes, the second order will apply as if it had been made on 24 February 2010. As a consequence, instruments will continue to qualify for the stamp duty loan capital exemption and the securitisation company regulations will apply as if the first order had not inadvertently dis-applied Article 77. A person may elect to opt out of this continuity of treatment, to ensure that no one is disadvantaged by these provisions.

The initial issue and subsequent resale on secondary markets of the bonds would be exempt. The *sukuk* issuer must issue bonds up to the value of at least 95 per cent of asset. To encourage wide ownership of bonds if one person acquired 10 per cent or more of the total *sukuk* then any income generated above that level would be restricted. If the SPV fails to restrict the income for parties holding 10% or more of the *sukuk* on three occasions, then, on the third offence, the SPV would become liable to 4% SDLT on the market value of the asset.

The arrangements must allow the bond-issuer to manage the assets so as to generate sufficient income to make the redemption payments and the additional payment. The alternative finance bonds must be listed on a recognised stock exchange; hence, income payments can be made without withholding income tax in the same way that

no income tax is withheld on interest paid on listed Eurobonds. The arrangements must be wholly or partly treated in accordance with international accounting standards as a financial liability.

Dealing in *sukuk* and many supplies of ancillary services to *sukuk* will generally be exempt from the VAT exemption on supply of financial services or goods (Adam & Thomas 2004). However, as the investors in *sukuk* are described as having an ‘undivided beneficial ownership interest’ in the underlying asset, the investors may be subject to a VAT charge on any rental payments received from the SPV and on their purchase of the *sukuk* (Housby 2011). VAT payments may not be recoverable (GB HM Treasury 2007). There is no comment regarding the relief on VAT on such rental transfers within the HMR&C consultation paper.

There are four primary markets on LSE; The Main Market – a premier market for larger companies, AIM – a global market for smaller growing companies, the PSM – the Exchange regulated market for listed debt and Depository Receipt Securities and the Specialist Fund Market – the dedicated market for issuers of specialist funds (Singh 2011).

The LSE offers a choice between two markets for the listing of debt securities: the EU regulated Main Market and the Exchange regulated PSM (Mantysaari 2010). The Main Market issuers are subject to the EU Prospectus and Transparency Directive requirements. Therefore, investors can also obtain a passport to other European markets and access to international investors (Klein 2005). The PSM is outside the scope of the EU Prospectus and Transparency Directives (Ferran 2008). The PSM provides a more flexible alternative solution for those issuers seeking to list debt securities and depository receipts in London without having to re-state their financial information to International Financial Reporting Standards or follow the additional requirements of an offering to retail investors (LSE 2007).

Most *sukuk* launched on the LSE to date have been listed on the Main Market (LSE, 2008). The demand for foreign (mainly Middle Eastern) corporate issuers to List *sukuk* in London is clear. Currently there are 46 *sukuk* listed in London, including the first sovereign *sukuk* listing in London (from the Central Bank of Bahrain *sukuk*).

Table 6.6: Listing Requirements for Sukuk on LSE Markets

| | Professional Securities Market | | Main Market | |
|---|---|---|---|---|
| | <i>sukuk</i> | GDR ⁷ | <i>sukuk</i> | GDR |
| Prospectus | Not required | | | |
| Accounting Standard | Listing Particulars LR4 | | Prospectus | |
| Financial Information | Latest two years of audited accounts (or such shorter period since has been in operation) | Latest three years of audited accounts (or such shorter period since has been in operation) | Latest two years of audited accounts (or such shorter period since has been in operation) | Latest three years of audited accounts (or such shorter period since has been in operation) |
| Exchange's Admission and Disclosure Standards | √ | √ | √ | √ |
| Corporate Governance Statement | n.a | √ | n.a | √ |
| 25% in Public hands | n.a | √ | n.a | √ |

Source: FSA

6.7 THE STRATEGIC POSITIONING OF THE LSE FOR SUKUK

A report by the rating agency Moody's (2008d) examining the development of Islamic finance in relation to France comments on the UK's national approach to the development of the industry and consequences for Europe:

“UK combines-cleverly, and in a characteristically British way-farsightedness, opportunism, common sense and liberalism, and has been adopted on four fronts: retail banking, wholesale banking, Islamic insurance (*takaful*), and *sukuk*. In every one of its aspects, this strategy pursues clearly identified objectives and has been employed with clear and open motives, frankly and without triggering a philosophical debate.”

⁷Global Depository Receipt.

The LSE has been recognised as encouraging innovation that has led to its depth and breadth as a primary exchange in world markets (Wilson 2008 and 2007). Its aim to become the market leader for Islamic finance, however, recognises that there are challenges and adjustments that may be necessary (Hesse et al. 2008). In the context of the LSE's tradition of 'competitive innovation' and flexibility to new ideas, Islamic Finance products developed in London are being marketed in other countries, even in the Middle East (Ainley et al. 2008). During the last 30 years of Islamic experience, it has developed as markets and skills base well placed to take advantage of these trends (Ainley et al. 2008). It is enhancing its ability to attract further *sukuk* structuring activity and activity related to Islamic finance more generally (GB HM Treasury 2007). London has deep and liquid markets and the exchanges are among the most frequently used venues for listing and trading Islamic financial instruments globally (Ainley et al. 2008). The 'Islamic windows' of established business lines based in the UK have contributed significantly to the development of Islamic finance because of the institutions' global experience in the Middle East and South East Asia in product development and their access to far greater resources than those available to local institutions (Ainley et al. 2008).

The LSE has proven to be an attractive draw for *sukuk* issuance. In 2010 there were 5 new listings worth \$1.7bn on the LSE's markets, with a single *sukuk* in early 2011 worth \$0.5bn. This has brought total *sukuk* listings to 46. Key milestones for the LSE have included the GE Capital *sukuk* in 2009, the first listed *sukuk* by a USA corporate, and in 2010 the Kuvayt Turk *sukuk*, the first by a European bank. Figure 6.5 depicts the *sukuk* listings at the LSE in terms of number of issues and annual amount of issues (The City UK 2011).

Figure 6.5: Sukuk Listings at LSE

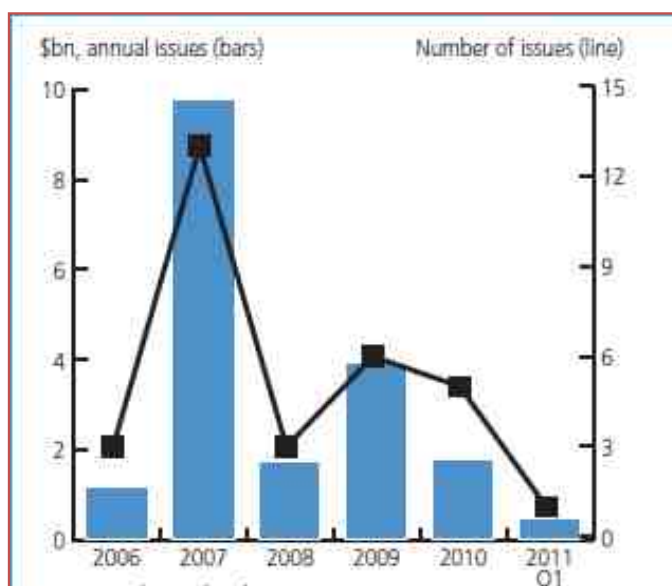

Source: LSE

A significant development in the UK in 2010 was the first corporate *sukuk* issued in 2010 by International Innovative Technologies. The company, a new technology development company specialising in design, precision engineering and manufacture of innovative products, issued it. The £10m *sukuk* was supposed to be used by the company as growth capital (The City UK 2011).

The Islamic finance industry in the UK is still keen to see a UK sovereign *sukuk*. While there is strong cross-party consensus in the UK on the need to develop Islamic finance, the UK government in January 2011 reiterated the position of the previous government: that the issue of a sovereign *sukuk* is not judged to provide value for money at the present time (The City UK 2011).

There are a huge liquidity surpluses and a surge in demand for Islamic as well as conventional assets in the countries of the Gulf region (Ainley et al. 2008). The capacity of the local financial markets has not, however, been able to develop at the same speed. London is well-established to capitalise on such competitor weaknesses (Ainley et al. 2008). The UK Government's public policy is also favourable with the objective for Islamic finance being twofold: to entrench London as a global gateway for Islamic finance; and to ensure that all British citizens, regardless of their faith, have access to competitive financial services—that is financial inclusion for all (Ainley et al. 2008). This strategy is exemplified further through the UK Government to

become a sovereign issuer of *sukuk* in the wholesale sterling market rated at AAA, and consequential aim to establish of a benchmark for high quality debt towards pricing more risky corporate issuances (Wilson 2007). It has established the HM Treasury Islamic Finance Experts Group (IFEG) to assist the development of the industry and its integration into markets.

As discussed earlier, the UK government taxation policy is also to develop a level playing field or tax-neutral system for *sukuk* and Islamic finance products (HMR&C 2008). Additionally, the FSA's approach is aligned with the government's objectives and is able to look across the system as a whole, to assess IFIs and products given their varying nature. The FSA single super-regulator and principles-led approach is being replicated in many other nations with recent discussion in the Netherlands looking to replicate the FSA regulatory structure and approach.

The LSE has enabling infrastructure, processes and procedures that are conducive in attaining the specified goals of the UK government towards Islamic Finance. Moody's (2008a) states that London has many advantages as a global financial centre: its size; its international status; a well-established and efficient market in which investors can put their money into a range of asset classes (including *sukuk*), which keeps its liquidity flowing; unequalled human resources and expertise in research, analysis, execution, structuring and preservation, *etc*; and a legal environment that is markedly more robust than those of most of the emerging markets. Compared to the UK many markets especially those in the GCC do not currently have a legal structure that can support the securitisation market. Property rights, trust law and insolvency law, are often rudimentary or non-existent in the GCC. This provides for more favourable conditions in the London. The FSA is seeking to apply the same principles-led approach and objectives to this arena, as it does to conventional instruments. These sentiments are echoed by Standard & Poors (2008) in their Islamic Finance outlook. Both rating agencies regard UK developments towards *sukuk* as of benefit to the industry globally.

For *sukuk* establishment within the UK, requires an infrastructure with high human capital and high absorptive capacity from the LSE that allows it to compete with other *sukuk* markets. Parameters for high absorptive characteristics are diverse. Besides asset price competition, asset class diversity, and the presence of an sophisticated

investor base, certain general criteria need to be satisfied for a viable use of asset securitisation from a supply and demand side perspective: (i) structural market imperfection due to fiscal constraints and high borrowing costs; (ii) an adequate and bankable legal and regulatory framework for bankruptcy, tax, and corporate governance issues; and (iii) transparent transaction structures that ensure demonstrable and unimpeded control over securitised assets subject to persistent monitoring by rating agencies, trustee and guarantors (Jobst 2007). Absorptive capacity also needs to consider systemic inhibitors such as market fragmentation (Delorenzo and Mcmillen 2007). Market fragmentation is identified by several factors (McMillen 2006). These include countries/underdeveloped markets within jurisdictions characterised by illiquidity, currency weakness, excessive concentration of risks and lack of specialisation. Further, significant inhibitors such as the state of legal and regulatory development (Securities and bankruptcy laws are relatively rudimentary for securitisations and capital markets). Lack of scale in the Islamic finance field is another inhibitor (ibid).

Another inhibiting factor is the scarcity of human resources such as qualified *shari'ah* scholars and experienced financial, legal, accounting and other professional of all types. It is widely acknowledged that there is a global shortage of experienced professional in the Islamic finance sector. There is clearly scope for more education and training in the UK and some positive steps are now being taken. These include university degrees and professional training courses. The shortage of resources also extends to *shari'ah* scholars who have relevant banking experience. To address this, some firms have placed less-experienced scholars alongside experienced ones on their SSB, thus helping to develop more knowledgeable scholars. The lack of trained *shari'ah* scholars in the UK is a weakness of the UK infrastructure for development of *sukuk*.

Several Islamic institutions and financial products have already been listed or traded over the counter at the LSE. Ten major global banks operating in the UK have set up units to provide Islamic financial services or 'windows'. Islamic banks in the UK have more than four times the number of banks offering Islamic Financial Services than any other country in Western Europe (IFSL 2008).

Market demand has stimulated growth in innovative mortgage products, new savings and commercial property finance products. Numerous fund managers and a number of accounting and international law firms are also offering Islamic services (IFSL 2008). Although only a small number of IFIs are capable of managing funds using *murabahah* instruments for inter-bank reserve borrowing and lending in this way on the London Metal exchange and hence charges were relatively high and returns were low.

AIM is the LSE's international market specifically designed for smaller, growing companies since 1995, combining the benefits of a public flotation with appropriate levels of regulation (Coyle 2000 and LSE 2009). Companies are listed through, vetted by, guided by, and arranged by a Nominated Advisers otherwise known as NOMADs (LSE 2010). The first listed Islamic investment house on the LSE, Tejoori was launched on the rapidly growing AIM in 2006 (Tejoori Limited 2006). This avenue is likely to be exploited more by Islamic companies and products. Conventional UK institutions have been involved in contributing to the development of Islamic finance (Grais and Pellegrini 2006). Barclays Capital partnered DIB for the world's largest *sukuk* issuances and Standard Chartered is also involved in the GCC and South East Asia. UBS Switzerland is prominent in *shari'ah* Wealth management and Deutsche Bank is active in *shari'ah* capital funds (Janin and Kahlmeyer 2007; Ahmad 2010b; Jamaldeen and Friedman 2012).

The climate in the UK has fostered Islamic Financial Services over the last 30 years permitting a range of IFIs and products that exceed other European markets. However, there have been no *sukuk* originations from the UK despite numerous non-UK domicile listings. There has been a landmark *sukuk* issuance from the German state of Saxony-Anhalt in 2004 (July 31st) of 100 million Euros. This is a five-year *ijarah sukuk* with a floating return based on the six-month Euribor rate plus one percent. It was rated at-AA by Standard & Poor's, listed in Luxembourg with a trust established in Holland.

In comparison with France, which has the highest European population of Muslims, the UK has a more pragmatic approach to the Islamic Finance Industry (Moody's, 2008a), as the Islamic finance industry in the UK is a good example of more favourable political economics in relation to France. Despite French institutions

setting up Islamic finance products on the Middle East and MENA, France is erecting barriers to establishing its own market for Islamic finance even while seeking to attract surplus oil wealth. The French do not have the political will to capitalise on the notion of 'Islamic' finance. Germany also has a larger Muslim population than the UK, yet it too seems to have lost first mover advantage and not established momentum subsequent to the first European *sukuk* launch in 2004. Hence, there is the LSE value adds to *sukuk* trading and issuance in relation to EU. However, Wilson (2007) sees the inclusion of Turkey into the EU as a threat to the UK's ambitions as the leading Islamic finance centre in the EU. Elsewhere, the Australians trying to incorporate facets of UK Financial Acts into their regulation of Islamic finance products.

6.8 REVIEW OF UK CONSULTATIONS AND DEVELOPMENTS ON SUKUK

The FSA published a paper titled "Islamic Finance in the UK: Regulation and Challenges" that highlights the UK approach to *sukuk* (FSA 2007). There have also been two public consultations. The UK Government through HM Treasury (2007) sought a public consultation in November 2007 regarding sovereign issuance whose response was published in June 2008. HM Revenue & Customs sought reviews on corporate issuance of *sukuk* with the primary focus on taxation (GB HM Revenue & Customs 2008). It is not clear to what extent the IFEG has been involved or what scope they had regarding these consultations and responses. However, both consultations do not appear to have had *shari'ah* scholarly input. In future, Islamic finance interest groups should request the government to get their input so that there should not be any conflict of a prospective legislation concerning *sukuk* with accepted *shari'ah* principles. The UK government is also preparing a long-term strategy paper for developing Islamic finance in the UK (HM Treasury 2008).

It is evident from these documents that even by these institutions of the establishment, a form of UK regulatory arbitrage is occurring regarding *sukuk*. The emphasis contained throughout is to approach the topic of *sukuk* as a debt instrument and treating *sukuk* from a regulatory and taxation perspective as such irrespective of the true nature of *sukuk* and the corresponding transactions.

The HM Treasury consultation (2007) sought views on the potential for Government (Sovereign) issuance of wholesale sterling denominated *sukuk* either in ‘bond-like’ or ‘bill-like’ form. A ‘bill-like’ *sukuk* was defined as a *sukuk* with maturities of less than one year, for example three months to maturity. A ‘bond-like’ *sukuk* is considered as a *sukuk* with maturities of greater than one year, for example, five years to maturity. In relation to this, the consultation sought accompanying issues to be resolved over, legislation, asset selection and taxation treatment in relation to asset transfers and payments.

There were several grounds provided towards UK *sukuk* issuance. Such developments contribute to the wider acceptability of *sukuk* as an asset class (GB HM Treasury 2007). There is likely to be increased secondary market liquidity in the *sukuk* market, with a sovereign issuance acting as a risk-free benchmark to facilitate pricing of other issues in the Islamic finance market (ibid). This should also enable and support the development and delivery of retail Islamic finance products UK based (ibid). The UK and industry wishes to move away from commodity *murabahah* as the fixed costs associated with transacting in commodity *murabahah*, made investment at short maturities particularly expensive (ibid). It would allow for further active liquidity management of Islamic banks (UK and non-UK domiciled) who are subject to the same regulations for liquidity management as conventional banks but lack tradable instruments beyond *murabahah* in the UK (ibid). *Sukuk* potentially strengthen the balance sheets of IFIs in the UK by providing an AAA-rated sterling denominated asset for Islamic banks, which would qualify under Basel II as a claim on central government (ibid).

The Government has so far assumed as a default position that any *sukuk* issuance would be structured using *ijarah* as the underlying contract. This follows an additional *mudarabah* study previously conducted. The Government seeks to continue to minimise any differences between any *sukuk* issuance and bonds and bills whilst not compromising the *shari‘ah* compliance of any *sukuk* issue. It also seeks for them to be treated as equivalents to their conventional counterparts including any issues relating to taxation, regulation, listing, registration and settlement that apply to the purchase and issuance of *sukuk* in ‘bond-like’ or ‘bill-like’ form.

In response to the consultation, HM Treasury decided in favour of an issuance of 'bill-like' *sukuk* rather than 'bond-like' *sukuk*, although it did not rule out potential issuance of 'bond-like' *sukuk* (GB HM Treasury 2008). A rolling programme of up to £2 billion of 'bill-like' *sukuk* issuance was thought to be achievable over time. This 'bill-like' *sukuk* programme would be fully integrated with the conventional Treasury bill programme, which currently has issuance at one, three and six month maturities; and would use a 'plain vanilla' *ijarah* contract to facilitate *sukuk* issuance. Sterling Treasury bills are currently issued on a competitive basis via tenders, held by the DMO on the last business day of each week. Treasury bills can also be sold to the market bilaterally. A small issuance of *sukuk* was sought as desirable initially and that *sukuk* issuance should be gradually increased thereafter. Any issuance of 'bill-like' *sukuk* would initially be relatively small, with a total programme limit of £2 billion.

The advantages and risks for selection of a bill-like *sukuk* were thought to be better. The shorter maturity of 'bill-like' *sukuk* would require a lower absolute level of funding than for 'bond-like' *sukuk* maintenance and have a smaller impact on conventional issuance. 'Bill-like' *sukuk* were thought to be more likely to be priced at, or close to, conventional equivalents than 'bond-like' *sukuk* as well as have a smaller impact on gilt supply than 'bond-like' *sukuk*.

The disadvantages at present with sovereign 'bond-like' *sukuk* issuance were deemed to be: the requirement of a larger volume of issuance necessary to achieve desirable levels of liquidity; which would also require a larger size and/or number of assets to be transferred to the SPV. Issuance of this size raises practical and other issues; and given the size of issuance involved, it is more difficult to achieve a regular programme for 'bond-like' *sukuk*. While gilts are listed on the LSE, Treasury bills are not. Amongst other features, listing requires the publication of a prospectus.

6.9 2011-PRE-BUDGET PROPOSALS

The 2011 Budget introduces legislation to limit the availability of Alternative Finance reliefs where they are being misused to avoid Stamp Duty Land Tax (SDLT). The government has announced that it will make regulations to introduce direct tax rules for *shari'ah*-compliant variable loan arrangements and derivatives in 2011. The

government will formally consult on this measure. If this happens, it will be a good step forward for the growth of Islamic finance in UK.

6.10 UK AND THE SOVEREIGN BOND-LIKE SUKUK

From the Treasury's response (2008), the characteristics of a sovereign bond-like *sukuk* were needed to: be perceived as having an equivalent credit risk to that of gilts; have a zero capital risk weighting; be eligible for use as collateral for the Bank of England's open market operations; be included in the same Government bond indices as gilts; have the same market-making support as for gilts; be strippable; have the same tax, listing, settlement and clearing treatment as gilts; and be eligible for the DMO's standing and special repo facilities (GB HM Treasury 2007). In the absence of some; or all, of these features, government *sukuk* would be likely to trade at a discount to gilts (ibid). However, from a *shari'ah* perspective it is not permitted for an instrument to be strippable in the conventional sense-the revenue and the asset must remain as one (ibid). Further, the issues of 'repos' are controversial themselves as they bring into the equation of the forbidden sale-buyback agreement (*bay' al-'inah*)-amongst other matters(ibid). Hence, it is perhaps not achievable to have a government *sukuk* as equivalent to gilt presently.

As eligibility of the *sukuk* as collateral for the Bank of England's open market operations is a matter for the Bank of England, the UK Government needs to coordinate with them (ibid). The Treasury also expressed its intention to work with Euroclear to ensure an appropriate settlement solution for *sukuk*, which would allow them to be settled in the CREST system (ibid). However, it recognised that any required systems changes could take a significant period of time (ibid). The FSA is also currently considering the treatment of the *sukuk* for risk-weighting for capital adequacy purposes (ibid).

An *ijarah* based *sukuk* structure was selected on the basis of; ease of structuring, wider *shari'ah* acceptability, tested legal documentation, flexibility in structuring rental payments, tradability and the ability to repurchase the assets underlying the structure at face value at maturity which allows for redemption of the *sukuk* at par (ibid). With the exception of sovereign issuance in Brunei, an *ijarah* contract has not been used, to facilitate short-term *sukuk* issuance (ibid).

However, the *ijarah*-based *sukuk* involves the need for frequent transfer of asset ownership (ibid). This has several consequences. As an SPV would have to declare a trust in favour of investors, before acquiring ownership, beneficial or otherwise, of the underlying assets, there is a potential conflict as to whether the SPV could be owned by the Government. However, it appears that the intention may not be to give over full ownership rights to the SPV as the UK Government would only transfer beneficial title to the underlying assets to the SPV and that maintenance of the underlying assets can remain with the UK Government via the use of a service agency agreement (ibid). The proposed use of a purchase undertaking issued by the UK Government to ensure that the assets would revert to the UK Government in the event of default is controversial and would need to be ratified from a *shari'ah* perspective. This has not apparently been considered (ibid).

It was noted that the issuance of UK sovereign *sukuk* would help to integrate *sukuk* as an asset class within the London markets, including leading to circumstances in which the UK Government developed a '*sukuk* yield curve' that would provide a pricing reference for other issuance. This could also avoid the need for benchmarking against an interest-based alternative, such as the LIBOR. In the event that the UK Government did issue 'bond-like' *sukuk*, the Treasury would approach the relevant bodies to ask them to examine the case for inclusion of the *sukuk* in the relevant government bond indices. However, research shows, as there may be difficulties in having *sukuk* exactly equivalent to gilts, such indices may not be accurate. The potential of separate indices may need to be considered. It was highlighted that any 'bond-like' *sukuk* should be designed to be attractive to conventional, as well as Islamic, investors.

Corporate *sukuk* success is linked with the evolution of the sovereign *sukuk* in the UK. Were these obstacles removed, unfamiliarity and higher transactions costs (legal fees) may still deter potential issuers.

In December 2008, Treasury jointly with the FSA, launched a '*Consultation on the Legislative Framework for the Regulation of Alternative Finance Investment Bonds (sukuk)*' which set out the proposed legislative framework for the regulatory treatment of "AFIBs". The order in fact takes into account responses received by Treasury to its consultation, which focused on definition of an AFIB as similar in characteristics to a

conventional bond, its regulation as such, mandatory listing of AFIBs, and tax provisions for AFIBs. Respondents to the consultation included special interest groups vis-à-vis., top City law firms, Islamic banks in the UK, other major financial institutions, community organizations and professionals.

The term alternative finance is synonymous with Islamic finance, though it actually encapsulates any form of financing which does not conform to western banking models. The UK Government aims to ensure, as far as possible, neutral taxation treatment between *sukuk* and their conventional equivalents. At present HM Revenue & Customs in their consultation document recognise that UK taxation requirements are acting as a barrier to the development of the alternative finance industry (GB HM Revenue and Customs 2008). This is a view echoed by the Treasury and Industry practitioners. For example European Islamic Investment Bank (EIIB) considers the issue of taxation as the most important inhibiting factor in the UK for the development of the *sukuk* and is currently preventing the issuing of *sukuk* and restricting the market. The consultation document builds upon the views sought in respect of the sovereign issuance and seeks to develop a mechanism for relief by which the barriers to the issuance of a commercial or corporate *sukuk* can be removed. To ensure a level tax playing field would involve a minor administrative burden in their opinion.

Building on legislation in the FA 2007 regarding *sukuk* and in light of discussions with industry, the UK Government announced at Budget 2008, that it would consult on removing the barrier to *sukuk* with the aim of legislating in FA 2009.

There is some replication of both consultation efforts in terms of questions on market size appreciation. It is clear that a proper market research and analysis is required to ascertain issues of supply and demand from a strategic perspective for the UK.

The HM Revenue & Customs consultation paper is not organised in the same manner and appears to display a different level of understanding of the concept of *sukuk* to that of the consultation document of the Treasury. For example, section (HMR&C 2008) regarding asset selection proposes shopping centres or hotels as possibilities. The asset selection of hotels might prove problematic as such assets involve the sale

of alcohol and may not be permissible normally. *Shari'ah* compliance is not considered within the HMR&C document.

As a result of consultations, the country took a step nearer to facilitating the issuance of the first UK corporate *sukuk*. In February 2010, the necessary final legislation adopted by the House of Commons following the introduction of The FSMA 2000 (Regulated Activities) (Amendment) Order 2010 to amend the FSMA 2000 (Regulated Activities) Order 2001 (S.I. 2001/544), by Treasury to support Islamic finance and the issuance of corporate *sukuk* within the UK.

According to the Treasury, Order 2010 will help to provide a level playing field for corporate *sukuk* within the UK and provides clarity on the regulatory treatment of corporate *sukuk*, reducing the legal costs for these types of investments and removing unnecessary obstacles to their issuance.

Both public consultations did not consider the various forms of *ijarah* of which at least five (5) are contained within the AAOIFI *Shari'ah* Investment *Sukuk* Standard Seventeen (17) (AAOIFI 2010). Other forms of *sukuk* albeit acknowledged in a limited fashion have no plans formulated or approaches specified for consideration. The HMR&C make no reference beyond that of the *ijarah sukuk* not even to that of a *mudarabah* model. There is also no explicit acknowledgement that the range of subject matter requiring reviewing as a consequence of *sukuk* is not really being appreciated. The apparent exception to this has been Lord Woolf (2007) in his request for a thorough review of all legislation from the Law Commission concerning Islamic finance-he identifies current approaches including that of the regulatory as 'piecemeal'.

Whilst the Treasury has been careful in avoiding defining *sukuk* categorically as a debt instrument, the HM Revenue and Customs approaches the regulatory treatment of *sukuk* as a debt instrument within their respective consultations. As alternative finance investment bonds must have a fixed term or maturity date, they are distinguished from collective investment schemes, where the investor's interest in the scheme may subsist indefinitely. However, controversially there does appear to be a suggestion that the HM Revenue & Customs whilst acknowledging that the *sukuk* fall within the

remit of collective investment Schemes of Tax treatments, they will not be regarded as such.

“Where an alternative finance investment bond is treated as a loan relationship, FA1996/S80(5) ensures that profits or losses from the bond cannot be taxed or relieved in any other way. But because many, if not most, *sukuk* arrangements involve the creation of a trust, and fail to be treated as collective investment schemes under FSMA 2000, the legislation provides that tax provisions relevant to trusts or to collective investment schemes do not apply.” (GB HM Revenue and Custom 2008)

There is also no clear intention specified as to whether or not UK sovereign *sukuk* are to be asset-based or asset-backed from the HM Treasury response consultation. However, due to the proposal of the use of an accompanying purchase undertaking with *sukuk* issuances and other references within the consultation response, it appears that the government will pursue the issuance of an asset-based *sukuk* in line with other sovereigns. This likely to seriously undermine the *shari'ah* legitimacy aspect of the issuance and may have an impact on prospective customers. There are also no mechanisms describing within the documentation the detailed differences in treatment arising from asset-based and asset-backed issuances by both the Treasury and HMR&C whether or not if an eventual bond-like *sukuk* would be listed was not specified.

6.11 REFLECTIONS AND CONCLUSIONS

The UK Government has not yet decided its preferred way to ensure the *shari'ah* compliance of *sukuk* issuance. The Treasury view was limited to seeking approval for the *sukuk* to be approved by a recognised board of *shari'ah* scholars, in the form of a *fatwa* (or opinion). However, the Treasury's approach did not consider the fact that *shari'ah* boards should be involved for the entire product lifecycle of the *sukuk*. The expected additional transaction costs of *sukuk* for example from *shari'ah* compliance and legal involvement were also not highlighted for both sovereign and more importantly for commercial issuances. The Treasury is yet to decide how to obtain *shari'ah* compliance.

There are only a few arguably integrated academic approaches (Adam and Thomas 2004; Jobst 2007). However, they are not contextualised for the UK financial markets and bodies. The developments in the UK *sukuk* market are nascent and requiring detailed academic enquiry due to the complexity of the issues rather than general approaches. The lack of expertise in understanding Islamic finance, its objectives and its complete value chain in the UK has been recognised and analysed through the public consultations sought on the topic of sterling sovereign and commercial issuance by HM Treasury (2007) and HM Revenues and Customs (2008) respectively in addition to recent efforts by the FSA (2007 and 2008). A holistic approach to research *sukuk* in the UK has been necessary that has required an integration of conventional and more traditional Islamic perspectives. This chapter has sought to address this gap. Contradictions have been highlighted and aspects analysed that are lacking in current approaches towards *sukuk*. Such academic works may help develop better theoretical and practical frameworks for financially engineering *sukuk* and their issuance in the UK.

This chapter has considered the topic of securitisation and issuance of *sukuk* from three perspectives each successive to the other each with relevance to the UK contexts. The first slant being the *shari'ah* basis, followed by the regulatory aspects and the market aspects. All facets are interdependent. From each has been derived the concerns, difficulties and risks arising from the complexities of *sukuk*. However, the originator of *sukuk* is the *shari'ah* element. Summarising these issues, it has been shown that at each level, the current *sukuk* securitisation and issuance is a story of arbitrage; *shari'ah* arbitrage, regulatory arbitrage and market arbitrage⁸. However, what is additionally fascinating is that this arbitrage has been brought about those responsible for the governance of the specific elements.

Shari'ah arbitrage or *shari'ah* engineering elements have been identified by certain scholars El-Gamal (2006a), Usmani (2007 and 2008) and Chowdhury (2008). If there was to be a perfect case study of *shari'ah* arbitrage it would be the *sukuk* industry.

⁸A market arbitrage is the potential for market participants to use a particular market or product instead of a competing market or product to exploit regulatory differences. Investopedia defines market arbitrage as purchasing and selling the same security (product) at the same time in different markets to take advantage of a price difference between the two separate markets (Investopedia at <http://www.investopedia.com/terms/m/marketarbitrage.asp> [Accessed 21/03/2012]).

Many issues of *shari'ah* 'arbitrage' have close connotations in practice to justifications of the principle of '*dharoorah*' or necessity within the exploitation through *shari'ah* engineering. This justification is arguably invalidated overtime and this time has arrived. The fundamental nature of *sukuk* as being asset-backed with full ownership presiding on a risk-sharing basis with the *sukuk* certificate holders is being challenged. Most *sukuk* have been asset-based with originators ensuring that ownership is not fully transferred to investors. The question of the *sukuk* structure being asset-backed or asset-based nature permeates this research topic. It is of paramount importance at all-levels at *shari'ah*, regulatory and market levels. Interestingly, each perspective is realising asset-based *sukuk* only. This is even at *shari'ah* gauge where many scholars permit asset-based venture to the detriment of asset-backed *sukuk*. At a regulatory level, the UK is driving an asset-based *sukuk* agenda from its consultation responses and documents. The UK regulations should cover both asset-backed and asset-based *sukuk*.

At a market level, sovereigns and corporate originators do not wish to give over full ownership rights. This is perhaps strange when conventional securitisation efforts do undergo true sale and bankruptcy remote structures and issuances. Competitive advantage could be gained through issuance of asset-backed *sukuk*. Admittedly, the structures and hesitancy or inertia due to the lack of regulatory and market desire may necessitate more development for this to occur.

Moody's (2008a) expects that *shari'ah*-compliant securitisation will expand going forward, and that therefore asset-backed *sukuk* sponsored by IFIs and other corporations will grow materially in number and size. For IFIs, these structured *sukuk* would play the roles of both attractive funding mechanisms and powerful balance-sheet and risk management tools.

Regulatory arbitrage in the UK has been brought about through the FSA, HM Treasury, HMR&C essentially confining *sukuk* to be within the debt market space and providing tax relief when technically they do not fall within this arena and are more akin to the definition of CISs. HM Treasury (2007) focus and default position on *ijarah sukuk* as the reference *sukuk* although understandable as an evolutionary first step, it is perhaps limiting in their pursuit of 'bond'-like' or 'bill-like' *sukuk* issuance. Regulatory arbitrage is occurring as the regulators seek to contrive a strategy of fitting

ijarah sukuk into the ‘debt’ box and in practice following a ‘one-size fits all’ approach for all *sukuk*. Arguments of economic substance over than legal form are being cited. However, both need to be consistently aligned. Nevertheless, the *ijarah sukuk* is a welcome first step. However, it is a limited approach given the broader range of *sukuk* possibilities. Additionally, the evolution of the hybrid *sukuk* is occurring within the market place, with simultaneously unique features including those that are debt-like and equity-like creating discussions at all levels. Treating *sukuk* as a commodity class on their own right distinct from bonds, shares or derivatives needs to be on the discussion agenda.

Market arbitrage as per this research is described as the process where the value of the *sukuk* is not being reflected by true fair market prices and performance of the underlying assets but through the credit risk of the originator or insurer in most cases which, in most cases are sovereigns for global *sukuk*. Market arbitrage is arising as originators, issuers and investors seek to capitalise on the profit motive elements come what may for example, through the use of asset-based *sukuk*. Pricing efforts are underdeveloped and distorted through market behaviour; buy-to hold sovereign issues guarantors. The LSE and Financial Times Stock Exchange (FTSE) are also considering rightly the introduction of a *sukuk* index (Hajdukovic 2008). Sovereign issuances as risk-free rates would provide a benchmark. However, it is unlikely that *sukuk* issuances will have the same profile or same pricing characteristics such as their conventional counterparts’ gilts or treasury bills despite the best of efforts. Hence, equal treatment of *sukuk*-like bonds and bills may not be possible. Manipulation is occurring to bring benefit primarily to benefit to the stakeholders of the market. There is a captive audience and a willing set of stakeholders at each level (El-Gamal 2006a). There is clearly a will, and that will, will find a way to make money out of *sukuk*.

The origination and issuance of *sukuk* is a conventionally driven practice akin to bonds, that is primarily profit motivated and not fulfilling the loftier objectives of Islamic finance. The moral appeal and purpose of *sukuk* is being neglected at all levels. *Sukuk* appeal to global investors, irrespective of consideration or not regarding *shari’ah* compliance aspects. However, *sukuk* stakeholders cannot ignore the *shari’ah* elements. Normally one can use the expression, ‘the ultimate success lies in the

market-place’. However, *sukuk* success originates in the *shari’ah*. Whoever brings to market a true asset-backed origination will gain competitive advantage over others with accompanying Islamic characteristics as identified within the *sukuk* value chain proposed below. The UK regulatory approach and review should be to start off with this objective of obtaining a *shari’ah* acceptable asset-backed origination top-down and seek to determine how this can be achieved as an outcome of its initial valuations.

The *sukuk* can create competitive advantage and strategic value for the LSE over other markets. The value chain of *sukuk* as determined from this research is proposed within Figure 6.6. This model is unique and the key aspect to note from this proposal is that the *shari’ah* is the fundamental starting point for value and a primary activity for margin creation that must permeate through all elements of the process towards issuance. The *shari’ah* element is currently being considered by most as a support activity for example in terms of a *fatwa* being generated and a compliant SSB. The technological aspects include the settlement systems. The structure design activity involves the packaging of the *sukuk* for example in terms of any ‘guarantees’ or promise elements such as insurance equivalents. The market placement considers for example the pricing aspects and the nature of the market.

Figure 6.6: Value Chain for Sukuk

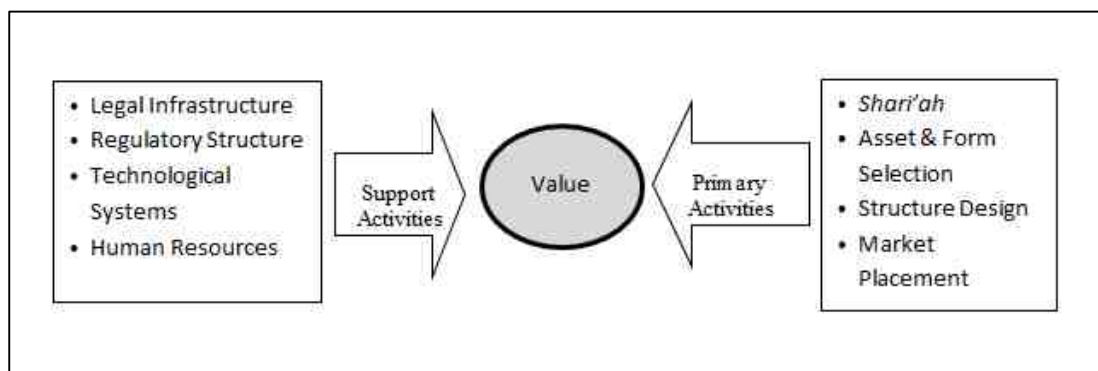

(Source: Author’s own)

Global and emerging markets are shown to be lacking the absorptive capacity of the LSE for *sukuk*. Absorptive capacity amongst other factors, requires institutional infrastructure and resources – not just in quantity but also in quality. From an Institutional legal, regulatory, technological and market infrastructure, the LSE is

perhaps best place globally to capitalise on this. However, at a *shari'ah* compliance level, it is lacking in comparison to other centres such as Malaysia and Dubai.

London is well positioned for European dominance with its comparative developments crating competitive advantage and strategic value. The UK is, clearly positioning to ensure that all Europe's Islamic finance would have to pass through the London market. Towards this it can become the European hub for the listing of Euro-Sukuk-Islamic Eurobonds-in a variety of currencies (Moody's 2008a). This is more readily achievable through the exploitation of the cross-border series passport, which enables the UK and its financial institutions to offer its products and services across all EU member states, without a physical presence in the host country. Figure 6.7 below exhibits key parameters for the success of *sukuk*.

Figure 6.7: Key Parameters for the Success of Sukuk

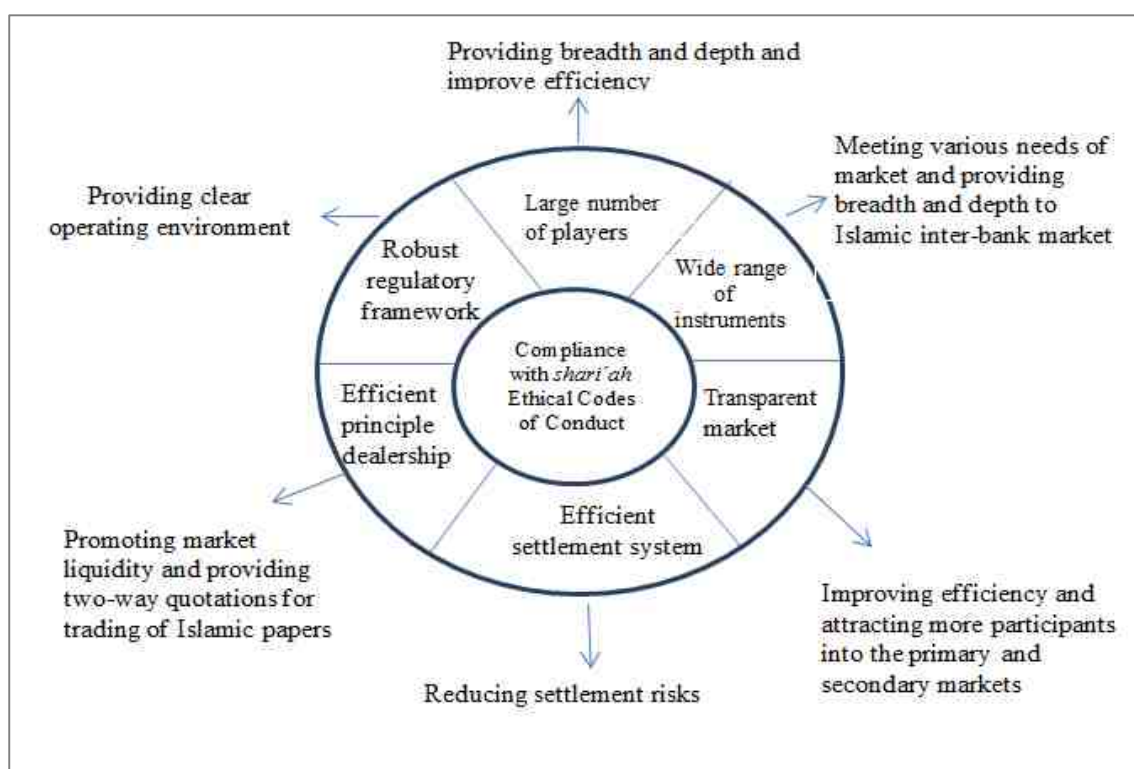

Source: Aseambankers (2006)

Further, if Turkey an aspiring EU member joins, the UK Islamic finance industry will be well-placed to enter not only Turkish markets (of 75 million Muslims) but also Central Asian markets through this avenue (Wilson 2007). UK positioning can be capitalised upon if it truly originates an asset-backed *sukuk*. Asset-based *sukuk*

issuance as its current inclination will undermine its worthy efforts. Malaysia has realised this and actively participating at various levels through AAOIFI and IFSB to make *shari'ah* compliant *sukuk* acceptable on traditional Islamic finance practices.

For the success of *sukuk* to occur, the high demand and supply forecasts amongst Muslims will need to appeal to non-Muslim (DiVanna and Strategies 2007). Whether or not, the positioning of Islamic Finance as ethical funds might be of benefit needs to be examined (DiVanna and Strategies 2007). This presents fresh regulatory challenges. The UK is in a unique position with its sovereign issuance to establish high ratings benchmarked *sukuk* through appropriate market-makers. Global capital markets would find it difficult to overtake first-mover advantage of LSE with its strategic aim to position itself as the hub for Islamic finance. It is currently well – placed to gain competitive advantage from its current dominance, willingness and attractiveness to customers (from the Gulf). It should not be forgotten that the LSE is owned 28% by the Dubai Borse. The development of *sukuk* within the UK markets will be shown to be perhaps most significant in setting the pace and create value for all stakeholders of *sukuk*.

CHAPTER 7

CONCLUSION

7.1 SUMMARY OF THE RESEARCH

This research aimed at critically analysing *sukuk* through legal, *shari'ah* and regulative aspects. In doing so, reference was made to its development, growth, issues involved in it and legislative and regulatory developments for *sukuk* in the UK. It also addresses the issue of *wa'ad* (undertaking) in *sukuk* industry and compares the concept of *wa'ad* with promise and promissory estoppel in common law. For this case, the relevant laws are also referred to in this research. The research supports Islamic financial engineering developments with a focus on addressing the contemporary issues facing the Islamic financial industry especially with reference to the UK.

This research attempted to peruse through original sources of both *shari'ah* and English Common law on the application of *wa'ad* particularly in the context of *sukuk* and derivatives. The research endeavoured to illustrate the essentiality and amplitude of the concept of *wa'ad* in both classical and contemporary Islamic jurisprudence with general implications in the context of *sukuk* and derivatives. In addition, the research explored the issue of enforceability of *wa'ad* in English Common law jurisdiction with reference to equivalent legal concepts of promise and promissory estoppels in light of relevant case law. The overall aim is to ascertain the correct *shari'ah* position for the validity purposes and the precise legal standpoint for enforceability purposes in the application of the *shari'ah*-compliant products.

7.2 REFLECTING ON THE RESEARCH FINDINGS

Sukuk is a recent development in Islamic finance which has so far been successfully performing in the market since 2001, which, as claimed by their promoters, is not only *shari'ah*-compliant but also ethical and moral. This research is conducted to determine whether or not claims of *sukuk* supporters have some ground or not and for this purpose following seven research

questions were developed and this section aims to examine these research questions with the knowledge developed in the earlier chapters. The research questions also relates to the UK experience.

R_{q1}: Sukuk are shari'ah compliant;

R_{q2}: Derivatives may be allowed under shari'ah. Shari'ah concerns such as SS, existence of subject-matter at the time of contract, possession of subject-matter before conclusion of contract, debt-sale, speculation may be removed with careful considerations;

R_{q3}: Sukuk as Islamic derivative instruments are as efficient as that of conventional derivative products and apply the similar securitization principles. Sukuk represent a process of securitization and securitization is selling the asset portfolios to investors in the form of securities. Their growth may be witnessed by exploring development in UK;

R_{q4}: Wa'ad has the same authority as that of 'aqd (contract);

R_{q5}: Wa'ad can be compared with 'promise' and promissory estoppels in Common law;

R_{q6}: Use of wa'ad in equity-based sukuk is against the shari'ah;

R_{q7}: Usage of wa'ad in derivatives, Forward Options, TRS and SS is inappropriate.

R_{q8}: UK is an attractive country for promoting and growth of sukuk.

In order to determine that following sub-research questions were developed:

R_{q8(i)} In UK sukuk have received positive legislative and regulatory response on its securitisation development;

R_{q8(ii)} Whether or not desire of AAOIFI that shari'ah boards should have more operational powers is welcomed by UK?; and

R_{q8(iii)} Sukuk are not treated as debt-instruments.

Rsearch question I: Sukuk are shari'ah compliant.

As the existing classical knowledge necessitates, sukuk holders should have ownership in real assets, which is emphasised in the AAOIFI *fatwa* of February 2008. Assets must be acceptable in

shari'ah, for example assets in the *sukuk* may be shares of companies that do not confer true ownership but merely a right to returns. In addition, virtually all of the *sukuk* issued guarantee by indirect means the return of principal to the *sukuk* holders at maturity, in exactly the same way as conventional bonds. A *mudarib* or a partner or an agent in *sukuk al-mudarabah*, *musharakah* and *wakalah*, respectively, cannot commit to repurchase assets at face value or nominal value upon maturity. But they can undertake to repurchase at the net value or market value of the assets or at a price that is agreed upon at the time of purchase. However, purchasing at the face value can only occur in cases of negligence or non-compliance of stated conditions. Repurchase does not allow it to be at the original value, as this would alter the *sukuk* to be tantamount to a *riba* contract. In true commercial enterprises, where the *shari'ah* is concerned, the return of investors' capital cannot be guaranteed. In *shari'ah* compliant dealings, reward always follows after risk. In the case of *sukuk al-ijarah*, AAOIFI allow the lessee to agree to purchase the leased assets when the *sukuk* are extinguished for their face (nominal) value provided that the lessee is not also an investment partner, *mudarib*, or agent.

Sukuk issues of Malaysia are mostly based on the concepts of *bay al-'inah* of underlying asset and the concept of *tabarru'* while their trading in secondary market took place through *bay' al-dayn* using the label (*Bay' Bithaman 'ajil*). Malaysian Islamic bonds based on *bay' al-'inah* and *bay' al-dayn* principles are not acceptable to mainstream juristic opinion and majority of *shari'ah* experts. Therefore, if a *sukuk* is issued by observing above formalities, it may be regarded as *shari'ah* compliant but this does not mean it is also *shari'ah* based. Though in form these are *shari'ah* compliant and may be allowed but whether or not these are also *shari'ah* compliant in terms of substance is totally different matter. For example in the case of *Nakheel Sukuk*, the obligors were unable to fulfil their guarantees and undertakings. Therefore, *sukuk* holders sought to have recourse to the properties which *sukuk* certificates were representing. But in reality no true ownership transfer took place in favour of the SPV, which raises concerns about the *Shari'ah* compliance nature of the *sukuk* and many *sukuk* present in the market. This research therefore concludes and accepts the research question that *sukuk* are *shari'ah* compliant but one has to determine their *shari'ah* compliance on individual case basis.

Research question II: Derivatives may be allowed under shari'ah. Shari'ah concerns such as Short-Selling, existence of subject-matter at the time of contract, possession of subject-matter

before conclusion of contract, debt-sale, speculation may be removed with careful considerations.

Derivatives are controversial in Islamic finance. It is said that derivatives imply speculation (*maysir*), uncertainty and ambiguity (*gharar, jahala*), exploitative zero-sum game (*zulm*), and high leverage - interest - (*riba*) and these issues are discussed in Chapter 3 of the thesis. As discussed in detail in the previous chapters, derivatives from the point of view of opponents may be prohibited for the following reasons:

- (i) Non-existence of subject matter at the time of transaction;
- (ii) Presence of subject-matter at the time of contract;
- (iii) Subject-matter must be in a deliverable position;
- (iv) The contract must be enforced immediately with the transfer of ownership and delivery of the subject-matter;
- (v) Ownership must lie with the seller at the time of contract otherwise it will amount to SS, which is prohibited in Islamic law; and
- (vi) Goods must not be sold prior to taking their possession.

This study concluded that since *shari'ah* has forbidden *gharar* and uncertainty on the existence of subject-matter at the time of delivery, it is not necessary that the subject-matter be existed at the time of contract. In all sales immediate transfer of ownership and delivery should be made except in the sale of *salam* and *istisna'*. In a contract of sale, the parties may agree either to defer payment of sale or delivery of the subject-matter. In futures-trading, the delivery in open contracts is delayed but guaranteed through the mechanism of clearing-houses in the exchanges, hence, no *gharar* and uncertainty. In futures trading one acquires liability when a contract is concluded and question of possession is immaterial.

A purchaser of an item may not resell it unless he gets possession over it, but sale in futures derivatives may be made prior to take possession where the object of sale is not food-grains like cotton, rubber and tin. It is further observed and concluded that futures involve *bay' al-dayn* but there is no general consensus on the prohibition of *bay' al-dayn* and in the absence of any consensus on its prohibition the maxim of permissibility in things will prevail if free of *riba* and

gharar. Bay' al-dayn which is incurred in futures transactions is in the nature of the fulfillment of an obligation and the repayment of a debt by the debtor.

Research question III: Sukuk as Islamic derivative instruments are as efficient as that of conventional derivative products and apply the similar securitization principles.

Sukuk represent a process of securitization and securitization is selling the asset portfolios to investors in the form of securities. According to AAOIFI (*Shari'ah Investment Sukuk Standard 17*) securitisation "is a process of dividing ownership of pooled tangible assets, usufructs or both into units of equal value and issue securities as per their value." Conventionally, it is used primarily as a means of securitising debt, but securitisation is not limited to debt. The Islamic alternative is mostly the securitisation of real capital assets and property leasehold interests. Originators sell existing or future revenues from a portfolio of Islamically acceptable assets to a SPV, which refinances itself by issuing unsecured securities to market investors, who are the capital market corollary to a singular lender in Islamic finance. The investors assume the role of a collective financier. *Sukuk* in itself are a form of securitisation through the underlying asset backing or asset-based mechanism.

Islamic securitization transforms bilateral risk sharing between borrowers and lenders in Islamic finance into the market-based refinancing of one or more underlying Islamic finance transactions. Therefore, this research concludes that Islamic securitisation offers generally the same economic benefits conventional structured finance purports to generate, such as the active management of designated asset portfolio due to greater control over asset status, as well as the isolation of certain assets in order to make them self-financing at a fair market rate.

Research question IV: Wa'ad has the same authority as that of 'aqd (contract).

Chapter 5 discusses the *wa'ad* wherein it was held that classical jurists are in agreement that an *'aqd* is legally binding on the parties. In the case of *wa'ad*, a promisor is morally bound but he is not legally liable to fulfill his promise.

On the issue of fulfilment of promise this research concludes that: (i) a group of *fuqaha* held that if the harm as a consequence of non-fulfilment of promise is unforeseeable, the promisor cannot be apprehended unless a wilful commission of a tort such as negligent misstatement is proved;

(ii) some of the *fuqaha* regards the fulfilment of a *wa'ad* as *wajib*; and (iii) another group of *fuqaha* is of the view that promise is not binding on the promisor but where a promisee incurs expenses relying on the promise then it is upon the promisor to execute it.

This research further concludes that present day scholars are of the view that a *wa'ad* becomes binding where it gives rise to a tort. Therefore, the implications of this conclusion is promises may have the binding nature if upon the undertaking of the promisor, a promisee incurs some expenses or does a similar act detrimental to his interests.

Research question V: Wa'ad can be compared with 'promise' and promissory estoppels in Common law.

The discussion presented in Chapter 5 further explores the research question of the comparability of *wa'ad* with the concept of 'promise' and 'promissory estoppel' in Common law. The concept of promissory estoppel English legal system has similarities with *wa'ad* such as both *wa'ad* and promissory estoppels are unilateral; and for any failure of promisor to perform his promise, the promisee can seek compensation. Promissory estoppel is an extension of Common law estoppel through the principles of equity. This research came to the conclusion that *wa'ad* is not an enforceable phenomena under English common law. It may however be enforced if it is executed through a deed poll or there is an element of forbearance which can be proved or alternatively a party can bring action in tort. Therefore, if this is the case, *wa'ad* can be enforced in English Courts under Common law.

Research question VI: Use of wa'ad in equity-based sukuk is against the shari'ah.

Purchase undertaking in an equity-based *sukuk* is to guarantee the principal to the *sukuk* holders regardless of the fact that the *sukuk* assets loose their value or gain value. The research proves the research question that any guarantee of principal or return is against the spirit of equity financing in Islam. On the contrary use of *wa'ad* turns an equity-based *sukuk* into a fixed return mode of financing from a variable mode of financing. This is already understood that any guaranteed fixed income in commercial transactions is *riba*, which is impermissible in the eyes of *shari'ah*. Therefore, guaranteeing an income through *wa'ad* cannot be allowed.

Research question VII: Usage of wa'ad in derivatives like FX forward options, TRS and Short-Selling is inappropriate.

In 1992, the Jeddah-based OIC Fiqh Academy, in its seventh session, held that FX forward transactions, without regard to the fact that they are helpful in speculation or hedging, are impermissible. The reason for such an impermissibility was due to its violation of *sarf* principle that it must be on the spot. According to this research by usage of *wa'ad* (unilateral promise), one can promise to buy and sell currencies on one date and delivery to be made on another date. As per the ruling of the OIC Fiqh Academy, unilateral promises in commercial transactions are binding with certain conditions.

This research further concluded that in TRS by using one set of double *wa'ad* and in SS structure by using two sets of double *wa'ad*, TRS and SS structures, the usage of *wa'ad* is not appropriate. It is inappropriate both in form and substance.

Research question VIII: UK is an attractive country for promotion and growth of sukuk

R_{q8}(i) In UK sukuk have received positive legislative and regulatory response on its securitisation development

There are inherent conflicts with *shari'ah* requirements and western legal systems. There is a need for legal certainty particularly for *shari'ah* compliant product development and dispute resolution involving such products. UK has the capability in terms of infrastructure to become a leader in Islamic finance. Current regulatory regime of FSA has to incorporate various *shari'ah* requirements for devising various *sukuk* structures. The discussion and analysis thus concludes that FSA has sufficient legislative and regulative infrastructure to entertain *shari'ah* compliant products such as *sukuk* in the future.

R_{q8} (ii) Whether or not desire of AAOIFI that shari'ah boards should have more operational powers is welcomed by UK?

UK Treasury so far is impartial in the debate on *shari'ah* compliance approval process of products. Whether or not there should be an appointed SSB, an independent *shari'ah* authority, an independent board of scholars or an international body to regulate this matter,

is still debated in UK. However response to consultations suggests for the appointment of *shari'ah* scholars by the government in any board formed after devising a mechanism in either a secular jurisdiction or otherwise.

R_{q8} (iii) Sukuk are not treated as debt-instruments

It is important to define *sukuk* in terms of regulations whether these are treated as debt-instruments or CIS or Asset-backed instruments. This is important for tax consequences. There is Confusion between FSMA and FSA about if *sukuk* are CIS or not.

This study came with an extensive research and analysed growth of *sukuk* and its structures in UK with legislative and regulatory developments and concludes UK is place where development of *sukuk* is phenomenal for the role of LSE. Though not many *sukuk* are being issued in UK but it is a place where most of the *sukuk* are listed. The result shows the popularity of the instrument in the UK market.

7.3 CONTRIBUTIONS OF THE STUDY

This study will help in determining the key legal, regulatory and *sharia'h* compliance issues to the Islamic financial industry in UK with special focus on derivatives (*sukuk*), in particular, and to the Islamic financial industry as a whole in general. After highlighting the issues, solutions to the problems will be suggested by gathering suggestions from the professionals and a model will be presented through this research which will try to match the customer's requirements in accordance with the injunctions of the Qur'an and *sunnah*.

From a strategic perspective it is clear that the *sukuk* market will influence and be affected by political, economic, social and technological forces. Hence, a strategic review analysis of *sukuk* issuance and relevant capital market development as sought by this research would assist in the establishment of a sovereign *sukuk* market to determine where competitive strengths lie and where value can be created in its quest to be the global hub of Islamic Finance. HM Treasury proposals to undertake a review (2008) are welcome, although the scope should be comprehensive.

7.4 RECOMMENDATIONS

It is important that the UK is involved and seeks to address the need of standardisation to achieve its goals realising value and advantage over its competitors in the field of Islamic finance. However, to expedite and provide a robust foundation, the UK should seek official involvement with the IFSB and AAOIFI. Anticipated developments occurring externally identify the need for the UK to keep abreast with global *sukuk* developments such as the concept of a universal *sukuk*.

The relationship between *shari'ah* compliance and regulatory stipulations in non-Islamic jurisdictions are key to the success of Islamic financial instruments. The selection and issues of *shari'ah* compliance for its own sovereign issuances may be quicker fed through a global representative body. However, the immediateness and relevance of scholars in the UK with experience of UK financial markets may well be more appropriate. It is recommended that the IFIs in the UK establish such a *shari'ah* reference point for industry that could help works towards standardisation and homogenisation of *shari'ah* elements.

Most *sukuk* issuances governing law and jurisdictions of dispute resolution are contractually defined for the more established Law courts of England. However, as it is clear from the analysis presented in the earlier chapters that the FSA (2007: 13, 16) and the UK Treasury (amongst many others) wish to avoid being a participant in the debate on *shari'ah* towards compliance of products such as *sukuk* and advocating a particular position. The FSA does not regulate nor provide any formal guidance on the governance of SSBs. The role of the SSBs does need to be clearly identified to the FSA (2007:13) including the extent to which the *shari'ah* board is involved in the running of the board. The rulings by the AAOIFI (2008) clearly call for a more operational involvement on part of these boards. This potential conflict requires to be managed. There are additional requirements to resolve the *shari'ah* stipulations for Islamic financial products and those of the UK legal system and financial policies and avoid legal uncertainties.

It is appreciated a starting point is required and a necessary evolutionary path occurs on a gradual basis. However, UK efforts towards Islamic Finance although laudable are as Lord Woolf (2007) states piecemeal requiring legal developments beyond the scope for regulatory authorities. If political economics or Islamophobia dictates that the term Islamic cannot be employed. Then an alternative finance structure needs to be permanently instituted at different regulatory and

institutional levels. With the current trend, the IFEG can become a *de facto* establishment in practice.

The development of Islamic Finance in the UK is a politically driven debate based on sound economic principles. The political direction shown by the UK government sends a signal to the Muslim world regarding its attractiveness for investment. The development of *sukuk* within the UK markets is perhaps the most significant key to obtain first-mover advantage of the LSE with its strategic aim to position itself as a global hub for Islamic Finance. Global capital markets would find it difficult to overtake this. It is currently well-placed to gain competitive advantage from its current dominance, political direction and attractiveness to customers both conventional and from the Gulf having surpluses from oil revenues and cash due to illiquidity in their own markets. The FSA approach is commendable, as it is seeking to apply the same principles-led approach and objectives to this arena as conventional finance, and thereby encouraging the development of the *sukuk* industry. The UK establishment is beginning to recognise the complexity and breadth of the machinations of *sukuk* securitisation and issuance. The benefits of *sukuk* need to be identified to the UK market-place through promoting and increasing awareness of the *sukuk* concept to market stakeholders as per the FSAs objectives.

Taxation has been found to be the single most inhibiting factor for originating commercial or corporate *sukuk* in the UK. The taxation policy in the UK has been modified to accommodate Islamic financial products including *sukuk* to provide a level playing field for their equivalent products. It has been shown that regulatory arbitrage is occurring to a degree through applying debt instrument taxation to *sukuk* when they are recognised to be more appropriately classified as CISs.

A critical mass is needed to be developed of volume of trading for both bill-like *sukuk* and bond-like *sukuk* for there to be an effective pricing benchmark. The developments of the Treasury bill-like *sukuk* will be fascinating for monitoring and analytical purposes globally. The experiences of conventional instruments, both bonds and bills, may well be relevant for *sukuk* in the UK.

Opportunities for example from spill-over effects can be exploited. Spill-overs arising from *sukuk* are likely to occur in a variety of forms. For example, controversial credit enhancements

from a *shari'ah* perspective could be met by *takaful* (or Islamically acceptable mutual insurance).

Increasing international network externalities along with the blurring of institutional boundaries and increasing product complexities require regulatory adjustments and flexibility. The *sukuk* capital markets are not waiting for scholars to provide legitimacy for their activities, as *shari'ah* compliance throughout the product life cycle is also not a prevailing decision-making influence.

Sukuk and securitisation are clearly against the traditional fundamental debt like nature of current markets. The use of asset-backed *sukuk* in dis-intermediated finance develops real economics. Securitisation creates net gains as almost everybody gains something from the process. Islamic institutions, promote direct asset financing, rather than lending funds to entities and individuals. Securitisation through *sukuk* enables Islamic institutions to by-pass conventional interest-based instruments and shortcomings by engaging directly with the assets to be financed, and with investors in an Islamically acceptable fashion. The *sukuk* phenomenon and Islamic finance could offset issues such as the credit crunch and SS practices that are causing mass volatility to markets on a regular basis due to the nature of financial markets being remote from real industry. As *sukuk* is an instrument that could bridge such gaps on a global basis with its true potential yet to be realised on an ever increasing converged single global integrated interdependent economy.

Sukuk in the market are characterised by a compressed spread environment, shortage of investment assets and abundant global liquidity. McMillen (2006) highlights that market depth is a prerequisite to the development of strong securitisation capability and related secondary markets. Programme issuers are a critical component, and those issuers must generate considerable volumes on a constant basis. The prevalence of sovereign guarantees has made asset risk incidental to counterparty risk and credit support mechanisms sponsored by sovereign goodwill, hampering market maturity and investor sophistication. Despite this, 'buy-and-hold' investor philosophy predominates. Hence, for the UK Government to have a program philosophy towards issuance of *sukuk* will help develop secondary markets.

When Islamic finance is truly Islamic, rather than profit-driven *shari'ah* arbitrage, it should be good finance at a good price (El-Gamal 2006a). Malaysia is seeing benefits accruing from the excess Gulf liquidity and elsewhere from avenues where it did not have such investors

previously due to dubious *shari'ah* arrangements. The loftier objectives of Islamic finance are not being realised. Increased inequality is being seen, with the concentration of the wealth of Islamic finance in the hands of a few in contradictions to the aspirations of Islamic economics. *Sukuk* have taken off in terms of quantity, but the emphasis now needs to shift to quality. In financial terms, the current *sukuk* offerings simply mirror their conventional equivalents. More financial engineering and imagination are clearly needed if new products are to be developed, with distinctive risk characteristics that will appeal to Muslims, and indeed non-Muslims seeking to diversify their risk portfolios. Complementary activities to securitisation from Islamic fund management would be mutually-enforcing vehicles for Islamic finance promotion.

The key element of pricing *sukuk* should be reflective of the traditional attributes of value; time, cash, flow and risk. The nascent *sukuk* indices of Dow Jones and HSBC/DIFX are a mechanism to progress pricing scenarios that should develop overtime. However, they are currently not accurate representations of benchmark performance because of the low volume of *sukuk* meeting criteria the indices are not reflective of the various underlying forms of *sukuk*. The LSE and FTSE are also considering rightly the introduction of a *sukuk* index.

7.5 LIMITATIONS OF THE RESEARCH

Similar to any other study, this research has also limitations too in terms of methodology, strategy and analysis. However, whilst one cannot rule out limitations in research, one should not overlook the specific advantages of the research methods which have been painstakingly selected. Moreover, since this is a qualitative research, then criticisms of being too subjective, difficulty of replicating, problems of generalisations and an alleged lack of transparency will always be raised (Bryman, 2004). This research ensured that these limitations are at least dealt with adequately.

As for limitations of legal research methodologies, the main criticism of 'black-letter law' by advocates of 'law in context' is focused on preoccupation with doctrine and as such it is thought to be rigid. However, the proponents of the former contend that adopting 'socio-legal' methods "dissolves the unity of law as a distinct discipline by fragmenting both the sources and methodology of legal analysis" (Twining 1990). Therefore, a combination of the two methodologies should balance out the limitations.

The research strategy is also not completely free from limitations. Case studies have been criticised for lack of statistical generalisability and non-representativeness (Cornford and Smithson 1996). Nonetheless, they are of use in structuring and refining generalizable concepts and through multiple studies they can result in propositional generalisations (Pettigrew 1985).

Discourse and textual and textual analysis also suffer from being “limited to understanding particular [discourse and text] and cannot develop a more general theory of what’s going on” (Maxwell 1996:78). This criticism is actually levelled at all ‘contextualising strategies’ of which discourse and textual analysis are an integral part. However, this limitation can be reduced sharply in legal research by recourse to the previously mentioned rules interpretation which are specifically designed for this purpose. There are such rules for *shari’ah* law texts and English Common law texts respectively.

In terms of the study itself, the main limitation could be the lack of genuine case studies through particular *sukuk* issued in different regions (the EU, the GCC and the Malaysia regions). This could have provided further legitimacy for making generalisations.

7.6 EPILOGUE

This research aimed at critically examining the *shari’ah*, legal and regulative aspects of *sukuk* in the first place and then examining this in the case of the UK. As the foundational chapters provide the base through which such a critical examining can be made, it can be concluded that this study completed its task in the short-run, as in the long-run further *sukuk* development is expected.

APPENDIX: LIST OF LIVE INSTRUMENTS

| Admission Date | Issuer Name | Instrument Name | Market | Segment | Sector | Money Raised £(million) |
|-----------------------|--|--------------------------------|---------------|----------------|---------------|--------------------------------|
| 20111123 | Aadcb Islamic Finance (Cayman) Limited | CERTS 22/11/2016 | Main Market | CWNR | NIOW | 311.25 |
| 20101104 | Adib <i>Sukuk</i> Company Ltd | TRST CERTS 04/11/15 | Main Market | CWNR | NIDW | 469.1 |
| 20111130 | Adib <i>Sukuk</i> Company Ltd | TST CERTS 30/11/16 | Main Market | CWTR | UIDW | 323.83 |
| 20110729 | Almana <i>Sukuk</i> 2011 Limited | TST CERTS 28/07/16 | PSM | CWNU | EICU | 133.38 |
| 20120523 | Bsf <i>Sukuk</i> Ltd | 2.947% TST CERTS 22/05/17 | Main Market | CWNR | EIDW | 474.14 |
| 20111125 | Cbb International Sukuk Company (No.3) (Spc) | 6.273% TST CERTS 22/11/18 \$ | Main Market | CWNR | NIOW | 474.5 |
| 20080320 | Cbb International Sukuk Company (Spc) | TRUST CERTIFICATES 18/03/13 \$ | Main Market | CWNR | NIOW | 176.38 |
| 20090618 | Cbb International Sukuk Company No2 (Spc) | TRUST CERTS 17/06/14 \$ | Main Market | CWNR | NIOW | 458.76 |
| 20071102 | Dana Gas Sukuk Limited | TRUST CERT 31/10/12 \$ | PSM | CWNU | NIOW | 487.9 |
| 20100219 | Dar Al-Arkan International Sukuk Company Ii | CERTS 18/02/2015 (REG S) | Main Market | CWNR | NIOW | 289.29 |
| 20100219 | Dar Al-Arkan International Sukuk Company Ii | CERTS 18/02/2015 (144A) | Main Market | CWNR | NIOW | 0 |
| 20070703 | Dp World Sukuk Limited | TST CERTS 02/07/17 (REGS) \$ | Main Market | CWNR | NIOW | 751.04 |
| 20070703 | Dp World Sukuk Limited | TST CERTS 02/07/17 (144A) \$ | Main Market | CWNR | NIOW | 0 |

| Admission Date | Issuer Name | Instrument Name | Market | Segment | Sector | Money Raised £(million) |
|----------------|-------------------------------|-------------------------------|-------------|---------|--------|-------------------------|
| 20091103 | Dubai Dof Sukuk Limited | 6.396% TST CERTS 03/11/14 | Main Market | CWNR | NIDW | 745.78 |
| 20091103 | Dubai Dof Sukuk Limited | FLTG RTE TST CERTS 03/11/14 | Main Market | CWNR | NIDW | 406.08 |
| 20120118 | Eib Sukuk Company Ltd | TRST CERTS 18/01/2017 | Main Market | CWNR | NIDW | 326.22 |
| 20110204 | Emaar Sukuk Limited | TST CERTS 03/08/16 | Main Market | CWNR | NIDW | 311.12 |
| 20110802 | Fgb Sukuk Company Limited | TRUST CERTS 02/08/2016 | Main Market | CWNR | NIDW | 395.98 |
| 20120118 | Fgb Sukuk Company Limited | TRST CERTS 18/01/2017 | Main Market | CWNR | NIDW | 766.35 |
| 20091130 | Ge Capital Sukuk Ltd | TST CERTS 26/11/14 \$ | Main Market | CWNR | NIOW | 302.16 |
| 20070726 | Gfh Sukuk Limited | FLTG RTE SUKUK CERTS 26/07/12 | Main Market | CWNR | NIDW | 100.37 |
| 20110602 | Hbme Sukuk Company Limited | 3.575% TST CERTS 02/06/2016 | Main Market | CWNR | NIDW | 303.69 |
| 20090916 | Idb Trust Services Limited | 3.172% TRUST CERTS 16/09/14 | Main Market | CWTR | UIDW | 1.85 |
| 20110525 | Idb Trust Services Limited | TRUST CERTS 25/05/2016 | Main Market | CWTR | UIDW | 463.11 |
| 20101027 | Idb Trust Services Limited | TST CERTS 27/10/15 | Main Market | CWTR | UIDW | 319.08 |
| 20070608 | Iig Funding Limited | TRUST CERTS 10/07/12 \$ | PSM | CWNU | EIOU | 100.76 |
| 20071128 | Jafz Sukuk Limited | TRUST CERT 27/11/12 AED | Main Market | CWNR | NIOW | 996.49 |
| 20111101 | Kt Sukuk Varlyk Kiralama A.Đ. | CERT 31/10/16 | Main Market | CWNR | NIOW | 219.38 |
| 20100825 | Kt Turkey sukuk Limited | TRUST CERTS 24/08/13 (\$) | Main Market | CWNR | NIOW | 64.16 |
| 20120208 | Maf Sukuk Ltd. | 5.85% TST CERTS 07/02/2017 | Main Market | CWNR | NIDW | 252.96 |

| Admission Date | Issuer Name | Instrument Name | Market | Segment | Sector | Money Raised £(million) |
|-----------------------|--|---|----------------|----------------|---------------|------------------------------------|
| 20070816 | Nig Sukuk Ltd | TRUST CERTS 16/08/12 | Main Market | CWNR | NIDW | 232.12 |
| 20070803 | Qatar Alaqaria sukuk Company | TRUST CERT 02/08/12 \$ | Main Market | CWNR | NIOW | 146.6 |
| 20101008 | Qib Sukuk Funding Limited | 3.856% CERTS 07/10/15 \$ | Main Market | CWNR | NIOW | 474.53 |
| 20120404 | Saudi Electricity Global Sukuk Company | 2.655% CERTS 03/04/17 USD | Main Market | CWNR | NIOW | 315.78 |
| 20120404 | Saudi Electricity Global Sukuk Company | 4.211% CERTS 03/04/2022 USD | Main Market | CWNR | NIOW | 789.44 |
| 20110526 | Sib Sukuk Company Ii Limited | TRUST CERTIFICATES DUE 25/05/2016 | Main Market | CWNR | NIOW | 246.99 |
| 20080618 | Sukuk Funding (No.2) Limited | TRUST CERTS 17/06/13 AED | Main Market | CWNR | NIOW | 520.91 |
| 20091021 | Tdic Sukuk Limited | 4.949% CERTS 21/10/14 | Main Market | CWNR | NIDW | 602.23 |

Source: LSE (website)

GLOSSARY

'Aam: General text. A general word or textual evidence, as distinguished from a specific word (*khass*)

Ahadith: (singular *hadith*): Speech, conversation. Tech: Speech, action, habits and events of the Prophet's life codified by his companions and enlarged and revised by later Muslims. There is a large collection of Ahadith, the most authentic of which have been recorded in the six books

'ahd: Generally, a unilateral promise or an undertaking, although sometimes it also covers a bilateral obligation.

'ajalin: See *'ajal*.

ajam: non-Arab.

'akl al-mal bil-batil: Devouring the property of others illegally.

al-asl fi al-ashya'-i-ibahah: The phrase meaning that 'the norm for things is permissibility'.

al-kharaj bi al-daman: One can claim profit only if one is ready to take liability - to bear the business risk, if any.

Allah: The name for God in Islam. It is used by Arabic-speakers of all Abrahamic faiths, including Christians and Jews. The concept of Allah, is the only real supreme being, all-powerful and all knowing Creator, Sustainer, Ordainer, and Judge of the universe. There is no plural, masculine or feminine form of this word in Arabic. This denotes the One True God, the Almighty Creator, Who is neither male nor female. Islam puts a great emphasis on the conceptualisation of God as strictly singular (*tawhid*). God is unique (*wahid*) and inherently one (*ahad*), all-merciful and omnipotent. Islam teaches that Allah is the same God worshiped by the members of other Abrahamic religions such as Christianity and Judaism.

al-Nisa'/Sura al-Nisa': Literal meaning of *Nisa'*, is women and *Sura al-Nisa'* is the fourth chapter of the Qur'an, with 176 verses.

'aqd: Lexically, conjunction or to tie; legally, synonymous with the word "contract" in modern law. *'Aqd* is a central term in Islamic financial law and it may be divided into three types with reference to time of completion: (i) prompt (*al-'aqd al-munajjaz*), which is effected straight away; (ii) contingent (*al-'aqd al-mu'allaq*), is contingent to a condition attached; and (iii) deferred (*al-'aqd al-mudaf*) i.e., a deferment to a future date.

'aqd al-mu'allaq: see *al-'aqd*

'aqdal-mu'awadhah: A contract of exchange in which compensation is given against the goods or services received.

'aqd al-mudaf: see *al-'aqd*

'aqd al-munajjaz: see *al-'aqd*

'ajal: Period; duration for which delivery is delayed.

Awqaf: Plural of *waqf*, meaning charitable trust or testamentary trust. Also see *waqf*.

a'yan: Plural of *al-'ayn*.

'ayn: The corpus or substance of a thing. A thing present as distinguished from one that is absent at the time of the contract. In Hanafi terminology, it is a thing that is to be determined through weight or measure during a transaction of sale. It also refers to currency or ready money. *'ayn* is often contrasted with *dayn*.

'ayn al-hadirah: see *al-'ayn*

batil: Literally it means nullity or void. In *fiqh*, it is a juristic expression about something that is unlawful in substance as well as in description (*wasf*). The Hanafi jurists distinguish between *batil* and *fasid*, the latter stands for vitiated; irregular; or unenforceable. It denotes something which is not inherently void but has conditions or characteristics which make it void. A *fasid* contract can become valid only if the offending condition is removed from the contract. Other jurists do not distinguish between *batil* and *fasid*.

- bay‘:** Comprehensive term that applies to sale as well as many other transactions that are not strictly referred to as sales in positive law; bilateral contract; exchange.
- bay‘ al-’ajal:** See *bay‘ al-mu’ajjal*.
- bay‘ al-’ayn:** Sale of tangible objects such as goods (as opposed to sale of services or rights).
- bay‘ al-’ayn bi’l-’ayn:** In a sale immediate delivery of both the counter-values.
- bay‘ al-’ayn bi’l-dayn:** A sale in which the payment of price is deferred and becomes a debt on the buyer.
- bay‘ al-dayn:** Sale of debt or debt instruments.
- bay‘ al-dayn bi’l-dayn:** Sale of a debt for a debt or debt clearance sale.
- bay‘ al-fuduli:** An agreement of sale concluded by someone on the property of another without the permission of the latter.
- bay‘ al-gha’ib:** Sale of absent or concealed goods (without knowing their features/specifications).
- bay‘ al-’inah:** Double sale by which the borrower and the lender sell and then resell an object between them, once for cash and then for a higher price on credit, with the net result of a loan with interest.
- bay‘ al-istisna’:** See *istisna’*
- bay‘ al-kali’ bil-kali’:** Sale of one debt for another.
- bay‘ al-ma’dum:** Sale of non-existent objects.
- bay‘ al-maghsab:** Sale of a usurped object.
- bay‘ al-majhul:** Sale of the unknown.
- bay‘ al-mu’ajjal:** Literally, a credit sale. Technically, a financing technique adopted by Islamic banks. It is a contract in which the seller allows the buyer to pay the price of a commodity at a future date in lump sum or in instalments. The price fixed for the commodity in such a transaction can be the same as the spot price or higher or lower than the spot price. The concept is the same as *bay‘ bithaman ‘ajil*.
- bay‘ al-mu’atat:** See *bai‘ al-ta’ati’*.
- bay‘ al-mulamasah:** A form of sale prevalent in the days of the Prophet in which the buyer or the seller used to touch a piece of cloth and this very act of touching finalised the deal.
- bay‘ al-munabadhah:** A contract of sale prevalent in the days of the Prophet in which the seller or the buyer would throw a piece of cloth towards the other and this very act of throwing finalised the deal.
- bay‘ al-murabahah:** Sale at cost price plus a mutually agreed profit - bargaining on profit margin on the cost price. See *Murabahah*.
- bay‘ al-musawamah:** Literally: haggling, bargaining. Technically it is a sale of goods at a price on which the buyer and seller agree after haggling without mentioning the cost to the seller.
- bay‘ al-salam:** A contract in which advance payment is made for a delayed delivery of goods.
- bay‘ al-sarf:** Sale of gold, silver or other monetary units on both sides.
- bay‘ al-sifah:** Sale of goods by description.
- bay‘ al-ta’ati’:** A sales contract whereby the buyer picks up the goods and the seller accepts the price without any explicit bargain. It is also termed as *bai‘ al-mu’atat*.
- bay‘ bithaman ‘ajil:** This contract refers to the sale of goods on a deferred payment basis; a deferred payment sale.
- bay‘ muqayadah:** See *muqayadah*.
- bay‘ al-’urbun:** A sale of downpayment with the condition that if the buyer takes the commodity, the downpayment will become part of the selling price and if he does not purchase the commodity, the advance money will be forfeited.

buyu': Plural of bay'. See bay'.

daman: Literally; responsibility; guarantee; warranty; surety. Surety against and responsibility for all insurable risks as well as uncertainty. The *shari'ah* has made the responsibility of the entrepreneur to cover all these risks since he is the one who is entitled to the profit. There cannot accrue any lawful profit to someone who refuses to accept these risks.

dayn: Literally, debt; liability. Technically it is a liability created by a contract, expenditure or debt. Al-dayn has a definite term fixed for repayment as distinguished from *qard*, which does not have a fixed term for maturity.

daynin: See *dayn*.

daman: Guarantee, security. Taking responsibility - contact of guarantee; responsibility of entrepreneur/manager of a business.

dharoorah: Necessity; overriding necessity. Adopting a ruling, even one that may contravene a *shari'ah* rule, when one is compelled by extreme necessity, usually life or death (usually used for the "Doctrine of Necessity," whereby something otherwise prohibited becomes temporarily permissible).

dhimmah: Personal responsibility or obligation.

fa'idah: Utility; benefit.

faqih: (plural *fuaha*): Jurist who gives rulings on various juristic issues in the light of the Qur'an and the *Sunnah*.

fasid: See *batil*.

fass: Dice.

fatwa: A decree by a competent *shari'ah* scholar qualified to issue decrees (*mufti*) on a matter giving an opinion about the position of a matter in the light of the *shari'ah* rules and principles.

fiqh: Islamic jurisprudence. The science of the *shari'ah*. It is an important source of Islamic economics and finance.

fuduli: A person who is neither guardian nor agent, or if he is agent, he transgresses the limits prescribed by the principal in respect of a contract. See *bay' al-fuduli*.

fuqaha: Plural of *faqih*. See *faqih*.

ghabn: Misappropriation or defrauding others in respect of specifications of the goods and their prices.

ghalib: Winner.

gharar: Literally: hazard, chance or risk. Technically it is sale of a thing that is not present at hand; or the sale of a thing whose consequence or outcome is not known; or a sale involving risk or hazard in which one does not know whether it will come to be or not, or if the performance of obligations under an agreement is conditional on the occurrence or non-occurrence of a certain event (fall in currency exchange rate etc). Scholars have indicated following levels of *gharar* in a contract: (a) trifling *gharar* (*al-gharar al-yasir*), element of uncertainty is low and that is acceptable from the point of view of *shari'ah*; (b) average *gharar* (*al-gharar al-mutawassit*), the contract can be valid if certain conditions are met; and (c) excessive *gharar* (*al-gharar al-kathir*), the presence of which invalidates the contract.

gharar al-kathir: see *gharar*.

gharar al-yasir: See *gharar*.

gharm: Liability.

ghubn: The sale of the commodity with higher price than its price in excessive and overcharging, or buy the commodity lesser than its price.

habal al-habalah: A type of sale practiced by the Arabs during the *Jahiliyyah*, in which the essence of the agreement between the two transacting parties, depended on a pregnant she-camel giving birth to a female calf which would subsequently become pregnant itself. The *habal al-habalah* transaction was prohibited by the Prophet, according to several well-known reports, ostensibly because of the extreme uncertainty (see *gharar*) in the essence of the contract, given that neither of the contractual parties can be even remotely certain that a

pregnant she-camel would successfully give birth to another she-camel, which would subsequently mature and become pregnant itself.

habs: Inalienable property, the yield of which is devoted to pious purposes; religious bequest. An alternate term used for is *waqf*, mostly in North Africa. See also *waqf*.

hadith: See *ahadith*.

haqiqi: Original; real; true; genuine.

hassan: *Hasan* means good *hadith* but not on level of *sahih* only due to minor reasons.

hawalah: Literally: Bill of exchange, promissory note, cheque, draft. Technically a debtor passes on the responsibility of payment of his debt to a third party - contract of assignment of debt.

hibah: Literally: Gift, donation. Transfer of a determinate property (*mal*) without any material consideration.

Hidayah: The famous of book by Al-Marghinani of Hanafi school

hila: (plural *hiyal*): Literally it means legal device. Technically it is used in transactinos to circumvent the basic prohibitions.

hukm: (plural *ahkam*): In *Fiqh*, the *shari'ah* ruling (e. g. obligatory, recommendable, neutral, reprehensible, or forbidden) associated with any action.

'ibahah: Literally: permissibility. *'ibahah* refers to the rule that every economic transaction is *mubah* (permissible) unless expressly and specifically forbidden by the *shari'ah*

ibra' al-dayn: Release of debt.

'idah: Promise

'idat: (plural *'idah*): See *'idah*.

ijama': Consensus of the jurists of Islamic *fiqh* (*mujtahidun*) on a certain question in a certain age.

ijarah: Literally, letting on lease. Technically, sale of defined usufruct of any asset for a defined period in exchange of definite rent; only those assets can be leased the corpus of which is not consumed with use or the form/shape of which is not entirely changed with use..Commonly used for wages, it also refers to a contract of land lease at a fixed rent payable in cash. It is contrary to "Muzarah" when rent is fixed as a certain percentage of the produce of land.

ijarahmawsufah fi al-dhimmah: Forward leasing contract.

ijarah muntahiah bi-tamleek: Lease (*ijarah*) contracts that end up with transfer of ownership of leased assets to the lessee.

ijarahsukuk: A financial instrument issued in an *ijarah* financing arrangement.

ijarah wa iqtina': A mode of financing by way of hire-purchase, adopted by Islamic banks but different from conventional hire-purchase.

ijtihad: Independent or innovative legal reasoning or interpretation by qualified Islamic legal scholars to formulate a ruling on a given issue on the basis of evidence found in Islamic sources.

'illah: The attributer of an exchange or event that entails a particular Divine ruling cases possessing that attribute-cause of prohibition of specific exchange contracts. *'illah* is the basis for applying analogy for determining permissibility or otherwise of any transaction.

iltizam al-wa'ad: Binding promise.

imam: Leader; guide or ruler. Head of a religious community.

'inah: A sale in which a purchaser buys merchandise from a seller for a stipulated price on a deferred payment basis and then sells the same merchandise back to the original seller for a price lower than the original price.

irshad: Moral guidance.

istihsan: Relating to the sources of Islamic law, it is a deviation, on a certain issue, from the rule of a precedent to another rule for a more relevant legal reason that requires such deviation.

istisna': Contract of sale of specified goods that have to be manufactured before delivery is possible. Literal meaning is to manufacture or build. It is a contract of sale of a specified goods that can be sold before manufactured product comes into existence; an order to manufacture (for purchase) allowing the buyer to pay the price progressively in accordance with the progress of a job or project or against delivery in stages; takes the form of progressive financing.

'iwadh: Recompense or equivalent counter value in an exchange.

ja'ihah: Literally, calamity, ruin, epidemic, crop damage. Any calamity or accident beyond human control that causes loss to life or property.

jahalah: Ignorance, lack of knowledge; indefiniteness in a contract, non-clarity about the parties or their rights and obligations, the goods/subject matter or the price/consideration-leading to *gharar*.

jahalalah al-fahishah: Excessive ignorance of something.

jahl: See *jahalalah*.

Jumhur ulama': In accordance with opinion of the majority of scholars.

juzafan: As a lump sum.

ka'b or ka'bah: Dice.

kafil: Guarantor.

karahiyyah: Abomination; distaste for something.

kasb: Effort.

khaas: Specific or special.

khiyar: Literally option. A term used to express an option to rescind a contract of sales by either party within a certain period after the conclusion of a bargain. Its main types are: (a) *khiyar al-shart*, conditional option, where one of the parties stipulates certain conditions, failing to meet which would grant a right to the stipulating party an option to rescind the contract; (b) *Khiyar al-'aib*, the option to rescind the contract on discovery of a defect in the subject of sale; (c) *Khiyar al-ru'yah*, option of rejecting the thing purchased after seeing it.; (d) *Khiyar al-t'ayin*, where a person having purchased two or three things of the same kind, stipulates a period to make his selection; (e) *Khiyar al-majlis*, the condition of withdrawing from the contract while the two parties are still at the place of transaction; (f) *Khiyar al-naqd*, where the seller has the option to cancel the contract if the buyer does not pay cash up to a certain agreed date; (g) *Khiyar al-ghubn*, the option of the buyer to cancel the contract if the seller has sold it at a price higher than what an independent evaluator evaluates; (h) *Khiyar kashf al-hal*, the buyer's option to cancel the contract on knowing specifications of the product where a product is sold without specifications; (i) *Khiyar al-qabul*, the option to accept or reject a proposal, in a contract of sale, before the proposal is accepted, the option is surrendered by giving acceptance to the proposal; and (j) *Khiyar al-taghrir*, option to rescind the contract if the seller perpetrates a fraud causing loss to the buyer.

khiyar al-ru'yah: See *khiyar*

kifalah: Contract of surety; guarantee; bail; and posting a bond.

madhab: Juristic or theological school. A *fiqhi* school or orientation characterized by differences in the methods or approaches by which certain source-texts are understood and therefore differences in the *shari'ah* rulings which are deduced from them. There are four well known schools of Islamic jurisprudence of religious law in *Sunni* Islam associated with the classical jurists who founded them (Hanabali, Hanafi, Maliki and Shafi'i).

madhahib: See *madhhab*.

maghlub: Loser

majazi: Metaphorical.

Malikis: One of the four well-known schools of thought in Islamic Jurisprudence or religious law engaged in the interpretation of the Qur'an and *Sunnah*. Founded by one of the classical jurists, Imam Malik ibn Anas ibn Malik ibn Abi 'Amir al-Asbahi (d. 795 AD), followers are known as *Malikis*. Others are Hanbalis (Ahmad bin Muhammad bin Hanbal Abu 'Abd Allah al-Shaybani (d. 855 AD), Hanafis (founded by Nu'man ibn Thabit ibn Zuta ibn Marzuban d. 767 AD) and Shafis (founded by Abu 'Abd'illah Muhammad ibn Idris al-Shafi'i, d. 820 AD). Zahiri is another known school developed by Daud ibn Khalaf (d. 883 AD). The Jafri Shia' branch of Islamic school in Islamic jurisprudence was developed by Imam Ja'far al-Sadiq (d. 765) at about the same time its legal *fiqh* counterparts of Sunni branch of Islam were being codified. It was distinguished from Sunni law on matters regarding inheritance, religious taxes, commerce, and personal status.

maqasah: Clearance of mutual debts.

maqasid al-shari'ah: Literally: objectives of the *shari'ah*. It refers to the protection of life, religion, reason ('*aql*), progeny and property. These objectives also define basic needs in an Islamic economy.

maqdur al-Taslim: Able to be delivered.

maslahah: (plural: Masalih)It refers to unrestricted public interest (welfare) invoked to prohibit or permit something on the basis of whether or not it serves the public's benefit or welfare.

mawquf: Suspended, Stopped for a while.

maysir: An ancient Arabian game of chance played with arrows without heads and feathering, for stakes of slaughtered and quartered camels. It refers to all types of hazard and gambling - acquisition of wealth by chance/easily (without paying an equivalent compensation (*'iwad*) for it or without working for it, or without undertaking any liability against it). The word *maysir* derives from *yasira* means 'to be easy', and *yassara* means an easy success over something of value without any labour.

mi'ad: Promise

mu'amalat mu'ajjalah: Deferred transactions

mu'awadat: Exchange.

mudarabah: A form of business partnership in which one party contributes capital and the other personal effort. The financier is known as *rabb al-mal* and the worker or entrepreneur as *mudarib*.

Mudarabah al-muqayyadah: Literally: Conditional *mudarabah*. A contract of *mudarabah* in which certain conditions like place, season, commodities, credit and techniques of trade are stipulated by the provider of the capital (*rabb al-mal*).

mudarabah al-mutlaqah: Literally: Unconditional *mudarabah*. A contract of *mudarabah* that does not bind the entrepreneur about the place; time; season; commodities; credit or techniques of trade. These matters are left to the option of the entrepreneur. The *mudarabah* contract defines merely the profit-sharing ratio.

mudarabah certificate: A financial instrument devised by Islamic investment companies to mobilize funds for investment based on *mudarabah* contract.

mudarib: The partner in *mudarabah* providing entrepreneurship and management to a partner providing the capital.

mudayanah: Deferred liability contracts.

mukhatarah: A wagering contract or a risky contract. It applies to all those contracts which may bring a reward without any human effort or to contracts that involve non-business risks.

munqati': Broken.

muqamarah: Gambling.

muqayadah: Selling a commodity for another commodity. Barter exchange. Also known as *bay' al- muqayadah*.

murabahah: Literally it means a sale on mutually agreed profit. Technically, it is a contract of sale in which the seller declares his cost and the profit. See *bay' al murabahah*.

mursal: [of a *hadith*] disconnected.

musamah: Cost price.

musawamah: A general kind of sale in which the price of the commodity to be traded is bargained between the seller and the purchaser without any reference to the price paid or cost incurred by the former. See *bay' al-musawamah*.

musharakah: Literally: partnership; participation. It is a partnership between two parties, who both provide capital towards the financing of a project. Both parties share profits on a pre-agreed ratio, but losses are shared on the basis of equity participation. Management of the project is carried out by both parties. However, the partners also have a right to forego the right of management/work in favour of any specific partner or person. There are two main forms of *musharakah*: Permanent *Musharakah* and Diminishing *Musharakah*.

musharakah mutanaqisah: Form of partnership in which one of the partners promises (*wa'ad*) to buy the equity share of the other partner gradually until the title of the equity is completely transferred to him.

musharakah sukuk: *Sukuk* issued on the basis of *musharakah* contract. For the definition of *sukuk* see *sukuk*.

musharik: Partner in a *musharakah* partnership.

musnad: *hadith* with a continuous chain of narrators.

mustahab: In *fiqh* what is recommended, but not obligatory.

muwafiq al-qiyas: In accordance with norms.

muwatta': The *Muwatta'* is the first written collection of *hadith* comprising the subjects of Muslim law, compiled and edited by Imam Malik ibn Anas.

muzayadah: Literally, a public sale through auction in which the deal is struck with the highest bidder. Technically, a form of sale of a merchandise in which more than one seller is interested, and before the deal is finalized some of the prospective customers start bidding up the price without the intention of buying it. Also known as *bay' al-muzayadah*.

nahi: Prohibition.

nass: An Arabic word meaning clear texts of the *shari'ah* i.e., the Qur'an and *sunnah*.

nifadh: Effectiveness.

al-Nisa'/Sura al-Nisa': Literal meaning of *Nisa'*, is women and *Sura al-Nisa'* is the fourth chapter of the Qur'an, with 176 verses.

niyyah: Intent or intention while doing a job or action.

nudum pactum: Literally: a Latin phrase meaning "Bare or Naked Promise". In law it is a promise which is not legally binding for want of consideration.

nusus qat'iyah: Decisive injunctions.

paradeigma: Greek, argument created by a list of examples that leads to a probable generalised idea.

pari passu: At an equal pace; side by side.

qabd: Possession.

qabd al-haqiqi: Actual possession.

qard-e-hasan: Literally: a virtuous loan. A loan with the stipulation to return the principal sum in the future without any increase; in Islamic law, all loans have to be virtuous, as seeking any benefit from loaning amounts to *riba*.

qawa'id al-kulliyah al-fiqhiyyah: Salient legal maxims of *fiqh*.

qayd al-hisabi: Account records.

qimar: Literal meaning is gambling or game of chance. Technically it is an agreement in which possession of a property is contingent upon the occurrence of an uncertain event. By implication it applies to those agreements in which there is a definite loss for one party and definite gain for the other without specifying which party will gain and which party will lose.

qiyas: Literally it means to measure or compare for analogy. Technically, it means as derivation of the law on the analogy of an existing law if the basis ('*illah*) of the two is the same. It is one of the primary sources of Islamic law.

qur'ah: Throwing of lots.

Qur'an: The sacred book of Islam. The literal meaning is "the recitation". Muslims believe the Qur'an is God's final message to all of mankind. The Qur'an is a book which emphasises deed rather than idea. The rules laid down in The Qur'an are universal and not restricted to one ethnic group or a specific area or time.

Qur'anic: Related to Qur'an. See Qur'an.

rabb al- mal: investor; beneficial owner; sleeping partner. The person who invests the capital in a *shirkah*.

riba: Literally it means an excess or increase. Technically it is an increase which in a loan transaction accrues to the lender over time without giving an equivalent counter-value or recompense ('*iwad*) in return to the borrower.

riba al-nasi'ah: Increment on the principal of a loan payable by the borrower. It refers to the practice of lending money for any length of time on the understanding that the borrower would return to the lender at the end of this period the amount originally lent together with an increment in consideration of the lender having granted him time to pay. The increment is known as *riba al-nasi'ah*.

ribawi: Goods subject to *fiqh* rules on *riba* in sales – monetary units and items sold by weight and/or by measure, including gold, silver, paper currencies, edible goods like wheat, rice, barley, dates, salt, etc.

rihan: Literally it means pledge. Another meaning of *rihan* is betting.

rukun: Literally it means pillar (plural. Arkan). In *fiqh*, an integral part of an act, such as a transaction, without which the act can not be said to have been performed.

sabab: (plural, *asbab*) cause; means of obtaining something.

sadd al-dhara'i': Blocking the means to something.

sahih: valid; authentic.

sakk: (plural: *sukuk*). Literally it is an order of payment. Technically, it is certificate of equal value representing undivided share in ownership of tangible assets of particular projects or specific investment activity, usufruct and services.

salaf: Predecessors.

salam: A contract in which advance payment is made for a delayed delivery of goods.

sarf: Contract in which both exchange items are gold, silver or any monetary units.

sarf: see *bay' al-sarf*.

sha'n al-nuzul: Occasion of revelation.

Shafi'is: See *Malikis*

shari'ah: Literally: the way. Technically, divine guidance as given by the Qur'an and the *sunnah* of the Prophet; embodies all aspects of the Islamic faith, including beliefs and practice. It is generally spoken to mean the Islamic law.

shart al-nafadh: Condition of effectiveness.

shart al-sihhah: Condition of validity.

shirkah: Partnership; a contract between two or more persons who launch a business or financial enterprise with the purpose of making a profit. See also *musharakah*.

shirkah al-'aqd: Literally: contractual partnership. Technically, two or more persons may continue to carry on business on the condition that capital and profit will be shared among them. This is distinguished from *shirkah al-milk*, which is partnership in joint property.

shirkah al-milk: Literally: proprietary partnership. Technically, a proprietary partnership occurs when two persons inherit or purchase something together. Neither of them is permitted to dispose off the other's portion except with the other's permission. Each of them is considered a stranger in regard to the other's portion. If the property is divisible and the partners still decide to stick together, the partnership is termed *shirkah milk al-ikhtiyariyah*. However, if it is indivisible and the partners are constrained to stay together, the partnership is termed as *shirkah milk al-jabariyah*.

subhanahu wa ta'ala: glorious and exalted is He, placed after the name of Allah.

sukuk: See *sakk*.

sukukal-ijarah: *sukuk* issued in an *ijarah* financing arrangement.

sukuk al-istisna': *sukuk* issued in an *istisna'* financing arrangement.

sukukal-istithmar: Istithmar means "investment". A *sukuk al-istithmar* structure involves *ijarah* contracts (and the relevant underlying assets), *murabahah* receivables, and/or *istisna'* receivables (each generated by the originator), as well as shares and/or *sukuk* certificates to be packaged together and sold as an investment. The income generated by such investment can then be used to make payments to the investors under the *sukuk*.

sukuk al-mudarabah: *sukuk* issued in a *mudarabah* financing arrangement. *Sukuk al-mudarabah* in form can also be referred to *sukuk al-muqharadah*.

sukuk al-muqharadah: See *sukuk al-mudarabah*.

sukuk al-murabahah: *sukuk* issued in a *murabahah* financing arrangement.

sukuk al-musharakah: *sukuk* issued in a *musharakah* financing arrangement.

sukukal-salam: *sukuk* issued in a *salam* financing arrangement.

sukuk al-wakalah: *sukuk* issued in a *wakalah* financing arrangement.

sulh: Reconciliation; amicable settlement.

Sunan Abu Dawud: Collection of *ahadith* by Abu Dawud Sulayman ibn al-Ash'ath al-Azdi as-Sijistani (d. 889 AD).

sunnah: Literally: custom, habit or way of life. Technically, the sayings and living example of the Prophet Muhammad (peace be upon him) as recorded in the books of *hadith*. *Sunnah* is a legislative source along with the Qur'an and the *Qur'an* cannot be understood without the application of *Sunnah*.

ta'abbudi: Devotional.

ta'am: Foodstuffs.

ta'am al-mu'ayyan: Specified tangible foodstuffs.

tabarru': Literally: gift, donation. Technically, benefits given by a person to another without getting anything in exchange. Any voluntary provision of funds upon mutual consent of the parties. Voluntary payment to the lender in addition to the amount of the principal, made of the debtor's own accord, is also referred to as *tabarru'*.

tabarru'at: (plural: *tabarru'*).

tadayantum: Reciprocal deferred liability exchange.

tahrim: A complete ban; prohibited.

takaful: Literally: mutual or joint responsibility; solidarity; mutual agreement. Technically it is an alternative of the contemporary insurance in the Islamic framework based on the principle of *ta'awun* (mutual assistance). It provides for mutual assistance in cases of loss to life, assets and property and offers joint risk-sharing in the event of a loss incurred by one of the pool members.

takhliyah: Evacuation.

tamyiz: Identification.

- taqabud:** Literally: to possess. Technically *taqabud* is to take delivery of the object of sale and to pay its price in an agreement of sale.
- tawa'ud:** Exchange of promises.
- tawarruq:** A sales contract in which the buyer obtains merchandise on credit and then sells it at a loss to the original seller for cash. The purpose of such a transaction is to get cash and not to do business. It is condemned as a trick to give or to get an interest-bearing loan.
- tawliyah:** Sale at cost price.
- ta'yin:** Identification.
- ulama:** Scholars, Muslim scholars trained in Islam and Islamic law.
- 'uqud:** (plural: 'aqd). See 'aqd..
- 'urbun:** A non-refundable down payment or deposit paid by a buyer for the right to purchase goods at a certain time and certain price in future; if the right is exercised, it becomes part of the purchase price. If the buyer does not complete the purchase or backs out for any reason, the seller has the option to forfeit the deposit.
- 'urf:** Custom; usage.
- usul:** Principle.
- usul al-fiqh:** Roots of Islamic legal theory.
- wa'ad:** Promise; undertaking. A promise, such as is found in purchase and sale undertakings used in certain Islamic finance transactions; a promise to buy or sell certain goods in a certain quantity at a certain time in future at a certain price. It does not create contractual rights and obligationsö may be binding or unbinding.
- wa'az:** Warning; kindly admonition.
- wadi'ah:** Sale at lesser price than its cost.
- wajib:** Obligatory; compulsory; mandatory.
- wakalah:** Literally: representation, agency. Technically, it is a contract of agency in which a person delegates his business to another and substitutes the other in his own place. The latter is called the *wakil*, or agent, and the former is called *muwakkil*, or principal.
- wakil:** See *wakalah*.
- waqf:** Literally: retention. Technically *waqf* represents retention of a property in perpetuity for the benefit of a charitable or humanitarian objective, or for a specified group of people such as members of the donor's family. The *waqf* property can neither be sold nor inherited or donated to anyone.
- yad-e-amanah:** Trustee custody i.e. a trustee as a custodian is duty bound to safeguard the property held in trust.
- yasir:** Slight; insignificant; immaterial.
- yasira:** See *maysir*.
- yassara:** See *maysir*.
- zahir:** The apparent or literal meaning.
- zakah:** The compulsory levy on wealth for the poor imposed as a right of Allah.
- zulm:** Injustice, oppression, exploitation, encroaching upon the rights of anyone or usurping other's rights; not giving proper recompense in an exchange by way of any illegal act or coercion.

BIBLIOGRAPHY

- AAOIFI (2008). *Summary of Recommendations of AAOIFI's Shari'ah Committee in a series of meetings in 2007-08*, Newsletter, February 2008, available from www.aaofii.com/aaofii_sb_sukuk_Feb2008_Eng.pdf [Accessed 08/09/2012].
- AAOIFI, (2010). *Accounting, Auditing and Governance Standards for Islamic Financial Institutions: 1431H - 2010*. Manama, Bahrain: AAOIFI.
- ABDEL-KHALEQ, A. H., (2004). Legal Implications of Structuring and Offering *Shari'ah-Compliant Investment Products*. In: JAFFER, S., (ed) *Islamic Asset Management Forming the Future for Shari'ah-Compliant Investment Strategies*, London: Euromoney books.
- ABDEL-KHALEQ, A. H., (2009). *Musharakah Sukuk: Structures, Legal Framework and Opportunities*. In: THOMAS, A., (ed.). *Sukuk Islamic Capital Market Series, Securities Commission, Malaysia*, Sweet & Maxwell Asia, Kuala Lumpur, Malaysia.
- ABDULLAH, N. I., (2010). The Status of Promise (*Wa'ad*) and its Implication in Contemporary Islamic Banking. *Humanomics*, Vol. 26 Issue 2, pp.84 – 98.
- ABN AMRO (2003) *Cross-Border Securitisation Case Studies*, Presentation by David Kahm, at Conference: Korea Finance & Capital Markets, 4 September 2003, The Westin Chosun, Seoul, Korea available from <http://pages.stern.nyu.edu/~igiddy/ABS/ibbm/ABN%20Amro%20-%20Cross%20Border%20Securitization%20-%20Case%20Studies.pdf> [Accessed 15/07/2011]
- ABU DAWUD, S. I. A.-A. A.-S., (1984) *Sunan Abu Dawud*, Eng trans, HASSAN, A., Lahore: Ashraf Press, Book 23, Hadith No. 3496, Book 24, Hadith No. 3597, Book 41, 4977, online translation available from: <http://www.biharanjuman.org/hadith/sunan-abu-dawud-english.pdf> [Accessed 10/05/2012]
- ABU GHUDDAH, A. S., (2007). *Buhuth fi al-Mu'amalat wa al-Asalib al-Masrafiyyah al-Islamiyyah*, No.8. Jeddah, KSA: Majmu'at Dallah al-Barakah.
- ABU JAYB, S., (1988). *Al-Qamus al-Fiqhi Lugatan wa Istilahan*. Damascus: Dar al-Fikr.
- ABU ZAHRAH, M. (1957). *Uşul al-fiqh*, Cairo, Dar al-Fikr al-Arabi.
- ABUL- HASAN, A., (2001). *Mu'ajam al-Maqayis fi al-Lughah*, Beirut, Lebanon : Dar Ihya' al-Turath al-'Arabi.
- ADAM, N. J. and THOMAS, A. S. (2004). *Islamic Bonds: Your Guide to Issuing, Structuring and Investing in Sukuk*. London, Euromoney Books.
- AFRIQI, I. AL-, (1985). *Lisan Al Arab*, Dar Dader: Beirut.
- AGARWAL, Y. (2013). *Capital Structure Decisions Evaluating Risk and Uncertainty*. New York, Wiley.
- AHMAD, A. U. F. (2010a). *Developments In Islamic Banking Practice: The Experience Of Bangladesh*, Florida, Universal Publishers.
- AHMAD, A. U. F. (2010b). *Theory and practice of modern Islamic finance: the case analysis from Australia*. Boca Raton, Fla, BrownWalker Press.

- AHMED, A. AND AWAN, K.R., (1992). Introduction. In: AHMED, A. AND AWAN, K.R., (eds) *Lectures on Islamic Economics*, Jeddah, Saudi Arabia, Islamic Research and Training Institute, Islamic Development Bank.
- AHMED, H., (2006). Islamic Law, Adaptability and Financial Development, *Islamic Economic Studies*, Vol. 13(2), February 2006.
- AHMED, K. A., (2011). Sukuk: Definition, Structure and Accounting Issues, *Munich Personal RePEc Archive*, available from http://mpra.ub.uni-muenchen.de/33675/1/MPRA_paper_33675.pdf [Accessed 15/01/2012].
- AHMED; K., (1992) Nature and Significance of Islamic Economics. In AHMED A. AND AWAN K.R. (eds) *Lectures on Islamic Economics*, Jeddah, Saudi Arabia, Islamic Research and Training Institute, Islamic Development Bank.
- AINLEY, M., MASHAYEKHI, A., HICKS, R, RAHMAN, A. and RAVALIA, A., (2008). The Development of Islamic Finance in the UK. In: MILLAR R, ANWAR H (eds.) *Islamic Finance: A Guide for International Business and Investment*, GMB, London.
- AKERLOF, G. A., (1970). The Market for 'Lemons': Quality Uncertainty and the Market Mechanism. *The Quarterly Journal of Economics*, 84(3), pp. 488-500.
- Al-Baraka, (2002). Resolutions and recommendations on Al-Baraka Symposia for Islamic Economy, 1403-1422 H/1981-2001 G, 1st English ed, Dallah AlBaraka Group, Secretariat General of the Unified Sharia Panel, Published 2002 by Nadwat al-Barakah lil-Iqtisad al-Islami (Al Baraka Symposia on Islamic Economy) in [Jeddah].
- ALCHAAR, M. N., and SANDRA, A., (2009). *Islamic finance qualification (IFQ): the official workbook*. London, U.K., Securities & Investment Institute.
- ALDOHNI, A. K., (2011). *The Legal and Regulatory Aspects of Islamic Banking: A Comparative Look at the United Kingdom and Malaysia*. Milton Park, Abingdon, Oxon, [England], Routledge.
- Alhusen v. Prest* (1851) 6 Exch 720
- ALI, R., (2009). Legal Certainty for Sukuk. In THOMAS, A., (ed.). *Sukuk Islamic Capital Market Series, Securities Commission, Malaysia*, Sweet & Maxwell Asia, Kuala Lumpur, Malaysia, pp: 95-96.
- ALLEN, F. and KARJALAINEN, R., (1999). Using genetic algorithms to find technical trading rules, *Journal of Financial Economics*, 51, 245-271.
- ALSAYYED, N., (2009). *Shari'ah Parameters of Islamic Derivatives: Shari'ah Objectives vs. Industry Practitioners*, *International Sharia's Research Academy for Islamic Finance in Islamic Banking and Finance*, available from <http://www.kantakji.com/fiqh/files/finance/n362.pdf> [Accessed 21/02/2012].
- AMERICAN LAW INSTITUTE. (1981). *Restatement of the law, ...: contracts*. St. Paul, Minn, American Law Institute Publishers.
- AMINE, M. A.-B.M. AL-, (2008a). *Risk management in Islamic finance an analysis of derivatives instruments in commodity markets*. Leiden, Brill.

- AMINE, M. A.-B.M. AL-, (2008b). *Sukuk Market: Innovation and Challenges*, *International Journal of Islamic Financial Services*, Vol. 3, No. 1.
- AMINE, M. A.-B.M. AL-, (2012). *Global sukūk and Islamic securitization market: financial engineering and product innovation*. Leiden, Brill.
- ANDERSON, L. W., and BURNS, R. B. (1989). *Research in Classrooms: the Study of Teachers, Teaching, and Instruction*. Oxford, England, Pergamon Press.
- ANWAR, Z., (2009). *The Emerging Islamic Capital Markets*. In THOMAS, A., (ed.). *Sukuk Islamic Capital Market Series, Securities Commission, Malaysia*, Sweet & Maxwell Asia, Kuala Lumpur, Malaysia.
- 'ARABI, A. A. AL-, (n.d). *Aradat al-Ahwadhi bi-Sharh Sahih al-Tirmidhi*. Beirut: Dar al-Kutub al-'Ilmiyyah.
- ARB NOR, I. and BJERKE, B., (1997). *Methodology for Creating Business Knowledge*. 2nd Edition, Thousand Oaks, London and New Delhi: Sage Publications.
- ARCHER, S., ABDEL KARIM, R. A. (2007). *Islamic finance: the regulatory challenge*. Singapore, J. Wiley.
- Argy Trading Development Co. Ltd v. Lapid Developments Ltd [1977] 3 All ER 785
- ASHKER, A. A.-F. EL-, and WILSON, R., (2006). *Islamic Economics a Short History*, Leiden, Brill.
- ASHKER, A. A.-F. EL-, (1987). *The Islamic Business Enterprise*. London, Croom Helm.
- ASHRAF, M., (2012) *Principle to Practice - Islamic Economics* [WWW]. Available from <http://www.islamonline.com/news/articles/105/Principle-to-Practice--ISLAMIC-ECONOMICS.html> [Accessed 02/06/2012]
- ASKARI, H. (2010). *The Stability of Islamic Finance Creating a Resilient Financial Environment for a Secure Future*, Singapore, Wiley.
- ASKARI, H., IQBAL, Z., MIRAKHOR, A. (2009). *New issues in Islamic finance and economics: progress and challenges*. Singapore, John Wiley & Sons (Asia).
- ASKARI, H., IQBAL, Z., MIRAKHOR, A. (2010). *Globalization and Islamic finance: convergence, prospects and challenges*. Singapore, J. Wiley & Sons (Asia).
- 'ASQALANI, I. H. AL-, (1988). *Fath al-Bari Sharh Shaih al-Bukhari*. Beirut, Lebanon: Dar al-Ma'rifah.
- ASUTAY, M., (2007). A Political Economy Approach to Islamic Economics: Systemic Understanding for an Alternative Economic System, *Kyoto Bulletin of Islamic Area Studies*, Vol. 1, No. 2, pp. 3-18.
- ATIYAH, P., (1986). *Consideration: A Restatement, in Essays on Contract*, Oxford: Oxford University Press.
- 'ATTAR, A. A.-N. T. AL-, (1978). *Nazriyyah al-'ajal fi al-Iltizam fi'l Shari'ah al-Islamiyyah wa'l-Qawanin al-'Arabiyyah*. Cairo: Matba'ah al-Sa'adah.
- AVGOULEAS, E. (2012). *Governance of global financial markets: the law, the economics, the politics*. Cambridge, Cambridge University Press.

- 'AYNI, B. AL-, (n.d). *Umdat al-Qari*', *Sharh Sahih al-Bukhari*. Beirut, Lebanon: Idarat al-Tiba'ah al-Munirah.
- AYUB, M. (2007). *Understanding Islamic finance*. Hoboken, NJ, John Wiley & Sons.
- AYUB, M., (2005). Securitisation, Sukuk and Fund Management-Potential to be Realised by Islamic Financial Institutions. In: *Proceedings of the 6th International Conference Islamic Banking and Finance, Jakarta, Indonesia, 2005*, available from <http://www.kantakji.com/fiqh/Files/Markets/m151.pdf> [Accessed 07/06/2012].
- BABA, R., (2007). Islamic Financial Centres. In: HASSAN, K., and LEWIS, M. (eds). *Handbook of Islamic Banking*. Cheltenham, UK, Edward Elgar. P 384-400
- BACHA, O. I., (1999). Derivative Instruments and Islamic Finance: Some Thoughts for a Reconsideration, *International Journal of Islamic Financial Services* , Vol. 1, No. 1 (April 1999): pp. 9-25.
- BAGHAWI, A. M. A.-H. AL-, (1974). *Sharh al-Sunnah*. Damascus: Maktab al-Islami.
- Bailey v. Croft 4 Taunt 611 (1812)*.
- BAJI, A. A.-W. S. AL-, (1914). *Al-Muntaqa Sharh al-Muwatta*. Beirut: Dar al-Kitab al-'Arabi.
- BAJI, A. A.-W. S. AL-, (1999). *Al-Muntaqa Sharh al-Muwatta' Malik*. In: 'ATA, M. 'A. A.-Q. M(ed), Beirut: Dar al-Kutub al-'Ilmiyyah.
- Balfour v. Balfour* [1919] 2 KB 571
- BANAKAR R. AND TRAVERS M., (2005). *Theory and Method in Socio-Legal Research*, Oxford: Hart Publishing.
- BANK NEGARA MALAYSIA, (2009). Draft of Shari'ah Parameters, Reference 3: Mudarabah Contract, BNM, http://www.bnm.gov.my/documents/conceptpaper/attachment_mudarabah_contract.pdf [Accessed 21/02/2011].
- BARAZI, M., (2009). *The Lender of First Resort: A Handbook in Islamic Finance and Risk Management: Resilience and Best Practices; A Post Crisis Outlook*, Policy Research Papers, Volume 1 of the Lender of the First Resort, Beirut, DataInvestArabiaINC.
- Barclays Bank plc. v. Fairclough Building Ltd.* [1995] IRLR 605
- BELOUAFI, A. and BELABES, A., (2010) ISLAMIC FINANCE IN EUROPE: THE REGULATORY CHALLENGE, *Islamic Economic Studies*, Vol. 17 No. 2.
- BIGGAM, J., (2008). *Succeeding with your Master's Dissertation: A Step-by-Step Handbook*. Berkshire: Open University Press.
- Birmingham and District Land Co. v. London and North Western Rly Co.* (1888) 40 ChD 268
- BIS (2004). *The International Convergence of Capital Measurement and Capital Standards report* (Basel II) dated June 2004 by the BCBS, BIS, Switzerland.
- BIS (1988). *The International Convergence of Capital Measurement and Capital Standards Report* (Basel I) dated July 1988 by the BCBS, BIS, Switzerland.

- BLAXTER, L., HUGHES, C., TIGHT, M. (2006). *How to Research*. Berkshire, England, Open University Press.
- BOSSUYT, G., (2008), The Securitisation Process in Islamic Capital Markets Instruments. In: *Sukuk Summit, London* available at www.assaif.org/content/download/1063/7661/file/ [Accessed 02/05/2010]
- BRIAULT, O. B., (2000). *FSA Revisited, and Some Issues for European Securities Markets Regulation 2000*, London: Financial Services Authority.
- BROWN, K., HASSAN, M. K., SKULLY, M., (2007), Operational Efficiency and Performance of Islamic Banks, In HASSAN, K., & LEWIS, M. (eds). *Handbook of Islamic banking*. Cheltenham, UK, Edward Elgar.
- BRUYÈRE, R., & CONT, R. (2006). *Credit derivatives and structured credit: a guide for investors*. Chichester, England, John Wiley & Sons. p36
- BRUYÈRE, R., and CONT, R., (2006). *Credit Derivatives and Structured Credit: A Guide for Investors*. Chichester, England, John Wiley & Sons.
- BRYMAN, A., (2004). *Social Research Methods*. Oxford: Oxford University Press.
- BUKHARI, M. I. I. AL-, (2009). *Sahih al- Bukhari*, Eng trans., KHAN, M. M., In: AL ALMANY (ed.), 1st edition, Vol. 1, Book 2, *Hadith* No. 33, Vol. III, Book 34, *Ahadith*, 336, 338, 343, 345, Book 35, *Ahadith* No.441 and 443, pp. 19, 481-483 and 503, available at http://www.islamicbulletin.org/free_downloads/resources/sahih_bukhari.pdf [Accessed 24/04/2010].
- BURN, E.H. (2000). *Cheshire and Burn's Modern Law of Real Property*, 14th edn., London: Butterworths.
- BURTON, M. and BROWN, B., (2009). *The financial system and the economy: principles of money and banking*. Armonk, N.Y., M.E. Sharpe.
- Burton v. Brook* (1956) 6 DLR (2d) 464
- CAKIR, S. and RAEI, F., (2007). *Sukuk vs. Eurobonds: Is there a Difference in Value-at-Risk?* WP/07/237, IMF, Washington, D.C., Middle East and Central Asia Dept.
- Carr v. London and North Western Rly Co.* (1875) LR 10 CP 307
- CASELLI, S., and GATTI, S., (2005). *Structured Finance Techniques, Products and Market*. Berlin, Springer.
- CASEY, P., (2012) Regulatory Lessons on Sukuk Financial Products, an Opinion, In: ARIFF, M., IQBAL, M., and MOHAMAD, S., (eds). *The Islamic debt market for sukuk securities: the theory and practice of profit investment*. Cheltenham, Edward Elgar.
- Central London Property Trust Ltd v. High Trees House Ltd* [1947] KB 130
- CHANCE, D. M. and BROOKS, R. E., (2008). *An Introduction to Derivatives and Risk Management*, Mason, Ohio, Thomson/South-Western.
- CHANDRA, P., (1984). *Financial Management: Theory and Practice*. New Delhi, Tata McGraw-Hill.

- CHAPRA, M. U., (1985). *Towards a Just Monetary System: a Discussion of Money, Banking, and Monetary Policy in the Light of Islamic Teachings*. Leicester, UK, Islamic Foundation.
- CHAPRA, M. U., (2007). Challenges Facing the Islamic Financial Industry. In: HASSAN, K., and LEWIS, M. (eds). *Handbook of Islamic banking*. Cheltenham, UK, Edward Elgar.
- CHAPRA, U., (1992). *Islam and the Economic Challenge*, Leicester, UK, Islamic Foundation.
- CHEHATA, C., (1968). The Concept of Contract in Islamic Law, translated from, “Le Concept de contract en Droit Musulman”, 13 *Archives de Philosophie du Droit*, 129-136.
- CHOUDHRY, M., and LANDUYT, G., (2010). *The Future of Finance: A New Model for Banking and Investment*. Hoboken, N.J., Wiley.
- CHOUDHURY, M. M., (2008). Towards Principles based Financial Engineering, *Islamic Banker*, pp. 144-145.
- Civil Code of Iraq (1951)*.
- CIZAKCA, M., (2012). History of Islamic Public Finance: *Gharar* and Risk Aversion In: ARIFF, M., IQBAL, M., and MOHAMAD. S., (eds). *The Islamic Debt Market for Sukuk Securities: the Theory and Practice of Profit Investment*. Cheltenham, Edward Elgar.
- CLIFFORD CHANCE (2010) *Regulating Sukuk in the UK: the New Framework*, Clifford Chance, available from http://www.cliffordchance.com/publicationviews/publications/2010/01/regulating_sukukintheukthenewframework.html [Accessed 21/05/2011].
- Collin v. Duke of Westminster* [1985] QB 581.
- Combe v. Combe* [1951] 2 KB 215.
- Commercial Code of Bahrain (1987)*.
- CONRAD, C. (1993). *Qualitative Research in Higher Education: Experiencing Alternative Perspectives and Approaches*. Needham Heights, MA, Ginn Press.
- COOTNER, P. H., (1968). *Speculation, Hedging, and Arbitrage*. New York, Macmillan.
- CORNFORD, T. AND SMITHSON, S., (1996). *Project Research in Information Systems*, London: Macmillan.
- COURTNEY, D., & BETTELHEIM, E. C., (1986). *An Investor's Guide to the Commodity Futures Markets*, London, Butterworths.
- COVEY, S. R. (1990). *The Seven Habits of Highly Effective People: Restoring the Character Ethic*, New York, Fireside Book.
- COX, S., (2002). Islamic Asset Management: An Expanding Sector, *Review of Islamic Economics*, pp 27-50.
- COYLE, B. (2000). *Hedging Currency Exposures*, Financial World Publishing.
- COYLE, B. (2001). *Interest-Rate Swaps*. Canterbury, Financial World Publishing.
- CROUSHORE, D. D., (2007). *Money and Banking: A Policy-Oriented Approach*, Boston, MA, Houghton Mifflin Co.

Curie v. Misa (1875) LR 10 Ex 153 at 162

DAMAK, M., VOLLAND, E., MAHESHWARI, R., (2009). Sukuk Market Declined Sharply in 2008 but Long-Term Prospects Remain Strong. *Standard & Poor's*, London: Standard & Poor's.

DAR AL-ISTITHMAR, (2006). *Sukuk: An Introduction to the Underlying Principles and Structure*. Oxford: Darl-Al-Istithmar Ltd. Pp 31-69.

DAR, H. and TARIQ, A.A, (2007). Risks of Sukuk Structures: Implications for Resource Mobilisation. *Thunderbird International Business Review*, 49(2). pp 203-233, available from http://ipac.kacst.edu.sa/eDoc/2007/166319_2.pdf [Accessed 17/09/2010]

DAR, H., (2002). Growing Mainstream Relevance of Islamic Finance: A Critical Review of Recent Literature, *Review of Islamic Economics*, Vol. II, pp. 63-72.

DAR, H., (2005). Innovation in Islamic Finance: Marriage between Conventional and Islamic Contracts, *Islamic Finance News*, No. 7, available from www.islamicfinancenews.com [Accessed 26/09/2010].

DAR, H., (2007). Incentive Compatibility of Islamic Financing. In: HASSAN, K., and LEWIS, M. (eds). *Handbook of Islamic Banking*. Cheltenham, UK, Edward Elgar, pp 85-95.

DARIR, A.-S. M. A.-A. (1997). *Al-Gharar in Contracts and its Effects on Contemporary Transactions*, Jeddah, Islamic Research and Training Institute.

DARIR, A.-S. M. A.-A. AL-, (1967). *Al-Gharar wa Atharuh fi'l-'Uqud fi'l Fiqh al Islami*. Cairo: Dar al-Nashr al-Thaqafah.

DAS, S., (2009). *Perspectives on Financial Services*, Allied Publishers, New Delhi.

DATTATREYA, R. E., VENKATESH, R. E. S., and VENKATESH, V. E. (1994). *Interest Rate & Currency Swaps: The Markets, Products and Applications*, Chicago, Ill, Probus Pub. Co.

DAVIDSON, A. S., (2003). *Securitization: Structuring and Investment Analysis*, Hoboken, N.J., Wiley.

Davis v. Dodd (1812) 4 Taunt 602

DE BONO, E., (1973). *Lateral Thinking: Creativity Step by Step*, New York, Harper & Row, Publishers.

De La Bere v. Pearson Ltd. [1908] 1 KB 280

DEACON, J., (2004). *Global Securitisation and CDOs*, Chichester, Wiley.

DELANTY, G., (1997) *Social Science: Beyond Constructivism and Realism*, University of Minnesota Press, Minneapolis.

DELOITTE (2012) Luxembourg - A Prime Location for Sukuk Issuance, Luxembourg, Deloitte General Services at http://www.deloitte.com/assets/Dcom-Luxembourg/Local%20Assets/Documents/Whitepapers/2012/lu_en_wp_luxsukukissuance_09112012.pdf [Accessed 25/05/2012].

DELORENZO Y. T. and MCMILLEN M. J. T (2007) Law and Islamic Finance: An Interactive Analysis. In: ARCHER, S., and ABDEL KARIM, R. A. (eds). *Islamic Finance: the Regulatory Challenge*, Singapore, J. Wiley.

- DELORENZO, Y. T., (2007). *The Total Returns Swap and the Shari'ah Conversion Technology Strategem*, available from www.dinarstandard.com/finance/DeLorenzo.pdf [Accessed 19/07/2009].
- DEMETRIADES, P., (2003). *Central Banks and Prudential Regulations*, Chapter 5, Unpublished.
- Dent v. Bennett* (1839) 4 My & Cr 269
- DEUTSCHE BANK, (n.d). *Deutsche Bank, Pioneering Innovative Shari'ah Compliant Solutions*, Deutsche Bank Academic Paper, Deutsche Bank, available from https://www.db.com/medien/en/downloads/White_Paper.pdf [Accessed 16/06/2011].
- DIAS, R. W. M. (1985). *Jurisprudence*. London, Butterworths.
- DIDSBURY, H. F. (2004). *Thinking Creatively in Turbulent Times*. Bethesda, Md, World Future Society.
- DIFC, & CLIFFORD CHANCE, (2009). *Sukuk guidebook*. [Dubai], Dubai International Financial Centre.
- DIN, T. S. I. EL-, (2008). *The Capital and Money and Markets of Muslims: Theory and the Emerging Practice*, Unpublished, Markfield Institute of Higher Education.
- DIVANNA, J., Strategies, M., (2007). Will Islamic Banking Appeal to non-Muslims? In: *Convergence: New Directions in Islamic Finance?*, Arab Financial Forum, Harvard University, pp. 72-4.
- DORRIS, M. S. and POTENZA, V. A., (2004). *Securitization for Firs Time Issuers, Global Securitization and Structured Finance*, Globe White Page Ltd.
- DRUCKER, P., (1999). Innovate or Die, *The Economist*, available from <http://www.economist.com/node/242082> [Accessed 23/12/2011].
- DUALEH, S. A., (1998). Islamic Securitisation: Practical Aspects. paper presented at *World Conference on Islamic Banking*, Geneva, 8–9 July, available from <http://www.iefpedia.com/english/wp-content/uploads/2009/09/Islamic-Securitisation-Practical-Aspects.pdf> [Accessed 22/08/2009].
- Dubai Law of Contract* (1971).
- Durham Fancy Goods Ltd v. Michael Jackson (Fancy Goods) Ltd* [1968] 2 QB 839
- DUSUKI, A. W. and ABOZAID, A., (2008). Fiqh Issues in Short-Selling as Implemented in the Islamic Capital Market in Malaysia, *JKAU: Islamic Econ.*, Vol. 21 No. 2, pp: 63-78.
- DUSUKI, A. W., (2009). *Shari'ah Parameters on Islamic Foreign Exchange Swaps as a Hedging Mechanism in Islamic Finance*, *ISRA International Journal of Islamic Finance*, Vol. 1, Issue 1, Kuala Lumpur, Malaysia.
- DUSUKI, A. W., and ABOZAID, A., (2008). Fiqh Issues in Short-Selling as Implemented in the Islamic Capital Market in Malaysia, *Journal of King Abdulaziz Universitz: Islamic Economics*, Voll. 21, No. 2, Jeddah, KSA, pp. 63-78, available from http://www.kau.edu.sa/Files/320/Researches/54640_24959.pdf [Accessed 07/05/2010].

- DUSUKI, A. W., and MOKHTAR, S., (2010). *Critical Appraisal of Shari'ah Issues on Ownership in Asset-based Sukuk as Implemented in the Islamic Debt Market*, International Shari'ah Research Academy for Islamic Finance, Research Paper No : 8/2010, Kuala Lumpur, Malaysia.
- EFFROS, R. C., (1992). *Current Legal Issues Affecting Central Banks*, Washington, D.C., International Monetary Fund.
- Egyptian Civil Law (1948)*.
- ELFAKHAMI S. M., YAIB I. J., AHMED Y. U (2007) Marketing of Islamic Financial Products, In HASSAN, K., and LEWIS, M. (eds). *Handbook of Islamic banking*. Cheltenham, UK, Edward Elgar.
- ELGARI, M. A., (2006). *Shari'ah Injunctions on Futures Contracts*, *Islamic Finance News*, Vol 3, Issue 40.
- ELGARI, M. A., (2008). *Aliyyat al-Tahawwut fi al-'Amaliyat al-Maliyyah al-Islamiyyah*, AAOIFI, Bahrain.
- ELSTER, J., (2000). *Ulysses Unbound: Studies in Rationality, Pre-commitment, and Constraints*, Cambridge University Press.
- Evenden v. Guildford City Association Football Club Ltd [1975] QB 917 at 924, per Lord Denning MR and at 926 and 275 per Browne LJ
- FABOZZI, F. J., JONES, F. J. and JOHNSON, R. R., (2002). Common Stock. In: FABOZZI, F. J. (2002). *The Handbook of Financial Instruments*. Hoboken, N.J., Wiley, pp 67-118.
- FAROOQ, M. O. (2007). Stipulation of Excess in Understanding and Misunderstanding "Riba": the Al-Jassas Link. *Arab Law Quarterly*, 21, 285-316.
- FEDERAL RESERVE BANK OF CHICAGO, (2006). *Innovations in real estate markets: risks, rewards, and the role of regulation : the 42nd annual Conference on Bank Structure and Competition*. Chicago, Ill, Federal Reserve Bank of Chicago.
- FELL, L. (2000). *An introduction to financial products and markets*. New York, Continuum.
- FERGUSON, R. W., Jr., (2003). *Testimony before the Sub-committee on Domestic and International Monetary Policy, Trade and Technology, Committee on Financial Services*, U.S. House of Representatives, Washington D.C.”.
- FERRAN, E. (2008). *Principles of corporate finance law*. New York, Oxford University Press.
- FINK, R. E., (1988). *Futures Trading. Concepts and Strategies*, New York: New York Institute of Finance.
- FINNERTY, J., (1988). Financial Engineering in Corporate Finance: An Overview, *Financial Management*, Volume 17, pp. 14-33.
- FINNERTY, J., (1994). Financial Engineering. In: NEWMAN, P., MILGATE, M., and EATWELL, J. (eds.). *The New Palgrave Dictionary of Money & Finance*. [London] [etc.], MacMillan Press.
- FITCH RATINGS (2005). *Securitisation and Shari'ah Law*, Emerging Markets Special Report, Fitch Ratings.

- FITSELL, T., and WILLIAMS, R. (2007). *HSBC's guide to cash and treasury management in Asia Pacific 2008*. Hong Kong, PPP Co. Ltd.
- Four Oaks Estate Ltd v. Hadley* (1986) 83 Law LS Gaz 2326
- FRASER, J., and SIMKINS, B. J. (2010). *Enterprise risk management today's leading research and best practices for tomorrow's executives*. Hoboken, N.J., John Wiley & Sons.
- FRIED, C., (1981). *Contracts as Promise: A Theory of Contractual Obligations*, Cambridge, Mass, Harvard University Press.
- FSA, (2007). *Islamic Finance in the UK: Regulation and Challenges*, UK.
- FSMA, (2000). Available from <http://www.legislation.gov.uk/ukpga/2000/8/contents>. [Online] [Accessed 11/03/2011].
- GAMAL, M. A. EL- (2006a). *Overview of Islamic Finance, Department of the Treasury Office of International Affairs, Occasional Paper No. 4*, available from <http://www.nzibo.com/IB2/Overview.pdf> [Accessed 13/07/2009].
- GAMAL, M. A. EL-, (2002). *Islamic Finance: Law, Economic and Practice*, Cambridge University Press, Cambridge.
- GAMAL, M. A. EL-, (2004). *Limits and Dangers of Shari'ah Arbitrage* available from <http://www.ruf.rice.edu/~elgamal/files/Arbitrage.pdf> [Accessed 18/09/2010].
- GAMAL, M. A. EL-, (2006b). *Islamic finance: law, economics, and practice*. Cambridge [UK], Cambridge University Press.
- GAMAL, M. A. EL-, (2008). Introduction to Islamic Finance. In: FABOZZI, F. J., (ed). *Handbook of Finance Financial Markets and Instruments*, Vol.1, Hoboken, John Wiley & Sons.
- GANNON, P. (2009). *Business Knowledge It in Islamic Finance*, London, Essvale Corp.
- GB HM REVENUE & CUSTOMS (2008). *Stamp Duty Land Tax Commercial Sukuk*, Consultation Document, HM Treasury, June 2008.
- GB HM Revenue and Customs, (2008). *Stamp Duty Land Tax: Commercial Sukuk*, Consultation Document.
- GB HM TREASURY (2007). *Meeting the Aspirations of the British People: 2007 Pre-Budget Report and Comprehensive Spending Review*. London, Stationery Office.
- GB HM TREASURY (2007a) *Government Sterling Sukuk Issuance: a Consultation*, London, Debt Management Office, HM Treasury.
- GB HM TREASURY, (2008a). *Government Sterling Sukuk Issuance: A Response to the Consultation*. London, Debt Management Office, HM Treasury.
- GB HOUSE OF LORDS, (2010). *The Future Regulation of Derivatives Markets is the EU on the Right Track? : 10th Report of Session 2009-10 : Report with Evidence*, HL Paper 93, 10th Report of Session 2009-10, London, Stationery Office Ltd., House of Lords. <http://www.publications.parliament.uk/pa/ld200910/ldselect/ldcom/93/93.pdf> [Accessed 11/07/2011].

- GHAMRAWI, M. A.-Z. AL-, (n.d). *Al-Siraj al-Wahaj ala Matan al-Minhaj li al-Nawawi*, Al-Maktabah al-Shamilah, available at www.al-islam.com [Accessed 16/02/2012].
- GHAZALI, A. H. M. I. M. AL-, (1996). *Ihya' 'Ulum al-Din*. Beirut, Lebanon: Dar ul-Kutub al-'ilmiyyah.
- GIBBS, G. R., (2002). *Qualitative Data Analysis: Exploration with NVivo*, Buckingham: Open University Press.
- GIDDENS, A., (2000). *Runaway World: How Globalization is Reshaping our Lives*, London, Profile Books.
- GIGERENZER, G., TODD P. M. and THE ABC RESEARCH GROUP, (1999). *Simple Heuristics that Make Us Smart*, New York, Oxford University Press.
- Gilbert Steel Ltd v. University Construction Ltd* (1976) 12 OR (2d) 19
- GITMAN, L. J., and MCDANIEL, C. D., (2008). *The Future of Business: the Essentials*. Mason, OH, Thomson South-Western.
- GLUDER, D., (2006) Regulatory Impact of Synthetic Securitisation. In: WATSON, R. and CARTER, J. (eds). *Asset Securitisation and synthetic Structures: Innovations in the European Credit Markets*. London, Euromoney Books.
- GODDARD, G. J., and MARCUM, B. (2012). *Real estate investment: a value based approach*. Berlin, Springer.
- GOFF, R., (1987). Judge, Jurist and Legislature. *Denning Law Journal*, Volume 79, p. 92.
- GORDON, R. W., (1993). Lawyers, Scholars, and the "Middle Ground". *Michigan Law Review*. 91, 2075-2112.
- GOYAL, R (n.d). *Basel III Accord - Basel 3 Norms*, available from <http://www.allbankingsolutions.com/Banking-Tutor/Basel-iii-Accord-Basel-3-Norms.shtml> [Accessed 24/12/2012].
- GRAHAM, J. R., SMART, S. B., and MEGGINSON, W. L. (2010). *Corporate finance: [linking theory to what companies do]*. Mason, OH, South-Western Cengage Learning.
- GRAIS, W., and KLATHUNGA, A., (2006). Capital Structure and Risk in Islamic Financial Services. In: ARCHER, S. and ABDEL KARIM, R. A., (eds.) *Islamic Finance: The Regulatory Challenge*, Singapore: John Wiley & Sons.
- GRAIS, W., and PELLEGRINI, M. (2006). *Corporate Governance in Institutions Offering Islamic Financial Services: Issues and Options.*, World Bank Policy Research Working Paper 4052, [Washington, D.C.], World Bank, Financial and Private Sector Development Network.
- GREUNING, H. V. and IQBAL, Z., (2008). *Risk Analysis for Islamic Banks*, Washington, D.C., World Bank.
- GREUNING, H. V. and BRATANOVIC, S. B., (2009). *Analyzing Banking Risk: a Framework for Assessing Corporate Governance and Risk Management*. Washington, D.C., World Bank.p123
- GURULKAN, H (2010) *Islamic Securitization, A Legal Approach*, Unpublished Dissertation (LL.M) Johann Wolfgang Goethe University, Frankfurt am Main.

- HAAN, J. D., OOSTERLOO, S. and SCHOENMAKER, D., (2009). *European financial markets and institutions*. Cambridge, UK, Cambridge University Press.
- HAJDUKOVIC, D., (2008). *Shari'ah Financing Alternatives on the London Stock Exchange*, (Presentation), June 25-26, London.
- Hamer v. Sidway* (1891) 2 AC 234
- HAMMAD, N., (2008). *Mu'jam al-Mustalahat al-Muliyah wa al-Iqtisadiyyah fi Lughat al-Fuqaha'*, Dar al-Qalam, Damascus.
- HAMOUD, S. H., (1981). *Tatwir al-'Amal al-Masrafiyyah bima Yattafiq wa al-Shari'ah al-Islamiyyah*, Oman: Matba'ah al-Sharq.
- HANEEF, R., (2009). *From Asset-Backed to Asset-Light Structures: The Intricate History of Sukuk*, Dar al-Qalam, Damascus.
- HANSMAN, H., (1996). *The Ownership of Enterprise*, Harvard University Press.
- Harran, S, A.-S. AL-, (1993). *Islamic Finance: Partnership Financing*, Petaling Jaya, Selangor DarulEhsan, Malaysia, Pelanduk Publications.
- HART, J. A. and PRAKASH, A., (2000). Responding to Globalization: A Conclusion. In: HART, J. A., & PRAKASH, A. (eds) *In Responding to globalization*, London, Routledge.
- Hartley v. Hymans* [1920] 3 KB 475
- HASAN, A. M. A., (1986). *'Amal Sharikat al-Istithmar al-Islamiyyah fi al-Suq al-'Alamiyyah*, Jeddah: al-Dar al-Sa'udiyyah li'l-Nashr wa'l-Tawzi'.
- HASAN, A., (2010). Islamic Structured Products: Issues and Challenges. In: VENARDOS, A. M., (2010). *Current Issues in Islamic Banking and Finance Resilience and Stability in the Present System*. Singapore, World Scientific, pp 189-228.
- HASSAN A. A. H. (1997). *Sales and Contracts in Early Islamic Commercial Law*. New Delhi, Kitab Bhavan.
- HASSAN, A., (1978). *The Doctrine of Ijma' in Islam*. Islamabad, Pakistan: Islamic Research Institute.
- HASSAN, A., (1986). *Analogical Reasoning in Islamic Jurisprudence: A Study of the Juridical Principle of Qiyyas*, Islamabad, Pakistan: Islamic Research Institute.
- HASSAN, F., (2012). Islam: A Religion of Tolerance or Terrorism (An Analytical and Critical Study), *Interdisciplinary Journal of Contemporary Research in Business*, Vol. 3, No. 10, Feb 2012.
- HASSAN, H. AND IRFAN, H., (2006). In RHODES, T., (ed) *Euromoney Encyclopedia of Debt Finance*, London, Euromoney Books.
- HASSAN, K., and LEWIS, M., (2007). *Handbook of Islamic Banking*, Cheltenham, UK, Edward Elgar.
- HASSAN, K., and MAHLKNECHT, M., (2011). *Islamic Capital Markets: Products and Strategies*, Chichester, West Sussex, U.K, Wiley.

- HASSARD, J., KELEMEN, M., and COX, J. W. (2008). *Disorganization Theory: Explorations in Alternative Organizational Analysis*. London, Routledge.
- HATTAB, M. I. M. AL-, (1969). *Mawahib al-Jalil li-Sharh al-Mukhtasar Khalil*, Tarabulus, Libya: Maktabah al-Najah.
- Hedley Byrne & Co. Ltd. v. Heller & Partners Ltd* (1964) AC 465
- Henderson v. Merrett Syndicates Ltd* (1995) 2 AC 145
- HESSE, H., JOBST A. A., SOLE, J., (2008). Trends and Challenges in Islamic Finance, *World Economics*, Vol. 9, No.2.
- HITTI, E. E., (2007). *Basic Mechanics of Islamic Capitalism*, Hong Kong, ArabCham Publications.
- HOOKER, M. B., (2008). *Indonesian Syariah: Defining a National School of Islamic Law*. Singapore, Institute of Southeast Asian Studies.
- HOUSBY, E. S., (2011). *Islamic financial services in the United Kingdom*. Edinburgh, Edinburgh University Press. Great Britain.
- HSU, L. and MOHEBBI, C., (2001). Credit Enhancement in ABS Structures. In: FABOZZI, F. J. (ed). *Accessing Capital Markets through Securitization*. New York, Frank J. Fabozzi Associates: New Hope, Pennsylvania.
- Hughes v. Metropolitan Rly Co* (1877) 2 App Cas 439
- IBN 'ABIDIN, M. A. (1966). *Hashiyyat al-Radd al-Mukhtar 'ala'l Durr al-Mukhtar*. 2nd edn., Cairo: Matba' al-Babi al-Halab.
- IBN AL-HUMAM, K. A.-D. M., (1970). *Fath al-Qadir lil 'ajiz al Faqeer*. Cairo: Mustafa al-Babi al-Halabi.
- IBN HANBAL, A. I. M., (1985). *Fihris Ahadith Musnad al-Imam Ahmad b. Hanbal*. Compiled by Abu Hajir Zaghlul, Beirut: Dar al-Kutub.
- IBN HANBAL, A. I. M., KHATTAB, N., and KHATTAB, H. (2012). *English translation of Musnad Imam Ahmad bin Hanbal*. Riyadh, Darussalam.
- IBN HAZM, M. 'I. A., (1988). *Al-Muhalla bi al-Athar*. Beirut, Lebanon: Dar al-Kutub al-'Ilmiyyah.
- IBN JUZAY, M. I. A. A.-G., (1975). *Qawanin al-Ahkam al-Shari'iyah*, Cairo: 'Alam al-Fikr.
- IBN MAJAH, M. I. Y. A.-D. A. M. A.-M., (1981). *Sunan Ibn Majah*, Istanbul: Cagri Yayinlari.
- IBN MANZUUR, M. I. M., (1955). *Lisan al-'Arab*. Bayrut, Dar Sadir.
- IBN QAYYIM AL-JAWZIYAH, M. I. A. B., (1968). *Ilam al-Muwaqqi'in `an Rabb al-'Alamin*, Cairo: Maktabah al-Kulliyat al-Azhariyyah.
- IBN QAYYIM AL-JAWZIYAH, M. I. A. B., (1990). *Al-Furusiyah. Muhammad Nizam al-Fatih ed. Madinah Munawarah*: Maktabah Dar al-Turath.
- IBN QUDAMA, M. A.-D. A. M. A.-M., (1969). *Al-Mughni*. Cairo: Maktabah al-Qahirah.

- IBN RUSHD, A. A.-W. M. I. A. (1982). *Bidayat al-Mujtahid Wa Nihayat al-Muqtasid*. 7th ed. Damascus: Dar al- Ma'rifah.
- IBN TAYMIYYAH, A. A. ,. A. I. ,.-H., (1977). *Majmu'ah Fatawa. Beirut:Mu'assasah al-Risalah*. Compiled by 'Abd al-Rahman bin al-Qasim, Beirut: Mu'assasah al-Risalah.
- IBN TAYMIYYAH, A. A. ,. A. I. ,.-H., (1899). *Nazariyyah al-al'Aqd*. Beirut: Dar al Ma'rifah .
- IBN TAYMIYYAH, A. A. ,. A. I. ,.-H., (1997). *Biyān al-Dalil Fi Butlan al-Tahlil*, Al-Maktab al-Islami.
- IBP (2010), *Islamic Financial Institutions (Banks and Financial Companies) Handbook*, 4th ed, Washington DC USA: International Business Publications.
- IDB, (1995). *Tabung Haji as an Islamic Financial Institution: the Mobilization of Investment Resources In an Islamic Way and the Management of Hajj : the Organization of the Pilgrims Management and Fund Board of Malaysia*. IDB Prizewinners' Lecture Series No. 4, Jeddah, Saudi Arabia, Islamic Research and Training Institute, Islamic Development Bank.
- IDB, (2000). *Resolutions and Recommendations of the Council of the Islamic Fiqh Academy 1985-2000, Jeddah (Saudi Arabia)*. Jeddah, Islamic Development Bank.
- IDB, (2003). *29 Annual Report-Islamic Development Bank*. [Jeddah], Islamic Development Bank.
- IFSB, (2005). *Capital Adequacy Standard for Institutions (other than Insurance Institutions) Offering Islamic Financial Services*, A Report by the Islamic Financial Services Board, Malaysia: IFSB, Dec 2005.
- IFSB, (2007). *Capital Adequacy Requirements for Sukuk Securitisation and Real Estate Investment*, Exposure Draft, Malaysia: IFSB, Dec 2007.
- IFSB, (2009). *Capital Adequacy Requirements for Sukuk, Securitisations and Real Estate Investment*. Malaysia: IFSB.
- IFSL Research, (2008). *Islamic Finance 2008*, International Financial Services London, available from www.ifsl.org.uk/research.
- IIFM, (2001-2010). *Sukuk Issuance Database (2001-2010)*.
- IMESON, M., (2008). Worldwide ?Ethical Banking, Islamic-Style, *Financial World*, February 2008, available from http://fwarchive.ifslearning.ac.uk/financial_world/Archive/2008/2008_02feb/Features/islamic_banking/13785.cfm [Accessed 17/09/2011].
- IMF, (1998). *World Economic Outlook and International Capital Markets, Interim Assessment*. Washington, D.C., International Monetary Fund.
- IOSCO, (2004). *Islamic Capital Market Fact Finding Report of the Islamic Capital Market Task Force*, Report of the Islamic Capital Market Task Force of the International Organisation of Securities Commission, available from <http://www.iosco.org/library/pubdocs/pdf/IOSCOPD170.pdf> [Accessed 09/07/2009].
- IQBAL, J. (2009). *Islamic Financial Management*. New Delhi, India, Global Vision Pub.House.

- IQBAL, M. and KHAN, T., (2005). *Financial Engineering and Islamic Contracts*. Basingstoke: Palgrave MacMillan.
- IQBAL, M. and MOLYNEUX, P., (2005). *Thirty Years of Islamic Banking: History, Performance, and Prospects*. Houndmills: Palgrave Macmillan.
- IQBAL, M., (2011). Development, History and Prospects of Islamic Banking. In: ARIFF, M. and IQBAL, M. (eds). *The Foundations of Islamic Banking: Theory, Practice and Education*. Cheltenham, [U.K.], Edward Elgar.
- IQBAL, M., and LLEWELLYN, D. T., (2002). Introduction. In: IQBAL, M., and LLEWELLYN, D. T. (eds) *Islamic Banking and Finance: New Perspectives on Profit Sharing and Risk*. Cheltenham, UK, Edward Elgar in association with International Association of Islamic Economics, Islamic Development Bank [and] The Islamic Foundation.
- IQBAL, Z. and MIRAKHOR A., (2007). *An Introduction to Islamic Finance Theory and Practice*. Singapore: John Wiley and Sons (Asia) Pvt. Ltd.
- IQBAL, Z. and TSUBOTA, H., (2006). Emerging Islamic Capital markets – A Quickening Pace and New Potential, *The Euromoney International Debt Capital Markets Handbook*, London: Euromoney Institutional Investor PLC available from http://treasury.worldbank.org/cmd/pdf/Euromoney_2006_Handbook_International_Debt_Capital_Markets.pdf [Accessed 18/10/2011].
- IQBAL, Z., and MIRAKHOR, A. (2007). *An Introduction to Islamic Finance: Theory and Practice*. Singapore, John Wiley & Sons (Asia).
- ISARD, P., (2005). *Globalization and the International Financial System: What's Wrong and What Can Be Done*. Cambridge: Cambridge University Press.
- Islamic Fiqh Academy, (2000). *Resolutions and Recommendations of the Council of the Islamic Fiqh Academy 1985-2000, Jeddah (Saudi Arabia)*, Jeddah: Islamic Research and Training Institute, Islamic Development Bank.
- JABEEN, Z and JAVED, M. T., (2007). *Sukuk-Structures: An Analysis of Risk-reward Sharing and Wealth Circulation*, *The Pakistan Development Review*, 46 : 4 Part II (Winter 2007) pp. 405–419.
- JAIN, B. A., (2001). Promoting Securitisation in Emerging Economics. In: FABOZZI, F. J. (ed). *Accessing Capital Markets through Securitization*. New York, Frank J. Fabozzi Associates: New Hope, Pennsylvania.
- JAMALDEEN, F., and FRIEDMAN, J. (2012). *Islamic Finance for Dummies*, Hoboken, N.J., Wiley.
- James v. Heim Gallery (London)* [1980] 2 EGLR 119
- JANIN, H., and KAHLMEYER, A. (2007). *Islamic Law: the Shari'ah from Muhammad's Time to the Present*. Jefferson, NC, McFarland & Co.
- JARHI, M. A. AL-, (2002). Transactions in Conventional and Islamic Economics. In: Theoretical Foundations of Islamic Economics, Ahmed H.. Jeddah, Saudi Arabia : Islamic Research and Training Institute.

- JARHI, M. A. AL-, (2005). *Islamic Banking and Finance in the 21st Century: The Way Ahead*. In: ANWAR, M., and HANEEF, M. A., (EDS). *Studies in Islamic banking and finance in the 21st century: theory and practice*. Kuala Lumpur, Malaysia, Kulliyah of Economics and Management Sciences, International Islamic University Malaysia.
- JARHI, M. A. AL-, (2009). *Emirates Islamic Bank Report*, UAE, March.
- JASSAS Al-Razi, A. B. A., (1985). *Ahkam al-Qura'n*. Beirut, Lebanon: Dar al-Kitab al-'Arabi.
- JOBST, A., and SOLÉ, J. (2012). *Operative Principles of Islamic Derivatives Towards a Coherent Theory*, Washington, D.C.: International Monetary Fund.
- JOBST, A.A. (2007), "The economics of Islamic Finance and securitization", *Journal of Structured Finance*, vol. 13, No. 1.
- JOHNSON, P. and Duberley, J., (2000). *Understanding Management Research*, London, Sage Publications.
- JOHNSON, R. S. (2013). *Debt Markets and Analysis*, Hoboken, N.J., Bloomberg Press.
- JOMADAR, B. K., (2007). *Islamic Finance and Securitisation: Man-Made Tale or Reality*, *Islamic Law and Law of the Muslim World*, New York Law School Research Paper Series 08-18, University of Westminster-School of Law, available from http://papers.ssrn.com/sol3/papers.cfm?abstract_id=1093064 [Accessed 03/09/2011].
- JOMO, K. S., (2010). *Reforming the International Financial System for Development*, New York, N.Y., Columbia University Press.
- JONG, F. D., and RINDI, B. (2009). *The Microstructure of Financial Markets*, Cambridge, Cambridge University Press.
- Jorden v. Money* (1854) 5 HL Cas 185
- Joscelin v. Shelton* (1557) 3 Leon 4
- JUNDI, M. A.-S. AL-, (1988). *Mu'amalat al- Bursah fi'l-Shari'ah al-Islamiyyah*. Cairo: Dar al-Nahdah al-'Arabiyyah.
- JURJANI, ' I.-M. A. AL-, (1909). *Kitab al-Ta'rifat*. Istanbul: al-Astanah.
- KAMALI, M. H., (1991). *Principles of Islamic Jurisprudence*. Cambridge: Islamic Texts Society.
- KAMALI, M. H., (1997). *Islamic Commercial Law: An Analysis of Options*, *American Journal of Islamic Social Sciences*, Vol. 14, No. 3.
- KAMALI, M. H., (1999). *Prospects for an Islamic Derivatives Market in Malaysia*, *Thunderbird International Business Review*. 41, No. 5, pp 523-540.
- KAMALI, M. H., (2004). *Equity and Fairness in Islam*, Cambridge: Islamic Texts Society.
- KAPETANOVIC, H. and BECIC, M., (2009). *Mudarabah Sukuk: Essential Islamic Contract, Application and Way Forward*. In: THOMAS, A., (ed.). *Sukuk Islamic Capital Market Series, Securities Commission, Malaysia*, Sweet & Maxwell Asia, Kuala Lumpur, Malaysia.
- KAPNER, K. R. and MARSHALL, J. F., (1990). *The Swaps Handbook: Swaps and Related Risk Management Instruments*, New York, New York Institute of Finance.

- KASANI, M. I.-A. A. AL-, (1910). *Badai' al-Sanai' fi Tartib al-Shara'i'*. Cairo: Matba' al-Jamaliyyah.
- Kelner v. Baxter* (1866) LR 2 CP 174
- KELSEN, H. (1961). *General Theory of Law and State*. Eng Trans. Wedberg, A., Cambridge: Harvard University Press, USA.
- KETTELL, B., (2010a). *Frequently Asked Questions in Islamic Finance*, Hoboken, N.J., Wiley.
- KETTELL, B., (2010b). *Islamic Finance in A Nutshell: A Guide for Non-Specialists*, Chichester, Wiley.
- KETTELL, B., (2011a). *Case Studies in Islamic Banking and Finance Case Questions & Answers*, Chichester, East Sussex, Wiley.
- KETTELL, B., (2011b). *The Islamic Banking and Finance Workbook Step-By-Step Exercises to Help You Master the Fundamentals of Islamic Banking and Finance*. Chichester, U.K., Wiley.
- KHALIFA, L. A. A. AL-, (2007). *Foreign direct investment in Bahrain*. Leeds, University of Leeds.
- KHAN, A., and HILDRETH, W. B., (2004). *Financial Management Theory in the Public Sector*, Westport, Conn, Praeger.
- KHAN, I., (2001). Issues and Relevance of Islamic Finance in Britain, *New Horizon*, (111), August 2001.
- KHAN, M. A., (1988). Commodity Exchange and Stock Exchange in an Islamic Economy, *The American Journal of Islamic Social Sciences*, Vol. 5, No. 1.
- KHAN, M. A., (1994). *An Introduction to Islamic Economics*, Islamabad, International Institute of Islamic Thought and Institute of Islamic Studies.
- KHAN, M. F, and PORZIO, M. (2010). *Islamic banking and finance in the European Union a challenge*. Cheltenham, UK, Edward Elgar.
- KHAN, M. Y., (2008). *Financial Services*. New Delhi [u.a.], Tata McGraw-Hill.
- KHAN, N. A., (2011). *Islamic Financing Discussion, The Market for Sukuk Bonds*, Report Corporates & Markets-DC Bonds, Commerzbank.
- KHAN, T. and AHMED, H., (2001). *Risk Management: An Analysis of Issues in Islamic Financial Industry*, Jeddah, Islamic Development Bank, Islamic Research and Training Institute.
- KHATIB, A. A.-K. AL-, (1976). *Al-Siyasah al-Maliyyah fi'l-Islam wa Sillatuha bi'l-Mu'amat al-Mu'asarah*. 2nd edn., Cairo: Dar al-Fikr al-'Arabi.
- KHATTABI, A. H. H. AL-, (1949). *Ma'lim al-Sunan*. In: FAQI, M. H. AL-, (ed) Cairo: Matba'ah al-Sunnah al-Muhammadiyah .
- KHORSHID, A., (2009). *Euromoney Encyclopedia of Islamic Finance*. London, Euromoney Books.
- KLEIN, E. (2005). *Stock Exchanges, IPO's and Mutual Funds*, New York, Nova Science Publishers.

- KLEIN, P. J. and IAMMARTINO, B. R., (2010) *Getting Started in Security Analysis*, 2nd edn., John Wiley & Sons.
- KOTHARI, V. (2006). *Securitization: the financial instrument of the future*. Singapore, John Wiley & Sons (Asia).
- KOTHARI, V., and KOTHARI, V. (2009). *Credit Derivatives and Structured Credit Trading*, Singapore, John Wiley & Sons (Asia).
- KRICHENE, N. (2013). *Islamic Capital Markets : Theory and Practice*. Singapore, John Wiley & Sons Singapore Pte Ltd.
- KUHN, T. S. (1962). *The Structure of Scientific Revolutions*. Chicago, University of Chicago Press.
- KUHN, T. S. (1977). *The Essential Tension: Selected Studies in Scientific Tradition and Change*. Chicago, University of Chicago Press
- KFH, (1979). Shari'ah Fatwa on Economic Issues, Vol. 2, No. 96, Kuwait: Kuwait Finance House.
- Kuwait's Commercial Code (1980)*
- LAHSASNA, A. and IDRIS, U., (2011), Examination of the AAOIFI Pronouncement on *Sukuk* Issuance and its Implication on the Future *Sukuk* Structure in the Islamic Capital Market in Malaysia. In: IDRIS, U., (ed) *Islamic Banking & Finance: Issues & Solutions*, Malaysia, IIUM Press, IIUM.
- LALDIN, M. A., (2009). *The Concept of Promise and Bilateral Promise in Financial Contracts: A Fiqhi Perspective*. Kuala Lumpur: ISRA.
- LAMBRECHT, M. (2005). *The Basel II Rating: Ensuring Access to Finance for Your Business*. Aldershots, Hants, England, Gower House.
- LAMFALUSSY, A., (2003). *Initial Report of the Committee of Wise Men on the Regulation of European Securities Markets*, Brussels: European Commission
- Lampleigh v. Brathwait (1615) Hob 105*
- LANE, E. W., (2003). *Arabic-English Lexicon*, Librairie Du Liban, Sh. Muhammad Ashraf, London.
- Lark v Outhwaite [1991] 2 Lloyd's Rep. 132*
- LATIF, Q., (2006). Islamic Finance, *J.I.B.F.L.*, Volume 10.
- LEATHERS, C. G. and RAINES, J. P., (2004). The Schumpeterian Role of Financial Innovations in the New Economy's Business Cycle, *Cambridge Journal of Economics*, Volume 28, No. 5, pp. 667-681.
- LILIENTHAL, S., (2009). *Thoughts on Entry Regulation, Financial Market Competition and Financial Crisis*, München, GRIN Verlag GmbH, available from <http://nbn-resolving.de/urn:nbn:de:101:1-2010090220807> [Accessed 19/01/2011].
- LINCOLN, Y. S., and GUBA, E. G. (1985). *Naturalistic Inquiry*. Beverly Hills, Calif, Sage Publications.

- LLEWELLYN, M. I. A. D. T., (2002). *Islamic Banking and Finance*, Cheltenham: Edward Edgar Publishing.
- LOCKWOOD, B. M., MOND, D. and FABOZZI, F. J., (2001) The Anatomy of a Securitisation. In: FABOZZI, F. J. (ed). *Accessing capital markets through securitization*. New York, Frank J. Fabozzi.
- LSE (2007), *A Guide to Capital Markets Your Route To The Heart Of Global Finance*, London, available from <http://www.londonstockexchange.com/companies-and-advisors/listing/markets/guide-to-capital-markets.pdf> [Accessed 13/01/2011].
- LSE (2009) *Tokyo Stock Exchange and London Stock Exchange publish rulebook for public comment Name new growth market TOKYO AIM*, London available from <http://www.londonstockexchange.com/about-the-exchange/media-relations/press-releases/2009/tokyostockexchangeandlondonstockexchangepublishrulebookforpubliccommentnamenewgrowthmarkettokyoaim.htm> [Accessed 15/01/2011].
- LSE (2010) *A Guide to AIM*, White Page Ltd., London, available from <http://www.londonstockexchange.com/companies-and-advisors/aim/publications/documents/a-guide-to-aim.pdf> [Accessed 17/02/2012].
- LSE (2012) *Global Hub for Islamic Finance*, LSE, available from <http://www.londonstockexchange.com/specialist-issuers/islamic/finance.htm> [Accessed 19/05/2012].
- LSE (2012) *Islamic Finance 2012*, London, available from <http://www.thecityuk.com/research/our-work/reports-list/islamic-finance-2012/> [Accessed 19/05/2012].
- Lyle-Meller v. A Lewis & Co. (Westminster) Ltd [1956] 1 All ER 247
- MACFARLANE, B., (2011). Sizing up London Sukuk, Country Report, *Islamic Finance News* available from <http://kantakji.com/fiqh/Files/Markets/f196.pdf> on August, 11, 2011 [Accessed 08/02/2012].
- MADURA, J. (2001). *Financial Markets and Institutions*, Australia, South-Western College Pub.
- Mahmassani, S., (1983). *Al-Mawjibat wa'l-'Uqud fi'l-Shari'ah al-Islamiyyah*, Beirut: Dar al-'Ilm li'l-Malayin.
- MAJID, S., (2003). Worldwide: Application of Islamic Law in the Middle East, *International Construction Law Review*, Volume 20, January.
- MALLAT, C., (1996). Tantawi on Banking Operations in Egypt, In: MASUD, M. K., MESSICK, B. M., & POWERS, D. S. (1996). *Islamic Legal Interpretation: Muftis and Their Fatwas*, Cambridge, Mass, Harvard University Press.
- MANTYSAARI, P., (2010). *The Law of Corporate Finance General Principles and EU Law*, Heidelberg, Springer.
- MARCINKOWSKI, C., CHEVALLIER-GOVERS, C. and HARUN R. (2011). *Malaysia and the European Union: Perspectives for the Twenty-First Century*. Zürich, Lit, P 114
- MARGHINANI, B. A.-D. AL- (1982). *The Hidayah*. Eng. Tran. HAMILTON, C, Lahore: Premier Book House.

- MARKUS, H., (2006). The Changing Profile of Risk-the Impact of Basel II on ABS Issuance and Investment. In: WATSON, R. and CARTER, J. (eds). *Asset Securitisation and synthetic Structures: Innovations in the European Credit Markets*. London, Euromoney Books.
- Marrie v. Misa* (1875) LR 10 Exch 153
- MASON, S. et al., (1995). *Cases in Financial Engineering: Applied Studies of Financial Innovation*, Englewood Cliffs, N.J., Prentice Hall.
- MASRI, R. Y. AL-, 2002. The Binding Unilateral Promise (Wa'ad) in Islamic Banking Operations: Is it Permissible for a Unilateral Promise (Wa'ad) to be binding as an Alternative to a Proscribed Contract, *Journal of King Abdulaziz (Islamic Economics)*, Vol. 15, Jeddah, KSA.
- MAXWELL, J. A. (1996). *Qualitative Research Design: An Interactive Approach*, Thousand Oaks, Calif, Sage Publications.
- MAYO, H. B., (1991). *Investments: An Introduction*, Chicago, Dryden Press.
- MCCONVILLE, M., and CHUI, W. H., (2007). Introduction and Overview. In: MCCONVILLE, M., and CHUI, W. H., (eds) *Research methods for law*. Edinburgh, Edinburgh University Press.
- MCMILLEN, M. J. T., (2006). *Sukuk* Issuances and the Glimpse of a Secondary Market, *Euromoney Year Book-Islamic Finance Review*, pp 10-17.
- McMILLEN, M. J. T., (2007). Aset Secuitisation, *Sukuk* and Islamic Capital Markets: Structural Issues in these Formative Years. In: HASSAN, K., and LEWIS, M. (eds). *Handbook of Islamic Banking*. Cheltenham, UK, Edward Elgar.
- MEED (2007) Sabic to Raise *Sukuk* Limit, *Middle East Economic Digest*, [the University of Virginia], Volume 51, Issues 26-38, p.19 available at from <http://www.meed.com/sectors/finance/sabic-to-raise-sukuk-limit/224270.article?sm=224270> [Accessed 20/01/2010].
- MERTON, R., (1992). Financial Innovation and Economic Performance. *Journal of Applied Corporate Finance*, Volume 4, pp. 12-22.
- Midland Bank Trust Co. Ltd. v. Hett, Stubbs & Kemp* [1979] Ch 384
- MILLER, M., (1986). Financial Innovations: The Last Twenty Years and the Next. *Journal of Financial and Quantitative Analysis*, Volume 21, pp. 459-471.
- MILLER, N. D. (2008), Risk Management Considerations in *Sukuk* Issuance and Securitisation, *ICG London Sukuk Summit The Roal Horse Guards*, Norton Rose.
- MISHKIN, F. S., and EAKINS, S. G., (2009). *Financial Markets and Institutions*. Boston, Pearson Prentice Hall.
- MISHKIN, F. S., (2007). *The Economics of Money, Banking, and Financial Markets* (Alternate Edition). New York: Addison Wesley.
- MISHLER, E. G., (1986). *Research Interviewing: Context and Narrative*, Cambridge, Harvard University Press.

- MISRI, R. Y. AL-, (1993). *Al-maysir wa'l-Qimar al-Musabaqat wa'l-Jawa'iz*, Damascus: Dar al-Qalam.
- Mitas v. Hyams* [1951] 2 TLR 1215
- MOHAMAD, S. and TABATABAEI, A., (2008) Islamic Hedging: Gambling or Risk Management? *Islamic Law and Law of the Muslim World*, Paper No. 08-47, 21st Australasian Finance and Banking Conference 2008 Paper. Available from SSRN: http://papers.ssrn.com/sol3/papers.cfm?abstract_id=1260110 [Accessed 07/11/2010].
- MOHAMAD, S., YUSOFF, M. F. M. and QASSAR, A. A. AL-, (2009). Ground Rules for Sukuk Issuance. In: THOMAS, A., (ed) *Sukuk: Islamic Capital Market Series*, Securities Commission Malaysia, Sweet & Maxwell Asia, Kala Lumpur, Malaysia.
- MOKHTAR, S. and ABDULLAH, N. I., (2010) A Synthesis of Shari'ah Issues and Market Challenges in the Application of wa'ad in Equity-Based Sukuk, *ISRA*, Kuala Lumpur, Malaysia.
- MOKHTAR, S., (2008). True Sale and Bankruptcy Remoteness in *Sukuk*, *Islamic Finance News*, 5(18).
- MOKHTAR, S., (2010). A Diagnosis of Tranching in Light of Shari'ah Principles, *ISRA International Journal of Islamic Finance*, Vol. 2 (June 2010), Kuala Lumpur, Malaysia: ISRA.
- MOKHTAR, S., and THOMAS, A., (2009). *Ijarah Sukuk*. In: THOMAS, A., (ed.). *Sukuk Islamic Capital Market Series, Securities Commission, Malaysia*, Sweet & Maxwell Asia, Kuala Lumpur, Malaysia.
- MOKHTAR, S., RAHMAN, S., KAMAL, H. and THOMAS, A., (2009) Sukuk and the Capital Markets. In: THOMAS, A., (ed) *Sukuk: Islamic Capital Market Series*, Securities Commission Malaysia, Sweet & Maxwell Asia, Kala Lumpur, Malaysia.
- MONJOO, F. A., (2007). *Regulatory Challenges Faced by the Islamic Capital Market from an IOSCO Perspective*. Presented at International Islamic Capital Market Conference.
- MOODY'S (2008c). *Islamic Banks and Sukuk Growing Fast but Still Fragmented, Rating Methodology*, Moody's Global Banking, Moody's Rating Methodology, April 2008 available from <http://ddata.over-blog.com/4/08/16/46//Islamic-banks-and-sukuk.pdf> [Accessed 19/01/2011].
- MOODY'S (2008d). *Islamic Finance in France: Strong Potential, But Key Obstacles Persist*, Special Comment, Moody's Global Banking, July 2008, available from <http://ddata.over-blog.com/4/08/16/46//Islamic-finance-in-France.pdf> [Accessed 19/01/2011].
- MOODY'S, (2008). *Pre-Sale Report: Sum Finance Limited*, London, Moody's Investors Service.
- MOODY'S, (2008a). *2007 Review and 2008 Outlook: Islamic Finance: Sukuk take Centre Stage*, Special Report, London: Moody's.
- MOODY'S, (2008b). *The Benefits of Ratings for Islamic Financial Institutions and What They Address*, Special Comment, London: Moody's Global Credit Research.
- MOODY'S, (2009) *The Future of Sukuk: Substance over Form? Understanding Islamic Securitisation, Asset-Backed and AAOIFI Principles*, Moody's Investors Services, London.

- MUBARAKFURI, A. A.-A. M. ' A.-R. AL-, (1965). *Tuhfah al-Ahwazi bi-Sharh Jami' al-Tirmidhi.*, 2nd edn., Cairo: al-Maktabah al-Salafiyyah.
- MUHAMAD, R., MELEWAR, T. C. and ALWI, S. F. S., (2011). Market Segmentation and Buying Behaviour in the Islamic Financial Services. In: SANDIKCI, O., and RICE, G., (eds). *Handbook of Islamic Marketing*, Cheltenham, UK, Edward Elgar. P250.
- MUHAMMAD, M. Z., and CHONG, R., (2007). The Contract of Bay' al-Salam and Istisna' In Islamic Commercial Law: A Comparative Analysis, *Labuan E-Journal of Muamalat and Society*, Vol. 1, pp. 21-28.
- MUSLIM, I. A.-H. A.-Q., (2009). *Sahih Muslim*, Eng. trans., SIDDIQUI, A. A.-H. In: Al AIMANY (ed.) 1st Edition, Chapter 26, Book 1, Hadith No. 0114, Chapter 8, Book 10, Hadith No. 3651 available from https://docs.google.com/viewer?url=http://www.islamhouse.com/d/data/en/ih_books/single/en_Sahih_Muslim.pdf [Accessed 19/01/2012].
- NAIM, F. and HUSSAIN, A., (2009). *Wakalah Sukuk*. In: THOMAS, A., (ed.). *Sukuk Islamic Capital Market Series, Securities Commission, Malaysia*, Sweet & Maxwell Asia, Kuala Lumpur, Malaysia.
- NAQVI, S. N. H., (1994) *Islam, Economics and Society*, Kegan Paul International, London.
- NAWAWI, A. Z. M.-D. Y. AL-, (1925). *Al-Majmu' Sharh al-Muhadhdhab*, Cairo: Idarah al-Tiba'ah al-Muniriyyah.
- NISAR, S., (2000), *Islamic Bonds (Sukuk): Its Introduction and Application*, available from www.kantakji.com/fiqh/Files/Markets/m128.doc [Accessed 07/02/2010].
- NORMAN, T. L., (2004). Islamic Investment Funds. In: JAFFER, S., (ed) *Islamic Asset Management Forming the Future for Shari'ah-Compliant Investment Strategies*, London: Euromoney books.
- NYAZEE, I. A. K., (1994). *Theories of Islamic Law: the Methodology of Ijtihad*, Islamabad, International Institute of Islamic Thought and Islamic Research Institute.
- NYAZEE, I. A. K., (1995). *The Concept of Riba and Islamic Banking*, Islamabad: Niazi Publishing House.
- NYAZEE, I. A. K., (2000). *Islamic Jurisprudence*, Islamabad, International Institute of Islamic Thought and Islamic Research Institute.
- OBAIDULLAH, M., (1999) Financial Options in Islamic Contracts: Potential Tools for Risk Management, *J.KAU: Islamic Econ.*, Vol. 11.
- OBAIDULLAH, M., (2005). *Islamic Financial Services*, Islamic Economics Research Centre, Jeddah.
- OBG (2008). *The report on Kuwait*. London, Oxford Business Group.
- OIC, (2004). The Council of the Islamic Fiqh Academy of the OIC Fifteenth Session, Decision No. 136 (15/2). OIC.
- OIC, (1988). *Resolutions and Recommendations of the Council of the Islamic Fiqh Academy 1985-2000*, The Council of the Islamic Fiqh Academy of the Organization of Islamic

- Conference (OIC) in its Fourth Session held in Jeddah, Kingdom of Saudi Arabia, Resolution No.(5/4), p61.
- OIC, (1988). The Council of the Islamic Fiqh Academy of the OIC Fifth Session Decision no. 3/2. OIC .
- OIC, (2006). The Council of the Islamic Fiqh Academy of the OIC Seventeenth Session, OIC .
- OLSEN, M. E., LODWICK, D. G., and DUNLAP, R. E. (1992). *Viewing the World Ecologically*, Boulder, Westview Press.
- OMAR, A, ABDUH, M. and SUKMANA, R., (2013). *Fundamentals of Islamic Money and Capital Markets*. John Wiley & Sons Inc.
- OSMAN, M. H., (n.d) Islamic Private Debt Securities and Syndicated Financing, *Bank Islam*, available from at <http://www.bankislam.com.my/en/Documents/shariah/IslamicPrivateDebtSecuritiesSyndicatedFinancing.pdf> [Accessed 18/12/2011].
- PEBs (1980). *Report on the Elimination of Interest from the Economy Submitted to the Council of Islamic Ideology*, Para 1.25 of the Report, Panel of Economists and Bankers, Pakistan.
- PARTNOY, F., (1997). Financial Derivatives and the Costs of Regulatory Arbitrage. *Journal of Corporation Law*, Volume 22, pp. 211-227.
- Peeke v. Redman* [1552] 2 Dyer 113a
- PETTIGREW, A., (1985). *The Awakening Giant: Continuity and Change in Imperial Chemical Industries*. Oxford: Blackwell.
- Pinnel's Case* (1602) 5 Co Rep 117a
- Plymouth Corp'n v. Harvey* [1971] 1 All ER 623
- POCK, A. V. (2007). *Strategic Management in Islamic finance*. Wiebaden, Deutscher Universitats-Verlag. <http://public.eblib.com/EBLPublic/PublicView.do?ptiID=750717> [Accessed 21/04/2011].
- PRAKASH, A., (2008) Evolution of the Basel Framework on Bank Capital Regulation, *Reserve Bank of India Occasional Papers* Vol. 29, No. 2, Monsoon 2008, available from http://www.rbi.org.in/Scripts/bs_viewcontent.aspx?Id=2023 [19/03/2011].
- PROCTER, N. and LEEDHAM, E., (2004). Trust and Agency Services in the Debt Capital Markets. In: FABOZZI, F. J., and CHOUDHRY, M. (eds). *The Handbook of European Structured Financial Products*. New York, pp 143-174
- QADIR, A. A. Al-, (1982). *'Ta'qib 'ala Ra'y al-Tashri al-Mawsu'ah al-'Ilmiyyah wa'l-'Amaliyyah li'l-Bunuk al-Islamiyyah*, Cairo: Al-Itthihad al-Duwali li'l-Bunuk al-Islamiyyah.
- QARADAGHI, A., (1985). *Mabda al-Ridha fi al-'Uqud*. Beirut, Lebanon: Dar Ihya' al-turath al-'Arabi, Mu'assasah Tarikh al-'Arab.
- QARADAWI, Y. AL-, (1987). *Bai' Al-Murabahah li al Amir bi al-Shira'*, 2nd edn., Cairo: Maktabah Wahbah.

- QARAFI, A. I. I. AL-, MUHAMMAD, ‘. J., & SIRAJ, M. A. (2001). *Kitab al-Furuq: Anwar al-Buruq fi anwa' al-furuq*, Cairo, Dar al-Salam.
- QARI, A. I. S. M., (1994). *Mirqat al-Mafatih Sharh Mishkat al-Masabih*. Beirut, Lebanon: Dar al-Fikr.
- Qatar Civil and Commercial Law (1971)*.
- QAYYUM, M. A., (2010). Editorial-Executive Editor’s Note, *New Horizon*, April-June 2010, available from Islamic-banking.com/resources/7/NewHorizon%20Previous%Issues/NewHorizon_Apr-June-10.pdf. [Accessed 15/05/2011].
- QFC., (2009). *QFinance the Ultimate Resource*, London, Bloomsbury.
- QUR'AN, (2012). Quran. [Online] Available from <http://quran.com/> [Accessed 06/06/2012].
- QURTUBI, M. I. A. AL-. (1967). *Al-Jami' li-Ahkam al-Qur'an (Tafsir al-Qurtubi)*, Cairo, Dar al-Kutub al-'Arabiyyah.
- RAHIM, A., (1977). *Principles of Muhammadan Jurisprudence*, Lahore: All Pakistan Legal Decisions.
- RAJAB, I. ‘. A.-R. B. A., (2007). *The Compendium of Knowledge and Wisdom*. Eng. Trans. CLARKE, ‘., London, Turath Publishing.
- RAM, (2010). *Sukuk Focus*, Berhad: Kuala Lumpur, Malaysia: RAM Rating Services.
- Rann v. Hughes (1778) 7 Term Rep 350n*
- RASUL, B., (2010a). Lessons from Pakistan’s Model. In: VENARDOS, A. M., (2010). *Current Issues in Islamic Banking and Finance Resilience and Stability in the Present System*. Singapore, World Scientific, pp 167-188.
- RASUL, B., (2010b). Identifying the Main Regulatory Challenges for Islamic Finance. In QFC, *Islamic Finance: Instruments and Markets*, London, Bloomsbury Information Ltd.
- RAVALIA, A., (2008). *Regulating Sukuk, Sukuk UK Background*, Unpublished, Capital Market Analyst, London: FSA.
- RAYSOONI, A., (2005). *Imam al-Shatibi’s Theory of the Higher Objectives and Intents of Islamic Law*. Herndon, Virginia, USA: International Institute of Islamic Thought.
- RAZALI, S. S., (2008). *The Concept of Wa’ad in Islamic Financial Contract*, Kulliyah of Economics and Management Sciences. Kuala Lumpur, Malaysia: IIUM.
- RAZI, F. A.-D. M. I. ‘. AL- (1978). *Tafsir al-Kabir*. Beirut: Dar al-Fikr.
- REBELL, A. L., GORDON, G., and PLATNICK, K. B., (1984). *Financial Futures and Investment Strategy*. Homewood, Ill, Dow Jones-Irwin.
- RELLY, F. K., (1985). *Investment Analysis and Portfolio Management*. 2nd ed. Chicago: The Dryden Press.
- REUTERS, (2007). “The Reality of Sukuk”, November 21, 2007.
- RHODES, T. (2006). *Euromon Eyencyclopedia of Debt Finance*. London, EuromoneyBooks.

- RITTER, L. S., and SILBER, W. L. (1974). *Principles of Money, Banking, and Financial Markets*, New York, Basic Books.
- RIZVI, S. A. R, LAHSASNA, A (2012), Derivatives in Islamic Finance: the Need and Mechanisms Available for Islamic Financial Markets, 2nd ISRA Colloquium 2012 “Islamic Finance in a Challenging Economy: Moving Forward”, SasanaKijang, Bank Negara Malaysia.
- ROBBÉ, J. J. D. V, ALI, P. A. U. and COYNE, T. (2008). *Securization Law and Practice: in the Face of the Credit Crunch*. Alphen aan den Rijn, Kluwer law international.
- ROBBÉ, J. J. D.V. (2005) Synthetic Squares, or the Securitisation of Russian Dolls in ROBBÉ, J. J. D.V., & ALI, P. A. U. (eds). *Securitisations of Derivatives and Alternative Asset Classes: Yearbook 2005*, the Hague, Netherlands, Kluwer Law International.
- ROSENTHAL, F., (1975). *Gambling in Islam*. Leiden: E.J. Brill.
- ROSLY, S. A. and SANUSI, M. M., (1999). The Application of Bai’ al-‘inah and Bay’ al-dayn in Malaysian Islamic Bonds: An Islamic Analysis. *International Journal of Islamic Financial Services*, Vo. 1, No. 2, available from <http://islamic-finance.net/journal.html> [Accessed 23/02/2011].
- ROSLY, S. A., (2005). *Critical Issues on Islamic Banking and Financial Markets*, Kuala Lumpur, Malaysia: Dinamas Publishing.
- Ross T Smythy & Co. Ltd v. T.D. Bailey, Son & Co.* [1940] 3 All ER 60
- SAEDD, A. (1996). *Islamic Banking and Interest: A Study of the Prohibition of Riba and Contemporary Interpretation*. Leiden [etc.], Brill.
- SAEED, A. and SALAH, O., (2012). History of *Sukuk*: Pragmatic and Idealist Approaches to Structuring *Sukuk*. In: ARIFF, M., IQBAL, M., and MOHAMAD, S., (eds). *The Islamic Debt Market for Sukuk Securities: the Theory and Practice of Profit Investment*. Cheltenham, Edward Elgar.
- SAEED, A. and SALAH, O., History of *Sukuk* Pragmatic and Idealist Approaches to Structuring *Sukuk* (eds). ARIFF, M., IQBAL M., and MOHAMAD S. (2012). *The Islamic Debt Market for Sukuk Securities: the Theory and Practice of Profit Investment*, Cheltenham, Edward Elgar.
- SALEH, N. A., (1990). Definition and Formation of Contract under Islamic and Arab Law, *Arab Law Quaterly*, 5, 101-116.
- SALEH, N.A., (1992) *Unlawful Gain and Legitimate Profit in Islamic Law*. 2n ed. London/Dordrecht/Boston: Graham & Trotman.
- Saltzberg and Rubin v. Hollis Securities Ltd* (1964) 48 DLR 344
- SALVATORE, D., (2004). *Managerial Economics in a Global Economy*, Kbh, Thomson - South-Western.
- SANHURI, ‘. A.-R. A. AL-, (1956). *Masadir al-Haq fi’l Fiqh al-Islami*, Cairo: Ma’had al-Darasat al-‘Arabiyyah al-‘Aliyyah.
- SARAKHSI, M. I.-A. A., AL, (1986). *Al-Mabsut*. Beirut: Dar al-Ma’rifah.

- SARKAR M. A. A., (1999) *Islamic Business Contracts: Agency Problems and the Theory of the Islamic Firms*, International Journal of Islamic Financial Services Vol. 1 No.2, July-September.
- SAUNDERS, M., LEWIS, P. and THORNHILL, A., (2000). *Research Methods for Business Students*, London: Pearson Education Limited.
- Savage v. Uwechia* [1961] 1 All ER 830
- SAW, S.-H., and WANG, K. (2008). *Introduction to Islamic finance*. Singapore, Saw Centre for Financial Studies.
- SCHACHT, J., (1964). *An Introduction to Islamic Law*, Oxford, UK: Clarendon Press.
- SCHINASI, G. J., (2000). *Modern Banking and OTC Derivatives Markets: the Transformation of Global Finance and its Implications for Systemic Risk*, Washington, DC, International Monetary Fund.
- SCHOON, N., (2009a). *Islamic Banking and Finance*, London, Spiramus Press.
- SCHOON, N., (2009b). BASEL II and *Sukuk*. In THOMAS, A., (ed.). *Sukuk Islamic Capital Market Series, Securities Commission, Malaysia*, Sweet & Maxwell Asia, Kuala Lumpur, Malaysia.
- SCHOON, N., (2011). *Islamic Asset Management : An Asset Class on Its Own?* Edinburgh, Edinburgh University Press.
- SECURITIES COMMISSION, MALAYSIA, (2009). *Islamic Capital Market: The Islamic Securities (Sukuk) Market*, Petaling Jaya, Selangor Darul Ehsan: LexisNexis Malaysia, p. 13.
- SEN. A., (1985). Social Choice and Justice: A Review Article, *Journal of Economic Literature*, Vol 23, 4 December.
- SHAFI'I, M. I. I. AL-, (1901). *Al-'Umm*, Bulaq: Matba'ah al-Kubra.
- SHAFI'I, M. I. I. AL-, (1940). *Al-Risalah*. In: SHAKIR, A. M. (ed), Cairo: Mustafa al-Babi al-Halabi.
- SHAH, A., (2011) Dubai Leads the Rise in Islamic Finance: The Growth of Sukuk, *Institutional Investors*, available from <http://angelashah.wordpress.com/2011/07/28/the-growth-of-sukuk/> [Accessed 17/11/2011].
- Shamil Bank of Bahrain E.C. v Beximco Pharmaceuticals Ltd. (No.1)* [2004] 4 All ER 1072
- SHANMUGAM, B., & ZAHARI. Z. R. (2009). *A primer on Islamic finance*. Charlottesville, Va, Research Foundation of CFA Institute.
- SHARBINI, M. I. A. AL-, (1958). *Mughni al-Muhtaj*, Cairo: Mustafa al-Babi al-Halabi.
- SHAWKANI, M. I. '. AL-, (1975). *Nayl al-Awtar*, Beirut, Lebanon.
- SHERMAN, R. R., and WEBB, R. B. (1988). *Qualitative Research in Education: Focus and Methods*. London, Falmer Press.
- SHILLER, R., (2003). *The New Financial Order: Risk in the 21st Century*, Princeton, NJ, Princeton University Press.

- SHIRAZI, A. I. I. I. ' I. Y. A.-F. AL-, (1976). *Al-Muhadhdhab fi'l Madhhab*, Cairo: Mustafa al-Babi al-Halab.
- SIBLER, W., (1983). The Process of Financial Innovation, *American Economic Review*, Volume 73, pp. 89-95.
- SIDDAIAH, T(hummuluri) (2011) *Financial Services*, Dorling Kindersley (India) Pvt. Ltd. (Pearson).
- SIDDIQI, M. N., (1985). *Insurance in an Islamic Economy*. Leicester: The Islamic Foundation.
- SINGER, D., (2001a). Securitisation Basics. In: FABOZZI, F. J. (ed). *Accessing Capital Markets through Securitization*. New York, Frank J. Fabozzi Associates: New Hope, Pennsylvania.
- SINGER, D., (2001b). Market Innovation in Securitisation and Structured Finance. In: FABOZZI, F. J. (ed). *Accessing Capital Markets through Securitization*. New York, Frank J. Fabozzi Associates: New Hope, Pennsylvania.
- SINGH, M. (2011). *Security Analysis with Investement [i.e. investment] and Profolio [i.e. portfolio] Management*. Delhi, Isha Books.
- SINKEY, Jr. J. F., (2001), Strategies for Community Bankers. In: FABOZZI, F. J. (ed). *Accessing Capital Markets through Securitization*. New York, Frank J. Fabozzi Associates: New Hope, Pennsylvania.
- SIRAJ, M. A., (1989). *Nizam al-Masrafi al-Islami*, Cairo: Dar al-Trhaqafah li'l-Nashr wa'l-Tawzi'.
- SLAPPER, G. and KELLY, D., (2010). *The English Legal System*, 11th edn, Routledge, Oxon.
- Slough Estates Ltd v. Slough Borough Council* (No. 2) (1967) 19 P & CR 326
- SMART, S. B., MEGGINSON, W. L., and GITMAN, L. J. (2004). *Corporate Finance*, Mason, Ohio, Thomson/South-Western.
- SMITH, A., (1776). *An Inquiry into the Nature and Causes of the Wealth of Nations*, W. Strahan & T. Cadell, London
- SMOLARSKI, J., SCHAPEK, M. and TAHIR, M. I., (2006). Permissibility and Use of Options for Hedging Purposes in Islamic Finance, *Thunderbird International Business Review*, Vol. 48, Issue No. 3. Pp 425-443.
- SOLÉ, J., (2007). *Introducing Islamic Banks into Conventional Banking Systems*, IMF Working Paper WP/07/175.
- STANDARD & POOR'S, (2008). *The Sukuk Market Continues to Soar and Diversify, Held Aloft by Huge Financing Needs*, Mohamed Damak and Emmanuel Volland.
- STANDARD & POOR'S (2007), *Islamic Finance Outlook 2008*, London.
- STENSGAARD, A. B. (2005) *Arcapita Bank B.S.C.(C) USD200,000,000 Murabaha-Backed Sukuk* available from <http://www.ameinfo.com/63220.html> at 26/06/2012
- STERLING, T. F. (2002). *The Enron scandal*, New York, Nova Science Publishers.
- STICH, R. (2008). *America's Housing And Financial Frauds Massive Financial Frauds Played Upon An Uninformed Or Gullible Public*. Alamo, Silverpeak Publishers.

- STRAUSS, A., (1987). *Qualitative Analysis for Social Scientists*. Cambridge: Cambridge University Press.
- SUDAIRY, S. AL-, (2008). The Potential for Global Sukuk Mandates-Demystification, Education and Familiarization, *Sukuk Summit, London*, available from <http://www.assaif.org/content/download/1062/7657/file/The%20Potential%20for%20Global%20Sukuk%20Mandates.pdf> [Accessed 21/02/2011].
- SUDAN, CENTRAL BANK OF SUDAN, (2009). Provided by Economics & Policy Wing.
- SUWAILEM, S. AL-, (2006). *Hedging in islamic finance*, Occasional Paper No. 10, Jeddah (Saudi Arabia), Islamic Development Bank, Islamic Research and Training Institute.
- SUWAILLEM, S. AL-, (2007), Financial Engineering on Islamic Perspective, *Sinergi Ka Jian Bisnis Dan Manajembn*, Vol. 9 No. 1, January.
- TACY, K. J., (2006). Islamic Finance: A Growing Industry in the United States. *North Carolina Banking Inst.*, Volume 10, p. 355.
- TAHIR, M. AL-, (2006). *Ibn Ashur Treatise on Maqasid al-Shari'ah*, Herndon, Virginia, USA, International Institute of Islamic Thought.
- TARIQ, A. A., (2004). *Managing Financial Risks of Sukuk Structures*. Dissertation (M.S.c.) Loughbroroguh University, UK.
- Taylor v. Brewer* (1813) 1 M & S 290
- TEJOORI LIMITED (2006) *Admission to trading on AIM*, available from <http://www.tejooriltd.ae/pdfs/AIM.pdf>
- TERRE BLANCHE, M. J., and DURRHEIM, K. (1999). *Research in Practice: Applied Methods for the Social Sciences*. Cape Town, University of Cape Town Press.
- TERRE BLANCHE, M. J., DURRHEIM, K., & PAINTER, D. (2006). *Research in practice: applied methods for the social sciences*. Cape Town, South Africa: UCT Press.
- TEWELES, R. J. and JONES, F. J., (1987). *The Futures Game: Who Wins? Who loses? Why?*, New York, McGraw-Hill.
- The City UK (2011), *Islamic Finance, Financial Markets Series*.
- THOMAS A. S., (2006b) Islamic Securitisation: Opportunities with *Sukuk*, In: WATSON, R., and CARTER, J., (eds). *Asset Securitisation and Synthetic Structures: Innovations in the European Credit Markets*. London, Euromoney Books.
- THOMAS A. S., KRATY B, HUSSAIN M and COX, S. (2005b) *Salam* in THOMAS, A. S., COX, S., and KRATY, B., (eds). *Structuring Islamic Finance Transactions*. London, Euromoney Books.
- Thomas v. Thomas* [1842] 2 QB 852
- THOMAS, A. S (2005) Risk Management and Derivatives. In: THOMAS, A. S., COX, S., & KRATY, B. (eds). *Structuring Islamic Finance Transactions*. London, Euromoney Books.
- THOMAS, A. S. (2006a). *Interest in Islamic Economics Understanding Riba*. London, Routledge.

- THOMAS, A. S. and Hussain M., (2005). Introduction, the Origins and Nature of the Islamic Financial Market. In: THOMAS, A. S., COX, S., and KRATY, B. (eds) *Structuring Islamic Finance Transactions*. London, Euromoney Books.
- THOMAS, A. S. and Thofeek, M. I., (2005). Equity Finance Vehicles: *Mudarabah* and *Musharakah*. In: THOMAS, A. S., COX, S., and KRATY, B. (eds) *Structuring Islamic Finance Transactions*. London, Euromoney Books.
- THOMAS, A., QAISER, W., BAHAR, B. AL-. and HARON, S., (2005a) Structuring Islamic Mortgage and Home Finance Products. In: JAFFER, S. (ed). *Islamic Retail Banking and Finance: Global Challenges and Opportunities*. London, Euromoney Books.
- THOMAS, A., S and KRATY, B., (2005) Complex Transactions: *Istisna'*, Pre-Export Manufacturing Finance Working Capital and Project Finance. In: THOMAS, A. S., COX, S., and KRATY, B. (eds). *Structuring Islamic Finance Transactions*. London, Euromoney Books.
- TIBY, A. M. EL-, (2011). *Islamic Banking How to Manage Risk and Improve Profitability*, Hoboken, N.J., Wiley.
- TIRMIDHI, M. I. ' AL-, (1974). *Sunan al-Tirmidhi*. In: SHAKIR, A. M., 2nd edn., Chapter 7, Book 13, Hadith No. 1352, Chapter 19, Book 12, Hadith No. 1232, Mustafa al-Babi al-Halabi.
- TORRE, A. de la and IZE, A., (2009). *Financial Paradigms: What Do They Suggest about Regulatory Reform?*, Crisis Response Public Policy for the Private Sector, The World Bank Group Financial and Private Sector Development Vice Presidency, Note No. 10, November 2009.
- TUSI, M. I. A.-H., (2008). *Al-nihayah: Concise Description of Islamic Law and Legal Opinions*, Eng. Trans. EZZATI, A. A.-F, London, ICAS Press.
- TWINNING, W. L., (1990). *Rethinking Evidence*. Oxford: Blackwell.
- TYSER, C. R., DEMTRIADES, D. G., and EFENDI, I., (1967). *The Mejelle; being an English Translation of Majallah al-Ahkam-i-Adliya and a Complete Code on Islamic Civil Law*. Lahore, All Pakistan Legal Decisions.
- Uberoi, P., Chatterji, R., and Bidar, D., (2009). *Promises on the Horizon: An Introduction to the Wa'ad*, Allen& Overy, available from <http://www.allenoverly.com/archive/Documents/Legacy/52774.pdf>. [Accessed 22/10/2011]
- UDOVITCH, A. L. (1970). *Partnership and Profit in Medieval Islam*, Princeton, N.J., Princeton University Press.
- 'ULAYSH, A.-'. M. A. (1985). *Fath Al-'ali Al-Malik Fi Al-Fatwa 'ala Madhab Al-Imam Malik Guz' I Guz' I*. Bairut, Dar al-Fikr Li-l-Ṭiba'a wa al-Nasr wa al-Tauzi'.
- United Arab Emirates Federal Civil Code (1985)*.
- United Dominions Trust (Commercial) Ltd v. Eagle Aircraft Services Ltd* [1968] 1 All ER 104
- UNITED STATES OF AMERICA, (2010). *The Financial Crisis Inquiry Report: Final Report of the National Commission on the Causes of the Financial and Economic Crisis in the United States*. Washington, DC, Financial Crisis Inquiry Commission.

- USMANI, M. I. A., (2007) Fixed Income Securities *Shari'ah* Perspective, *SBP Research Bulletin*, Volume 3, Number 1.
- USMANI, M. I. A., and ZUBAIRI, Z., (2002). *Meezanbank's Guide to Islamic Banking*, Karachi, Darul-Ishaat.
- USMANI, M. T., (1998). *An introduction to Islamic finance*. Karachi, Idaratul Ma'arif.
- USMANI, M. T., (2005). *An Introduction to Islamic Finance*, In: Karachi: Maktaba Ma'riful Quran, pp. 168-171.
- USMANI, M. T., (2008). *Sukuk and Their Contemporary Application*, available from <http://www.muftitaqiusmani.com/images/stories/downloads/pdf/Sukuk.pdf>.
- Vallance, Re; Vallance v. Blagden* (1884) 26 ChD 353
- VENARDOS, A. M., (2005). *Islamic Banking & Finance in South-east Asia its Developments & Future*, Hackensack, NJ, World Scientific.
- VENARDOS, A. M., (2010). Resilience and Stability: Socioeconomic Response in Southeast Asia. In: VENARDOS, A. M., *Current Issues in Islamic Banking and Finance Resilience and Stability in the Present System*. Singapore, World Scientific, pp 1-10.
- VIKØR, K. S., (2005). *Between God and the Sultan: A History of Islamic Law*. Oxford [England], Oxford University Press.
- VISSER, H. (2009). *Islamic Finance: Principles and Practice*. Cheltenham, U.K., Edward Elgar.
- VOGEL, F. E., and HAYES, S. L., (1998). *Islamic Law and Finance: Religion, Risk, and Return*. Boston, Mass, Kluwer Law International.
- WALIYYULLAH, S. D., (1936). *Hujjatullah al-Baligah*, Cairo: Dar al-Turath.
- WALLERSTEIN, I. M., (2001). *Unthingking Social Science: the Limits of Nineteenth-Century Paradigms*, Philadelphia, Temple University Press.
- Walsh v. Westpac Banking Corp*n (1992) 104 ACTR 30
- Waltons Stores (Interstate) Ltd v. Maher* (1988) 76 ALR 513
- WARDE, I., (2000). *Islamic Finance in the Global Economy*, Edinburgh, Edinburgh University Press.
- WATSON, R., and CARTER, J. (2006). *Asset Securitisation and Synthetic Structures: Innovations in the European Credit Markets*. London, Euromoney Books.
- Whitaker, Re; Whitaker v. Palmer* [1901] 1 Ch 9
- White v. Jones* [1995] 2 AC 207.
- WIEDEMER, J. P., (1977). *Real Estate Finance*, Reston, Va, Reston Pub. Co.
- Wigan v. English and Scottish Law Life Assurance Association* [1909] 1 Ch 291
- WILLIAMS, R. T. (2011). *An Introduction to Trading in the Financial Markets Trading, Markets, Instruments, and Processes*, Amsterdam, Elsevier.
- WILSON, R. and BALDWIN, D, (1988). Islamic Finance in Principle and Practice. in: Mallat, C., (ed.). *Islamic Law and Finance*, London, Graham and Trotman, pp. 184-86.

- WILSON, R., (1995). Islamic Banking and its Impact on the International Financial Scene. *J.I.B.L.*, 10(10), p. 437.
- WILSON, R., (2002a). Parallels between Islamic and Ethical Banking, *Review of Islamic Economics*, Vol. 11, pp 51-62.
- WILSON, R., (2002b). The Interface between Islamic and Conventional Banking. In: IQBAL, M. and LLEWELLYN, D. T., (eds) *Islamic Banking and Finance*, Cheltenham: Edward Edgar Publishing.
- WILSON, R., (2004). Overview of the Sukuk Market. In: ADAM, N. J., and THOMAS, A. S., (authors). *Islamic Bonds: Your Guide to Issuing, Structuring and Investing in Sukuk*. London, Euromoney Books.
- WILSON, R., (2006). Regulatory Challenges Posed by Islamic Capital Market Products and Services, In: LEVENTHAL, A., AFF (ed) *Convergence: New Directions in Islamic Finance?* Harvard University.
- WILSON, R., (2007). *Islamic Finance in Europe*, RSCAS Policy Papers 2007/02, European University Institute for MUSMINE, Florence, Robert Schuman Centre for Advanced Studies available from http://www.eui.eu/RSCAS/WP-Texts/07_02p.pdf [Accessed 05/12/2011].
- WILSON, R., (2008). Innovation in the Structuring of Islamic Sukuk Securities. *Humanomics*, 24(3), 170-181.
- WJ Alan & Co. Ltd. v. El Nasr Export and Import Co.* [1972] 2 QB 189
- Wyvern Developments Ltd In Re* [1974] 2 All ER 535
- YEGANEH, H. and SU, Z., (2005). Positivism and Constructivism: Two Opposite But Reconcilable Paradigms In Cross-Cultural Management Research, *Administrative Sciences Association of Canada*, 2005, Toronto, Ontario.
- ZAHRAH, M. A., (1958). *Usul al-Fiqh*, Cairo: Dar al-Fikr al-Arabi.
- ZAIDI, J. A, (2007). Sukuk A Global Trend, *The Analyst*, September 2007.
- ZARQA, M. A. (1997). Istisna' Financing Of Infrastructure Projects, *Islamic Economic Studies* Vol. 4, No. 2, May 1997.
- ZARQA, M. A. AL-, (1967). *Al-Fiqh al-Islami fi Thuwbihi al-Jadid*. Damascus, Syria: Matabi' Alif Ba al-Adib.
- ZARQA, M. A. AL-, (1984). *Nizam Al-Ta'min*. Beirut, Lebanon: Dar al-Fikr.
- ZIN, M. Z. M, HASHIM, N., KHALID, N. K., OPIR, N., SULAIMAN, R. (2011) The Implementation of Sukuk in Islamic Finance, *IPEDR* vol.10 (2011), IACSIT Press, Singapore.
- ZUHAYLI, W. AL-, (2003). *Financial Transactions in Islamic Jurisprudence*. Damascus: Dar al-Fikr.