

2013

# Factors Which Influence Key Entry Speed On Hard and Soft Keyboards: Experience, Eye Behaviors and Finger Movements

Seckin Celik

*University of Massachusetts Amherst*

Follow this and additional works at: <https://scholarworks.umass.edu/theses>

 Part of the [Operations Research, Systems Engineering and Industrial Engineering Commons](#)

---

Celik, Seckin, "Factors Which Influence Key Entry Speed On Hard and Soft Keyboards: Experience, Eye Behaviors and Finger Movements" (2013). *Masters Theses 1911 - February 2014*. 983.

Retrieved from <https://scholarworks.umass.edu/theses/983>

This thesis is brought to you for free and open access by ScholarWorks@UMass Amherst. It has been accepted for inclusion in Masters Theses 1911 - February 2014 by an authorized administrator of ScholarWorks@UMass Amherst. For more information, please contact [scholarworks@library.umass.edu](mailto:scholarworks@library.umass.edu).

**FACTORS WHICH INFLUENCE KEY ENTRY SPEED ON HARD AND SOFT KEYBOARDS: EXPERIENCE,  
EYE BEHAVIORS AND FINGER MOVEMENTS**

A Thesis Presented

by

SECKIN CELIK

Submitted to the Graduate School of the  
University of Massachusetts Amherst in partial fulfillment  
of the requirements for the degree of

MASTER OF SCIENCE IN INDUSTRIAL ENGINEERING AND OPERATIONS  
RESEARCH

February 2013

Mechanical and Industrial Engineering

© Copyright by S.CELIK 2013

All Rights Reserved

**FACTORS WHICH INFLUENCE KEY ENTRY SPEED ON HARD AND SOFT KEYBOARDS: EXPERIENCE,  
EYE BEHAVIORS AND FINGER MOVEMENTS**

A Thesis Presented

by

SECKIN CELIK

Approved as to style and content by:

---

Donald Fisher, Chair

---

Ana Muriel, Member

---

Jenna Marquard, Member

---

Donald Fisher, Department Head

Mechanical and Industrial Engineering

## **DEDICATION**

I dedicate this study to my beloved parents, who supported me each step of the way. They helped me to overcome the strength of studying abroad.

## **ACKNOWLEDGMENTS**

I would like to express deepest appreciation to my committee chair, Professor Donald Fisher, who has the attitude and substance of a genius: he continually and convincingly conveyed a spirit of adventure in regard to research and scholarship, and an excitement in regard to teaching. Without his guidance and persistent help this dissertation would not have been possible.

I would like thank my committee members, Ana Muriel and Jenna Marquard, whose comments made this research a better one. With their proposal suggestions, this work produced stronger and precise results.

I would like to also thank to Human Performance Lab Manager Tracy Zafian, Industrial Engineering PhD student Siby Samuel and Luis Roman Gerardino for helping me with eye tracker training and IRB protocol process.

**ABSTRACT**

**FACTORS WHICH INFLUENCE KEY ENTRY SPEED ON HARD AND SOFT KEYBOARDS: EXPERIENCE,  
EYE BEHAVIORS AND FINGER MOVEMENTS**

February 2013

SECKIN CELIK

B.S., ISTANBUL TECHNICAL UNIVERSITY

M.S.I.E.O.R., UNIVERSITY OF MASSACHUSETTS AMHERST

Directed by: Professor Donald Fisher

Soft keyboards have become ubiquitous, especially with the introduction of the iPad. This study aims to determine for experienced touch typists whether there are characteristics of soft QWERTY keyboards that can make them easier to use and why those characteristics provide an advantage. Two characteristics would appear to be of central importance. First, hard keyboards provide home row positioning information that is not as easily provided by soft keyboards. Second, hard keyboards also provide auditory and tactile feedback when a key is depressed, something not generally provided with soft keyboards.

In order to test the hypothesis that the absence of home row positioning and key strike feedback information can reduce expert touch typists' speeds on soft keyboards, expert touch typists were run in two experiments. In Experiment 1, soft and hard keyboards in landscape and portrait mode were evaluated. The hard keyboards had the standard home row positioning and

key strike feedback whereas the soft keyboards had neither. If these are important elements in typing speed, then experienced hard keyboard typists should type less quickly when using soft keyboards than when using hard keyboards. Moreover, if reducing the footprint of the keyboard, from landscape to portrait, requires more eye movements, then typists using both hard and soft keyboards should be slower when using the portrait size keyboard than when using the landscape size keyboard. Perhaps not surprisingly, experienced hard keyboard touch typists do less well when entering information on soft keyboards without home row positioning information or auditory feedback. Moreover, both groups appear to type more slowly in keyboards laid out in a portrait format than they do in keyboards laid out in a landscape format.

In summary, the results from Experiment 1 suggest that both home row positioning information and auditory key strike feedback should speed performance. In Experiment 2, an attempt was made to determine just how much of a gain can be made in the typing speed of more experienced soft keyboard users if home row positioning information (tactile feedback), auditory feedback, or both are added. Participants were run in four conditions: auditory key strike feedback (with and without) was crossed with tactile home row positioning information (with and without). Participants included expert level hard keypad QWERTY touch typists who have had at least five hours' typing experience with an iPad. Participants were given four passages to type, all of equal length and all balanced for letter frequency. Participants typed one passage in each of the four conditions. The passage sequence was counterbalanced across participants. Typing speeds for each of the passages was measured and averaged across participants within conditions. A repeated measures analysis of variance was used to determine whether there was a main effect of position or feedback.



In order to determine why it is that home row positioning and key strike feedback alters performance, eye behaviors, movement times and task completion times are calculated. If home row position information is important, soft keyboards without this information may have a larger number of glances that a typist directs at the keyboard. These glances will help the typist determine either whether a finger is positioned over the correct home key (the launch key) or whether the location of the key to be typed next (the target key) is in the expected position. If key strike feedback is important, soft keyboards without this information should have longer movement times where the typists do not need to glance at the keyboard. This follows since the typist will process less quickly the fact that a finger has landed on a key.

Key press and key release times will be included each time a character, number or spacebar is depressed or releases. The *finger movement time* between any pair of keys  $i$  and  $j$  will be derived from the key press and key release times. This time will be measured from the moment the finger leaves the launch key  $i$  until the moment that the finger arrives at the target key  $j$ . Task completion times were defined as the difference between the first key press in a passage and the last key release. Finger movement times, inter-keystroke intervals and task completion times were recorded using a program developed in JAVA 2SE. Eye movements are recorded with aid of an ASL Mobile EYE tracker.

Analyses of the finger movement times and task completions times in Experiment 2 indicated that participants were fastest when both position information and auditory feedback were included. When just finger movement times are considered, there was a significant effect of auditory feedback but not of positioning information. This was what was expected given that the speed of finger movement times is arguably largely a function of how quickly a typist perceives that a movement has been completed, something that auditory feedback, but not

positioning information provides. When just the task completion times were analyzed, position information had a significant effect. The effect of auditory feedback was only marginally significant. It was expected that both factors would be significant. Perhaps the power was too small. Finally, when the eye movements were analyzed, the total scanning time was shortest when both position information and auditory feedback were available. The effects of both were statistically significant.

In summary, on the basis of the results from Experiment 1 it appeared likely that auditory feedback and positioning information accounted in part for the faster typing times of touch typists on hard keyboards as opposed to soft keyboards. In Experiment 2, this hypothesis was evaluated. Finger movement and task completion times were fastest when both auditory feedback and positioning information were present. The effect of auditory feedback appeared to impact only the finger movement times. The effect of both auditory feedback and positioning information appeared to impact the task completion times. However, the effect of auditory feedback on task completion times was only marginal. Finally, it was clear that much of the reduction in task completion times occurred because the time that the touch typists spent scanning the keyboard was smaller when both auditory feedback and positioning information was available.

It is recommended in the future that soft keyboards have both sets of feedback available, auditory (through simulated key clicks) and tactile (through home row positioning information). The gains in typing speed with these additions were modest (about 10%), considered over the entire population of users the impact could be considerable.

## TABLE OF CONTENTS

	Page
ACKNOWLEDGMENTS.....	v
ABSTRACT.....	vi
LIST OF TABLES.....	xii
LIST OF FIGURES.....	xiv
CHAPTER	
1. LITERATURE REVIEW .....	1
Introduction .....	1
Movement Time Studies.....	1
Early Studies on Information Theory .....	1
Text Entry on Soft Keyboards .....	7
Stylus Activated Typing.....	9
Other Methods Used in Literature .....	13
Modeling of Touch Typing .....	14
Importance of Positioning and Feedback .....	15
Home Row Positioning Information .....	15
Auditory Feedback.....	17
2. EXPERIMENT I.....	18
Method.....	18
Participants.....	18
Apparatus.....	18
Stimuli.....	19
Experimental Design .....	21

Procedure.....	22
Dependent Variables .....	22
Results.....	22
Discussion and Limitations.....	26
3. EXPERIMENT II .....	28
Method.....	28
Participants .....	28
Stimuli.....	29
Apparatus.....	32
Experimental Design .....	32
Procedure.....	34
Dependent Variables .....	34
Results.....	35
Time Data.....	35
Finger Movement Time: One Finger Typing .....	35
Residual Finger Movement Time: Multiple Finger Typing.....	37
Eye Movement Data .....	45
Areas of Interest .....	45
Eye Glance Analyses .....	46
Discussion and Limitations.....	48
CONCLUSION.....	50
JAVA CODE .....	52
LETTER FREQUENCY .....	56
TEXT PASSAGES .....	58
REFERENCES.....	60

## LIST OF TABLES

Table	Page
2.1 Sentence characteristics of first experiment as indexed by letters per sentence.....	20
2.2 Sentence characteristics of first experiment as indexed by letters per word .....	21
2.3 Correlation result of first experiment.....	21
2.4 Participants typing speed in words per minute .....	22
2.5 Tests of Within-Subjects Contrasts. [Levels are the sizes (e.g. Large Small) for each layout (e.g. Hard, Soft).] .....	24
2.6 Correlation results for different situation .....	24
3.1 Sentence characteristics of second experiment as indexed by letters per sentence.....	29
3.2 Sentence characteristics of second experiment as indexed by letters per word.....	30
3.3 Correlation results of passages.....	30
3.4 Chi square test result for experiment II passages.....	31
3.5 Counterbalancing for conditions .....	33
3.6 Descriptive Statistics for Finger Movement.....	36
3.7 Analysis of One Finger Movement Times: Effect of Audio Feedback and Position Information .....	36
3.8 Experiment design for within subjects .....	39
3.9 Descriptive Statistics for ANOVA test in finger movement.....	39
3.10 ANOVA Test for residual finger movement time .....	41
3.11 Descriptive statistics for task completion.....	42

<b>3.12</b>	Analysis of task completion times after space bar correction.....	44
<b>3.13</b>	ANOVA test for task completion.....	44
<b>3.14</b>	Distribution of eye glance proportion for conditions .....	47
<b>3.15</b>	Test results for Area of Interest-II.....	47

## LIST OF FIGURES

Figure	Page
1.1 A general communication system.....	1
1.2 Original experiments in Hick (1952) study.....	3
1.3 Reaction time as a function of degree of choice (Hick, 1952) .....	4
1.4 Movement time with varying of difficult level (Fitts, 1954).....	5
1.5 Typing speed in terms of words per minute for varying keyboard size (Sears, Revis, Swatski, Crittenden, & Shneiderman, 1993) .....	11
1.6 OPTI performance results projected (MacKenzie & Zhang, 1999) .....	12
2.1 Plot graph of highest positive correlation.....	25
2.2 Plot graph of highest negative correlation .....	26
3.1 Different letter transition cases.....	37
3.2 Algorithmic representation of key depressing time derivation.....	38
3.3 Box plot graph for finger movement times for different conditions.....	40
3.4 Bar graph for finger movement interaction .....	41
3.6 Areas of interest.....	45
3.7 3-D chart for eye movement percentages (seconds) .....	46

## CHAPTER 1

### LITERATURE REVIEW

#### Introduction

There are three different literatures that bear on an understanding of the effects of positioning information and feedback on typing speed on soft keyboards. The first is the literature which examines the time that it takes a user to move a stylus, or possibly a finger, between two different locations. Such information can potentially be used to predict the time it takes a typist to type two different letters in sequence with the same finger. The second body of literature deals more generally with touch typing, not just single finger typing. Finally, the third body of the literature bears on the importance of position information and feedback in motor control.

#### Movement Time Studies

The study of movement time begins with early work on information theory.

#### **Early Studies on Information Theory**

The classical information theory is essentially a communication engineering theory. Shannon (1948) is considered to be the founder of Information Theory. In his work, a general model of the communication system is developed (Figure below).

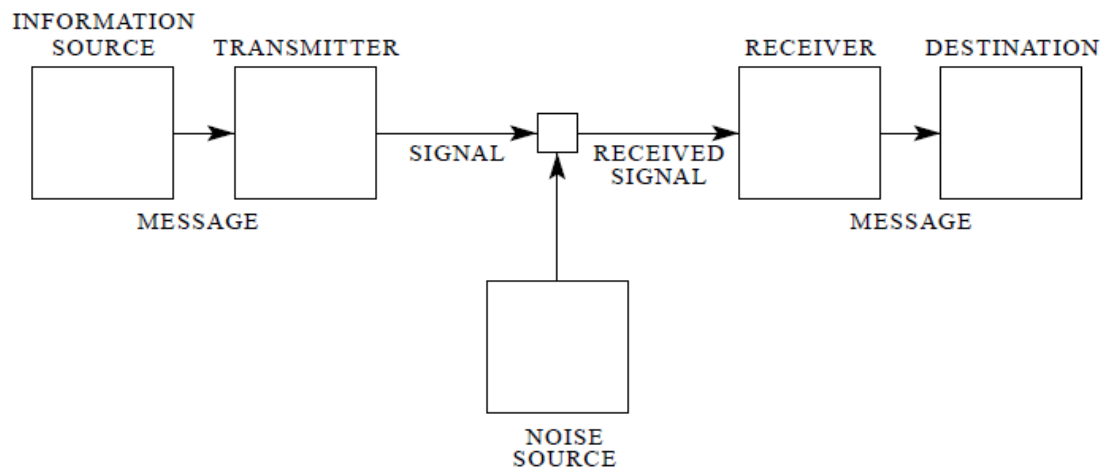

**Figure 1.1** A general communication system



The information source produces a message; the transmitter operates on the message to make it transmissible through a medium called the channel; a transmitted message reaches the receiver that reconstructs the message to the destination. The channel capacity ( $C$ ) is defined as the amount of information that a communication channel transmits in a fixed amount of time. Information is formally defined in Information Theory as a reduction in uncertainty and quantified in units of bits. The information ( $I$ ) in a message with probability  $p$  is given by the formula:

$$I = -\log_2(p)$$

The entropy (expected information) in a set of messages ( $H$ ) follows weighting the information in each message by its likelihood and is given by the following formula:

$$H = \sum_i^a p_i \log_2 \left( \frac{1}{p_i} \right)$$

The transmitted information  $H_T$  from message set  $X$  to message set  $Y$ , ( $H_T$ ), is given by the formula

$$H_T = H(x) - H_y(x),$$

where  $H_y(x)$  is the conditional entropy of  $x$  when  $y$  is known.

There are other very important works by Fitts (1954), Hick (1952) and Hyman (1953a) that are based on the extensions of the general model by Shannon (1948). The Hick (1952) and Hyman (1953a) experiments assessed the cognitive information capacity in choice-reaction experiments. In the Hick's and Fitts' paradigms, when a participant performs a task without errors, he is said to be extracting all the expected information or the stimuli. As such  $H_y(x)$  equals zero.

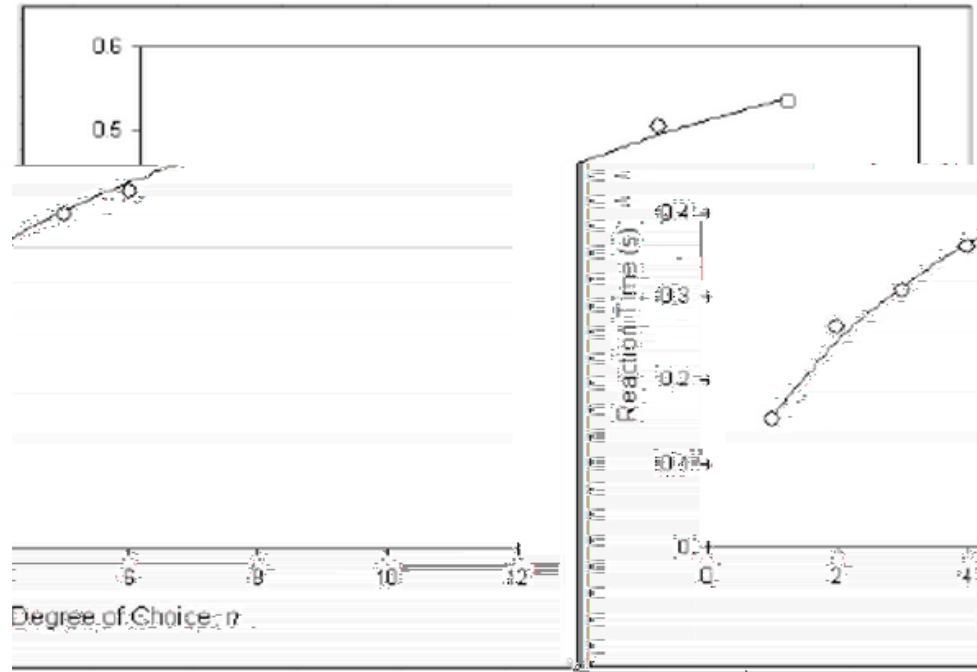
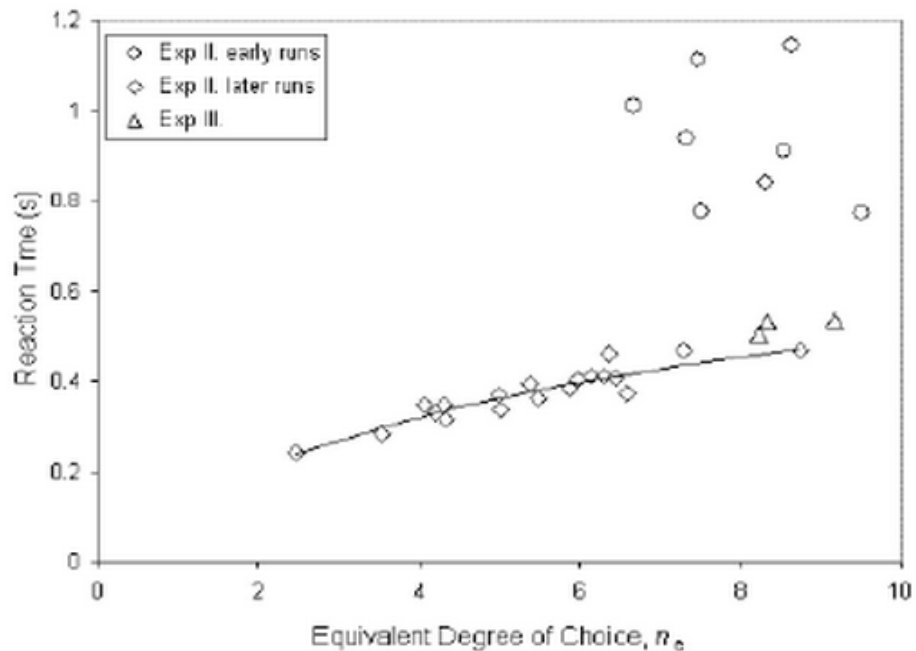

**Figure 1.2** Original experiments in Hick (1952) study

Experiment 1 was used to determine the empirical relationship between choice reaction time and stimulus information content. Hick (1952) characterized the relationships between response time  $RT$  and the number  $n$  of choices as logarithmic. He did not, however, explicitly postulate a linear relationship between  $RT$  and  $H_T$ . Hyman (1953) may be first to articulate the linearity between the two variables. Hyman altered the probabilities of the stimuli to yield varying amounts of entropy so that he can assess  $RT$  as a function of  $H_T$ .  $RT$  was a linear function of stimulus information entropy. The Hick-Hyman Law follows from the above research. It states that the relation is a linear one between the information transmitted between the stimuli and responses and the response time:

$$RT = a + bH_T$$

The reciprocal of  $b$  is what Hick referred to as the rate of gain of information or the information capacity.



**Figure 1.3** Reaction time as a function of degree of choice (Hick, 1952)

In the early runs of Experiment 2 (the “accuracy” run), the subjects were asked to respond as accurately as possible. They were more accurate, but at the expense of speed. In the later runs of Experiment 2 (the “speed run”), the subjects were asked to respond as quickly as possible. They did respond more quickly on average, but accuracy was compromised. The information theoretic relation to the speed-accuracy tradeoff is demonstrated by comparing the amount of information processed in both runs. More information was processed in the “accuracy” run than the “speed” run.

It was also hypothesized that compatible stimulus-response (S-R) pairs facilitate the response to a stimulus, and yield a higher rate of information transfer, whereas incompatible ones impede optimal performance. Stimulus-response compatibility (SRC) effects were observed on the slope parameter of the Hick-Hyman Law: An increase in SRC decreased the slope.

Many current studies investigate the relationship between RT and intelligence as measured by IQ scores. Empirical parameters of the intercept ( $a$ ), slope ( $b$ ), and  $RT$  ( $M$  and  $SD$ ) have all been correlated against intelligence. Applications of Hick-Hyman Law are scarce in the human-computer interaction (HCI) literature despite its foundation in information processing.

Olson and Nilsen (1987) compared the decision time taken to perform equivalent functions in two different spreadsheet programs (Lotus 1-2-3 and Multiplan). Lotus 1-2-3 had three methods available to users to perform a particular task and Multiplan only had one to perform the similar task. The investigators found that users took additional time to decide which of the three alternatives to use in Lotus 1-2-3.

Landauer and Nachbar (1985) studied response time in menu selection using touch screen. They reported that the results were consistent with the Hick-Hyman Law but were unable to recommend any particular menu design: “more results from experiments like these will clearly be needed before more confident generalization to new cases become feasible”

Fitts (1954) work was an empirical determination of the information capacity of the human motor system. There is a linear relationship between task difficulty and movement time. Define the index of difficulty ( $ID$ ) as a function of the amplitude of a movement ( $A$ ) and the width of a target ( $W$ ) where  $ID = 2A/W$ . Then,

$$MT = a + b \log_2 ID$$

$$= a + b \log_2 \left( \frac{2A}{W} \right)$$

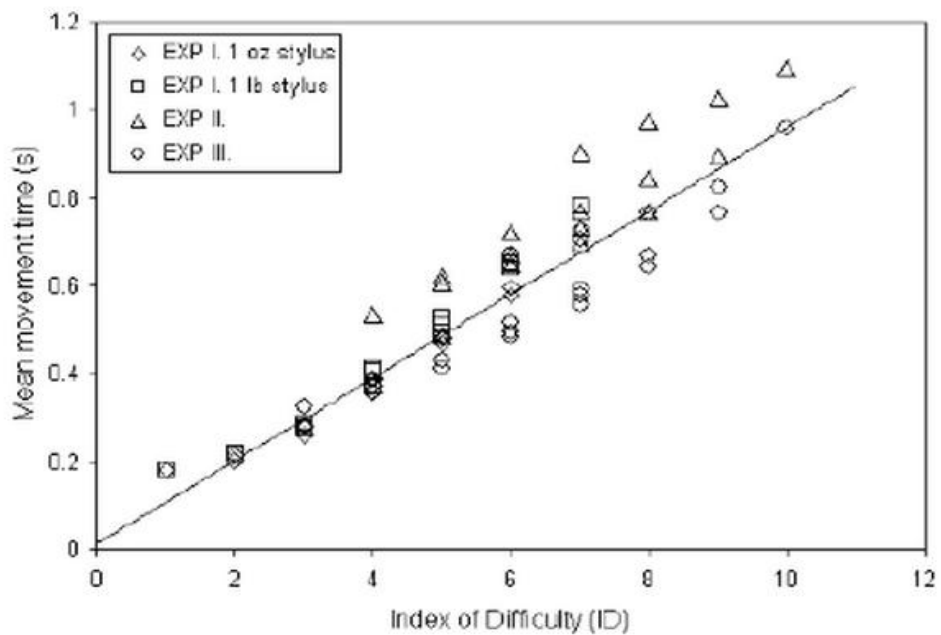

**Figure 1.4** Movement time with varying of difficult level (Fitts, 1954)

By combining various degrees of  $A$  and  $W$ , Fitts was able to vary  $ID$  and determine the information capacity of the human motor system. Fitts asserted that there is an inverse correlation between speed and accuracy. The width of the target determines how much information must be processed in a given unit of time. Fitts assumed that the motor system has

a fixed information processing capacity. If a repetitive movement of fixed amplitude is speeded up, the movement variability will increase and therefore the accuracy will decrease.

Schmidt, Zelaznik, Hawkins, Frank, and Quinn Jr (1979) contended that the error made by participants in Fitts' paradigm is "linearly and directly related to movement amplitude, independent of movement time".

Jensen and Munro (1979) reported a mean correlation of -0.46 between the Raven IQ scores and MT.

Roberts (1997) found no evidence for a correlation between IQ and *MT*. The majority of the HCI research involves the physical operation (pointing, dragging, etc.) of a mouse or stylus to acquire a visual target on the screen.

Gillan, Holden, Adam, Rudisill, and Magee (1990) compared point-click and point-drag performance. Point-click was relatively faster and was sensitive to the width and height of the text to be selected and its distance from the starting point; pointing time in point-dragging was not related to the width of the text but was affected by the height of the text and distance.

The original Fitts' paradigm is essentially a single dimensional task. The height of the target was negligible and never was considered as an independent measure. Most targets in the applications of HCI (buttons, radio buttons, checkboxes, etc.) have both height and width constraints, and are two-dimensional.

MacKenzie and Buxton (1992) employed a 2D paradigm that involved an approach angle. They found that movement time was longer when the approach angle was 45 degrees than when it was 0 or 90 (relative to the horizontal axis). It has been found that for rectangular targets, as the angle approaches 90 from 0, the roles of the target width and height reverse. Theoretically, the pointing task can be optimized by manipulating the targets, such that *A* is decreased or *W* is increased.

Researchers have recently introduced the concept of semantic pointing (Blanch, Guiard, & Beaudouin-Lafon, 2004). The combination of Hick's Law and Fitts' Law was not entirely successful unless the combination of the two tasks was sequential.

Beggs, Graham, Monk, Shaw, and Howarth (1972) tried to model user behavior for icon driven software systems. More specifically capture time for such systems is intended to explain by integrating Hick's law and Fitts' law. In the study participants aimed for randomly indicated targets with a pencil from home position along to clicks of a metronome. However there is not any conclusion regarding combination of these two laws worked together.

Hoffmann and Lim (1997) also attempted to combine the Hick's and Fitt's laws using a home-to-target paradigm. They tested their participants with both sequential tasks and

concurrent tasks. In the former task, participants first react to a visual stimulus (light) and then make a movement from a home position to a target position. In the latter task, participants were required to lift their fingers from the home position before knowing where the target was. Hoffmann and Lim reported that total time taken in the sequential task was simply a sum of the decision time and movement time. However, the total time taken in the concurrent task showed substantial interference. The Hick-Hyman Law and Fitts' Law share much in common. Both laws employed temporally dependent measures and accuracy to address performance rates and limits of a human system. When one considers HCI research and applications of the laws, the Hick-Hyman Law falls short. This is due to the complexity of stimuli in Human Computer Interaction field. Also this law has not been validated for expert level behavior. Most of the studies are based on novice interaction.

To apply the Hick-Hyman in the traditional fashion, it is necessary first to identify the alternatives. The probabilities of these alternatives must then be determined to calculate their entropy. One reason few HCI research projects have hardly been past this stage is because there was no need to engage in the complexity of the information theoretic measures. When a task can be viewed in terms of alternatives and quantified in bits, it is likely to be too simplistic to be practical and useful. The Hick-Hyman research has been used primarily in other field which employs simple one-dimensional stimuli. Contemporary interfaces in HCI involve highly complex interfaces that frequently comprise a variety of multidimensional stimuli.

### **Text Entry on Soft Keyboards**

A recent focus is the evaluation of stylus tapping on soft keyboards, or a graphic representation of a computer keyboard. Mackenzie, Zhang, and Soukoreff (1999) evaluated six types of keyboard layouts (QWERTY, ABC, Dvorak, Fitaly, JustType, and telephone) and reported the novice and expert typing speeds. The findings lend support to the superiority of QWERTY layout over other the forms of layout. They attributed this advantage to skill transfer from desktop keyboard, for users who are already experienced with QWERTY layout.

Another area that Fitts' Law has been proven applicable is controlling navigation within a graphical user interface (GUI) environment, such as panning and zooming. Guiard, Beaudouin-Lafon, Bastin, Pasveer, and Zhai (2004) investigated multi-scale pointing and concluded that the time needed to reach a remotely located target in a multi-scale interface still obeys Fitts' Law.

William Soukoreff and Scott Mackenzie (1995) built a model for text entry on a stylus activated soft keyboard. This approach assumes that the distance traveled is the only difference between keystrokes. This formulation is heavily influenced by Fitts' Law. Stylus activated devices use simply a pen to tap keys on the screen. Since there is only one pen, this can be considered as one finger typing. In most cases the pen leads to accurate typing with few errors. The article can be divided into three parts. In the first part, the linguistic data used in the experiment is reported. It is good representation of common English. A 27 by 27 matrix is used to get

character frequency along with a space bar. In the second part, Fitts' law is used to predict the physical movement of the pen. Hick-Hyman is used to predict the visual scan time. Since every soft keyboard requires a motor act, a representation of this is included in the model. Briefly, a stimulus is presented to a subject. Then the subject visually scans for the desired character and eventually uses the pen to type the character. The physical movement of the finger while switching among the keys will take some time. The equation for Fitts' law incorporating Shannon's formulation is given below. Movement Time is expressed in terms of amplitude of the movement ( $A$ ) and width of the target area ( $W$ ).  $A_{ij}$  is the movement amplitude from location  $i$  to location  $j$ .  $a$  and  $b$  represents the start/stop time and inherent speed respectively. If the movement amplitude to target width ratio is same equation yields same results. While movement time is used to predict time for a movement, response time (RT) equation measures the time that takes a subject to respond to a stimulus.  $n$  is the number of stimulus.

$$MT = a + b * \log_2 \left( \frac{A_{ij}}{W} + 1 \right)$$

$$RT = a + b * \log_2 (n)$$

Although this is not correct for repeated keys, it is easy to implement for different characters (i.e., characters which do not repeat). The measurement of the key repeat time is important to estimate. It was empirically estimated using six participants. They were asked to hit same key for a minute and 0.153 ms mean time was found.

Some models also added a simple visual search component based to the basic Hick-Hyman (Hick, 1952) (Hyman, 1953b) model of choice reaction times (Soukoreff & MacKenzie, 1995). However, results of a recent study Sears et al. (2001a) suggest that Hick-Hyman is inappropriate for this task. Using Hick-Hyman implies that only the number of keys is important when determining which key to press.

In contrast, Sears et al. (2001b) provided evidence that both the keyboard layout (e.g., QWERTY, Dvorak) and the number of letters represented by each key (e.g., three per key on a telephone keypad) must be considered. Existing models based on Fitts' Law do not address the time involved in moving between alternative keyboards or the additional time required to enter the first character when starting a new task. Further, there appear to be fundamental problems with both Fitts' Law (Fitts, 1954) and the Hick-Hyman (Hick, 1952; Hyman, 1953a) model of choice reaction time in the context of small stylus-activated soft keyboards. The use of the Hick-Hyman model for visual search has been shown to be inappropriate by both A. Sears et al. (2001a) and Mackenzie and Zhang (2001).

The keystroke level analysis presented previously provides the first empirical evidence that Fitts' Law is not appropriate for modeling user interactions with soft keyboards. The failure of Fitts' Law to accurately model the start-up time is most important when a limited number of

characters are entered. The failure to accurately model keyboard transitions becomes important in situations where characters are required that are not available on the primary keyboard. Therefore, Sears et al. (2003) propose a KLM-style model that shifts the focus from predicting the time required to move between specific keys to predicting the total time necessary to complete tasks when multiple characters are entered. The model builds on the following definitions:

- $T$  Total task completion time;
- $t_1$  Time for the first key press when beginning a new task;
- $t_d$  Time to make a decision that a transition is required;
- $t_r$  Time to recover from a transition and complete the subsequent key press;
- $t_k$  Time for each additional keystroke (not addressed by  $t_1, t_d, t_r$ );
- $c$  Number of characters required by the task;
- $c_s$  Number of shifted characters (e.g., uppercase letters or alternative symbols);
- and
- $c_t$  Number of transitions between keyboards required by the task.

The total task completion time  $T$  is then computed as follows:

$$T = t_1 + [(t_d + t_c) * c_t] + [t_k * (c + c_s - c_t + 1)]$$

Using this equation, the predicted time showed a very high correlation with the observed time in actual experiments.

### **Stylus Activated Typing**

Numerous studies have been conducted with the goal of better understanding the efficacy of stylus-activated, QWERTY-style keyboards. Most, if not all, of these studies were motivated by the fundamental problem that users encounter entering data on small, handheld, mobile devices.



Mackenzie and Zhang (2001) studied novice users on soft keyboards. To achieve this goal, 12 participants were recruited. Two sizes of keyboard and two different layouts were used. One of the keyboards was a QWERTY keyboard and the other one was a keyboard that randomly changes the location of letters after each key entry. Random generation requires users to do a visual scan each time thus lowering the typing speed. Another question addressed in this article is whether touch typing skills are transferred to touch tapping. In the experiment two different keyboard sizes were used. Bigger keyboard had keys 10\*10 mm each, small ones, 6\*6 mm each. Each participant was given a short phrase that could be memorized thus easily avoiding the cognitive effort that is required to copy from a source. Each participant typed 10 phrases for each condition which totals 40 phrases. Each character entry time and character position were noted. Errors were ignored by the users. Mean typing speed with the fixed-large keyboard was 21.17 wpm and with the small one was 19.97 wpm. There was not any significant difference between the means. The typing speeds for the random large and small size keyboards were respectively 5.34 and 5.52 wpm. Keyboard size showed no effect on typists' performance. However there is quite big difference between the layouts. Keyboard size doesn't have an effect on typing speed which we know from Fitts' Law. As long as the ratio remained same there should be no difference, although Fitts's Law only accounts for physical movement. For the error rates, the small, fixed keyboard showed a higher rate than large, fixed keyboard. The error rates on the random keyboard were very low. This is hypothesized to be due to the cautious behavior of users. With the random keyboard, each time users type a character they have to scan and find the proper key, whereas when users type a character on the fixed keyboard, they rely on automatic motor control which is more error prone. There is an important result pertaining error rates. Fitts' law assumes no change in error rates between keyboards as long as they have the same letter sizes. But the error rates were statistically different. This is hypothesized to be a function of the visual scanning effect. Also touch typing and tapping were compared. There was a modest correlation between these two groups on fixed keyboard. But this wasn't observed with the random layout.

Sears et al. (1993), tested the effect of keyboard size on typing speed. His study investigated the soft keyboard for novice and expert users. 24 novice and 4 expert users participated in the experiments. Each letter size was 2.27, 1.14, 0.76 and 0.57 cm per side for large, medium, small and extra small sizes respectively. An ANOVA was used to analyze the results. A significant effect was observed for keyboard size among novice users. There was a difference among the expert users as well. Corrected and uncorrected error rates were measured. For novice users a significant effect was found for keyboard size on corrected errors. But there is no significant effect for uncorrected errors. Overall, the results favor large and medium size keyboards over small and extra small. Most users used one or two fingers while typing with the medium, small and extra small keyboards. However users were able to use more fingers with large keyboard set. This showed up as an effect on typing speeds and typing comfort. Below Figure 1.5 displays the results.

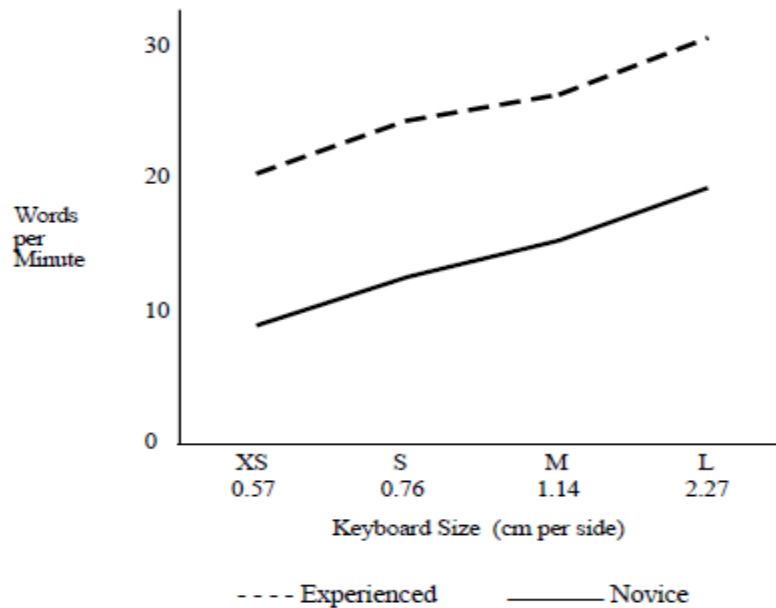
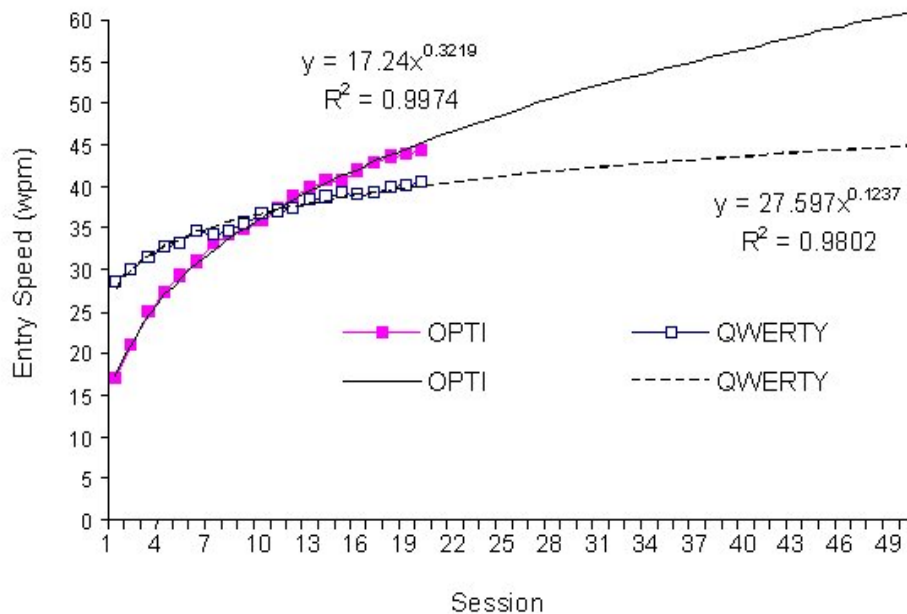

**Figure 1.5** Typing speed in terms of words per minute for varying keyboard size (Sears, Revis, Swatski, Crittenden, & Shneiderman, 1993)

Andrew Sears and Ying Zha (2003) built on the previous study using a stylus activated soft keyboard. Their study aimed to gain insight into the effectiveness of a stylus activated soft keyboard and determine whether or not keyboard size affects performance. As an extension to existing models, a key stroke tapping prediction time was included in their model. In this article 30 participants' performance was observed on three different size QWERTY soft keyboards over 6 tasks. The tasks included writing an address, entering a URL, replying to an e-mail and writing appointment information. Each participant completed all the tasks in each of the three keyboard sizes. This means  $6 \times 3 = 18$  different conditions. Unlike many other studies, users corrected most but not all of the typos during the experiment. Upon completing the test, a questionnaire was given to each participant. The experiment results and theoretical values from the mathematical model were compared. Text entry was performed using a stylus. Therefore only one hand is active in tapping. This study used the smallest sized soft keyboard in all of the studies that had been undertaken to date. Until this study, there was no research that proved validity of Fitts Law for keyboards used in this model this small. The keyboard had a button that displays punctuation and numbers. There are basically two different screens. The transition time between two keyboard layouts is important in the model. The results showed that different size of the keyboards did not have an effect on performance (data entry rate). However, the tasks did differ significantly. A counter null value is computed for each type of layout. The counter null value is a statistic first used in Rosenthal and Rubin (1994). It is used to understand research results when the null hypothesis is not rejected. Rather than saying there is no effect, the counter null value gives the size of the effect. The magnitude of effect is derived by dividing the

effect size by standard deviation for conditions being tested. Even though the keyboard size didn't show a significant effect on typist performance, the counter null value indicated that size had an effect varied between 0% and 19%. Corrected words were also recorded for each test and an ANOVA test was performed. There was also no statistically significant effect but the counter null test showed a decrease in error rates by decreasing screen size. In the paper, the authors build a mathematical model based on 4 different keystrokes. Unlike many other researches it is assumed there is a difference between keys. According to paper, the initial character takes more time than subsequent characters. This is one point to be considered. Also transitions between the keyboards are the second issue that was considered. Subsequent letter tapping time is the third issue. And also additional keys such as shift and punctuations were considered. These 4 different times were represented in a model and the results were compared with the experiment. There was a 99% correlation with mean values.

MacKenzie and Zhang (1999) proposed an alternative soft keyboard layout called OPTI. The study aims to build a model and evaluate a soft keyboard for text entry rate with a stylus.



**Figure 1.6** OPTI performance results projected (MacKenzie & Zhang, 1999)

Text entry requires the user to visually scan for a key on the soft keyboard. If we neglect this scanning time we are left with only the time it takes a user to tap a key with a pen. In the study this time alone is seen as an upper bound for entry. There are 4 major parts of the study: linguistic data, Fitts Law, a shortest path model, and a key repeat time measure. Linguistic data is the frequency of each letter in common English. Fitts' Law is used to predict the time interval between locating the key and tapping the key. There are two refinements of the model: the shortest path algorithm and the key repeat time measure. The typing speed with the proposed keyboard was slower than with the QWERTY keyboard in the first nine typing sessions. However,

in the 10<sup>th</sup> session the entry speed on the proposed keyboard (OPTI) exceeded the entry speed on the standard keyboard. At the twentieth session, the average typing speed with OPTI and QWERTY was 45 wpm and 40 wpm relatively. This result is rather surprising since it all happened in around 7 hours of training. The result is extrapolated to 50<sup>th</sup> session. For the first 20 sessions a trend line and correlation were obtained. Using these results, the model better fit typing performance on the OPTI than it did the QWERTY. This is natural because of participants' initial experience was with classic keyboard. Figure 1.6 above shows the result of the longitudinal study.

MacKenzie, Nonnecke, Riddersma, McQueen, and Meltz (1994) investigated two alternatives for entering text on pen-based computers including a stylus-activated, QWERTY-style soft keyboard. Participants used a Wacom tablet to enter 22 character phrases composed only of lowercase letters. Participants were instructed to aim for both speed and accuracy but were also instructed to ignore mistakes. When using the QWERTY keyboard, participants were able to enter over 22 wpm.

Lewis, LaLomia, and Kennedy (1999) had participants enter sentences using six paper mockups of several alternative keyboard layouts. Participants were instructed to enter sentences as quickly and accurately as possible. When errors occurred, participants were instructed to enter the correct letter (without deleting the incorrect letter) and to continue. Data entry rates for the QWERTY layout reached approximately 24 wpm.

Lewis (1999) also compared three alternatives for data entry on handheld devices including a stylus-activated, QWERTY-style soft keyboard. Participants used a Simon PDA to enter both addresses and sentences. Participants were required to produce 100% accurate text by correcting errors, but the procedure for verifying the accuracy of the results before allowing a participant to continue was not specified. Data entry rates ranged from approximately 11 wpm for addresses to 17 wpm for sentences.

### **Other Methods Used in Literature**

Different inputting strategies are investigated in the literature. Study by Potter, Weldon, and Shneiderman (1988) focuses on three different touching technique. Touch screen typing techniques are tested in terms of performance and error numbers. Since touching affects the performance, three techniques namely, land- on, take-off and first contact are identified and experimented in this article. 24 people participated and tested for different strategies for about 20 minutes each session. An evaluation questionnaire is given upon completing the tests. Subjects are given abbreviations and required the find relevant one inside the 50 of them. Abbreviations are listed alphabetically and only two letters consist of ten rows and 5 rows. In this case there is more cognitive load then simply copying and pasting a text. Subject did some practice prior to experiment and a total of 15 trials are done for each type of strategy. Analysis of variance with repetitive measure was adopted. Performance is the time interval between a

stimulus and finding the desired abbreviation. The results showed second strategy is significantly better than third strategy. Land-on strategy didn't show a significant effect over other two. There are two different error types in this study. First one is users chose wrong abbreviations and the second one is when users tapped on a blank screen thus not entering a letter. According to statistical test, take-off strategy showed significantly less errors than other two. We have three strategy and two types of errors assessed. After analysis we can see the correlation between types of errors and strategies. Take-off strategy showed fewer wrong target errors than other two.

In Magnien, Bouraoui, and Vigouroux (2004) article performance of soft keyboard with existing of visual clues are investigated. The experiment obtained three different modes which are no visual clues, visual clues and visual clues with some exceptions. Simply, when a user starts to type a word, possible letters - depending on the letter frequency - is highlighted to lessen the cognitive load of user. In the first mode there is no help thus user is exposed to full cognitive load. In the second mode there is clue and all of the possible letters are included inside the highlight. Last case had only 90% of the correct letters. Frequency of the letters is gathered from French language thus will not guarantee the results for every language. User mistakes are compared and seen that visual stimuli does not increase the error rate. Error rates were at its minimum point when the stimuli displayed all the correct characters. Overall gain was around 40%. Error-prone system deteriorates user performance but does not necessarily destroy the positive effect of the recourse to visual clues in spite of the 10% errors of setting in contrast, they provide a significant improvement.

### **Modeling of Touch Typing**

Studies divided typing process into 2 main categories. Visually guided typing and touch typing are the models. In visually guided typing, typist look for the keys to be pressed whereas touch typist know the locations from memory. Therefore visually guided typists are usually slower. There are a few other distinctions listed by Crook(1964):

- use of all 10 finger as opposed to use of one hand
- fixed key assignments
- less arm movements
- fixed locations of palms

Touch typing studies focused on sighted or visually challenged people in order to facilitate their computations. However it is still a big challenge since they rely on visual interaction (Kane et al., 2011). Kane et al. (2011) tested access overlays. Access overlays are

interaction for soft screens to increase usability. 7 females and 7 males included in this study and performed 5 tasks. Locate, count, relate, select and relocate tasks performed using 4 different techniques. These methods are edge projection, neighborhood browsing, touch-and-speak and Apple's Voice-Over. These methods provided audio feedback for participant whenever a target selected. In addition to this neighborhood browsing and touch-and-speak offer guided directions for users. Overall results indicated edge projection and neighborhood projection showed great results in terms of task completion time and correct answers. Also subjects favored these two methods over other commercial products.

### **Importance of Positioning and Feedback**

Mobile devices with capacitive or resistive touch capabilities often utilize an on-screen, virtual keyboard, or touch screen keyboard for text input. Because touch screen keyboards are software-based, they can be easily adjusted for different languages, screen orientation, and key layouts. On the other hand, touch screen keyboards have a significant disadvantage in that they lack the tactile affordances of physical hardware. Unlike only audio or only visual interfaces, a physical feedback provides interaction that can be interrupted. Without tactile feedback, users often have to switch their focus of attention between the keyboard area, where they must locate and hit the correct keys, and the text area, where they must verify the typed output. There is a significant number of articles published focusing on equipping the soft keyboards with tactile feedback. Most of the study investigated physical contribution of hardware using micro-tactile actuators.

**Home Row Positioning Information.** Much of the hap-tic feedback explored includes the use of kine-static feedback, or mouse vibrations and movement to provide users with tactile information. In our research we implemented Braille Display to provide home row positioning. We are testing efficiency of multi-model feedback along with audio which is a click sound when the key is tapped. It is not surprising that researchers focused on vibro-tactile mostly since the whole idea of touch screen is to fully utilize the screen real estate. After doing a literature review we presented a number of articles focusing on the vibrations. The efficiency of such actuator is that it takes no spaces from screen. However, its disadvantage also comes from this actuator. When the mechanism starts, whole device shakes and make it rather hard for user to get the feeling. In order to avoid this effect we use actual physical objects and tested. Some studies built very sophisticated devices.

Luk et al. (2006) explored the tactile technology. A design is proposed in order to meet user needs that is not met by visual and auditory interfaces alone. The research discussed the usage scenarios to identify which interaction way is most appropriate. Vibrator is used in order to maintain physical force. A handheld prototype is designed and built which consists of a plastic casing containing a tactile display for the thumb. 3 experiments designed namely: Range of Perceivable Stimulus Speed, Haptic Icon Discrimination Experiment and Subgroup Multi

Dimensional Scaling Experiment. Majority of the participants favored the device over traditional ones.

Brewster, Chohan, & Brown, (2007) presented a study on the use of tactile feedback for an on-screen PDA keyboard. They run experiments with and without vibro-tactile feedback under two scenarios. First experiment is done in a standard lab environment and second in an underground train. Vibro-tactile feedback is provided using an actuator at the back of the IPAQ PDA device. 6 subjects are included for this study. Dependent variables were the amount of text entered, the total number of errors made and the number of errors that were uncorrected by users. Each subject is given a poem and asked to type after a practice with device. Lab session showed that with tactile feedback users entered significantly more text, made fewer errors and corrected more of the errors they did make. Mobile session showed that the number of lines of text entered was not significantly different between the two conditions, neither was the total number of errors made. There was, however, a significant difference in the number of uncorrected errors, with more being corrected in the tactile condition (as in the lab study).

Chang and O'Sullivan (2005) compared audio-haptic interface feedback with audio only. A total of 42 subjects tested haptic and non-haptic multi-touch Motorola phones. Users asked to navigate through menu items and change the ring tones. After completing experiment session, each subject filled a questionnaire. Ratings indicated that haptic feedback is favored. Approximately half of the attendees thought audio quality was better in haptic phone. As a result, it is shown that presence of haptics improved audio perception.

Poupyrev and Maruyama (2003) implemented a tactile interface similar to our study but for small touch screen devices. A tactile apparatus is embedded in a Sony PDA. A vibro-tactile feedback is used but only for GUI components. Whenever a touchdown, dragging, hold or lift off occurred, phone provided a different reaction. For example in dragging tasks, it gave a continuous vibration. 10 Sony workers tested interface in audio, tactile and no feedback conditions. Tactile feedback was exceptionally well-received by our users who often remarked how similar tactile feedback felt to an actual mechanical switch.

Paek et al. (2010) introduced multimodal signals that provide feedback and guidance to users in the keyboard area. They compared multi-modal feedback for a small on-screen keyboard with 11 people under a combination of signal types: unexpected key, auto-correction and key prediction feedback. First group consists of auto-correction and unexpected key. Second group is auto-correction and key prediction and last group is auto-correction alone. Third group signal showed higher Key per Second value, and Average Number of Backspaces. For all of the two dependent variables, first group emerged as the best combination of signals. In summary, first group reduced KSPC by 7.7%, and reduced the number of backspaces by 27.9%

**Auditory Feedback.** The most common forms of auditory feedback used in multi-model research include the auditory icon and ear-con. Our design tests users under multi-model. Most of the research on the use of different feedback modalities has focused on the use of auditory and hap-tic feedback in uni-modal and bimodal conditions. There is an extensive literature in this field but we reviewed a small number of them. In our experiment design, auditory feedback provided with a click sound when the user strokes a key. However many study investigated different scenarios and devices.

Zhao, Dragicevic, Chignell, Balakrishnan, and Baudisch (2007) designed a touch-based auditory menu technique called ear-Pod which provides users with audio feedback that is synchronously linked to touch input. Ear-Pod is similar to Apple I-pod's touch pad which looks like a pie chart divided into 8 regions with an inner disk placed. Efficiency of the designed product is compared to I-pod with 12 volunteered students. In terms of accuracy and selection time results showed higher percentage in visual condition although there wasn't a statistically meaningful difference.

Rauterberg (1999) designed two sets of experiment to identify audio effects for man-machine systems. First, they investigated the effects of auditory feedback for a situation where the sound is given additionally to the visual feedback. In the second experiment they investigated the effects of auditory feedback of hidden events which were produced by a continuous process in the background. The first experiment employed 12, second 8. The results from first design didn't show a superior audio performance. However, second experiment indicated that the additional feedback of auditory alarms improves significantly the operator performance and increases positively some mood aspects.

Lee, Poliakoff, and Spence (2009) conducted an experiment with older adults under uni-modal, bimodal and tri-modal feedback. These sensory signals investigated for single and dual-task conditions. A subjective measure is also gathered. Results showed that bi-modal and tri-modal feedback made a positive effect on performance.

Jacko et al. (2003) investigating multi-model feedback on older people whose vision is impaired due to Age-Related Muscular Degeneration (AMD). 59 participants are asked to drag a Microsoft Word document and drop into a file folder using a mouse. This is repeated 15 times for 7 different scenarios (Auditory, Hap-tic, Visual, Auditory and Hap-tic, Auditory and Visual, Visual and Hap-tic, Auditory and Hap-tic and Visual). 4 groups are formed according to visual acuity. Study showed that multimodal feedback augment the interaction of visually impaired computer users.



## CHAPTER 2

### EXPERIMENT I

If finger positioning information and key press auditory feedback are making large, independent contributions to typing speed, then one should find a difference in the typing speeds on hand-held computer soft keyboards without positioning information or auditory feedback turned on (e.g., portrait mode, iPad) and hard keyboards which have positioning information and auditory feedback built into them (e.g., laptop computers). Additionally, if keyboards with a smaller footprint are requiring more scanning independent of positioning information and auditory feedback, then within soft keyboards I hypothesized that users would be faster with landscape layouts (larger physical layouts) than portrait layouts (smaller physical layouts). Within hard keyboards, I hypothesized that users would be faster with large keyboards than small keyboards

#### **Method**

##### **Participants**

A total of 10 participants 8 PhD level and 2 MS level graduate students were included in first experiment. All were experienced touch typists on a hard keyboard. Each one of the participants had minimum of 5 years experience with a standard keyboard. Their ages ranged from 26 to 34 with an average of 28.9 years old. There were 8 males and 2 females. In this experiment, I investigated the behavior of experienced hard keyboard touch typists who had little or no familiarity with a soft keyboard. All the participants were required to have no prior typing experience on a tablet computer. Although some of the subjects had some initial exposure, none of them used a hand held computer for typing purposes. We neglected this initial exposure and considered them as novice users.

##### **Apparatus**

In first experiment an Apple iPad 2 was used. Both portrait and landscape orientation were utilized. For a physical keyboard I used one hard keyboard QWERTY layout sized the same as the portrait mode on the iPad 2 and one hard keyboard QWERTY sized the same as the layout for landscape mode on the iPad 2. The Kensington external keyboard was used for the large physical condition. The Menotek Bluetooth keyboard was used provide small physical keyboard condition. The iPad 2 has a screen resolution of 2048 by 1536 pixels and 264 pixels per inch. In portrait orientation the on-screen keyboard has a height of 528 pixels and a width of 1536 pixels. In landscape mode, it has 704 by 2048 pixels height and width respectively. In landscape and portrait mode each key has a 1.43 cm and 1.07 cm edge. We used approximately the same

size physical keyboards. A pixel is the smallest unit of an image in a display device. Sharper images usually have more pixels. However it is not a measure used for physical entities in general. Regarding our physical apparatus, no dimensions in pixels were given by the manufacturer.

### **Stimuli**

Mayzner and Tresselt (1965) analyzed 20,000 English words and obtained single letter and bi-gram letter frequency. They used words 3 to 7 characters length for estimating bi-gram frequency. There are also other studies that focus on this particular topic, but this study was used as the reference.

MacKenzie and Soukoreff (2003) published 500 text phrases and measured their correlation with Mayzner and Tresselt's study. I used the sentences that were listed in this study but relatively fewer of them. Briefly, two criteria were considered for selecting sentences that had:

- A high correlation with Mayzner and Tresselt (1965); and
- Been previously tested in other studies on text entry.

For my first experiment 2 groups of phrases were selected, each consisting of 10 sentences. Examples include the following:

#### Passage 1:

Sentence 1: the first time he tried to swim

Sentence 2: that referendum asked a silly question

Sentence 3: a steep learning curve in riding a unicycle

Sentence 4: a good stimulus deserves a good response

Sentence 5: everybody loses in custody battles

Sentence 6: put garbage in an abandoned mine

Sentence 7: employee recruitment takes a lot of effort

Sentence 8: experience is hard to come by

Sentence 9: everyone wants to win the lottery

Sentence 10: the picket line gives me the chills

Passage 2:

Sentence 1: the water was monitored daily

Sentence 2: he watched in astonishment

Sentence 3: a big scratch on the tabletop

Sentence 4: salesmen must make their monthly quota

Sentence 5: saving that child was a heroic effort

Sentence 6: granite is the hardest of all rocks

Sentence 7: bring the offenders to justice

Sentence 8: every Saturday he folds the laundry

Sentence 9: careless driving results in a fine

Sentence 10: microscopes make small things look big

The stimuli in the two sets of sentences are characterized in more detail below.

**Table 2.1** Sentence characteristics of first experiment as indexed by letters per sentence

Sets	Sentences	min length	max length	avrg. length
Set 1	10	29	43	35.7
Set 2	10	26	38	33.1

Table 2.1 shows the minimum and maximum number of letters in each set of sentences. The average length was also measured. “Min length” refers to the sentence which has minimum letter count. “Max length” refers to the sentence which has the maximum character count in a set. In first passage, shortest and longest sentences have 29 and 43 characters respectively. The entire passage has an average of 35.7 characters per sentence as indicated.

Table 2.2 summarizes letter wise comparison. The first set of sentences has a total of 64 words with word length varying from 1 (“a”) to 11 (“recruitment”). “Min length” refers to the word which has the minimum letter count. “Max length” refers to the word which has the

maximum letter count. There are 52 unique words in the first set, 48 in the second set. The average word length is 4.72 characters per word.

**Table 2.2** Sentence characteristics of first experiment as indexed by letters per word

Set	Words	Min Length	Max Length	Average Length	Unique Words
Set 1	64	1	11	4.72	52
Set 2	58	1	12	4.9	48

Table 2.3 gives us the correlation with Mayzner and Tresselt (1965). Letter frequency of each letter in our text passages and Mayzner and Tresselt (1965) are dependent variables whereas character is the independent variable. We can consider characters “A” thru “Z” as categorical variables on x-axis and single letter frequency of our study as quantitative variable represented on y-axis. For each letter on x-axis we have a frequency value associated with it on y-axis for both our and previous study. Specifically, the number of instances of letters A – Z in the first passage is correlated with this number in Mayzner and Tresselt. In this 2 sets of passages, it is clear that the second passage has a higher correlation and is assumed a better representative of English. Letters refer to total number of letters in each passage including repetitive characters.

**Table 2.3** Correlation result of first experiment

Sets	Letters	Correlation
Set 1	356	0.8908
Set 2	332	0.9621

### Experimental Design

All participants were given the iPad first and then a hard keypad. The first passage was given to subjects and they were asked to type the passage using the iPad in landscape orientation. The second passage was typed in portrait orientation. Similarly subjects used the

larger keyboard layout first and the smaller keyboard layout second. The first and second passages were given in the same order. Task start and completion times were recorded. Participants' times were converted to words per minute.

### **Procedure**

First the participants were given a brief introduction to how the experiment proceeds. Then, their typing speeds using a hard keyboard were measured. The subjects were then be evaluated in the 4 different conditions described above. Participants were required memorize each sentence before typing it. By doing this, I hoped to minimize the practice effect. Each sentence was displayed on a flashcard above the keyboard. The participant indicated when he or she had memorized it and the flashcard was removed.

### **Dependent Variables**

There are two dependent variables measured for this experiment. First, task completion times were recorded. Also the total number of backspaces was collected. These two measurements are important since task completion time is not the only variable of interest. The number of mistakes and the kinds of mistakes are also of interest. Task completion times are recorded from the moment a typist strikes the first letter to the moment a typist releases the last letter. The inter keystroke interval is the time that elapses from the moment that the participant presses the first letter to the moment the participant presses the second letter.

### **Results**

Below in Table 2.4 are the results for the experiment. The numbers in the table represent the words per minute values. On average individuals typed faster with the large (landscape) layouts than they did with the small (portrait) layouts.

**Table 2.4** Participants typing speed in words per minute

	Soft		Physical	
	Landscape	Portrait	Large	Small
<b>Subject 1</b>	17.086	19.223	26.597	32.238

<b>Subject 2</b>	20.270	21.814	42.995	23.612
<b>Subject 3</b>	29.702	16.739	21.936	30.308
<b>Subject 4</b>	24.393	18.836	33.131	22.076
<b>Subject 5</b>	17.329	26.707	40.115	22.050
<b>Subject 6</b>	37.317	18.432	30.496	28.221
<b>Subject 7</b>	25.687	26.443	27.043	28.441
<b>Subject 8</b>	19.064	20.691	32.330	28.536
<b>Subject 9</b>	16.531	26.325	25.296	24.448
<b>Subject 10</b>	19.923	14.645	29.802	15.614
<b>Mean</b>	22.73	20.99	30.97	25.55
<b>Std. Dev.</b>	6.66	4.27	6.54	4.94

A repeated measures analysis of variance was performed with two levels of keyboard types (soft versus hard) and two levels of keyboard arrangement (landscape/large versus portrait/small) using SPSS. There was a main effect of the type of keyboard,  $F(1, 9)=24.471$ ,  $p < .001$  (Table 2.5). On average, participants with a hard keyboard typed 28.27 words per minute whereas participants with a soft keyboard typed only 21.79 words per minute. The difference in the types of keyboard arrangement was only marginally significant,  $F(1,9)=4.003$ ,  $p < .0764$ . Participants were slightly faster with the landscape/large keyboard (26.82 words per minute) than they were with the portrait/small keyboard (23.24 words per minute).

**Table 2.5** Tests of Within-Subjects Contrasts. [Levels are the sizes (e.g. Large Small) for each layout (e.g. Hard, Soft).]

Source	Soft	Hard	SS	df	F	Sig.	ES
Soft	Level 1 vs. 2		410.420	1	24.471	.001	.731
Hard		Level 1 vs. 2	128.322	1	4.003	.076	.308
Soft * Hard	Level 1 vs. 2	Level 1 vs. 2	135.056	9	.592	.461	.062

It was also of interest to know whether there was a correlation between the typing speeds of individuals on the various different keyboards or, instead, the keyboards introduced difficulties which interacted with users' typing skills. To test this, I performed all pair wise correlations. A positive correlation indicates that increases in typing speed in one condition were associated with increases in typing speed in the second condition. A negative correlation indicates that there is an inverse effect. This simply means that whoever types fast in one layout types more slowly in other or vice versa. The correlation results are given in Table 2.6. Curiously, negative correlations were observed within the same form factors, e.g., the correlation of portrait and landscape soft keyboard typing speeds and the correlation of small and large physical keyboard typing skills.

**Table 2.6** Correlation results for different situation

	<i>Landscape</i>	<i>Portrait</i>	<i>Large/Phys.</i>	<i>Small/Phys.</i>
<i>Landscape</i>	1			
<i>Portrait</i>	-0.35705557	1		
<i>Large/Phys.</i>	-0.25181055	0.23942795	1	
<i>Small/Phys.</i>	0.285417697	0.1001889	-0.4324651	1

The pair-wise results for the largest positive correlation between keyboards with different form factors (Small Physical hard keyboard and Landscape Orientation soft keyboard) are plotted in Figure 2.1. Both a curve and line are fit to the observations. The typing speeds of an individual in the two conditions are plotted as blue dots. The X-axis represents the values for the small physical keyboard and the Y-axis represents the corresponding values for the

Landscape orientation. The correlation for the curve that was fit was much higher than that for the line, but the curve is clearly capitalizing on change. The correlation may be positive here because one finger typing is likely to be used

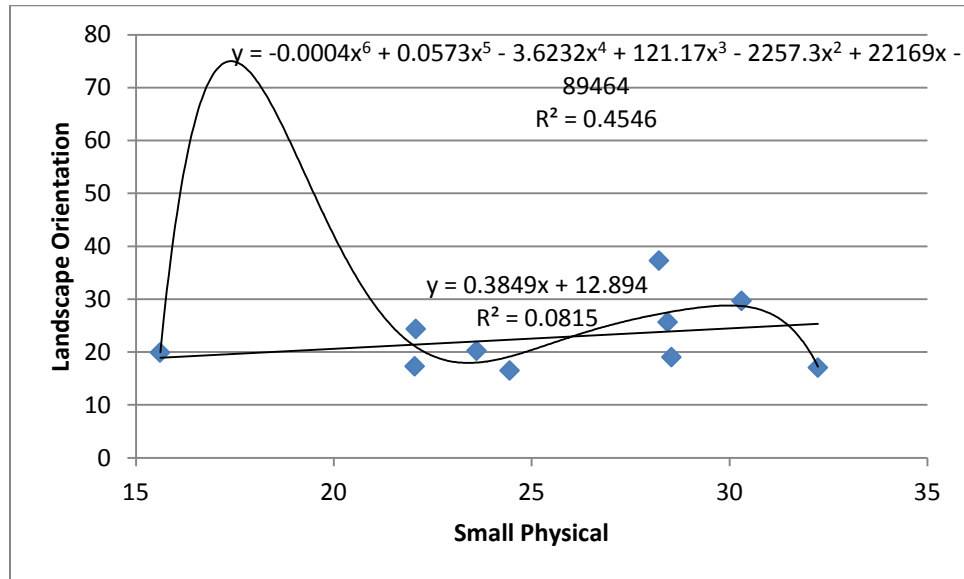

**Figure 2.1** Plot graph of highest positive correlation

The pair-wise results for the largest negative correlation between keyboards with different form factors are graphed below in Figure 2.2. This figure shows the relation between typing speeds in the Landscape orientation soft keyboard and large physical keyboards. Again the curve has a higher  $R^2$  than the line. The correlation may be negative here because the large physical keyboard allows for touch typing whereas the soft keyboard, even with a landscape orientation, may not allow touch typing. Why the correlation should be negative, however, is not clear.



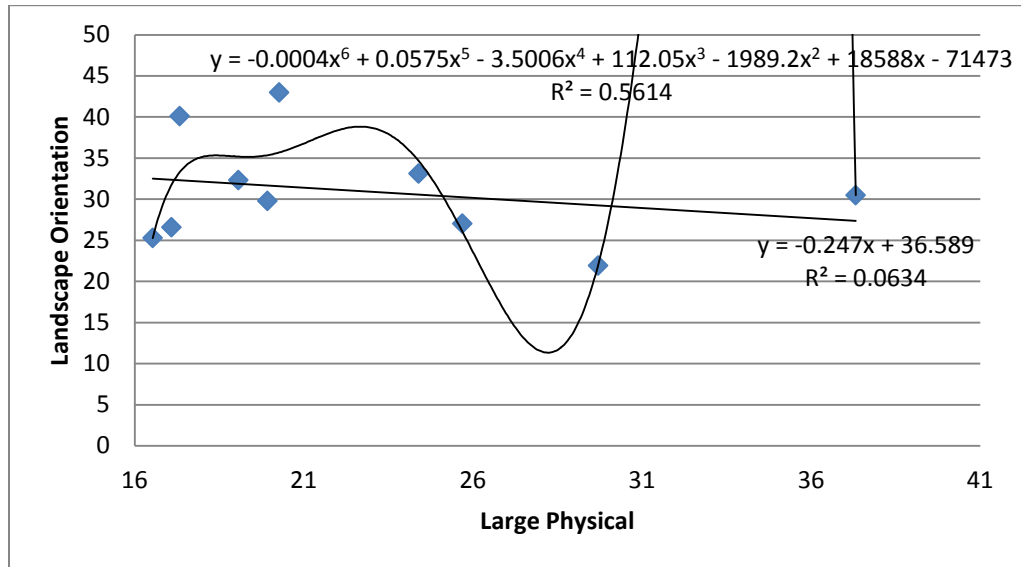

**Figure 2.2** Plot graph of highest negative correlation

### Discussion and Limitations

Not unexpectedly, the users were faster to type with the hard keyboard (with which they had experience) than they were to type with the soft keyboard (with which they had little experience), even though the size of the two keyboards was controlled as best as possible. This suggests that home row finger positioning information and key press feedback are important variables. Moreover, users were faster in landscape mode than in portrait mode, although the difference was not statistically significant. This suggests that spreading out the keys horizontally helps, perhaps by requiring a typist to make fewer eye movements to double check that his or her fingers are positioned correctly in the landscape mode.

There is one major limitation. In this experiment, the four conditions were not counterbalanced. Specifically, for all participants the conditions always appeared in the following order: (i) iPad, landscape orientation, first set of sentences; (ii) iPad, portrait orientation, second set of sentences; (iii) physical keyboard, large, first set of sentences; and (iv) physical keyboard, small, second set of sentences. It is true the typing speeds were faster on the physical keyboards; it is also true that this is the second time the passages are being typed. Thus one cannot separate the effect of device (iPad versus physical keyboard) from the effect of practice. Having said this, all typists were experienced. The effect of practice for experienced typists on finger movement time is presumably minimal. Additionally, the typists entered each sentence from memory. Thus, in neither the first or second instance in which the typist entered a sentence did the typist need to glance back towards the sentence. Thus, there should be no effect of practice on the time typists spend scanning the sentence which is to be entered.

Assuming that the effect of the type of device is real (and therefore the effect of position information and auditory feedback is real as well), the real question at this point is whether home row positioning information and key press feedback can improve performance in soft keyboards the same way that they do in hard keyboards. The next experiment is an attempt to answer this question.

## CHAPTER 3

### EXPERIMENT II

In Experiment 2 an attempt was made to determine whether the addition of home row positioning information (tactile feedback), auditory feedback, or both to a soft keyboard increased the typing speed of experienced soft keyboard users if. There were two levels of feedback (Factor 1) and two levels of positioning information (Factor 2). The two factors were crossed, leading to four conditions in Experiment 2: soft keyboards without auditory or position feedback, soft keyboards with auditory, but no positioning feedback, soft keyboard with positioning feedback but no auditory feedback, and soft keyboards with both positioning and auditory feedback. Participants were asked to type one passage in each of the four conditions. Average typing speeds for each of the passages was measured and averaged across participants within conditions. In addition, the movement time between any pair of keys  $i$  and  $j$  will be recorded. Eye movements will be recorded with aid of an ASL Mobile EYE tracker.

In order to determine why it is that home row positioning and key strike feedback alter performance, eye behaviors, movement times, and inter-keystroke intervals were measured. If home row position information is important, typists using soft keyboards with this information should glance less frequently at the top or bottom rows. Presumably they should be able to use the position information to guide their motor movements. Contrariwise, typists using soft keyboards without home row position information should distribute their glances more evenly across the three rows. If auditory key strike feedback is important, soft keyboards without this information should have longer inter-keystroke intervals even on trials where the typists does not need to glance at the keyboard. This follows since the typist will process less quickly the fact that a finger has landed on a key. More generally, if positioning information and auditory feedback are having an effect on typing speed they should reduce search time as well.

#### **Method**

##### **Participants**

A total of 24 participants participated in the experiment. The age of the participants varied between 20 and 30. All were experienced touch typists with a hard keyboard. Yechiam, Erev, Yehene, and Gopher (2003) reported 60 to 70 words per minute as the average typing speed for touch typists whereas it is 30 to 40 wpm for experienced visually guided typists. Based on the literature values, we expected our subjects to type as fast as 60 words per minute on a standard keyboard. Additionally, each participant had to have had at least 5 hours typing experience with an iPad soft keyboard.

## Stimuli

Five sentences for each set of four passages (A – D) were used. The entire body of sentences is included in the Appendix. Example sentences from each passage are given below:

Sentence A.1 *the water was monitored daily*

Sentence B.1 *my watch fell in the water*

Sentence C.1 *elephants are afraid of mice*

Sentence D.1 *movie about a nutty professor*

**Table 3.1** Sentence characteristics of second experiment as indexed by letters per sentence

Passages	Number of Sentences	Sentence Min. Length(words)	Sentence Max. Length(Letters)	Sentence Average Length(Letters)
A	5	26	38	32
B	5	22	33	28
C	5	22	30	26.2
D	5	24	33	30

In Table **3.1**, various characteristics of the sentences in the passages are given. “Min length” refers to the letter count for the shortest sentence. “Max length” refers to the longest sentence character count. “Avrg length” refers to average letter count across sentences in each passage. Additional characteristics of each passage are displayed below in Table 3.2. The table reports a comparison of passages in terms of letter counts in words.

**Table 3.2** Sentence characteristics of second experiment as indexed by letters per word

Passages	Total Words	Min Length Word(Letters)	Max Length Word(Letters)	Avrg Length Word(Letters)	Total Unique Words
A	28	1	12	5.71	26
B	26	2	10	5.38	22
C	28	1	9	4.68	22
D	30	1	9	5.00	29

It is important from the standpoint of the generalizability of the results that the letter frequency of the sample sentences in each passage be roughly equivalent to the letter frequency in the larger population of sentences [e.g., see Mazyner & Tresselt, 1965]. Table 3.3 gives the letter count of each text passage and the correlation with the letter count in the corpus used by Mayzner and Tresselt (1965). The results indicate a high correlation with minimum and maximum correlation values 0.8419 and 0.9499 respectively. Such high correlations help ensure that the behaviors observed with the experimental corpus of passages will be observed in the real world.

**Table 3.3** Correlation results of passages

Passages	Total Letters	Correlation
A	160	0.9499
B	140	0.8911
C	131	0.8979
D	150	0.8419

The letter frequencies across passages were summed and a chi-square test was used to compare the overall letter frequencies of the passages with those of Mazyner and Tresselt (1965). In particular, let  $N_{ij}$  be the observed number of letters in the  $i^{th}$  position in the alphabet for either the passages ( $j= 1$ ) or Mazyner and Tresselt ( $j = 2$ ). Let  $p_{ij}$  be the predicted proportion

of letters (from Mazzyner and Tresselt). And let  $n$  be the total number of letters which were in the four text passages. Then I can compute chi-square as follows:

$$X^2 = \sum_{j=1}^{26} \left[ \sum_{i=1}^2 \frac{(N_{ij} - np_{ij})^2}{np_{ij}} \right]$$

Define the null hypothesis as follows:

$H_0$  : *There is no statistically significant difference between the letter frequencies in the corpus used in Experiment 2 and the corpus used in Mayzyner and Tresselt (1965).*

A Chi-square statistic was computed for each of the four passages and in all four cases the  $p$  value is greater than 0.05. Therefore, one cannot reject the null hypothesis (though for passage A the difference is marginally significant). In each of the cases, the relationship is very strong. This implies our sample data is reliable based on previous study. The test was done using a 95% confidence interval. The table below shows the results of the analysis. All text passages have higher  $p$  value than our significance level. Cramer's V is used to show the strength of correlation between the single letter frequencies in Mayzner and Tresselt (1965) our text passages letter frequencies.

**Table 3.4** Chi square test result for experiment II passages

Passage	Value	df	$p$	Cramer's V
A	364	322	0.053	1
B	427	391	0.098	0.984
C	372	345	0.147	0.978
D	390	368	0.206	0.968

## **Apparatus**

In our tests for touch typing skills a standard desktop hard keyboard an Apple Ipad2 soft keyboard was. Home row position information was given to typists by affixing small raised dots on the home row keys. Auditory feedback was given to typists by turning on the audible key click. An ASL Mobile Eye tracker was used to sample the position of the eye 30 times a second. Briefly, the eye tracker consists of both a video camera and infrared optics. Software is used to overlay a cross on the video indicating where the individual is looking in real time. Fixations can be identified with the software as well as fixation durations.

## **Experimental Design**

There are four conditions, the four conditions obtained by crossing position information (present or absent) with auditory feedback (present or absent):

- (I) Position information and auditory feedback (P-F)
- (II) Position information with no auditory feedback (P-NoF);
- (III) No position information with auditory feedback (NoP-F); and
- (IV) Neither position information nor auditory feedback (NoP-NoF).

It is necessary to counterbalance the order of the conditions across subjects. With four different conditions there are 24 possible orders. All orders were used (one order per participant). Similarly, it is necessary to counterbalance the passages so that all four passages occur equally often with all four conditions and equally often in all four positions – first, second, third and fourth. Table 3.5 represents in what order passages were presented to subjects. As can be seen in the table, each passage occurs equally in each position. Conditions vary for each participant and all possible ordering will be tested. In each condition (I – IV), a subject typed passages A, B, C and D but with a different ordering. Thus, 20 sentences were typed for each condition. In the table below the first subject was tested in condition (I) and typed passages in the order B, D, A, C. Then condition (II) was tested with the passages typed in the order D, C, B, A. Next condition (III) was evaluated and the passages typed in the order A, B, C, D. Lastly condition (IV) was tested and the passages typed in the order C, A, D, B. The rest of the subjects and order of sentences were as described below.

**Table 3.5** Counterbalancing for conditions

<b>Conditions</b>	<b>Order of Sentences</b>			
(I) (II) (III) (IV)	<i>B D A C</i>	<i>D C B A</i>	<i>A B C D</i>	<i>C A D B</i>
(I) (II) (IV) (III)	<i>B D A C</i>	<i>D C B A</i>	<i>C A D B</i>	<i>A B C D</i>
(I) (III) (II) (IV)	<i>B D A C</i>	<i>A B C D</i>	<i>D C B A</i>	<i>C A D B</i>
(I) (III) (IV) (II)	<i>B D A C</i>	<i>A B C D</i>	<i>C A D B</i>	<i>D C B A</i>
(I) (IV) (II) (III)	<i>B D A C</i>	<i>C A D B</i>	<i>D C B A</i>	<i>A B C D</i>
(I) (IV) (III) (II)	<i>B D A C</i>	<i>C A D B</i>	<i>A B C D</i>	<i>D C B A</i>
(II) (I) (III) (IV)	<i>D C B A</i>	<i>B D A C</i>	<i>A B C D</i>	<i>C A D B</i>
(II) (I) (IV) (III)	<i>D C B A</i>	<i>B D A C</i>	<i>C A D B</i>	<i>A B C D</i>
(II) (III) (IV) (I)	<i>D C B A</i>	<i>A B C D</i>	<i>C A D B</i>	<i>B D A C</i>
(II) (III) (I) (IV)	<i>D C B A</i>	<i>A B C D</i>	<i>B D A C</i>	<i>C A D B</i>
(II) (IV) (I) (III)	<i>D C B A</i>	<i>C A D B</i>	<i>B D A C</i>	<i>A B C D</i>
(II) (IV) (III) (I)	<i>D C B A</i>	<i>C A D B</i>	<i>A B C D</i>	<i>B D A C</i>
(III) (I) (II) (IV)	<i>A B C D</i>	<i>B D A C</i>	<i>D C B A</i>	<i>C A D B</i>
(III) (I) (IV) (II)	<i>A B C D</i>	<i>B D A C</i>	<i>C A D B</i>	<i>D C B A</i>
(III) (II) (I) (IV)	<i>A B C D</i>	<i>D C B A</i>	<i>B D A C</i>	<i>C A D B</i>
(III) (II) (IV) (I)	<i>A B C D</i>	<i>D C B A</i>	<i>C A D B</i>	<i>B D A C</i>
(III) (IV) (I) (II)	<i>A B C D</i>	<i>C A D B</i>	<i>B D A C</i>	<i>D C B A</i>
(III) (IV) (II) (I)	<i>A B C D</i>	<i>C A D B</i>	<i>D C B A</i>	<i>B D A C</i>
(IV) (I) (II) (III)	<i>C A D B</i>	<i>B D A C</i>	<i>D C B A</i>	<i>A B C D</i>



(IV) (I) (III) (II)	<i>C A D B</i>	<i>B D A C</i>	<i>A B C D</i>	<i>D C B A</i>
(IV) (II) (I) (III)	<i>C A D B</i>	<i>D C B A</i>	<i>B D A C</i>	<i>A B C D</i>
(IV) (II) (III) (I)	<i>C A D B</i>	<i>D C B A</i>	<i>A B C D</i>	<i>B D A C</i>
(IV) (III) (I) (II)	<i>C A D B</i>	<i>A B C D</i>	<i>B D A C</i>	<i>D C B A</i>
(IV) (III) (II) (I)	<i>C A D B</i>	<i>A B C D</i>	<i>D C B A</i>	<i>B D A C</i>

### Procedure

Experiments were completed with a total of 24 people from University of Massachusetts Amherst community. First the participants were given a brief introduction to how the experiment proceeds. Then, their typing speeds using a hard keyboard were measured. The subjects were then be evaluated in the 4 different conditions described above. An iPad2 was used to gather their typing behavior. Subjects were expected to type the passages they were shown into a graphical user interface where data was gathered related to each key press, key release and key type times. Each passage was displayed on iPad screen above the keyboard. There were a total of three components with which the participant interacted on the screen. The individual sentences were displayed using flashcards. Each key event was recorded so that the task completion times, movement times and inter keystroke intervals can be measured. Upon completion of a task, a new condition was initialized for subjects. There were a few minutes idle time between conditions for arranging the settings required for a new condition (e.g., the key click tone, Braille display). Before testing began, the eye tracker device was mounted on the participant's head. In order to measure eye movements, the device was calibrated accordingly. When the subject completed a set of sentences, the experimenter presented the new sentence set until all 4 sets were typed. The conditions were counterbalanced and the passages within conditions were presented in a different order each time in order to reduce practice effects.

### Dependent Variables

Four dependent variables were measured for each letter pair. There are 26 choose 2 letter pairs, or a total of 325 letter pairs. (1) First, measures were made of glances between sequential letter pairs *i* (launch) and *j* (target). This will be labeled as the inter-letter glance likelihood (or just glance likelihood). It will be recorded as 0 if the typist does not look away from letter *i* before moving to or during the movement towards *j*. It will be recorded as 1 otherwise. (2) Second, measures will be made of the inter-letter search time (or just search time) when participants do scan. The inter-letter search time will be defined as the sum of the glance durations away from letter *i* before launching towards letter *j*. (3) Third, measures will be

made of the inter-letter movement time (or just movement time) using a JAVA API. This time will be measured from the moment the finger leaves the launch key  $i$  until the moment that the finger arrives at the target key  $j$ . Note that in most cases this will include only the movement time, easily predicted by Fitts' law when it is the same finger. However, on some occasions participants may be glancing while they move their finger. These times will not be included in the computation of the movement time.

## **Results**

Briefly, iPad expert level typists' behavior was compared across in four conditions. The four conditions studied were: position information-no auditory feedback (P-NoF), position information-auditory feedback (P-F), no position information-auditory feedback (NoP-F), and no position information-no auditory feedback (NoP-NoF). Position information is considered as a physical cue that might be provided with, say, a Braille display that is installed on an iPad. Auditory feedback is provided with the iPad's custom built key click sound which beeps as soon as the finger lands on a key. A software program was developed that returns each key stroke time (e.g., key press time and key release time). A mobile, head mounted, eye tracker device which tracks participants' eye movements was used to gather data as well. After carefully collecting data from participants, statistical tests were undertaken to evaluate the various hypotheses. Time data for both finger movement and task completion are analyzed immediately below.

### **Time Data**

Time data is an essential indicator of performance. Data is collected in milliseconds to have a precise measure. A total of twenty four data sets for task completion times were gathered whereas 21 were gathered for eye movements. Due to reasons regarding subjects' physical attributes (e.g. eye lid aperture), the eye tracker results could not be obtained for three participants. Therefore these three participants weren't included in average time data reported below.

**Finger Movement Time: One Finger Typing.** As was mentioned before, the finger movement time is described as the time which elapses from when a key is released by a given finger to when the next key is pressed by the same finger. The finger movement time does not include the time to depress a key and therefore the sum of the finger movement times is not equal to the task completion time. Note that the finger movement times are computed for the non-character space bar as well as the character and numeric keys. An attempt was made to measure the finger movement time both in situations where an individual was a one finger typist (hunt and peck) and in situations where the individual typed with multiple fingers.

The results for one finger typing are reported here. It was hypothesize that there would be an effect of audio feedback on one finger typing, but no effect of position information. The

descriptive statistics are indicate that the fastest finger movements are recorded when the audio feedback is present and position information is not present.

**Table 3.6** Descriptive Statistics for Finger Movement

	Mean	Std. Deviation	N
P-F	132.8	22.5	16
P-NoF	135.7	14.8	16
NoP-F	127.1	13.1	16
NoP-NoF	139.3	20.6	16

An ANOVA was used to determine whether there was a significant effect of either position information or feedback. The effect of audio feedback is significant, but there is no effect of position information nor is there an interaction. This is consistent with the hypothesis. However, note that audio has a much larger effect when position information is not present (139.3 s without audio feedback versus 127.1 s with audio feedback) than when it is not present (135.7 s without audio feedback versus 127.1 s with audio feedback).

**Table 3.7** Analysis of One Finger Movement Times: Effect of Audio Feedback and Position Information

Source	Position	Audio	Mean Square	F	Sig.
position	Level 1 vs. 2		17932048	.117	.738
audio		Level 1 vs. 2	916507507	2.965	.106
position * audio	Level 1 vs. 2	Level 1 vs. 2	1377838720	2.233	.156

**Residual Finger Movement Time: Multiple Finger Typing.** Not all typists use only one finger while typing. In this case, it becomes more difficult to analyze the finger movement time. To understand what is happening, it is necessary to decompose the finger movements into three different types. (a) The individual can press key 1 with finger 1 ( $P_1$ ), release key 1 with finger 1 ( $R_1$ ; the numeric labels are arbitrary) and then, using that same finger, press the next key 2 ( $P_2$ ). The finger movement time is set equal to  $P_2 - R_1$ . It is being assumed here that the second key press,  $P_2$ , is being made by finger 1. This is not necessarily always the case. (b) The individual can press key 1 with finger 1, press key 2 with finger 2, release finger 2 from key 2, and then release finger 1 from key 1. Clearly the quantity  $P_2 - R_1$  does not yield the finger movement time (it is negative). This is because two fingers are involved in this scenario. (c) The individual can press key 1 with finger 1, press key 2 with finger 2, release finger 1 and then release finger 2. Again, the above difference is negative and is not the correct difference to use in order to estimate the finger movement time. The figure below depicts all three cases mentioned.

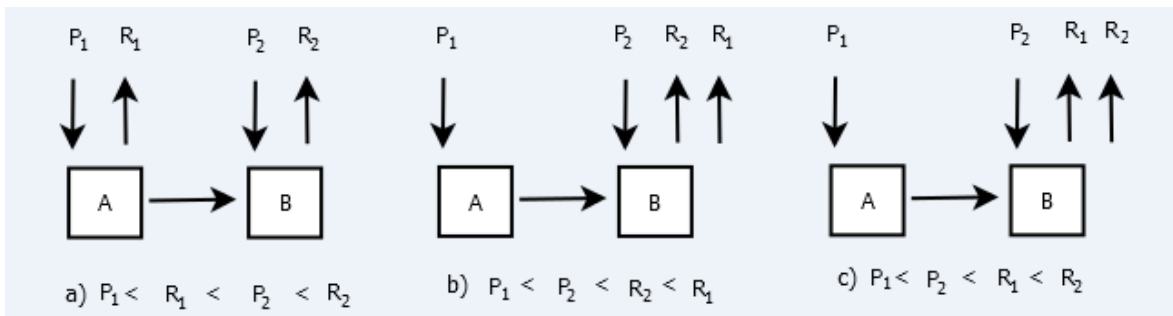

**Figure 3.1** Different letter transition cases

The sequence of key presses and key releases is an important factor in the computation of finger movement times. In cases similar to first case above, the finger movement time is calculated as key press time for second key minus the release time for the first key ( $P_2 - R_1$ ). In other cases, as can be seen from the figure above, the time at which the first key is released ( $R_1$ ) is later than the time at which the second key is pressed ( $P_2$ ). Using the above difference to compute the finger movement time would lead to negative finger movement times, something which clearly is not possible. Multiple fingers are used to type the letters in this case

As one way to deal with this problem, I will compute what I define as the *residual finger movement time*. It is equal to the time that the typist spends between adjacent key presses  $i$  and  $j$  moving his or her fingers, assuming that the typist released his or her finger on key  $i$  at a time equal to the average key depression time for key  $i$ . The average key depressing time (defined as  $R_i - P_i$ ) for a given finger is derived to estimate finger movement time for the second and third cases. All letter transitions are analyzed and those which follow the first pattern are incorporated into the calculation of the average finger movement time as is. The average key depressing time is added to key press time of first letter in the other two cases and the difference between the time at which the second key is pressed and this sum [ $P_2 - (P_1 + \text{average}$

key depressing time)] is used to estimate the finger movement time. There will still be some cases where this is negative and these cases are excluded.

A simple algorithm was used to compute the average key depressing time. To begin, the following definitions are needed:

$i$  = rank of a character in a string (e.g. word)

$N$  = total number of characters in tasks

$P_i$  = key press time for letter  $i$

$R_i$  = key release time for letter  $i$

$totalOccurence$  = total number of times that a certain case occurs in a typing task

$totalDepressingTime$  = total time spent on key depressing

$averageKeyDepressingTime$  = average time spent on key depressing

The algorithm used to compute the average key depressing time is then as given below:

```

Data: Letter press time and release time
Result: Average key depressing time
while  $i < N$  do
  if  $P_{i+1} > R_i$  then
     $totalDepressingTime = totalDepressingTime - P_i + R_i;$ 
     $totalOccurence ++;$ 
     $i ++;$ 
  else
     $i ++;$ 
  end
   $averageKeyDepressingTime = \frac{totalDepressingTime}{totalOccurence};$ 
end

```

**Figure 3.2** Algorithmic representation of key depressing time derivation

After obtaining an average key depressing time, the residual finger movement times are computed for all inter-letter transitions. So far the discussion has focused on how the data were manipulated in order to obtain better estimates of the residual finger movement times. The remainder of this section is devoted to a discussion of the tests used to identify the effects of the factors that were manipulated in the experiment on the residual finger movement times. In order to test for the effects of position information and auditory feedback on the residual finger movement times, a two way ANOVA was performed with two levels of position and two levels of auditory feedback. The table below shows the factors and conditions within the factors.

**Table 3.8** Experiment design for within subjects

Position	Audio	Dependent Var.
1	1	P-F
	2	P-NoF
2	1	NoP-F
	2	NoP-NoF

In the above table there are 2 levels for each condition which makes a total of 4 different conditions. Conditions are shown as “P” and “F” which are *position information* and *audio feedback* respectively. Subject data is organized following this guideline and Analysis of Variance (ANOVA) test is done.

The table below summarizes the descriptive results. Twenty-four subjects participated in this study. All subjects tested for all conditions as defined before. Passages and conditions are counterbalanced across the participants. “N” represents the number of total participants. Standard deviation and mean values are calculated considering all observations for corresponding conditions. Both the standard deviation and mean tend to increase when there are no cues provided. There is a small exception to this trend for the third condition (NoP-F). A decrease of approximately 18% in the residual finger movement time is achieved after providing the iPad with both position information and auditory feedback. This calculation is based on mean values.

**Table 3.9** Descriptive Statistics for ANOVA test in finger movement

Conditions	Mean	Std. Dev.	N
P-F	117.1	14.3	24
P-NoF	135.3	24.1	24
NoP-F	137.7	40.3	24
NoP-NoF	138.1	27.7	24

A box plot graph is also given below. The y-axis shows the values in milliseconds whereas the x-axis shows the different conditions.

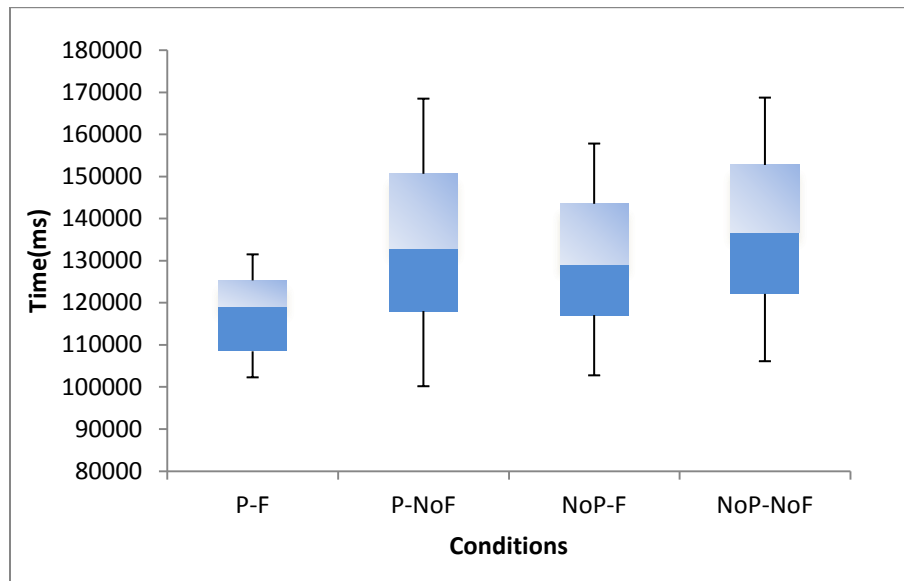

**Figure 3.3** Box plot graph for finger movement times for different conditions

In above figure, the whiskers below each box show the minimum value -- fastest finger movement -- and whiskers above each box show the maximum value -- slowest finger movement. The point at which the colors change inside a box is the median value of all participants for the corresponding condition. The upper and lower edges of the boxes are 75 and 25 percentile values. This indicates that upper edge includes 75% of the observations whereas lower edge includes 25% of the total participant data. As can be seen above, when both cues are provided values are clustered whereas lack of feedback caused values to be dispersed.

An ANOVA (Analysis of Variance) was used to evaluate the effect of the different factors and their interaction on the finger movement time. A 2 by 2 experimental design implies that there are 3 hypotheses to be tested. The first two of them are the main effects of the factors whereas the last one is the interaction of these two. The table below displays the results of these analyses. There is a main effect of position information, but no effect of audio feedback. In other words it can be said that applying the Braille display helped users and reduced their residual finger movement time. The presence of an interaction is also an important consideration for two factor tests. Although it is not significant for this data, it might help to identify the source of the difference. Based on the average subject performances, one can conclude subjects performed best in the 1<sup>st</sup> condition and worst in the 4<sup>th</sup> condition. When there is only one cue presented subjects performed better with only physical cue than only audio feedback.

**Table 3.10** ANOVA Test for residual finger movement time

Source	Position	Audio	F	Sig.
Position	Level 1 vs. Level 2		6.351	.019
Audio		Level 1 vs. Level 2	3.430	.077
Tactile * Audio	Level 1 vs. Level 2	Level 1 vs. Level 2	4.040	.056

The interaction appears to have a strong effect on the residual finger movement time. Below is bar graph which displays the interaction. In some cases when an interaction is present, it can mask the main effect of one factor at the different levels of the second factor. In our study a strong interaction masks the fact that audio feedback is important when there is positioning information, but has no effect when there is no positioning information. This is just the opposite of what was found with finger movement time as the dependent variable. The difference will be addressed in the Discussion section below.

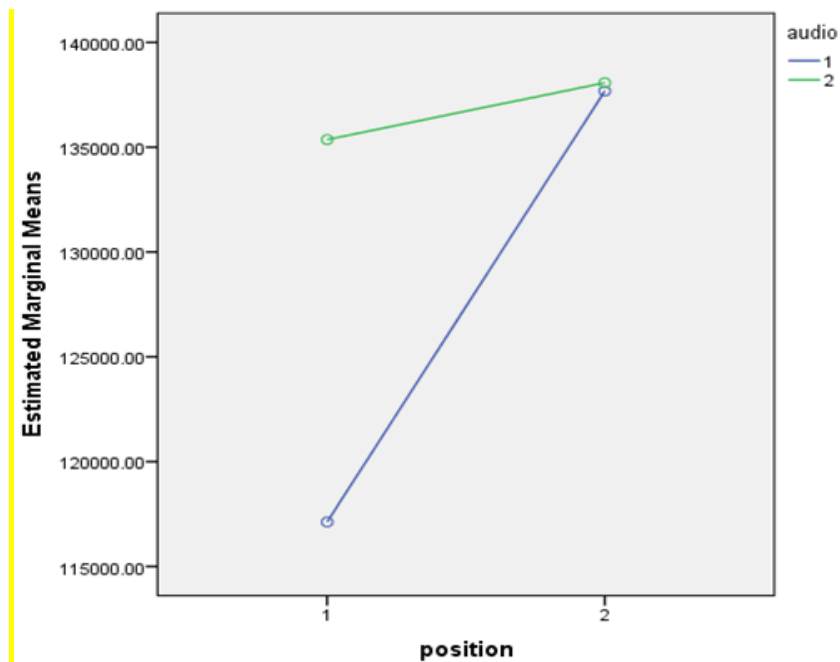

**Figure 3.4** Bar graph for finger movement interaction



### Task Completion Time

The task completion time is another dependent variable that was measured. It is calculated as the time that elapses from when first key was pressed to when the last key was released for each sentence. Since each subject is required to memorize every sentence, there is no idle time passed while typing a sentence (i.e., the participant does not have to glance back and forth between the sentence that is to be typed and the keyboard). It is hypothesized that there is no effect of audio feedback on task completion time however position information will make a difference. The null hypothesis is:

$H_0$  : There will is no main effect of position information or auditory feedback on either search time or task completion;

Below are the descriptive results. The condition with the shortest task completion times (P-F) is also the condition with the fastest finger movement times. Similarly, the condition with the longest task completion times (NoP-NoF) is also the condition with the longest finger movement times. There is an 8.4% increase in task completion time when both cues are absent. As with the analysis of residual movement times, the effect of audio feedback is again larger when positioning information is present (142.7 s with no feedback, 134.1 with feedback) than when positioning information is not present (145.3 with no feedback versus 140.2 with feedback). This interaction mirrors the interaction in the finger movement time analyses above.

**Table 3.11** Descriptive statistics for task completion

Conditions	Mean	Std. Dev.	N
P-F	134.1	22.9	24
P-NoF	142.7	15.3	24
NoP-F	140.2	13.8	24
NoP-NoF	145.3	20.79	24

In addition to above table, a box plot graph is given below. The y-axis represents the milliseconds values whereas the x-axis represents the conditions. The figure indicates a wide variance in the task completion times for the different conditions. However the means, 25<sup>th</sup> percentiles, and 75<sup>th</sup> percentiles are very close across the conditions.

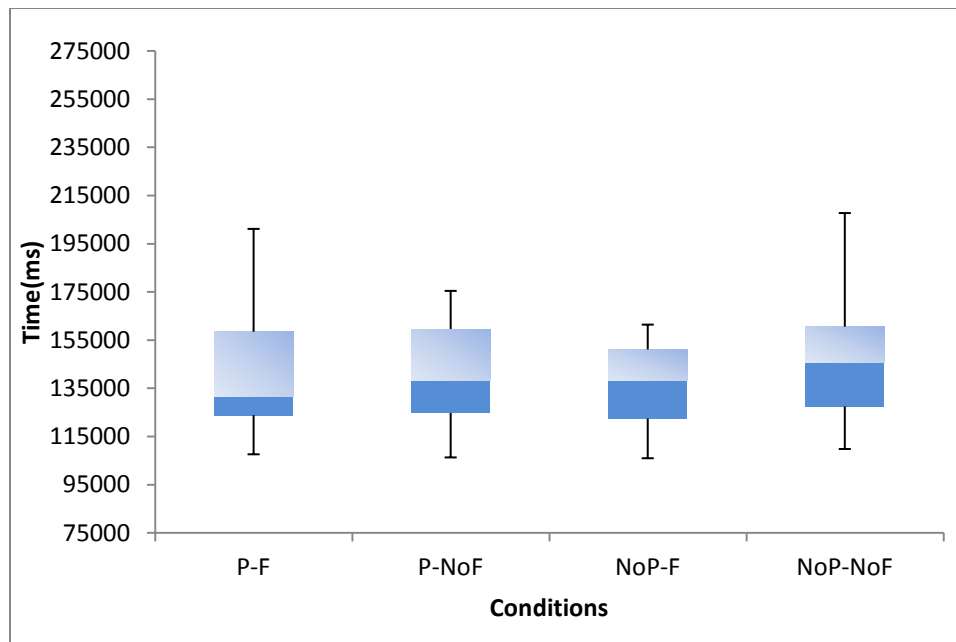

**Figure 3.5** Box plot graph for task completion

It is of some interest to determine whether the typing of the space bar itself affected the typing speed similarly across conditions. The difference between the task completion time in Table 3.11 and the task completion time excluding the total time spent typing the space bar is reported below in Table 3.12. It is clear from the difference values in Table 3.12 that there was the exclusion of space bar typing times did not have an alter the pattern of task completion times. It was still the case that audio feedback had a slightly larger effect when position information was present than when it was not present.

**Table 3.12** Analysis of task completion times after space bar correction

Conditions	Mean	Std. Dev.	Difference	N
P-F	99.4	30.7	34.7	24
P-NoF	108.5	28.4	34.2	24
NoP-F	104.4	41.9	35.8	24
NoP-NoF	109.5	34.3	35.8	24

As indicated in the above there is a 10% increase in the task completion time when both cues are absent (or, equivalently, 7.7% increase in typing speed). More specifically, it can be said that the presence of tactile and auditory cues helped subjects to finish the typing tasks in less time. In order to determine which of the tactile or auditory cues was having an effect, an ANOVA was undertaken. The same statistical tests were used to test for effects of position information and auditory feedback on task completion times as were used for finger movement time. The table below contains the results of this analysis. It is clear that there is a significant effect of audio feedback on tasks. However position information didn't have a significant effect on task completion times after the space bar correction was introduced. The interaction was also not significant.

**Table 3.13** ANOVA test for task completion

Source	Position	Audio	MS	df	F	Sigma
Position	Level 1 vs 2		27556	1	3.18	0.041
Audio		Level 1 vs 2	879589	1	2.836	0.113
Interaction	Level 1 vs 2	Level 1 vs 2	1509808	23	2.535	0.132

Based on the Tukey's HSD post-hoc analysis, there is a bigger difference between positions or no position for audio than non audio feedback. Put slightly differently, the effect of audio feedback is larger when position information is present than when it is not present, consistent with the task completion time results and the residual finger movement results. This

result is expected as it was hypothesized that the source of the improvement in task completions times was position information.

### Eye Movement Data

In addition to time data in this study, another dependent variable can be constructed from the record of eye movements. A head mounted eye tracker was used to measure eye movements. Unfortunately, it was not possible to use the data from all participants. In general, when typing, users look down to screen with an angle. When looking down, some of the participants' eye lids covered their pupils. Fortunately, only three of the 24 participants' data was lost due to this problem.

**Areas of Interest.** The iPad screen was divided into three areas of interest (AOI). The first area of interest is the top (first) row of QWERTY keyboard, which starts with "Q" and ends with "P". The second area of interest was home (second or middle) row where users position their fingers before they start typing. The last area of interest was the bottom (third) row of the same keyboard.

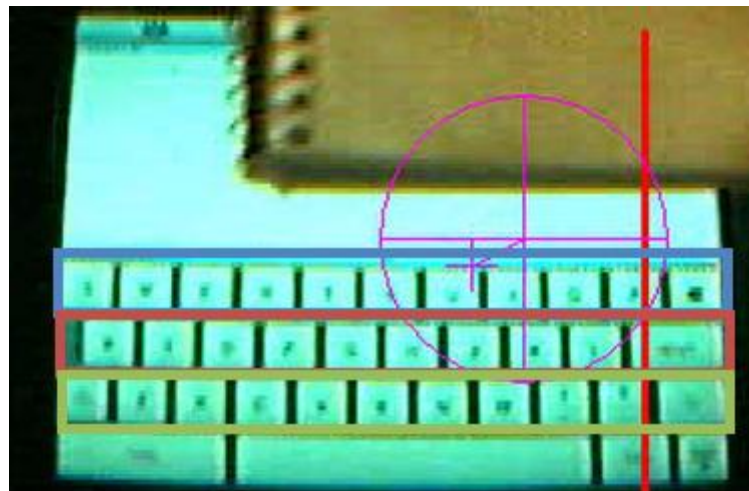

**Figure 3.6** Areas of interest

In the figure above, the green rectangle is the first AOI (AOI-I), the black is the second AOI (AOI-II), and yellow is the third AOI (AOI-III). This picture is taken just before the experiment to provide a general idea about the experiment. Since the eye tracker records the video files 29 frames per second, there are very short saccades between the areas not taken into account.

There are three important points I considered in measuring the glance time on any particular area of interest. First, when a glance was located on the line separating rows, the time spent looking there was not included in the computations since it was not clear upon which

area of interest the participant was focusing. Second, time spend looking outside the three areas of interest was excluding. Finally, on some occasions the hands covered the keyboard and the participant glanced at the back of the hands. It was not possible in these cases to determine definitively upon which area of interest the participant was glancing and so these times were excluded as well.

**Eye Glance Analyses.** I tested two hypotheses related to the distribution of eye glances:

- There would be a main effect of position information on the distribution of search times across the areas of interest
- There will be no effect of auditory feedback on the distribution of search times across the areas of interest.

In chart below, AOI-I, AOI-II, AOI-III represent the first, second and third areas of interest respectively. The average (purple columns) is found by averaging the time spent on three areas of interest. Y-axis values are the time spent on each row given in seconds. The values are the average amount of time spent for each condition. (For instance, in the NoP-F condition) on average subjects spend around 65 seconds on the top row, 40 seconds on second row and around 15 seconds on third row. The x-axis shows all four conditions.

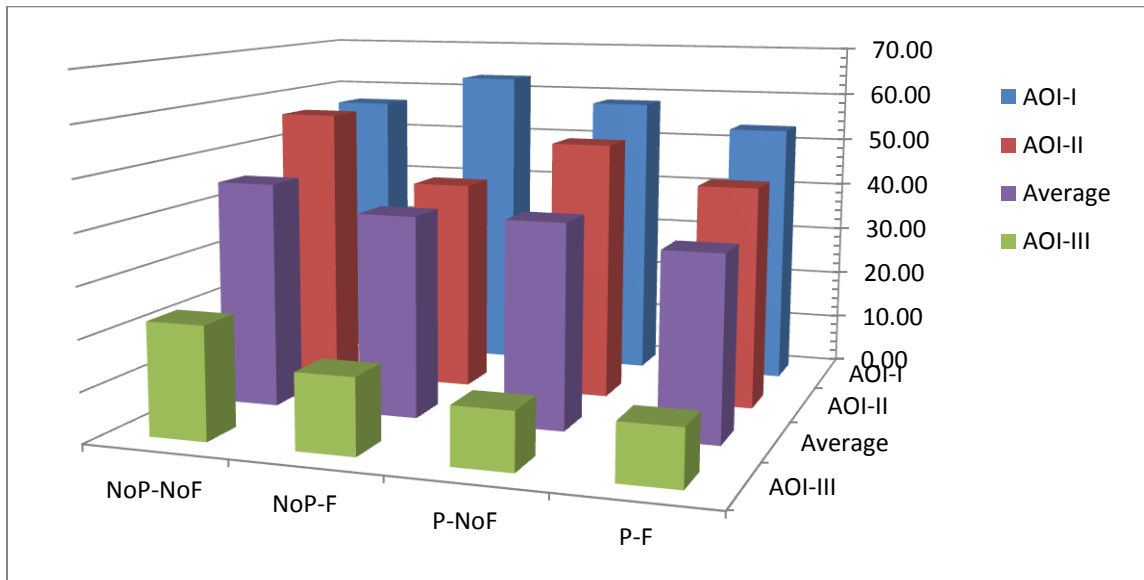

**Figure 3.7** 3-D chart for eye movement percentages (seconds)

The table below gives the exact proportions of the total time spent on each area of interest as well as the total scanning time for 21 data sets for corresponding condition. It can be seen that typists without position information but with auditory feedback did pay less attention

to the home row (AOI II). But this was definitely not true for typists who received no position information or auditory feedback. Thus, it does not appear that the positioning information is decreasing typists scanning of other areas.

**Table 3.14** Distribution of eye glance proportion for conditions

Conditions	AOI I	AOI II	AOI III	Total
P-F	0.49	0.41	0.10	1.00
P-NoF	0.48	0.43	0.09	1.00
NoP-F	0.52	0.35	0.12	1.00
NoP-NoF	0.42	0.42	0.17	1.00

As with finger movement times and task completion times, the typists are performing best in the condition with information positioning and auditory feedback. Based on the average values, there is a 24% improvement in total time spent scanning in the P-F condition. This is a great improvement for an individual. It took subjects 109.3 seconds in the P-F condition. Average total scanning time for the NoP-NoF condition was 135.58.

An ANOVA was undertaken to determine whether there was any effect of the two factors on the total time individuals spend scanning the display. As can be seen in the table below, both position information and auditory information had a significant effect.

**Table 3.15** Test results for Area of Interest-II

Source	Position	Audio	Mean Square	F	Sig.
Position	Level 1 vs. 2		4186.0	17.61	.003
Audio		Level 1 vs. 2	842.93	10.59	.012
Position * Audio	Level 1 vs. 2	Level 1 vs. 2	418.88	1.88	.207

A post-hoc test was used to analyze the data still further. Tukey's HSD method is adopted. The first condition (P-F) had the biggest effect. For different levels of audio options,

participants on an average tend to type faster when position information is also presented. Likewise, for different levels of positioning information, they perform better with audio option on.

### **Discussions and Limitations**

Different measures were made of the effect of position information and auditory feedback on users typing performance. These measures included: finger movement time and residual finger movement time; task completion time (including and excluding the time to press the space bar), and total glance time on the areas of interest. Position information had a main effect in four of the five dependent measures (all but finger movement time). Moreover, in four of the five dependent measures – the same measures – audio feedback had an as large or larger effect when position information was present than when it was not present.

The question is whether finger movement times are an anomaly or one needs to consider presenting different types of feedback for different types of typist. Recall that the finger movement times are analyzed only for the one finger typist. A post hoc explanation of why audio would have no (or little effect) when position information is present and a larger effect when position information is not present is possible. Specifically, it may be the case that for typists using only one finger the combined tactile and auditory feedback on the home row is more confusing for them than it is for typists using two or more fingers. The combined feedback for one finger typists would not be present for typists using two or more fingers if their fingers remain positioned over the home row. Note that when a finger is positioned over the home row position (tactile) feedback is already present. Striking the key would not change that tactile feedback; it would only create auditory feedback. However, when a one finger typist strikes a home row key he or she receives both position and auditory feedback which could create the hypothesized confusion. However, it should be emphasized that this explanation is post hoc and cannot be evaluated with this design.

In Experiment 1, there were clear limitations created by the confounding of device with practice. In this experiment such confounding did not exist. However, there is a related limitation present which is difficult to unravel. Participants in Experiment 2 may not have reached the true speeds that they could have reached in a between subjects design because they switched among the four different conditions. What is observed here should generalize to a situation where a typist was switching quickly among different keyboards (with different levels of feedback). But no conclusion can be drawn about the performance of typists if they were given a keyboard with an unchanging condition for a prolonged period of time.

A second clear limitation is due to the fact that only the iPad 2 was used as a soft keyboard. It is known that many factors affect the performance of typists and that these factors vary among soft keyboards. For example, each manufacturer uses its own footprint. Display quality, the space between keys, and the key size vary across the brands. Thus, it is not

possible to generalize with absolute assurance the finding that position information in general is helpful and that audio feedback is more helpful when position information is present than when it is absent.



## CHAPTER 4

### CONCLUSION

Measuring keyboard activities has a long history. There have been a large number of studies reported in the literature. The advent of new devices gave new urgency to this field of human factors. This study focused on quantifying touch typists' performance on soft screen keyboards. I was motivated by the fact that there are fundamental differences between soft and hard types of keyboards, differences which appear to make it much easier for experienced typists to operate a hard keyboard. After reviewing the literature, two key factors stood up as critical to the success of hard keyboards: tactile feedback on finger position and auditory feedback when a key is pressed. In Experiment 1, I evaluated this hypothesis. Typists were quicker with hard keyboards than soft keyboards. Because the hard keyboards had both position information and audio feedback, this suggested that either one or both were important. However, from Experiment 1 it could not be determined whether it was position feedback, audio feedback or both that were important. Moreover, a confound existed which prevented a conclusive determination of whether the effect of the hard keyboard was a function of the existence of position information and audio feedback or, instead, was a function of practice.

In order to get rid of the confound and isolate the effects of position information and auditory feedback, a second experiment was run. A 2 (position feedback available or not available) by 2 (auditory feedback available or not available) experiment was designed. The same subjects were exposed to soft keyboards in each of the four possible conditions. Since it is a laborious work to measure the efficiency of the large number of different devices and screen sizes that are on the market, it was decided to use one of the most popular, the Apple iPad 2. In this study, improvements of up to 18% on finger movement time, 10% on task completion time and 24% on eye glance time were observed. This is a practically significant increase, considering the number of users of soft keyboards now and the rapid increase projected in the future. Although the results can't be generalized to other devices, this study is a good indicator of what performance might look like on these other devices.

The technology required to generate tactile feedback might be complex. However, home row positioning information can be provided without incurring much cost. Simple transparent dots could be placed for index fingers on devices for both landscape and portrait orientation. However, using something which is physically mounted on the face of a display such as raised dots might create problems for applications other than typing with the soft keyboard that is supplied by the manufacturer. Since the location and size of the keys can change from one context to another, it might be desirable to have no positioning information on a device.. Also considering that users use hand held computers for web browsing mostly rather than typing, the manufacturer might consider other options.

By contrast, audio feedback can be applied easily. Moreover, rather than a simple beep for key strike feedback, there could be other varieties to mimic key strike behavior more realistically.

There are other differences between hard and soft keyboards that might be introduced into soft keyboards and improve performance still more. Identifying these additional factors that might possibly account for the performance increase would be a topic for another study. One very prominent feature is the ability that users have with a hard keyboard to rest their palms. It gives users an additional point of reference when attempting to position the fingers without looking at the keyboard. Additionally, factors that were considered in this study could be implemented differently. The built-in key click sound and Braille display that were used mimicked the hard keyboard. But this certainly does not need to be the case.

Another future topic of study is the determination of the optimal distance between any two pairs of keys. The keys in soft keyboards could actually be relocated as a function of an individual user's behavior based both on the particular frequencies of letter pairs in the lexicon of a user and the particular finger movement times of a user between any two locations on the keyboard. Such is not possible (or easily possible) with hard keyboards.

Human computer interaction is a rich field for human factor engineers. I studied a problem and proposed a solution methodology within the context of human factors. Behaviors of a certain population segment were analyzed using standard statistical methods.

## APPENDIX A

### JAVA CODE

Below is the source of the software developed for this study. First three line address the Java classes included. Java programming language has no support for allow multiple inheritance, interface classes “KeyListener” and “ActionListener” are implemented. Each keyboard activity is outputted with a value. Value is the elapsed time between the current time and midnight, January 1, 1970 UTC. It is in milliseconds scale.

```
import java.awt.*;

import java.awt.event.*;

import javax.swing.*;

public class neww extends JPanel implements KeyListener, ActionListener

{

    JTextArea displayArea;

    JTextField typingArea;

    static final String newline = "\n";

    public neww() {

        super(new BorderLayout());

        JButton button = new JButton("Clear");

        button.addActionListener(this);

        typingArea = new JTextField(20);

        typingArea.addKeyListener(this);

        displayArea = new JTextArea();

        displayArea.setEditable(false);

        JScrollPane scrollPane = new JScrollPane(displayArea);

        scrollPane.setPreferredSize(new Dimension(1350, 375));
```

```

Font f =new Font("serif", Font.BOLD,30 );

typingArea.setFont(f);

add(typingArea, BorderLayout.PAGE_START);

add(scrollPane, BorderLayout.CENTER);

add(button, BorderLayout.PAGE_END);

}

/** Handle the key pressed event from the text field. */

public void keyPressed(KeyEvent e) {

displayInfo(e, "KEY PRESSED: ");

}

/** Handle the key typed event from the text field. */

public void keyTyped(KeyEvent e) {

}

/** Handle the key released event from the text field. */

public void keyReleased(KeyEvent e) {

displayInfo(e, "KEY RELEASED: ");

}

/** Handle the button click. */

public void actionPerformed(ActionEvent e) {

//Clear the text components.

typingArea.setText("");

//Return the focus to the typing area.

typingArea.requestFocusInWindow();

}

/*

```

```

* We have to jump through some hoops to avoid
* trying to print non-printing characters such as
* Shift. (Not only do they not print, but if you put
* them in a String, the characters afterward won't
* show up in the text area.)
*/

protected void displayInfo(KeyEvent e, String s) {
    String keyString;
    int id = e.getID();
    if (id == KeyEvent.KEY_PRESSED) {
        char c = e.getKeyChar();
        keyString = "key character = " + c + "";
    } else {
        int keyCode = e.getKeyCode();
        keyString = "key code = " + keyCode + " ("
            + KeyEvent.getKeyText(keyCode) + ")";
    }
    displayArea.append(s + " " + System.currentTimeMillis() + newline +
        keyString + newline );
    displayArea.setCaretPosition(displayArea.getDocument().getLength());
}

/**
* Create the GUI and show it. For thread safety, this method should be
* invoked from the event-dispatching thread.
*/

```

```

private static void createAndShowGUI() {

//Make sure we have nice window decorations.

JFrame.setDefaultLookAndFeelDecorated(true);

//Create and set up the window.

JFrame frame = new JFrame("Key Events by Seckin");

frame.setDefaultCloseOperation(JFrame.EXIT_ON_CLOSE);

//Create and set up the content pane.

JComponent newContentPane = new neww();

newContentPane.setOpaque(true); //content panes must be opaque

frame.setContentPane(newContentPane);

//Display the window.

frame.pack();

frame.setVisible(true);

}

public static void main(String[] args) {

//Schedule a job for the event-dispatching thread:

//creating and showing this application's GUI.

javax.swing.SwingUtilities.invokeLater(new Runnable() {

public void run() {

createAndShowGUI();

}

});

}

}

```

**APPENDIX B**

**LETTER FREQUENCY**

**Table B.1** Letter Frequency table

Letters	M&T	Experiment 1		Experiment 2			
		Psg1	Psg2	Psg1	Psg2	Psg3	Psg4
<b>A</b>	0.081	0.048	0.075	0.061	0.072	0.081	0.048
<b>B</b>	0.016	0.014	0.012	0.019	0.011	0.011	0.014
<b>C</b>	0.024	0.025	0.03	0.03	0.026	0.037	0.024
<b>D</b>	0.043	0.034	0.03	0.023	0.037	0.011	0.014
<b>E</b>	0.113	0.138	0.093	0.099	0.095	0.095	0.099
<b>F</b>	0.018	0.014	0.021	0.015	0.009	0.029	0.014
<b>G</b>	0.022	0.02	0.021	0.03	0.023	0.007	0.024
<b>H</b>	0.077	0.022	0.051	0.057	0.023	0.04	0.031
<b>I</b>	0.052	0.065	0.06	0.08	0.08	0.059	0.068
<b>J</b>	0.002	0	0.003	0	0.003	0.004	0.007
<b>K</b>	0.011	0.008	0.012	0.004	0.011	0.011	0.014
<b>L</b>	0.045	0.037	0.042	0.023	0.04	0.026	0.027
<b>M</b>	0.025	0.025	0.027	0.023	0.037	0.026	0.034
<b>N</b>	0.06	0.056	0.051	0.068	0.043	0.04	0.051
<b>O</b>	0.066	0.059	0.054	0.049	0.083	0.062	0.089
<b>P</b>	0.015	0.017	0.006	0.023	0.014	0.022	0.024
<b>Q</b>	0.001	0.003	0.003	0	0.003	0	0.003

<b>R</b>	0.059	0.051	0.054	0.057	0.049	0.059	0.055
<b>S</b>	0.061	0.059	0.072	0.038	0.052	0.048	0.041
<b>T</b>	0.098	0.079	0.081	0.084	0.077	0.088	0.068
<b>U</b>	0.031	0.025	0.018	0.011	0.023	0.015	0.031
<b>V</b>	0.01	0.014	0.009	0.019	0.003	0.011	0.01
<b>W</b>	0.029	0.008	0.012	0.023	0.011	0.022	0.02
<b>X</b>	0.001	0.003	0	0	0	0	0.003
<b>Y</b>	0.021	0.025	0.015	0.015	0.02	0.026	0.007
<b>Z</b>	0.001	0	0	0	0	0.004	0
<b>Sum</b>	0.982	0.849	0.852	0.851	0.845	0.834	0.82



## APPENDIX C

### TEXT PASSAGES

#### Passage A

the water was monitored daily  
he watched in astonishment  
a big scratch on the tabletop  
salesmen must make their monthly quota  
saving that child was an heroic effort

#### Passage B

my watch fell in the water  
prevailing wind from the east  
never too rich and never too thin  
breathing is difficult  
physics and chemistry are hard

#### Passage C

elephants are afraid of mice  
my favorite place to visit  
on the way to the cottage  
a lot of chlorine in the water  
do not drink the water

#### Passage D

movie about a nutty professor  
come and see our new car  
coming up with killer sound bites

the opposing team is over there  
soon we will return from the city

## REFERENCES

- Beggs, W. D. A., Graham, J. C., Monk, T. H., Shaw, M. R. W., & Howarth, C. I. (1972). Can Hick's law and Fitts' law be combined? *Acta Psychologica*, 36(5), 348-357. doi: 10.1016/0001-6918(72)90031-5
- Blanch, R., Guiard, Y., & Beaudouin-Lafon, M. (2004). *Semantic pointing: improving target acquisition with control-display ratio adaptation*. Paper presented at the Proceedings of the SIGCHI Conference on Human Factors in Computing Systems, Vienna, Austria.
- Brewster, S., Chohan, F., & Brown, L. (2007). *Tactile feedback for mobile interactions*. Paper presented at the Proceedings of the SIGCHI conference on Human factors in computing systems, San Jose, California, USA.
- Chang, A., & O'Sullivan, C. (2005). *Audio-haptic feedback in mobile phones*. Paper presented at the CHI '05 Extended Abstracts on Human Factors in Computing Systems, Portland, OR, USA.
- Crook, M. (1964). *Touch typing for teachers*. London: Pitman.
- Fitts, P. M. (1954). The information capacity of the human motor system in controlling the amplitude of movement. *J Exp Psychol*, 47(6), 381-391.
- Gillan, D. J., Holden, K., Adam, S., Rudisill, M., & Magee, L. (1990). *How does Fitts' law fit pointing and dragging?* Paper presented at the Proceedings of the SIGCHI Conference on Human Factors in Computing Systems, Seattle, Washington, United States.
- Guiard, Y., Beaudouin-Lafon, M., Bastin, J., Pasveer, D., & Zhai, S. (2004). *View size and pointing difficulty in multi-scale navigation*. Paper presented at the Proceedings of the working conference on Advanced visual interfaces, Gallipoli, Italy.
- Hick, W. E. (1952). On the rate of gain of information. *Quarterly Journal of Experimental Psychology*, 4(1), 11-26. doi: 10.1080/17470215208416600
- Hoffmann, E. R., & Lim, J. T. A. (1997). Concurrent manual-decision tasks. *Ergonomics*, 40(3), 293-318.
- Hyman, R. (1953a). Stimulus information as a determinant of reaction time. *J Exp Psychol*, 45(3), 188-196. doi: 10.1037/h0056940
- Hyman, R. (1953b). Stimulus information as a determinant of reaction time. *Journal of Experimental Psychology*, 188-196.

- Jacko, J., Scott, I., Sainfort, F., Moloney, K., Kongnakorn, T., Zorich, B., & Emery, V. (2003). Effects of Multimodal Feedback on the Performance of Older Adults with Normal and Impaired Vision Universal Access Theoretical Perspectives, Practice, and Experience. In N. Carbonell & C. Stephanidis (Eds.), (Vol. 2615, pp. 3-22): Springer Berlin / Heidelberg.
- Jensen, A. R., & Munro, E. (1979). Reaction time, movement time, and intelligence. *Intelligence*, 3(2), 121-126. doi: 10.1016/0160-2896(79)90010-2
- Kane, S. K., Morris, M. R., Perkins, A. Z., Wigdor, D., Ladner, R. E., & Wobbrock, J. O. (2011). *Access overlays: improving non-visual access to large touch screens for blind users*. Paper presented at the Proceedings of the 24th annual ACM symposium on User interface software and technology, Santa Barbara, California, USA.
- Landauer, T. K., & Nachbar, D. W. (1985). Selection from alphabetic and numeric menu trees using a touch screen: breadth, depth, and width. *SIGCHI Bull.*, 16(4), 73-78. doi: 10.1145/1165385.317470
- Lee, J.-H., Poliakoff, E., & Spence, C. (2009). The Effect of Multimodal Feedback Presented via a Touch Screen on the Performance of Older Adults
- Haptic and Audio Interaction Design. In M. Altinsoy, U. Jekosch & S. Brewster (Eds.), (Vol. 5763, pp. 128-135): Springer Berlin / Heidelberg.
- Lewis, J. R. (1999). Input Rates and User Preference for Three Small-Screen Input Methods: Standard Keyboard, Predictive Keyboard, and Handwriting. *Proceedings of the Human Factors and Ergonomics Society Annual Meeting*, 43(5), 425-428. doi: 10.1177/154193129904300507
- Lewis, J. R., LaLomia, M. J., & Kennedy, P. J. (1999). Evaluation of Typing Key Layouts for Stylus Input. *Proceedings of the Human Factors and Ergonomics Society Annual Meeting*, 43(5), 420-424. doi: 10.1177/154193129904300506
- Luk, J., Pasquero, J., Little, S., MacLean, K., Levesque, V., & Hayward, V. (2006). *A role for haptics in mobile interaction: initial design using a handheld tactile display prototype*. Paper presented at the Proceedings of the SIGCHI Conference on Human Factors in Computing Systems, Montré#233;l, Qu#233;bec, Canada.
- MacKenzie, I. S., & Buxton, W. (1992). *Extending Fitts' law to two-dimensional tasks*. Paper presented at the Proceedings of the SIGCHI Conference on Human Factors in Computing Systems, Monterey, California, United States.
- MacKenzie, I. S., Nonnecke, B., Riddersma, S., McQueen, C., & Meltz, M. (1994). Alphanumeric entry on pen-based computers. *International Journal of Human-Computer Studies*, 41(5), 775-792. doi: 10.1006/ijhc.1994.1081

- Mackenzie, I. S., & Soukoreff, R. W. (2003). *Phrase sets for evaluating text entry techniques*. Paper presented at the CHI '03 Extended Abstracts on Human Factors in Computing Systems, Ft. Lauderdale, Florida, USA.
- Mackenzie, I. S., & Zhang, S. X. (1999). Design and evaluation of a high-performance soft keyboard. *Conference on Human Factors in Computing Systems - Proceedings*, 25-31.
- Mackenzie, I. S., & Zhang, S. X. (2001). An empirical investigation of the novice experience with soft keyboards. *Behaviour and Information Technology*, 20(6), 411-418. doi: 10.1080/01449290110089561
- Mackenzie, I. S., Zhang, S. X., & Soukoreff, R. W. (1999). Text entry using soft keyboards. *Behaviour and Information Technology*, 18(4), 235-244. doi: 10.1080/014492999118995
- Magnien, L., Bouraoui, J. L., & Vigouroux, N. (2004). Mobile Text Input with Soft Keyboards: Optimization by Means of Visual Clues
- Mobile Human-Computer Interaction – MobileHCI 2004. In S. Brewster & M. Dunlop (Eds.), (Vol. 3160, pp. 197-218): Springer Berlin / Heidelberg.
- Mayzner, M. S., & Tresselt, M. E. (1965). TABLES OF SINGLE-LETTER AND DIGRAM FREQUENCY COUNTS FOR VARIOUS WORD-LENGTH AND LETTER-POSITION COMBINATIONS. *Psychonomic Monograph Supplements*, 1(2), 13-32.
- Olson, J. R., & Nilsen, E. (1987). Analysis of the cognition involved in spreadsheet software interaction. *Hum.-Comput. Interact.*, 3(4), 309-349. doi: 10.1207/s15327051hci0304\_1
- Paek, T., Chang, K., Almog, I., Badger, E., & Sengupta, T. (2010). *A practical examination of multimodal feedback and guidance signals for mobile touchscreen keyboards*. Paper presented at the Proceedings of the 12th international conference on Human computer interaction with mobile devices and services, Lisbon, Portugal.
- Potter, R. L., Weldon, L. J., & Shneiderman, B. (1988). *Improving the accuracy of touch screens: an experimental evaluation of three strategies*. Paper presented at the Proceedings of the SIGCHI Conference on Human Factors in Computing Systems, Washington, D.C., United States.
- Poupyrev, I., & Maruyama, S. (2003). *Tactile interfaces for small touch screens*. Paper presented at the Proceedings of the 16th annual ACM symposium on User interface software and technology, Vancouver, Canada.
- Rauterberg, G. W. M. (1999). *Different effects of auditory feedback in man-machine interfaces*: Ashgate Publishing.

- Roberts, R. D. (1997). Fitts' law, movement time and intelligence. *Personality and Individual Differences, 23*(2), 227-246. doi: 10.1016/S0191-8869(97)00038-X
- Rosenthal, R., & Rubin, D. B. (1994). The Counternull Value of an Effect Size: A New Statistic. *Psychological Science, 5*(6), 329-334. doi: 10.1111/j.1467-9280.1994.tb00281.x
- Schmidt, R. A., Zelaznik, H., Hawkins, B., Frank, J. S., & Quinn Jr, J. T. (1979). Motor-output variability: A theory for the accuracy of rapid motor acts. *Psychological Review, 86*(5), 415-451. doi: 10.1037/0033-295X.86.5.415
- Sears, A., Jacko, J. A., Chu, J., & Moro, F. (2001a). The role of visual search in the design of effective soft keyboards. *Behaviour and Information Technology, 20*(3), 159-166.
- Sears, A., Jacko, J. A., Chu, J. Y. M., & Moro, F. (2001b). The role of visual search on the design of effective keyboards. *Behaviour & IT, 159-166*.
- Sears, A., Revis, D., Swatski, J., Crittenden, R., & et al. (1993). Investigated touchscreen typing: The effect of keyboard size on typing speed. *Behaviour & Information Technology, 12*(1), 17-22. doi: 10.1080/01449299308924362
- Sears, A., & Zha, Y. (2003). Data entry for mobile devices using soft keyboards : Understanding the effects of keyboard size and user tasks. *International Journal of Human-Computer Interaction, 163-184*.
- Sears, A., & Zha, Y. (2003). Data Entry for Mobile Devices Using Soft Keyboards: Understanding the Effects of Keyboard Size and User Tasks. *International Journal of Human-Computer Interaction, 16*(2), 163-184. doi: 10.1207/S15327590IJHC1602\_03
- Shannon, C. E. (1948). A mathematical theory of communication. *SIGMOBILE Mob. Comput. Commun. Rev., 5*(1), 3-55. doi: 10.1145/584091.584093
- Soukoreff, R. W., & MacKenzie, I. S. (1995). Theoretical upper and lower bounds on typing speed using a stylus and soft keyboard. *Behaviour & Information Technology, 370-379*.
- William Soukoreff, R., & Scott Mackenzie, I. (1995). Theoretical upper and lower bounds on typing speed using a stylus and a soft keyboard. *Behaviour & Information Technology, 14*(6), 370-379. doi: 10.1080/01449299508914656
- Yechiam, E., Erev, I., Yehene, V., & Gopher, D. (2003). Melioration and the Transition from Touch-Typing Training to Everyday Use. *Human Factors: The Journal of the Human Factors and Ergonomics Society, 45*(4), 671-684. doi: 10.1518/hfes.45.4.671.27085

Zhao, S., Dragicevic, P., Chignell, M., Balakrishnan, R., & Baudisch, P. (2007). *Earpod: eyes-free menu selection using touch input and reactive audio feedback*. Paper presented at the Proceedings of the SIGCHI Conference on Human Factors in Computing Systems, San Jose, California, USA.