

5-1-2013

# Progeny Release of Species B Human Adenoviruses Is Not Mediated By Early Region 3 Proteins 20.1K, 20.5k, and 10.9k

James Dowling

Follow this and additional works at: [https://digitalrepository.unm.edu/biom\\_etds](https://digitalrepository.unm.edu/biom_etds)

---

## Recommended Citation

Dowling, James. "Progeny Release of Species B Human Adenoviruses Is Not Mediated By Early Region 3 Proteins 20.1K, 20.5k, and 10.9k." (2013). [https://digitalrepository.unm.edu/biom\\_etds/69](https://digitalrepository.unm.edu/biom_etds/69)

This Thesis is brought to you for free and open access by the Electronic Theses and Dissertations at UNM Digital Repository. It has been accepted for inclusion in Biomedical Sciences ETDs by an authorized administrator of UNM Digital Repository. For more information, please contact [disc@unm.edu](mailto:disc@unm.edu).

James Andrew Dowling  
*Candidate*

---

Molecular Genetics and Microbiology  
*Department*

---

This thesis is approved, and it is acceptable in quality and form for publication:

*Approved by the Thesis Committee:*

Michelle Ozbun, Ph. D. , Chairperson

---

Adriana Kajon, Ph. D.

---

David Peabody, Ph. D.

---

---

---

---

---

---

---

**PROGENY RELEASE OF SPECIES B  
HUMAN ADENOVIRUSES IS NOT MEDIATED  
BY EARLY REGION 3 PROTEINS 20.1K, 20.5K,  
AND 10.9K**

**by**

**JAMES ANDREW DOWLING**

**BS. BIOLOGY, UNIVERSITY OF NEW MEXICO 2007**

***THESIS***

***Submitted in Partial Fulfillment of the  
Requirements for the Degree of***

**Masters of Science  
Biomedical Sciences**

***The University of New Mexico  
Albuquerque, New Mexico***

**May, 2013**

## **Acknowledgements**

I would like to thank Dr. Adriana Kajon. For years she has been a mentor and a friend. Without her and her incredible knowledge of the field, I would have not been able to develop my skills as a molecular biologist. She constantly pushed me to be the best that I could possibly be.

I would also like to thank the members of my committee Dr. Michelle Ozbun and Dr. David Peabody. Their insight has helped me to develop and shape my project over the years.

Dr. Stephanie Ruby also deserves special recognition. Not only did she serve on my committee, but she was also a special instructor through multiple classes in the program. Her insight, knowledge, and support will be missed.

Finally, I would like to thank my wife Kristin, my daughter Charlotte, and the rest of my family. Their love has provided the motivation and support through this process.

**PROGENY RELEASE OF SPECIES B HUMAN  
HUMAN ADENOVIRUSES IS NOT MEDIATED  
BY EARLY REGION 3 PROTEINS 20.1K, 20.5K,  
AND 10.9K**

by

**JAMES ANDREW DOWLING**

**M.S., BIOMEDICAL SCIENCES, UNIVERSITY OF NEW  
MEXICO, 2013**

**Abstract**

The early region 3 (E3) of the human adenovirus (HAdV) genome encodes proteins that regulate the host immune response to viral infection. The E3 region also exhibits the highest level of genetic diversity among the genomes of the six (A-F) species of HAdV. This diversity in genetic content is found primarily between the highly conserved E3-gp19K and RID $\alpha$  open reading frames (ORFs). It has been previously shown that HAdV-C encodes the adenovirus death protein (ADP) in this location. ADP is an 11.6kDa, transmembrane protein that localizes to the nuclear membrane, and facilitates the efficient release of progeny virions. HAdV-B1 encodes three ORFs, E3-20.1K, E3-20.5K and E3-10.9K, in the analogous region of the viral genome. Since ADP and the three novel HAdV-B1 proteins share several structural characteristics and location in the E3 region, we hypothesized that one or more of these unique ORFs play a similar role to ADP in facilitating viral progeny egress. Reverse transcriptase PCR showed that transcripts of the novel ORFs are expressed at

both early and late time points post infection. Through the examination of ectopically expressed EGFP fusion proteins, we demonstrated that E3-20.1K, E3-20.5K and E3-10.9K localize to the plasma membrane and intracellular vesicle-like structures. Localization to intracellular vesicle-like structures was also observed when the novel HAdV-B1 E3 proteins fused with short, C-terminal, epitope tags were expressed from the viral genome. We generated a HAdV-3 knock out mutant virus which lacks the ability to express the E3-20.1K, E3-20.5K, and E3-10.9K proteins to examine whether the products of these ORFs are required for viral replication or play a role in facilitating the release of viral progeny from infected polarized or non-polarized lung epithelial cells. The knock out virus did not show any impaired growth in non-polarized A549 cells or polarized Calu3 cells when compared to wild type virus. The knockout HAdV-B1 mutant also did not show any significant changes in the development of plaques, size of plaques, or dissemination of the virus on cell monolayers. Even though the novel E3-20.1K, E3-20.5K, and 10.9K proteins of HAdV-B1 are encoded in the analogous region of E3 and they share several structural characteristics with ADP, our experimental data show that they do not play a role in the release of progeny virions from infected cells.

**Table of contents:**

|   |             |
|---|-------------|
| <b>List of figures and tables.....</b>                | <b>viii</b> |
| <b>Chapter 1: Introduction.....</b>                   | <b>1</b>    |
| <b>Chapter 2: Background.....</b>                     | <b>4</b>    |
| Structure.....  | 4           |
| Classification and taxonomy.....                      | 5           |
| Genome organization and transcription.....            | 6           |
| Replication cycle.....                                | 9           |
| Species B human adenoviruses.....                     | 11          |
| Early region 3 transcription unit.....                | 12          |
| Functional roles of conserved E3 proteins.....        | 14          |
| E3-gp19K.....   | 14          |
| RID $\alpha$ /RID $\beta$ Complex.....                | 15          |
| E3-14.7K.....   | 16          |
| Functional roles of species-specific E3 Proteins..... | 17          |
| E3-6.7K.....  | 17          |
| Adenovirus death Protein (ADP).....                   | 17          |
| Gaps in current knowledge.....                        | 19          |
| <b>Chapter 3: Materials and methods.....</b>          | <b>21</b>   |
| Cells.....  | 21          |
| Viruses and infection.....                            | 21          |
| Secondary structural predictions.....                 | 22          |
| EGFP fusion protein constructs.....                   | 22          |

|   |           |
|---|-----------|
| Transfection of HeLa T-Rex cells.....   | 23        |
| Generation of mutant HAdV-3 viruses.....  | 23        |
| Immunofluorescence.....   | 27        |
| EGFP fusion constructs.....   | 27        |
| HAdV-3-FRT-Tag mutant virus infections.....   | 28        |
| Reverse transcriptase PCR.....  | 29        |
| Plaque Accumulation.....  | 30        |
| Statistics.....   | 30        |
| <b>Chapter 4:Results.....</b>   | <b>31</b> |
| HAdV-3 E3-20.1K, E3-20.5K, and E3-9K triple knock out mutant does not display impaired growth in an infected cell monolayer.....  | 31        |
| HAdV-3-Triple KO and HAdV-3-Double KO do not show impaired dissemination through an infected cell monolayer.....  | 34        |
| Accumulation of plaques is not inhibited by the loss of E3-20.1K, E3-20.5K, and E3-9K.....  | 35        |
| E3-20.1K, E3-20.5K, and E3-9K do not play a critical role in plaque development during infection.....   | 36        |
| Functional motifs located within E3-20.1K, E3-20.5K, and E3-9K.....   | 37        |
| E3-20.1K, E3-20.5K, and E3-9K are expressed at early and late time points post infection.....   | 40        |
| C-Terminal EGFP fusions of E3-20.1K, E3-20.5K, and E3-9K localize to the plasma membrane and intracellular vesicle-like structures when expressed in HeLa TRex cells..... | 42        |
| E3-20.1K, E3-20.5K, and E3-9K localize to intracellular, vesicle-like structures during infection of A549 cells.....  | 44        |
| E3-20.1K, E3-20.5K, and E3-9K do not localize with the early or late endosome or Golgi markers.....   | 47        |



|  |           |
|--|-----------|
| <b>Chapter 5: Discussion.....</b>  | <b>49</b> |
| E3-20.1K, E3-20.5K, and E3-9K do not mediate the release of progeny virions.....   | 50        |
| E3-20.1K, E3-20.5K, and E3-9K knockout mutants do not alter dissemination of the virus, plaque size or morphology, or plaque accumulation..... | 51        |
| Structural and functional motifs of E3-20.1K, E3-20.5K, and E3-9K.....   | 53        |
| Subcellular localization of E3-20.1K, E3-20.5K, and E3-9K.....   | 54        |
| Future directions.....   | 56        |
| <b>Appendix: Acronyms.....</b>   | <b>59</b> |
| <b>References.....</b>   | <b>60</b> |

## List of figures and tables

|   |    |
|---|----|
| Figure 1: An overview of the adenovirus virion.....   | 5  |
| Figure 2: Transcriptional organization of the HAdV genome .....   | 7  |
| Table 1: The seven species of human adenovirus.....   | 12 |
| Figure 3: A representation of the early region 3 transcription unit from members of HAdVs A-F.....  | 14 |
| Figure 4: Overview of the recombination strategy used to generate mutant HAdV-3 .....   | 25 |
| Figure 5: Map of the mutated HAdV-3 E3 ORFs that were inserted into the pKSB2Ad3wt bacmid to generate mutant HAdV-3.....  | 26 |
| Table 2: Primers used for detection of cDNA transcripts of E3-20.1K, E3-20.5K, E3-9K, Hexon, and RIG/S15.....   | 30 |
| Figure 6: Release of progeny virions from non-polarized A549 cells is not mediated by E3-20.1K, E3-20.5K, or E3-9K.....   | 32 |
| Figure 7: Apical release of progeny virions from polarized epithelial cells is not mediated by E3-20.1K, E3-20.5K, or E3-9K.....  | 33 |
| Figure 8: Dissemination of HAdV-3 is not affected by the loss of E3-20.1K, E3-20.5K, or E3-9K .....   | 34 |
| Figure 9: Plaque accumulation is not inhibited by the loss of E3-20.1K, E3-20.5K, and E3-9K in HAdV-B1.....   | 36 |
| Figure 10: Plaque size is not affected by the HAdV-B1 E3 proteins 20.1K, 20.5K, and 9K.....   | 37 |
| Figure 11: Structural prediction of important domains of E3-20.1K, E3-20.5K, and E3-9K.....   | 39 |
| Figure 12: Transcripts of E3-20.1K, E3-2.5K, and E3-9K are expressed at all time points post infection. During late time points, there is a switch to transcription from the MLP..... | 42 |
| Figure 13: C-terminal EGFP fusion proteins localize to the plasma membrane and intracellular vesicle like structures when expressed in HeLa TRex cells.....                           | 44 |

Figure 14: E3-20.1K, E3-20.5K, and E3-9K localize to intracellular, vesicle like structures, but do not co-localize with each other.....46

Figure 15: E3-20.1K, E3-20.5K, and E3-9K do not localize to the early endosome, late endosome, or Golgi.....48

## Chapter 1: Introduction

Species B human adenoviruses (HAdV-B) are common causative agents of acute lower respiratory infections in children, as well as the causative agents of outbreaks of febrile respiratory illness in military recruits (Ryan et al, 2002). Despite their medical importance, little is understood about their unique molecular biology and pathogenesis. The Early Region 3 (E3) of the HAdV genome contains the highest level of genetic diversity among the six species (A-F) of HAdVs found in humans. This diversity in genetic content is primarily located between the highly conserved E3-gp19K and E3-RID $\alpha$  open reading frames (ORFs) where species-specific arrays of genes are encoded (Burgert and Blusch, 2000). Determining the functional implications of the genetic diversity in this region may provide insight into the molecular basis of the distinct pathobiology of the different species of HAdVs.

Although the E3 region is not essential for viral replication, it does encode non-structural proteins that play important roles in the regulation of the host response to infection at early time points post infection. For example, the RID $\alpha/\beta$  complex is responsible for EGFR, TNF $\alpha$ R, and FasLR down regulation from the plasma membrane, and glycoprotein 19K plays an important role in retaining MHC class I in the ER, preventing the activation of cytotoxic T cells (CTLs). Between the highly conserved E3-19K and RID $\alpha$ /E3-10.4K open reading frames, the HAdV-C genome encodes an 11.6kDa protein that has been termed the Adenovirus Death Protein (ADP). Tollefson and associates demonstrated that, unlike other E3 proteins, ADP is primarily expressed at late time points post infection from the major late promoter,

and is required for efficient viral progeny release in human lung epithelial cells (Tollefson et al., 1992-1996).

Viruses with large DNA genomes, such as adenoviruses, can use multiple strategies for viral progeny release (Zheng et al, 2008). The mediators of different release strategies may be encoded in the highly divergent E3 region. HAdV-Bs encode two to three E3 proteins of unknown function between E3-gp19K and RID $\alpha$ . HAdV-B1 and HAdV-B2 encode proteins of predicted size 20.1kDa and 20.5kDa. The HAdV-B1 genome also encodes a highly polymorphic ORF designated E3-10.9K (Frietze et al., 2011). ADP and the three proteins (E3-20.1K, E3-20.5K, and E3-10.9K) encoded by HAdV-B1 share the characteristics of viroporins. Viroporins are comprised of roughly 60-120 amino acids, have a hydrophobic transmembrane domain, a stretch of basic amino acids close to the transmembrane domains, are frequently modified with N- or O- linked oligosaccharides, and are expressed at late time points post infection (Gonzales et al., 2003). Some viroporins can oligomerize to form pores in a membrane increasing its permeability, however, such an effect has not yet been shown for the proteins encoded in HAdV-B or -C E3 ORFs. We hypothesize that one or more of the unique ORFs in the E3 region of HAdV-B1, like ADP, facilitate the release of progeny virions.

With the exception of ADP, little is known about the functions of the products of species-specific E3 ORFs. Windheim and Burgert (2001) demonstrated the E3-49K protein encoded by keratoconjunctivitis-causing HAdV-19a, and other HAdV-Ds, localizes to the trans-Golgi network and early endosomes in human fibroblast cells. The E3-49K protein has structural features similar to those of the E3-20.1K and E3-

20.5K, but its function has not been elucidated. Hawkings and Wold have previously demonstrated that E3-20.5K, like ADP, is expressed at late times post infection (1995a). E3-20.5K is also heavily glycosylated which is consistent with the structure of a viroporin (Hawkins and Wold, 1995a).

In order to investigate the roles of HAdV-B1 E3-20.1K, E3-20.5K, and E3-10.9K in the release of progeny virions from infected cells, we have generated a triple knock out mutant (knocking out E3-20.1K, E3-20.5K, and E3-10.9K) and a double knock out mutant (knocking out E3-20.1K and E3-20.5K) HAdV-3 which lack the ability to produce the E3 proteins of interest. We have utilized these knock out viruses to examine the roles of the E3 proteins in plaque formation, plaque morphology, dissemination of the virus throughout an infected cell monolayer, and in a one-step growth curve in polarized and non-polarized cell monolayers. Despite being encoded in the analogous region of the viral genome as ADP, and their viroporin-like characteristics, our knockout mutant viruses lacking the ability to express E3-20.1K, E3-20.5K, and E3-9K did not show any impaired growth phenotype in cell monolayers. Our data demonstrate that the E3-20.1K, E3-20.5K, and E3-9K are not mediators of progeny viral egress.

## Chapter 2: Background

### Structure.

Members of the Family *Adenoviridae* have non-enveloped capsids between 90 and 100nm in diameter. The adenovirus (AdV) genome consists of double stranded DNA between 26-45kbp in length. A virus-encoded terminal protein is covalently attached to the 5' end of each strand of the genome. These terminal proteins act as primers for replication of the viral genome. The capsid is composed primarily of the hexon, penton base, and fiber proteins. The capsid contains 240 capsomers of hexon. A trimer of the hexon protein creates each capsomer. The adenovirus' icosahedral capsid contains 12 pentons, each composed of the penton base and projecting fiber proteins. The fiber protein is primarily involved in host receptor binding (Lonberg-Holm et al., 1969) A schematic of the adenovirus capsid can be found in **Figure 1**. The capsid also contains proteins involved in disruption of the endosomal membrane (Polypeptide VI), stabilization of the capsid (Polypeptide IX), and disassociation of the capsid after entry (Polypeptide IIIa). Core proteins V, VII, and  $\mu$  are found within the capsid and are involved in condensing the viral genome (Russell, 2009).

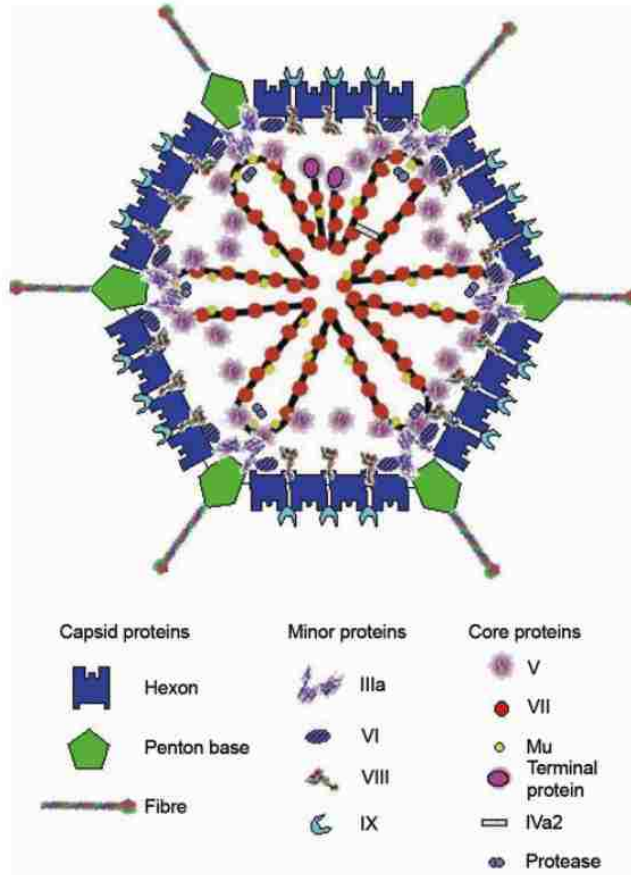

**Figure 1: An overview of the adenovirus virion.** The capsid primarily consists of the hexon protein, with the penton base and fiber proteins located at each of the twelve vertices. The capsid encloses the linear, double stranded DNA genome (Russell, 2009).

### Classification and taxonomy

The family *Adenoviridae* comprises four genera: *Atadenovirus*, *Aviadenovirus*, *Mastadenovirus*, and *Siadenovirus*. *Mastadenovirus* contains adenoviruses with mammalian hosts, including humans. Adenovirus genera are also divided into species and subspecies. Species are designated with a capital letter. Subspecies are designated with the capital letter of their species as well as a number. Species are classified by phylogenetic distance, restriction enzyme profiles, percentage of GC content,



oncogenicity in rodents, organization of the E3 region of the viral genome, and most importantly the host range of the virus. Species of adenoviruses contain serotypes, designated by an Arabic number assigned by the order in which they were discovered. These serotypes are distinguishable using neutralization assays with horse or rabbit reference anti-sera. Intraserotypic variation can be further characterized by restriction enzyme analysis (ICTVbd, 2002). Genome types or genomic variants of a given serotype are designated with a lower case letter. For example HAdV-7d2 is a genomic variant of serotype 7.

### **Genome organization and transcription**

The size, organization, and coding content of the adenovirus genome vary among genera and species. For example the E3 region is only found in the genomes of members of *Mastadenovirus* and a few members of *Siadenovirus* (Davidson et al., 2003). Frog AdV1 contains the smallest known genome of 26.1kbp and fowl AdV-D contains the largest genome of 45kbp (ICTVdB, 2002).

The AdV genome contains inverted terminal repeats (ITR) at each end (Davison et al., 2003) and is divided into transcription units. Genes are transcribed off of both strands of the DNA. A diagram of the HAdV genome and the location of these transcription units can be found in **Figure 2**. HAdV genomes contain five early transcription units, E1A, E1B, E2, E3 and E4, which are transcribed after entry but before DNA replication. There are three delayed early transcription units: IX, IVa2, and E2 late. Each of these early transcription units contains its own unique promoter. Only one late transcription unit has been identified. The late genes located in this

transcription unit are transcribed off of the Major Late Promoter (MLP). The late genes encode primarily structural proteins and are transcribed after the initiation of DNA replication. Some AdV also encode virus-associated RNA genes (VA RNA) that stimulate viral gene transcription of both early and late genes including genes in E3 and the late protein Hexon (Svensson and Akusjarvi, 1984). An important role of VA RNA I is the inhibition of PKR. PKR is activated via interferon and viral dsRNA. The activated PKR inhibits the recycling of pIF-2, which inhibits cellular and viral protein production. The highly structured VA RNA I binds to and inhibits PKR (Rahman et al., 1995)

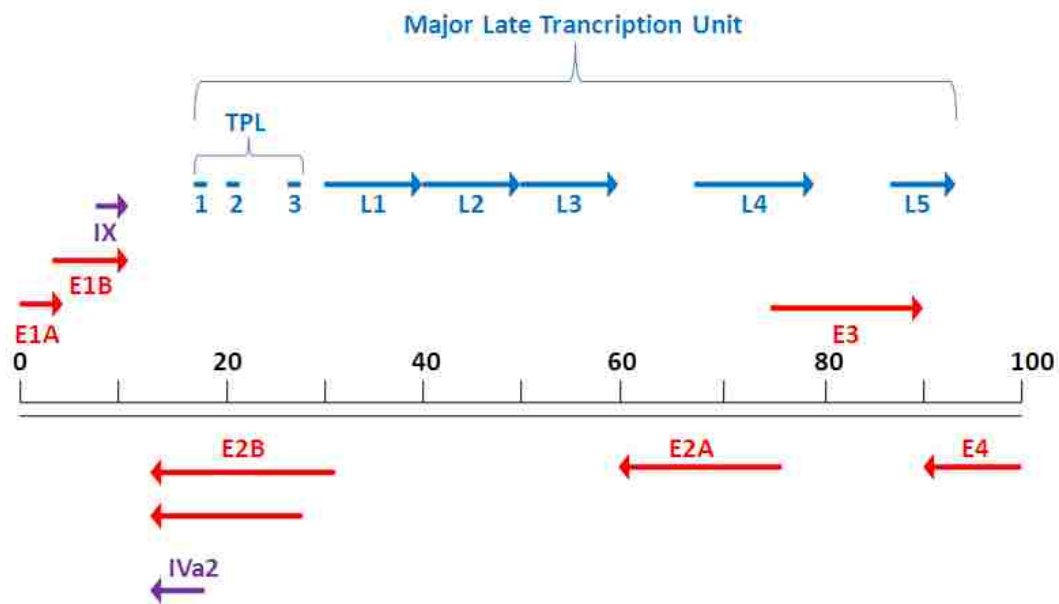

**Figure 2: Transcriptional organization of the HAdV genome.** The early transcription units are marked in red. The late transcription unit, preceded by the tripartite leader sequence, is marked in blue (Akusjarvi. 2008).

In general, the genes located in a given transcription unit serve related functions. The E1A genes activate transcription and force the cell into S phase. Apoptosis is inhibited by genes located in E1B transcription unit. The viral DNA polymerase and

other genes regulating viral DNA replication are found in E2 and E2 late. The E3 region regulates the host immune response to infection. The products of IX activate transcription and reorganize the host nucleus. MLP activation is controlled by genes encoded in IVa2. Structural proteins and progeny virion assembly genes are found in the late transcription unit (Davidson et al., 2003).

Transcription of AdV genes is activated by the large E1A proteins (Berk et al., 1979; Nevins, 1981). The production of the E1A proteins begins when the genome reaches the host cell nucleus after entry (Nevins, 1981). The E1A protein interacts with cellular transcription factors and is responsible for initiating activation of the early transcription units (Berk, 2005; Liu and Green, 1994). The small E1A protein is responsible for the activation of E2 transcription (Bagchi et al., 1990; Phelps et al., 1991).

The MLP is responsible for the transcription of all the genes found in the late transcription unit. The MLP is active during early stages of infection, but is over 100 times more active after viral DNA replication has begun (Shaw et al., 1980). The late transcription unit is transcribed as one large transcript of approximately 28kb (Evans et al., 1977; Nevins et al., 1978). This transcript is spliced into distinct mRNAs containing a poly A tail and a 5' untranslated region, 201 bases long, called the tripartite leader (TPL) sequence (Berget et al., 1977; Chow et al., 1977). The TPL is generated by splicing three short exon sequences (TPL1, TPL2, and TPL3) together (Berget et al., 1979). The TPL sequence also enhances the translation of the late mRNAs (Logan and Shenk, 1984). While the majority of products of the late transcription unit are structural proteins, the adenovirus death protein encoded in the

E3 region of HAdV-C is a transmembrane, non-structural protein expressed from the MLP at late time points post infection (Bhat and Wold, 1986).

### **Replication cycle**

The AdV replication cycle is divided into two temporal stages: early and late. These stages are defined by the onset DNA replication. The early stage of infection occurs before DNA replication, and includes receptor binding, entry, un-coating, transport of the viral genome into the host cell's nucleus, and early viral gene activation and transcription. The late stage of infection occurs after DNA replication has begun. At this stage of infection, late genes are expressed, structural proteins are produced, virion assembly takes place, and progeny virion release occurs from the infected host cell.

The fiber protein, located at each of the twelve vertices of the icosahedral AdV particle, mediates attachment of the virion to the host cell (Longberg-Holm et al., 1969). The host cell receptor protein varies among species of HAdVs. Coxsackievirus B and adenovirus receptor (CAR), which is a component of the tight junction complex of polarized epithelial cells (Philipson and Petterson, 2004), serves as the primary receptor for HAdV-A, -C, -E, and -F. Sialic acid moieties can be used as cellular receptors by HAdV-Ds (Arnberg et al., 2000). HAdV-Bs, the topic of this thesis, can use a variety of receptors. The complement regulatory protein CD46 is used by most members of HAdV-B (Martitila et al., 2005). Recently, desmoglein 2 (DSG-2) was also shown to be an important cellular receptor for HAdV-B (Trinh et al., 2011).

The penton base associates with  $\alpha_V\beta_3/\alpha_V\beta_5$  integrins on the host cell membrane simultaneously with the fiber protein binding its receptor. The virion is then internalized by clathrin-coated vesicles into the endosomal pathway (Mathias et al., 1994; Patterson and Russell, 1983). Binding  $\alpha_V\beta_3/\alpha_V\beta_5$  integrins on the host cell membranes activates Rho GTPases and PI3 kinases, which in turn alter the cell's cytoskeleton (Li et al., 1998a, Li et al., 1998b). In the acidic endosome/lysosome, protein IIIa and protein VI convert the AdV capsid into a subviral particle (Russell, 2009). The subviral particle, now a shell of hexon, core proteins, and the viral genome, ruptures the membrane of the endosome/lysosome. The virion enters the cytoplasm and travels to the nuclear pore complex via interaction of hexon with microtubules (Dales and Chardonnet, 1973; Greber and Way, 2006; Lepold et al., 2000; Mabit et al., 2002; Suomalaie et al., 1999). The viral genome and protein VII are released from the subviral particle and enter the nucleus through the nuclear pore complex (Greber et al., 1997). Once inside the nucleus, large E1A and small E1A activate the transcription of early genes located in the E1B, E2, and E3 transcription unit. The products of these transcription units prepare the cell for DNA replication. The cell is forced into S phase by products of E1A and E4. E4 encodes viral factors required for viral DNA synthesis, and products of E1B, VA RNA, and E3 modulate the host response to infection.

The E2 transcription unit produces the pre-terminal protein (pTP), viral DNA polymerase (AdPol), and DNA binding protein (DBP), which along with cellular transcription factor NF1, cellular transcription factor OCT-1, and cellular type 1 topoisomerase NFII, allow the replication of AdV genome (de Jong et al., 2003). A heterodimer of pTP and AdPol is formed and then binds to the viral ITRs, located at

both ends of AdV genome. DBP then binds the viral genome, allowing AdPol to begin DNA synthesis through strand displacement. The genome is synthesized off of the template strand. The displaced strand forms a pan-handle structure through the binding of the ITRs at either end of the strand. This pan-handle is recognized by the pTP/AdPol structure which initializes synthesis of the displaced strand (Lechner and Kelly, 1977; Liu et al., 2003).

During late stages of infection, structural proteins are translated from MLP transcripts. The structural proteins encapsidate the viral genome. Virion assembly occurs in the nucleus of the infected cell. The adenovirus death protein (ADP)/E3-11.6K of HAdV-C is produced at this stage during infection (Tollefson et al., 1996). ADP localizes to the nuclear membrane and is involved in the efficient release of progeny virions (Tollefson et al., 1996b).

### **Species B human adenoviruses**

HAdVs have been classified into seven species, A-G (ICTVbd, 2002) (**Table 1**). However, only species A-F have been thoroughly characterized and been detected in humans. HAdV-B serotypes have been further classified into subspecies B1 and subspecies B2 based on relative DNA homology (Wadell, 1984). HAdV-B1 contains HAdV-3, -7, -16, -21, and -50. This thesis focuses on HAdV-3. HAdV-3, -7, -16, and -21 are causative agents of acute lower respiratory infections in the pediatric and military recruit populations. HAdV-3 and -7 are commonly associated with severe and fatal infections in pediatric populations worldwide (James et al., 2007; Kajon et al., 2010; Lee et al., 2010; Selvaraju et al., 2011). Symptoms of HAdV-B infection

include sore throat, coughing, wheezing, runny nose, congestion, vomiting, abdominal pain, and diarrhea. HAdV -3, -7, and -21 infections can also result in long term obstructive lung disease such as constrictive bronchiolitis and bronchiectasis up to ten years after acute infection (Becroft, 1971; Dehghan et al., 2012; Herbert et al., 1977). HAdV-50 was isolated from a patient hospitalized due to AIDS and diarrhea (de Jong et al., 1999). Subspecies B2 includes HAdV-11, -14, -34, -35. HAdV-B2 can cause respiratory disease, urinary tract infections, and conjunctivitis (Wold and Horwitz, 2007).

**Table 1: The seven species of human adenovirus<sup>1</sup>.**

| Species |   | Serotypes   |
|---------|---|---|
| A       |   | 12, 18, 31  |
| B       | 1 | 3, 7, 16, 21, 50  |
|         | 2 | 11, 14, 34, 35  |
| C       |   | 1, 2, 5, 6  |
| D       |   | 8, 9, 10, 13, 15, 17, 19, 20, 23-30, 32, 33, 36-39, 42-49, 51 |
| E       |   | 4   |
| F       |   | 40, 41  |
| G       |   | 52  |

<sup>1</sup>Clustering within species is based on sequence similarity, associated disease type, oncogenicity in rodents, phylogenetics, and organization of the E3 region. This thesis focuses on HAdV-3, a HAdV-B1.

### **Early region 3 transcription unit**

The E3 region of HAdVs encodes non-structural proteins that are not essential for viral replication in cell culture (Ginsberg et al., 1989; Morin et al., 1987). The E3 is the only region of the adenovirus genome that encodes transmembrane proteins

(Wold et al., 1995). The size and number of genes present in the E3 region vary among species A-F of HAdVs. Species A-F each encode the highly conserved ORFs E3-10.4K/RID $\alpha$ , E3-14.5K/RID $\beta$ , and E3-14.7K. HAdV species A-E also encode the highly conserved E3-12.5K and E3-gp19K. Each species also contains an array of species-specific ORFs. A map of the E3 region can be found in **Figure 3**. The majority of this diversity within E3 occurs between the E3-gp19K and E3-10.4K/RID $\alpha$  ORFs (Burgert and Blusch, 2000). The species-specific ORFs encoded within the E3 region share common structural motifs and may have evolved through gene duplication events. The high levels of genetic variability could also be the result of adaptive evolution in order to differentially mediate the immune response of various hosts.

These E3 genes have been described as members of the Conserved Region 1 (CR1) family of genes (Lin et al., 2006). In addition to the CR1 prefix, the CR1 genes have been assigned Greek letters that correspond with their location in the E3 cassette. E3-20.1K, E3-20.5K, and E3-9K have been termed CR1 $\beta$ , CR1 $\gamma$ , and CR1 $\delta$  respectively (E3-16K is termed CR1 $\alpha$ ). In order to differentiate them clearly from other CR1 family members, E3-20.1K, E3-20.5K, and E3-9K will not be referred to by their CR1 designations throughout the remainder of this thesis. The CR1 family of genes is not found in the E3 region of *Siadenovirus* (Davison et al., 2003a). Interestingly, the CR1 family of genes shares common structural characteristics with the human cytomegalovirus RL11 family of genes (Davison et al., 2003b). With the exception of E3-12.5K, the functional roles of the conserved E3 proteins have been established. The roles of most of the species-specific ORFs, however, remain to be elucidated (Lichtenstein et al., 2004).



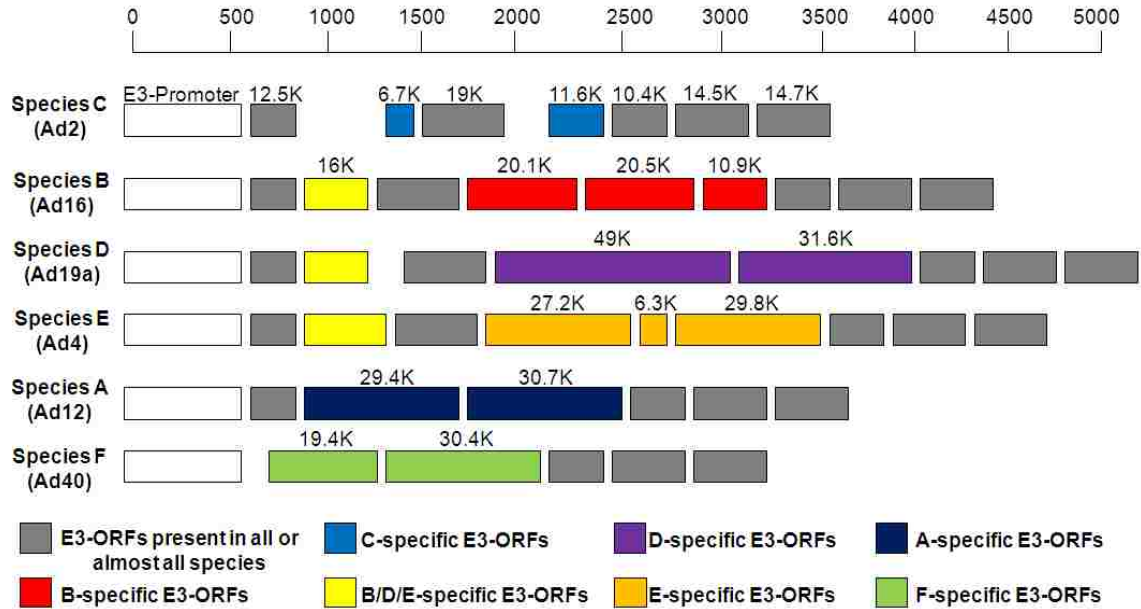

**Figure 3: A representation of the early region 3 transcription unit from members of HAdVs A-F.** Most of the genetic variability in this region occurs between the highly conserved E3-gp19K and RID $\alpha$  (E3-10.4K) open reading frames (adapted from Burgert and Blusch, 2000). The E3-10.9K ORF of HAdV-16 is the ortholog of E3-9K ORF encoded by HAdV-3.

### Functional roles of conserved E3 proteins

Adenoviruses are highly species-specific. This has led to the lack of a suitable animal model for determining the functions of E3 proteins *in vivo*. The following observations on the functions of E3 proteins have been made *in vitro*.

#### E3-gp19K

The glycoprotein E3-gp19K is a type I membrane protein expressed at early times post infection. The N-terminal region contains a signaling sequence that is cleaved during post-translational modification of the protein, and a C-terminal transmembrane domain. E3-gp19K localizes primarily to the endoplasmic reticulum (Lichtenstein et al, 2004). Cytotoxic T-Cell mediated killing of viral-infected cells is

modulated by E3-gp19K. This is accomplished by blocking transport of MHC class I to the plasma membrane, and inhibiting the TAP-MHC class I complex formation (Andersson et al., 1985; Andersson et al., 1987; Burgert and Kvist, 2002, Bennet et al., 1999). Blocking MHC class I from being expressed on the cell surface reduces the killing of infected cells by T cells specific for adenovirus. Independent of its ability to bind MHC class I, E3-gp19K is also able to mimic TAP and bind tapasin, which is required for full maturation of the MHC class I (Bennet et al., 2001).

#### RID $\alpha$ /RID $\beta$ Complex

The RID $\alpha$  (E310.4K) - RID $\beta$  (E3-14.5K) complex is made up of two, small type I transmembrane proteins (Krajcsi et al, 1992a; Krajcsi et al, 1992b). Expression of RID $\alpha$  by itself results in localization to the Golgi, while expression of RID $\beta$  alone results in localization to the Golgi and ER. However, when expressed together, the RID complex localizes to the plasma membrane. (Lichtenstien et al., 2002; Stewart et al., 1995; Tollefson et al., 1998). The RID complex is responsible for blocking apoptosis of infected cells. This is accomplished by down regulating pro-apoptotic receptors TRAILR1, TRAIL2, TNFR, and FAS ligand receptor and by blocking the activation of NF- $\kappa$ B (Tollefson et al., 2001; Benedict et al., 2001; Freidman and Horwitz, 2002). The RID complex can also protect the cell from EGF-mediated inflammation through down regulation of EGFR (Wold et al., 1999). The RID complex acts by down regulation of these receptors at the plasma membrane, and not by degrading mRNA or inhibiting the receptors from reaching the plasma membrane in a manner similar to E3-gp19K (Lichtenstein et al., 2004). RID removes these

receptors from the plasma membrane and targets them for degradation through the lysosome (Carlin et al., 1989; Tollefson et al., 1998; Toth et al., 2002). Internalized TRAILR1, and FAS ligand receptors were co-localized with LAMP-1 and LAMP-2 through confocal microscopy (Tollefson et al., 1997; Benedict 2001).

Pro-apoptotic receptors, Fas ligand receptor, EGFR, and TRAIL receptors, are internalized through the tyrosine-sorting signal found on the C-terminal domain of RID $\beta$  (Lichtenstien et al., 2002). The tyrosine-sorting motif, as reviewed by Kirchhausen (1999), is defined by the consensus sequence YXX $\phi$ . Y is the amino acid tyrosine, X represents any amino acid, and  $\phi$  is a hydrophobic amino acid with a bulky side chain. A di-leucine (LL) sorting motif is located in the cytoplasmic domain of RID $\alpha$ , and is critical of the internalization of Fas ligand and EGF receptors (Zanardi et al., 2003; Hilgendorf et al., 2003). The tyrosine sorting and di-leucine sorting signals have been shown to interact with clathrin adaptor proteins, and target the receptor for degradation through the endosomal pathway (Ohno et al., 1995; Bonifacino and Traub, 2003).

### E3-14.7K

E3-14.7K is the only known protein encoded by E3 region that is not an integral membrane protein. Instead, it localizes to the cytosol and nucleus (Gooding et al., 1990; Li et al., 1998). During viral infection, and when expressed alone, E3-14.7K can protect the host cell from TNF-mediated cytolysis through release of arachidonic acid (Gooding et al., 1988; Gooding et al., 1990; Krajcsi et al., 1996). It has been suggested

that E3-14.7K could also prevent cell death through the interference of Fas ligand receptor and by binding Caspase-8 (Chen et al., 1998).

### **Functional roles of species-specific E3 proteins**

#### E3-6.7K

The E3 region of HAdV-C encodes a unique 6.47kDa transmembrane protein. E3-6.7K is a type III transmembrane protein that localizes to the ER and potentially to the plasma membrane with the RID complex (Wilson-Rawls et al., 1990; Wilson-Rawls and Wold, 1993; Benedict et al., 2001). The E3-6.7K protein is encoded between the E3-12.5K and E3-gp19K ORFs. E3-6.7K plays an important role in RID-mediated internalization of TRAIL receptors (Benedict et al., 2001). E3-6.7K also inhibits apoptosis induced by TNF, thapsigargin, Fas ligand, and TNF-mediated release of arachidonic acid. E3-6.7K is proposed to function mainly in the ER and maintains cytosolic concentrations of  $Ca^{2+}$  (Moise et al., 2002).

#### Adenovirus death protein (ADP)

HAdV-C encodes an 11.6kDa protein between the highly conserved E3-gp19K and RID $\alpha$  ORFs. This protein has been named the adenovirus death protein (ADP). Unlike other proteins of the E3 transcription unit, ADP is produced at low levels during early time points post infection. However, after DNA replication has begun, there is a switch of ADP transcription from the E3 promoter to the MLP. ADP is then

produced at levels similar to viral capsid proteins during late time points post infection (Tollefson et al., 1996a). ADP is responsible for the efficient release of progeny virions. The loss of ADP results in the formation of small plaques and swollen nuclei in infected cells. This is due to the inability of the virions to be released from the nucleus, and not deficiency in the replication of the virus (Tollefson et al. 1996b). ADP's mechanism of action is still under investigation. ADP does not show any homology to known caspases or any other proteins involved in cell death. It has been observed that degradation of cellular DNA and RNA occurs in cells infected with HAdVs encoding intact ADP. This degradation is not seen in cells infected with a mutant lacking the ability to transcribe ADP (Tollefson et al., 1996). Through yeast two hybrid screening and GST pull down assays, the C-terminal domain of ADP was shown to interact with MAD2B (mitotic arrest deficiency 2B). Cell lysis was slowed by over expressing MAD2B in infected cells (Ying and Wold, 2003). MAD2B has been implicated in the spindle assembly checkpoint and promoting error-prone DNA replication (Cahill et al., 1999; Murakumo et al., 2000). However, the role of ADP in affecting these processes has not been established.

ADP is a type III integral membrane protein with a N-terminal luminal domain and a C-terminal cytoplasmic domain. ADP also contains a central signal sequence that is not cleaved during post-translational modification. The ADP backbone is modified by a palmitic acid, N- and O- linked oligosaccharide (Scaria et al., 1992; Tollefson et al., 2003). ADP's subcellular localization varies through the progression of infection. The protein is initially (16-18 hours post infection) located primarily in the Golgi. At 18hpi, the protein is then seen in the ER. The amount seen in the ER

increases until 33hpi, where there is switch to ADP being primarily located at the nuclear membrane (Tollefson et al., 1992).

ADP in HAdV vectors can be beneficial or detrimental depending on the desired function of the vector. Unlike other E3 proteins, ADP does not modulate the host response to infection, but it does enhance the cell-to-cell spread of the virus. Oncolytic viruses can use this feature as an advantage. However, if the vector is designed to produce long term transgene expression, then the deletion of ADP from the E3 region would be advantageous.

### **Gaps in the current knowledge**

HAdV-B1s are the causative agents of severe and fatal respiratory disease. Yet our understanding of the unique molecular pathobiology of this group of adenoviruses is still limited. This is due to the fact the HAdV-Cs remain the most commonly studied of all the known HAdVs. While the core mechanisms of viral replication are most likely conserved among HAdVs, the way the virus interacts with the host cell and the host's immune system is expected to be highly variable. The majority of proteins encoded by the E3 region modulate the host response to viral infection. The E3 region is a valid target for identifying new mechanisms that are responsible for each virus' unique molecular biology.

Overall egress of nonenveloped viruses also remains poorly understood. The budding of enveloped viruses has been well characterized for many different families and genera. However, it has been assumed that most non-enveloped viruses exit from the infected cell through lysis. The discovery of ADP has shown that viral egress can

be much more tightly organized and temporally controlled. Viroporins, which are small, hydrophobic transmembrane proteins encoded by viruses (Carrasco, 1995), have also been discovered to play a significant role in the release of nonenveloped viruses like poliovirus (Aldabe et al., 1996). ADP is encoded in the highly variable region of E3, between E3-gp19K and RID $\alpha$ . Since each species of HAdV encodes its own unique array of species-specific proteins in this region, it is reasonable to investigate the E3 transcription unit for unique mediators of viral egress.

## **Chapter 3: Materials and Methods**

### **Cells**

A549 cells (ATCC, #CL-185) were grown in Eagle Minimum Essential Medium (EMEM) supplemented with 8% (v/v) new born calf serum (NBCS). During infection, A549 cells were maintained in EMEM with 2% NBCS (v/v). Calu3 cells (ATCC HTB-55) were grown in RMPI with 10% fetal bovine serum (FBS) and 2% FBS during infection. HeLa-T-REx cells (Invitrogen, R7 14-07) were grown in EMEM with 10% FBS. Cell lines were passed twice per week.

### **Viruses and infection**

The prototype strain of HAdV-3, GB, was used. HAdV-3 is a HAdV-B1. The E3 of HAdV-3p contains the three novel ORFs of interest: E3-20.1K, E3-20.5K, and E3- 9K (an ortholog of the E3-10.9K protein) located between the highly conserved E3-19K and E3-10.4K ORFs (Kajon et al., 2005. Frieze et al., 2010; Sirena et al. 2005).

Viral stocks were grown in A549 monolayers and harvested after three freeze/thaw cycles. Titers of infectious virus for stock preparations and all experiments were determined by standard plaque assay with an agarose medium overlay (as previously described by Wold et al, 1999). Virus infections were carried out at a multiplicity of infection (MOI) of 5 or 10 plaque forming units (PFU) per cell. Medium on the cells was removed before adding the inoculum. The cells were then incubated for 1 hour at 37°C with 5% CO<sub>2</sub> with rocking every 15 minutes. Following the incubation period, cells were replenished with infection medium.



## **Secondary structural predictions**

Hydrophobicity plots of the predicted amino acid sequence of E3-20.1K and E3-20.5K were generated using ProtScale (Gasteiger et al. 2005, <http://us.expasy.org/cgi-bin/protscale.pl>). Candidate signal sequences were determined by using SignalP 3.0 (Emanuelsson et al. 2007, <http://www.cbs.dtu.dk/services/SignalP/>). Potential N-glycosylation (Gupta et al. 2004, <http://www.cbs.dtu.dk/services/NetNGlyc/>), O-glycosylation (Julenius et al, 2005, <http://www.cbs.dtu.dk/services/NetOGlyc/>), and palmitoylation sites (Ren et al, 2008, <http://csspalm.biocuckoo.org/online.php>) were determined using web based prediction programs. The membrane topologies of E3-20.1K and E3-20.5K were predicted using HMMTOP (Tusnady and Simon, 1998, <http://www.enzim.hu/hmmtop/index.html>).

## **EGFP fusion protein constructs**

Due to a lack of antibodies for E3-20.1K and E3-20.5K, C-terminal EGFP fusions of the two proteins were created to permit the study of subcellular localization in an ectopic expression system. Each ORF was amplified using high fidelity DNA polymerase (iProof, Bio-Rad, Hercules, CA). Primers for this amplification introduced convenient restriction sites for cloning into pEGFP-N1 (Clontech, Mountain View, CA). For ectopic expression under tetracycline regulation, the EGFP fusion was subcloned into pcDNA 4/TO (Invitrogen, Carlsbad, CA). The vectors that were generated were designated E3-20.1K-EGFP pcDNA 4/TO and E3-20.5K-EGFP pcDNA.

### **Transfection of HeLa T-Rex cells**

HeLa T-REx were plated on 100mm coverslips and transfected with 1ug of E3-20.1K-EGFP pcDNA 4/TO or E3-20.5K-EGFP pcDNA using Effectene Transfection Reagent (Qiagen, Valencia, CA) 24 hours after plating. Tetracycline (1ug/ml) was added to the culture medium 24 hours after transfection to induce expression of the EGFP fusion proteins. Cells were either fixed with 4% paraformaldehyde, or protein lysates were collected using RIPA buffer (NaCl, Tris, SDS, Triton X-100, Deoxycholate, EDTA).

### **Generation of mutant HAdV-3 viruses**

In order to investigate the roles of E3-20.1K, E3-20.5K, and E3-9K in the HAdV-3 life cycle, we generated knockout (KO) viruses lacking the ability to produce HAdV-3 B-specific E3 proteins. These viruses were created using the highly efficient bacteriophage  $\lambda$  red recombination system in *E. coli* (Poteete, 2001). Using this system, we generated the recombinant control HAdV-3-FRT, HAdV-3 -FRT Double KO (lacking the ability to produce E3-20.1K and E3-20.5K), and HAdV-3-FRT Triple KO (lacking E3-20.1K, E3-20.5K, and E3-9K). The start codon of each ORF was mutated from a “ATG” to “ATT”. Additionally, a “TGA” stop codon was introduced downstream of the mutated start codon.

Dr. Silvio Hemmi provided the chloramphenicol-resistant bacmid pKSB2Ad3wt (Sirena et al., 2005) which contains the entire genome of HAdV-3p strain GB (GenBank accession DQ086466). Dr. Samuel Campos, from the University of Arizona, generated the ampicillin-resistant shuttle vector pSCE3B containing the entire E3 region of HAdV-3p GB (**Figure 4A**). pSCE3B, was generated to facilitate modification of the E3-20.1K,

E3-20.5K, and E3-9K ORFs within pKSB2Ad3wt. pSCE3B was constructed by PCR cloning into plasmid pFZF (Campos and Barry, 2004). Briefly, annealed oligos containing unique *AscI* and *AgeI* sites or *AvrII*, *AflIII*, and *Acc65I* sites were cloned in between the *SalI* and *BamHI* sites or *NheI* and *NotI* sites of pFZF respectively, to generate pFZF2. The E3-20.1K, E3-20.5K, and E3-9K ORFs, as well as ~2.0 kb upstream and downstream sequences were sequentially PCR-cloned into pFZF2 using the *AscI/AgeI*, *AvrII/AflIII*, *AflIII/Acc65I*, *SalI/AscI*, and *Acc65I/NotI* sites respectively. The resulting plasmid, pSCE3B, has each of the E3-20.1K, E3-20.5K, and E3-9K ORFs flanked by unique restriction sites for modification or replacement of the wild type ORFs with mutant or epitope-tagged versions and places the *Flipase* recognition target (FRT)-flanked zeocin resistance gene in between the E3-20.1K and E3-20.5K ORFs. The *SalI/NotI* fragment of pSCE3B can then be recombined into the pKSB2Ad3wt bacmid and the FRT-flanked ZeoR cassette can be excised to generate E3-20.1K, E3-20.5K, and E3-9K mutants.

The pSCE3B shuttle vector underwent site directed mutagenesis to introduce mutations to the start codon of each novel E3 ORF and introduce the “TGA” stop codon downstream of the mutated start codon. The newly generated pSCE3B shuttle vectors were then linearized with *SalI* and *NotI*. The E3 fragment released from pSCE3B was electroportated into *E. coli* harboring pSKB2Ad3wt and pKD46. The temperature-sensitive replicon pKD46 expresses the  $\lambda$  red recombination genes at room temperature under the arabinose-inducible BAD promoter (Datsenko and Wanner, 2000). The cells were electroporated in a 0.2cm gap cuvette in a micropulser (BioRad) set at 2500V. Cells were then rescued with 1mL of SOC + L-arabinose broth and incubated at room

temperature with gentle rocking overnight. This resulted in the recombination of the linearized E3 fragment with pSKB2Ad3wt. Positive clones were selected by plating 100µl of the electroporated cells on LB agar containing 34µg/mL chloramphenicol and 50µg/mL zeocin. Recombinant bacmids were purified via alkaline lysis and electroporated (in the same conditions as above) into an *E. coli* strain SW105 (Warming et al., 2005). Flip recombinase genes were activated after rescue with SOC + L-arabinose broth. Cells were incubated at room temperature overnight with gentle rocking. This resulted in the collapse of the FRT-Zeocin-FRT cassette into one 34bp FRT site located between E3-20.1K and E3-20.5K. Successful recombination also leads to the loss of zeocin resistance. Cells were plated on 34µg/mL LB agar plates and grown overnight at 30°C. Colonies

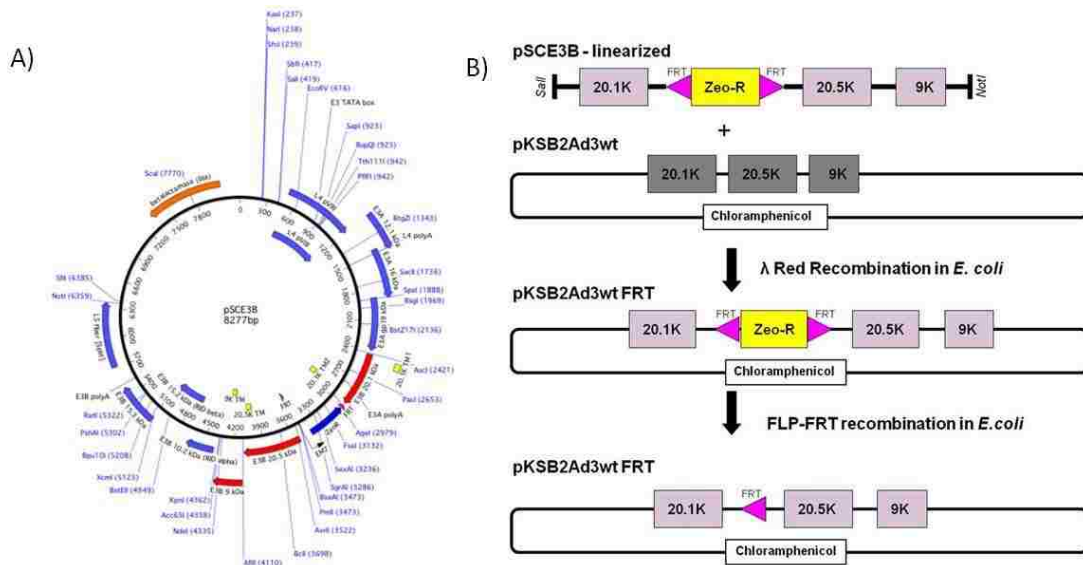

**Figure 4: Overview of the recombination strategy used to generate mutant HAdV-3.**

A) The shuttle vector pSCE3B encoding the entire E3 region of HAdV-3p. B) Starting with the linearized E3 region from pSCE3B shuttle vector and the pKSB2Ad2wt.  $\lambda$  Red recombination *E. coli*, to insert the E3 fragment from pSCE3B into the pSKB2Ad3wt bacmid, was followed by Flippase, to remove the zeocin resistance gene and leave behind a 34bp FRT scar site. The final pKSB2Ad3wt bacmid, containing the mutated E3 region, is then digested with *MluI* to linearize the viral genome. The genome is then transfected into A549 cells, and infectious virus is produced.

were selected and screened for zeocin sensitivity. An overview of the generation of recombinant bacmids can be found in figure 4B.

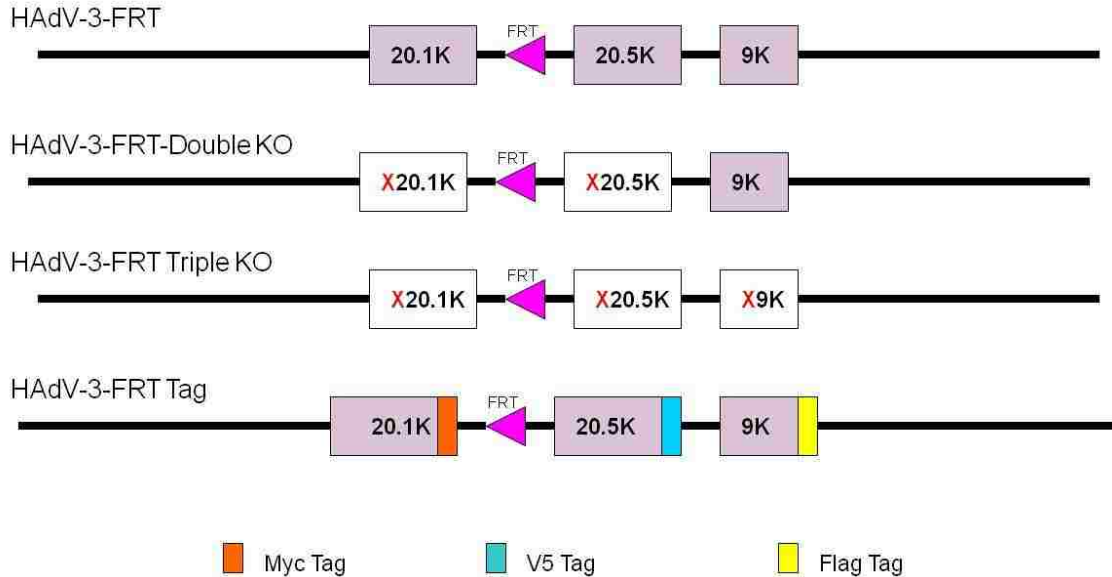

**Figure 5: Map of the mutated HAdV-3 E3 ORFs.** The E3 region of pSCE3B was mutated and then recombined with pKSB2Ad3wt. The E3 region of each mutant virus was sequenced. The above map demonstrates the E3 proteins that were knocked out, fused with a small, C-terminal epitope tag, and the location of the FRT scar site for each mutants

The newly generated mutated pKSB2Ad3wt bacmids were then digested with *MluI* to linearize the HAdV-3-FRT genome. The 1 $\mu$ g of digested DNA was transfected into A549 cells using Effectene Reagent (Qiagen, Valencia, CA). The transfected cells were then incubated for 14 days at 37°C, with additional media added to the cells at 7 days post transfection. Cells were then subjected to three freeze/thaw cycles at -80°C and 25°C to harvest virus. Samples were then clarified by centrifugation, and then passaged in A549 cells until characteristic HAdV-B cytopathic effect (CPE) was observed. Virus stocks were grown and tittered in A549 cells. The E3 region of each virus was amplified by PCR and sequenced to confirm the identity of each virus. Four HAdV-3 mutants were

generated in this manner: HAdV-3-FRT as a recombination control, HAdV-3-FRT-Double KO (knocking out E3-20.1K and E3-20.5K), HAdV-3-FRT-Triple KO (knocking out E3-20.1K, E3-20.5K, and E3-9K), and HAdV-3-FRT-Tag (with small, C-terminal epitope tags fused to each of the three novel E3 proteins) as seen in **Figure 5**.

## **Immunofluorescence**

### EGFP fusion constructs

HeLa TRex cells transfected with EGFP fusions were incubated for 10 minutes at 37°C with 1µg wheat germ agglutinin conjugated with Alexa Fluor 647 (Molecular Probes, Carlsbad, CA). Coverslips with cells were then washed 3x in PBS before being fixed with 4% paraformaldehyde (v/v) for 15 minutes. Cells were quenched after fixation by washing in PBS with 100mM glycine 3 times for 5 minutes each wash. Coverslips were submerged in dd H<sub>2</sub>O before mounting on slides with SlowFade Gold with DAPI (Molecular Probes, Carlsbad, CA).

Images of transfected HeLa T-Rex cells were acquired with a Zeiss epifluorescence Axioscop with Hamamatsu Digital camera controlled by Slide Book Images Analysis v5.0 (Intelligent Imaging Innovations, Denver, CO). SlideBook deconvolved the images using a nearest neighbor algorithm.

### HAdV-3-FRT-Tag mutant virus infections

A549 cells were seeded onto 18mm glass coverslips in 12 well plates. When cells were approximately 80-90% confluent, cells were counted and infected with HAdV-3-FRT-Tag at an MOI of 10 PFU/cell. After infection, cells were incubated at 37°C for 1

hour, with intermediate rocking. Infected cells were then washed three times in 1xPBS and replenished with A549 infection medium. Cells were then incubated at 37°C for 24 or 48 hours post infection.

At 24 or 48hpi, cells were washed three times in 1xPBS. Cells were fixed by adding 100µl of 4% paraformaldehyde/acetone (mixed at 3:1 ratio) for 10 minutes. After fixation cells were washed 3x in 1xPBS. Cells were blocked with 10% goat serum (Jackson Immuno Research, West Grove, PA) and PBS with 0.02% Tween20 (Invitrogen, Carlsbad, CA). After blocking, cells were stained with primary antibodies targeting the unique epitope tags that were engineered onto the C-terminal end of each of the E3 proteins under investigation: E3-20.1K-Myc, E3-203.5K-V5, and E3-9K-Flag. Primary antibodies used were:  $\alpha$ -Myc-Tag 9B11 (#2276, 1:500 dilution, Cell Signaling, Danver, MA),  $\alpha$ -V5 Tag (ab9113, 1:1000 dilution, AbCam, Cambridge, MA),  $\alpha$ -DYKDDDDK Tag (Binds to same epitope as Sigma's Anti-Flag M2 Antibody) (#2368, 1:200 dilution, Cell Signaling), and  $\alpha$ -Flag M2 (F3165, 1:200 dilution, Sigma-Aldrich, St. Louis, MO). Cellular markers for the early endosome (EEA1), late endosome/lysosome (LAMP2), and the Golgi (Giantin) were counterstained in infected cells. Antibodies used for the cellular markers were:  $\alpha$ -EEA1 C45B10 (#3288, 1:200, Cell Signaling),  $\alpha$ -LAMP2 GL2A7 (ab13524, 1:200 dilution, AbCam), and  $\alpha$ -Giantin (ab24586, 1:1000 dilution, AbCam).

All primary antibodies were made up in 1% Goat serum and 1xPBS with Tween 20 and 100µl of appropriate antibody were added to the cells. Cells were incubated at room temperature for one hour, while rocking. Cells were then washed 3x in 1xPBS with three minutes in-between each wash. Appropriate secondary antibodies were prepared in

1% goat serum, Hoechst stain (H3570, 1:400 dilution, Invitrogen, Carlsbad, CA), and 1xPBS with Tween20. Cells were incubated with 100µl of the appropriate secondary antibody for one hour, in the dark, while rocking. Cells were then washed 3x in 1xPBS with three minutes in between washes. Coverslips with attached cells were then mounted on glass coverslips. Cells were imaged on a Zeiss LSM510 META Confocal Microscope (Carl Zeiss, Inc., Oberkochen, Germany) at the University of New Mexico & Cancer Center Fluorescence Microscopy Shared Resource, as funded in detail on: <http://hsc.unm.edu/crtc/microscopy/Facility.html>.

### **Reverse transcriptase PCR**

A549 cells were infected with HAdV-3p at an MOI of 5 PFU/cell. Total RNA was isolated at early (8 and 10 hours) and late (20 and 24 hours) time points post infection using RNAqueous kit (Ambion, Austin, TX) following the manufacture's protocol. To remove any contaminating DNA, total RNA samples were treated with TURBO DNA-free kit (Ambion, Austin, TX). Total RNA was tested for the presence of DNA after DNase treatment with PCR using primers specific for RIG.

After RNA isolation, cDNA was generated from each sample using 1µg of RNA, random decamer primers, and the RETROscript kit (Ambion, Austin, TX) following manufacture's protocol. cDNA was amplified using GoTaq polymerase (Promega, Madison, WI) using the manufacture's protocol. Primers to amplify E3-20.1K, E3-20.5K, E3-10.9K, Hexon (late time point control), and RIG (reverse transcriptase control) are detailed in Table X. Agarose gel electrophoresis (in Tris-Borate-EDTA buffer) was used



to analyze the PCR products. Ethidium bromide staining in a Universal HoodII/Gel Doc XR camera and the Quantity One software (Bio-Rad, Hercules, CA) were used to visualize the DNA bands.

**Table 2: Primers used for detection of cDNA transcripts of E3-20.1K, E3-20.5K, E3-9K, Hexon, and RIG/S15**

| Primer Name       | Primer Sequence                   | Annealing Temp | Extension Time |
|-------------------|-----------------------------------|----------------|----------------|
| E3-20.1K Forward  | 5' CCATATTACCTTAAGACATAATCACAC 3' | 58C            | 30 sec         |
| E3-20.1K Reverse  | 5' GTGCCATTCCCAATGC 3'            | 58C            | 30 sec         |
| E3-20.5K Forward  | 5' CCTTGCACTGTAACCTATGG 3'        | 58C            | 30 sec         |
| E3-20.5K Reverse  | 5' AATCCCACTACCACGGC 3'           | 58C            | 30 sec         |
| E3-9K Forward     | 5' GTTCAATCAAATACC 3'             | 40C            | 30 sec         |
| E3-9K Reverse     | 5'CTAATCATAGGAGAATAG 3'           | 40C            | 30 sec         |
| E3-9K Reverse 58C | 5' GGGACGACTAATCATAGGAGAATAG 3'   | 58C            | 30 sec         |
| Hexon Reverse     | 5' GGTCTGTTAGGCATGGC 3'           | 58C            | 45 sec         |
| RIG/S1 Forward    | 5' TTCGCAAGTTCACCTACC 3'          | 58C            | 30sec          |
| RIG/S15 Reverse   | 5' CGGGCCGGCCATGCTTTA 3'          | 58C            | 30 sec         |
| Ad-3-TPL3         | 5' CAGTCGCAATCGCAAG               | 58C            |                |

### Plaque Accumulation Assay

A549 cells were infected with 50 plaque-forming units of HAdV-3, HAdV-3-FRT, HAdV-3-FRT-Double Knockout, and HAdV-3-FRT-Triple Knockout in 60mm dishes. After a one-hour incubation at 37°C with intermediate rocking, cells were overlaid with 2% MEM agarose overlay. Plaque accumulation was recorded over a 15-day period.

### Statistics

Mean and standard error were calculated and graphed using GraphPad Prism 5.

## Chapter 4: Results

### **HAdV-3 E3-20.1K, E3-20.5K, and E3-9K triple knock out mutant does not display impaired growth in an infected cell monolayer**

Species A-F of human adenoviruses contain a species-specific array of ORFs between the highly conserved E3-gp19K and RID $\alpha$  ORFs. The only protein encoded in this region with an assigned function is the adenovirus death protein (ADP) encoded by HAdV-C. ADP is required for efficient release of progeny virions. The ADP-deficient HAdV-C pm734.1 shows an impaired growth phenotype when compared to the wild type HAdV-C Rec700 (Ad-5/2/5) virus in a representative experiment (**Figure 6A**). To investigate whether one or more of the products of E3-20.1K, E3-20.5K, or E3-9K act in a similar manner as ADP with regards to viral egress in HAdV-B1, HAdV-3 mutants were generated using the recombination strategy described above. The start codons of E3-20.1K, E3-20.5K, and E3-10.9K were mutated from “ATG” to “ATT” and an additional “TGA” stop codon was introduced downstream of each mutated start codon in the pSCE3 shuttle vector before they were recombined with pKSB2Ad3wt. Three mutant HAdV-3 viruses were generated: wild-type virus (HAd3p-WT), the HAdV-3-FRT control virus that has undergone the recombination pathway, acquiring the Flippase Recognition Target (FRT) scar site, with no additional mutations, and HAdV-3-Triple KO with E3-20.1K, E3-20.5K and E3-10.9K knocked out. After infecting monolayers of A549 cells, extracellular and total virus were collected at 6, 12, 24, 48, 72, 96, and 120 hours post-infection. Infectious titers in plaque forming units (PFUs) per mL of each sample were determined by standard plaque assay. In contrast to the HAdV-C ADP deletion mutant no

significant difference in viral titer was seen at any time point between HAdV-3-Triple KO virus, HAdV-3-WT, and HAdV-3-FRT control viruses (**Figure 6B and C**). HAdV-3-FRT Double KO was not tested in these experiments. HAdV-3-FRT Double KO does have an intact E3-9K. However, our lab has shown that deleting E3-9K alone does not impact growth phenotype of HAdV-3 (Frietze et al., 2012). Furthermore, HAdV-3-FRT Double KO was tested in a similar experiment using polarized epithelial cells (Figure 7), and growth phenotype was not impacted in the more physiologically relevant system.

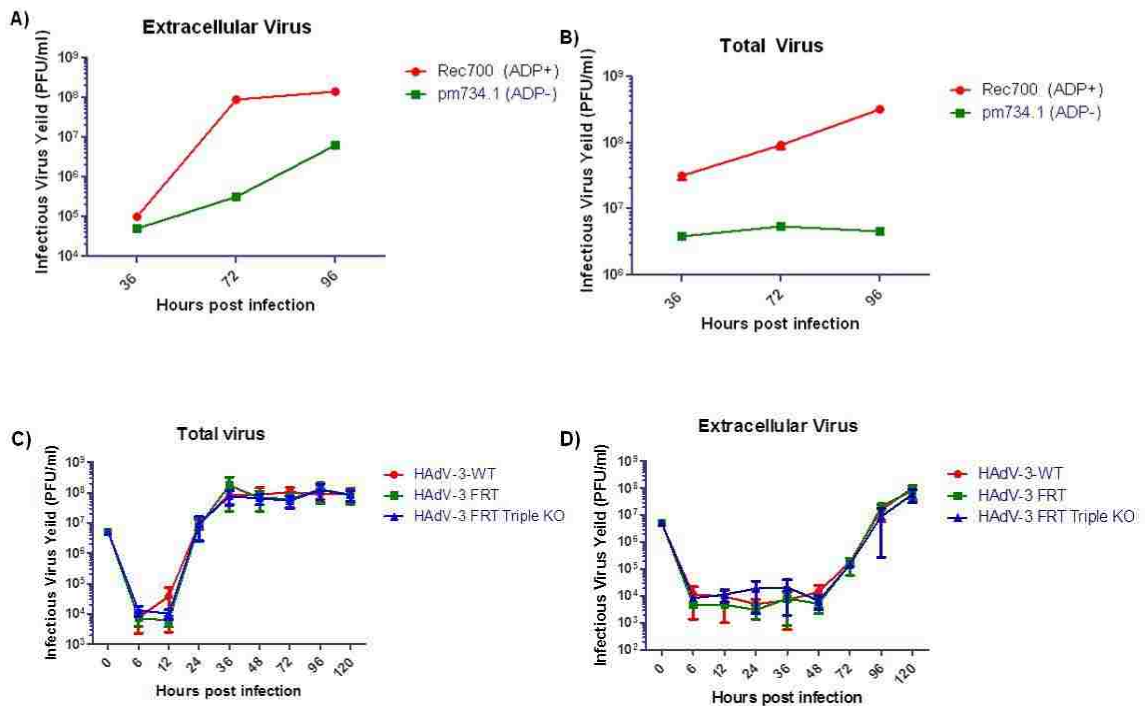

**Figure 6: Release of progeny virions from non-polarized A549 cells is not mediated by E3-20.1K, E3-20.5K, or E3-9K.** A549 cells were infected with Rec700 or pm734.1. Total virus (A) and Extracellular virus (B) were collected at 36, 72, and 96 hours post infection. Rec700 showed significantly higher total and extracellular infectious viral titers than pm734. A549 cells were infected with HAdV-3-WT, HAdV-3-FRT, or HAdV-3-Triple KO at an MOI of 10 PFU/cell. Total virus (C) and extracellular virus (D) were collected at 6, 12, 24, 48, 72, 96, and 120 hours post-infection. No significant difference was seen in total or extracellular titers between the HAdV-3-Triple KO and the wild type viruses. Viral titers were determined by standard plaque assay on A549 cells.

The altered release of progeny virions from polarized cells has been observed in other non-enveloped DNA viruses such as polyomaviruses. In polarized epithelial cells polyomaviruses are released from the apical side of the infected cells (Clayson et al., 1989). In order to determine if the novel E3 proteins, 20.1K, 20.5K, or 9K, alter the release of progeny HAdV-B1 virions in polarized cells, lung epithelial Calu3 cells in trans-well plates were infected with HAdV-3-WT, HAdV-3-FRT, HAdV-3-Triple KO, HAdV-3-Double KO. Virus was added to the apical side at an MOI of 10 PFU/cell. Cells were incubated at 37°C for one hour with intermediate rocking before both apical and basal compartment were replenished with infection medium. Apical supernatant was collected at 48, 76, 96, and 120 h pi and assessed for infectious virus load by standard plaque assay in A549 cells. No significant difference was seen between the control and knock out mutant viruses (**Figure 7**). Taken together, these and the data from non-polarized epithelial A549 cells, indicate that E3-20.1K, E3-20.5K, and E3-9K do not play a crucial role in the replication cycle or release of progeny virions in infected cell monolayers.

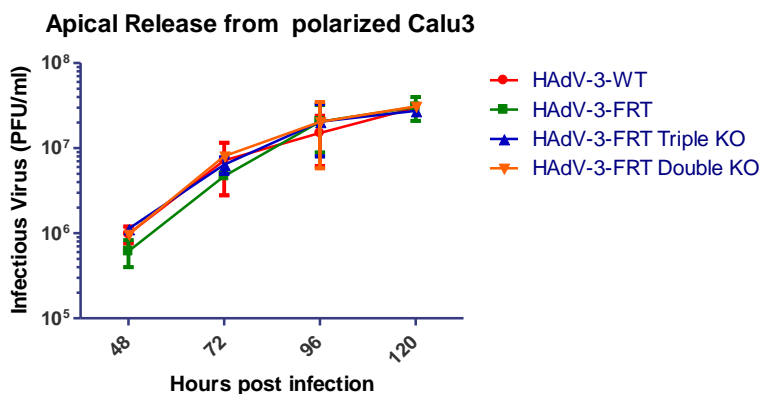

**Figure 7: Apical release of progeny virions from polarized epithelial cells is not mediated by E3-20.1K, E3-20.5K, or E3-9K.** Calu3 cells were infected with HAdV-3-WT, HAdV-3-FRT, HAdV-3-Triple KO, HAdV-3-Double KO at an MOI of 10 PFU/cell. Medium in the apical compartment was collected at 48, 72, 96, and 120-hour post infection. Virus titer was determined by standard plaque assay on A549 cells. The knockout mutants reached titers similar to the wild type and control viruses.

## HAdV-3-Triple KO and HAdV-3-Double KO do not show impaired dissemination through an infected cell monolayer

The ADP-deficient mutant pm734.1 retains progeny virions in the nucleus of infected cells (Tollefson et al. 1996b). Due to ineffective release of viral particles, this mutant does not disseminate through an infected cell monolayer as efficiently as the wild type virus Rec700. In order to investigate the role of E3-20.1K, E3-20.5K, and E3-9K on dissemination, A549 cells were infected with HAdV-3-FRT, HAdV-3-FRT-Double KO, HAdV-3-FRT-TKO, Rec700, and pm734.1 at MOIs of 0.001, 0.01, 0.1 and 1.0 PFU/cell. Unlike the HAdV-C pm734.1 ADP deletion mutant, HAdV-3-Triple KO and HAdV-3-Double KO mutants were able to disseminate through the cell monolayer just as efficiently as the wild type (data not shown) and HAdV-3-FRT viruses (**Figure 8**).

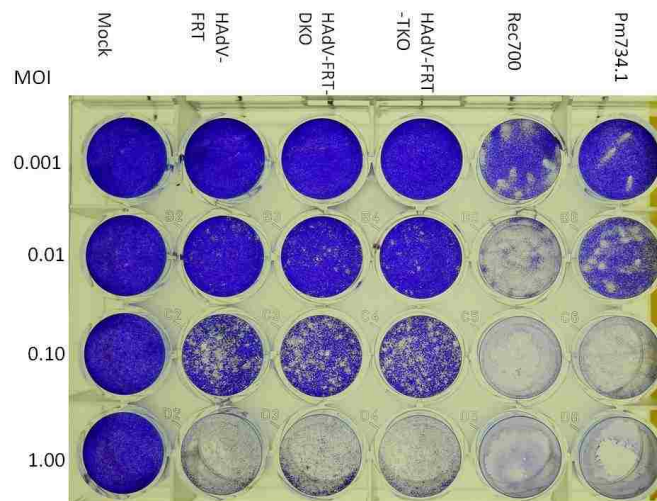

**Figure 8: Dissemination of HAdV-3 is not affected by the loss of E3-20.1K, E3-20.5K, or E3-9K.** A549 cells were infected with HAdV-3-WT (data now shown), HAdV-3-FRT, HAdV-3-Triple KO, HAdV-3-Double KO, Rec700, and pm734.1 at MOIs of 1.0, 0.1, 0.01, and 0.001 PFU/cell. Cells were fixed at eight days post infection. Rec700 was able to disseminate throughout an infected cells monolayer much more readily than pm734.1. HAdV-3-Triple KO and HAdV-3-Double KO did not show any impaired dissemination when compared to HAdV-3-WT and HAdV-3-FRT.

### **Accumulation of plaques is not inhibited by the loss of E3-20.1K, E3-20.5K, and E3-9K**

The accumulation of plaques in cells infected with pm734.1, an ADP knockout virus of HAdV-C, is significantly inhibited when compared to cells infected with the wild type virus Rec700. When knocked out, ADP was the only product of the E3 region that showed any phenotypic difference on the accumulation of plaques (Tollefson et al., 1996b). In order to examine if the novel E3 proteins located in HAdV-B1 play a critical role in the accumulation of plaques, A549 cells were infected with 50 plaque-forming units of HAdV-3-WT, HAdV-3-FRT, HAdV-3-Triple KO, or HAdV-3-Double KO. An agarose overlay was added to the infected cells after a one-hour incubation with the virus. The number of plaques that appeared were counted over a 15-day period and were reported as a percentage of the total number of plaques seen on day 15 (**Figure 9**). No significant difference was observed between the wild type, recombination control, and the knockout mutants. The novel proteins located in the E3 region of HAdV-B1 do not play a discernable role in accumulation of plaques over time.

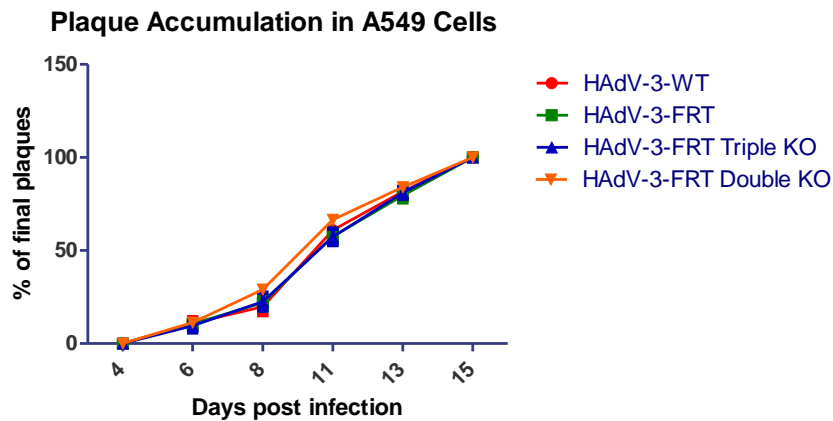
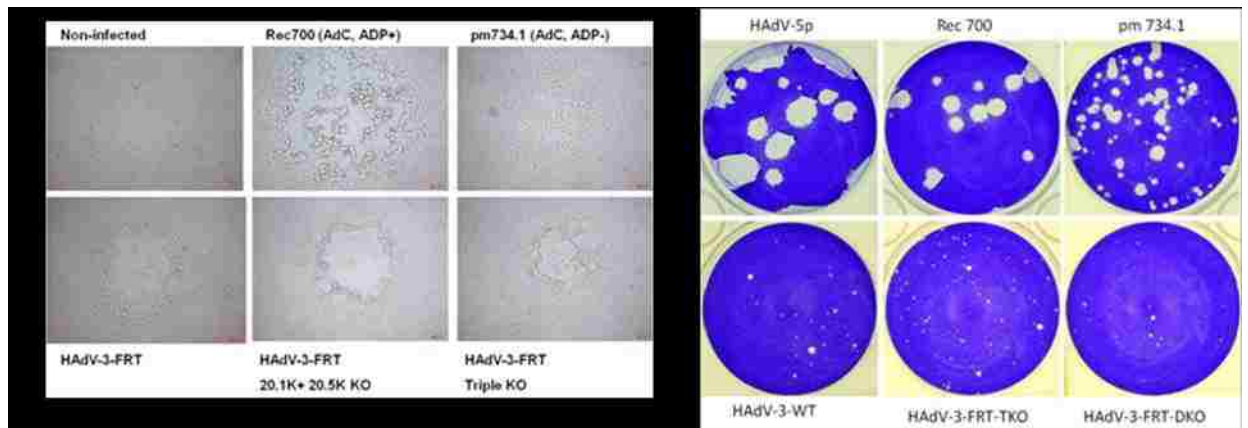

**Figure 9: Plaque size is not affected by the HAdV-B1 E3 proteins 20.1K, 20.5K, and 9K.** A549 cells in 60mm dishes were infected with 50 PFUs of HAdV-3-WT, HAdV-3-FRT, HAdV-3-Triple KO, or HAdV-3-Double KO. Cells were then overlaid with and agarose medium. The number of plaques that appeared were counted over a 15-day period and reported as a percentage of the total number of plaques seen on day 15. The number of plaques that accumulated in the cells infected with the knockout viruses did not vary significantly than cells infected with the control viruses.

### **E3-20.1K, E3-20.5K, and E3-9K do not play a critical role in plaque development during infection**

Tollefeson and colleagues (1996b) observed that when ADP was knocked out in a HAdV-C, the size of plaques generated by that virus were much smaller than plaques generated by the wild type virus or any other E3 gene knockout virus. A549 cells were infected with HAdV-3-FRT, HAdV-3-Triple KO, HAdV-3-Double KO, Rec 700, pm734.1. Images of the plaques that formed were taken on day 7 post infection (**Figure 10A**). Six well plates were also infected with HAdV-3-WT, HAdV-3-Triple KO, HAdV-3-Double KO, HAdV-5p (a wild type species C HAdV), Rec 700, or pm734.1. The cells were fixed and stain to visualize plaques over an entire cell monolayer (**Figure 10B**). Rec700 produced large plaques with extensive CPE. In contrast pm734.1

produced smaller plaques with less CPE and more cells that appeared to still be viable. The cells infected with HAdV-3-FRT, HAdV-3-Triple KO, or HAdV-3-Double KO all produced small plaques with no observable difference in size or amount of CPE present. It is important to note that HAdVs in general have varying plaque size within one species. Taking together these and the data collected on the accumulation of plaques, we can confirm that the novel proteins E3-20.1K, E3-20.5K, and E3-9K do not appear to play a role in the development of plaques during the infection of A549 cells.



**Figure 10: Plaque size is not affected by the subspecies B1 E3 proteins 20.1K, 20.5K, and 9K.** A549 cells were infected with HAdV-3-FRT, HAdV-3-Triple KO, HAdV-3-Double KO, Rec 700, pm734.1 and images of plaques were taken at day 7-days post infection (A). A549 cells infected with HAdV-3-WT, HAdV-3-Triple KO, HAdV-3-Double KO, HAdV-3p, Rec 700, or pm734.1 in a 6 well plate were fixed and stained to visualize plaques (B). Rec700 produced plaques that were larger than those seen in cells infected with pm734.1. Plaques observed in cells infected with HAdV-3-FRT-TKO or HAdV-3-FRT-DKO did not show any significant difference compared to those infected with HAdV-3-WT.

### Functional motifs located within E3-20.1K, E3-20.5K, and E3-9K

Mutant viruses lacking the ability to produce the E3-20.1K, E3-20.5K, and E3-9K proteins showed no apparent phenotypic difference in a one-step growth curve, dissemination throughout a cell monolayer, or plaque size and accumulation when



compared to the wild type virus. Therefore, in order to obtain clues on the function of these E3 proteins, structural and functional motifs were analyzed. Structural prediction software was used to analyze the amino acid sequence of each of the three proteins. A summary of predicted structural motifs can be found in **Figure 11**. The E3 region is the only transcription unit of the HAdV genome to contain integral membrane proteins. A hydrophobic transmembrane domain was identified near the C-terminal end of each of the three proteins. The short C-terminal domain was also predicted to be located on the cytosolic side of a membrane. E3-20.1K and E3-20.5K also contain a short hydrophobic domain located on the N-terminus. This region was identified as a signal sequence domain that is predicted to be cleaved off during post-translational modification. A di-leucine sorting motif was located within the short cytosolic domain of both E3-20.1K and E3-20.5K. In the analogous region of E3-9K, a tyrosine-sorting motif was identified. Tyrosine and di-leucine sorting motifs play important roles in the rapid internalization of receptors from the plasma membrane, and targeting them for degradation through the endosomal pathway (as reviewed by Bonifacino and Traub, 2003; Pandey, 2008). A di-leucine sorting motif located in the cytosolic domain of RID $\alpha$  has been shown to be critical for the internalization of FasL and EGF receptors (Zanardi et al, 2003). The cytosolic domain of RID $\beta$  also contains a tyrosine sorting motif that is required for the internalization of Fas and TRAIL receptors (Lichtenstein et al., 2002). E3-20.1K and E3-20.5K also contain several cysteines in their large N-terminal domains. These cysteines could potentially be used to form immuno-globulin like doaming, as found in E3-49K, or possibly homodimers or heterodimers. Several serine and tyrosine residues are also located in the N-terminal domains in each of the E3

proteins. These amino acids could be phosphorylated and affect the function of these proteins. Interestingly, E3-20.1K also contains a Src homology 3 ligand motif. This indicates that E3-20.1K could interact with cellular factors and modulate signal trafficking. It is important to investigate the importance of these signal sorting motifs of E3-20.1K, E3-20.5K, and E3-9K in order to elucidate the functional roles of these proteins.

**Figure 11.**

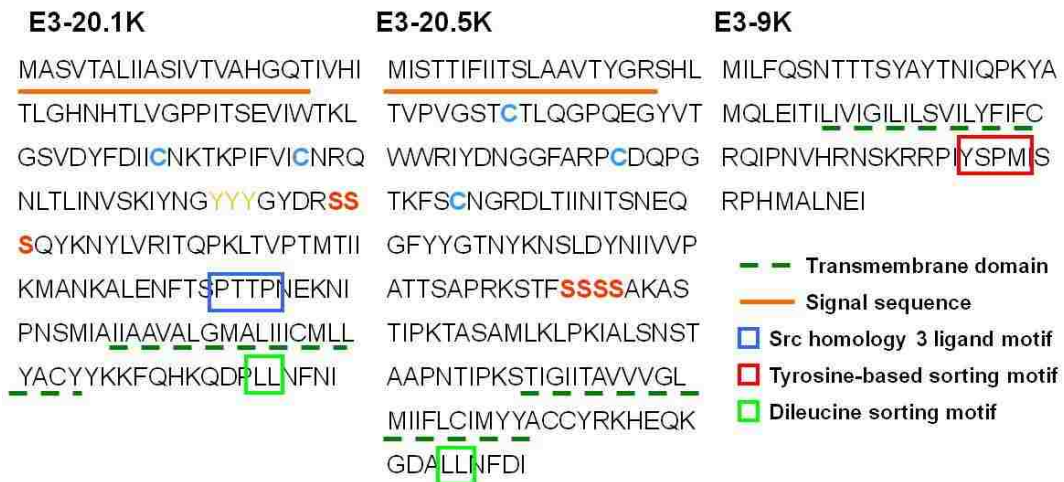
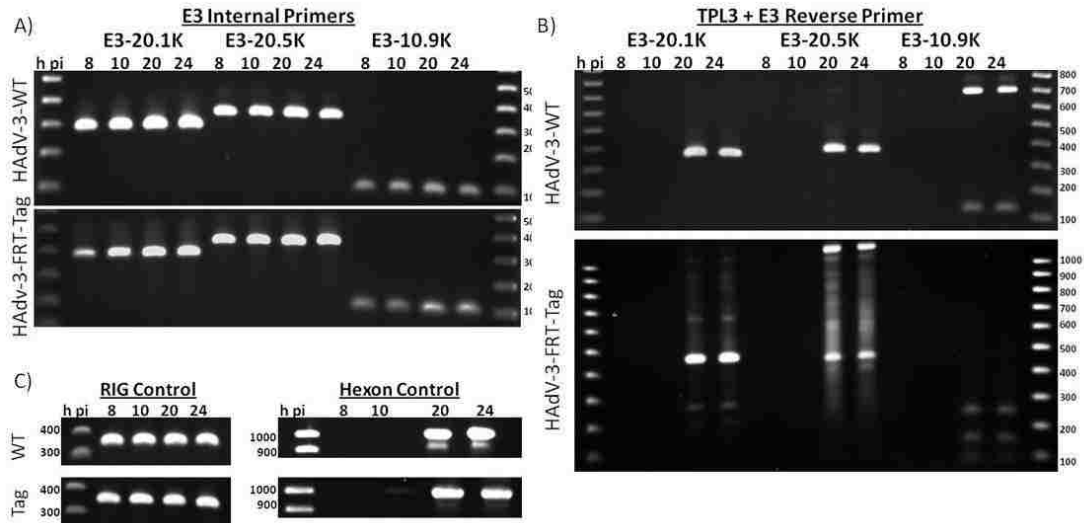

**Figure 11: Structural prediction of important domains of E3-20.1K, E3-20.5K, and E3-9K.** Structural prediction software was used to identify structural motifs of the novel B1 E3 proteins. A hydrophobic, transmembrane domain was located in the C-terminal domain of each of the three proteins. E3-20.1K and E3-20.5K both contain a hydrophobic, signaling motif on the N-terminal domain. Each of the three proteins contain a di-leucine (E3-20.1K and E3-20.5K) or a tyrosine (E3-9K) signal-sorting motif. E3-20.1K also contains a Src homology 3 ligand motif. Serines and tyrosines, that have the potential to be phosphorylated, and cysteines that could contribute to the structure of each protein, have also been marked.

### **E3-20.1K, E3-20.5K, and E3-9K are expressed at early and late time points post infection**

ADP is produced primarily after viral DNA replication. Prior to viral DNA replication, ADP is expressed at low levels from the E3 promoter, however, during late times post infection, ADP is expressed at much higher levels from the major late promoter (MLP) (Tollefson et al., 1996a). In order to gain an understanding of when the novel B1 E3 proteins might be active, the temporal expression of their RNA transcripts was examined. A549 cells were infected with HAdV-3-WT or HAdV-3-FRT-Tag at a MOI of 5 PFUs/cell. RNA was extracted at early time points, prior to viral DNA replication (8 and 10 h pi) and late time points after viral DNA replication had begun (20 and 24 h pi). After DNase treatment, the extracted RNA was used in a reverse transcriptase PCR (RT-PCR) reaction to produce cDNA. Two sets of primers were used to detect transcripts of the novel B1 E3 proteins. Primers located within each ORF were designed to detect the transcripts at any time post infection. To detect transcripts transcribed from the MLP, a forward was designed within the Tri-partite Leader sequence 3 (TPL3). This sequence is transcribed from the MLP and is spliced onto the 5' end of late transcripts. The accompanying reverse is located within the 3' end of each specific ORF under investigation. Transcripts of the major structural protein Hexon reverse-transcribed in this manner were used as a control for expression at late time points post infection. The PCR products were then run on an agarose gel. Using the primer set located entirely within each ORF, it is apparent that transcripts of E3-20.1K, E3-20.5K, and E3-9K exist at both early and late time points post infection. There is a switch, however, to expression of these transcripts at late times (20 and 24

hours) post infection from the MLP (**Figure 12**). A larger transcript was also detectable at late times post infection with HAdV-3-WT in the E3-9K lanes. This transcript has previously been shown to be a fusion of TPL3, E3-20.5K, and E3-9K (Frietze et al., 2010). However, this transcript was not found in the E3-9K-FLAG lanes of HAdV-FRT-Tag . The tagged mutant virus expresses a large fusion transcript of TPL3, E3-20.1K-MYC, and E3-20.5K-V5 in the lanes depicting late transcripts for E3-20.5K-V5 (sequencing data not shown). In the lanes depicting late transcripts of E3-9K-FLAG, small degradation products are seen below the full size E3-9K transcript. These products have been seen previously in HAdV-3-WT infected cells (Frietze et al., 2010). The differences in the larger, immature transcripts in the lanes of E3-20.5K and E3-9K indicate that the splicing of late transcripts is altered in the tagged mutant virus. It is not clear if the fused C-terminal tags or the FRT scar site is responsible for these differences. However, the full sized mature transcripts are seen for all three proteins in the tagged virus, indicating that all of the tagged E3 proteins are being produced by the virus. It is not apparent from this experiment whether the quantity of transcripts produced at early time points is significantly different to the quantity produced at late time points post infection.

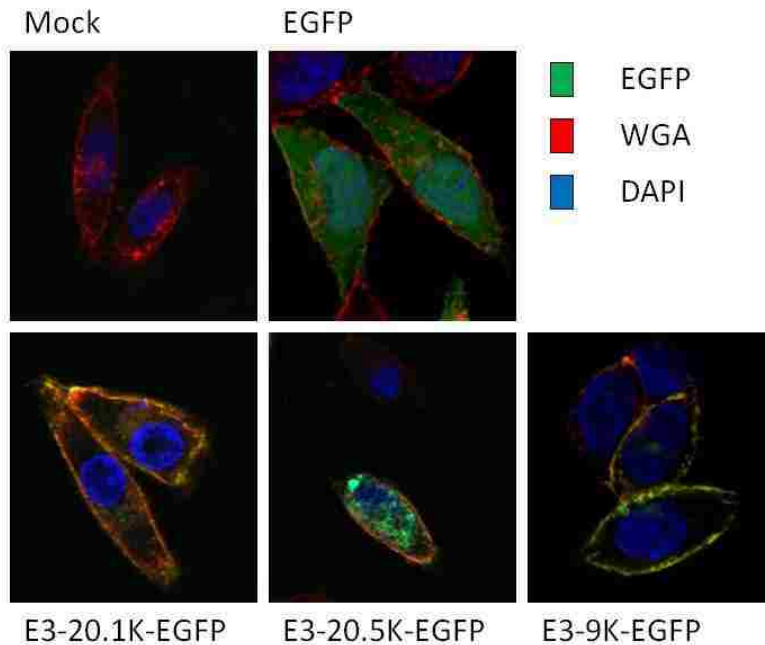

**Figure 12: Transcripts of E3-20.1K, E3-2.5K, and E3-9K are expressed at all time points post infection. During late time points, there is a switch to transcription from the MLP.** RNA was extracted from A549 cells infected with HAAdV-3-WT or HAAdV-3-FRT-Tag at a MOI of 5 PFUs/cell. (A) Transcripts of the novel B1 E3 proteins are expressed at all time points post infection using primers internal to each ORF. (B) The E3 proteins under investigation are expressed at late time post infection (20 and 24 hours) from the MLP as demonstrated by using a primer located in the TPL3 sequence as well as a primer located in the 3' end of each E3 protein. (C) RIG was used as a positive control for the reverse transcriptase reaction. Hexon was used as a control for late time points post infection.

**C-Terminal EGFP fusions of E3-20.1K, E3-20.5K, and E3-9K localize to the plasma membrane and intracellular vesicle-like structures when expressed in HeLa TRex cells**

The examination of the sub-cellular localization of the novel HAAdV-B1 E3 proteins could provide important clues to their function. ADP localizes to the nuclear membrane during late time points post infection (Tollefson et al., 1966). The RID $\alpha$ /RID $\beta$  complex localizes to the plasma membrane and the endocytic pathway (Gooding et al., 1991, Hilgendorf et al., 2003, Shah et al., 2007). The E3-49K protein encoded by the E3 region of HAAdV-D, contains many similar structural motifs of E3-20.1K, E3-20.5K, and E3-9K, including a large N-terminal domain with a cleavable

signaling sequence, a transmembrane near the C-terminal end, and a short C-terminal domain containing both a tyrosine and di-leucine sorting motifs. E3-49K has been shown to co-localize with trans-Golgi network and early endosome (Windheim et al., 2002). Due to the lack of available antibodies for E3-20.1K, E3-20.5K, and E3-9K, C-terminal EGFP fusion proteins were generated and expressed in HeLa-TREx cells under tetracycline "on" regulation. Constructs with the EGFP fusions were transfected into HeLa-TREx. Twenty-four hours post transfection, tetracycline (at a concentration of 1µg/mL) was added to the culture medium to induce expression of the EGFP fusions. Twenty four hours post induction of the EGFP, cells were stained with wheat germ agglutinin (WGA) as a marker for the plasma membrane, fixed with 4% paraformaldehyde , and mounted on glass slide with DAPI stain. Unlike ADP, E3-20.1K, E3-20.5K, and E3-9K were seen at the plasma membrane and intracellular vesicle like structures at 24 hours post induction (**Figure 13**). This further supports the fact that these proteins do not act in a manner similar to ADP.



**Figure 13: C-terminal EGFP fusion proteins localize to the plasma membrane and intracellular vesicle-like structures when expressed in HeLa TRex cells.** E3-20.1K, E3-20.5K, and E3-9K were individually expressed as C-terminal EGFP fusions in HeLa-TRex cells under tetracycline "on" regulation. Twenty-four hours post induction, the three novel sub-species B1 E3 proteins localized to the plasma membrane and intracellular, vesicle-like structures.

**E3-20.1K, E3-20.5K, and E3-9K localize to intracellular, vesicle-like structures during infection of A549 cells**

The C-terminally fused EGFP tag is larger (26.9kDa) than the proteins under investigation. Also, the predicted tyrosine and di-leucine sorting motifs are located in the C-terminal domain of each of the E3 proteins. Having EGFP fused to the C-terminal end could therefore potentially affect the folding and the ability of cellular proteins to recognize these sequences thus interfering with trafficking of the EGFP fusion protein within the infected cell. In order to investigate the sub-cellular localization in a more physiologically relevant system, the HAdV-3-FRT Tag virus (containing short, C-terminally fused epitope tags on E3-20.1K, E3-20.5K, and E3-9K) (**Figure 14A**) was

used to visualize the sub-cellular localization of each novel E3 protein. A549 cells were mock infected or infected with HAdV-3-FRT (a recombination control) or HAdV-3-FRT Tag. Twenty-four hours post infection, cells were fixed with 4% para-formaldehyde/acetone (at a 3:1 ratio). Cells were stained with appropriate anti-tag antibodies to visualize each individual protein. E3-20.1K, E3-20.5K, and E3-9K all localized to intracellular, vesicle-like structures (**Figure 14B**). The pattern of staining for the E3 proteins was remarkably similar. RID $\alpha$  and RID $\beta$ , expressed from the E3 region, have been shown to co-localize together at the plasma membrane and the endocytic pathway (Gooding et al., 1991, Hilgendorf et al., 2003, Shah et al., 2007). In order to determine if E3-20.1K, E3-20.5K, or E3-9K co-localize with each other, cells infected with HAdV-3-Tag were stained to visualize two of the B1 E3 proteins at a time. All possible combinations of E3-20.1K, E3-20.5K, or E3-9K were used. The novel sub-species B1 E3 proteins did not co-localize with each other during infection of A549 cells.



A)

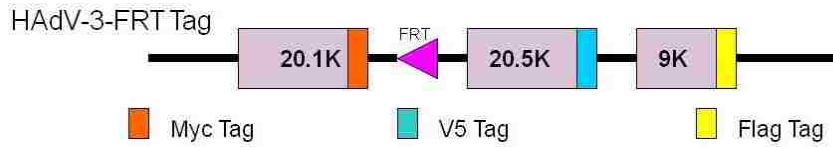

B)

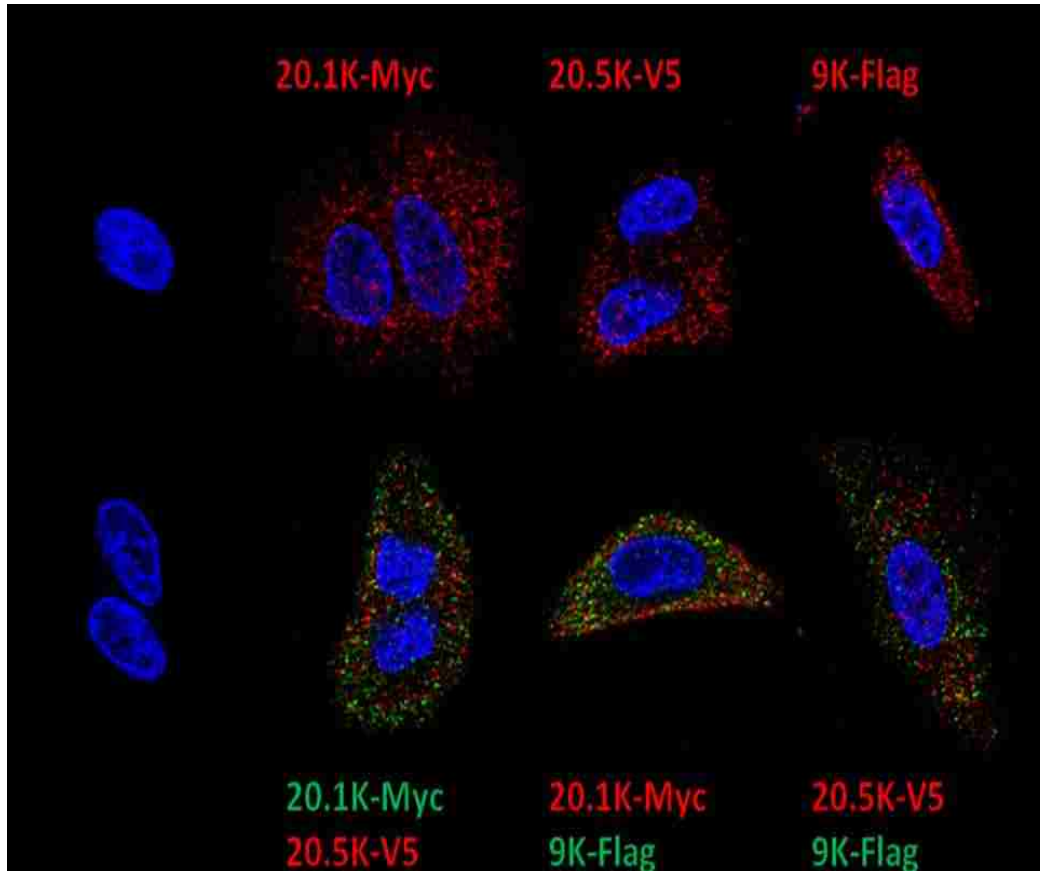

**Figure 14: E3-20.1K, E3-20.5K, and E3-9K localize to intracellular, vesicle like structures, but do not co-localize with each other.** A549 cells were infected HAdV-3-FRT, HAdV-FRT Tag, or mock-infected. At 24 hours post infection, cells were fixed and stained with appropriate antibodies to visualize the novel E3 proteins. (A) Map of the mutant E3 region of HAdV-3-Tag showing the location and type of small epitope tags fused to the C-terminal domains of E3-20.1K, E3-20.5K, and E3-9K. (B) E3-20.1K, E3-20.5K, and E3-9K all localize to intracellular, vesicle like structures. However, they do not co-localize to each other during infection of A549 cells.

### **E3-20.1K, E3-20.5K, and E3-9K do not localize with the early or late endosome or Golgi markers**

The presence of di-leucine sorting motif located in E3-20.1K and E3-20.5K and the tyrosine-sorting motif located in E3-9K is typically associated with targeting a protein at the plasma membrane for internalization through the endocytic pathway (Bonifacino and Traub, 2003; Pandey, 2008). In order to investigate whether E3-20.1K, E3-20.5K, and E3-9K interact with the endocytic pathway, A549 cells were infected with HAdV-3-FRT, HAdV-3-Tag, or mock-infected. At twenty-four hours post infection the cells were fixed with 4% para-formaldehyde/acetone (at a 3:1 ratio) and stained with antibodies against the small, C-terminal, epitope tags. The tagged E3 proteins were counterstained with antibodies against EEA1 (a marker of the early endosome), LAMP2 (a marker of the late endosome), and Giantin (a marker of the Golgi). Despite the fact that these proteins all contain a signal-sorting motif, and have been localized to vesicle like structures in an infected cell, E3-20.1K, E3-20.5K, and E3-9K did not co-localize with EEA1 or LAMP2. They also did not show any co-localization with the Golgi. However, E3-20.5K and E3-9K have been shown to be glycosylated and therefore must traffic through the Golgi (Hawkins et al., 1995, Frieze et al., 2010) (**Figure 15**). The exact nature and function of these vesicle-like structures remains to be determined.

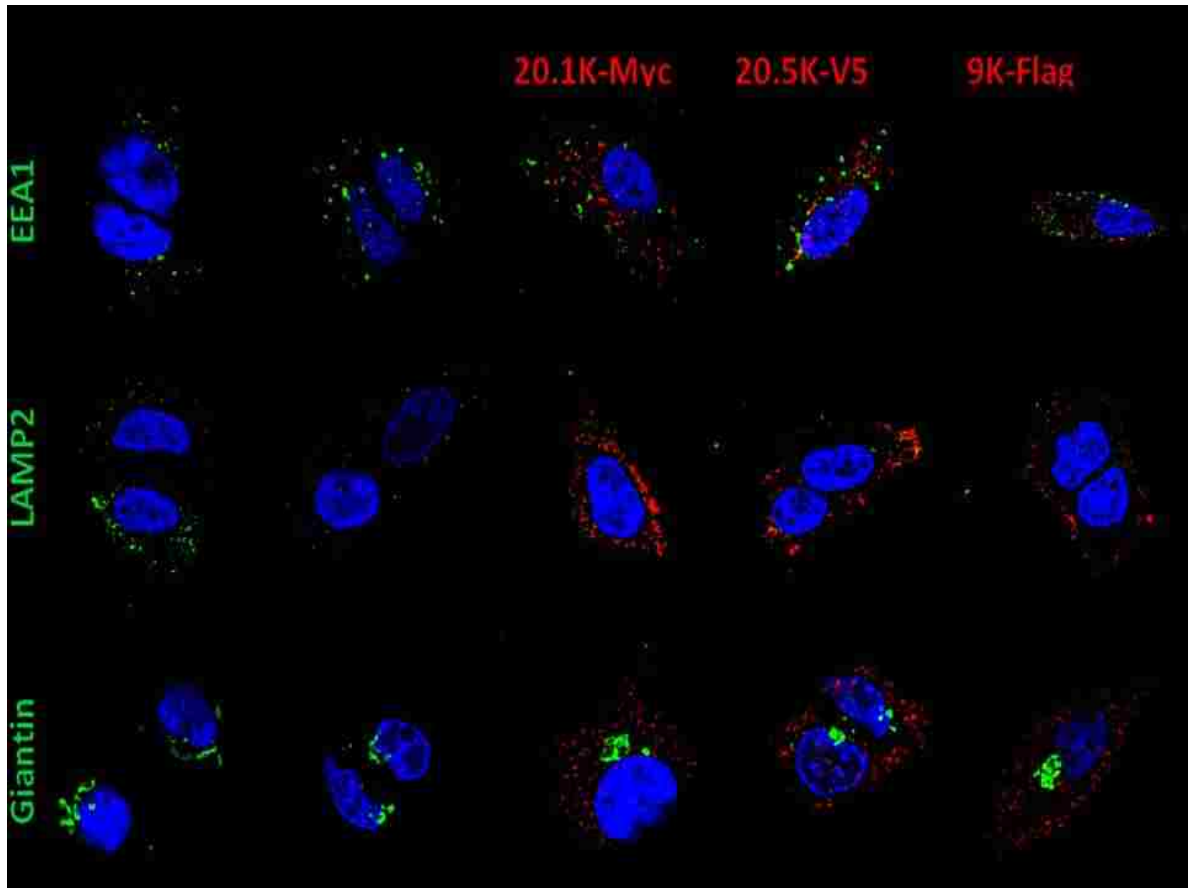

**Figure 15: E3-20.1K, E3-20.5K, and E3-9K do not localize to the early endosome, late endosome, or Golgi.** A549 cells were infected with HAdV-3-FRT, HAdV-3-Tag, or mock-infected. Twenty four hours post infection, cells were fixed and stained with antibodies against the small epitope tags fused to each novel E3 protein, EEA1 (a marker for the early endosome), LAMP2 (a marker of the late endosome, and Giantin (a marker for the Golgi).

## Chapter 5: Discussion

The Early Region 3 contains the highest level of genetic diversity among the HAdV. The known functions of the majority of the proteins encoded in the E3 region implicate them in the modulation the host response to infection (as reviewed by Burgert and Blusch, 2000; Lichtenstein et al., 2004). The adenovirus death protein (ADP) is one known exception. ADP is a transmembrane protein that localizes to the nuclear membrane and is required for the efficient release of HAdV-C virions from infected cells at late time points post infection (Tollefson et al., 1992; Tollefson et al., 1996; Doronin 2003). ADP is encoded between the highly conserved E3-gp19K and RID $\alpha$ . In this particular region of the genome, species A-F of HAdVs encodes a species-specific array of one to three predicted proteins (Burgert and Blusch, 2000). With the exception of ADP, no function has been assigned to any of these species-specific E3 proteins. In the analogous region of the genome, HAdV-B1s encode three novel transmembrane proteins designated E3-20.1K, E3-20.5K, and E3-10.9K by their predicted molecular weight. Due to their location in the E3 region, and the presence of a transmembrane domain, we hypothesized that one or more of these proteins act in a similar manner as ADP and are required for efficient release of progeny virions from infected cells.

In order to test our hypothesis, we generated a mutant HAdV-3 lacking the ability to produce E3-20.1K, E3-20.5K, and E3-9K. This mutant virus was used to examine growth phenotype characteristics in A549 cells compared to a wild type HAdV-3 as well as adequate recombination controls. There was no significant difference observed between the wild type and knockout mutants. These data allowed us to conclude that our original hypothesis was incorrect.

The amino acid sequence of the three HAdV- B1 E3 proteins was analyzed to gain additional insight into their potential functions. A transmembrane domain was found in E3-20.1K, E3-20.5K, and E3-9K polypeptides. Potential signal sorting motifs are present in their short, C-terminal cytosolic domains. Despite the presence of these sorting signals, we were not able to co-localize these E3 proteins to compartments of the endocytic pathway. However, the proteins under investigation were localized to intracellular, vesicle-like structures and potentially the plasma membrane.

Many of the proteins encoded by the E3 region are involved in modulating the host cell response to infection. E3-gp19K binds and retains MHC class I in the endoplasmic reticulum, the RID complex targets receptors at the plasma membrane and targets them for degradation, and E3-14.7K can protect the infected cell from pro-apoptotic factors (as reviewed by Lichtenstein et al., 2004). Although neither E3-20.1K, E3-20.5K nor E3-9K co-localized with markers of the endocytic pathway, as seen with HAdV-D E3-49K (Windheim and Burgert, 2002), it is still likely that these novel E3 proteins interact with and modify some cellular response to viral infection.

#### E3-20.1K, E3-20.5K, and E3-9K do not mediate the release of progeny virions

In order to elucidate the roles of the novel E3 proteins in the life cycle of HAdV-B1s, we generated a HAdV-3 knock out. Our initial hypothesis was that one or more of these proteins were involved in progeny virion egress. An ADP deletion mutant of HAdV-C showed a significant drop in both extracellular and intracellular infectious virus titers when compared to the corresponding wild type HAdV-C in A549 cells. In order to investigate whether E3-20.1K, E3-20.5K, or E3-9K function in a similar

manner, a one step growth curve was carried out with wild type virus and our HAdV-3 triple knock out mutant. No significant difference was observed between the wild type and the triple knockout mutant in non-polarized A549 cells. Although A549 cells are a standard cell line for the study of HAdV infection, they do not simulate polarized cells that these viruses would encounter in a more physiologically relevant system. Other viruses with a DNA genome such as polyomaviruses have shown differential release in a polarized cell system (Clayson et al., 1989). In order to simulate a more physiologically relevant system, this experiment was replicated in a polarized lung epithelial cell line, Calu3. Again, no difference was seen between the wild type and knock out mutant viruses. Since no significant drop in viral titer was observed in infected cells compared to wild type virus, we concluded that the E3-20.K, E3-20.5K, and E3-9K proteins do not mediate viral progeny release in a manner similar to ADP. Although these novel E3 proteins do not play an important role in the release of progeny virions, it is still possible that they are implicated in another important stage in the viral life cycle.

E3-20.1K, E3-20.5K, and E3-9K knockout mutants do not alter dissemination of the virus, plaque size or morphology, or plaque accumulation

In order to further characterize the roles of E3-20.1K, E3-20.5K, and E3-9K on the viral replication cycle, we used HAdV-3 knock out mutants for these genes to look at any differences in plaque accumulation and morphology as well as the virus' ability to disseminate throughout an infected cell monolayer when compared to the wild type virus. An ADP deletion mutant show a decreased ability to disseminate throughout an

infected cells monolayer (Doronin et al., 2003). To investigate whether E3-20.1K, E3-20.5K, and E3-9K knock out mutants had a similar phenotype, a dissemination assay was carried out on A549 cells. Cells were infected with ten-fold serial dilutions. In contrast to the ADP knock out mutant and the wild type HAdV-C viruses, no phenotypic difference was seen between the mutant and wild type species B1 viruses.

The ADP knock out mutant has also been shown to produce plaques of smaller size when compared to the parental virus. No other mutant HAdV-C has produced a similar effect when any other E3 proteins were individually knocked out. Plaques of the ADP knockout mutant also displayed reduced cytopathic effect (Tollefson et al., 1996). We infected A549 cells with either HAdV-3 wild type or knockout mutants and examined their plaque size and morphology during the course of infection. The plaques of both the wild type and mutants were similar in size. It should be noted, however, that the plaques of HAdV-3 are much smaller than the plaques of a HAdV-C. The plaques of both the mutant and the wild type viruses showed similar magnitude of CPE. Overall, the lack of E3-20.1K, E3-20.5K, and E3-9K did not produce any observable effect on the plaque size or morphology in infected cell monolayers.

In addition to exhibiting a reduced plaque size, the HAdV-C ADP knockout virus accumulated plaques at significantly reduced rate when compared to the wild type (Tollefson et al., 1996). Monolayers of A549 cells were infected with 50 total plaque-forming units of our wild type and knockout HAdV-3 mutants in order to determine if E3-20.1K, E3-20.5K, and E3-9K play a role in the formation and accumulation of plaques. The number of plaques that formed were counted over a course of two weeks. The HAdV-3-Double or Triple knockout viruses produced plaques at the same rate as

the wild type viruses. One step growth curves as well as the plaque morphology in cell monolayers infected with E3-20.1K, E3-20.5K, and E3-9K knock out mutants have revealed that these three novel E3 proteins do not mediate or contribute to the release of progeny virions in a manner similar to ADP.

#### Structural and functional motifs of E3-20.1K, E3-20.5K, and E3-9K

Since the original hypothesis of E3-20.1K, E3-20.5K, or E3-9K having a similar function as ADP was proven to be incorrect, we decided to investigate other possible functions for the novel E3 proteins. Structural prediction software can identify important structural domains and functional motifs by analyzing the amino acid sequence of the proteins under investigation. Using structural prediction software, we observed that E3-20.1K, E3-20.5K, and E3-9K encode a hydrophobic transmembrane domain towards their C-termini. E3-20.1K and E3-20.5K have very similar structures. In addition to the transmembrane domain, each of these proteins contains a hydrophobic signal sorting sequence on the N-terminal domain. The N-terminal domain for all three proteins is predicted to be luminal, while the short C-terminal domain is predicted to be cytosolic. The three E3 under investigation encode serine and tyrosine residues that could potentially be phosphorylated. E3-20.1K also contains a Src homology 3 ligand motif, suggesting that it could interact with cellular factors influencing trafficking. The fact that these proteins share such similar predicted structures, along with other members of the CR1 family of genes, supports the notion that these genes may have evolved through gene duplication events (Davison et al., 2003).



In addition to the hydrophobic domains, each protein is predicted to have a signal-sorting motif in their short cytosolic domain. E3-20.1K and E3-20.5K both encode a di-leucine sorting motif, while E3-9K encodes a tyrosine-sorting motif. These sorting motifs are used for the rapid internalization of receptors from the plasma membrane, and their targeting towards the endocytic pathway (reviewed by Pandely, 2008). These sorting motifs could be important clues towards the function of the E3 proteins under investigation. It is important to investigate whether E3-20.1K, E3-20.5K, and E3-9K localize to the plasma membrane, or interact with components of the endocytic pathway.

#### Subcellular localization of E3-20.1K, E3-20.5K, and E3-9K

The subcellular location of E3-20.1K, E3-20.5K, and E3-9K may provide important clues to the functional roles of the novel E3 proteins. Due to the lack of available antibodies against the E3 proteins under investigation and for an initial examination of subcellular localization, we decided to express E3-20.1K, E3-20.5K, and E3-9K individually as C-terminal EGFP fusion proteins in HeLa-TREx cells. E3-20.1K, E3-20.5K, and E3-9K were cloned into a mammalian expression vector with tetracycline "on" regulation. The EGFP fusion constructs were individually transfected into HeLa-TREx cells. Twenty-four hours post induction of expression, cells were fixed, counterstained with DAPI and wheat germ agglutinin (as a plasma membrane marker). The C-terminal fused EGFP fusion proteins were localized at the plasma membrane as well as intracellular vesicle like structures. Several other HAdV E3 proteins have similar subcellular localization. The RID $\alpha/\beta$  complex acts to internalize

several plasma membrane receptors, such as EGFR, FasL-R, and TRAIL-R from the plasma membrane and target them for degradation through the endocytic pathway (Gooding et al., 1991, Hilgendorf et al., 2003, Shah et al., 2007). However, the EGFP protein alone is very large (26kDa). It is also fused to the C-terminal domain where the tyrosine and di-leucine sorting motifs are located. The fused EGFP protein may be interfering with proper transportation or sorting of these novel E3 proteins. The EGFP fusions were also expressed independently of any other viral proteins. If one or more of these E3 proteins function together, we may not be seeing the correct co-localization or trafficking of these proteins.

In order to examine the expression of these proteins in a more physiologically relevant system, a mutant HAdV-3 was generated with small, unique epitope tags fused to the C-terminal domain of each E3-20.1K, E3-20.5K, and E3-9K. Our tagged mutant was used to infect A549 cells. Twenty-four hours post infection, cells were fixed and stained with antibodies against the individual epitope tags. E3-20.1K, E3-20.5K, and E3-9K localized to vesicle like structures within the cytoplasm of infected cells. These findings matched the intracellular structures that were seen with the EGFP fusion proteins. However, no strong localization was seen at the plasma membrane. This suggests that the large EGFP tag was in fact interfering with the correct localization or sorting of the novel E3 proteins. RID $\alpha$  and RID $\beta$  co-localize with each other and are dependent on each other to be completely functional (Gooding et al., 1991). Since E3-20.1K, E3-20.5K, and E3-9K each had very similar subcellular localization, we examined whether or not these E3 proteins co-localized with each other. When we stained cells infected with the HAdV-3 tagged mutant, and stained for two of the

proteins under investigation at a time, it was observed that none of the HAdV-B1 E3 proteins co-localized with each other.

In their short C-terminal domains, E3-20.1K, E3-20.5K, and E3-9K encode signal-sorting sequences that are known to interact with the early and late endosomes. Because the novel E3 EGFP fusion proteins were visualized as unidentified intracellular vesicle-like structures, it is important to investigate their interaction with the early and late endosomes. The early endosome and late endosome are important components of the endocytic pathway, and EEA1 (early endosome) and LAMP2 (late endosome) were chosen as markers of the endocytic pathway. A549 cells were infected with the tagged mutant, and stained individually for E3-20.1K, E3-20.5K, or E3-9K, and either EEA1 or LAMP2 twenty hours post infection. Despite the encoding di-leucine or tyrosine sorting motifs in the C-terminal domains of E3-20.1K, E3-20.5K, and E3-9K, they did not co-localize with EEA1 or LAMP2. The cellular and/or viral interactors of E3-20.1K, E3-20.5K, and E3-9K remain unknown. Clathrin-mediated endocytosis is another important pathway of internalization from the plasma membrane. Colocalization of E3-20.1K, E3-20.5K and E3-9K with components of clathrin coated pits should be investigated in future studies.

#### Future directions

In order to identify potential cellular interactors of E3-20.1K, E3-20.5K, and E3-9K, these proteins could be cloned for screening using a yeast two hybrid system (Y2H). Since the hydrophobic and unorganized transmembrane domains can generate false positives in the Y2H system, the E3 proteins as a whole cannot be cloned into the

Y2H bait vectors. In order to find potential interactors then, the larger N-terminal domain, excluding the hydrophobic signal sequences of E3-20.1K and E3-20.5K, and the shorter C-terminal domains could be cloned independently into the Y2H bait vector. The larger N-terminal domain would probably identify any cellular interacting proteins. The shorter C-terminal domains could potentially detect any cellular proteins within infected cells that act in the sorting and trafficking of the E3 proteins in an infected cell.

The results of the Y2H experiment could be confirmed using the HAdV-3-FRT-Tag mutant virus. E3-20.1K, E3-20.5K, and E3-9K could be individually pulled down through an immuno-precipitation targeting the small epitope tag fused to each E3 protein under investigation. The targets identified in the Y2H experiment could then be probed by western blot to determine if they do in fact interact with E3-20.1K, E3-20.5K, or E3-9K. This approach could also be used to determine any potential interactors not identified by Y2H. After the immuno-precipitation targeting the small epitope tags fused to E3-20.1K, E3-20.5K, and E3-9K, the proteins pulled down through IP could then be run on a 2D gel to identify any other interactors. Any interactors could be further identified by mass spectrometry.

If E3-20.1K, E3-20.5K, and E3-9K interact with an unknown receptor at the plasma membrane and internalize that receptor in a manner similar to the RID complex, isolating the plasma membranes from infected cells could prove to be useful. Membranes infected with wild type, knockout, and mock-infected cells could be probed for common receptors involved in regulating the host cell's response to infection such as EGFR, TRAIL, or FasL receptors. If E3-20.1K, E3-20.5K, and E3-9K interacts with a receptor at the plasma membrane and internalizes it, we would see reduced levels of the

receptor in membranes infected with the wild type HAdV-3. The cells infected with a knock out mutant, however, would still retain that receptor at the plasma membrane at normal levels.

E3-20.1K, E3-20.5K, and E3-9K could have profound effects on the ability of virus to modify the host's immune response to HAdV infection that could be impossible to observe in cell cultures. An infection in an animal model would be ideal to determine if the novel E3 proteins are crucial for the proper replication of HAdV-B1s or control of the host's immune response to infection. Unfortunately, because HAdVs are highly species-specific, there are no suitable animal models for HAdV infection. While early events of viral infection can be initiated, no animal model can produce progeny virions (Toth et al., 2005; Lam et al., 2011). Therefore the roles of these proteins in the late stages of viral infection cannot be investigated.

Species A-F of HAdVs have evolved species-specific arrays of open reading frames in the E3 region of their genome. While the function for HAdV-C E3-11.6K/ADP has been established, the functional role of the products of the rest of these ORFs remains unknown. Although E3-20.1K, E3-20.5K, and E3-9K do not function in a similar manner as ADP, their potential as role in modulators of the host cell's response to viral infection remains to be determined. The continued investigation into the functional roles of these proteins is important to further understand the various ways viruses interact with their host cells and subvert anti-viral responses.

## Appendix: Acronyms

|              |  |
|--------------|--|
| ADP          | Adenovirus death protein                       |
| AdV          | Adenovirus                                     |
| CAR          | Coxsackievirus and adenovirus receptor         |
| CPE          | Cytopathic effect                              |
| DBP          | DNA binding protein                            |
| E3           | Early Region 3                                 |
| EGFP         | Enhanced green fluorescent protein             |
| EGFR         | Epidermal growth factor receptor               |
| EMEM         | Eagle Minimum Essential Medium                 |
| FasLR        | Fas ligand receptor                            |
| gp           | Glycoprotein                                   |
| HAdV         | Human adenovirus                               |
| ICTV         | International Committee of Taxonomy of Viruses |
| MLP          | Major Late Promoter                            |
| MOI          | Multiplicity of infection                      |
| ORF          | Open reading frame                             |
| PFU          | Plaque forming units                           |
| RID          | Receptor internalization and degradation       |
| TNF $\alpha$ | Tumor necrosis factor                          |
| TPL          | Tripartite leader                              |
| VA RNA       | Virus associated RNA                           |

## References

- Akuusjarvi, G. (2008). Temporal regulation of adenovirus major late alternative RNA splicing. *Fronteir Bioscience*. 13, 5006-15.
- Aldabe, R., Barco, a, & Carrasco, L. (1996). Membrane permeabilization by poliovirus proteins 2B and 2BC. *The Journal of Biological Chemistry*, 271(38), 23134-7
- Andersson, M., McMichael, A., & Peterson, P. A. (1987). Reduced allorecognition of adenovirus-2 infected cells. *The Journal of Immunology*, 138(11), 3960-3966.
- Andersson, M., Pääbo, S., Nilsson, T., & Peterson, P. A. (1985). Impaired intracellular transport of class I MHC antigens as a possible means for adenoviruses to evade immune surveillance. *Cell*, 43, 215-222.
- Arnberg, N., Kidd, A. H., Edlund, K., Olfat, F., Arnberg, N., Kidd, A. H., Edlund, K., et al. (2000). Initial Interactions of Subgenus D Adenoviruses with A549 Cellular Receptors: Sialic Acid versus  $\alpha$  v Integrins Initial Interactions of Subgenus D Adenoviruses with A549 Cellular Receptors : Sialic Acid versus Integrins. *Journal of Virology*. 74(16), 7691-7693.
- Bagchi, S., Raychaudhuri P., and Nevins, J.R. (1990). Adenovirus EA1 proteins can dissociate heteromeric complexes involving the E2F transcription factor: a novel mechanism for the E1A trans-activation. *Cell* 62, 659-69.
- Becroft, D. M. (1971).Bronchiolitis obliterans, bronchiectasis, and other sequelae of adenovirus type 21 infection in young children, *J of Clinical Pathology* 24:72-82.
- Bennett, E. M., Bennink, J. R., Yewdell, J. W., & Brodsky, F. M. (1999). Cutting edge: adenovirus E19 has two mechanisms for affecting class I MHC expression. *Journal of Immunology*, 162, 5049-52.
- Benedict, C. a, Norris, P. S., Prigozy, T. I., Bodmer, J. L., Mahr, J. a, Garnett, C. T., Martinon, F., et al. (2001). Three adenovirus E3 proteins cooperate to evade apoptosis by tumor necrosis factor-related apoptosis-inducing ligand receptor-1 and -2. *The Journal of Biological Chemistry*, 276(5), 3270-8.
- Berget, S.M., Moore, C., and Sharp, P.A. (1977). Spliced segment at the 5' terminus of adenovirus 2 late mRNA. *Proceedings of the National Academy of Sciences*. 74, 3171-5.
- Berget, S.M., and Sharp, P.A. (1979). Structure of late adenovirus 2 heterogeneous nuclear RNA. *Journal of Molecular Biology*. 129, 547-65.

- Berk, A.J., F. Lee, T. Harrison, J. Williams, and P.A. Sharp. (1979). Pre-early adenovirus 5 gene product regulates synthesis of early viral messenger RNAs. *Cell* 17, 935-44.
- Bhat, B. M., & Wold, W. S. (1986). Genetic Analysis of mRNA Synthesis in Adenovirus Region E3 at Different Stages of Productive Infection by RNA-Processing Mutants. *Journal of Virology*, 60, 54-63.
- Bonifacino, J. S., & Traub, L. M. (2003). Signals for sorting of transmembrane proteins to endosomes and lysosomes. *Annual Review of Biochemistry*, 72, 395-447.
- Burgert, H. G., & Blusch, J. H. (2000). Immunomodulatory functions encoded by the E3 transcription unit of adenoviruses. *Virus Genes*, 21(1-2), 13-25.
- Burgert, H. G., & Kvist, S. (1987). The E3/19K protein of adenovirus type 2 binds to the domains of histocompatibility antigens required for CTL recognition. *The EMBO Journal*, 6(7), 2019-26.
- Cahill, D. P., da Costa, L. T., Carson-Walter, E. B., Kinzler, K. W., Vogelstein, B., & Lengauer, C. (1999). Characterization of MAD2B and other mitotic spindle checkpoint genes. *Genomics*, 58(2), 181-7.
- Campos, S. K., & Barry, M. a. (2004). Rapid construction of capsid-modified adenoviral vectors through bacteriophage lambda Red recombination. *Human Gene Therapy*, 15(11), 1125-30.
- Carlin, C. R., Tollefson, A. E., Brady, H. A., Hoffman, B. L., & Wold, W. S. (1989). Epidermal growth factor receptor is down-regulated by a 10,400 MW protein encoded by the E3 region of adenovirus. *Cell*, 57(1), 135-44.
- Carrasco, L., Otero, M. J., & Castrillo, J. L. (1989). Modification of membrane permeability by animal viruses. *Pharmacology Therapeutics*, 45(2), 171-212.
- Chen, P., Tian, J., Kovesdi, I., & Bruder, J. T. (1998). Interaction of the adenovirus 14.7-kDa protein with FLICE inhibits Fas ligand-induced apoptosis. *The Journal of Biological Chemistry*, 273(10), 5815-20.
- Chow, L.T., Gelinas, R.E., Broker, T.R., and Roberts, R.J. (1977) An amazing sequence arrangement at the 5' ends of adenovirus 2 messenger RNA. *Cell* 12, 1-8.
- Clayson, E. T., Brando, V. J., & Compans, R. W. (1989). Release of simian virus 40 virions from epithelial cells is polarized and occurs cell lysis. *Microbiology*, 63(5), 2278.



- Dales, S., & Chardonnet, Y. (1973). Early events in the interaction of adenoviruses with HeLa cells. IV. Association with microtubules and the nuclear pore complex during vectorial movement of the inoculum. *Virology*, 56(2), 465-83.
- Datsenko, K. A., & Wanner, B. L. (2000). One-step inactivation of chromosomal genes in *Escherichia coli* K-12 using PCR products. (A. D. Meijere & F. Diederich, Eds.) *Proceedings of the National Academy of Sciences*, 97(12), 6640-6645.
- Davison, A. J. (2003a). Genetic content and evolution of adenoviruses. *Journal of General Virology*, 84(11), 2895-08.
- Davison, a. J. (2003b). Homology between the human cytomegalovirus RL11 gene family and human adenovirus E3 genes. *Journal. of General Virology*, 84(3), 657-63.
- de Jong, J. C. D., Wermenbol, A. G., Marja, W., Slaterus, K. W., Wertheim-van, P., Doornum, G. J. J. V., Khoo, S. H., et al. (1999). Adenoviruses from Human Immunodeficiency Virus-Infected Individuals , Including Two Strains That Represent New Candidate Serotypes Ad50 and Ad51 of Species B1 and D , Respectively Adenoviruses from Human Immunodeficiency Virus-Infected Individuals , Including Two Strains That Represent New Candidate Serotypes Ad50 and Ad51 of Species B1 and D , Respectively. *Journal of Clinical Microbiology*. 37, 3940-45.
- de Jong, R. N. (2003). DNA binding properties of the adenovirus DNA replication priming protein pTP. *Nucleic Acids Research*, 31(12), 3274-86.
- Dehghan, S., Liu, E. B., Seto, J., Torres, S. F., Hudson, N. R., Kajon, A. E., Metzgar, D., et al. (2012). Five genome sequences of subspecies B1 human adenoviruses associated with acute respiratory disease. *Journal of Virology*, 86(1), 635-6.
- Doronin, K. (2003). Overexpression of the ADP (E3-11.6K) Protein Increases Cell Lysis and Spread of Adenovirus. *Virology*, 305(2), 378-87.
- Emanuelsson, O., Brunak, S., Von Heijne, G., & Nielsen, H. (2007). Locating proteins in the cell using TargetP, SignalP and related tools. *Nature Protocols*, 2(4), 953-71.
- Evans, P.S., Fraser, N., Ziff, E., Weber, J., Wilson, M., and Darnell, J.E. (1977). The initiation sites for RNA transcription in Ad2 DNA. *Cell* 12, 733-9.
- Friedman, J. M., & Horwitz, M. S. (2002). Inhibition of Tumor Necrosis Factor Alpha-Induced NF-  $\kappa$  B Activation by the Inhibition of Tumor Necrosis Factor Alpha-Induced NF-  $\kappa$  B Activation by the Adenovirus E3-10.4 / 14. 5K Complex. *Journal of Virology*. 76, 5515-21.
- Frietze, K. M., Campos, S. K., & Kajon, A. E. (2010). Open reading frame E3-10.9K of subspecies B1 human adenoviruses encodes a family of late orthologous proteins that

vary in their predicted structural features and subcellular localization. *Journal of Virology*, 84(21), 11310-22.

Gasteiger, E., Hoogland, C., Gattiker, A., Duvaud, S., Wilkins, M. R., Appel, R. D., & Bairoch, A. (2005). Protein Identification and Analysis Tools on the ExPASy Server. In J. M. Walker (Ed.), *The Proteomics Protocols Handbook*. 112, 571-607.

Ginsberg, H. S., Lundholm-Beauchamp, U., Horswood, R. L., Pernis, B., Wold, W. S., Chanock, R. M., & Prince, G. a. (1989). Role of early region 3 (E3) in pathogenesis of adenovirus disease. *Proceedings of the National Academy of Sciences*, 86(10), 3823-7.

Gonzalez, M. (2003). Viroporins. *FEBS Letters*, 552(1), 28-34.

Gooding, L. R., Elmore, L. W., Tollefson, A. E., Brady, H. A., & Wold, W. S. (1988). A 14,700 MW protein from the E3 region of adenovirus inhibits cytolysis by tumor necrosis factor. *Cell*, 53(3), 341-6.

Gooding, L. R., Ranheim, T. S., Tollefson, a E., Aquino, L., Duerksen-Hughes, P., Horton, T. M., & Wold, W. S. (1991). The 10,400- and 14,500-dalton proteins encoded by region E3 of adenovirus function together to protect many but not all mouse cell lines against lysis by tumor necrosis factor. *Journal of Virology*, 65(8), 4114-23.

Gooding, L. R., Sofola, I. O., Tollefson, a E., Duerksen-Hughes, P., & Wold, W. S. (1990). The adenovirus E3-14.7K protein is a general inhibitor of tumor necrosis factor-mediated cytolysis. *Journal of Immunology*, 145, 3080-86.

Greber, U. F., & Way, M. (2006). A superhighway to virus infection. *Cell*, 124(4), 741-754. Hawkins, L., & Wold, W. (1995). A 20,500-Dalton Protein is Coded by Region E3 of Subgroup B but not Subgroup C Human Adenoviruses. *Virology*, 208, 226-33.

Gupta, R., Jung, E., & Brunak, S. (2004). Prediction of N-glycosylation sites in human proteins. *International Journal of Cancer*, 46(2), 203-6.

Hawkins, L., & Wold, W. (1995). The E3-20.5 K membrane protein of subgroup B human adenoviruses contains O-linked and complex N-linked oligosaccharides. *Virology*. 210, 335-44.

Herbert, F. a, Wilkinson, D., Burchak, E., & Morgante, O. (1977). Adenovirus type 3 pneumonia causing lung damage in childhood. *Canadian Medical Association Journal*, 116(3), 274-6.

Hilgendorf, A., Lindberg, J., Ruzsics, Z., Höning, S., Elsing, A., Löfqvist, M., Engelmann, H., et al. (2003). Two distinct transport motifs in the adenovirus E3/10.4-14.5 proteins act in concert to down-modulate apoptosis receptors and the epidermal growth factor receptor. *The Journal of Biological Chemistry*, 278(51), 51872-84.

*Index of Viruses - Adenoviridae* (2006). In: ICTVdB - The Universal Virus Database, version 4. Büchen-Osmond, C (Ed), Columbia University, New York, USA.

[http://www.ncbi.nlm.nih.gov/ICTVdb/Ictv/fs\\_index.htm](http://www.ncbi.nlm.nih.gov/ICTVdb/Ictv/fs_index.htm)

James, L., Vernon, M. O., Jones, R. C., Stewart, A., Lu, X., Zollar, L. M., Chudoba, M., et al. (2007). Outbreak of human adenovirus type 3 infection in a pediatric long-term care facility--Illinois, 2005. *Clinical Infectious Diseases*, 45(4), 416-20.

Julenius, K., Mølgaard, A., Gupta, R., & Brunak, S. (2005). Prediction, conservation analysis, and structural characterization of mammalian mucin-type O-glycosylation sites. *Glycobiology*, 15(2), 153-64.

Kajon, A. E., Dickson, L. M., Fisher, B. T., & Hodinka, R. L. (2011). Fatal disseminated adenovirus infection in a young adult with systemic lupus erythematosus. *Journal of Clinical Virology*, 50(1), 80-3.

Kajon, A. E., Lu, X., Erdman, D. D., Louie, J., Schnurr, D., George, K. S., Koopmans, M. P., et al. (2010). Molecular epidemiology and brief history of emerging adenovirus 14-associated respiratory disease in the United States. *The Journal of Infectious Diseases*, 202(1), 93-103.

Kajon, A. E., & Wadell, G. (1992). Molecular epidemiology of adenoviruses associated with acute lower respiratory disease of children in Buenos Aires, Argentina (1984-1988). *Journal of Medical Virology*, 36(4), 292-7.

Kajon, a E., Xu, W., & Erdman, D. D. (2005). Sequence polymorphism in the E3 7.7K ORF of subspecies B1 human adenoviruses. *Virus Research*, 107(1), 11-9.

Kirchhausen, T. (1999). Adaptors for clathrin-mediated traffic. *Annual Review of Cell and Developmental Biology*, 15(1), 705-32.

Krajcsi, P., Dimitrov, T., Hermiston, T. W., Tollefson, A., Ranheim, S. B., Pol, V., Stephenson, A. H., et al. (1996). The adenovirus E3-14.7K protein and the independently inhibit tumor necrosis factor ( TNF ) -induced apoptosis , also independently inhibit TNF-induced release of arachidonic acid . The Adenovirus E3-14.7K Protein and the E3-10.4K / 14.5K Complex. *Journal of Virology*, 70, 4904-13.

Krajcsi, P., Tollefson, a E., Anderson, C. W., & Wold, W. S. (1992a). The adenovirus E3 14.5-kilodalton protein, which is required for down-regulation of the epidermal growth factor receptor and prevention of tumor necrosis factor cytolysis, is an integral membrane protein oriented with its C terminus in the cytoplasm. *Journal of Virology*, 66(3), 1665-73.

- Krajcsi, P., Tollefson, A. E., & Wold, W. S. (1992b). The E3-14.5K integral membrane protein of adenovirus that is required for down-regulation of the EGF receptor and for prevention of TNF cytotoxicity is O-glycosylated but not N-glycosylated. *Virology*, 188(2), 570-9.
- Lam, E., Ramke, M., Groos, S., Warnecke, G., & Heim, a. (2011). A differentiated porcine bronchial epithelial cell culture model for studying human adenovirus tropism and virulence. *Journal of Virological Methods*, 178(1-2), 117-23.
- Lechner, R. L., & Kelly, T. J. (1977). The structure of replicating adenovirus 2 DNA molecules. *Cell*, 12(4), 1007-20.
- Lee, J., Choi, E. H., & Lee, H. J. (2010). Comprehensive serotyping and epidemiology of human adenovirus isolated from the respiratory tract of Korean children over 17 consecutive years (1991-2007). *Journal of Medical Virology*, 82(4), 624-31.
- Li, Q. G., Hambraeus, J., & Wadell, G. (1991). Genetic relationship between thirteen genome types of adenovirus 11, 34, and 35 with different tropisms. *Intervirology*, 32(6), 338-50.
- Li, Y., Kang, J., & Horwitz, M. S. (1998). Protein with a Novel Tumor Necrosis Factor Alpha-Inducible Cellular Protein Containing Leucine Zipper Domains Interaction of an Adenovirus E3 14 . 7-Kilodalton Protein with a Novel Tumor Necrosis Factor Alpha-Inducible Cellular Protein Containing Leucine Zipper Domains. *Molecular and Cellular Biology*, 18, 1601-10.
- Li, E., Stupack, D., Bokoch, G. M., Glen, R., Li, E., Stupack, D., & Bokoch, G. M. (1998a). Adenovirus Endocytosis Requires Actin Cytoskeleton Reorganization Mediated by Rho Family GTPases Adenovirus Endocytosis Requires Actin Cytoskeleton Reorganization Mediated by Rho Family GTPases. *Journal of Virology*, 72, 8806-12.
- Li, E., Stupack, D., Klemke, R., Cheresch, D. A., & Nemerow, G. R. (1998b). Adenovirus endocytosis via alpha(v) integrins requires phosphoinositide-3-OH kinase. *Journal of Virology*, 72(3), 2055-61.
- Lichtenstein, D. L., Krajcsi, P., Esteban, D. J., Tollefson, A. E., & Wold, W. S. M. (2002). Adenovirus RID $\beta$  Subunit Contains a Tyrosine Residue That Is Critical for RID-Mediated Receptor Internalization and Inhibition of Fas- and TRAIL-Induced Apoptosis. *Journal of Virology*, 76(22), 11329-42.
- Lichtenstein, D. L., Toth, K., Doronin, K., Tollefson, A. E., & Wold, W. S. M. (2004). Functions and mechanisms of action of the adenovirus E3 proteins. *International reviews of Immunology*, 23(1-2), 75-111.

- Lin, B., Wang, Z., Vora, G. J., Thornton, J. A., Schnur, J. M., Thach, D. C., Blaney, K. M., et al. (2006). Broad-spectrum respiratory tract pathogen identification using resequencing DNA microarrays. *Genome Research*, *16*(4), 527-35.
- Liu, F., & Green, M. R. (1994). Promoter targeting by adenovirus E1a through interaction with different cellular DNA-binding domains. *Nature*, *368*, 520-25.
- Liu, H., Naismith, J. H., & Hay, R. T. (2003). Adenovirus DNA replication. *Current Topics in Microbiology and Immunology*, *111*, 131-64.
- Lonberg-holm, K., & Philipson, L. (1969). Early Events of Virus-Cell System Early Events of Virus-Cell Interaction in an Adenovirus System. *Microbiology*, *4*(4), 323-38.
- Logan, J., & Shenk, T. (1984). Adenovirus tripartite leader sequence enhances translation of mRNAs late after infection. *Proceedings of the National Academy of Sciences*, *81*(12), 3655-9.
- Madisch, I., Harste, G., Pommer, H., & Heim, A. (2005). Phylogenetic analysis of the main neutralization and hemagglutination determinants of all human adenovirus prototypes as a basis for molecular classification and taxonomy. *Journal of Virology*, *79*(24), 15265-76.
- Marttila, M., Persson, D., Gustafsson, D., Kathryn, M., Atkinson, J. P., Wadell, G., (2005). CD46 Is a Cellular Receptor for All Species B Adenoviruses except Types 3 and 7. *Journal of Virology*, *79*(22), 14429-36.
- Mathias, P., Wickham, T., Moore, M., & Nemerow, G. (1994). Integrins for infection . Multiple Adenovirus Serotypes Use cxv Integrins for Infection. *Journal of Virology*, *68*(10), 6811-4.
- Moise, A. R., Grant, J. R., Vitalis, T. Z., Jefferies, W. A., Moise, A. R., Grant, J. R., Vitalis, T. Z., et al. (2002). Adenovirus E3-6 . 7K Maintains Calcium Homeostasis and Prevents Apoptosis and Arachidonic Acid Release Adenovirus E3-6 . 7K Maintains Calcium Homeostasis and Prevents Apoptosis and Arachidonic Acid Release. *Journal of Virology*, *76*, 1578-87.
- Morin, J. E., Lubeck, M. D., Barton, J. E., Conley, A. J., Davis, A. R., & Hung, P. P. (1987). Recombinant adenovirus induces antibody response to hepatitis B virus surface antigen in hamsters. *Proceedings of the National Academy of Sciences*, *84*(13), 4626-30.
- Murakumo, Y., Roth, T., Ishii, H., Rasio, D., Numata, S., Croce, C. M., & Fishel, R. (2000). A human REV7 homolog that interacts with the polymerase zeta catalytic

subunit hREV3 and the spindle assembly checkpoint protein hMAD2. *The Journal of Biological Chemistry*, 275(6), 4391-7.

Nevins J.R., (1981). Mechanism of activation of early viral transcription by the adenovirus E1A gene product, *Cell*, 26, 213-20.

Nevins, J. R., Darnell, J. E., & Rockefeufer, T. (1978). Groups of Adenovirus Type 2 mRNA's Derived from a Large Primary Transcript : Probable Nuclear Origin and Possible Common 3 ' Ends. *Electrophoresis*, 25(3), 811-23.

Pandey, K. (2008). Functional roles of short sequence motifs in the endocytosis of membrane receptors. *Brain, Behavior, and Immunity*, 22(5), 5339-60.

Ohno, H., Stewart, J., Fournier, M. C., Bosshart, H., Rhee, I., Miyatake, S., Saito, T., Galusser, A., Kirchhausen, T., & Bonifacino, J., (1995). Interaction of tyrosine-based sorting signals with clathrin-associated proteins. *Science*, 269(5232), 1872-5.

Patterson, S., & Russell, W. C. (1983). Ultrastructural and immunofluorescence studies of early events in adenovirus-HeLa cell interactions. *The Journal of General Virology*, 64, 1091-9.

Phelps, W. C., Bagchi, S., Barnes, J. a, Raychaudhuri, P., Kraus, V., Münger, K., Howley, P. M., et al. (1991). Analysis of trans activation by human papillomavirus type 16 E7 and adenovirus 12S E1A suggests a common mechanism. *Journal of Virology*, 65(12), 6922-30.

Philipson, L., & Pettersson, R. F. (2004). The coxsackie-adenovirus receptor--a new receptor in the immunoglobulin family involved in cell adhesion. *Current Topics in Microbiology and Immunology*, 273, 87-111.

Poteete, A. R. (2001). What makes the bacteriophage lambda Red system useful for genetic engineering: molecular mechanism and biological function. *FEMS Microbiology Letters*, 201(1), 9-14.

Rahman, A., Malhotra, P., Dhar, R., Kewalramani, T., & Thimmapaya, B. (1995). Effect of single-base substitutions in the central domain of virus-associated RNA I on its function. *Journal of Virology*, 69(7), 4299-07.

Ren, J., Wen, L., Gao, X., Jin, C., Xue, Y., & Yao, X. (2008). CSS-Palm 2.0: an updated software for palmitoylation sites prediction. *Protein Engineering Design and Selection*, 21(11), 639-44.

Russell, W. C. (2009). Adenoviruses: update on structure and function. *The Journal of General Virology*, 90, 1-20.

- Ryan, M. a K., Gray, G. C., Smith, B., McKeehan, J. a, Hawksworth, A. W., & Malasig, M. D. (2002). Large epidemic of respiratory illness due to adenovirus types 7 and 3 in healthy young adults. *Clinical Infectious Diseases*, 34(5), 577-82.
- Scaria, A., Tollefson, A. E., Saha, S. K., & Wold, W. S. (1992). The E3-11.6K protein of adenovirus is an Asn-glycosylated integral membrane protein that localizes to the nuclear membrane. *Virology*, 191(2), 743-53.
- Selvaraju, S. B., Kovac, M., Dickson, L. M., Kajon, A. E., & Selvarangan, R. (2011). Molecular epidemiology and clinical presentation of human adenovirus infections in Kansas City children. *Journal of Clinical Virology*, 51(2), 126-31.
- Seto, J., Walsh, M. P., Mahadevan, P., Purkayastha, A., Clark, J. M., Tibbetts, C., & Seto, D. (2009). Genomic and bioinformatics analyses of HAdV-14p, reference strain of a re-emerging respiratory pathogen and analysis of B1/B2. *Virus Research*, 143(1), 94-105.
- Shah, A., Cianciola, N. L., Mills, J., Sonnichsen, F., & Carlin, C. R. (2007). Adenovirus RID $\alpha$  regulates endosome maturation by mimicking GT-Rab7. *The Journal of Cell Biology*, 179(5), 965-80.
- Shaw, A.R., and Ziff, E.B. (1980). Transcripts from the adenovirus-2 major late promoter yield a single early family of 3' coterminal mRNAs and five late families. *Cell*, 22, 905-16.
- Sirena, D., Ruzsics, Z., Schaffner, W., Greber, U. F., & Hemmi, S. (2005). The nucleotide sequence and a first generation gene transfer vector of species B human adenovirus serotype 3. *Virology*, 343(2), 283-98.
- Stewart, A R, Tollefson, A. E., Krajcsi, P., Yei, S. P., Wold, W. S., Stewart, A. R., Tollefson, A. N. N. E., et al. (1995). The Adenovirus E3 10 . 4K and 14 . 5K proteins , Which Function To Prevent Cytolysis by Tumor Necrosis Factor and To Down-Regulate the Epidermal Growth Factor Receptor , Are Localized in the Plasma Membrane. *Journal of Virology*, 69, 172-81.
- Svensson, C., & Akusjärvi, G. (1984). Adenovirus VA RNAI: a positive regulator of mRNA translation. *Molecular and Cellular Biology*, 4(4), 736-42.
- Tollefson, A. E., Hermiston, T. W., Lichtenstein, D. L., Colle, C. F., Tripp, R. A., Dimitrov, T., Toth, K., et al. (1998). Forced degradation of Fas inhibits apoptosis in adenovirus-infected cells. *Nature*, 392(6677), 726-30.
- Tollefson, A.E., Ryerse, J.A.N.S., Scaria, A., Hermiston, T.W., & Wold, W.S.M. (1996a). The E3-11 . 6-kDa Adenovirus Death Protein ( ADP ) Is Required for Efficient

Cell Death : Characterization of Cells Infected with *adp* Mutants. *Virology*, 162(220), 152-62.

Tollefson, A. E., Scaria, A., Hermiston, T. W., Ryerse, J. S., Wold, L. J. (1996b). The adenovirus death protein (E3-11.6K) is required at very late stages of infection for efficient cell lysis and release of adenovirus from infected cells. *Journal of Virology*, 70, 2296-06.

Tollefson, A.E., Scaria, A., Saha, S. K., & Wold, W. S. M. (1992). The 11,600-MW protein encoded by region E3 of adenovirus is expressed early but is greatly amplified at late stages of infection. *Journal of Virology*, 66(6), 3633-42.

Tollefson, A. E., Scaria, A., Ying, B., & Wold, W. S. M. (2003). Mutations within the ADP ( E3-11 . 6K ) Protein Alter Processing and Localization of ADP and the Kinetics of Cell Lysis of Adenovirus-Infected Cells. *Journal of Virology*, 77, 7764-78.

Tollefson, A. E., Toth, K., Doronin, K., Kuppuswamy, M., Lichtenstein, D. L., Hermiston, W., Smith, C. A., Wold, W. S. (2001). Inhibition of TRAIL-Induced Apoptosis and Forced Internalization of TRAIL Receptor 1 by Adenovirus Proteins. *Journal of Virology*. 75, 8875-87.

Toth, K. (2002). Construction and Characterization of E1-Minus Replication-Defective Adenovirus Vectors that Express E3 Proteins from the E1 Region. *Virology*, 301(1), 99-108.

Toth, K., Spencer, J. F., Tollefson, A. E., Kuppuswamy, M., Doronin, K., Lichtenstein, D. L., La Regina, M. C., et al. (2005). Cotton rat tumor model for the evaluation of oncolytic adenoviruses. *Human Gene Therapy*, 16(1), 139-46.

Trinh, H. V., Lesage, G., Chennampampil, V., Vollenweider, B., Burckhardt, C. J., Schauer, S., Havenga, M., et al. (2012). Avidity Binding of Human Adenovirus Serotypes 3 and 7 to the Membrane Cofactor CD46 Triggers Infection. *Journal of Virology*, 86(3), 1623-37.

Tusnády, G. E., & Simon, I. (1998). Principles governing amino acid composition of integral membrane proteins: application to topology prediction. *Journal of Molecular Biology*, 283(2), 489-506.

Warming, S., Costantino, N., Court, D. L., Jenkins, N. a, & Copeland, N. G. (2005). Simple and highly efficient BAC recombineering using galK selection. *Nucleic acids research*, 33(4), e36.



- Windheim, M., & Burgert, H.-gerhard. (2002). Characterization of E3 / 49K , a Novel , Highly Glycosylated E3 Protein of the Epidemic Keratoconjunctivitis-Causing Adenovirus Type 19a. *Journal of Virology*, 76(2), 755-66.
- Wilson-Rawls, J., Saha, S. K., Krajcsi, P., Tollefson, A. E., Gooding, L. R., & Wold, W. S. (1990). A 6700 MW membrane protein is encoded by region E3 of adenovirus type 2. *Virology*, 178(1), 204-12.
- Wilson-Rawls, J., & Wold, W. S. (1993). The E3-6.7K protein of adenovirus is an Asn-linked integral membrane glycoprotein localized in the endoplasmic reticulum. *Virology*, 195(1), 152-61.
- Wold, W. S., Doronin, K., Toth, K., Kuppaswamy, M., Lichtenstein, D. L., & Tollefson, A. E. (1999.). Immune responses to adenoviruses: and their implications for the clinic viral evasion mechanisms. *Current Opinion in Immunology*, 11, 380-86.
- Wold, W.S. and Horwitz, M. (2007). *Fields Virology*. 2, 2395-36.
- Wold W.S., Tollefson, A.E., and Hermiston, T.W. (1995). E2 transcription unit of adenovirus. *Current Topics in Microbiology and Immunology*, 199, 237-74
- Ying, B. and Wold, W.S. (2003). Adenovirus ADP protein (E3-11.6K), which is required for efficient cell lysis and virus release, interacts with human MAD2B. *Virology*, 313(1), 224-34.
- Zanardi, T. A., Yei, S., Lichtenstein, D. L., Tollefson, A. E., & Wold, W. S. M. (2003). Distinct Domains in the Adenovirus E3 RID $\alpha$  Protein Are Required for Degradation of Fas and the Epidermal Growth Factor Receptor. *Journal of Virology*, 77(21), 11685-96.
- Zheng, Y., Struck, D. K., Dankenbring, C. a, & Young, R. (2008). Evolutionary dominance of holin lysis systems derives from superior genetic malleability. *Microbiology*, 154, 1710-8.
- Zhu, Z., Zhang, Y., Xu, S., Yu, P., Tian, X., Wang, L., Liu, Z., et al. (2009). Outbreak of Acute Respiratory Disease in China Caused by B2 Species of Adenovirus Type 11. *Journal of Clinical Microbiology*, 47(3), 697-703.