

9-12-2014

# AN OPENDSS FRAMEWORK OF AN 100% PV PENETRATION MICROGRID

Siva Tharun Patibandla

Follow this and additional works at: [https://digitalrepository.unm.edu/ece\\_etds](https://digitalrepository.unm.edu/ece_etds)

---

## Recommended Citation

Patibandla, Siva Tharun. "AN OPENDSS FRAMEWORK OF AN 100% PV PENETRATION MICROGRID." (2014).  
[https://digitalrepository.unm.edu/ece\\_etds/202](https://digitalrepository.unm.edu/ece_etds/202)

This Thesis is brought to you for free and open access by the Engineering ETDs at UNM Digital Repository. It has been accepted for inclusion in Electrical and Computer Engineering ETDs by an authorized administrator of UNM Digital Repository. For more information, please contact [disc@unm.edu](mailto:disc@unm.edu).

SIVA THARUN PATIBANDLA  
*Candidate*

ELECTRICAL AND COMPUTER ENGINEERING DEPARTMENT  
*Department*

This thesis is approved, and it is acceptable in quality and form for publication:

*Approved by the Thesis Committee:*

Dr.Olga Lavrova , Chairperson  
\_\_\_\_\_

Dr.Andrea Mammoli  
\_\_\_\_\_

Dr.Edward Graham Jr  
\_\_\_\_\_

\_\_\_\_\_

\_\_\_\_\_

\_\_\_\_\_

\_\_\_\_\_

\_\_\_\_\_

\_\_\_\_\_

**AN OPENDSS FRAMEWORK OF AN 100% PV PENETRATION  
MICROGRID**

BY

**SIVA THARUN PATIBANDLA**

**BACHELOR OF TECHNOLOGY IN ELECTRICAL AND ELECTRONICS  
ENGINEERING, JNTU 2012**

*THESIS*

*Submitted in Partial Fulfillment  
of the Requirements for the Degree of*

**MASTER OF SCIENCE**

**ELECTRICAL ENGINEERING**

*The University of New Mexico  
Albuquerque, New Mexico*

July, 2014

### **ACKNOWLEDGEMENTS**

I would like to thank all the people that helped in progress and completion of this work. Specifically I would like to thank my advisor, Dr. Olga Lavrova, and my committee members, Dr. Edward Graham Jr and Dr. Andrea Mammoli, for their help and support. I would also like to thank the faculty of Engineering Department for their help and support throughout my years at UNM. I would like to express my gratitude to School of Engineering for funding my study at UNM.. Last and most importantly, I would like to thank my family for their love and support throughout my life.

**AN OPENDSS FRAMEWORK OF AN 100% PV PENETRATION  
MICROGRID**

BY

**SIVA THARUN PATIBANDLA**

BACHELOR OF TECHNOLOGY IN ELECTRICAL AND ELECTRONICS  
ENGINEERING, JNTU 2012

MASTER OF SCIENCE IN ELECTRICAL ENGINEERING, UNIVERSITY OF NEW MEXICO 2014

**ABSTRACT**

The purpose of this thesis is to understand how the microgrid with 100% PV penetration reacts to multiple scenarios. This is done by creating a framework or test model in OPENDSS and ETAP. The stability is tested by creating a test scenario that tests the safety equipment in place and also provides insight in to problems that might arise in the near future as Renewable energy penetration reaches new levels. The fast approaching problem of electric vehicles becoming increasingly popular is also investigated.

The methodology is to have a simulation model mimicking the actual SD village. Then the results from the simulation model are compared with that of the actual test values. And also the performance of the microgrid under multiple scenarios can be found out.

## TABLE OF CONTENTS

<b>LIST OF TABLES.....</b>	vii
<b>LIST OF FIGURES.....</b>	viii
<b>LIST OF ABBREVIATIONS.....</b>	x
<b>CHAPTER 1 INTRODUCTION.....</b>	1
<b>CHAPTER 2 THE CONTROL SYSTEM OF THE SHADE HOUSE.....</b>	3
2.1 Lighting.....	7
2.2 HVAC.....	7
2.3 Load Controller.....	7
2.4 Nexia system.....	8
2.5 TED.....	8
<b>CHAPTER 3 WEB INTERFACE FOR THE CONTROL SYSTEM OF THE SHADE HOUSE.....</b>	9
3.1 Web Interface.....	9
3.1.1 Schneider Load Controller.....	9
3.1.2 Powerone Inverters.....	10
3.1.3 The TED dataloggers.....	11
3.1.4 The Nexia system.....	12
<b>CHAPTER 4 THE PV SYSTEM OF THE SHADE HOUSE.....</b>	13
4.1 Load Calculation.....	13
4.2 Array Tilt Angle.....	14
4.3 Three-Line Diagram.....	15
<b>CHAPTER 5 DESIGN OF THE MICROGRID AT THE SD VILLAGE.....</b>	18

5.1 Utility Connection.....	18
5.2 PV production.....	19
5.3 Electrical Loads.....	20
5.4 Data Management systems.....	22
5.5 Voltage Regulators.....	23
5.6 Frequency Converters.....	26
5.7 Cables.....	27
5.8 Meter Configuration.....	28
<b>CHAPTER 6 CID TEST PLAN.....</b>	<b>30</b>
<b>CHAPTER 7 DATA COLLECTED FROM THE SD VILLAGE.....</b>	<b>32</b>
7.1 Power Flow.....	35
7.2 Power Quality.....	37
<b>CHAPTER 8 CONTROLLED ISLANDING DEMONSTRATION RESULTS.....</b>	<b>48</b>
<b>CHAPTER 9 ETAP SIMULATION MODEL OF THE SD VILLAGE.....</b>	<b>52</b>
<b>CHAPTER 10: OPENDSS SIMULATION OF THE SD VILLAGE.....</b>	<b>56</b>
<b>CHAPTER 11 CONCLUSION AND RESULTS.....</b>	<b>59</b>
<b>CHAPTER 12 FUTURE WORK.....</b>	<b>60</b>

**LIST OF TABLES**

Table 4.1 Load Calculation.....	14
Table 4.2 Power Vs Panel Tilt Angle.....	15
Table5.1: Participants' PV systems sizes.....	20
Table 6.1: CID Test – EV's test plan.....	31
Table 7.1 EV Chargers-Levels.....	33
Table 7.2 EV Model.....	33
Table 7.3: Typical team service voltages for 120V service.....	38



## LIST OF FIGURES

Figure 3.1: Schneider Wiser-Web Interface.....	9
Figure 3.2: Power one inverters-Web interface.....	10
Figure 3.3: TED500-Web Interface.....	11
Figure 3.4: Nexia-Web Interface.....	12
Figure 4.1: SD House PV 3-line diagram.....	16
Figure 5.1: Ariel Photo of the SD village.....	18
Figure 5.2: SD Village One line Diagram.....	21
Figure 5.3: Voltage Regulator Schematic.....	25
Figure 5.4: Voltage Regulator Operation.....	25
Figure 5.5: Cable configuration SD village.....	27
Figure 5.6: Meter Configuration.....	28
Figure 7.1: Energy Balance- All houses.....	34
Figure 7.2: SD village- Cars Locations.....	34
Figure 7.3: Real and Reactive Power of the US DOE SD 2013 Village. Legend: Red – PV Power production, Green – power exported by the Village, Black – power imported to the village.....	36
Figure 7.4: Histogram of real power ramp rates for all days of SD2013. The insert shows CDF of ramp rates.....	36
Figure 7.5: Phase A Voltage for collegiate houses during SD 2013 competition Days.....	39
Figure 7.6: Line current and power factor for one of the collegiate houses at the SD2013 Village.....	39

Figure 7.7: Line voltage THD for one of the collegiate houses at the SD2013 Village.....	40
Figure 7.8 Voltage Profile of House 117 during CID test.....	45
Figure 7.9 THD of House 117 during CID test.....	45
Figure 7.10 Power of House 117 during CID test.....	46
Figure 7.11 Current data of House 117 during CID test.....	46
Figure 8.1: Phase B Voltage for collegiate houses during SD 2013 competition days.....	49
Figure 8.2: House 117- Voltage Profile.....	50
Figure 8.3: House 117-Power Factor.....	50
Figure 8.4: House 117- Phase A current.....	51
Figure 8.5: House 117 – Total PV Power produced.....	51
Figure 9.1: ETAP Simulation Model-One Line Diagram.....	55
Figure 10.1: House 117-Voltage profile in OPENDSS.....	57
Figure 10.2: Voltage Profile of all Houses in OPENDSS.....	58

**LIST OF ABBREVIATIONS**

SD	Solar Decathlon
PV	Photovoltaic
DOE	Department of Energy
RF	Radio Frequency
HVAC	Heating Ventilation and Cooling
PLC	Programmable Logic Controller
HDIO	High Density Input and Output
SHADE	Solar Homes Adapting to Desert Equilibrium
TED	The Energy Detective
CT	Current Transformer
FCU	Fan Coil Unit
ERV	Energy Recovery Ventilation
OGCP	Orange County Great Park
MTS	Manual Transfer Switch
VR	Voltage Regulator
EV	Electric Vehicle
PCC	Point of Common Coupling
CDF	Cumulative Definition Function
PF	Power Factor
THD	Total Harmonic Distortion
CID	Controlled Islanding Demonstration
DG	Distributed Generation

## **Chapter 1**

### **Introduction**

The U.S. Department of Energy Solar Decathlon challenges collegiate teams to design, build, and operate solar photovoltaic (PV) houses that are cost-effective, energy-efficient, and attractive. The US DOE Solar Decathlon 2013 (SD) was held in the Orange County Great Park, Irvine, CA, October 3rd – 13th, 2013. The competition included ten contests and public exhibit of the houses. Of the ten contests, five were juried (Architecture, Market Appeal, Engineering, Communications, Affordability) and five were measured (Comfort Zone, Hot Water, Appliances, Home Entertainment, Energy Balance). Energy Balance contest enabled teams to earn 100 points if their houses produced as much as or more. A high-penetration microgrid[1] was designed, installed and operated by the SD organizers, to operate 19 PV-powered collegiate houses, as well as supporting infrastructure. As a temporary ground-laid installation, this microgrid presented additional technical challenges such as long low voltage cable runs up to 650ft to some houses. (Such arrangement is almost similar to European Low Voltage networks, but running at half the voltage and twice the current.) Low voltage microgrid with circuit length greater than 500ft to 600ft needs special consideration for voltage regulation. The voltage regulation basis for typical systems are max load and light load. The voltage regulation basis for a microgrid is max load and max generation. SD village presented both of these cases, which made microgrid design twice as hard. One or a combination of the following options was needed: massively paralleled conductors, voltage regulators, higher low voltage distribution, medium voltage distribution. The technical tradeoffs and costs needed to be optimized for a particular application. For SD we chose a combination of the first three.

Resulting microgrid had 100% customer PV penetration ratio (meaning every house had a PV system installed), 28% capacity penetration ratio (defined as PV generation fraction of total capacity of the interconnection), and 105% of load penetration ratio (defined as peak PV generation with respect the peak load). It is important to define all three of these definitions since each describes a unique aspect of power flow picture for SD microgrid.

Seventeen of the houses were supplied with 60Hz AC power, and two of the houses (designed by European Universities) were supplied with 50Hz AC power through frequency converters. In addition to the utility-supplied meters, a comprehensive monitoring system for the event was provided by Schneider Electric to log data for approximately 72 power attributes for each of the houses and for 5 subpanels at 1 min interval.

After the completion of the Solar Decathlon 2013 competition, a controlled island test was conducted during the final public exhibit day to evaluate the microgrid response in an islanded condition by creating additional load (stress) to the microgrid, as well as to determine the effectiveness of voltage regulators.

An OPENDSS and ETAP model of the SD village is created and then most of the test conditions are recreated.

## Chapter 2

### The Control System of the SHADE house

Team ASUNM is a collaborative effort between Arizona State University (ASU) and University of New Mexico (UNM). The two schools have worked together to create the desert home, “SHADE”. SHADE stands for “Solar Homes Adapting for Desert Equilibrium”. In the last decade, the population of Phoenix, Arizona has grown 30% to 4.5 million people, or 1.5 million households. Albuquerque, New Mexico experienced similar growth trends, expanding its population from 1 million to 1.1 million people over the last 10 years. Team ASUNM seeks to address the inefficiencies of urban sprawl and reduce energy consumption by utilizing the sun. Team ASUNM is building a campaign, highlighted by an inviting residence, to educate our communities on and stimulate a new direction for affordable, adaptable, solar-powered homes. These homes root themselves in the suburban landscape, fostering sustainable growth of both family and ecosystem

The engineered systems of SHADE consist of a PV electricity system, a radiant-DOAS (Dedicated Outdoor Air System), a water chiller/heat pump to remove/produce heat, a small ice-storage system, and an integrated, web-enabled control system that controls and monitors the HVAC equipment, lighting, electrical loads.

The PV array was designed to meet a variety of needs including annual electricity production, aesthetic integration with the house architecture, and long-term reliable operation. A radiant ceiling was chosen as the primary space conditioning system. A small chilled water fan coil unit treats ventilation air and peak load not met by the radiant ceiling. The thermal storage system is sized to provide the cooling required during peak electricity hours, which occur when ambient temperatures are highest. This eliminates the

need to run the compressor during this time, and it also allows the necessary amount of ice to be made while ambient temperatures are low. The control system provides control, scheduling, and monitoring of lighting, HVAC equipment, security equipment, and some household appliances.

#### Equipment and system choice

Efficient performance influenced the choice of equipment in many areas. For example, EnergyStar household appliances were chosen when available. Maintaining a healthy indoor environment was a priority, and this is accomplished through mechanical ventilation. An Energy Recovery Ventilation unit was chosen to reduce the ventilation cooling and heating load; the model installed was chosen in part because of its efficient operation, at 4 CFM/Watt. Light emitting diodes (LED's) were chosen for the lighting fixtures because of their combination of light output and low energy consumption.

This choice of radiant cooling and heating was based on the reduced energy cost compared to air-only systems, estimated at up to 30% savings, as well as on the superior thermal comfort provided by radiant systems compared to forced-air systems. The pumps and fan for this combined radiant-air system are equipped with electronically commutated motors (ECM's) which perform more efficiently than conventional fan/pump motors, which are typically of the permanent split capacitor (PSC) type. The efficiency of a PSC motor drops off significantly at partial loads, whereas an ECM motor is capable of operating at partial loads and maintaining high levels of efficiency. The control system allows the pumps and fan to scale their output based on which zones are calling for

cooling. If this same approach were used with a PSC motor, its efficiency would drop off at partial loads.

### Scheduling

The ability to schedule the operation of system components contributes to overall efficiency. In arid climates the range of daily temperatures tends to be high. Clear night skies typically allow much of the heat absorbed during the day to be radiated back out at night, lowering the ambient temperature. This daily rhythm is one of the renewable resources of the desert, and we've taken advantage of it in some key ways. The thermal storage system operates by freezing water to make ice overnight, during off-peak electricity hours, when ambient temperatures are low compared to daytime temperatures. This schedule results in savings in three main ways.

Energy is saved by running the condenser when ambient temperatures are lower, such as at night. Rejecting heat to a lower ambient temperature requires raising the refrigerant to a lower pressure, which takes less work and thus consumes less electricity. Furthermore, when a condenser must operate at a high temperature, a larger percentage of the heat rejected comes from internal waste heat, from the compressor itself. This means that to reject the same amount of heat, removed from the building, the condenser must reject more heat overall, which takes more work in form of condenser fan power.

Money is saved based on time-of-use rates offered by local utility companies. In Phoenix as well as in many municipalities, utility companies charge significantly higher rates for electricity consumed during peak hours. In the summer, peak hours occur during the early afternoon through the early evening, typically 1:00 - 6:00 pm. The utility that serves



Phoenix, the Salt River Project, charges three times as much per kWh used during peak rates, compared to off-peak rates.

The third source of savings can be realized by utility companies. They often need to rapidly cycle large equipment, such as gas turbines, to meet peak demand within strict guidelines set by regulatory agencies. In some cases the utility cannot keep up with demand and black- or brown-outs occur. In other cases, equipment damage and inefficiency result from subjecting generation equipment to rapid cycling, for which it is not designed. On the other hand, wind energy is often produced most abundantly at night, when demand is low. Without utility-scale storage facilities, this renewable energy can be difficult to integrate into a grid. Distributed storage in the form of residential (or commercial) thermal storage increases overnight demand, giving utility companies a useful destination for wind energy, and improving its penetration into the electricity grid and market. This can help utility companies meet goals for renewables in their generation portfolios, preventing fines and punitive action, and making the overall energy landscape more sustainable. Scheduling also benefits our domestic hot water system. Our heat pump water heater has a built-in scheduling feature and will be used to make hot water preferentially when the ambient temperatures are highest. The large capacity of the ATI80 permits us to make hot water when conditions are favorable, and store it for use at night and in the early morning.

## **2.1 Lighting**

The system that was used to control the lights was 'Lutron Radio RA'. It uses the clearconnect RF protocol for wireless communication between a central repeater to the various lights and controllers in the house.

The controllers are essentially keypads that can be programmed to carry out specific tasks.

The system also has a web interface which can control the aforementioned devices.

## **2.2 HVAC**

The HVAC system consists of a PLC and HDIO extension cards. The PLC used was a PCS-101. It was used to control all the HVAC equipment according to a pre programmed logic. The HDIO extension cards used were HDIO-24P. We used 3 HDIO cards for taking in all the inputs from the HVAC system.

## **2.3 Load controller**

The SHADE house had a load controller set up on a large load of the house i.e. the water heater. This load controller can be used to switch on and off the equipment and it can log the amount of power being consumed. Of course, this can be controlled wirelessly. As is the case with many systems in the house it has a web interface too, which can be used to carry out all the functions. The data can be accessed remotely. One more load controller was connected to the chiller. A single remote Zigbee to Ethernet converter was able to log and control both appliances.

## **2.4 Nexia system**

The Nexia system is essentially a controller which has an ethernet port. It also communicates with other nexia devices/sensors in the house by Z Wave, an open source protocol.

More importantly, the Nexia Bridge can communicate with the thermostats of the house.

In our case there are 4 thermostats, one for each zone.

The controller can also log video/data from the cameras, sensors etc.

## **2.5 TED**

The TED system was used to log data on individual branches of the house. The branches was chosen such that the data obtained would be informative for the home owner. The data obtained here can be accessed remotely as this product has a web interface too.

## Chapter 3

### Web Interface for the control system of SHADE house

#### 3.1 Web interface

The control system of the house gives the ability to log data and monitor equipment as well. But what makes it a truly smart house is the fact that it can communicate with the local utility and also cede control of the devices to it. The idea behind the shade house automation system was to bring the best products in the market and put them on a single platform. As there are no products out there than can do all of functions that were required. The capabilities of each of the systems are listed below.

##### 3.1.1 Schneider load controllers

The web interface can keep track of up to 6 load controllers. The webpage also registers the energy usage of the devices through the current transformers(CT) landed inside in the load controller. A photograph of the webpage can be shown in the Fig 3.1.

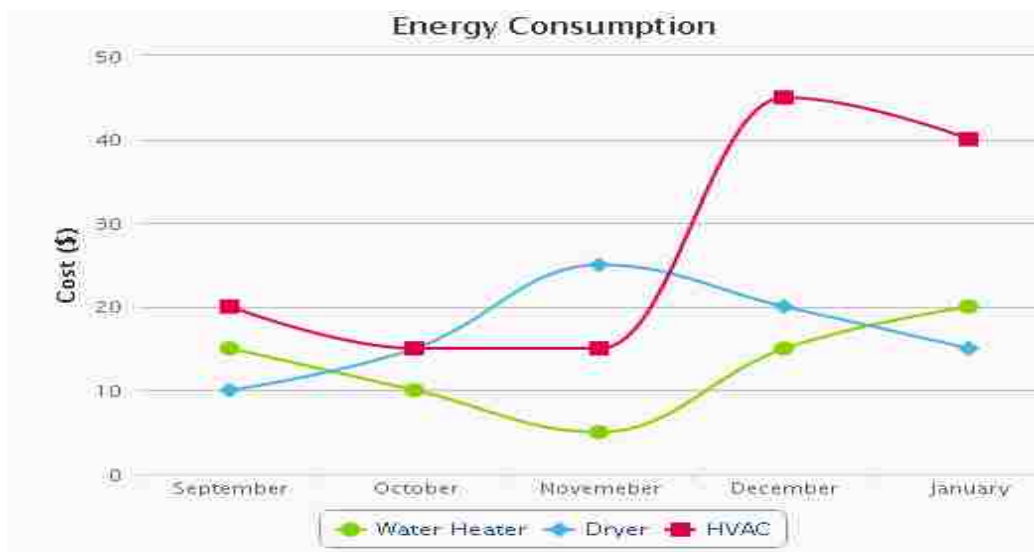

Figure 3.1

The web interface can also create a schedule for the particular device to run on a daily basis. For each individual load controller a Zigbee to Ethernet converter was provided and this in turn transferred the data online on to a web interface which is shown in the Fig 3.1. All the data is recorded for a certain period of time on the cloud and can be downloaded for further research.

### 3.1.2 Power One Inverters

The 9.54kw system installed on the SHADE house is configured such that it has 2 inverters. Both these inverters have a capability to send data to a server which can be accessed through the power one website. It gives us a 15 second sampling rate. This tool can be used to monitor the energy being produced and it calculates the money being saved accordingly, Depending upon the price of electricity from an individual utility.

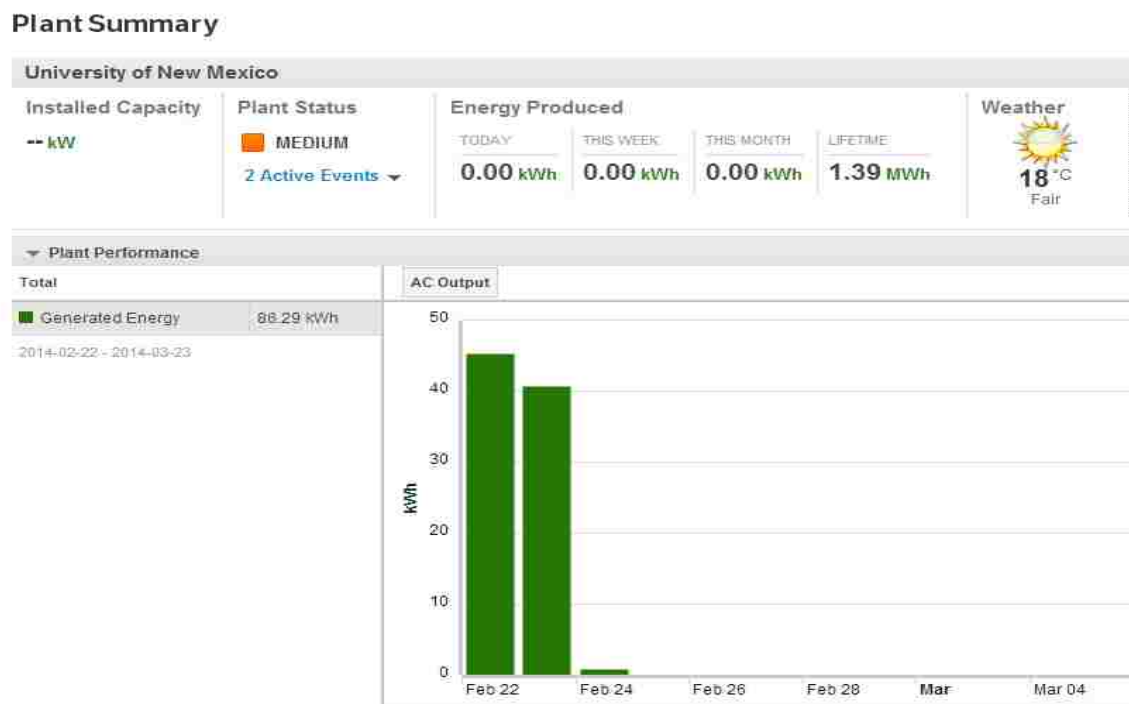

Figure 3.2: Power one inverters-Web interface

The inverters communicate with the modem through dataloggers. The dataloggers are called aurora dataloggers. These dataloggers have the capability to store information in them and also forward it to the web interface online which has the capability to then store all the information in the cloud. Data was collected for a period of three weeks when the SHADE house was showcased in Albuquerque.

### 3.1.3 The TED data loggers

The gateway for the TED current transformers is a TED gateway. The individual CTs relay the current data to the gateway in real time, which then sends the data to a server. This data was collected for 4 individual circuits in the house for a period of 2 weeks. This data can also be stored in the cloud for future reference. The web interface is shown in the Figure 3.3.



FIG: 3.3: TED500-Web Interface

### 3.1.4 The Nexia system:

The Nexia system was used to control the HVAC devices that could interact with the gateway. The devices that were under the control of this system were the FCU(Fan coil unit) , ERV(Energy recovery vent) and all 4 of the thermostats for each one of the zones of the house.

The nexia system uses a gateway system called the nexia bridge. The web interface gives the user the capability to remotely adjust temperature, and switch the devices on and off.

The interface can be seen in Fig 3.4.

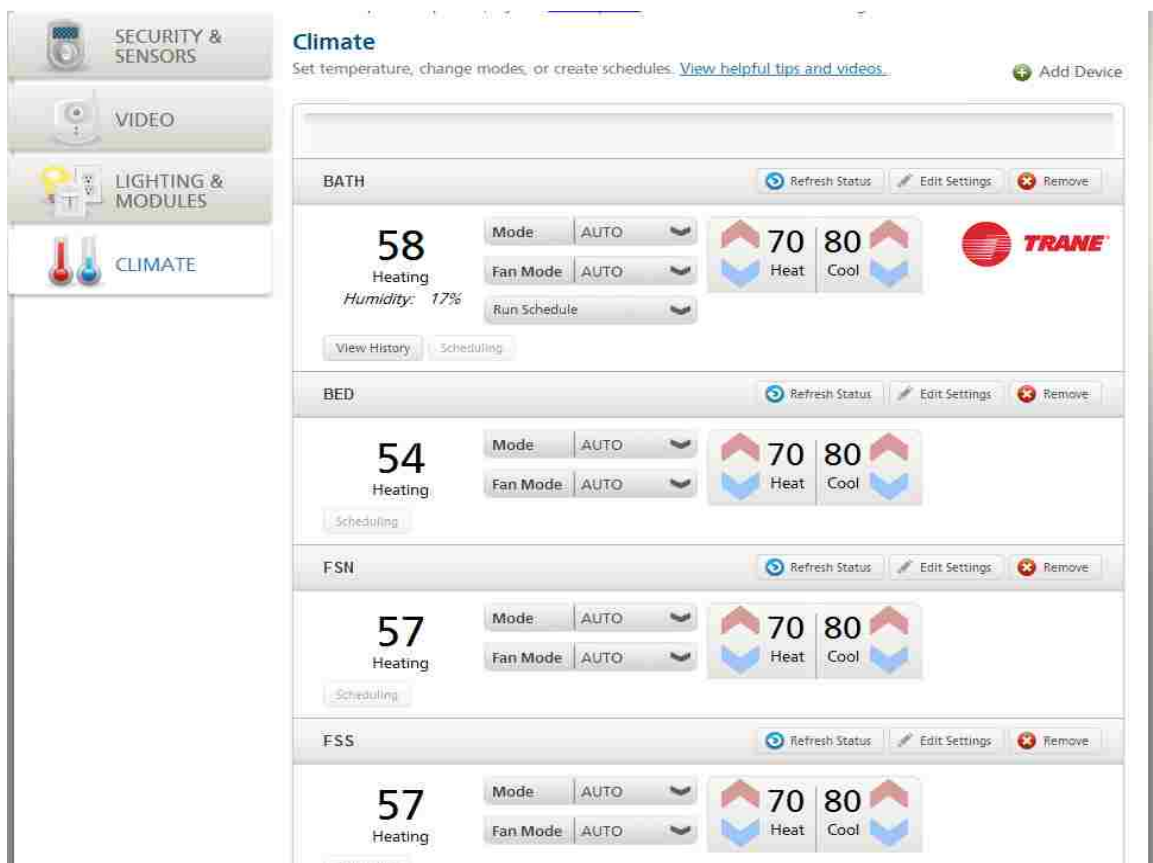

Figure 3.4: Nexia-Web Interface

## **Chapter 4**

### **The PV system of the SHADE house**

The house was designed for urban phoenix environment, so the PV system played a vital role in the design. It had to use the local environmental conditions to work more efficiently and also shade the house from the sun. The size of the system had to be carefully selected, as balancing the cost and the net energy produced was an important factor.

While most of the conventional PV systems are roof mounted, the SHADE house was designed to be innovative in its usage of the PV structure. The reason the SHADE house was named so, was because of the PV structure. The PV canopy was liberated from the house and stands as a standalone structure. This makes the design employable in even the retrofit case where a great deal of structural changes cannot be made. The canopy also provides shade to the house during the summer, because it is a south facing structure. Since the idea behind the SD is to educate people and inspire them to use more efficient technologies, this standalone PV structure motivates them to use it, as the capital cost is a lot lower.

#### **4.1 Load Calculation**

The next step in the design process was to calculate the load on the house over a period of year i.e. for all the seasons. The system had to be net zero for all environmental conditions. So the load analysis of the house was done, to get an understanding of what sized system had to be used. Of course considering the fact that we were in a competition



a buffer had to be taken in to account too, thereby overdesigning the system by at least a factor of 1.5. The load calculations can be seen in Table 4.1

LOAD CLASSIFICATIONS	CONNECTED LOAD	DEMAND FACTOR	ESTIMATED DEMAND
LIGHTING (CONTINUOUS LOAD)	1320 VA	100%	1320
RECEPTACLES (AS PER NEC 220.41)	5714.32	9000 AT 100% 5714.32 AT 95%	5000.01
RANGE	4500	85%	3825
DRYER	2760	111%	5000
WATER HEATER CHILLER AND PUMPS	7503	100%	7503
SMALL APPLIANCES	8000	100%	8000
LAUNDRY	1500	100%	1500
TOTAL CONNECTED LOAD:	29597.32 VA		
TOTAL ESTIMATED DEMAND:	27163 VA		
TOTAL CONNECTED CURRENT:	123A		
TOTAL ESTIMATED DEMAND CURRENT:	113.13A		

Table 4.1 Load Calculation

Upon further load calculations and analysis we arrived at a figure of 9.54KW.

## 4.2 Array Tilt angle

The next step in the process was to decide the angle at which the panels were to be inclined with respect to the structure. As the amount of power generated by these panels vary greatly depending on the degree of exposure to the sun and also the physical location, the most efficient angle had to be selected considering phoenix as the geographical location where the system will be in the place. The calculations and results can be seen in in Table 4.2.

A 34 tilt was selected as the inclination of the PV canopy.

Now the configuration had to be selected for producing that amount of power. The panels selected were 265W mono black panels from solar world. The number of PV panels for

arriving at that power was calculated as 42. The panels were carefully selected looking at the technical specifications as well as the aesthetic aspect.

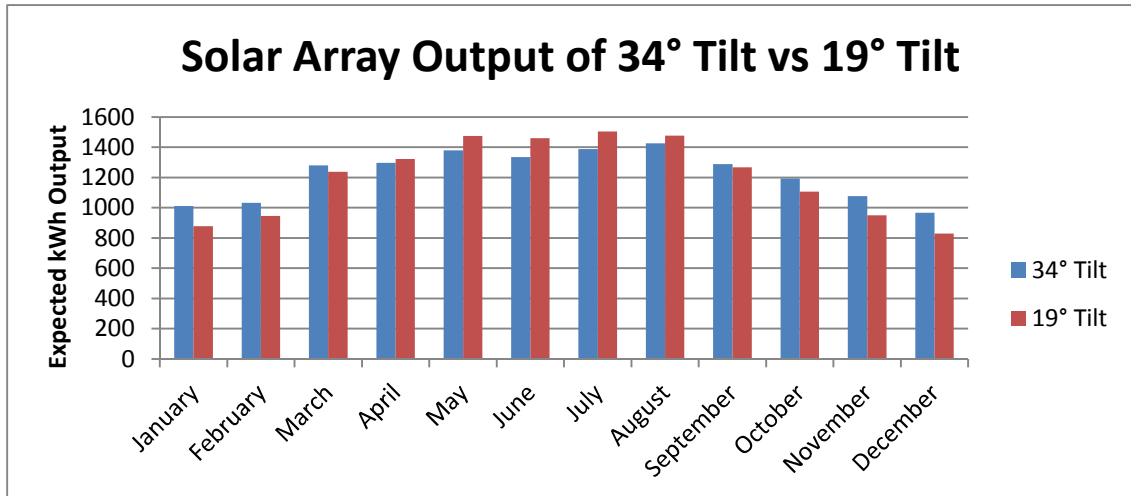

Table 4.2 Power Vs Panel Tilt Angle

### 4.3 Three Line Diagram

The design of the PV system can be illustrated in Fig 4.1. This system was permitted to be constructed in three states of Arizona, California and New Mexico.

As the three line diagram depicts, a panel configuration of 4 strings of 9 panels each is used. The Wire from the PV panel goes in to a junction box and the THWN-2 wires are used to run the positive negative and ground wire all the way across the roof and into the inverters. To reduce the amount of wire used and also to give the system one more point of disconnect. The inverter configuration was used to achieve the maximum amount of power from various string configurations of the PV panels.

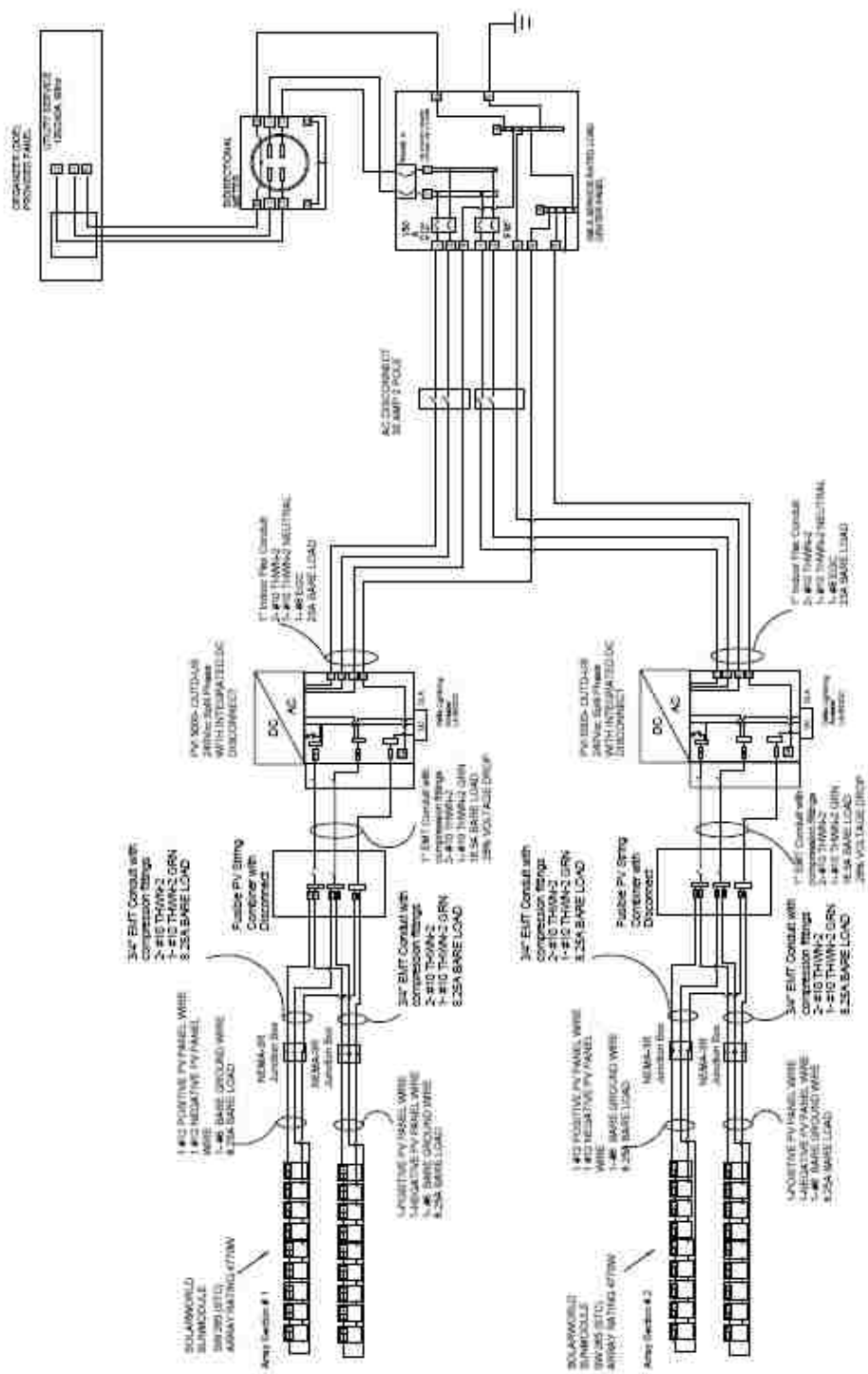

Figure 4.1 SD House PV 3-line diagram

The final design had 2 strings of 9 panels each connected to each inverter. The inverters output was connected to the main distribution panel of the house. This system was designed for a peak output of 9.54KW.

One of the contests that each team had to participate in was the Net zero energy production contest. The house had to put more energy on the grid than how much it was producing. The SHADE house won all available points in that contest, thus proving that the system was of the right size.

## Chapter 5

### Design of the microgrid at the SD village:

The one line diagram of the SD village represented in Figure 5.2 was designed with reliability of operation as the prime target.

#### 5.1 Utility Connection

The local electrical utility company Southern California Edison provided a 12kV connection to Orange County Great Park (OCGP), subsequently OCGP provided 277/480V 3-phase connection for the Solar Decathlon organizers. The organizers stepped down the voltage to 120/208V, 3 $\phi$  for village distribution, and further transformed the voltage into 120/240V, 1 $\phi$  for house interconnection. For backup power to the event, Power Plus, a subcontractor to the organizers, provided a 500 kVA, 480V diesel isochronous generator along with a 100kW load bank.

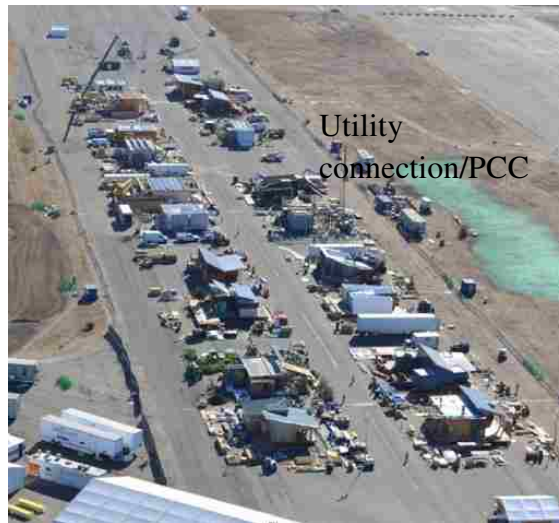

Figure 5.1: Ariel Photo of the SD village

The generator output was connected to a manual transfer switch (MTS) which then supplied both the north and south parts of the site (teams and organizer loads). The MTS

prevented connection of the generator to the utility (open transition). A momentary OFF position is provided at the transfer switch for this purpose. The generator and load bank were only used during the controlled island operation day

## 5.2 PV Production

The total installed capacity of PV systems in the Solar Decathlon 2013 village was 140 KW. PV system sizes varied between 4 and 10 kW<sub>dc</sub> as shown in Table 5.1. The tilt of the PV systems ranged from 0 degrees (flat) to 40 degrees. The size and orientation of the PV system was determined by each team, and was often based on the location and orientation of each house as well as other architectural factors.

Team/University	PV System Rating (kW)
Missouri S&T	10.5
AZ State/New Mexico	9.0
North Carolina	9.0
Team Alberta	8.6
West Virginia	8.5
Team Texas	8.1
Team Austria (1 <sup>st</sup> place)	8.0
Team Capitol DC	7.8
Santa Clara	7.1
Team Ontario	7.0
Stanford	7.0
Kentucky/Indiana	7.0
U of So Cal	6.8
Las Vegas (3 <sup>rd</sup> place)	6.7
Stevens	6.3
Middlebury College	6.0
Norwich	6.0

SCI-Arc/Caltech	5.3
Czech Republic (2 <sup>nd</sup> place)	5.0
<b>Total</b>	<b>140</b>

Table5.1: Participants' PV systems sizes.

It is important to notice that that all houses were facing exactly due south (as shown in Figure 5.1). This is different from a typical residential neighborhood where individual houses' orientation and architecture styles normally result in some "disorientation" of residential PV arrays.

Additionally, because of the compact layout of the SD 2013 village, there was no time delay between PV power generation onset of all houses, i.e. inverters would start producing power at exactly the same time. This again is different from a typical residential neighborhood where spatially distributed nature of PV installations leads to a smooth PV power turn on. Such situation describes an extreme case of 100% customer penetration ratio, coupled with 100% coincidence factor of PV generation. One of the goals of this investigation was to identify if this is an issue or not

### 5.3 Electrical Loads

Electrical loads of the village microgrid consisted of residential household loads of each of the collegiate houses, as well as additional loads of the event organizers' headquarters trailers. The loads on the three-phase system were unbalanced, resulting in different phase voltages at utilization points.

Many of the contests required consumption of energy for control of indoor temperature and relative humidity, as well as typical household appliance activities. For

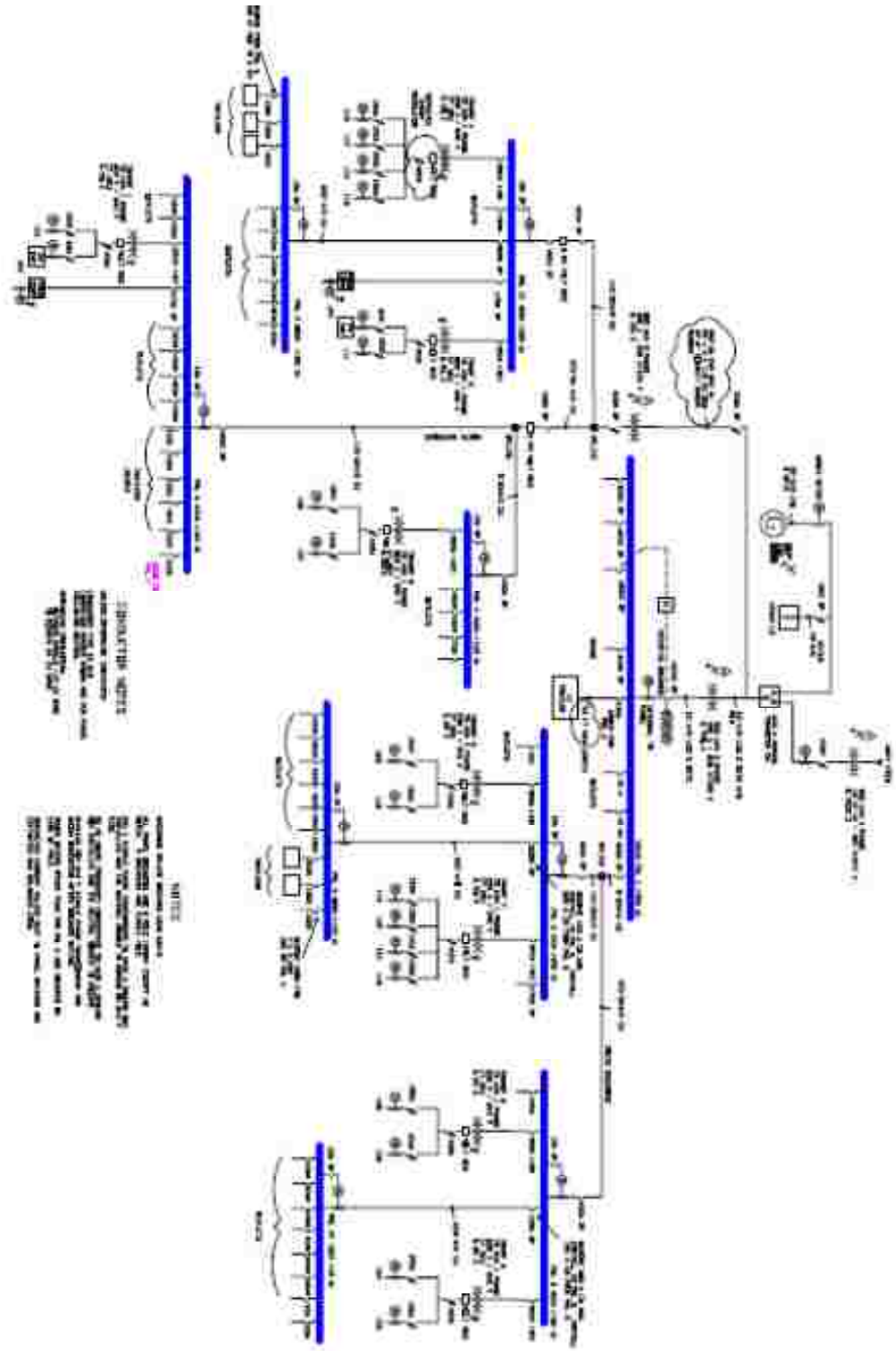

Figure 5.2: SD Village One line Diagram



these purposes, majority of loads in the houses were typical commercially-available energy efficient appliances and loads. However, time of use of these appliances was not typical due to the timing of the contests and needing to perform an energy-intensive task (such as washing and drying a load of laundry) at a time interval prescribed by the SD organizers – during day time. This point is important because such operation is counter-intuitive to performing energy-intensive tasks at times when, for example, electricity tariffs may be lowest, typically later at night. During this 2013 competition teams were not judged on the peak load or their other load characteristics. Incorporation of some version of load management, load curtailment or demand response strategies for teams may be an interesting possibility as one of the contests for future Solar Decathlon competitions.

#### **5.4 Data Management system**

In addition to designing the microgrid, Schneider Electric also provided a comprehensive monitoring system for the event. Two PM870 meters were used at each competition house. One meter measured PV production. The second meter measured net energy for 60 Hz houses and consumption for 50 Hz houses. These meters recorded values (described below) and sent them through the site's Ethernet network to the centralized StruxureWare™ Power Monitoring server on site. Values were then logged to an SQL database to be queried and analyzed at any time. StruxureWare™ Power Monitoring software is a complete, interoperable, and scalable supervisory interface dedicated to power monitoring that enables users to maximize operational efficiency, optimize power distribution system, and improve performance.

As mentioned earlier, 72 power attributes for each of the houses and for 5 subpanels were recorded at 1 min interval or better. Recorded power attributes included:

Apparent Energy,  
Reactive Energy Into the Load,  
Reactive Energy Out of the Load,  
Reactive Energy Absolute,  
Real Energy Into the Load,  
Real Energy Out of the Load,  
Real Energy Absolute,  
Apparent Power Total,  
Real Power Total, Reactive Power Total,  
Real Power A, Real Power B,  
Reactive Power A, Reactive Power B,  
Apparent Power A, Apparent Power B,  
Frequency,  
Line Voltages, Line Currents,  
Line Voltages THD, Line Currents THD,  
Power Factor Total, PF A, PF B,  
Displacement Power Factor Total,  
Displacement PF A, Displacement PF B,

## **5.5 Voltage Regulator**

The purpose of a voltage regulator is to maintain a constant output voltage regardless of the input voltage disturbances. They are used to monitor input voltages to

devices like computer processors which have an input voltage of about 5volts. They can also monitor voltages at the utility scale making sure that the voltage that the customer receives is still within ANSI requirements.

Linear regulator uses a active pass filter controlled by a high differential amplifier. It compares the output voltage to a reference voltage to adjust the output voltage to make sure it remains constant.

Switching regulators switch a series device on and off. The duty cycle regulates how much charge is transferred to the load. The system has a feedback loop comparing the output voltage to the reference voltage to check for disturbances. The reason switching regulators are more beneficial than linear regulators is because switching regulators can increase the output voltage to a greater value than the input voltage. And the losses tend to be lower because the switch is either fully conducting or completely turned off.

SCR voltage regulators are used to regulate AC power circuits by allowing current to pass through to the load whenever the voltage of the load drops below the reference voltage. Although they are cheap and effective, it does have commutation to stop current from flowing before the end of the half cycle. This limits the capacity of the voltage regulators in regulating sub cycle changes in load.

The other way of regulating voltage is to use a combination of the above mentioned voltage regulator schemes. An example is a switching regulators taking the input voltage and producing a noisy output voltage that is a little higher than the reference voltage. This can be connected next to a linear regulator which will the voltage level more accurate and also eliminate the noise from the signal.

Bidirectional electronic Voltage Regulators (VRs) from MicroPlanet were selected to provide four-quadrant voltage regulation of 60Hz power. The main reason for the voltage regulators is the anticipated voltage drop during either power import (load greater than PV power) or export (PV power greater than load) conditions. If unregulated, the impedance of the network would have resulted in unacceptably wide variations in voltage

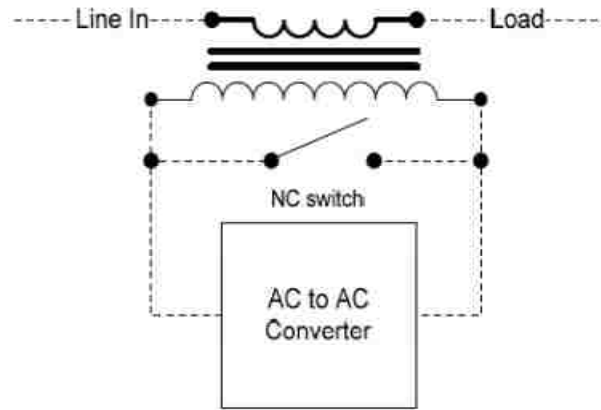

Figure 5.3 Voltage Regulator Schematic

Furthermore, local loading (such as organizer loads) could adversely affect some of the houses and not others, resulting in unequal competition conditions.

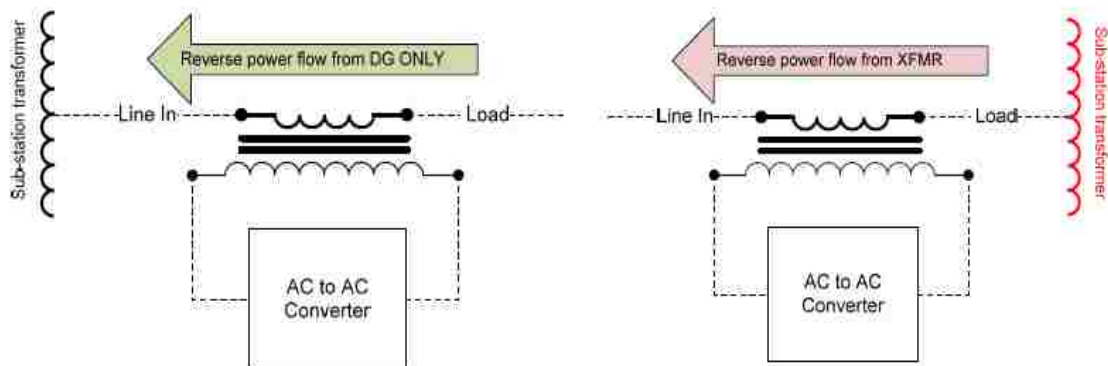

Figure 5.4 Voltage Regulator Operation

The voltage regulator used can be assumed to be an electronic equivalent of a variable auto transformer. This converter controls both the polarity and voltage on the secondary winding. Subtracts and adds flux density to the core to raise or lower voltage to the load.

Reverse power flow works only from distributed generation since the PV inverters follow the regulator output.

Bi-directional electronic voltage regulators from MicroPlanet were incorporated in the microgrid as shown in Figure 5.2 and they served two purposes. Three-phase models were installed on the north backbone to counter voltage drop along the “North-South Backbone Connection”. Single-phase models were selected to provide full four-quadrant voltage regulation of 60 Hz power to the competition houses, which were assembled in groups of two to four, as was shown in Figure 5.2. The voltage to all of the competition houses needed to be regulated because over or under voltage to one house (resulting from PV inverter or HVAC equipment controls shut down) may result in an unfair competition conditions for other houses

## **5.6 Frequency Converter**

SD 2013 included two teams from Europe (Czech Republic and Austria), where the standard residential service is 230 Vac at 50 Hz. These teams were provided with 50 Hz power from a dedicated 30kVA voltage/frequency converter for house energy consumption. These teams were required to export all PV production at 60 Hz because no four quadrant frequency converters are currently commercially available or feasible. Many inverter manufacturers provide both 50 and 60 Hz models, so this was not considered a significant concern for these teams, but this presents an interesting academic

and engineering challenge. Both 50 Hz house power and 60 Hz PV power were monitored at the European teams' homes.

## 5.7 Cables

the voltage drops caused during distribution are crucial to understand the voltage fluctuations during the test. The wire lengths can be seen from Fig: 6.3, the voltage drop can be calculated using the formula,

$$\text{Voltage} = \text{Current} * \text{Impedance}$$

The conductors used for the SD village were 4/0 copper. These shielded cables were used to connect each of the 19 houses and also the infrastructure to the main power supply which was stepped down various times along the way. Frequency converters were used to supply power to the European teams which had appliances rated for 50 Hz.

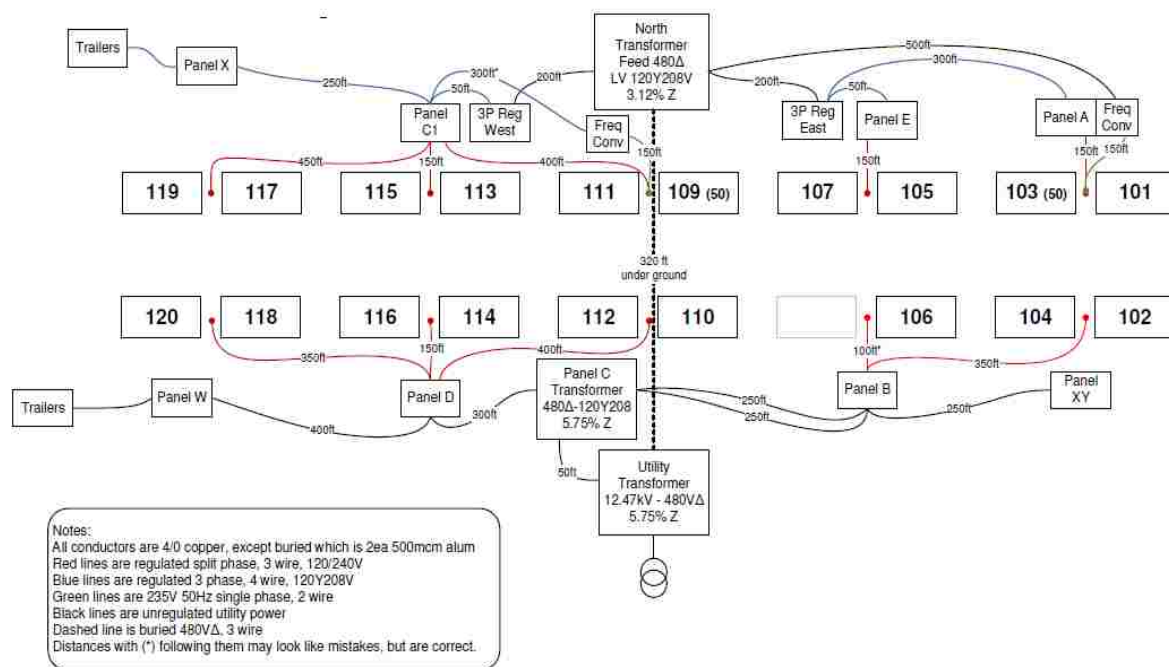

Figure 5.5: Cable configuration SD village

## 5.8 Meter Configuration

The data logging at the SD village consists of two parts. CT's monitor the power generated by the PV panels of each of the houses. A Schneider power logic meter is also placed at the main disconnect panel to monitor the amount of real energy consumed by the house. For the net energy calculation the real energy delivered to the house is subtracted from the real energy leaving the house. As net zero energy production was a contest requirement this setup was created to give real-time accurate data. In addition to this the aggregate of blocks of houses and other power consumption units were recorded at the main distribution panels. The logging software used for Schneider ION enterprise



Figure 5.6: Meter Configuration.

Power quality was monitored using Power logic PM870 Meters and everything was recorded using a Schneider ION enterprise server. The PowerLogic Power Meter Series 800 offers many high-performance capabilities needed to meter and monitor an electrical installation. The meter includes an easy-to-read display that presents measurements for

all three phases and neutral at the same time, an RS-485 Modbus communication port, one digital input, one KY-type digital output, total harmonic distortion (THD) metering, and alarming on critical conditions.



## **Chapter 6**

### **CID Test Plan**

After the completion of the US DOE Solar Decathlon 2011 competition, additional microgrid testing was conducted to evaluate the high-penetration of PV systems within a microgrid [10]. For 2013 the timeline of the test is shown in the Table 6.1.

At 8:30am, all Electric Vehicles (EVs) were plugged in, this was the time when PV production was ramping up due to the rising sun. The voltage waveforms of the houses that had EVs connected to them were recorded at the moment of plugging in. At 9:45 the 3 phase voltage regulators positioned at the east and west of SD village were switched off and the voltage waveforms were recorded before and after. The other voltage regulators remained connected.

At 10:30 EVs were disconnected to see the effect of lower load on the houses when the 3 phase regulators remained disconnected. The voltage waveforms were triggered before and after the unplugging of cars. At 11:35 the voltage regulators at the panels were also disconnected one by one. Regulator at panel C1 was disconnected first and then regulator at panel A was disconnected and panel E regulator was disconnected last at 13:30.

The voltage never went over 128V even though there were no voltage regulators connected. The cloud cover was also intermittent thus adding one more variable to the voltage swings. Due to the intermittent cloud cover the PV production of the SD village was ramping up and down quite frequently. This resulted in voltage swings ranging from 124V to 128v at the houses where the cars were connected. These voltage waveforms/data were logged and can be seen in the Figure 7.5 and Figure 8.1

Time	Event(s)	Goals or purposes
6:00am-6:30 am	All EVs plugged in	Baseline test while still connected to the grid
7:00am	Transfer to Generator	Islanded operation.
7:00am-8:00 am		Observe microgrid for stability, record all data as needed
8:00am-10:30 am	All EVs plugged in	<ol style="list-style-type: none"> <li>1) Before PV generation is significant, observe microgrid for voltage and frequency instabilities due islanded operation with additional loads (EVs)</li> <li>2) As power export begins, observe microgrid for voltage and frequency instabilities due to interplay between inverters, EV loads and islanded operation.</li> </ol>
10:30am-1:30 pm	All EVs unplugged	Observe microgrid in islanded mode during intermittent clouds conditions
1:30pm-2:00 pm	Systematically bypass all VRs	Observe microgrid in islanded mode as VRs are being bypassed one by one.
2:00pm-6:30 pm	All EVs plugged in	<ol style="list-style-type: none"> <li>1) While PV generation is significant, observe microgrid in islanded with all Voltage Regulators disabled and additional EV loads.</li> <li>2) As PV generation reduces and village returns to power import condition, observe microgrid for any instabilities during this transition (while all VRs are still disabled and EVs are plugged in)</li> </ol>
6:30pm	Transfer to grid	End of islanded operation

TABLE 6.1: CID Test EVs test plan

## Chapter 7

### Data collected from the SD village

All the houses participating in the competition had PV systems. The sizing of each houses system was dependent on the size of loads of the particular house.

The PV system size of house no 117, which is the house of interest (SHADE) was 9.54kw. It was oversized for competition purposes in the solar decathlon. And as a result the house had net positive energy. More energy was exported from the house than what was actually consumed. This can be seen in Fig: 8.1. So over sizing the system by a small margin proved to be beneficial in the competition. As most teams in the competition had oversized their pv system, the net energy competition had everyone scoring the same amount of points.

EVs connected to the houses:

There were a total of 7 EVs connected to various houses and a charging station in the SD village. The houses that had EVs connected are listed in Table 7.2. There was also a difference in the type of charger used for these cars, Level 1 and Level 2 chargers were used.

The difference between L1 and L2. There are 3 types of chargers. Level 1, Level 2, Level 3. The differences between different chargers are shown in Table 7.1.

LEVEL	DEFINITION
LEVEL 1	AC energy is supplied to the car using the household 120v receptacle.
LEVEL 2	AC energy is supplied to the vehicles onboard charger; 208V-240V single phase.
LEVEL 3	DC Energy from an offboard charger

TABLE 7.1: Car Chargers-Levels

HOUSE NUMBER	NUMBER OF CARS	MODEL NAME OF CAR
HOUSE 117	1	Ford focus electric
HOUSE 118	1	Mitsubishi i-MiEV
HOUSE 109	1	Nissan Leaf
HOUSE 105	2	Chevy Volt
SCHNEIDER CHARGING STATION	2	Chevy Volt

TABLE 7.2: Car models

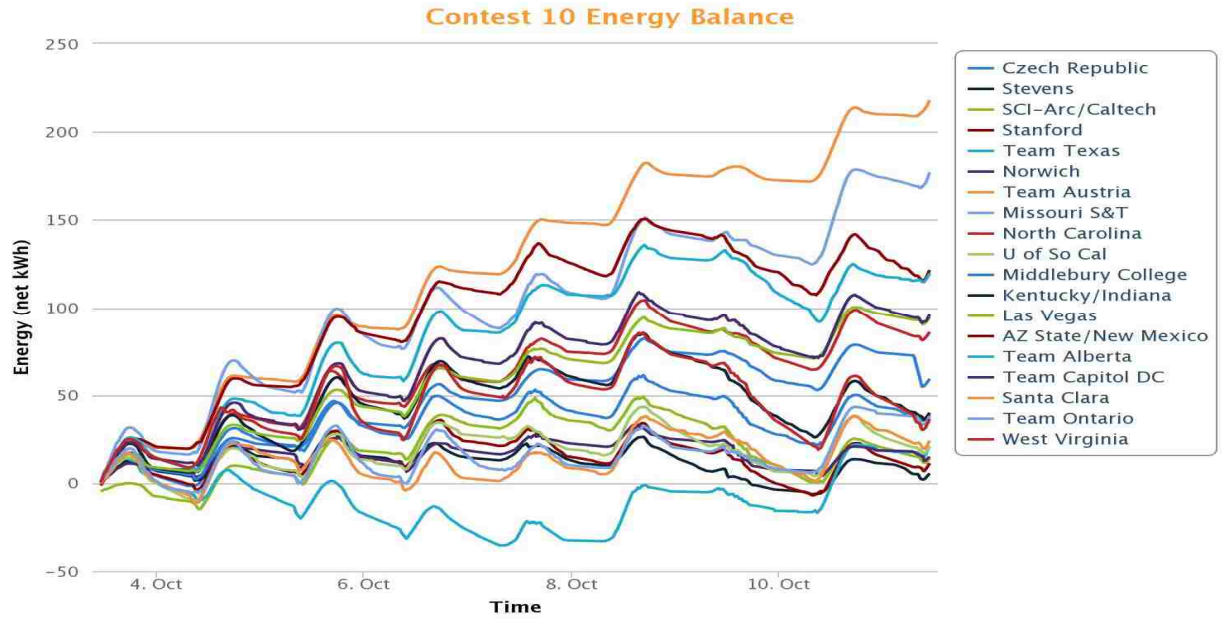

Figure 7.1: Energy Balance- All houses

For the test purposes cars were connected to houses, the houses that had EVs connected to them can be seen in Figure: 7.2.

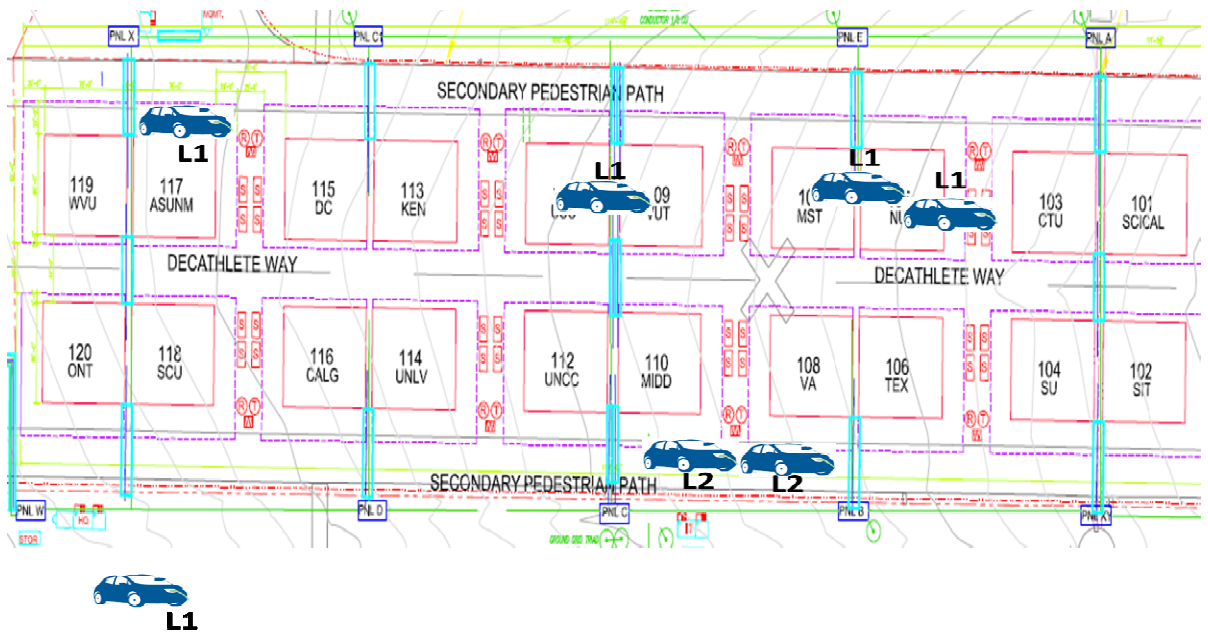

Figure 7.2: SD village- Cars Locations

## 7.1 Power Flow

The power flow in both directions was monitored and recorded at the competition houses, distribution panel boards and microgrid Point of Common Coupling (PCC). During the competition, the peak power imported to the SD2013 village was 98 kW, and the peak power exported from the SD2013 village was 77 kW as can be seen in Figure 7.3 (Teams' PV systems did not produce power close to the maximum installed capacity values because the competition was held in October, Peak exported power would have been even higher if the competition was to be held during summertime.) The transition between PV power produced to power consumed from the utility is point of interest. Ideally the transition should be smooth and there should not be any ramping up and down of the power curve. This generally happens when the sun sets or rises as the PV panels start producing and stop producing respectively. The figure 7.3 shows the PV power dropping off drastically at sunset and sunrise. This shape and amplitude of the power swings are clearly identifiable as a "duck curve" [2]. This problem can be overcome if there are smoothing batteries or there is an algorithm controlling the powering on sequence of the inverters. So that whenever there is a possibility of steep rise of PV power the algorithm would smooth out the power curve so that there is less stress on the voltage regulators and other protective equipment. This helps the utility by increasing the lifetime of devices already in place. Additionally, the addition of more PV systems to the grid becomes a possibility without any upgrade in the already existing infrastructure, which can be quite costly.

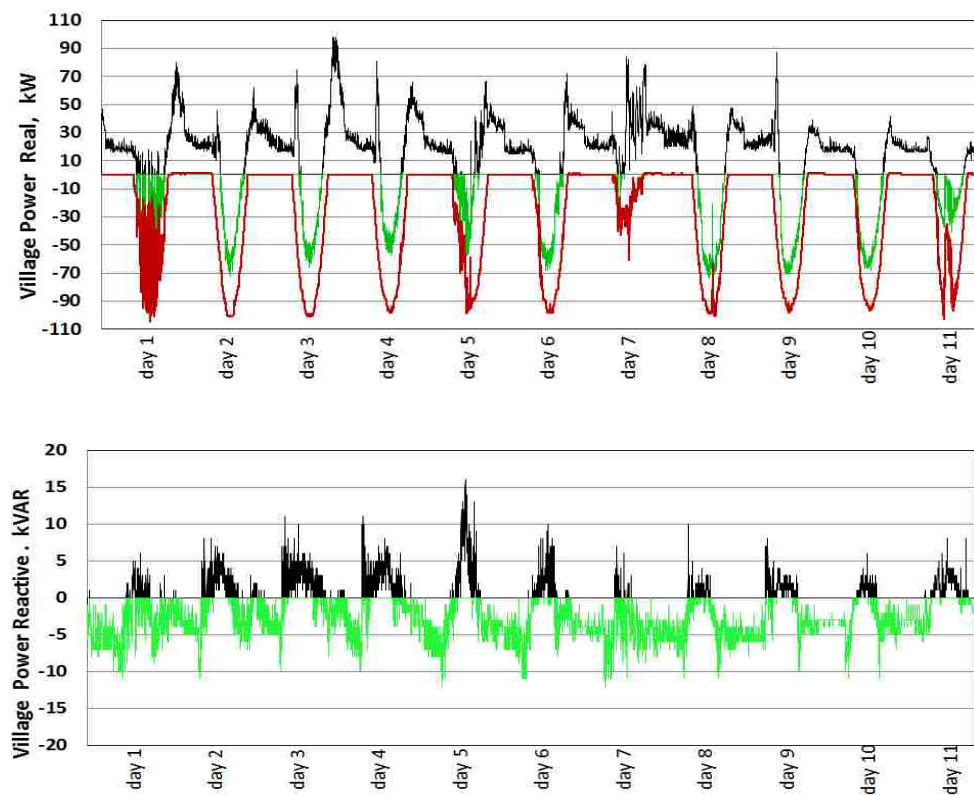

Figure 7.3. Real (a) and Reactive (b) Power of the US DOE SD 2013 Village. Legend: Red – PV Power production, Green – power exported by the Village, Black – power imported to the village

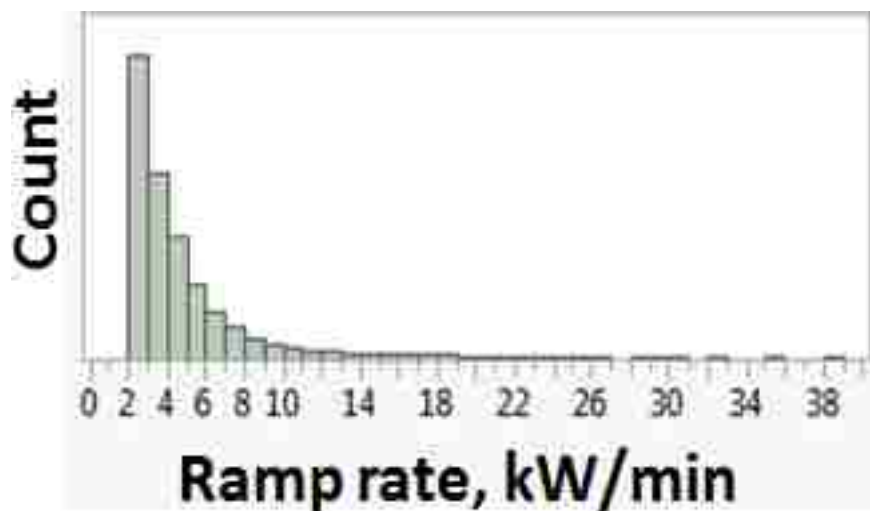

Figure 7.4. Histogram of real power ramp rates for all days of SD2013. The insert shows CDF of ramp rates.

Furthermore, 100% customer penetration ratio, coupled with the 100% coincidence factor of PV generation shows that additional abrupt spike in power consumption can be observed in the mornings, just before PV inverters start producing power – these can be seen as black spikes in Fig. 3. Several other high PV penetration localities are reporting similar trends in power and load flow [3,4]. Therefore, energy use coincidence factor (in time) is a very important factor for microgrid planners to consider.

Both the “duck curve” and cloud-induced power intermittencies can be characterized in by calculating power ramp rates in kW/min. Single-sided power ramp rates (ramp-up or ramp-down) at the Point of Common Coupling for the all days of SD village operation are shown in Figure 7.4; insert shows Cumulative Density Function (CDF) for this distribution. The histogram shows that majority of the power ramp rates are under 10kW/min, and the CDF function shows that 50% of the ramp rates are under 5kW/min. These values are typical for high % penetration residential PV installations [5]. But power ramps of this order of magnitude can be easily mitigated and smoothed by incorporating co-located residential, community-scale or utility-scale storage [11,12]. Several collegiate teams have already used thermal storage [13] in their SD 2013 house designs in order to smooth out their load profiles. Incorporating electrical storage (batteries) may be an interesting addition to future Solar Decathlon 2015 contests.

## **7.2 Power Quality**

As a temporary distribution network, the Solar Decathlon village was not required to comply with ANSI C84.1 or other stringent power quality requirements [5]. In order to guarantee fair competition conditions, SD 2013 organizers agreed to provide collegiate teams with service level voltages within  $\pm 5\%$  of the nominal voltage (Range A). For up



to two hours each day, the service voltage was allowed to be within +8% / - 10% of the nominal voltage (Range B). The ranges are shown in Table 7.3.

As mentioned above, voltage levels and other power quality attributes were continuously monitored.

	Service Voltage Range A	Service Voltage Range B
High	126	129.6
Nominal	120	120
Low	114	108

Table 7.3: Typical team service voltages for 120V service.

Figure 7.5 shows line voltages for all collegiate houses (except European); different colors correspond to different houses. Slight voltage pull is observed daily when inverters are generating. However, all voltages stay within Solar Decathlon's allowed ranges for all days, even during the last day of the controlled islanded test

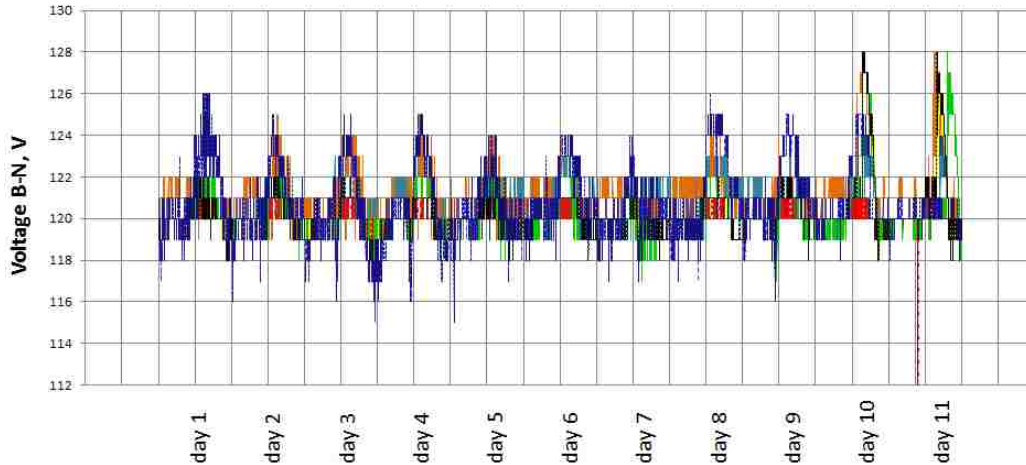

Fig 7.5. Phase A Voltage for collegiate houses during SD 2013 competition days

Beyond verifying that utility service voltages are within acceptable ranges, SD organizers wanted to evaluate all other power quality features for each of the contestants' houses, to see if a collection of all energy-efficient and (in some teams' cases) novel loads will produce high harmonic currents, which in turn would create high harmonic voltage distortion for the whole village. This can be significant concern for all utilities facing clustering of high-end residential housing with high energy-efficient loads percentages.

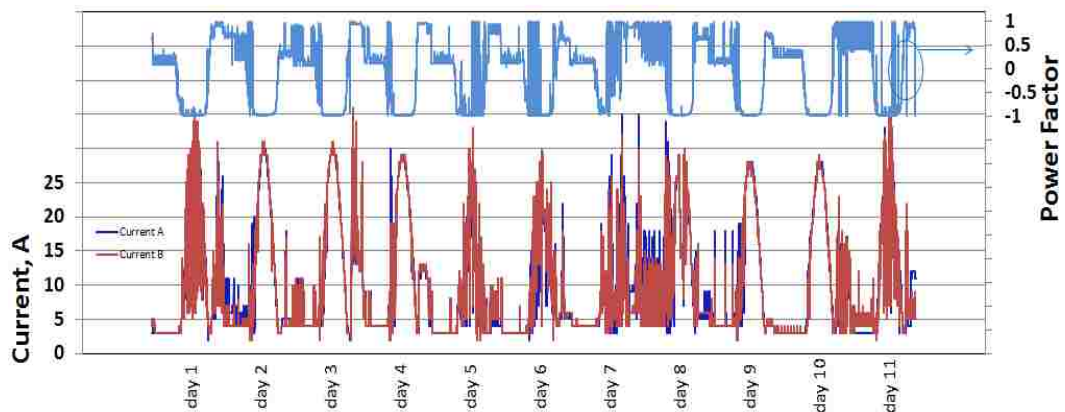

Figure 7.6. Line current and power factor for one of the collegiate houses at the SD2013 Village

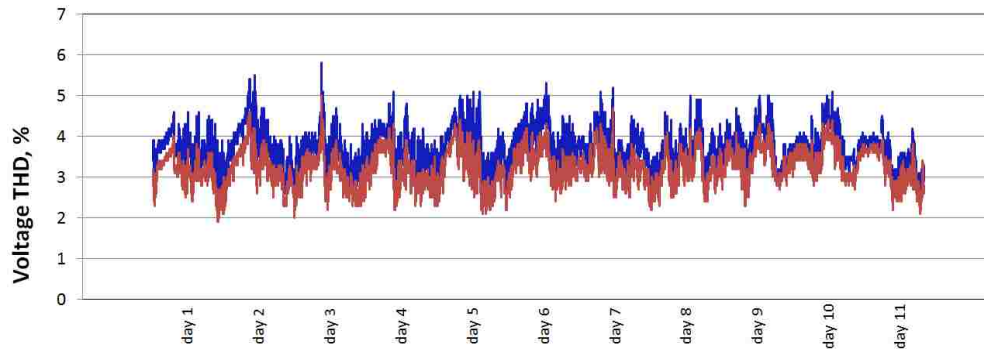

Figure 7.7. Line voltage THD for one of the collegiate houses at the SD2013 Village

### Total Harmonic Distortion

The power quality of the distribution plays an important factor in the power consumption and power regulation. As Johan Lundquist put it “the phrase “power quality” has been widely used in the last decade and includes all aspects of events in the system that deviates from normal operation.” [need to reference that ]

The power sources act as non-linear loads, drawing a distorted waveform that contains harmonics. The harmonics can cause telephone interference, increase the losses in the cables because of additional current flowing through them. The distortion of all these harmonics together is called Total Harmonic Distortion (THD).

Loads can generally be divided in to linear and non-linear loads. Linear loads are generally purely resistive in nature, whereas the non-linear loads have an element of capacitance or inductance in them. For example, imagine a AC source with a load connected to it. If a linear load in connected to it, it draws current which is sinusoidal in nature so it does not distort the voltage waveform. But if a non-linear load is connected to

the AC source it can draw current that is not sinusoidal in nature and thereby distort the voltage waveform. But the distorted waveform, however complex, is just a composite of multiple waveforms called harmonics. These harmonics have a frequency that is an integral multiple of the fundamental frequency of the waveform. If the fundamental frequency was 60Hz, the harmonics would have frequencies of 120Hz, 180Hz, 240Hz, and 300Hz etc. So harmonics distortion generally means the degree of distortion of the fundamental waveform due to the summation of all these individual harmonics. The ideal sine wave has zero harmonic components.

THD, is the summation of all the harmonic components compared to the fundamental component of the voltage/current waveform. Better show this with a formula. This is generally represented as a % value.

Harmonics are generally a result of non-linear loads like Variable Frequency Drives (VFD), computer power supplies, electronic ballasts and arc furnaces. These harmonics can cause harm to neutral conductors and transformers by increasing the amount of current flowing through them. If there are higher order harmonics they can cause interference in telecommunication lines. Additionally, they also cause higher core losses in motors. THD can be mitigated by using filters, transformers with different couplings and over sizing the system. The last method is not generally acceptable because of increase of cost of the system in place.

### Power Factor

The power factor of an AC electrical system can be defined as the ratio of real power flowing to the load, to the apparent power of the circuit. It is a dimensionless number

between -1 and 1. Due to energy stored in the load, or due to non linear loads which distort the waveform of the current drawn the apparent power turns out to be greater than the real power. This extra power increases the losses in the distribution system because of extra current flowing through the conductors. This in turn increases equipment costs as all of the parts of the system have to be oversized to accommodate this extra current. Utilities also charge penalties if the power factor is below a certain threshold. Depending on the type of the load the power factor increases or decreases. Linear loads with low power factor like induction motors can be compensated with a passive network of inductors or capacitors. But in the case of non linear loads like rectifiers active power correction methods have to be used.

The utility can use power factor correction methods like reactors to decrease the current in the distribution system or individual customers can install them at the plant to reduce the power factor penalties from the utility. The addition of reactive elements has to be done after careful engineering analysis as a poorly designed system can be counterproductive to the power quality. The reactive elements can create voltage fluctuations and harmonics when switched on and off. Also they can interact with other parts of the system or interact with each other to create resonance. This can result in system instability or very high voltage fluctuations. So the system has to be carefully designed.

As the reactive elements absorb reactive power from the system, the capacitance delivers VARs on to the system. If there are a lot of inductive loads in the system it causes lagging power factor, and the capacitors connected can counteract that effect.

Another way of improving power factor is to connect a unloaded synchronous motor to the line. This provides reactive power to the line. The control system of the synchronous condenser monitors the power factor of the system to controls the field excitation to regulate the amount of reactive power injected into the system. The reason this system is more robust is because the reactive power supplied is proportional to the voltage, whereas in the case of a capacitor the reactive power is proportion to the square of the voltage. So this gives the synchronous condenser greater control is regulating and improving the power factor of the system.

For non-linear loads like arc furnaces or rectifiers the power factor correction has to be done in a different manner. Because most of these loads have a switching action, this distorts the waveform of the current drawn. The distortion power factor is the measure of how much the harmonic distortion of the load current decreases the average power transferred to the load. The methods used to correct distortion power factor are different compared to the methods to correct displacement power factor. Passive filters can be used to improve distortion power factor. This is essentially a inductor connected to the line to reduce harmonic current. The active power factor correction schemes use power electronic equipment to alter the waveform of the current drawn by the load. The purpose is to make the load look purely resistive, thereby removing the need for supply of reactive power. The other way of improving power factor is by using dynamic power factor correction schemes which sample the power factor of the system numerous times in each cycle, which increase the capacity of the system to react to dynamic changes in the power factor of the load.

Power Factor (PF) of one of the collegiate houses is shown in Figure 7.6, line currents are shown in the same plot for reference. The following convention for PF is used: PF is positive when power is flowing into the load, (house in this case) and negative when power is flowing from the load. Understandably, PF is very close to -1 during daytime (when PV inverters are generating) and stays very stable independently on the PV power production and given weather pattern of the days. It can be seen in figure 7.6 that there are steep changes in power factor when the load of the house picks up. This can be attributed to the HVAC equipment turning on and off to maintain the temperature of the house. The data was collected for house 117 which had a chiller and was affecting the power factor value. This agrees with the concerns that the new energy efficient appliances have very detrimental power factor values. A more in depth analysis of power factor of each house in the next solar decathlon might be an interesting addition. Even adding a power factor correction scheme at individual houses might be a possibility depending on the economic justification.

Total Harmonic Distortion (THD) for line voltages is shown in Figure 7.7. With THD values between 3 and 4%, no dangerous harmonic injection was observed either during daytime (when PV inverters are generating) or nighttime (when teams house loads may be on), or even during the last day when additional EVs were plugged in. Figure 7.9 shows that additional heavy load from Electric Vehicles [6] also did not introduce further Power Factor or harmonic composition problems. It can be observed from the figure 7.7 that for house 117 the THD value was greater due to the effect of the chiller in the house. This non linear load was a substantial amount of the total power consumption of the house. That gives rise to THD fluctuation between 2 and 5%. Addition of more non linear

loads in the next solar decathlon might increase the THD values which introduce power quality issues. This can be mitigated by adding a active filter at the point of connection. A well designed filter should be able to reduce harmonic currents in the system and contribute to the reduction of cable losses in the microgrid.

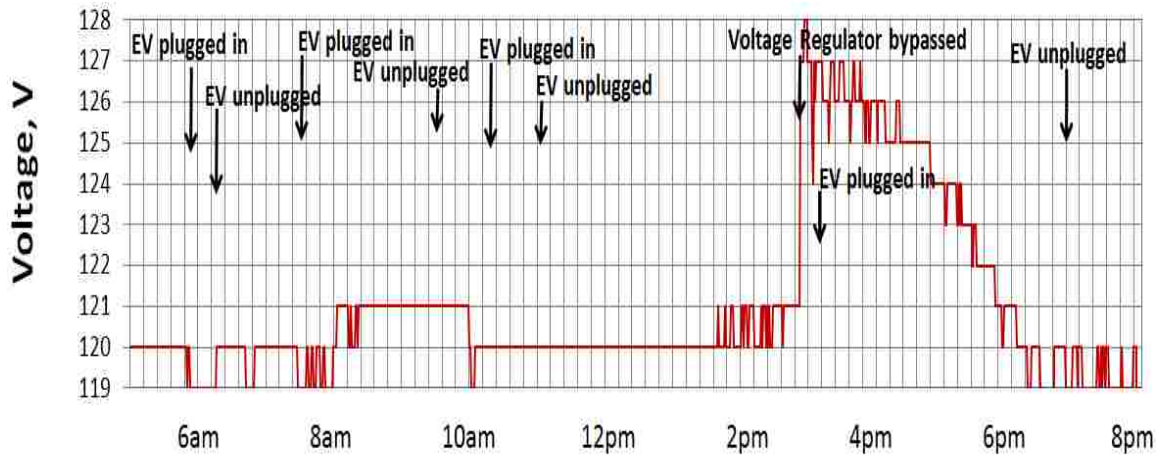

Figure 7.8 Voltage Profile of House 117 during CID test

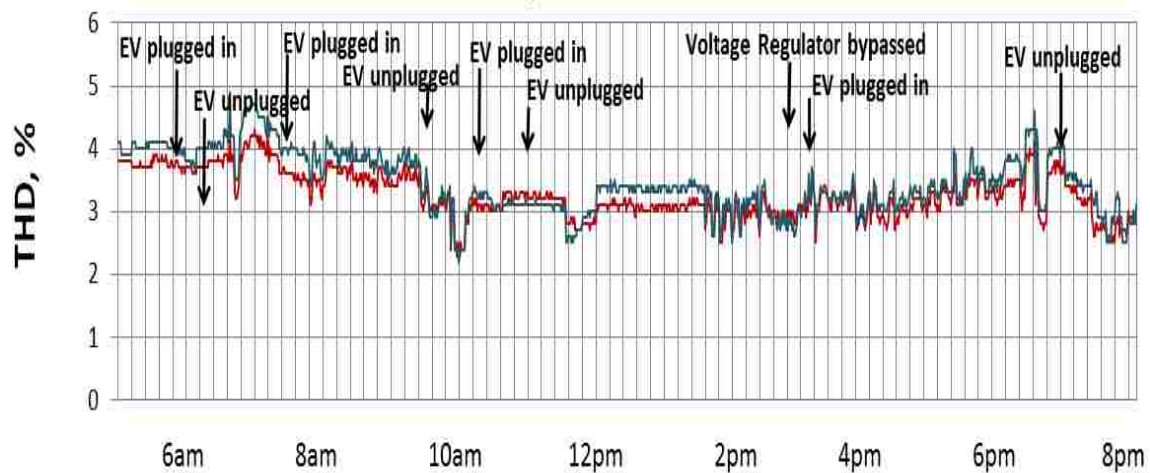

Figure 7.9 THD of House 117 during CID test



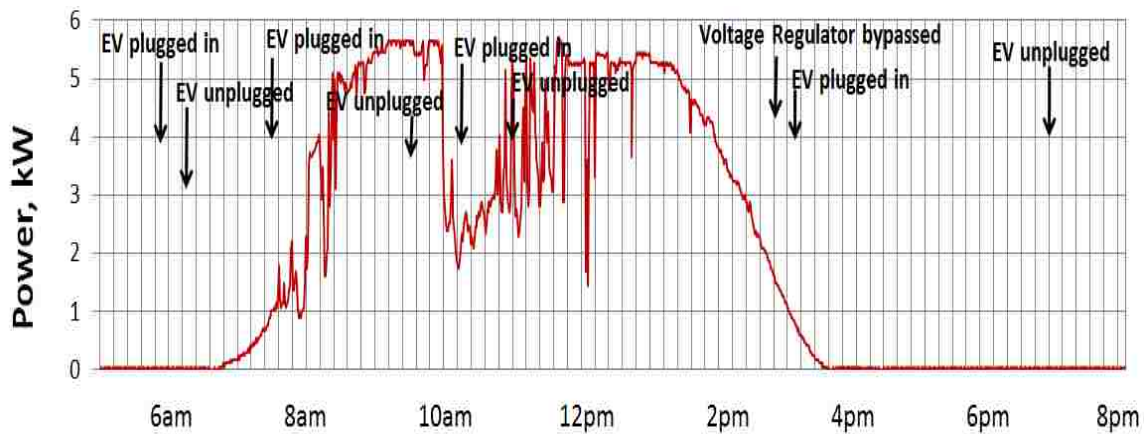

Figure 7.10 Power of House 117 during CID test

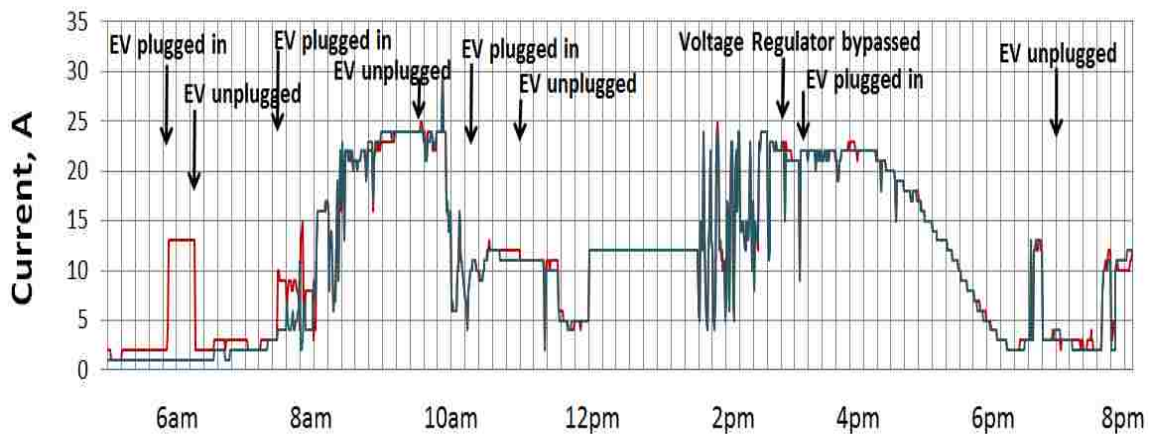

Figure 7.11 Current data of House 117 during CID test

The electric vehicles are known to be a source of harmonics in an AC system. But with enough damping or filters the affects can be mitigated. It can be seen in figure 7.9 that addition of electric cars to the house does not affect the THD values substantially. This can be attributed to long runs of cables all across the SD village which provided the necessary damping to the system.

But if substantially more non-linear loads are connected to the microgrid there is a possibility of THD values being outside the 5% tolerance value for most electronics equipment. This can be a cause for concern in the next solar decathlon.

## Chapter 8

### Controlled Islanding Demonstration Results

When the test was conducted all the HVAC equipment and rest of the appliances of all the houses in the competition were being operated according to normal schedule. One minute data was collected for the entire competition and during the points of interest when the supply was switched to the generator and when the voltage regulators were systematically switched off one second data was collected. The voltage profile can be illustrated in the figure 7.5, figure 8.1. There are four points of interest here,

1. Voltage when each panel regulator is turned off.
2. Voltage when electric cars at 6 houses are connected.
3. Voltage when individual house regulator is turned off.
4. Voltage when electric car is connected.

What has to be closely looked at is how the voltage profile, frequency changes when the cars are connected to the house. There is no prominent change in the voltage or frequency.

The figure 7.5 and figure 8.1 depict this. Voltage shoots upto 128V when voltage regulators are turned off. For all the houses this did not trip the inverters, and they were still connected to the grid.

The figure 9.1 and figure 9.2 represent the Voltage values seen at all houses for the entire competition, i.e. Sep 30<sup>th</sup> to Nov 14<sup>th</sup>. The CID test was conducted on the 13<sup>th</sup> of October and new graphs have been plotted accordingly to represent the voltage sags and swells during the period.

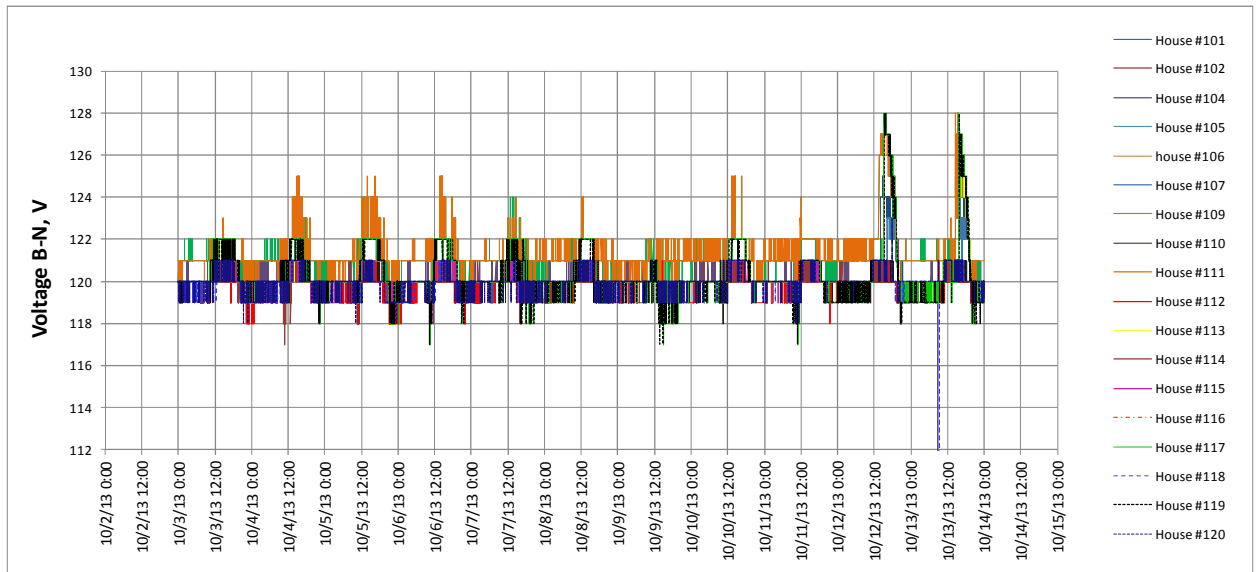

Fig 8.1.Phase B Voltage for collegiate houses during SD 2013 competition days

As the house of interest for us is House 117, we will look in to the effects of the various test conditions. The data logging equipment gathered data for power factor, Phase A current, Total PV power produced for house 117. Which are shown in Figures 8.3, Figures 8.4, and Figure 8.5 respectively. An interesting observation is the power factor of most of the new age equipment does not help the power factor remain close to unity. This is illustrated in the peaks and troughs of Figure 8.3.

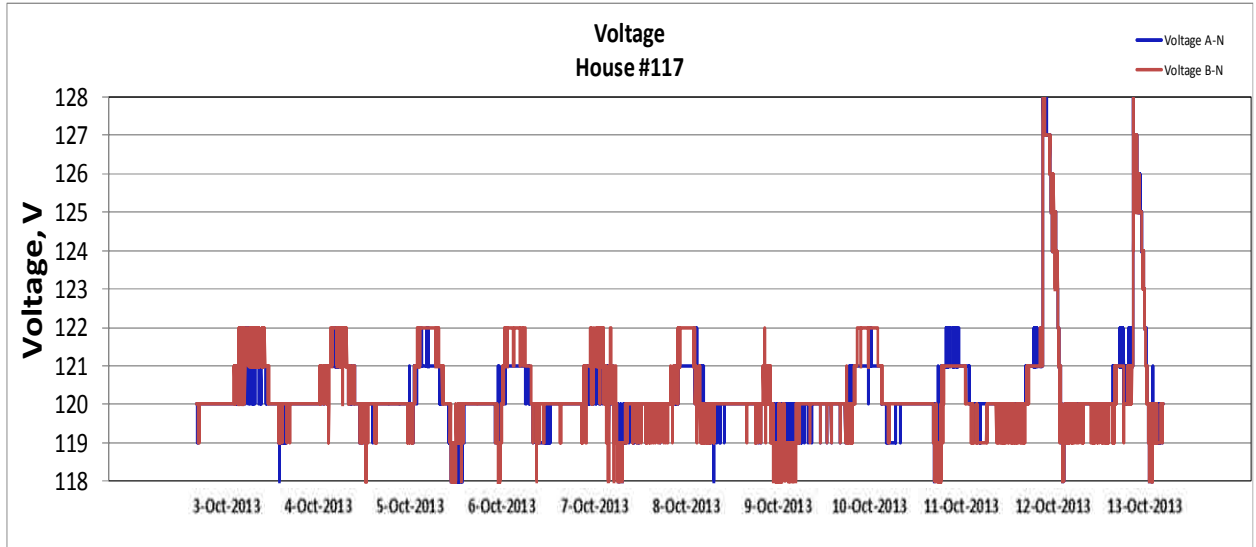

Figure 8.2 House 117- Voltage Profile

The voltage waveform showed in figure 9.3 shows the voltage swell to 128V when the voltage regulators are turned off during the time interval shown in Table 6.1. This can also be attributed to the change in load for the house 117. This can be seen in Fig 9.4 where the change in load current is shown during the test period.

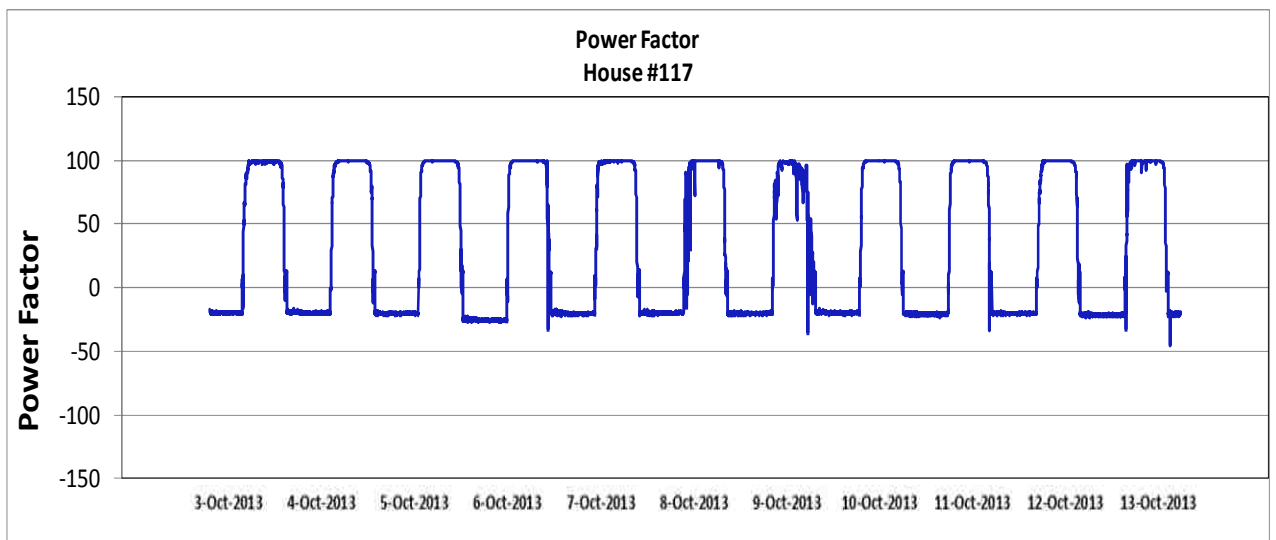

Figure 8.3: House 117-Power Factor

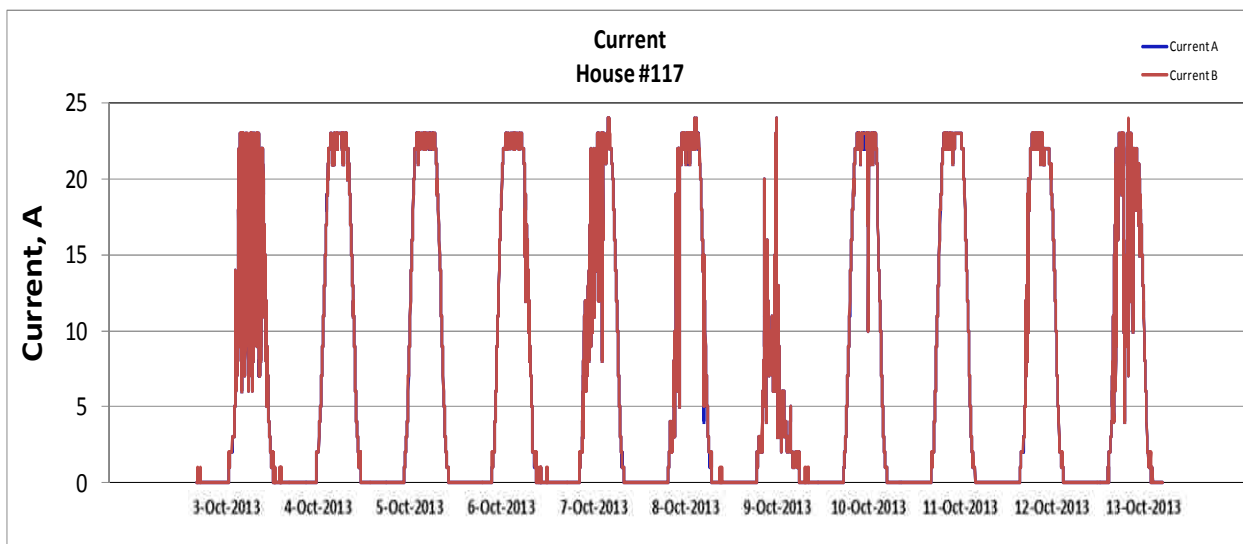

Figure 8.4: House 117- Phase A current

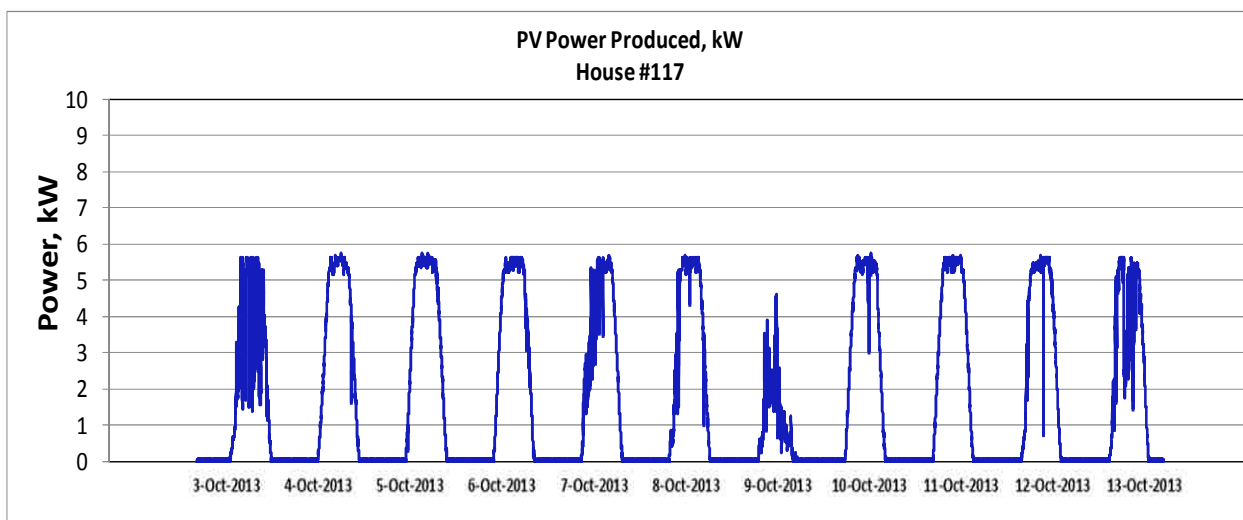

Figure 8.5: House 117 – Total PV Power produced

When the voltage regulators at panel C1 was disconnected the change in voltage was a result of the aggregated effect of the 3 houses connected to the panel, the voltage waveforms for the period of the test is shown in Fig: 9.3.

## Chapter 9

### ETAP simulation model of the SD village

**ETAP** electrical engineering software is a power systems analysis solution that includes analytical software modules for load flow, arc flash, short circuit analysis and many other applications. The SD 2013 one line diagram represented in figure 5.3 was created in etap using the components that were used. For the devices that did not have a preexisting ETAP model, an equivalent model was used with similar parameters. The voltage regulators used from Micro planet did not have an ETAP model so an equivalent voltage regulator was used instead to simulate its performance. The point of interest being what happens after the voltage regulators are turned off will limit the deviation of the simulation results from the actual recorded data.

The simulator can be used simulate a microgrid to a great level of details because of its many robust features. It can be used to conduct fault analysis on the system to understand the degree of stability. Faults like line-line, line-ground, 3-phase-ground can be simulated. These faults impact the line voltage of the system and induce transients which can be very detrimental to the loads connected to the microgrid. These faults can be used to understand the effectiveness of the protective scheme in place. The relays, fuses and circuit breakers must be designed to withstand transient fluctuations albeit only for a few cycles. As safety of the students and public was of primary concern when designing the system this fault analysis can provide insight in to the stability of the microgrid.

The simulator had the capability to introduce distributed generation sources in the one line diagram. Since the uniqueness of the microgrid was in its 100% PV penetration ratio this was an integral part of the simulation. Although the data obtained was a snapshot of the load flow values for the microgrid. Multiple cases could be created in the system to simulate varying PV power production conditions. The values of load and PV power could be decreased/increased to create stress on the microgrid in individual cases.

Meters can be placed at any node of the system and also at individual components to gather voltage power and current data, which can be exported to excel files for corroboration with data obtained during the CID test. Since the accuracy of the test depends on accuracy of the load data and how accurately it reflects the data collected at the SD village, this simulator had a few limitations in that aspect. The load profiles of the lumped loads were limited to a single value and could be given multiple values in different cases. But it could not replicate the minute by minute sampling of the data acquisition equipment at the SD village. This was one of the reasons for switching to a different simulator.

One of the reasons behind simulating the microgrid was to understand the effects of cable impedance on the voltage instability. The site had really long runs of cables which can cause voltage sag at the houses. The ETAP simulator had an exhaustive cable library which could accurately simulate the effect of long runs on the stability of the microgrid. The losses in the cables was extracted from the simulator to further investigate the relationship of the length of cable to voltage sag.



The simulator can be used to do arc flash analysis and it can generate arc flash labels that comply with ANSI requirements.

The one line diagram created in ETAP is shown in Figure 9.1. The point of interest for this simulation is the SHADE house (House 117). After conducting the ETAP simulation the conclusion drawn was that although the results were close to the actual data collected at the SD village, the data could not be collected across time steps. Since the test conducted yielded different results when the data was collected over a period of 24 hours the next step in the simulation process had to be thought through. Out of the numerous options available to conduct a simulation in the Time domain the most robust and well equipped was OPENDSS. So the SD village was next modeled in OPENDSS. The results obtained could be collected over a period of time which gave us better flexibility in testing the microgrid in place.

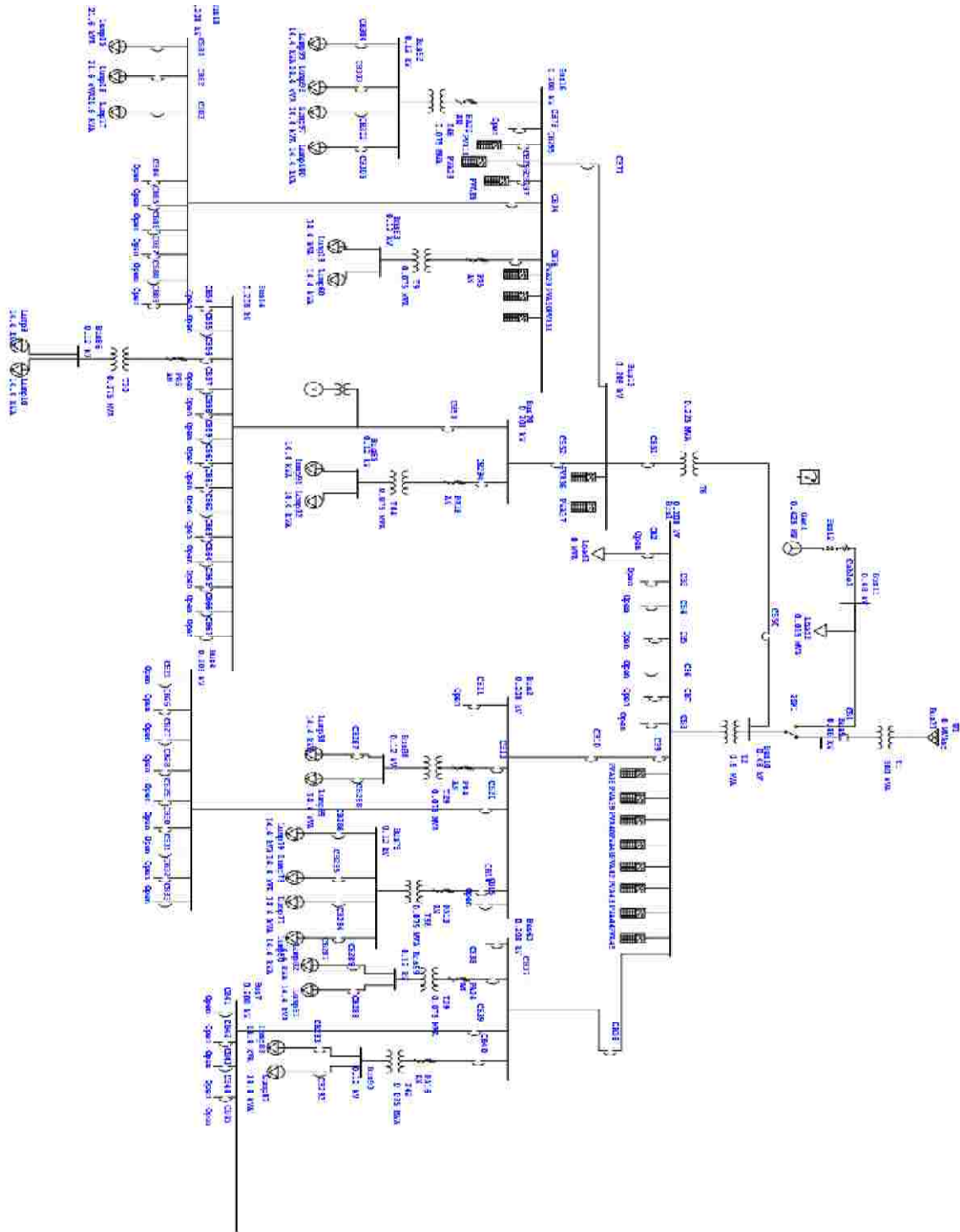

Figure 9.1 ETAP Simulation Model-One Line Diagram

## Chapter 10

### OPENDSS Simulation of the SD village

The idea behind conducting a second simulation of the solar decathlon village is to obtain data over a period of time. And see how the system reacts to different disturbances over a period of a day/ year or any other period of interest. The OPENDSS is an electric power system simulator for supporting distributed resource integration and grid modernization efforts. The solar decathlon one line diagram shown in figure 5.3 can be represented in OPENDSS [4] and can duplicate the setup to a great degree of accuracy.

The load data for each of the houses collected during the CID test was used to represent the loads for the microgrid. The PV systems for the houses were represented according to the values giving by individual teams in their project manuals

The Electric vehicles connected to the houses were modeled as a load with a specific loadshape. The loadshape of the load was given such that it duplicated the charging characteristics of the electric car. This would give us a better insight in to the effects of electric car in an microgrid with 100% PV penetration.

As the purpose of this simulation was to conduct it in the time domain. All the components of the simulation were given values for discrete time steps. The Solar irradiation data was considered to the Albuquerque, new mexico. And that was maintained as the constant source for all the PV systems.

The monitors in the script are used to log the power and voltage values at each of the houses. The time step value for this simulation was 1hr. And all the values were obtained for a period of 1 year. The load profile of individual houses can be changed according to the needs of the test. Similarly the profile of the PV system can be modified too. Once OPENDSS starts adding the islanding module to the program we can really test the stability of the micro grid in islanding mode.

The voltages, currents and power from all the houses was registered for a period of 1 year. The voltage profile of house 117 can be seen in figure 10.1 and the voltage profile of all the houses together can be seen in figure 10.2

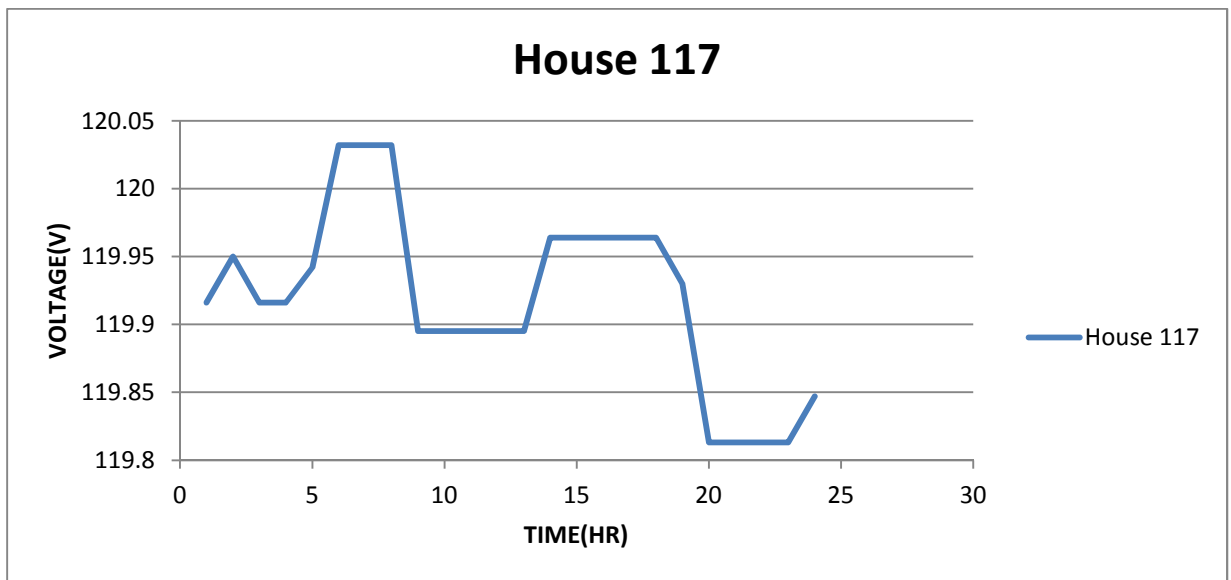

Figure 10.1: House 117-Voltage profile in OPENDSS

The Voltage profile of all the houses for a period of 1 day are shown in Fig 11.1

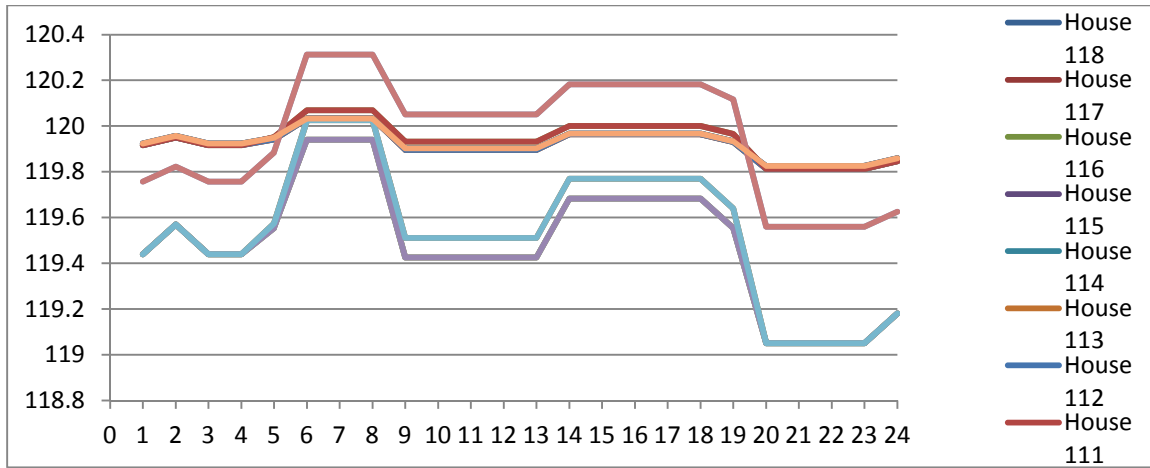

Figure 10.2: Voltage Profile of all Houses in OPENDSS

## Chapter 11

### Conclusion and Results

The microgrid model created in ETAP and OPENDSS was accurate to a certain extent to the one deployed in the SD village. The challenges faced during the modeling were accurately depicting the cables and transformers, as most of the products used did not have simulation models. The data used for transformers and cables was obtained from generic and industry standard models. Although this data is accurate to a very high degree it obviously cannot mimic the exact transformers and cables due to the small variance in the characteristics from one manufacturer to the other.

The idea was to create a framework so that future research could be carried on from this model. As the data suggested the model was quite accurate and depicted the voltage, power and current values for a 100% PV penetration microgrid. The microgrid was considered to be relatively stable considering the amount of Distributed Generation(DG) connected.

## **Chapter 12**

### **Future Work**

The framework created in OPENDSS can be used to simulate multiple scenarios. More electric cars and better voltage regulators can be added to this model to simulate the effects of added load on the microgrid.

This model can be further extended to simulate islanded operation of the microgrid. We should be able to simulate and record Sag/Swell voltage disturbances at each of the individual loads. The inverter operation can be modeled to react to voltage disturbances in the Grid after the thresholds are set. The resulting disturbances can be recorded when the PV systems are disconnected during islanded operation due to voltage disturbances above the threshold.

## References

- [1] Eman Beshr “Comparitive study of adding PV/Wind Energy systems to Autonomous Microgrid.” *2013 3<sup>rd</sup> International Conference on Electric Power and Energy Coversion systems.*
- [2] [http://www.aiso.com/documents/flexibleresourceshelprenewables\\_fastfacts.pdf](http://www.aiso.com/documents/flexibleresourceshelprenewables_fastfacts.pdf)
- [3] Mather, B. Russell N., "Integrating high penetrations of PV into Southern California: Year 2 project update." In Photovoltaic Specialists Conference (PVSC), 2012 38th IEEE, pp. 000737-000741. IEEE, 2012.
- [4] Stewart, Emma, James MacPherson, Slavko Vasilic, Dora Nakafuji, and Thomas Aukai. "Analysis of High-Penetration Levels of Photovoltaics into the Distribution Grid on Oahu, Hawaii." *Contract 303 (2013): 275-3000.*
- [5] Kleissl, Jan, Matthew Lave, Mohammad Jamaly, and J. Bosch. "Aggregate solar variability." In Power and Energy Society General Meeting, 2012 IEEE, pp. 1-3. IEEE, 2012.
- [6] Xiaoyu Wang, Haozhe Wu, Xiaoqian Ma Wenyuan Han, Tao Zheng “Impact of Islanding Detection Time on the Mode Transition of Inverter-Based Micro-grid.”
- [7] San Luis Obispo “Impacts of Plug-In Electric Vehicle On Residential Electric Distribution System using Stochastic And Sensitivity Approach”
- [8] Zhao Dongmei, Zhang Nan and Liu Yanhua,” Micro-grid Connected/Islanding Operation based on Wind and PV Hybrid Power System”
- [9] Xuan Liu, Bin Su “Microgrids - An Integration of Renewable Energy Technologies”
- [10] Stafford, B. Coddington, M.; Butt, R.; Solomon, S.; Wiegand, G.; Wagner, C.; Gonzalez, B. (2012). Design and Performance of Solar Decathlon 2011 High-Penetration Microgrid: Preprint. 10 pp.; *NREL Report No. CP-7A30-54719.*
- [11] O Lavrova, F Cheng, Sh Abdollah, H Barsun, A Mammoli, D Dreisigmayer, S Willard, B Arellano, C van Zeyl, “Analysis of battery storage utilization for load shifting and peak smoothing on a distribution feeder in new Mexico”, *IEEE PES Innovative Smart Grid Technologies (ISGT)*, 2012, pp 1-6
- [12] F Cheng, S Willard, J Hawkins, B Arellano, O Lavrova, A Mammoli, “Applying battery energy storage to enhance the benefits of photovoltaics”, *IEEE Energytech*, 2012 IEEE, 1-5



- [13] Siva Patibandla, Matt Erdman, H. Beauchamp, M. Montoya, J. Dellis, K. Yu, O. Lavrova J. Washington, A. Taqi, J. Cribbs, P. Horton, M., Fraser “Team ASU-UNM DOE solardecathlon 2013 Shade house. Combining passive and active solar designs with architecture”
- [14] Ren Jingding, Che Yanbo, Zhao Lihua “Discussion on Monitoring Scheme of Distributed Generation and Micro-Grid System.”
- [15] Vaidyanath Ramachandran, “Modeling of Utility Distribution Feeder in OpenDSS and Steady State Impact analysis of Distributed Generation”
- [16] He-Jin Liu, Ke-Jun Li, *Member, IEEE*, Hong-Xia Gao, Ying Sun, Kai-qi Sun and Wei-Jen Lee, *Fellow, IEEE* “Control and Simulation of Grid Connected Micro-Grid”
- [17] Chengming Wu, Jie Liu and Yabin Wu “The Impacts of Micro-grid on the Reliability of Distribution System”