

8-2010

The Larval salivary gland of *Drosophila melangogaster*: A model system for temporal and spatial steroid hormone regulation

Benjamin Constantino
University of Nevada, Las Vegas

Follow this and additional works at: <https://digitalscholarship.unlv.edu/thesesdissertations>



Part of the [Genetics Commons](#), and the [Molecular Biology Commons](#)

Repository Citation

Constantino, Benjamin, "The Larval salivary gland of *Drosophila melangogaster*: A model system for temporal and spatial steroid hormone regulation" (2010). *UNLV Theses, Dissertations, Professional Papers, and Capstones*. 833.

<https://digitalscholarship.unlv.edu/thesesdissertations/833>

This Dissertation is protected by copyright and/or related rights. It has been brought to you by Digital Scholarship@UNLV with permission from the rights-holder(s). You are free to use this Dissertation in any way that is permitted by the copyright and related rights legislation that applies to your use. For other uses you need to obtain permission from the rights-holder(s) directly, unless additional rights are indicated by a Creative Commons license in the record and/or on the work itself.

This Dissertation has been accepted for inclusion in UNLV Theses, Dissertations, Professional Papers, and Capstones by an authorized administrator of Digital Scholarship@UNLV. For more information, please contact digitalscholarship@unlv.edu.

THE LARVAL SALIVARY GLAND OF *DROSOPHILA MELANOGASTER*:
A MODEL SYSTEM FOR TEMPORAL AND SPATIAL
STEROID HORMONE REGULATION

by

Benjamin F.B. Costantino

Bachelor of Science
University of Nevada, Las Vegas, Las Vegas, NV
2000

A dissertation submitted in partial fulfillment of
the requirements for the

Doctor of Philosophy in Biological Sciences
School of Life Sciences
College of Sciences

Graduate College
University of Nevada, Las Vegas
August 2010

Copyright by Benjamin F.B. Costantino 2010
All Rights Reserved



THE GRADUATE COLLEGE

We recommend that the dissertation prepared under our supervision by

Benjamin F. B. Costantino

entitled

The Larval Salivary Gland of *Drosophila melanogaster*: A Model System for Temporal and Spatial Steroid Hormone Regulation

be accepted in partial fulfillment of the requirements for the degree of

Doctor of Philosophy in Biological Sciences

School of Life Sciences

Andrew J. Andres, Committee Chair

Frank van Breukelen, Committee Member

Allen Gibbs, Committee Member

Steven deBelle, Outside Committee Member

Ron Gary, Graduate Faculty Representative

Ronald Smith, Ph. D., Vice President for Research and Graduate Studies
and Dean of the Graduate College

ABSTRACT

The Larval Salivary Gland of *Drosophila Melanogaster*: A Model System for Temporal and Spatial Steroid Hormone Regulation

by

Benjamin F.B. Costantino

Dr. Andrew J. Andres, Examination Committee Chair
Associate Professor of Biological Sciences
University of Nevada, Las Vegas

Drosophila melanogaster provides an ideal model organism to test genetic and molecular biological mechanisms within the context of a living animal. For over one hundred years *Drosophila* continues to produce a boundless extent of informative and important scientific data providing crucial insight into development, disease progression and genetic interactions. A century as a model organism allowed for the development of an abundance of unique genetic and molecular tools allowing researchers to tease apart cellular mechanisms with very little limitation. From the whole adult body to tissue function to molecular networks, if a biological question arises it most likely can be answered using the fruit fly.

The *Drosophila* larval salivary gland is an organ that not only takes advantage of the many biological tools available, but also has innate properties favoring it as a model tissue to investigate nuclear hormone activity. In the final larval stage (third instar) of *Drosophila*, the salivary gland responds to the steroid hormone, 20-hydroxyecdysone (20E) by synthesizing and secreting a glycosylated polypeptide glue mix (glue).

In the mid-third instar, a low titer of 20E initiates a complex of gene expression that targets the glue genes resulting in the synthesis of glue. Using fluorescent markers tagged to the glue, this event is easily monitored using confocal microscopy. The first

part of my dissertation describes a model in which glue synthesis is a 20E-coordinated event and that surprisingly did not act through a canonical nuclear hormone receptor. Prior to my research, it was known that 20E-activated genes act through a nuclear hormone receptor comprised of a heterodimer between two proteins, ecdysone receptor (EcR) and ultraspiral (USP). However, I show that 20E-regulated glue synthesis is USP independent. Included in this section of my dissertation are experiments designed to test this model of glue synthesis that is independent of USP and to investigate the potential for another co-receptor functioning with EcR to initiate glue synthesis.

Following the logic that another receptor is functioning with EcR in 20E-mediated glue synthesis, I investigated other candidate receptors. I found the nuclear receptor, DHR96, to be required for glue synthesis and performed experiments that suggest DHR96 may work with EcR to initiate glue synthesis in response to a 20E signal.

The remaining sections of my dissertation are focused on the latter half of the third instar. This stage of the larval life cycle is the late-third instar and is marked in the salivary gland by the secretion of mature glue granules into the lumen of the gland in response to a large pre-metamorphic pulse of 20E. During this period, 20E initiates the expression of proteins that are mostly transcription factors; however, a gene was identified that had sequence similarity to both calmodulin and myosin light chains. This gene, E63-1, has been shown to trigger precocious glue secretion in glands overexpressing E63-1. However, E63-1 mutants secrete glue normally. Interestingly, calmodulin has been shown to prevent glue secretion in experiments using calmodulin inhibitors. These data provoked a model that E63-1 and calmodulin are both needed for

secretion to be successful. The goal of chapter 4 was to test this model using available molecular and genetic tools.

Finally, I analyze a secretion phenotype caused by the overexpression of GDP dissociation inhibitor (GDI) that produces rubble-like glue granules, which do not secrete. Part of this analysis involved describing the localization and morphology of wildtype cells using fluorescently tagged markers. When I compared the markers from the wildtype cells to those overexpressing GDI, I found a number of cellular disruptions. GDI overexpression caused an extension of ER membrane, a failure of membrane recycling and a failure for the glue granules to acidify.

Thus, through the use of molecular and genetic tools, I characterize 20E-signaling events in the third instar salivary gland, and more importantly, I lay the foundation to test novel models of 20E signaling and intracellular trafficking mechanisms.

ACKNOWLEDGEMENTS

I would like to thank the members of my committee, Frank van Breukelen, Allen Gibbs, Ron Gary, J. Steven deBelle, and Jeff Shen for their guidance and expert advice in directing this research. I especially would like to acknowledge my dissertation advisor, Andrew Andres, for challenging me to not only understand mercury poisoning, but the connection it has with the French fur trade between the 1650's and 1850's. As cognitively cunning as David Hume, Andy is the quintessential skeptical empiricist that took a chance on me, a *flâneur* student of philosophy, and shaped me into a critical thinking man of science. He is a man that commands my respect and admiration, and most of all my sincere gratitude for his support.

My lab experience was accented by relationships made with fellow grad students and lab members. I would like to extend my appreciation to those people. Randy Boyles was a fellow Andres Lab grad student and my co-conspirator. We spent time discussing our successes and failures in the lab, and also plotted ways to escape graduate school. He was a valuable resource who helped troubleshoot issues with kits that would eventually be reconciled using “old school” methods. Chris Tabone helped me to release stress using the power of computing and World War II simulation video games. A fellow East Coaster, we consoled each other about grad school politics and spent time reminiscing about the best pubs in NYC. I would like to acknowledge Dan Bricker for being an exceptionally gifted undergraduate researcher and good friend. His help with the glue synthesis study was invaluable and his dedication to science is remarkable. A note of thanks to Juan Duhart who despite his med school ambitions, has an incredible acumen for science. His support extended beyond the lab and has become a great friend.

A most heartfelt thank you goes to Elana Paladino, the Marie Curie to my Pierre. As my girlfriend and fellow lab member we shared scientific, spiritual and personal growth together. Elana truly is my better half; she is equipped with the patience and temperament of a monk and has a sharp critical mind capable of comprehending the most esoteric knowledge. Her love and support will continue to be cherished. Inherently a good soul, the encouragement she provided through the toughest times remains in my heart as perpetual wisdom. I look forward to our life together and hope to give her the same love and support.

I would like to thank my parents, Donald and Genevieve, for their unconditional love and support. My parents were my spiritual and financial collaborators during my time at graduate school and the only result they expected was my happiness. I hope to make them proud and I love them. My sister Gabrielle, who always knew I was a little odd, but still loves me. Also, I want to thank my brother Alexander who simultaneously attended graduate school and could effectively translate my joy and frustration to the rest of the family.

Thanks also to Jerrel Aguila, Nichole Bond, Stephanie Georges, Katie Lantz, Aaron Payette, Wendy Seto, and Brian Smith for becoming confidants and whose friendship has been rewarding. Also to Paul Schulte, Sean Neiswenter, Keala“Ala” Kiko, Marty Schiller, and Dennis Bazylinski, the UNLV ad hoc beer (snob) committee. Cheers!

TABLE OF CONTENTS

ABSTRACT.....	iii
ACKNOWLEDGEMENTS.....	vi
LIST OF TABLES.....	x
LIST OF FIGURES.....	xi
CHAPTER 1 INTRODUCTION.....	1
1.1 Nuclear receptors.....	1
1.2 The ecdysone receptor and insect hormone 20- hydroxyecdysone	7
1.3 20-hydroxyecdysone.....	21
1.4 Ecdysone regulated genes in the larval salivary gland	27
1.5 E63-1 and calmodulin.....	31
1.6 Myosin motor proteins.....	32
1.7 Why the salivary gland?	33
1.8 References	36
CHAPTER 2 STEROID REGULATED GLUE SYNTHESIS, A PROCESS INVOLVING A NOVEL ECDYSONE RECEPTOR	41
2.1 Introduction	41
2.2 Material and methods.....	44
2.3 Results.....	50
2.4 Discussion.....	81
2.5 References	88
CHAPTER 3 IDENTIFICATION OF A NOVEL ECDYSONE RECEPTOR REQUIRED FOR GLUE SYNTHESIS	94
3.1 Introduction	94
3.2 Materials and methods	98
3.3 Results.....	102
3.4 Discussion.....	124
3.5 References	128
CHAPTER 4 THE REQUIREMENT FOR BOTH THE CALCIUM BINDING PROTEIN E63-1 AND CALMODULIN IN GLUE SECRETION	130
4.1 Introduction	130
4.2 Materials and methods	132
4.3 Results.....	136
4.4 Discussion.....	154
4.5 References	160

CHAPTER 5 THE SALIVARY GLAND CAN BE USED TO STUDY INTRACELLULAR TRAFFICKING	163
5.1 Introduction	163
5.2 Materials and methods	165
5.3 Results	167
5.4 Discussion.....	185
5.5 References	187
CHAPTER 6 GENERAL DISCUSSION.....	188
6.1 Introduction	188
6.2 Summary of the glue synthesis model	188
6.3 Summary of the glue secretion model.....	190
6.4 The salivary gland as a model tissue to study intracellular trafficking.....	191
6.5 References	193
VITA.....	194

LIST OF TABLES

Table 1-1 The 21 nuclear hormone receptors in <i>Drosophila melanogaster</i>	6
Table 2-1 Overexpressing USP blocks the synthesis of glueRED.....	70
Table 3-1 A list of the nuclear receptors in <i>Drosophila</i> and VDRC stock numbers used in an RNAi screen for a block in glue synthesis	104
Table 3-2 Overexpressing EcR isoforms do not rescue the block in glue synthesis.....	116
Table 3-3 Broad complex overexpression rescues the block in glue caused by DHR96i.....	119
Table 4-1 RNAi lines directed against <i>Drosophila</i> myosin genes collected and tested in this work	133
Table 4-2 Genotypes of flies compromised for Cam and E63-1 proteins.....	135
Table 5-1 Fluorescent labeled markers used in identifying cellular structures	166

LIST OF FIGURES

Figure 1-1 A schematic nuclear receptor domains.....	4
Figure 1-2 A broad-view of the 20-hydroxyecdysone genetic hierarchy.....	9
Figure 1-3 The domain organization of EcR, USP and DHR96.....	13
Figure 1-4 An amino acid comparison of sequence similarity between DHR96 and the vertebrate homolog, vitamin D receptor DNA binding domain.....	17
Figure 1-5 An overview of the “ends-in” site-directed mutagenesis technique used to generate DHR96 mutant flies	19
Figure 1-6 20-hydroxyecdysone stereo chemical structure compared.....	22
Figure 1-7 20-hydroxyecdysone titers in the third instar larva.....	25
Figure 1-8 Confocal images of the salivary gland taken at different time points in the third instar.....	29
Figure 2-1 Glue genes are induced by 20E in cultured glands	52
Figure 2-2 <i>sgGal4</i> , a <i>GawB</i> -derived driver, has an expression pattern restricted to the salivary glands during larval stages	56
Figure 2-3 20E-mediated glueRED induction requires functional EcR proteins	59
Figure 2-4 Any isoform of EcR or BRC is sufficient to induce glueRED synthesis.....	62
Figure 2-5 EcR, but not USP, is needed for glue synthesis.....	67
Figure 2-6 Silencing USP in the salivary gland does not block glueRED synthesis.....	71
Figure 2-7 Western blot analysis comparing USP levels derived from different transgenic stocks.....	77
Figure 2-8 Overexpressing USP blocks the synthesis of glue proteins.....	79
Figure 3-1 Using RNAi to silence DHR96 in the salivary gland blocks glue synthesis	105
Figure 3-2 DHR96 immunohistochemical stain	109
Figure 3-3 Western blot of DHR96i salivary glands.....	111
Figure 3-4 qRT-PCR levels of HR96 RNA in wildtype cells vs. cells expressing HR96i	113
Figure 3-5 Overexpressing DHR96 in the late third instar blocks glue secretion	122
Figure 4-1 Genes tagged with GFP can be silenced with an RNAi construct against GFP	138
Figure 4-2 Glue secretion is partially blocked when Cam and E63-1 are compromised in the late larval salivary glands	141
Figure 4-3 <i>E63i</i> efficiently silences the endogenous <i>E63-1</i> gene.....	144
Figure 4-4 Secretion is inhibited when both Cam and E63-1 are silenced in the salivary gland during the entire larval period.....	148
Figure 4-5 Driving <i>AM8-2</i> in larval salivary glands blocks glue secretion.....	151
Figure 4-6 Sequence comparison of E63-1, calmodulin and Androcam.....	155
Figure 5-1 Confocal images of the molecular markers used to study secretion.....	168
Figure 5-2 Overexpression of GDI causes misshapen granules that fail to secrete.....	176
Figure 5-3 Western blot analysis of genetic reagents that affect GDI levels	178
Figure 5-4 Overexpression of GDI causes expansion of the ER.....	181
Figure 5-5 Granules fail to acidify when GDI is overexpressed	183

CHAPTER I

INTRODUCTION

1.1: Nuclear Receptors.

Small lipophilic hormones such as steroids, retinoids, thyroid hormones and vitamin D were first isolated and evaluated in the beginning of the twentieth century. However, it was unclear how these molecules functioned until Jensen and Jacobsen observed radiolabeled estradiol would translocate from the cytoplasm to the nucleus in target tissues and remain unmodified. Further, radiolabeled estradiol would complex with proteins in the nucleus in sucrose-density sedimentation experiments [1, 2]. These early findings were important, because they helped to establish a link between the control of transcription and the activity of a hormone. To further support this link, the Ashburner lab demonstrated that the insect hormone, 20-hydroxyecdysone, would trigger the formation of chromosomal puffs on polytenized chromosomes, indicating regions of 20E responsive gene activity [3]. The above are key studies leading to the current model that the nuclear receptor superfamily are ligand regulated transcription factors. This special family of receptors are essentially an efficient single step mechanism to transduce and amplify a lipophilic hormone signal that genetically reprograms target tissue cells.

Since then, we have more insight into the function of nuclear hormone receptors and evidence that they are the key regulators of growth, development and maturity of all vertebrates and some classes of sponges [4]. Nuclear receptors can function as either homodimers or heterodimers. An example of nuclear receptor homodimer activity is the glucocorticoid receptor (GR), first cloned by the Evans lab [5]. GR has been shown in vertebrates to bind ligand in the cytoplasm, homodimerize and then translocate into the

nucleus to regulate target gene expression. It was thought that nuclear receptors that function as heterodimers, such as thyroid receptor (TR) or retinoic acid receptor (RAR), must dimerize with a retinoid X receptor (RXR). However, some recent evidence supports an alternative to the RXR heterodimer; suggesting that a TR/RAR heterodimer has a distinct biological function [6]. Some nuclear receptor heterodimers repress gene transcription when not associated with ligand and are bound to DNA complexed with a co-repressor [4]. When a ligand binds the receptor the co-repressor dissociates and a co-activator is recruited. Thus, the nuclear receptor does not translocate upon ligand binding and instead has a gene-repressive function.

Nuclear receptors have distinct domains common to the entire super family: transactivating domain(A/B), DNA binding domain (C), hinge region (D), and ligand binding domain (E/F) (Fig. 1-1A). The E/F domain is also the site of transcriptional activation (AF-2) and possibly dimerization [7]. Although no function for the F domain has been elucidated, studies of the mammalian estrogen receptor (ER) show that the deletion of the F domain confers an agonist activity to tamoxifen and also an increase in dimerization in HeLa, MCF-7 and CHO cell lines, but not in 3T3 cells [8]; suggesting a tissue specific regulatory role for the F domain in estrogen receptors. All nuclear receptors contain two zinc finger domains in the C domain that are capable of binding a target sequence on the DNA or a hormone response element (HRE) (Fig. 1-1B). The HRE is part of the gene promoter and is primarily two hexameric, half-site sequences configured as palindromes, inverted repeats or direct repeats [9]. Because of the important roles in the success of animal development, these receptors have changed little evolutionarily and as-such are highly conserved throughout the animal kingdom.

Interestingly, while all receptors share sequence homology, cognate ligands have not been found for all nuclear receptors. Nuclear receptors with no known ligand are referred to as orphan receptors. In *Drosophila*, there are 21 known or putative nuclear hormone receptors, based on sequence homology (Table 1-1). Surprisingly, only EcR and E75 have known ligands, 20-hydroxyecdysone (20E) and heme respectively [10], although, recent experimental evidence has shown that cholesterol may bind to DHR96 to regulate cholesterol metabolism [11]. The haemolymph of *Drosophila* is rich with ecdysteroid metabolites, some of which are only present at certain developmental times. This lends a valuable opportunity to discover ligands for orphan receptors and potentially explain the mechanism behind temporal and spatial hormone responses in target tissues.

Figure 1-1: A schematic of nuclear receptor domains.

(A) The nuclear receptor super family have distinct domains. The A/B domain is a ligand independent transactivating domain. The C domain contains two zinc finger domains that bind target sites on DNA (shown in B). The D domain is a hinge region. The E/F domain forms the ligand binding allosteric site and the E domain is also the site of transcriptional activation. It has been suggested that the E/F domain may also be the site of dimerization.

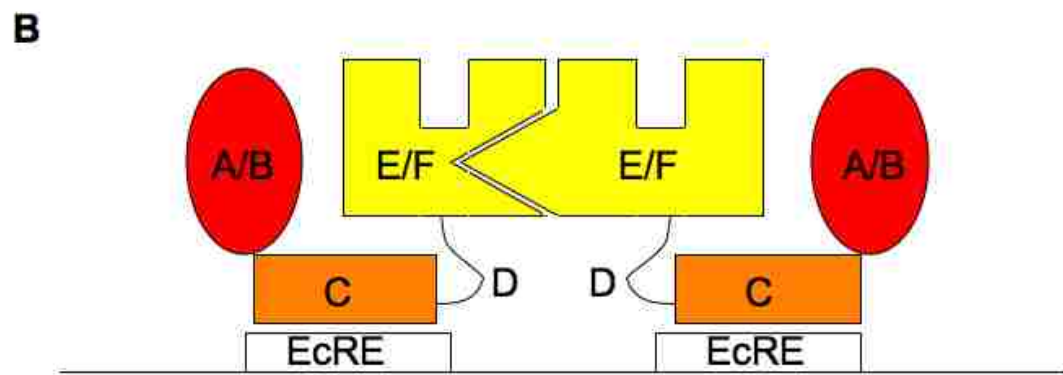
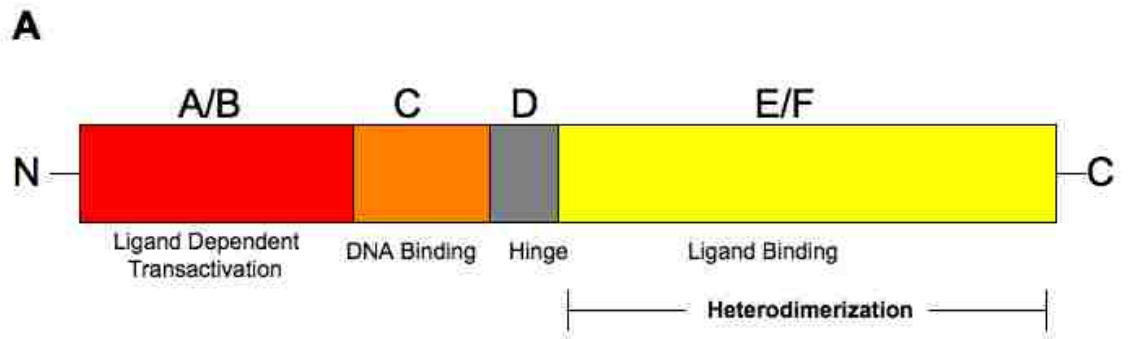

Table 1-1: The 21 nuclear hormone receptors in *Drosophila melanogaster*.

Gene Symbol	Synonyms	Chromosome	Isoforms	Cyto Location
EcR	<i>CG1765</i>	2R	5	42A9-42A12
HR39	<i>Cg8678</i>	2L	4	39B4-39C1
Eip75B	<i>E75</i>	3L	4	75A10-75B6
HR46	<i>DHR3</i>	2R	3	46F5-46F7
CG16801	<i>PNR, HR51</i>	2R	3	51F7-51F7
svp	<i>NR2F3</i>	3R	3	87B4-87B5
ttl	<i>NR2E2</i>	3R	1	100A6-100A6
Hnf4	<i>Hematocyte Nuclear Factor4</i>	2L	3	29E4-29E4
Hr38		2L	2	38D5-38E3
USP	<i>NR2B4</i>	X	1	2C7-2C7
ERR	<i>Estrogen Related Receptor</i>	3L	2	66B11-66B11
Eip78C	<i>E78</i>	3L	3	78C2-78C3
dsf	<i>dissatisfaction</i>	2L	1	26A1-26A2
ftz-F1		3L	2	75D8-75E1
HR78		3L	4	78D4-78D4
HR96	<i>NRIJ1</i>	3L	1	96B16-96B17
CG10296	<i>Fax1, HR83</i>	3R	1	83E4-83E4
HR4	<i>GRF</i>	X	1	2C1-2C1
Knrl	<i>Knirps like</i>	3L	1	77D4-77E1
Kni	<i>Knirps, NR0A1</i>	3L	1	77E3-77E3
Eg	<i>Eagle</i>	3L	2	78F2-78F3

* These receptors were identified using the PSI-BLAST algorithm.

1.2: The Ecdysone Receptor and Insect Hormone 20-hydroxyecdysone.

Ashburner in 1974 performed classic experiments on 20E gene regulation by observing chromosomal puffs on explanted *Drosophila* larval salivary glands in culture supplemented with the hormone [12]. These puffs were an indication of 20E induced gene activity and grouped into a hierarchical set of genes known as early and late response genes. The original Ashburner model of genetic control of 20E was that 20E would bind its hypothesized target receptor and regulate genetic transcription by directly inducing the early genes and repressing late genes (Fig. 1-2). The early genes encoded transcription factors that would have differential secondary functions either suppressing early gene function or inducing late gene expression.

When molecular cloning became available, Koelle *et al.* [13] identified the steroid receptor EcR as the hypothesized target receptor in Ashburner's model and performed experiments that provided valuable insight as to the characteristics of EcR. From Koelle *et al.* we learned that EcR has an 850-fold sequence specific DNA binding preference to an ecdysone regulatory element (*EcRE*) on DNA. Also, it was shown that 20E binding activity was not observed in cell lines or embryonic extracts treated with anti-EcR to remove EcR protein. Additionally, ecdysone responsiveness measured by an EcRE-lacZ reporter activity was absent in S2 cell lines deficient in the EcR protein, but EcRE-lacZ activity was restored upon the transfection of the cells with EcR expression plasmids [13]. Koelle did not demonstrate clearly, however, that the 20E response is conferred through EcR alone. Citing the lack of purified EcR protein in the above experiments, Koelle *et al.* do not claim that EcR is sufficient to convey the 20E response and hypothesize that a complex of receptors may be involved in *in vivo* 20E gene regulation.

Powerful genetic tools allowed for the identification of more nuclear receptors in *Drosophila*. Of these, ultraspiracle (USP) was of great interest. USP is the vertebrate RXR homolog exhibiting more than 86% amino acid similarity in the DNA-binding domain and 49% in the ligand binding domain [14]. Because of the amino acid similarities, it is reasonable to expect that function has been conserved between species and, like the vertebrate RXR homolog, can form heterodimers with other nuclear receptors. Research done by Yao *et al.* has shown that the 20E response in fact does depend on the heterodimerization of EcR and USP [15]. Binding was demonstrated by USP antibody supershift of the specific *EcRE* DNA sequence. In addition, mixing purified EcR and USP proteins increased the affinity to binding the *EcRE* compared to individual proteins [15]. In light of this evidence, the Ashburner model was refined to include 20E signaling occurring through a functional ecdysone receptor consisting of an EcR/USP complex. However, the availability of orphan receptors in these target tissues and the recent finding that not all 20E responses are dependent on USP [16] have led to a rethinking of the model altogether.

Figure 1-2: A broad view of the 20-hydroxyecdysone genetic hierarchy.

The original model of genetic control of 20E was that 20E would bind to a target receptor and regulate transcription directly by activating early genes. These early genes would in turn activate late genes and suppress additional early gene activation.

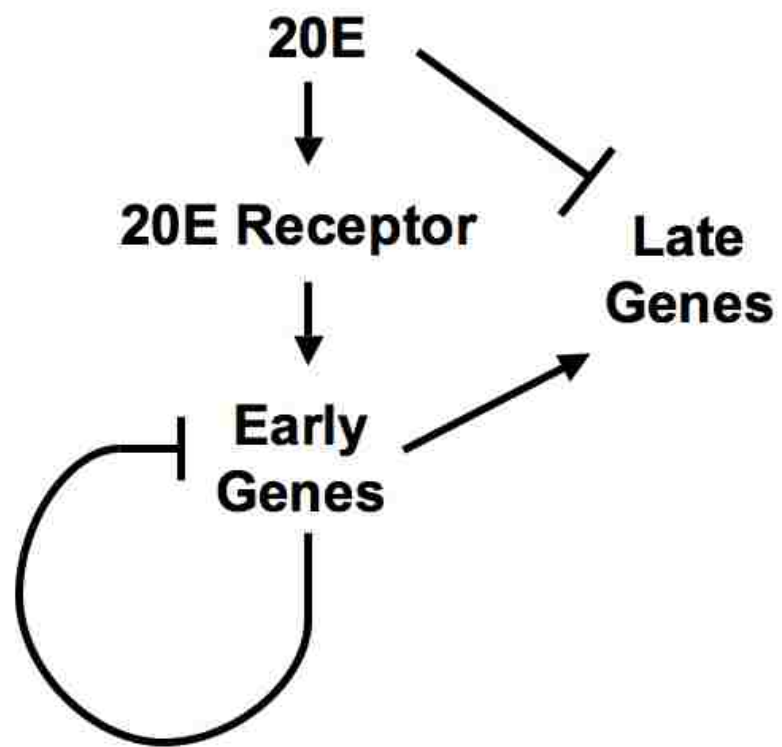

There are three isoforms of EcR; EcR-A, EcR-B1 and EcR-B2 with different lengths and sequences of the N-terminal A/B domain, but conserved DNA binding C domains (Fig. 1-3). EcR-A and EcR-B1 are encoded by overlapping transcriptional units and are controlled by different promoters. EcR-B2 is a splice isoform of the transcript encoded by the EcR-B1 transcriptional unit [17]. It has been suggested that these three isoforms have distinct functions and are not interchangeable, because neither EcR-A nor EcR-B2 overexpression could rescue early gene repression in EcR-B1 mutant salivary glands; only overexpressing EcR-B1 returned the early and late genetic hierarchy to wildtype levels [18]. Additionally, while all isoforms can rescue larval development in EcR homozygous mutants, EcR-B2 is the most efficient [19]. Further experiments showed that distinct EcR isoforms were present in varying morphological stages and cause lethal phenotypes at different stages [20], suggesting different isoforms can contribute to the diversity of the 20E response.

During development and before the onset of metamorphosis, USP is expressed in all tissues, though at varying times [21, 22]. When USP partners with EcR, the heterodimer of EcR/USP is able to induce the expression of many genes required for metamorphosis [23]. However, USP is considered to have promiscuous binding properties. For example, USP can function by dimerizing with different receptors. An example of USP promiscuity was demonstrated by Sutherland *et al.* 1995, who show that USP can heterodimerize with hormone receptor 38 (DHR38) and act to regulate ecdysone levels in target tissues. DHR38 competes *in vivo* with EcR for USP binding and can limit the expression of ecdysone-regulated genes [24]. Because USP is promiscuous, it stands to reason that other nuclear receptors may possess similar promiscuous characteristics and a

hypothesis can be drawn that perhaps temporal and spatial regulation of 20E occurs via a promiscuous ecdysone receptor. Experiments that closely examined the EcRE help to support such a hypothesis.

One ecdysone receptor binding site (EcRE) was elucidated by Antoniewski to be a palindromic inverted repeat separated by a nucleotide consensus sequence: 5'-PuG(G/T)T(C/G)A(N)TG(C/A)(C/A)(C/t)Py-3' [25]. The best-characterized EcRE is the conserved half site, AGGTCA, of the heat shock protein 27 (hsp27) promoter. The EcR/USP heterodimer can bind direct repeats of AGGTCA separated by 1-5 nucleotides with various affinities [26]. Interestingly, research into EcRE binding has shown that three other receptors, DHR38, DHR78, and DHR96, can also bind either the hsp27 EcRE or other EcRE sequences [27]. One can imagine yet another model of temporal and spatial regulation that involves crosstalk between these receptors and EcR or USP at EcRE sequences upstream of target genes to direct distinct 20E responsiveness in target tissues. The most promising of these receptors is DHR96.

Figure 1-3: The domain organization of EcR and USP.

Three isoforms of EcR differ in the length of their A/B domain. USP shares similarity to EcR in all domains except the A/B domain. The amino acid lengths of the EcR isoforms A/B domains are shown.

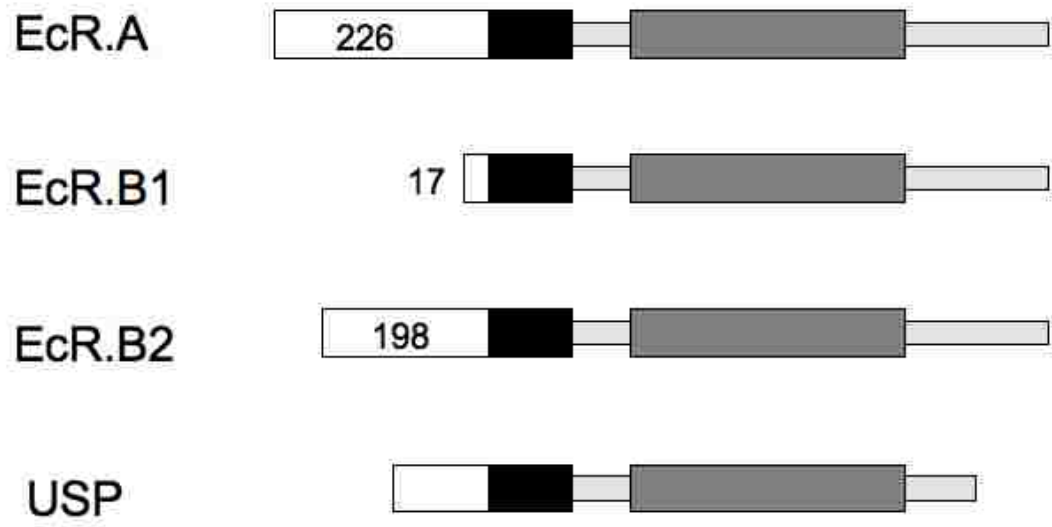

The *Drosophila* hormone receptor 96 (DHR96) is a strong candidate to be part of the ecdysone receptor complex, forming a heterodimer with EcR to temporally regulate the 20E response. DHR96 recognizes the same AGGTCA half sequence as the EcR/USP complex as demonstrated in gel shift assays [27]. Additionally, and most importantly DHR96 is thought to be 20E-inducible because it has a temporal expression profile correlating to times of 20E exposure [27].

The DHR96 gene codes for a 2.8 kb transcript that is expressed throughout the third instar larva and codes for a protein that has 64% amino acid similarity to the vertebrate vitamin D receptor DNA binding domain (Fig. 1-4). DHR96 is 20E inducible in cultured larval organs and is distinctly expressed in larval fat body, Malpighian tubules, midgut gastric caecae and the larval salivary gland. With the exception of the salivary gland, DHR96 expression is limited to tissues known to monitor and metabolize xenobiotics [28]. Homozygous *DHR96* mutant flies show a downregulation of xenobiotic genes: *CG4500*, *acyl-CoA synthetase*, *Turandot* gene family members *TotM* and *TotX*, *Jonah*, and *sugarbabe*. The downregulation of these genes by DHR96 makes the fly more sensitive to phenobarbital and the insecticide DDT [28] making a strong case for DHR96 being a xenobiotic regulatory receptor. Yet, the function of DHR96 in the salivary gland remains unknown.

More DHR96 research by Sieber and Thummel demonstrate that *DHR96* null mutants reduce the levels of triacylglycerol (TAG) in the midgut and the mutants are more sensitive to starvation [29]. Furthermore, mass spectrometry analysis identified cholesterol as a target ligand for DHR96. *DHR96* mutants cause an accumulation of excess cholesterol on high cholesterol diets and lethality on low cholesterol diets [11].

Taken together, the role of DHR96 in the fat body, Malpighian tubules, and midgut is to metabolize xenobiotics or to sense and maintain cholesterol homeostasis.

One potential problem of the above studies of *DHR96* mutants is the use of an “ends in” site-directed mutagenesis technique to generate a DHR96 mutant [30] (Fig. 1-5). This method can be used to create a loss of function mutant of gene of interest using homologous recombination to introduce deletions. In the case of the *DHR96* mutant, the donor DNA contained a deleted exon. Southern blot analysis on the mutant confirmed the deletion, but whether the presence of a single deletion is enough to cause a genetic null is still debatable. I have analyzed the mutant in PCR fragment studies and can confirm that the fourth exon is absent; however, western blots using polyclonal antibodies generated for DHR96 indicate the presence of additional low molecular weight bands. This could suggest a truncated form of the protein being expressed that may still harbor a function and could be enough to influence a heterodimeric partner binding to EcR or 20E.

Figure 1-4: An amino acid comparison of sequence similarity between DHR96 and the vertebrate homolog, vitamin D receptor DNA binding domain.

Comparing the DNA binding domain of DHR96 with the vertebrate homolog vitamin D receptor in clustalW. Amino acid residues are colored accordingly: yellow represents proline, orange represents glycine, red represent basic residues, purple represent acidic residues, blue represent small hydrophobic residues, green represent basic residues with hydroxyl and amine groups. The quality of the sequence identity is shown. Highly conserved sequences are ranked higher and less conserved sequences are ranked lower. Below in black is the consensus match.

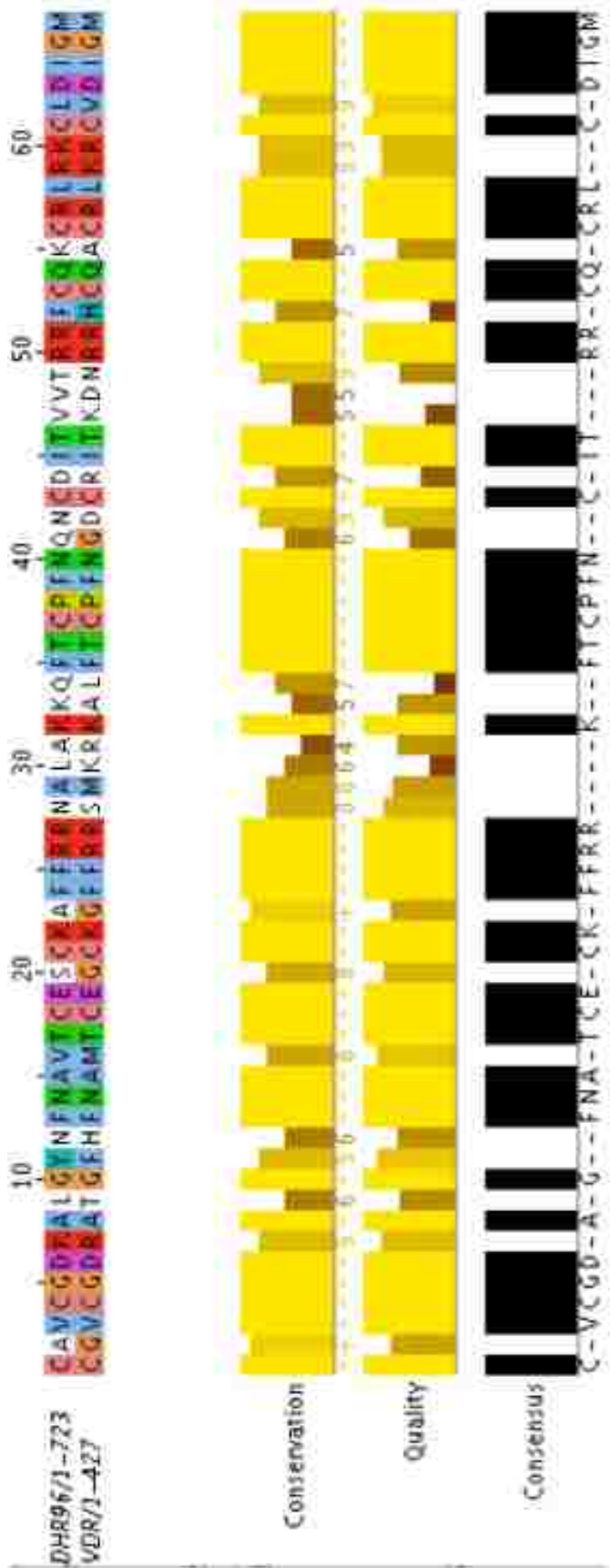
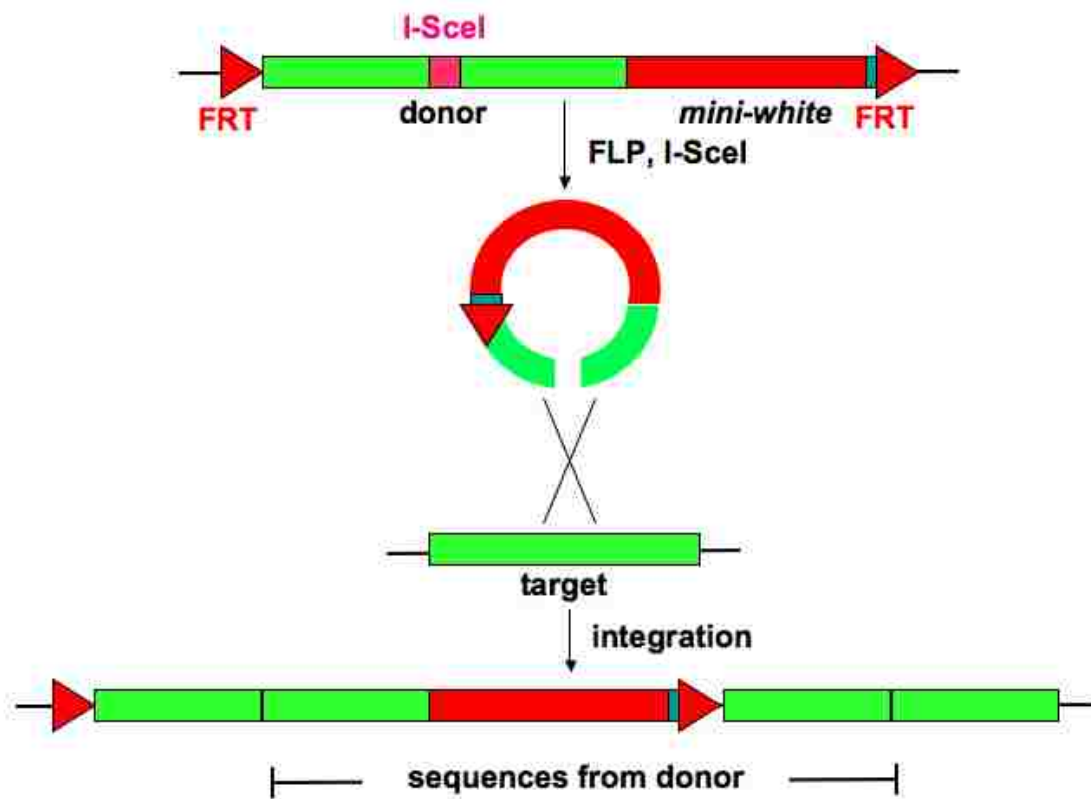

Figure 1-5: An overview of the “ends-in” site-directed mutagenesis technique used to generate DHR96 mutant flies.

A transgene that expresses a site-specific recombinase, a transgene that expresses a site-specific endonuclease, and a transgenic donor construct that carries recognition sites for both enzymes and DNA from the locus to be targeted. Flies with all three parts are generated, and expression of the enzymes are induced by heat-shocking the flies. The concerted action of these two enzymes produces an extrachromosomal recombinogenic donor DNA molecule in the cells of these flies. Progeny with gene-targeting events can be recovered by test-crossing. This gene-targeting technique provides a way to mutate genes that are identified only by sequence, and then to analyze their functions.



1.3: 20-hydroxyecdysone.

20-hydroxyecdysone (20E) is a 27-carbon polar steroid hormone derived from cholesterol that directs the development of all insect tissues. Cholesterol is formed from phytosterols that come from the insect diet, and is then converted to α -ecdysone in the prothoracic cells of the ring gland of the larva [31]. Circulating α -ecdysone is further processed to 20E in the fat body by a p450 monooxygenase enzyme coded by the gene *shade* that functions to hydroxylate ecdysone at carbon 20 [31] (Fig. 1-6 red arrow). While it has been suggested that α -ecdysone itself may function as a hormone [32, 33], 20E has been confirmed to be the major “molting” hormone in *Drosophila*.

Structurally, 20E is a sterol with similarities to the mammalian steroid hormones such as estradiol and testosterone. Unlike the mammalian steroids however, 20E is heavily hydroxylated; the molecule contains a 3β -OH, that is present in the sterol precursors, and also includes hydroxylation of the steroid nucleus and side chain. Although these additional hydroxylations make 20E highly water-soluble, the current model of 20E transport into cells is via passive diffusion.

Figure 1-6: 20-hydroxyecdysone stereochemical structure compared with estradiol and testosterone.

20E is similar to mammalian steroids like estradiol and testosterone. 20E is synthesized from a cholesterol precursor to an α -ecdysone form that is then hydroxylated at the carbon 20 (red arrow) in the larval fat body and other peripheral tissues by the p450 monooxygenase enzyme, Shade.

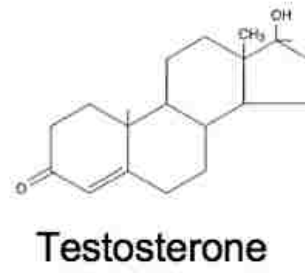
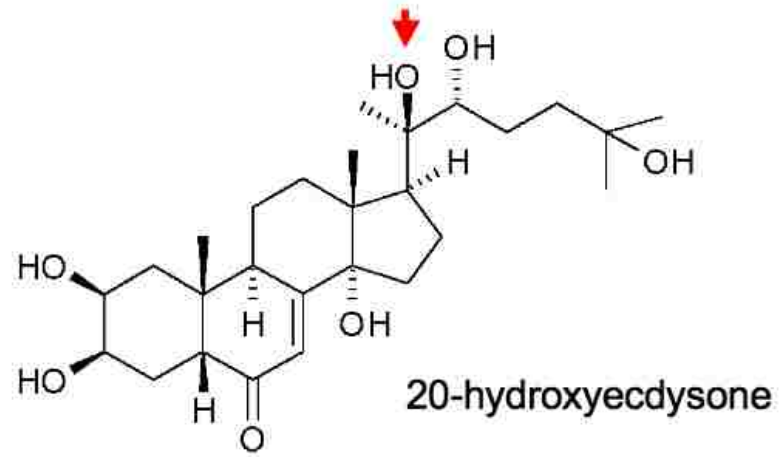

Throughout the life cycle of *Drosophila*, successful development of *Drosophila* is dependent upon specific temporal changes in the titer of 20E. For example, a high titer of 20E must be present between instars in order for the insect to molt and generate a new cuticle. Also, in the third instar, changing temporal pulses of 20E initiate a complex hierarchy of gene expression that includes early primary response genes that activate secondary response genes required for metamorphosis [3]. Historically, the pulses of 20E occurring in the third instar have been correlated to specific changes in the polytenized chromosomes in the form of puffs that are indicators of gene activity [34]. It was the observation of these puffs that originally outlined a hierarchical model of gene expression in response to the temporal pulses of 20E. Recently, the exact titers of 20E in the third instar have been measured by Warren *et al.* 2005 [35] allowing for a more detailed look at the molecular biology occurring in response to these temporal changes and how these genes coordinate tissue specific cellular events in response to a 20E signal. Warren *et al.* 2005 determined the whole body concentrations of 20E throughout the third-instar larva using a combination of High Performance Liquid Chromatography (HPLC) and radioimmuno-assay analysis; the results shown in Figure 1-7 indicate the concentration of 20E (in picograms per animal) of the distinct temporal pulses found in the third instar (Fig. 1-7 [35]). The important peaks relative to glue synthesis and secretion start at 16 hrs and 32 hrs after the last molt, and have a molar concentration of $1.8 \times 10^{-8} \text{M}$ and $1.2 \times 10^{-7} \text{M}$ per animal respectively (Costantino unpublished). Drawings of the salivary glands physiological response from the different 20E titers are shown in Figure 1-7.

Although the concentration of 20E was determined in whole animals, one might expect specific tissues to have varying exposures to the sterol depending on cell specific

Figure 1-7: 20-hydroxyecdysone titers in the third instar larva.

Shown is an image redrawn from Warren *et al.* 2006 [34] that has been modified to include the physiological events of the salivary gland. After a small increase in the systemic titer of 20E in the mid-third instar, the salivary gland begins to synthesize glue (yellow). The next high titer pulse of 20E initiates the secretion of the glue into the lumen of the gland and finally the gland is histolyzed.

L2 | **Third-Instar Larva (L3)** | **Prepupa** | **Pupa**

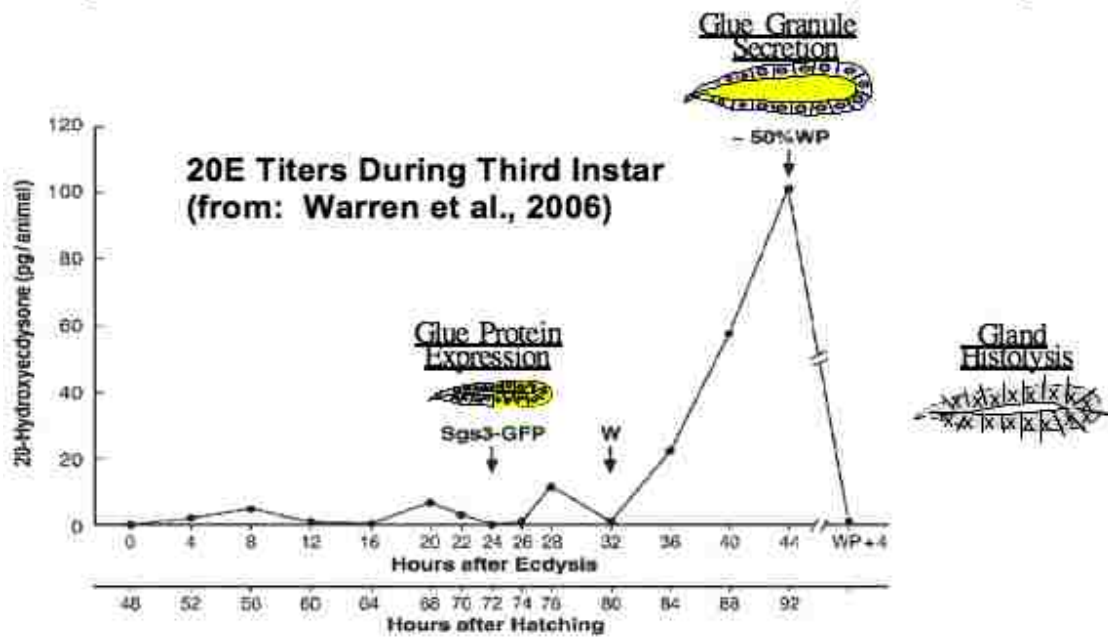

20E regulatory mechanisms. However, the peaks correlate nicely with previous chromosomal puff studies done in the larval salivary gland and therefore make the gland an important model tissue to study the mechanisms of the 20E response.

1.4: 20E-Regulated Genes in the Salivary Gland.

The major role of the third-instar salivary gland is to synthesize secretory polypeptides, known as the glue proteins, and then secrete the glue mixture onto a solid surface to secure the animal for pupariation and metamorphosis. As the animal pupariates the salivary gland enters programmed cell death that will effectively destroy the larval gland and allow the adult organ to develop in its place. These events are carefully coordinated by gene products that are expressed in a hierarchical fashion in response to the temporal changes in the 20E titer. Figure 1-8 is a series of confocal images taken at different time points throughout the third instar of the salivary gland. In these images glue is tagged with a fluorescent protein (glueRED) and is first visualized in Fig. 1-8 B corresponding to 16 hours after the final molt and then secreted into the lumen of the gland in (C).

In the early-mid third instar, corresponding to 0-24 hrs after ecdysis (last larval molt), the low titer pulse of 20E induces the transcription of the genes: *Broad Complex (BR-C)*, *forkhead (fkh)*, *E23*, *Gld*, *IMP-L2*, *Pig-1*, *Uro*, *Lsp-1 α* , *Lsp-2*, *Adh*, *Fbp-2*, *E74* and *E75* [34]. Of these genes, *BR-C*, *fkh*, *E74*, and *E75* code for regulatory transcription factors; *E23* codes for an ATP-binding cassette (ABC) transporter family member; *Gld*, *Adh*, *Fbp-2* and *Uro* are enzymes; *IMP-L2*, is a secreted insulin-like protein; *Lsp-1 α* and *Lsp-2* are serum proteins; *Pig-1* is unknown. Followed by this low titer pulse, a robust secondary response involving the induction of the *sgs* genes (glue) occurs.

The proteins encoded by the *BR-C* transcriptional unit directly regulate glue gene expression. The BR-C proteins are transcription factors that are isoforms differing in zinc finger domains. Interestingly, *fkh* is expressed early in the third instar and acts as an inhibitor of programmed cell death (PCD) by inhibiting BR-C from activating PCD genes until *fkh* expression is suppressed in the late third instar and the larger premetamorphic pulse of 20E can initiate PCD [36]. In summary, two major functions of the salivary gland are initiated at the early-mid third instar and then suppressed by 20E at a later time.

In the late third instar salivary gland, a premetamorphic pulse of 20E induces the expression of a set of early genes coding for mostly transcription factors that inhibit more early gene expression or induce the expression of late genes. We are particularly interested in two 20E-inducible early genes expressed at this stage that are not transcription factors: the ABC transporter *E23* and a calcium binding protein *E63-1*. It is hypothesized that *E23* expression is linked to 20E induction as an intracellular regulator of 20E ([23], Paladino unpublished). It is at this stage (~40 hrs after the last larval molt) that the cells secrete the glue proteins synthesized at the early-mid third instar into the lumen of the gland. Secretion of glue is concurrent with 20E induction of *E63-1* and thus helps to shape a functional model for *E63-1* as a requirement for secretion to occur. The details of how these 20E-induced genes, *E63-1* in particular, can coordinate distinct temporal effects such as glue synthesis and secretion remain unknown. This dissertation aims to fill such gaps in our knowledge.

Figure 1-8: Confocal images of the salivary gland taken at different time points in the third instar.

Prior to the mid-third instar titer of 20E (A) the glands do not express glueRED, until they have been exposed to the mid-third instar 20E titer (B). As granules mature they are secreted in response to the high premetamorphic pulse of 20E (C) until emptied of glue cargo (D).

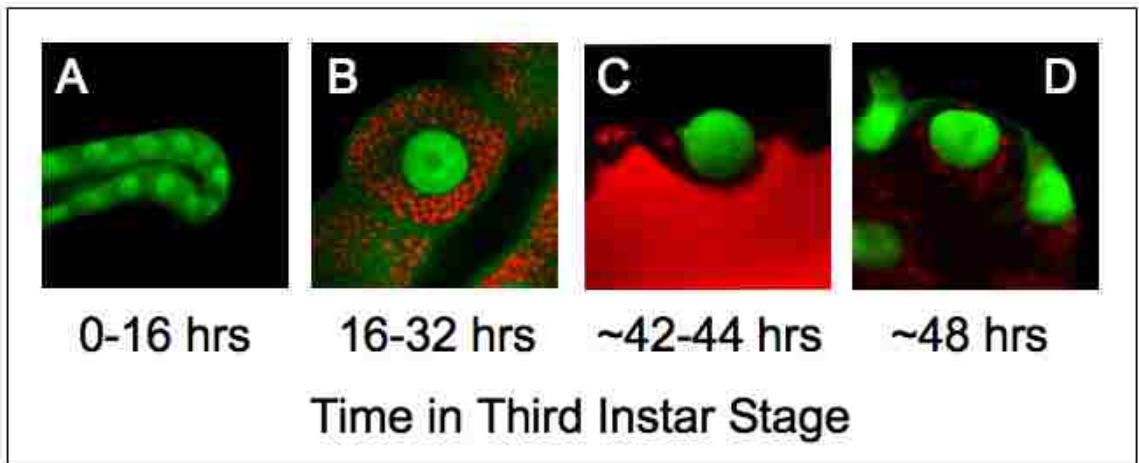

1.5: E63-1 and Calmodulin.

The E63-1 locus was an early puff originally described by Ashburner in 1974 and further elucidated by Andres and Thummel in 1995. The 63F puff corresponds to a locus containing two genes *E63-1* and *E63-2* that are induced directly by 20E in the presence or absence of cyclohexamide [37]. *E63-1* is temporally and spatially distinct from *E63-2*, in that it is expressed only in the late third instar salivary gland.

The *E63-1* ORF encodes a 22kD protein that has considerable sequence identity to calmodulin (CaM) and other myosin light chains (see chapter 4 Fig. 4-1). As expected, *E63-1* contains four EF hands grouped in pairs and are capable of binding Ca^{2+} *in vitro*. Ectopic expression of *E63-1* using a heat shock inducible form of *E63-1* leads to a precocious secretion of glue [38]. This, coupled with the similarity of *E63-1* to myosin regulatory light chains, suggests a model in which binding of *E63-1* to target myosin motor proteins can activate the motors and drive secretion of glue granule cargos.

CaM can also function as a light chain for many unconventional myosin proteins [39-41]. CaM binds to the IQ motif on unconventional myosin I in chicken intestinal epithelial brush border cells and acts as a myosin light chain [42, 43]. Since there is strong sequence similarity between *E63-1*, *Acam*, and CaM, we hypothesized that *E63-1* may affect glue secretion in the salivary gland by acting as a light chain for unconventional myosins, as described further in the next section. Moreover, *E63-1* ectopic expression can drive glue secretion, but *E63-1* null mutants fail to block secretion, leading us to predict that CaM has a redundant role with *E63-1* in the third instar salivary gland in which it to acts as a myosin light chain and contributes to the success of complete glue secretion.

1.6: Myosin Motor Proteins.

Spermatid individualization of *Drosophila* is regulated by the tissue-specific myosin light chain, androcam (Acam). Acam binds to and colocalizes with myosin VI in the larval testis and both are necessary components of the moving actin cone that rearranges the plasma membrane that form individual sperm. In the testis only androcam and not calmodulin coimmunoprecipitates with myosin VI and binds to the IQ motif and insert 2 of myosin VI [44]. The research into Acam function is important because it begins to build a foundation for a model describing a class of tissue-specific myosin light chains that can modify the behavior of unconventional myosin motor proteins. The model for Acam is testes specific and can easily be applied to other tissue specific myosin light chains like E63-1.

In *Drosophila*, the myosin superfamily consists of one conventional muscle myosin and 17 unconventional myosin heavy chains [45] which all share motor domain sequence similarity. Myosin heavy chain proteins are actin-based motor proteins that have such diverse roles as organelle/vesicle trafficking, structural maintenance, phagocytosis and cellular motility. Members of the myosin family contain an actin associated motor domain with catalytic activity and an alpha-helical domain that includes one or more IQ motifs, which are sites of regulatory light chain binding. Many of the myosin heavy chains have differing C-terminal tail domain that could imply specialization. These tail domains have been theorized to bind cargo or plasma membrane. I hypothesize that a myosin heavy chain is necessary to regulate the movement of secretory vesicles to the site of secretion.

1.7: Why the Salivary Gland?

To investigate steroid hormone signaling, I took advantage of a particular well-suited model tissue, the larval salivary gland of *Drosophila melanogaster*. Several key determinants argue that the *Drosophila* larval salivary gland has important molecular and genetic advantages over other tissues and these factors enable us to contribute considerably to our knowledge of hormone signaling and endocrinology. Among these factors include: a long history of research, a wide variety of available genetic and molecular tools, and the benefit of kingdom wide homology of the hormone signaling components.

The *Drosophila* larval salivary gland was initially described in 1939 and 1950 by Sonnenblick [46, 47]. The observation and identification of glue secretion at the end of the third instar was noted by Bodenstein in 1943 and 1950 [48, 49]. It was the work of Ashburner and his colleagues in the 1970's, however, that made clear the true potential of the salivary gland as a model tissue for nuclear hormone study. As previously shown in Figure 1-2, Ashburner and his contemporaries established a nuclear signaling hierarchy and meticulously catalogued cytological maps based on puffing of the polytenized chromosomes in response to 20E. The puffs contained important genes that have since been discovered, described, and verified, and continue to aid in describing a complete model of hormone signaling. The discovery and detailing of the 20E responsive puffs of the salivary gland nurtured innovative molecular and genetic tools to help investigate the 20E response.

Coupling the use of transgenic lines (containing fluorescent reporter genes) with transposon insertion has been vital to molecular genetic work in *Drosophila*. The most

widely used transgenic expression system is the Gal4/UAS binary expression system co-opted from yeast [50]. The Gal4/UAS system allows researchers to ectopically express target genes downstream of the *UAS* enhancer in a temporally and spatially specific manner using tissue specific drivers upstream of a *Gal4* coding sequence. In addition to these tools, the sequencing of the *Drosophila* genome has been completed and an effort has been made to tag each protein with a GFP (green fluorescent protein) marker by inserting the GFP gene as an artificial exon into all protein encoding genes [51]. Also, the Vienna Drosophila RNAi Center (VDRC) and the National Institute of Genetics in Kyoto, Japan (NIG-FLY) are continuing to develop *UAS-RNAi* lines for all known *Drosophila* genes, which would be a powerful tool to silence target gene function. These are just some of the important molecular and genetic tools we can use in the salivary gland to identify, silence, observe, and characterize important genes and proteins necessary for proper nuclear hormone signaling.

Finally, the salivary gland has three distinct physiological responses to a single hormone (20E): synthesis of glue, secretion of glue and programmed cell death of the tissue. These are all temporally regulated and have different nuclear receptor components associated with each activity. While glue secretion is mediated by EcR/USP heterodimer (FXR/RXR), we have shown that glue synthesis is independent of an RXR protein. This discovery challenges nuclear receptor signaling models established for all animals by showing a nuclear receptor heterodimer independent of an RXR component. Because the homology and sequence conservation between species is high and the ability to test these genes using a number of molecular tools, investigating 20E signaling in the

larval salivary gland is a valuable model tissue that has and will continue to shape a complete model for nuclear hormone signaling.

1.8: References.

1. Jensen EV, Jacobson HI (1962) Recent Progr. Hormone Res 18: 387.
2. Jensen EV, Suzuki T, Kawashima T, Stumpf WE, Jungblut PW, et al. (1968) A two-step mechanism for the interaction of estradiol with rat uterus. Proceedings of the National Academy of Sciences of the United States of America 59: 632.
3. Beermann W, Ashburner M (1972) Developmental studies on giant chromosomes. Springer.
4. King-Jones K, Thummel CS (2005) Nuclear receptors—a perspective from *Drosophila*. Nature Reviews Genetics 6: 311–323.
5. Mangelsdorf DJ, Thummel C, Beato M, Herrlich P, Schütz G, et al. (1995) The nuclear receptor superfamily: the second decade. Cell 83: 835–839.
6. Lee S, Privalsky ML (2005) Heterodimers of retinoic acid receptors and thyroid hormone receptors display unique combinatorial regulatory properties. Molecular Endocrinology 19: 863.
7. Gustafsson JA (1999) Estrogen receptor beta—a new dimension in estrogen mechanism of action. Journal of Endocrinology 163: 379.
8. Yang J, Singleton DW, Shaughnessy EA, Khan SA (2008) The F-domain of estrogen receptor-alpha inhibits ligand induced receptor dimerization. Molecular and Cellular Endocrinology 295: 94-100.
9. Aranda A, Pascual A (2001) Nuclear hormone receptors and gene expression. Physiological Reviews 81: 1269.
10. Reinking J, Lam MMS, Pardee K, Sampson HM, Liu S, et al. (2005) The *Drosophila* nuclear receptor e75 contains heme and is gas responsive. Cell 122: 195-207.
11. Horner MA, Pardee K, Liu S, King-Jones K, Lajoie G, et al. (2009) The *Drosophila* DHR96 nuclear receptor binds cholesterol and regulates cholesterol homeostasis. Genes & development 23: 2711.
12. Ashburner M, Chihara C, Meltzer P, Richards G (1974) Temporal control of puffing activity in polytene chromosomes. In: Cold Spring Harbor Symposia on Quantitative Biology. . p. 655.
13. Koelle MR, Talbot WS, Segraves WA, Bender MT, Cherbas P, et al. (1991) The *Drosophila* EcR gene encodes an ecdysone receptor, a new member of the steroid receptor superfamily. Cell 67: 59–77.

14. Oro AE, McKeown M, Evans RM (1990) Relationship between the product of the *Drosophila* ultraspiracle locus and the vertebrate retinoid X receptor. .
15. Yao TP, Segraves WA, Oro AE, McKeown M, Evans RM (1992) *Drosophila* ultraspiracle modulates ecdysone receptor function via heterodimer formation. *Cell* 71: 63–72.
16. Costantino BFB, Bricker DK, Alexandre K, Shen K, Merriam JR, et al. (2008) A Novel Ecdysone Receptor Mediates Steroid-Regulated Developmental Events during the Mid-Third Instar of *Drosophila*. *PLoS Genet* 4.
17. Talbot WS, Swyryd EA, Hogness DS (1993) *Drosophila* tissues with different metamorphic responses to ecdysone express different ecdysone receptor isoforms. *Cell* 73: 1323–1337.
18. Bender M, Imam FB, Talbot WS, Ganetzky B, Hogness DS (1997) *Drosophila* ecdysone receptor mutations reveal functional differences among receptor isoforms. *Cell* 91: 777–788.
19. Li T, Bender M (2000) A conditional rescue system reveals essential functions for the ecdysone receptor (EcR) gene during molting and metamorphosis in *Drosophila*. *Development* 127: 2897.
20. Schubiger M, Wade AA, Carney GE, Truman JW, Bender M (1998) *Drosophila* EcR-B ecdysone receptor isoforms are required for larval molting and for neuron remodeling during metamorphosis. *Development* 125: 2053.
21. Andres AJ, Fletcher JC, Karim FD, Thummel CS (1993) Molecular Analysis of the Initiation of Insect Metamorphosis: A Comparative Study of *Drosophila* Ecdysteroid-Regulated Transcription. *Developmental biology* 160: 388–404.
22. Henrich VC, Szekely AA, Kim SJ, Brown NE, Antoniewski C, et al. (1994) Expression and function of the ultraspiracle (*usp*) gene during development of *Drosophila melanogaster*. *Developmental biology* 165: 38–52.
23. Thummel CS (2002) Ecdysone-regulated puff genes 2000. *Insect biochemistry and molecular biology* 32: 113–120.
24. Sutherland JD, Kozlova T, Tzertzinis G, Kafatos FC (1995) *Drosophila* hormone receptor 38: a second partner for *Drosophila* USP suggests an unexpected role for nuclear receptors of the nerve growth factor-induced protein B type. *Proceedings of the National Academy of Sciences* 92: 7966.
25. Antoniewski C, Laval M, Lepesant JA (1993) Structural features critical to the activity of an ecdysone receptor binding site. *Insect biochemistry and molecular biology* 23: 105–114.

26. Antoniewski C, Mugat B, Delbac F, Lepesant J (1996) Direct repeats bind the EcR/USP receptor and mediate ecdysteroid responses in *Drosophila melanogaster*. *Mol. Cell. Biol.* 16: 2977-2986.
27. Fisk GJ, Thummel CS (1995) Isolation, regulation, and DNA-binding properties of three *Drosophila* nuclear hormone receptor superfamily members. *Proceedings of the National Academy of Sciences* 92: 10604.
28. King-Jones K, Horner MA, Lam G, Thummel CS (2006) The DHR96 nuclear receptor regulates xenobiotic responses in *Drosophila*. *Cell Metabolism* 4: 37–48.
29. Sieber MH, Thummel CS (2009) The DHR96 nuclear receptor controls triacylglycerol homeostasis in *Drosophila*. *Cell Metabolism* 10: 481–490.
30. Rong YS, Golic KG (2000) Gene Targeting by Homologous Recombination in *Drosophila*. *Science* 288: 2013-2018.
31. Petryk A, Warren JT, Marqués G, Jarcho MP, Gilbert LI, et al. (2003) Shade is the *Drosophila* P450 enzyme that mediates the hydroxylation of ecdysone to the steroid insect molting hormone 20-hydroxyecdysone. *Proceedings of the National Academy of Sciences of the United States of America* 100: 13773.
32. Warren JT, Gilbert LI (1986) Ecdysone metabolism and distribution during the pupal-adult development of *Manduca sexta*. *Insect Biochemistry* 16: 65–82.
33. Hiruma K, Bücking D, Lafont R, Riddiford LM (1997) Action of Different Ecdysteroids on the Regulation of mRNAs for the Ecdysone Receptor, MHR3, Dopa Decarboxylase, and a Larval Cuticle Protein in the Larval Epidermis of the Tobacco Hornworm, *Manduca sexta** 1. *General and comparative endocrinology* 107: 84–97.
34. Ashburner M (1972) Puffing patterns in *Drosophila melanogaster* and related species. *Results and problems in cell differentiation* 4: 101.
35. Warren JT, Yerushalmi Y, Shimell MJ, O'Connor MB, Restifo L, et al. (2006) Discrete pulses of molting hormone, 20-hydroxyecdysone, during late larval development of *Drosophila melanogaster*: correlations with changes in gene activity. *Developmental dynamics: an official publication of the American Association of Anatomists* 235: 315.
36. Cao C, Liu Y, Lehmann M (2007) Fork head controls the timing and tissue selectivity of steroid-induced developmental cell death. *Journal of Cell Biology* 176: 843.
37. Andres AJ, Thummel CS (1995) The *Drosophila* 63F early puff contains E63-1, an ecdysone-inducible gene that encodes a novel Ca (2+)-binding protein. *Development* 121: 2667.

38. Biyasheva A, Do TV, Lu Y, Vaskova M, Andres AJ (2001) Glue secretion in the *Drosophila* salivary gland: a model for steroid-regulated exocytosis. *Developmental Biology* 231: 234–251.
39. BONAFE NM, SELLERS JR (1998) Calmodulin-binding proteins of the cytoskeleton. *Calmodulin and Signal Transduction* : 347.
40. Hasson T, Mooseker MS (1994) Porcine myosin-VI: characterization of a new mammalian unconventional myosin. *Journal of Cell Biology* 127: 425.
41. Mooseker MS, Cheney RE (1995) Unconventional myosins. *Annual Review of Cell and Developmental Biology* 11: 633–675.
42. Garcia A, Coudrier E, Carboni J, Anderson J, Vandekerkhove J, et al. (1989) Partial deduced sequence of the 110-kD-calmodulin complex of the avian intestinal microvillus shows that this mechanoenzyme is a member of the myosin I family. *Journal of Cell Biology* 109: 2895.
43. Carboni JM, Conzelman KA, Adams RA, Kaiser DA, Pollard TD, et al. (1988) Structural and immunological characterization of the myosin-like 110-kD subunit of the intestinal microvillar 110K-calmodulin complex: evidence for discrete myosin head and calmodulin-binding domains. *The Journal of cell biology* 107: 1749.
44. Frank DJ, Martin SR, Gruender BN, Lee YS, Simonette RA, et al. (2006) Androcam is a tissue-specific light chain for myosin VI in the *Drosophila* testis. *Journal of Biological Chemistry* 281: 24728.
45. Berg JS, Powell BC, Cheney RE (2001) A Millennial Myosin Census. *Mol. Biol. Cell* 12: 780-794.
46. Sonnenblick BP (1939) The salivary glands in the embryo of *Drosophila melanogaster*. *Recordings of the Genetics Society of America* 8: 137.
47. Sonnenblick BP (1950) The early embryology of *Drosophila melanogaster*. *Biology of Drosophila* : 62–167.
48. Bodenstein D (1943) Factors influencing growth and metamorphosis of the salivary gland in *Drosophila*. *The Biological Bulletin* 84: 13.
49. Bodenstein D (1950) The postembryonic development of *Drosophila*. *Biology of Drosophila* : 275–367.
50. Brand AH, Perrimon N (1993) Targeted gene expression as a means of altering cell fates and generating dominant phenotypes. *Development* 118: 401.

51. Kelso RJ, Buszczak M, Quinones AT, Castiblanco C, Mazzalupo S, et al. (2004) Flytrap, a database documenting a GFP protein-trap insertion screen in *Drosophila melanogaster*. *Nucl. Acids Res.* 32: D418-420.

CHAPTER 2

A NOVEL ECDYSONE RECEPTOR MEDIATES STEROID- REGULATED DEVELOPMENTAL EVENTS

This chapter has been published in PLoS Genetics and modified slightly to satisfy in the style of this dissertation. The complete citation is:

Costantino BF, Bricker DK, Shen K, Merriam JR, Antoniewski C, Callender JL, Henrich VC, Presente A, Andres AJ. A novel ecdysone receptor mediates steroid-regulated developmental events during the mid-third instar of *Drosophila*. PLoS Genetics 2008 Jun 20;4(6):e1000102

My contribution to this work was performing the majority of the experiments, writing and editing the manuscript and addressing reviewer comments. J Merriam, J Callender, C Antoniewski, and V Henrich provided reagents. D Bricker, K Shen, and A Presente assisted in some experiments.

2.1: Introduction.

During metamorphosis in *Drosophila melanogaster*, pulses of the steroid hormone, 20-hydroxyecdysone (20E), stimulate diverse tissue-specific responses such as the histolysis of many larval tissues along with the simultaneous differentiation of adult structures from imaginal discs [reviewed in [1]]. In addition, multiple pulses of 20E during the last (third) larval instar (L3) trigger different responses within the same target tissue, raising the interesting question of how a generalized developmental signal is manifested into distinct physiological responses that are separated by time. The salivary gland of L3 and prepupae is an ideal assay system in which to investigate the molecular mechanisms responsible for such temporally specific developmental specifications. In a

36-hour period, the gland responds to three distinct pulses of 20E in three fundamentally different ways.

During most of larval life, the salivary gland is engaged in the synthesis of non-digestive enzymes that probably aid in the lubrication of the food through the gut [2-4]. However, about midway through the L3 stage, the pattern of gene expression is altered dramatically by the synchronous activation of a small number of genes (at least 8) that are abundantly expressed in the salivary gland [5]. These are known to encode components of the glue mix that cements animals to a solid surface during metamorphosis, and they were first identified because their induction is responsible for the “intermolt” puffs formed on the giant polytene chromosomes of the gland [6, 7].

Approximately 18 hours later, in response to different pulse of 20E that occurs at the end of L3, glue synthesis abruptly ceases [5,8] because the hormone represses transcription from these genes [9,10]. At the same time, the salivary gland begins to express another set of genes, many of which were originally described because they formed “early” and “late” puffs on the polytene chromosomes [reviewed in 11]. The end result of this 20E-mediated response is that glue granules are secreted into the lumen of the gland [12,13].

Finally, approximately 10 hours later at the end of prepupal development, the salivary gland responds to yet another pulse of 20E to initiate the histolysis of the tissue via a modified autophagic cell-death mechanism [14,15].

The details of how 20E initiates glue secretion and gland histolysis are well understood. The hormone is known to bind to a receptor consisting of a heterodimer of EcR and USP proteins [16-18]. Both receptor components are members of the nuclear-

hormone receptor superfamily, both contain well conserved DNA- and ligand-binding domains, and both are needed for the physiological responses of target tissues to 20E at the end of the third instar and at the end of prepupal development [reviewed in 19]. However, little is known concerning the mechanism of receptor mediation during the middle of L3 when glue genes are coordinately activated. Although it is generally assumed that these events are also mediated by a receptor consisting of EcR and USP, other explanations can be invoked including the use of a different 20E receptor.

Here we examine the requirements for EcR and USP in the induction of the glue genes at mid L3. By employing the GAL4/UAS binary expression system [20] with transgenic inducible dominant-negative and RNAi constructs we are able to limit perturbations of 20E signaling specifically to the salivary gland at defined developmental stages. We show that 20E is responsible for inducing a tagged glue transgene as a secondary response to the hormone, and that this programmed developmental response requires components of the 20E-inducible primary-response genes of the *Broad Complex (BRC)*. However, we clearly demonstrate that the mid-instar hormone response requires a receptor that has not yet been characterized. The receptor consists of EcR but not USP. These results challenge the traditional model that most developmental events triggered by 20E must signal through a heterodimer of EcR and USP, and they support alternative explanations that either EcR homodimers or other members of the nuclear hormone receptor superfamily play active roles in the diversity of developmental responses to steroid hormones in *Drosophila*.

2.2: Materials and Methods.

2.2.a: *Drosophila* Stocks and Culture

All flies were raised on standard cornmeal-molasses medium supplemented with live baker's yeast as recommended by the Bloomington Stock Center (Bloomington, Indiana, United States) (http://flystocks.bio.indiana.edu/Fly_Work/media-recipes/bloomfood.htm). w1118 (FBst0307124), GFP.nls [$\{UAS-GFP.nls\}$ 14 (FBst0004775)], EcRi [$\{UAS-EcR-RNAi\}$ 104 (FBst0009327)], EcR-DN [$\{UAS-EcR.B1-DC655.F645A\}$ TP1 (FBst0006869)], and the EcR isoform stocks [EcR-A $\{UAS-EcR.A\}$ 3a (FBst0006470), EcR-B1 $\{UAS-EcR.B1\}$ 3b (FBst0006469), EcR-B2 $\{UAS-EcR.B2\}$ 3a (FBst0006468), and EcR-C $\{UAS-EcR.C\}$ TP1-4 (FBst0006868)] were obtained from the Bloomington Stock Center.

The following stocks were provided as generous gifts: UAS-hid [60] from Eric Baehrecke, the hsGal4 driver on the third chromosome [20] from Robert Holmgren, and the stocks containing specific isoforms of the BRC (UAS-BRC-Z1, UAS-BRC-Z2, UAS-BRC-Z3, and UAS-BRC-Z4) [61] from Xiaofeng Zhou.

2.2.b: Generation of Transgenic Flies

Transgenic flies containing glueRED were prepared by digesting pDsRed2-C1 (Clontech, Palo Alto, California, United States) with AgeI and KpnI restriction enzymes to isolate a DNA fragment containing the open reading frame for DsRED. This fragment was cloned into pBS-Sgs Δ 3GFP [13] that was digested with the same enzymes to remove the eGFP tag and generate a vector with compatible ends. The resulting intermediate construct was digested with AgeI and the 39 recessed ends were filled in and religated to restore the open reading frame between Sgs3 and DsRED. The Sgs3- DsRED sequence

was removed from the Bluescript vector (Stratagene, La Jolla, California, United States) as a NotI/KpnI fragment and inserted into the NotI and KpnI sites of the pCaSpeR-4 fly transformation vector (FBmc0000178). DNA was sent to the vonKalm laboratory at the University of Central Florida for the generation of transgenic flies using standard techniques [62].

To produce the *UAS-USPⁱ* stock, a PCR fragment was amplified from a *USP* cDNA plasmid [63] using the primers AAGAATTCGGTACCAGTATCCGCCTAACCATCC and TTAGATCTCGCTTCATCTTTACTACTCAG. The resulting amplification product (corresponding to a 924 bp fragment between positions 467 and 1390 relative to the *USP* mRNA sequence) was cloned in the pUAST vector (FBmc0000383) using two steps. First a reverse fragment was placed between the vector BglII and KpnI sites. A second forward-orientated fragment was cloned between EcoRI and BglII sites. Recombinant *UAS-USPⁱ* constructs were transformed at 30°C in Sure-competent bacteria (Stratagene) to minimize DNA recombination and screened using appropriate restriction enzyme digestions. Transgenic lines were generated as previously described using a w¹¹¹⁸ strain as a recipient stock.

UAS-USP⁺ stocks were prepared as follows: The vector pUAST-*USP⁺* was constructed by PCR amplification of the *USP* open reading frame with the forward primer TTTTGCGGCCGCACC ATG GAC AAC TGC GAC CAG GAC and the reverse primer TTTTCTAGA CTA CTC CAG TTT CAT CGC CAG using pZ7-1 cDNA as a template [63]. The NotI and XbaI restriction sites flanking the PCR product were used for subsequent ligation into the corresponding sites in the pUAST vector. The pUAST-*USP⁺* vector was transformed into flies at the Duke University Medical Center.

The UAS-Control line (LA1216) contains an insert of the construct P{Mae-UAS.6.11} (FBtp0001327). This vector was designed for gene-misexpression screens because it contains a copy of the UAS/GAL4 binding sequences oriented to express flanking genes when inserted into the genome [64].

2.2.c: Selecting a Salivary-Gland Specific Driver

We tested four Gal4-drivers obtained from the Bloomington Stock Center [*ABI-Gal4* (FBst0001824), *C147-Gal4* (FBti0024396), *T155-Gal4* (FBti0002598), and *34B-Gal4* (FBst0001967)] with expression patterns reported to be restricted to the larval salivary gland. To ascertain which of these was best for tissue-specific expression studies, we crossed them to a stock in which the *hid*/ Wrinkled cell-death gene (FBgn0003997) was expressed under UAS control. Because the major function of the salivary gland in the larval stages is the reported synthesis of mucin-like proteins that help lubricate the food as it moves through the gut [2,3], we reasoned that animals could survive without a salivary gland only if they were provided a diet of freshly produced moist yeast paste. Thus, by using *UAS-hid* we could ablate the salivary gland and test if such animals were viable when raised on soft food.

The initial analysis using the above listed drivers indicated that no larvae were able to survive, probably due to expression of the *hid* gene in other vital tissues. But because these are derived from the GawB vector, we used a heat shock 70-Gal4 driver that is also GawB derived. These animals were able to survive to puparium formation when crossed to *UAS-hid* and raised on a diet of freshly prepared yeast paste. Crossing *hsGal4* to a stock containing both *UAS-hid* and *UAS-GFP.nls* confirmed that larval salivary glands could not be detected and were ablated. Great care was exercised to raise the animals

crossed to sgGal4 at temperatures below 30°C to prevent exposing them to a stress that might induce Gal4 in all cells. Because the GFP.nls transgene was used in most of the experiments, a non-specific response could easily be detected by the presence of green nuclei in other tissues.

2.2.d: Salivary Gland Organ Culture

20E (Sigma, St. Louis, Missouri, United States) was prepared as a stock solution of 10^{-2} M in 100% ethanol and stored at 220°C. The stock solution was diluted to the proper working concentration in Schneider's medium (Sigma).

Flies of the appropriate genotype were crossed and reared in a small population cage containing approximately 500 females and 500 males. The cage was presented with hard-agar plates (10% molasses, 3.5% agar) containing a dab of fresh yeast paste (prepared as a 1:1 mixture of dry baker's yeast with water) 2–3 times per day to collect fertilized eggs. Collection plates were aged at 25°C and first-instar larvae were collected in 1-hour intervals as they hatched. The first-instar larvae were added in groups of 100 to vials containing standard cornmeal-molasses-yeast medium and aged at 25°C for approximately 68 hours (a developmental stage that precedes glue induction by approximately 4 hours) before being washed from the food with Schneider's medium. Animals were torn in half lengthwise using small dissecting forceps (Fine Scientific Tools, Foster City, California, United States). Larvae prepared in this manner were transferred to clean microscope slides containing 25 ml of Schneider's medium with or without 20E. A range of 20E dilutions (10⁻⁶, 10⁻⁷, 10⁻⁸, 10⁻⁹ M) was prepared for each experiment. Small strips of Number 1 Whatman filter paper (Millipore, Billerica, Massachusetts, United States) were placed around the culture as spacers before adding a

22 mm² coverslip. The culture was placed on a platform shaker in a box into which O₂ was continuously infused during the culture period. Cultures were incubated at 25°C for 4–6 hours before being assayed for glue production as detected by the presence of green fluorescent protein from the glueGRN transgene.

2.2.e: Microscopy and Imaging

Whole larvae were selected from the food, washed 36in water, blotted on filter paper, placed in a depression slide, and killed with a few drops of ether. After the ether evaporated, animals were mounted in glycerol between two slides using glass coverslips as spacers. Larvae were photographed within 30 minutes of preparation. For isolated tissues, animals were dissected in Drosophila PBS (DPBS) [65] or Schneider's medium. Low-resolution images of whole animals or dissected tissues were obtained on a Leika fluorescent stereo microscope containing filter cubes for GFP and/ or DsRED. Images were captured with the Spot Insight QE Model #4.2 digital camera (McBain Instruments, Chatsworth, California, United States) and prepared with Canvas (ACD Systems, Miami, Florida, United States) graphics software.

High-resolution images of dissected salivary glands were imaged on a LSM 510 Axioplan confocal microscope (Carl Zeiss SMT, Peabody, Massachusetts, United States) equipped with LSM 510 image-analysis software.

2.2.f: Northern Blots

Northern blots were prepared as previously described [5]. Briefly, RNA was isolated from larvae by grinding animals in SDS lysis buffer, digesting the homogenate with 250 mM Proteinase K (NEB, Ipswich, Massachusetts, United States), extracting the sample with phenol/chloroform, and precipitating the aqueous phase with ethanol. Ten

micrograms of total RNA were fractionated on 1% formaldehyde/MOPS/agarose gels and blotted onto Duralon-UV membranes (Stratagene). Probes for each glue gene and the rp49 control were prepared as gel-isolated fragments from digested clones and hybridized with labeled random oligonucleotides using a Prime-it kit (Stratagene) and ³²P dCTP (GE Healthcare, Piscataway, New Jersey, United States) as previously described [5]. After washing, signals were detected using the Typhoon 8600 Variable Mode Phosphorimager equipped with Image Quant scanning software (GE Healthcare).

2.2.g: Protein Detection

Dissected tissues were prepared for antibody staining as previously described [66]. Tissues were stained using the AB11 USP mouse monoclonal antibody [67] (gift from Carl Thummel) at a dilution of 1:50. Protein levels were visualized using a goat-anti-mouse secondary antibody conjugated to FITC (Jackson Immuno Research, West Grove, Pennsylvania, United States).

To prepare protein extracts for Coomassie staining or Western-blot analysis, salivary glands were dissected in DPBS as described above. Typically 10–20 pairs of glands were collected in DPBS, pelleted in a microfuge, and resuspended in lysis buffer containing a cocktail of protease inhibitors [68]. Glands were homogenized and boiled for 5 minutes before being stored at -20°C for less than one week. Samples were divided in two and resolved on separate 12% SDS polyacrylamide gels that were run in the same electrophoresis rig. One was stained with Coomassie brilliant blue (J. T. Baker, Phillipsburg, New Jersey, United States) and the other was transferred to Immobilon P membranes (Millipore) as previously described [66]. Blots were incubated with the following antibodies: mouse anti- α -Tubulin primary (Sigma) diluted 1:15,000; rabbit

anti-DsRED primary (Clontech) diluted 1:15,000; mouse anti-USP primary diluted 1:100; goat anti-mouse-HRP secondary (Jackson Immuno Research) diluted 1:40,000; and goat anti-rabbit-HRP secondary (Jackson Immuno Research) diluted 1:25,000.

Protein levels were visualized and quantified using Chemiluminescence ECL(+) Western-blotting detection system (GE Healthcare) and a Typhoon 8600 Variable Mode Phosphorimager (GE Healthcare).

2.3: Results.

2.3.a: The *Sgs3* Transgene is Induced by 20E

It is generally assumed that the glue genes (*Sgs1*, *Sgs3*, *Sgs4*, *Sgs5*, *Sgs6*, *Sgs7*, *Sgs8*, and *I71-7*) are induced by a pulse of 20E that occurs midway through the third instar. This inference is based on the dramatically coordinated developmental induction at mid L3 of most of these genes [5], and on studies in which *Sgs* expression is examined in backgrounds mutant for genes thought to be involved in 20E production or transport [21,22]. The model further proposes that induction of the glue occurs as a secondary response to 20E, because *Sgs* expression is significantly perturbed in mutants defective for *BRC* and *E74*, which are known to be direct targets for the hormone/receptor complex [23-25]. However, an *Sgs3*-derived reporter transgene is induced when temperature-sensitive *ecd1^{ts}* (FBgn0000543) mutants— known to produce low circulating levels of 20E [26]—are shifted to the non-permissive temperature before the L3 stage, and the same GFP reporter is also induced in animals that are mutant for *USP*, *EcR-B1*, and *EcR-B2* receptor components [13].

Thus, the literature contains contradictory reports concerning the role of 20E in inducing some of the glue genes. Therefore, we began this analysis with an *in vitro* culture of salivary glands dissected from mid L3 because we know of no published

reports that directly test if glue-gene transcription can be induced by 20E in wildtype animals. To simplify the analysis, we dissected salivary glands from a line of flies in which the coding information for *Sgs3* had been tagged with *GFP* (*glueGRN*). This stock (formally called *SgsGFP*) contains adequate regulatory information for the proper temporal, spatial, and high-level expression of the *Sgs3* gene. It has also been extensively characterized and shown to be an accurate reporter for the secretion and expectoration of endogenous SGS3 glue protein [13].

Larvae were synchronized at hatching and raised to the early-third-instar stages approximately 5 hours prior to the normal transcriptional induction of the glue genes. Salivary glands were then dissected and exposed to media containing different concentrations of 20E (ranging 10^{-9} to 10^{-6} M) or in medium without hormone. Under these circumstances glueGRN accumulation was detected 4-6 hours later in cultures incubated with 10^{-8} or 10^{-9} M 20E (Fig. 2-1, experiment performed by Asaf Presente), but not in untreated cultures or those incubated with higher concentrations of the hormone. Thus, the concentration needed for induction of glueGRN is 2-3 orders of magnitude lower than the titer ($\sim 10^{-6}$ M) reported to trigger "early" polytene puff formation, imaginal disc eversion, and glue secretion [13,27,28]—all developmental events that occur near puparium formation in response to a much better characterized pulse of 20E. The result is consistent with the concentration of a small pulse of hormone that has been reported to occur in the hemolymph of developing larvae a few hours prior to the transcriptional activation of the glue genes [29].

Figure 2-1: Glue genes are induced by 20E in cultured glands.

Mid-L3 animals were torn in half and incubated with ethanol as a control (A), or with 20E at a final concentration of 10^{-8} M (B). The induction of glue proteins in the salivary glands was detected by the presence of a GFP-tagged Sgs3 protein (glueGRN). Note that the positions of the salivary glands in (A) are outlined with dashed lines. The fluorescence detected in the pharynx (arrowheads) is non-specific and was used to standardize photographic exposures. Both photographs were taken at the same magnification indicated by the bar in A. *Experiment performed by Asaf Presente.*

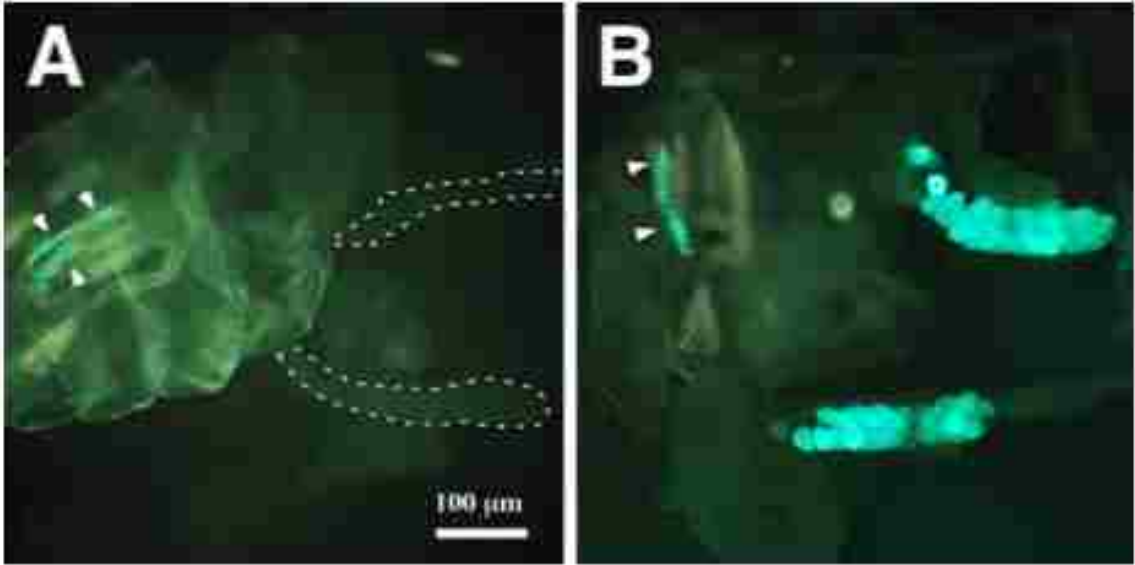

2.3.b: Sgs3 Transgene Induction Requires Functional EcR

The EcR gene encodes three different protein isoforms, EcR-A, EcR-B1, and EcR-B2. All three contain the same DNA- and ligand-binding domains, but they contain different amino terminal A/B sequences due to the use of alternative promoters and differential splicing [16]. Null mutations for EcR die early in development and cannot be assayed for glue synthesis [30]. However, mutations that remove EcR-B1 and EcR-B2 [31] do produce glue [13]. These observations raise the possibility that either EcR is not required for the induction of Sgs3, or that any EcR isoform is sufficient for the process. To distinguish between these possibilities and to take advantage of more powerful genetic tools that allow for tissue-specific manipulations of gene products, we utilized the GAL4/UAS binary expression system [20] to analyze glue-gene induction in developing salivary glands.

To perform this analysis in the most precise way, it was first necessary to identify a temporally and spatially restricted driver—a transgenic stock of flies in which the Gal4 transcription factor is under the control of specific *Drosophila* enhancers that limit its expression to larval salivary glands at least 10 hours preceding the normal induction of Sgs3. In our search for the best reagent, we noticed that a number of the drivers classified as salivary-gland specific were produced from the P{GawB} enhancer-trap element (FBtp0000352). Our lab and others have observed that GawB-derived elements display constitutive expression of GAL4 in larval salivary glands [32], perhaps because part of the GawB vector contains a cryptic larval salivary-gland-specific enhancer element. To test this hypothesis we used a hs-Gal4 stock that contains the Hsp70Bb (FBgn0013278) controlling elements driving Gal4 in a GawB vector. In the absence of heat stress these

animals produced GAL4 in the L1 (first instar), L2 (second instar), and L3 salivary glands as indicated when they were crossed to the GFP.nls responder. In this stock GFP is expressed under GAL4 control (it contains UAS elements that are binding sites for the GAL4 transcription factor) and it is targeted to nuclei (Figure 2-2, experiment was performed by Kate Shen). Thus, in subsequent experiments we used hsGal4 (now referred to as sgGal4) to drive spatially restricted expression of UAS-transgenes only in larval salivary glands.

With a spatially restricted driver on hand, we now crossed sgGal4 to both UAS-dominant-negative- (*EcR-DN*) and *UAS-RNA-interference-(EcRi)* constructs of EcR. The EcR-DN protein is defective in ligand-activated transactivation so that it competes with endogenous EcR isoforms to block normal hormone responses [33]. The *EcRi* construct contains an inverted repeat of a DNA region common to *EcR-A*, *B1*, and *B2* so that its expression silences all isoforms [34]. When either was crossed to a tester stock containing sgGal4 and glueGRN, no green fluorescence was detected in L3 larval glands. These results are consistent with a requirement that at least one EcR isoform must be present in the salivary gland for glueGRN synthesis (data not shown).

Figure 2-2: *sgGal4*, a *GawB*-derived driver, has an expression pattern restricted to the salivary glands during larval stages.

Flies containing *sgGal4* were crossed to the *UAS-GFP.nls* reporter and all developmental stages were examined for the spatial expression of GFP as indicated by green fluorescence in the nuclei of live animals. The only tissues that contained green protein were the salivary glands. Depicted are a first-instar larva (A), a second-instar larva (B), an early-third-instar larva (C), and the anterior half of a later instar larva (D). Anterior is to the left in all photographs, and all were taken at the same magnification indicated by the bar in (D). *Experiment performed by Kate Shen.*

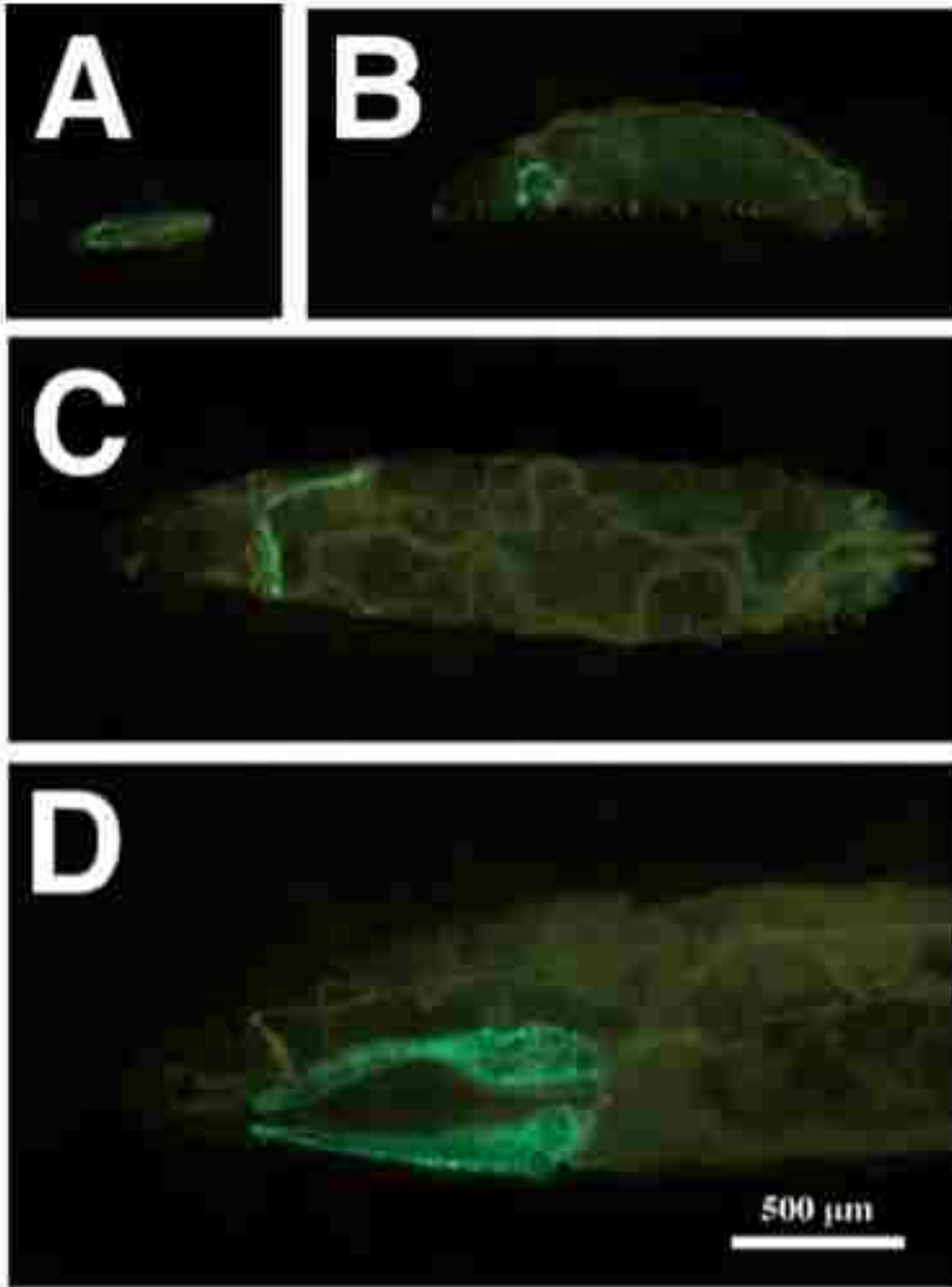

One potential caveat with the above experiments is that by perturbing EcR in the salivary gland, we were killing it or causing it to develop too slowly to induce the Sgs3 transgene. To address this possibility, we utilized another tester stock containing three transgenic elements: glueRED; GFP.nls; sgGal4. The glueRED element is an endogenously tagged Sgs3 gene (under its own promoter/enhancer elements). It contains the same DNA sequence as glueGRN except the coding information for GFP is replaced with that of DsRED [35]. As with glueGRN, the glueRED element produces a protein that is synthesized (Figure 2-3A), secreted (Figure 2-3B), and expectorated in exactly the same manner as endogenous SGS3. Thus, when this tester stock was crossed to EcR-DN (Figure 2-3C) or EcRi (Figure 2-3D) no glueRED was produced, but GFP was still localized to nuclei that are similar in size to those of the control glands producing glueRED (Figure 2-3A,B). These results indicate that neither EcR-DN nor EcRi expression is killing the cells or preventing their normal nuclear polytenization. Thus, EcR function in the salivary gland is required for glueGRN and glueRED production.

Figure 2-3: 20E-mediated glueRED induction requires functional EcR proteins.

Confocal images of salivary glands from stocks containing *sgGal4; UAS-GFP.nls; glueRED* transgenes. Normally glueRED (indicated by red fluorescence) is synthesized during the mid-L3 stage and loaded into large granules that remain within the cell until 6-8 hours prior to pupariation (A). At the end of the instar (in response to another pulse of 20E) glue becomes secreted into the lumen (B). No glueRED is produced in animals expressing a dominant-negative form of EcR (C) or an inverted repeat of EcR that induces RNA interference (D). Note that *UAS-GFP.nls* is expressed in both EcR-compromised glands. The GFP marker serves to mark the nucleus (green fluorescence), which is able to survive and polytenize to the same degree in all cells presented. All photos were taken at the same magnification indicated by the bar in (C). Arrowheads and “L” mark the position of the lumen into which glue should be secreted.

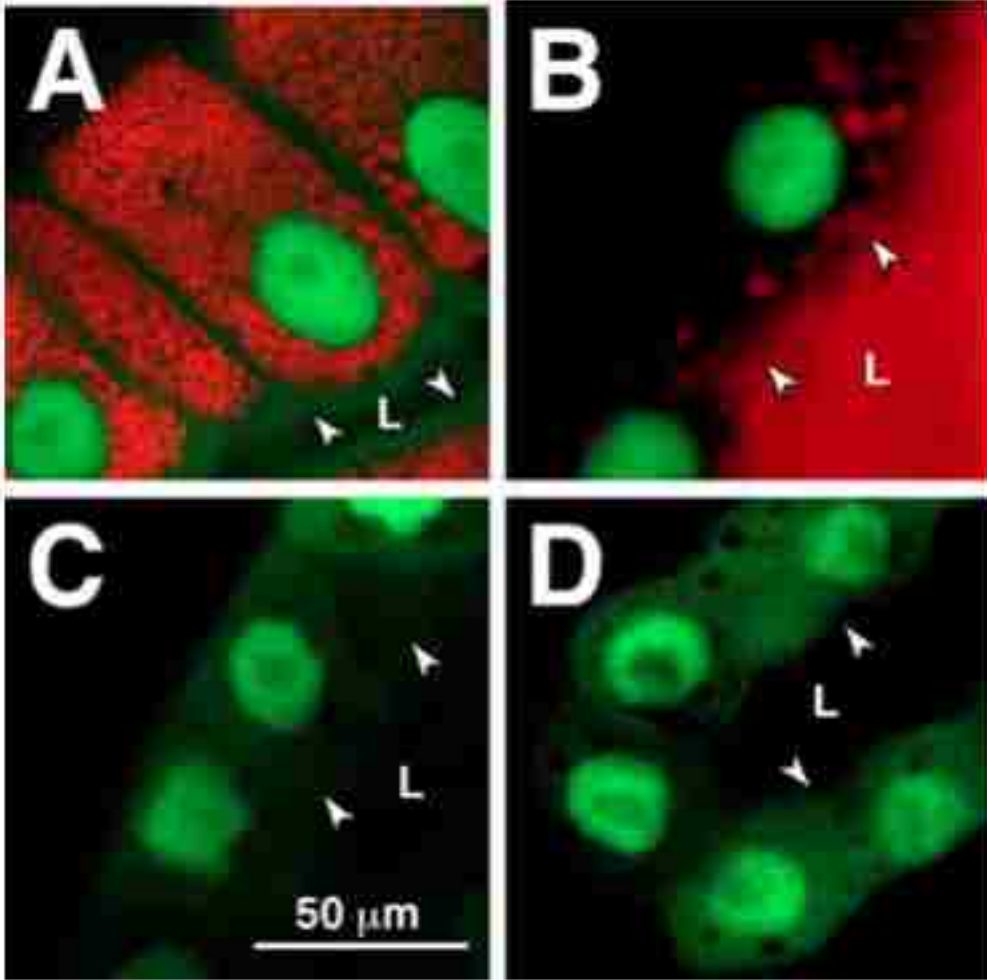















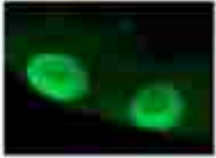
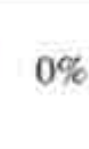





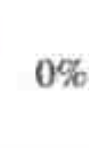
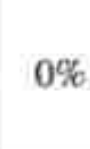



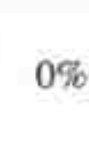
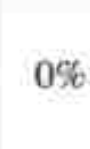
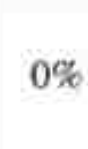







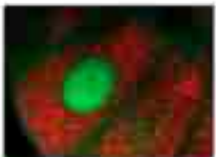





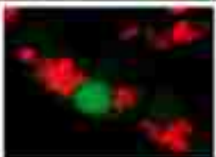



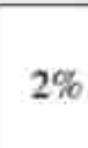

2.3.c: Sgs3 Transgenes Can be Induced by Any Isoform of EcR

To test the hypothesis that any isoform of EcR can be used to induce glue synthesis, we crossed each UAS-EcR isoform-specific transgene into a background in which EcR-DN was expressed in the salivary gland (under sgGal4 control) using the glueRED and GFP.nls transgenes to assay gland physiology. To confirm that extra copies of *UAS*-transgenes were not diluting the effects of EcR-DN in a non-specific manner, we included a UAS-control construct that contains a cassette of UAS/GAL4 binding sites. By itself, the expression of the UAS-control does not lead to a block in glueRED synthesis when driven by sgGal4 (data not shown). Furthermore when crossed into an animal producing EcR-DN and GFP.nls, it does not overcome the block in glueRED synthesis (Figure 2-4). This control eliminates the concern that the expression of EcR-DN may be reduced by the introduction of an additional transgene containing UAS elements.

In contrast to the UAS-control, introducing each of the known EcR-specific isoforms into the same genetic background completely rescues the block in the production of glueRED caused by EcR-DN. The rescue is fully penetrant and normal in the semi-quantitative scoring scheme that is presented in Figure 2-4. It is even more interesting because an artificially constructed EcR isoform— EcR-C, which contains only the common regions of EcR because it is missing the isoform-specific A/B domain—also rescues the block in glueRED synthesis in approximately 90% of the animals examined. These results confirm an earlier conclusion that any isoform of EcR expressed in the salivary gland is capable of transmitting the 20E signal to induce the transcription of Sgs3- derived genes.

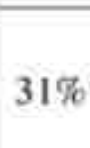
Figure 2-4: Any isoform of EcR or BRC is sufficient to induce glueRED synthesis.

The percentage of glands displaying each synthesis phenotype is indicated below a low-resolution representative (all photographed at the same magnification as indicated in E). Categories include glands that are not producing any glue (A), glands in which only a few cells produce glue (B), glands in which approximately 25% of the cells are producing glue (C), glands in which approximately half the cells are producing glue (D), and glands in which all the cells are producing glue (F). Higher resolution images of cells representing each genotype (transgene addbacks) were all taken at the same magnification (indicated bottom right).

Genotype (Transgene Addback)	A	B	C	D	E	Number Assayed	Photographic Example of Selected Cells	
<i>SgGal4</i> <i>UAS-GFP_{nlv}</i> <i>UAS-EcR-DN</i> <i>glucRED</i> <i>UAS-Control</i>						100% 0% 0% 0% 0%	(20)	
<i>SgGal4</i> <i>UAS-GFP_{nlv}</i> <i>UAS-EcR-DN</i> <i>glucRED</i> <i>UAS-EcR-A</i>						0% 0% 0% 0% 100%	(49)	
<i>SgGal4</i> <i>UAS-GFP_{nlv}</i> <i>UAS-EcR-DN</i> <i>glucRED</i> <i>UAS-EcR-B1</i>						0% 0% 0% 0% 100%	(48)	
<i>SgGal4</i> <i>UAS-GFP_{nlv}</i> <i>UAS-EcR-DN</i> <i>glucRED</i> <i>UAS-EcR-B2</i>						0% 0% 0% 0% 100%	(51)	
<i>SgGal4</i> <i>UAS-GFP_{nlv}</i> <i>UAS-EcR-DN</i> <i>glucRED</i> <i>UAS-EcR-C</i>						10% 0% 0% 0% 90%	(49)	
<i>SgGal4</i> <i>UAS-GFP_{nlv}</i> <i>UAS-EcR-DN</i> <i>glucRED</i> <i>UAS-BRC-Z1</i>						12% 81% 5% 2% 0%	(43)	
<i>SgGal4</i> <i>UAS-GFP_{nlv}</i> <i>UAS-EcR-DN</i> <i>glucRED</i> <i>UAS-BRC-Z2</i>						0% 7% 7% 27% 58%	(55)	
<i>SgGal4</i> <i>UAS-GFP_{nlv}</i> <i>UAS-EcR-DN</i> <i>glucRED</i> <i>UAS-BRC-Z3</i>						60% 38% 2% 0% 0%	(42)	
<i>SgGal4</i> <i>UAS-GFP_{nlv}</i> <i>UAS-EcR-DN</i> <i>glucRED</i> <i>UAS-BRC-Z4</i>						12% 31% 19% 21% 19%	(48)	

2.3.d: Proteins Encoded by the Broad Complex Control the Expression of Sgs3

Transgenes

The BRC is a large transcription unit that produces several different isoforms of a transcription factor containing C2H2 zinc- fingers. Although multiple transcripts are derived from the locus [36], only four general types of proteins are produced. Each isoform contains an identical NH2 terminus, but it has a different combination of DNA binding domains [37]. The four proteins, referred to as BRC-Z1, BRC-Z2, BRC-Z3, and BRC-Z4, have been shown to play an important role in the production of SGS3 and other glue proteins. This conclusion is based on the phenotypic analyses of null or isoform-specific hypomorphic mutants that either do not produce SGS3 or display a prolonged developmental delay in the accumulation of transcripts from the locus [13,23,24,38]. Because it has been shown that BRC is regulated as a primary response to 20E (the hormone/receptor complex directly binds to DNA elements within the gene and induction does not require *de novo* protein synthesis) [39], the above effects on Sgs3 activation have led to a model in which glue production occurs as a secondary response to the hormone. Thus, the BRC zinc-finger transcription factors are probably responsible for activating promoter/enhancer elements within the glue genes as suggested by DNA binding studies on Sgs4 [40].

To test this hypothesis in more detail, we utilized transgenic stocks in which each BRC-Z isoform was expressed under UAS control in larvae also containing glueRED; sgGal4; GFP.nls; and EcR-DN. As indicated in Figure 2-4, each BRC-Z isoform is capable of partially rescuing the block in glue synthesis imposed by the production of EcR-DN. Rescue was scored using five categories that indicated the approximate

percentage of cells within a gland that produced glueRED (none, few, 25%, 50%, 100%). However, not all BRC isoforms are equal in their ability to suppress the synthesis defect imposed by EcR-DN. BRC-Z2 (no glands were observed that were completely empty of glue, and 58% had full wildtype levels) and BRC-Z4 rescue the best; whereas, BRC-Z1 and BRC-Z3 (60% of the animals have glands with no glueRED) rescue poorly. The variability in rescuing the synthesis-blocked phenotype may reflect the partially redundant activities or regulatory dependencies that have been reported among the four types of BRC isoforms [37], or it may reflect the differences in expression levels among the different transgenes.

Two additional points are worth noting. First, expression of all forms of UAS-BRC altered the expression/localization of GFP.nls in some cells, but this failure to localize GFP did not correlate with a defect in glueRED production. In all cases, a few cells producing glueRED were observed with large prominent nuclei that did not contain GFP. Because we never observe this effect in the experiments performed with EcR isoforms or the UAS-control, it is unlikely that extra transgenes containing UAS elements are titrating a limiting amount of GAL4 transcription factor.

Second, we sometimes observe the appearance of glueRED in L1 and L2 animals when BRC isoforms are ectopically expressed (data not shown). This early expression of glueRED or glueGRN is never observed in control animals or in crosses where EcR-specific isoforms are ectopically expressed. This result may indicate that BRC proteins are sufficient for SGS3 production at any stage of larval salivary gland development, but that critical levels of BRC isoforms are normally restricted to mid-to-late L3 stages in wildtype animals [5].

2.3.e: EcR is Required for the Induction of Other Glue Genes

Glue is a mixture of at least eight different glycoproteins [41,42], which are coordinately induced midway through the third instar in a tissue-restricted fashion. To test whether perturbing EcR signaling disrupts the synthesis of most glue proteins, we assayed glue production in EcR-compromised glands in two different ways. First, we examined the glands directly. The cytoplasm of EcR-compromised cells is very small with no detectable secretory granules (Figure 2-3C,D). If other abundant non-tagged glue proteins were being loaded into granules, this result would not be expected. Second, when we examined the expression pattern of Sgs3, Sgs4, Sgs5, Sgs7, and Sgs8 transcripts by Northern analysis, we found very little signal for any of the five glue genes tested in animals in which EcR was compromised in the salivary gland (Figure 2-5). Note the normal developmental expression pattern in the control lanes (C-1; C-2). Transcript levels for all glue genes should be high in wandering larvae (L), and they should be low or undetectable at the time of puparium formation (W).

Figure 2-5: EcR, but not USP, is needed for glue synthesis.

Northern blots of whole-animal extracts from wandering-third-instar larvae (L) and animals at the white prepupal stage (W). Because the glue genes are known to be repressed by the 20E pulse that triggers secretion, RNA levels for each of the 5 different glue genes examined [*Sgs3* (and its derivative *glueGRN*), *Sgs4*, *Sgs5*, *Sgs7*, and *Sgs8*] are expected to be high in (L) and low or undetectable in (W) as they are in the controls (C-1 and C-2). C-1 is the parental glueGRN stock, and C-2 is a “driver only” control (glueGRN crossed to *sgGal4*). However, when *EcR-DN* or *EcRi* is expressed in the salivary glands, no glue expression can be detected. Blots were hybridized for *rp49* as a loading and blotting control. Interestingly, when glands from the *USPⁱ* cross are assayed, all glue genes examined are expressed, but they are not repressed at the W stage. This result is expected if USP is not required to turn the genes on, but is needed to turn them off at the end of the instar. *Experiment performed by Andrew Andres.*

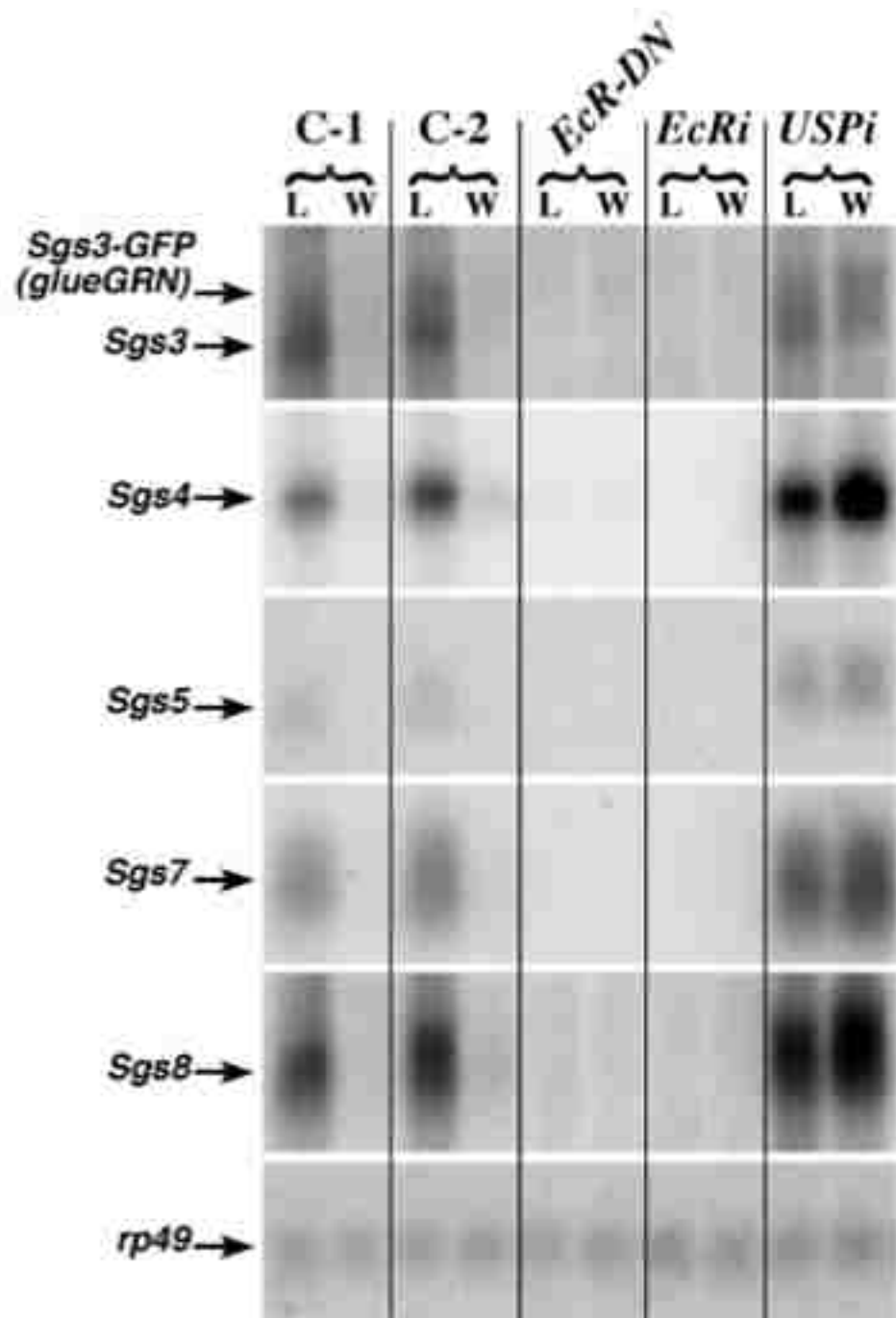

2.3.f: Induction of the Glue Genes does not Require USP

Because all known 20E signaling pathways that control in-vivo developmental events are thought to be mediated through an ecdysone receptor consisting of EcR and USP, we wanted to test the requirement for USP in the synthesis of glue. Thus, we utilized a transgenic RNAi construct that contains an inverted repeat of USP under UAS control (*USPi*). We expressed this construct using the sgGal4 driver and the reporter genes (glueRED; GFP.nls) described above in order to selectively silence USP in larval salivary glands. Under these circumstances glands were indistinguishable from parental stocks (compare Figure 2-3A with Figure 2-6A), and 100% of the glands produced wildtype levels of glueRED (Table 2-1). This result suggests that USP is not part of the receptor needed for glueRED expression. An alternative explanation is that the *USPi* construct is not effectively knocking down USP levels in the salivary gland, but three lines of evidence make this possibility very unlikely.

First, we examined wildtype- and *USPi*-compromised salivary glands for USP protein using a well-characterized USP antibody. As shown in Fig. 2-6, no USP protein can be detected in the nuclei of salivary glands where the *USPi* construct is expressed. This is in contrast to the wildtype glands of similar L3 stages (compare the tissues marked as SG in C-E with those outlined by a dashed line in C'-E'), and in contrast to *USPi* animals where the fat body (FB), nervous system (NS), imaginal discs (ID) and midgut (MG) clearly display the expected nuclear staining. This result is consistent with sgGal4 driving *USPi* only in salivary glands and not in other tissues. In addition, no USP protein is detected in salivary- gland extracts when a Western-blot analysis is performed on glands expressing the *USPi* construct (Figure 2-7).

Table 2-1: Overexpressing USP blocks the synthesis of glueRED.

Genotype (<i>Transgene Addback</i>)	Empty	Few	Quarter	Half	Full	Number Assayed
<i>SgGal4</i> <i>UAS-GFP.nls</i> <i>glueRED</i> <i>USP-USPⁱ</i>	0%	0%	0%	0%	100%	50
<i>SgGal4</i> <i>UAS-GFP.nls</i> <i>glueRED</i> <i>UAS-USP(+)</i> (at 25°C)	34%	2%	17%	25%	22%	56
<i>SgGal4</i> <i>UAS-GFP.nls</i> <i>glueRED</i> <i>UAS-USP(+)</i> (at 29°C)	53%	11%	16%	13%	7%	61

Figure 2-6: Silencing USP in the salivary gland does not block glueRED synthesis.

Confocal images in which RNAi against USP is expressed in the salivary glands demonstrate that glueRED synthesis is normal but not secreted at the time of puparium formation (A). Overexpression of wildtype USP blocks glueRED synthesis (B) in many animals producing a synthesis-defective phenotype that is similar to those observed when EcR is compromised. Both images were taken at the same magnification, which is identical to that presented in Fig 2-3.

Confocal images of L3 tissues from wildtype animals (C-E) and larvae in which RNAi was induced against USP (USPi) in the salivary glands (C'-E'). Tissues are stained with a USP antibody and visualized with a FITC-conjugated secondary. Fluorescence is detected in the nuclei of early third (C, C'), mid-third (D, D'), and late-third (E, E') instars. The positions of the salivary glands (SG and dashed outlines in C'-E'), nervous system (NS), imaginal discs (ID), fat body (FB), and midgut (MG) are marked for comparison to indicate that that USP silencing is restricted to the salivary gland as expected with a tissue-specific driver. Note that the gain in E' is increased to emphasize the lack of USP staining in the nuclei of the salivary glands. Photos C-E' were taken at the same magnification indicated by the bar in E.

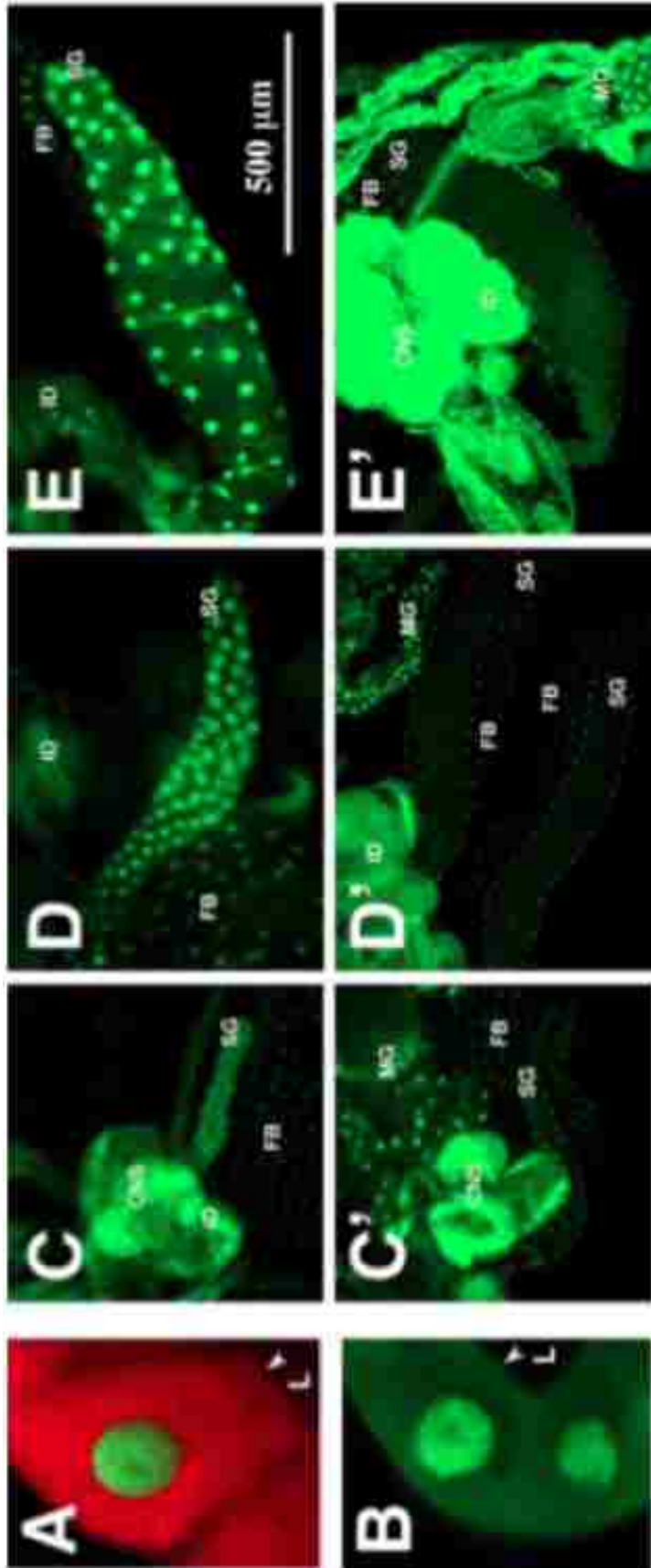

Second, because glue secretion (dumping of granules into the lumen of the gland) at the end of L3 has been shown to be 20E dependent [12] and to require functional EcR and USP [13], we expected that *USPⁱ* glands would not be able to secrete the glueRED that was produced at an earlier stage. This prediction was always supported by the data. Note that the photograph of the gland in Figure 2-6A was taken at the time of puparium formation and that no glueRED can be detected in the lumen (L) of the tissue. In wildtype parental glands, secretion of the tagged glue into the lumen (Figure 2-3B) always occurs by the white prepupal stage.

Third, because it has been reported that USP is necessary to repress the glue genes at the time of puparium formation, we expect that transcript accumulation for each Sgs gene should not decrease at the white prepupal stage. The data presented in Figure 2-5 (compare L with W in the *USPⁱ* lanes) support this hypothesis.

Another possible caveat for the observation that RNAi against USP does not prevent glueRED expression is that a small amount of USP protein may be very stable in the salivary gland and thus not subject to efficient silencing by the RNAi mechanism. Following this logic, the protein turn over might take 4 days to reach a critical threshold level. Thus, there would be enough USP protein for glueRED synthesis in 3-day old larvae (the age when glue genes are induced by 20E), but not enough in 4-day old larvae (the age when 20E causes glue secretion). To test the ability of the *USPⁱ* construct to silence USP effectively in a short time frame, we used the glueGal4 driver (FBst0006870) to express transgenes in the salivary gland from mid-L3 until puparium formation. Under these circumstances glue secretion was blocked even though the *USPⁱ* responder was only being expressed for 24 hours prior to the assay (data not shown).

Because it is known that USP can heterodimerize with EcR at the end of the larval period, we predicted that an overproduction of USP at mid-L3 might prevent a critical amount of EcR from forming the functional receptor needed for glue-gene induction. However, if even a small amount of a receptor consisting of EcR and USP is required to induce the glue genes, overproducing the USP component at an earlier time should not affect the response. Thus, we generated transgenic flies in which the coding information for wildtype USP was placed under UAS controlling elements. When this transgene (USP+) was driven by sgGal4, a large amount of USP protein was detected on Western blots of salivary glands (Figure 2-7), and the production of glueRED was reduced (Figure 2-6B; Table 2-1). We verified that this construct produces functional protein by crossing it to flies carrying both the glueGal4 driver and USPⁱ responder. Under these conditions the USP+ construct was able to rescue the block in glue secretion caused by USPⁱ.

Although the overproduction of USP in the salivary gland perturbs glueRED expression (34% of the glands produce no product), the block was not complete because animals were able to express varying levels of glueRED in some salivary-gland cells (Table 2-1). To more precisely quantify the amount of glueRED produced under these conditions, we performed the Western blot presented in Figure 2-8. As expected, no DsRED-tagged protein can be detected in the lanes in which EcR-DN or EcRⁱ are expressed in the salivary glands (Figure 2-8B). In addition, the levels of glueRED are not reduced when USPⁱ is expressed in the salivary glands because both control lanes (w1118 x sgGal4; glueRED) and experimental lanes (USPⁱ x sgGal4; glueRED) contain the same band intensities when quantified and adjusted for protein loading using α -Tubulin (Figure 2-8A,B). However, the levels of glueRED are reduced 3 fold when USP is overexpressed

(USP+ x sgGal4; glueRED) in the salivary gland compared to the control and USPⁱ lanes (Figure 2-8B).

One explanation for the reduction, but not elimination of glueRED, is that the amount of USP produced under these conditions is at a threshold level needed to antagonize the 20E-signaling pathway mediated by EcR. To test this hypothesis, we crossed the USP+ line to sgGal4; GFP.nls; glueRED and raised the larvae derived from the cross at two different temperatures (25°C and 29°C). Because temperatures closer to 30°C are reported to produce higher GAL4 activities [43] (probably because GAL4 is a yeast transcription factor), we predicted that larvae raised at 29°C would produce less glueRED (due to the overproduction of more USP that should antagonize 20E receptor formation). As indicated in Table 2-1, these differences were observed when animals were raised at the two different temperatures (53% of the glands failed to produce any glue when raised at 29°C compared to 34% that failed to produce any glue when raised at 25°C). In addition, we confirmed that raising control animals at 29°C did not perturb glueRED production, and raising experimental animals at the elevated temperature did not cause a non-specific induction of the heat shock promoter in other tissues because GFP.nls was only detected in the nuclei of salivary glands (data not shown).

Finally, to ascertain the role of USP in the production of other glue proteins, we compared the overall pattern of protein synthesis using Coomassie staining of SDS-PAGE. As shown in Figure 2-8C, the appearance of most of the glue proteins can be identified when whole salivary-gland-protein extracts are stained because the Sgs genes are abundantly expressed in this tissue. We were able to confirm the presence of the major glue bands by comparing extracts of secreted glue plugs [6] that were prepared as

ethanol precipitates from the lumens of white prepupae (data not shown). As expected, the accumulation of most glue proteins is reduced drastically in glands in which EcRi and EcR-DN are expressed. Also as expected, they are not reduced when USP_i is expressed, but they are affected when USP is overproduced.

Taken together these results are very compelling, and they indicate that USP_i is very efficient at gene silencing in the salivary gland when driven by sgGal4. Therefore, USP is not needed for the 20E-mediated induction of the glue genes through the BRC.

Figure 2-7: Western-blot analysis comparing USP levels derived from different transgenic stocks.

Protein extracts were prepared from larval salivary glands at the white prepupal stage dissected from three different crosses. Flies of the tester stock (*sgGal4; UAS-GFP; glueRED*) were crossed to a control to ascertain the normal amount of USP protein present in third-instar glands (*w¹¹¹⁸*), a line in which RNAi against USP could be produced in the salivary glands under *UAS* control (*USPi*), and a line in which wildtype USP could be overexpressed (USP+) under *UAS* control. The blot was cut; one part was incubated in AB11 antibody against USP and the other was incubated in primary antibody against α -Tubulin as a loading/blotting control.

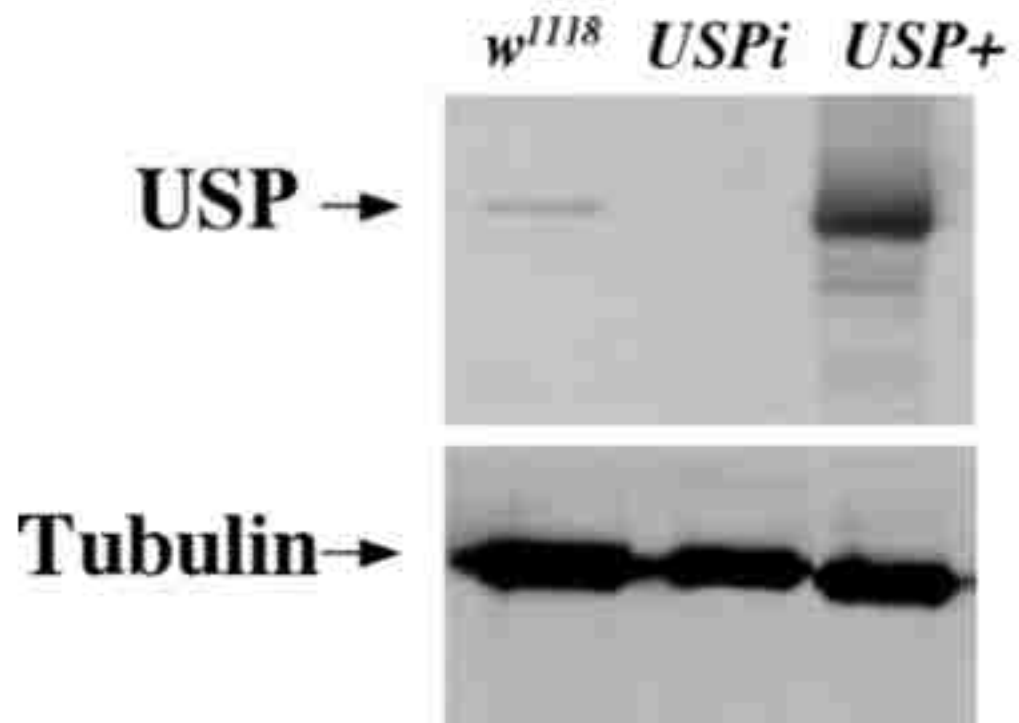
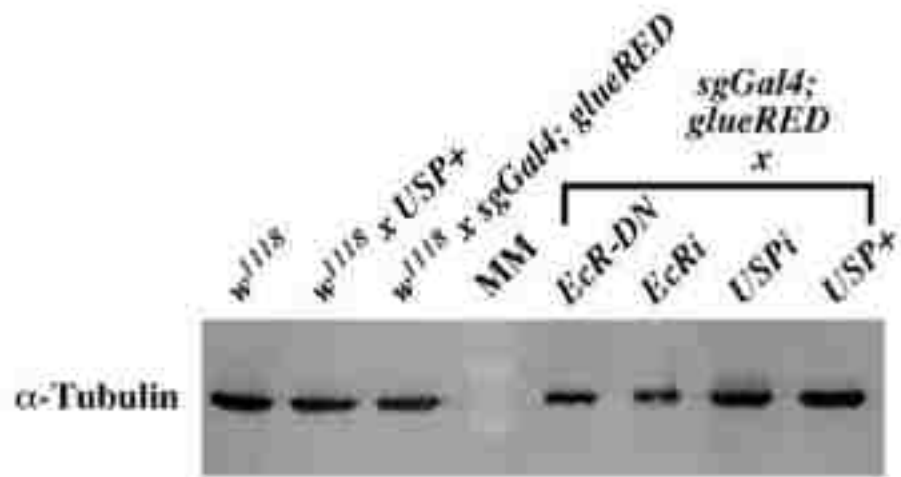
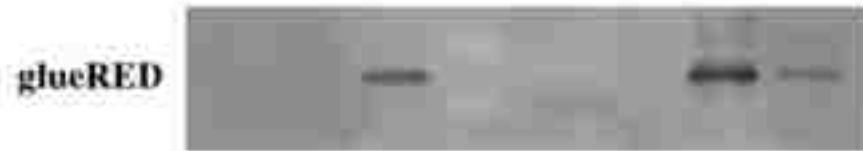
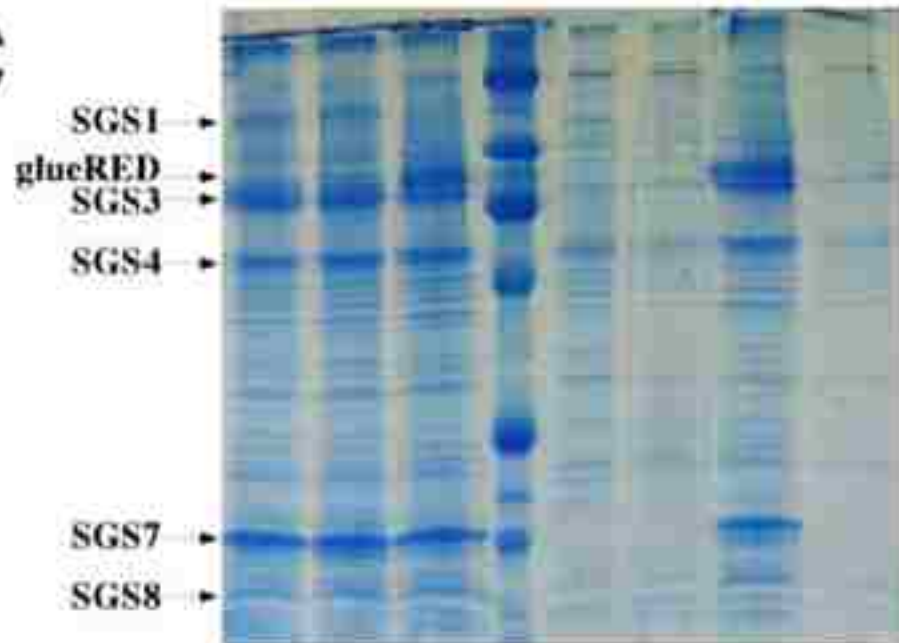

Figure 2-8: Overexpressing USP blocks the synthesis of glue proteins.

Protein extracts were prepared from larval salivary glands at the white prepupal stage dissected from 7 different crosses. Two SDS-page gels were produced, one was stained (bottom) and the other was blotted for the Tubulin loading control (top) or transgenic dsRED (middle). C1 is w^{1118} crossed to *Canton S* as a control for wildtype levels of SGS proteins. C2 is w^{1118} crossed to *sgGal4; UAS-GFP; glue RED* as a “driver only control for endogenous glue and glueRED protein production. C3 is w^{1118} crossed to *UAS-USP+* as a USP responder only control for levels of SGS proteins. The remaining 4 crosses were the tester stock (*sgGal4; UAS-GFP.nls; glueRED*) crossed to *UAS-EcR-DN (DN); UAS-EcR-i (EcRi); UAS-USPi (USPi)* and *UAS-USPwildtype (USP+)*. Note that all glue protein bands from the stained gel are affected by the EcR and USP reagents as predicted according to the model that glue-genes are induced by 20E through a receptor that requires EcR but not USP. The position of glue proteins correspond to band sizes observed when secreted glue plugs were precipitated with ethanol and subjected to SDS/Page.

A**B****C**

2.4: Discussion.

2.4.a: The Glue Genes are Induced by 20E

Previous reports using mutants that are defective in 20E production or signaling yielded contradictory results concerning the role of 20E in the induction of the glue genes in the salivary gland. Here we demonstrate that a glue-gene reporter derived from the *Sgs3* gene can be induced by 20E in cultured glands dissected from wildtype animals at mid L3. Furthermore, unlike the 20E-mediated events that occur at the end of the larval period, the induction of *Sgs3* and other glue genes is mediated by a lower titer of hormone (10^{-9} to 10^{-8} M). This result is consistent with a report of a small titer of 20E that has been detected in a population of synchronized animals two hours prior to the induction of the glue genes [29]. In addition, because the *ecd1ts* mutation probably reduces the concentration of 20E in the hemolymph, mutant animals shifted to the non-permissive temperature might still be exposed to enough 20E to induce the *Sgs* genes. We have also shown that the induction of the glue genes occurs as a secondary response to the hormone because the requirement for EcR can be bypassed if BRC isoforms are ectopically expressed. This finding is supported by published evidence that some 20E-regulated transcription factors (*BRC*, *E74B*) can be induced in cultured organs by a pulse of hormone that is much lower than that produced at the end of the third instar $\sim 10^{-8}$ M versus $\sim 10^{-9}$ M [44].

2.4.b: The Induction of the Glue Genes Requires a Different 20E Receptor

The dogma for the action of 20E during *Drosophila* development is that EcR and USP are associated as a heterodimer and often bound to the EcREs of target genes. When not

bound by ligand, the heterodimer associates with a repressor complex to prevent transcription from those genes. Hormone binding (to the ligand-binding domain of EcR) leads to a conformational change in the complex, the dissociation of the repressor complex, and the recruitment of co-activators for high-level transcriptional activation [reviewed in 19]. Although this model is well supported by evidence that both EcR and USP are required to initiate events during the late-larval and prepupal periods, our study presents compelling evidence for the existence of another bona fide receptor for 20E that consists of EcR but does not use USP as its heterodimeric partner.

We have provided evidence that SGS3 production (and probably glue synthesis in general) is a 20E-mediated event. We have also demonstrated that EcR is required for the induction of the glue genes, and that any isoform of EcR can be involved in the activation of Sgs3. This result is interesting because EcR-B1 is reported to be the predominant form that is normally expressed in the larval salivary gland [45]. Also, because expression of BRC is necessary and sufficient for the induction of Sgs3, these experiments suggest that the A/B domain of EcR does not participate in the expression of BRC by the smaller pulse of 20E that occurs midway through the L3 stage.

In contrast to the results for EcR, we have provided convincing evidence that USP is not the other half of the heterodimer needed for the 20E-mediated initiation of glue synthesis. In a previous report [13] we confirmed that USP mutants can be rescued from embryonic lethality by providing exogenous USP from a heat-shock driven transgene [46]. Furthermore, if these animals are not provided with a source of USP during the L2 and L3 stages (by being deprived of subsequent heat pulses that would induce the transgenic cDNA), they will not pupariate, but they will grow, molt, and express an Sgs3

derived reporter [13].

In the current study we have used strong tissue-specific drivers that are exclusively expressed in the salivary gland at two different time points. We have demonstrated that the USPⁱ stock is an effective reagent for silencing endogenous USP in the salivary gland (Figures 2-6; 2-7), even if it is only produced for 24 hours before the assay (i.e. inducing it with glueGal4 blocks glue secretion). Thus, when it is driven during all larval stages (3 days before glue synthesis) no USP protein can be detected by immunostaining, and this absence of USP protein has no effect on the production of glue. To further confirm that USP is not needed for glue synthesis, we demonstrated that when wildtype USP is overexpressed in the salivary gland during the larval stages, glue protein production is drastically reduced. Because USP is known to heterodimerize with EcR at a later developmental stage, the simplest explanation for this observation is that extra USP protein is preventing EcR from forming the functional 20E receptor needed for glue synthesis in mid L3. Such a result is not expected if only a small amount of functional EcR/USP is needed to induce the glue genes.

Interestingly, other researchers have observed similar effects. One report generated clones of *USP*⁻/*USP*⁻ mutant tissue in the salivary gland, and although they do not discuss the effects of glue production in mutant tissue, the presence of glue granules is apparent in the clones from late-L3 glands [47]. This and other studies also describe the developmental differences of clones of *USP*⁻ tissue in imaginal discs.

For example, movement of the morphogenetic furrow—a 20E mediated event responsible for eye development [48]—is actually accelerated across a *USP*⁻ patch of tissue [49,50]. In addition, others have noted that the 20E-dependent differentiation of

chemosensory neurons in the wing margin occurs precociously in the absence of USP function [51].

Furthermore, when target-gene expression is examined, transcripts from the BRC (BRC-Z1) accumulate earlier in development in mutant clones within the eye and wing discs [47,51]. These observations led to the hypothesis that in the absence of ligand, the EcR/USP heterodimer can act as a repressor in some tissues by binding to the response elements of a select group of target genes. The function of the hormone is to de-repress the target genes by removing the EcR/USP complex from the promoter region allowing other bound transcription factors to activate transcription [34]. Thus in a *USP*- clone, genes controlled by this mechanism should be precociously activated. We do not think that the induction of the glue genes is controlled by a de-repression of BRC through EcR/USP for two reasons. First, the glue genes are not induced (de-repressed) if *EcR* is silenced with an *EcRi* construct. Second, we do not see precocious activation of glue genes when a *USPi* construct is expressed.

Our model proposes that USP is acting as a repressor by heterodimerizing with EcR to prevent the association of EcR with another nuclear-hormone receptor (NR-X). Our hypothesis may also explain some of the data generated with the use of *USP*- clones in imaginal discs. For example, if we assume that movement of the morphogenetic furrow is induced by an earlier and lower pulse of 20E (as has been reported for *Manduca*) [52], we would speculate that furrow movement is controlled by EcR/NR-X regulating downstream genes including BRC-Z1. The normal presence of USP in this tissue at that time might serve to control the amount of functional EcR/NR-X available for high-affinity hormone binding. Thus in a *USP*- clone, we would expect the morphogenetic

furrow to move faster over the patch and the induction of BRC-Z1 to be premature. Such observations were reported [47,49,50].

The normal expression of USP in the salivary gland at mid L3 (Figures 2-6; 2-7) may also be needed to ensure that the response of glue-gene induction is precisely regulated. In any case, the induction of a 20E-regulated pathway that does not require USP as part of the receptor has no precedence in the *Drosophila* literature. Thus, a better characterization of this response at the molecular level is critical for our understanding of normal insect development.

2.4.c: Transcriptional Regulation of the Glue Genes

In this report we demonstrate that EcR is necessary for the expression of most of the glue genes at mid L3, and that USP is not needed for this expression. In addition, we show that any isoform of BRC can be sufficient for Sgs3 transgene expression even if the EcR component of the receptor is compromised with EcR-DN, and that overexpression of some BRC isoforms in first- and second-instar larvae is enough to induce expression of the Sgs3 transgenes days before they would normally be transcriptionally active.

However, it is interesting to note that although Sgs3 and Sgs4 appear to be coordinately expressed in mid-L3 salivary glands, different binding sites for regulatory proteins have been identified in their promoter/enhancer regions. These include response elements for EcR/USP, and binding sites for BRC [40], GEBF- I (FBgn0013970) [53], Forkhead (FBgn0000659) [54–56], and SEBP3 (FBgn0015293) [57]. The binding of different transcription factors to these sites may modulate the levels of expression of the two genes or they may contribute to their restricted expression patterns in the salivary gland or other tissues. For example, although we have shown that Sgs3 derived

transgenes are exquisitely restricted to the salivary glands of third-instar larvae, others have reported the expression of different glue genes in tissues outside this cell type. These include Sgs4 expression in the proventriculus [58] and I71-7 expression in the midgut and hemocytes [59]. Such expression patterns raise the interesting possibility that these highly glycosylated mucin secretions may perform other functions stemming from their propensity to form a sticky substance in aqueous solution. These functions could include the formation of the peritrophic membrane around the food or the formation of extracellular aggregates that might be involved in antimicrobial responses [59].

2.4.d: What is the Composition of the 20E Receptor Responsible for Inducing the Glue Genes?

If we assume that members of the nuclear-hormone receptor superfamily form dimers to produce the active receptor needed for glue-gene expression, we can formulate two hypotheses concerning the composition of that functional receptor. First, the active receptor may be a homodimer of EcR proteins. Homodimers are known to function as receptors for steroid hormones in vertebrates using a different mechanism of ligand activation than that observed with RXR heterodimeric receptors (USP is the insect homolog of RXR), but to our knowledge no biological activity has been ascribed to EcR homodimers during *Drosophila* development. Our analysis does not rule out the possibility that EcR homodimers are responsible for the induction of the glue genes.

The second possibility is that another member of the superfamily may be able to complex with EcR to transmit the hormone signal. Many of these receptors have pre-existing mutations and many more have UAS-RNAi lines that are now available from the RNAi Stock Centers in Vienna (<http://www.vdrc.at>) and Japan

(<http://www.shigen.nig.ac.jp/fly/nigfly/index.jsp>). At this point we have assayed production of glueRED in mutants or RNAi lines that knock down DHR38 (FBgn0014859) and DHR78 (FBgn0015239), but no effects on glueRED synthesis were observed (A. Andres, unpublished observations). However, the existence of transgenic RNAi lines should simplify the analysis because it is expected that when a specific nuclear receptor is silenced in the salivary gland, it should display a phenotype that is defective in glue synthesis. It would then be very interesting to screen the controlling region of the BRC to establish the nature of the EcRE(s) that control the response at the molecular level, and to test if this type of receptor could control other developmental events (perhaps molting of the instars or some aspect of early imaginal disc development) that are regulated by 20E during earlier larval stages.

2.5: References.

1. Henrich VC, Rybczynski R, Gilbert LI. Peptide hormones, steroid hormones, and puffs: Mechanisms and models in insect development. *Vitamins and Hormones*. 1999;55:73–125.
2. Zhimulev IF. Description of a new type of secretion in the larval salivary gland of *D. melanogaster*. *Dros Inf Serv*. 1973;50:46.
3. Thomopoulos GN. Ultrastructure of the *Drosophila* larval salivary gland cells during the early developmental stages. I. Morphological studies. *J Morphol*. 1988;198:329–354.
4. Furia M, D'Avino PP, Crispi S, Artiaco D, Polito LC. Dense cluster of genes is located at the ecdysone-regulated 3C puff of *Drosophila melanogaster*. *J Mol Biol*. 1993;231:531–538.
5. Andres AJ, Fletcher JC, Karim FD, Thummel CS. Molecular analysis of the initiation of insect metamorphosis: A comparative study of *Drosophila* ecdysteroid-regulated transcription. *Dev Biol*. 1993;160:388–404.
6. Korge G. Larval saliva in *Drosophila melanogaster*: Production, composition and relationship to chromosome puffs. *Dev Biol*. 1977;58:339–355.
7. Kress H, Swida U. *Drosophila* glue protein gene expression. *Naturwissenschaften*. 1990;77:317–324.
8. Huet F, Ruiz C, Richards G. Puffs and PCR: The *in vivo* dynamics of early gene expression during ecdysone responses in *Drosophila*. *Development*. 1993;118:613–627.
9. Crowley TE, Meyerowitz EM. Steroid regulation of RNAs transcribed from the *Drosophila* 68C polytene chromosome puff. *Dev Biol*. 1984;102:110–121.
10. Hansson L, Lambertsson A. Steroid regulation of glue protein genes in *Drosophila melanogaster*. *Hereditas*. 1989;110:61–67.
11. Russell S, Ashburner M. Ecdysone-regulated chromosome puffing in *Drosophila melanogaster*. In: Gilbert LI, Tata JR, Atkinson BG, editors. *Metamorphosis, Postembryonic Reprogramming of Gene Expression in Amphibian and Insect Cells*. San Diego: Academic Press; 1996. pp. 109–144.
12. Boyd M, Ashburner M. The hormonal control of salivary gland secretion in *Drosophila melanogaster*: Studies *in vitro*. *J Insect Physiol*. 1977;23:517–523.

13. Biyasheva A, Do T-V, Lu Y, Vaskova M, Andres AJ. Glue secretion in the *Drosophila* salivary gland: A model for steroid-regulated exocytosis. *Dev Biol.* 2001;231:234–251.
14. Jiang C, Baehreche EH, Thummel CS. Steroid regulated programmed cell death during *Drosophila* metamorphosis. *Development.* 1997;124:4673–4683.
15. Berry DL, Baehreche EH. Growth arrest and autophagy are required for salivary gland cell degradation in *Drosophila*. *Cell.* 2007;131:1137–1148.
16. Koelle MR, Talbot WS, Segraves WA, Bender MT, Cherbas P, et al. The *Drosophila* *EcR* gene encodes an ecdysone receptor, a new member of the steroid receptor superfamily. *Cell.* 1991;67:59–77.
17. Thomas HE, Stunnenberg HG, Stewart AF. Heterodimerization of the *Drosophila* ecdysone receptor with retinoid X receptor and *ultraspiracle*. *Nature.* 1993;362:471–475.
18. Yao T-P, Forman BM, Jiang Z, Cherbas L, Chen J-D, et al. Functional ecdysone receptor is the product of *EcR* and *Ultraspiracle* genes. *Nature.* 1993;366:476–479.
19. Riddiford LM, Cherbas P, Truman JW. Ecdysone receptors and their biological actions. *Vitam Horm.* 2000;60:1–73.
20. Brand AH, Manoukian AS, Perrimon N. Ectopic expression in *Drosophila*. In: Goldstein LSB, Fyrberg EA, editors. *Drosophila melanogaster: Practical Uses in Cell and Molecular Biology.* San Diego: Academic Press; 1994. pp. 635–654.
21. Hansson L, Lambertsson A. Ecdysterone responsive functions in the mutant *l(1)su(f)^{ts67g}* of *Drosophila melanogaster*. *Roux's Arch Dev Biol.* 1984;193:48–51.
22. Furia M, D'Avino PP, Digilio FA, Crispi S, Giordano E, et al. Effect of *ecd^l* mutation on the expression of genes mapped at the *Drosophila melanogaster* 3C11-12 intermolt puff. *Genet Res Camb.* 1992;59:19–26.
23. Crowley TE, Mathers PH, Meyerowitz EM. A *trans*-acting regulatory product necessary for expression of the *Drosophila melanogaster* 68C glue gene cluster. *Cell.* 1984;39:149–156.
24. Guay PS, Guild GM. The ecdysone-induced puffing cascade in *Drosophila* salivary glands: A *Broad-Complex* early gene regulates intermolt and late gene transcription. *Genetics.* 1991;129:169–175.
25. Fletcher JC, Thummel CS. The *Drosophila* *E74* gene is required for the proper stage- and tissue-specific transcription of ecdysone-regulated genes at the onset of metamorphosis. *Development.* 1995;121:1411–1421.

26. Berreur P, Porcheron P, Moriniere M, Berreur-Bonnenfant J, Belinski-Deutsch S, et al. Ecdysteroids during the third larval instar in *l(3)ecd-1^{ts}*, a temperature-sensitive mutant of *Drosophila melanogaster*. *Gen Comp Endocrinol*. 1984;54:76–84.
27. Ashburner M. Sequential gene activation by ecdysone in polytene chromosomes of *Drosophila melanogaster*. I. Dependence upon ecdysone concentration. *Dev Biol*. 1973;35:47–61.
28. Fristrom JW, Logan WR, Murphy C. The synthetic and minimal culture requirements for evagination of imaginal discs of *Drosophila melanogaster in vitro*. *Dev Biol*. 1973;33:441–456.
29. Warren JT, Yerushalmi Y, Shimell MJ, O'Connor MB, Restifo LL, et al. Discrete pulses of molting hormone, 20-hydroxyecdysone, during late larval development of *Drosophila melanogaster*: Correlations with changes in gene activity. *Dev Dynamics*. 2006;235:315–326.
30. Bender M, Imam FB, Talbot WS, Ganetzky B, Hogness DS. *Drosophila* ecdysone receptor mutations reveal functional differences among receptor isoforms. *Cell*. 1997;91:777–788.
31. Schubiger M, Wade AA, Carney GE, Truman JW, Bender M. *Drosophila* EcR-B ecdysone receptor isoforms are required for larval molting and for neuron remodeling during metamorphosis. *Development*. 1998;125:2053–2062.
32. Gerlitz O, Nellen D, Ottiger M, Basler K. A screen for genes expressed in *Drosophila* imaginal discs. *Int J Dev Biol*. 2002;46:173–176.
33. Cherbas L, Hu X, Zhimulev IF, Belyaeva E, Cherbas P. EcR isoforms in *Drosophila*: Testing tissue-specific requirements by targeted blockade and rescue. *Development*. 2003;130:271–284.
34. Schubiger M, Carre C, Antoniewski C, Truman JW. Ligand-dependent de-repression via EcR/USP acts as a gate to coordinate the differentiation of sensory neurons in the *Drosophila* wing. *Development*. 2005;132:5239–5248.
35. Matz MV, Fradkov AF, Labas YA, Savitsky AP, Zaraisky AG, et al. Fluorescent proteins from nonbioluminescent *Anthozoa* species. *Nature Biotech*. 1999;17:969–973.
36. DiBello PR, Withers DA, Bayer CA, Fristrom JW, Guild GM. The *Drosophila Broad-Complex* encodes a family of related proteins containing zinc fingers. *Genetics*. 1991;129:385–397.

37. Bayer CA, von Kalm L, Fristrom JW. Relationships between protein isoforms and genetic functions demonstrate functional redundancy at the *Broad-Complex* during *Drosophila* metamorphosis. *Dev Biol.* 1997;187:267–282.
38. Karim FD, Guild GM, Thummel CS. The *Drosophila Broad-Complex* plays a key role in controlling ecdysone-regulated gene expression at the onset of metamorphosis. *Development.* 1993;118:977–988.
39. Chao AT, Guild GM. Molecular analysis of the ecdysterone-inducible 2B5 ‘early’ puff in *Drosophila melanogaster*. *EMBO J.* 1986;5:143–150.
40. von Kalm L, Crossgrove K, von Seggern D, Guild GM, Beckendorf SK. The *Broad-Complex* directly controls a tissue-specific response to the steroid hormone ecdysone at the onset of *Drosophila* metamorphosis. *EMBO J.* 1994;13:3505–3516.
41. Beckendorf SK, Kafatos FC. Differentiation in the salivary glands of *Drosophila melanogaster*: Characterization of the glue proteins and their developmental appearance. *Cell.* 1976;9:365–373.
42. Lehmann ML. *Drosophila Sgs* genes: Stage and tissue specificity of hormone responsiveness. *BioEssays.* 1996;18:47–54.
43. Morimura S, Maves L, Chen Y, Hoffmann FM. *decapentaplegic* overexpression affects *Drosophila* wing and leg imaginal disc development and *wingless* expression. *Dev Biol.* 1996;177:136–151.
44. Karim FD, Thummel CS. Temporal coordination of regulatory gene expression by the steroid hormone ecdysone. *EMBO J.* 1992;11:4083–4093.
45. Talbot WS, Swyryd EA, Hogness DS. *Drosophila* tissues with different metamorphic responses to ecdysone express different ecdysone receptor isoforms. *Cell.* 1993;73:1323–1337.
46. Hall BL, Thummel CS. The RXR homolog Ultraspiracle is an essential component of the *Drosophila* ecdysone receptor. *Development.* 1998;125:4709–4717.
47. Ghbeish N, Tsai C-C, Schubiger M, Zhou JY, Evans RM, et al. The dual role of ultraspiracle, the *Drosophila* retinoid X receptor, in the ecdysone response. *Proc Natl Acad Sci USA.* 2001;98:3867–3872.
48. Brennan CA, Ashburner M, Moses K. Ecdysone pathway is required for furrow progression in the developing *Drosophila* eye. *Development.* 1988;125:2653–2664.
49. Zelhof AC, Ghbeish N, Tsai C, Evans RM, McKeown M. A role for Ultraspiracle, the *Drosophila* RXR, in morphogenetic furrow movement and photoreceptor cluster formation. *Development.* 1997;124:2499–2506.

50. Ghbeish N, McKeown M. Analyzing the repressive function of ultraspiracle, the *Drosophila* RXR, in *Drosophila* eye development. *Mech Dev.* 2002;111:89–98.
51. Schubiger M, Truman JW. The RXR ortholog USP suppresses early metamorphic processes in *Drosophila* in the absence of ecdysteroids. *Development.* 2000;127:1151–1159.
52. Champlin DT, Truman JW. Ecdysteroids govern two phases of eye development during metamorphosis of the moth, *Manduca sexta*. *Development.* 1998;125:2009–2018.
53. Georgel P, Romain P, Giangrande A, Dretzen G, Richards G, et al. *Sgs-3* chromatin structure and *trans*-activators: Developmental and ecdysone induction of a glue enhancer-binding factor, GEBF-I, in *Drosophila* larvae. *Mol Cell Biol.* 1991;11:523–532.
54. Mach V, Ohno K, Kokubo H, Suzuki Y. The *Drosophila* Fork head factor directly controls larval salivary gland-specific expression of the glue protein gene *Sgs3*. *Nucl Acids Res.* 1996;24:2387–2394.
55. Lehmann M, Korga G. The *fork head* product directly specifies the tissue-specific hormone responsiveness of the *Drosophila Sgs-4* gene. *EMBO J.* 1996;15:4825–4834.
56. Lehmann M, Wattler F, Korge G. Two new regulatory elements controlling the *Drosophila Sgs-3* gene are potential ecdysone receptor and fork head binding sites. *Mech Dev.* 1997;62:15–27.
57. Lehmann M, Korge G. Ecdysone regulation of the *Drosophila Sgs-4* gene is mediated by the synergistic action of ecdysone receptor and SEBP 3. *EMBO J.* 1995;14:716–726.
58. Barnett SW, Flynn K, Webster MK, Beckendorf SK. Noncoordinate expression of *Drosophila* glue genes: *Sgs-4* is expressed at many stages and in two different tissues. *Dev Biol.* 1990;140:362–373.
59. Korayem AM, Fabbri M, Takahashi K, Scherfer C, Lindgren M, et al. A *Drosophila* salivary gland mucin is also expressed in immune tissues: Evidence for a function in coagulation and the entrapment of bacteria. *Insect Biochem Mol Biol.* 2004;34:1297–1304.
60. Chao SH, Nagoshi RN. Induction of apoptosis in the germline and follicle layer of *Drosophila* egg chambers. *Mech Dev.* 1999;88:159–172.

61. Zhou X, Zhou B, Truman JW, Riddiford LM. Overexpression of broad: a new insight into its role in the *Drosophila* prothoracic gland cells. *J exp Biol.* 2004;207:1151–1161.
62. Robertson HM, Preston CR, Phillis RW, Johnson-Schlitz DM, Benz WK, et al. A stable genomic source of *P* element transposase in *Drosophila melanogaster*. *Genetics.* 1988;118:461–470.
63. Henrich VC, Sliter TJ, Lubahn DB, MacIntyre A, Gilbert LI. A steroid/thyroid hormone receptor superfamily member in *Drosophila melanogaster* that shares extensive sequence similarity with a mammalian homologue. *Nucl Acids Res.* 1990;18:4143–4148.
64. Bellen HJ, Levis RW, Liao G, He Y, Carlson JW, et al. The BDGP gene disruption project: Single transposon insertions associated with 40% of *Drosophila* genes. *Genetics.* 2004;167:761–781.
65. Wunsch S, Schneider S, Schwab A, Oberleithner H. 20-OH-ecdysone swells nuclear volume by alkalization in salivary glands of *Drosophila melanogaster*. *Cell Tissue Res.* 1993;274:145–151.
66. Vaskova M, Bentley AM, Marshall S, Reid P, Thummel CS, et al. Genetic analysis of the *Drosophila* 63F early puff: Characterization of mutations in *E63-1* and *maggie*, a putative Tom22. *Genetics.* 2000;156:229–244.
67. Christianson AMK, King DL, Hatzivassillou E, Casas JE, Hellenbeck PL, et al. DNA binding and heteromerization of the *Drosophila* transcription factor chorion factor 1/ultraspiracle. *Proc Natl Acad Sci USA.* 1992;89:11503–11507.
68. Laemmli UK. Cleavage of structural proteins during the assembly of the head of bacteriophage T4. *Nature.* 1979;227:680–685.

CHAPTER 3

THE ROLE OF DHR96 AS PART OF A NOVEL RECEPTOR REQUIRED FOR GLUE SYNTHESIS

3.1: Introduction.

Steroid hormone signaling is an essential biological event that is necessary for the successful development of all animals. Proper steroid hormone signaling occurs when a hormone ligand binds to and activates its target nuclear receptor. In vertebrates the activation of the nuclear receptor occurs in the cytoplasm and the hormone receptor complex is transported into the nucleus as a transcription factor that binds to specific DNA regulatory sequence elements to initiate a genetic reprogramming of the target cell type. The activated receptor can take the form of a ligand-bound monomer, homodimer, or heterodimer. In some cases, inactivated nuclear hormone receptors are heterodimers that are in a complex with co-repressors to repress gene activity. When ligand binding activates the nuclear receptor, the co-repressors dissociated and co-activators are recruited to initiate target gene transcription.

In *Drosophila*, 20-hydroxyecdysone (20E) is the systemic steroid hormone responsible for major developmental changes that occur in molting and metamorphosis. Throughout insect development temporal changes of the 20E titer cause diverse physiological responses in the whole animal. For example, 20E is required for the intermolt transition in the larval stage and for metamorphosis (a complete reprogramming of larval tissues) to occur. Although the 20E signaling hierarchy has been studied extensively, the exact nature of how individual tissues respond to different pulses of 20E

remains to be understood. A model tissue that is well suited to address this gap in our knowledge is the third instar (L3) larval salivary gland.

In the final larval stage, the third instar, there is a dramatic whole-body response to two different peaks in the ecdysone titer that are presumably required to set up the genetic programming required for metamorphosis. Warren *et al.* (2005), used a combination of HPLC and radioimmuno assays to carefully identify these pulses in the whole body [1] and validate long held models of temporal genetic reprogramming in the third instar that were classically analyzed by Ashburner as puffs on polytenized chromosomes [2]. In the salivary gland, the two 20E pulses in the L3 stage trigger three distinct events that are temporally distinguished: the synthesis of glycosylated polypeptides (glue), the secretion of glue, and the programmed cell death of the secretory cells of the gland.

The function of the salivary gland prior to the L3 stage is thought to be that of an organ that assists in digestion of food by producing mucins. The larvae spend ~48 hours in the L3 stage. At the end of the L3 stage, the salivary gland secretes glue that aids the organism in securing itself to a substrate during metamorphosis. Once this task is complete, the larval salivary gland activates programmed cell death to make way for the adult structure. 20E signaling coordinates all of these events at different times throughout the L3 stage.

First, a pulse of the steroid hormone at the mid L3 stage occurring around ~68 hours after hatching, or 20 hours after entering the third instar molt, initiates the transcription of glue peptides that when mature become highly glycosylated (glue) and serve as an adhesive substance during metamorphosis [3]. Then, in response to a premetamorphic

pulse of 20E occurring ~40-44 hours after entering the third instar, the salivary gland secretes the mature glue granules into the lumen of the gland and subsequently expectorates the glue in the white prepupal stage (WPP). Lastly, the tissue is removed via programmed cell death by 20E responsive enzymes repressed by Forkhead in the third instar, but de-repressed and able to commit the cells to PCD in response to a prepupal pulse of 20E [4]. We are interested in how 20E causes distinct temporal changes in a specific tissue. To answer this question we turn our attention to the 20E receptor, and hypothesize that differences in the composition of the ecdysone receptor may account for the difference in the temporal response in the salivary gland.

The ecdysone receptor considered to be responsible for the effects of 20E signaling throughout the whole animal is thought to be a heterodimer between EcR and USP. EcR is the vertebrate homolog of the farnesoid receptor (FXR) and USP is the homolog of the retinoic X receptor (RXR). Steroid hormone function in vertebrates has been thought to act via monomers, homodimers, or heterodimers of RXR and another nuclear receptor partner. Because the events in the salivary gland of *Drosophila* require 20E signaling, it was assumed that the signal was regulated through a heterodimer of USP and another receptor. Later, it was discovered that EcR is the receptor that directly binds 20E and thus the model of 20E activation was modified to include the now canonical ecdysone receptor heterodimer of EcR and USP [5]. Given the vertebrate literature at the time, this model was not unreasonable; however, recent evidence elucidates a functional heterodimeric nuclear receptor in vertebrates formed by RAR and thyroid hormone receptor (TR), which does not contain an RXR receptor [6]. The vertebrate model was reinforced by our lab in 2008 when we showed that surprisingly, a 20E response in the

salivary gland (glue synthesis) is EcR dependent but USP (RXR) independent [3]. The vertebrate literature and our finding support a possibility for another novel ecdysone receptor consisting of EcR and another nuclear receptor.

In *Drosophila*, exist 21 nuclear receptors, most of which are transcriptionally regulated by 20E, but many with no known function. However, three receptors are able to bind known EcR/USP DNA binding sites: DHR38, DHR78, and DHR96. Of these three, the *Drosophila* hormone receptor 96 (DHR96) recognizes the same *hsp27* ecdysone receptor response element (EcRE) as the EcR/USP complex as demonstrated in gel shift assays [7]. In addition, DHR96 is thought to be 20E-inducible because it has a temporal expression profile correlating to times of 20E exposure [7].

The *DHR96* gene encodes a 2.8 kb transcript that is expressed throughout the third instar larva and is homologous to the vertebrate vitamin D receptor [7]. It is thought that DHR96 acts as a metabolic sensor for xenobiotics, because it is expressed in tissues known to metabolize xenobiotics [8]. Any loss of DHR96 makes the fly more sensitive to phenobarbital and DDT [8]. DHR96 may also bind cholesterol and regulate triacylglycerol in the midgut [9]. DHR96 mutants are sensitive to starvation and cannot survive on low cholesterol diets and accumulate cholesterol [9]. In these tissues, DHR96 is involved in the pathway to metabolize xenobiotics and to sense and maintain cholesterol homeostasis. However, the function of DHR96 in the salivary gland is not characterized.

I show that silencing DHR96 using RNAi only in the salivary gland results in the absence of glue synthesis. This new model of 20E regulation can answer some questions regarding temporal and spatial specificity within the 20E-signaling pathway, as well as

define a role for DHR96 in the salivary gland. Using an RNAi strategy we propose a model that includes DHR96 as a required receptor for 20E-initiated glue synthesis and a putative constituent of a novel ecdysone receptor. Teasing apart the mechanisms behind 20E glue synthesis serves as a model to uncover other tissue-specific responses to 20E that may include other novel types of ecdysone receptors.

3.2: Materials and Methods.

3.2.a: Fly Stocks

All flies were raised on a cornmeal-soyflour as described in 2.2.a. The RNAi fly lines used in the screen were obtained from the Vienna Drosophila RNAi Center [10] and VDRC stock numbers are listed in Table 3-1. The tester stocks, *glueRED*, *UAS-GFP.nls*; *sgGal4 (RG;sgGal4)*, are described by Costantino et al. 2008 [3].

The *hsp70DHR96* (heat shock inducible full length DHR96) was provided by the Carl Thummel lab at the University of Utah [8]; the *BRC* isoforms were described in 2.2.a [11].

3.2.b: Nuclear Receptor RNAi Screen

To generate the list of candidate receptors we performed a PSI-BLAST [12] using the EcR.A (FBpp0085349) as a seed sequence to search the non-redundant protein sequence database specific for *Drosophila melanogaster*. We used the default parameters set for the PSI-BLAST algorithm with the inclusion factor set to 0.005. Table 3-1 was created after iteration five of the PSI-BLAST.

Virgins from each of the VDRC fly lines were crossed to *RG;sgGal4* and kept at 25°C. Late third instar larvae from each cross were analyzed for glueRED synthesis

under fluorescent microscopy using a Leika fluorescent stereo microscope containing filter cubes for GFP and DsRED.

3.2.c: DHR96 Western Blot and Immunohistochemical Staining

Tissue stains and Western blots were done using a polyclonal antibody against DHR96 that was kindly provided by Carl Thummel. For the tissue stains, the salivary glands were dissected in DPBS as described in Vaskova et al. 2000 [13] and transferred to tubes containing 600 μ L of 4% paraformaldehyde (JT Baker S898-07) in PBS. The tissue was fixed for 30 minutes and washed with PBS, 0.3% Triton X-100 (PT) four times for 10 minutes each. The wash was replaced by PBS, 0.3% Triton X-100, 2% BSA fraction V (Sigma #A-2153) (PBT), then the tissue was incubated for 60 minutes, followed by PBS, 0.3% Triton X-100, 2% BSA fraction V, 3% normal goat serum (PBT-S) for 60 minutes. The PBT-S solution was replaced with primary DHR96 antibody diluted 1:100 in PBT-S, and the tissue was incubated over night at room temperature. Tissues were rinsed five times for 15 minutes in PT, 20 minutes in PBT, 30 minutes in PBT, and finally 30 minutes in PBT-S. The PBT-S was replaced with goat anti-rabbit rhodamine-conjugated secondary antibody diluted 1:1000 in PBT-S and incubated at room temperature for 4 hours. The tissue was then washed four times for 15 minutes in PT and mounted on slides in Gel/Mount from Biomedica.

Protein extracts for Western blot analysis were prepared by dissecting 30 glands from each group in DPBS. For the hsDHR96 sample, the larvae were heat shocked twice (with a 1 hour rest at 25°C in between) in a water bath at 36°C in vials containing ~ 0.50 g of *Drosophila* media to prevent desiccation and then dissected as normal. The samples were centrifuged at 10,000 rpm to pellet the glands and then resuspended in a lysis solution

containing a cocktail of protease inhibitors. A 1:1 dilution of Laemmli buffer plus β -mercaptoethanol (BME) were added to the samples and subsequently, homogenized and boiled for five minutes. The samples were loaded into a 12% SDS-polyacrylamide gel and then transferred to Immobilon P membranes (Millipore). Blots were incubated with rabbit anti-DHR96 primary diluted 1:500 and mouse anti- α tubulin primary (Sigma) diluted 1:15,000. Secondary antibody incubation was with goat anti- mouse-HRP secondary (Jackson Immuno Research) diluted 1:40,000; and goat anti-rabbit-HRP secondary (Jackson Immuno Research) diluted 1:25,000. Detection and quantification was performed using Protein levels were visualized and quantified using Chemi- luminescence ECL(+) Western-blotting detection system (GE Healthcare) and a Typhoon 8600 Variable Mode Phosphorimager (GE Healthcare).

3.2.d: DHR96 qRT-PCR

RNA was extracted from 20 third instar larvae from each group using RNeasy Mini Kits (Qiagen, Valencia CA, USA Cat. #74104) and treated with Turbo DNA-*free* (Ambion Austin, TX USA Cat. #AM1907). The cDNA was made using SuperScript First-Strand (Invitrogen Carlsbad, CA USA Cat. #11904). qRT-PCR primers used for the reference gene, β -actin were: 5'-TCTACGAGGGTTATGCCCTT-3' and 5'-GCACAGCTTCTCCTTGATGT-3'. For the target gene, DHR96, the primers used were: 5'-GATGTGGAGCGTCTGAACAA-3' and 5'-TCATCATTGGGCATCAACAT-3' (corresponding to Exon 6 of the DHR96 mRNA transcript). Each reaction was done in triplicate on a Bio-Rad iCycleriQ Real Time PCRSys system, and experimental C_t values were normalized to β -Tubulin using $\Delta\Delta C_t$ statistical analysis. Primer efficiency for both primer sets is 2.0.

3.2.e: Scoring Flies in GlueRED Synthesis and Secretion Experiments

In the experiments involving overexpression of either the EcR.B isoforms or the BRC isoforms, glueRED synthesis was determined by observation under fluorescent microscopy. Larvae were marked as “no synthesis” if no glueRED detection was observed. If detection of glueRED was observed in half or less of the cells in the larval salivary glands those larvae were categorized as “partial synthesis”. “Complete synthesis” was noted when most or all cells of the salivary gland expressed glueRED.

To determine glue secretion in Figure 3-7, WPP were observed under fluorescent microscopy. Figure 3A served as the criteria for counting either secretion (right) or no secretion (left). It is important to note that some animals exhibited partial secretion in which the glueRED expectorated onto the body of the animal was not as robust as Figure 3-7A right. These, however, were still considered secretion positive in the study.

3.2.f: Microscopy and Imaging

Low-resolution images of whole animals or dissected tissues were obtained on a Leika fluorescent stereo microscope containing filter cubes for GFP and DsRED. Images were captured with the Spot Insight QE Model #4.2 digital camera (McBain Instruments, Chatsworth, California, United States) and prepared with Canvas (ACD Systems, Miami, Florida, United States) graphics software.

High-resolution images of dissected salivary glands were imaged on a LSM 510 Axioplan confocal microscope (Carl Zeiss SMT, Peabody, Massachusetts, United States) equipped with LSM 510 image-analysis software.

3.3: Results.

3.3.a: DHR96 Knockdown Prevents Glue Synthesis

A strongly held model about 20E signaling is that it occurs through the ecdysone receptor, which is a heterodimer between EcR and USP. The model assumes that only EcR and USP can form the ecdysone receptor required for a variety of temporal and spatial responses to 20E. This model is supported by work done by Yao *et al.* (1992) showing that EcR and USP form a receptor complex on EcREs in cell nuclear extracts and later [14] showing that EcR and USP colocalize to 20E responsive sites on polytene salivary gland chromosomes [15, 14]. However, these data do not sufficiently address how the 20E-response can have temporal and spatial differences. Our lab has shown that glue synthesis is a 20E induced event, but does not operate through the classically established EcR/USP ecdysone receptor [3]. A functional EcR protein is necessary, but USP is not required for glue synthesis. These results were exciting because it suggested that a novel ecdysone receptor was functioning during the mid third instar of the salivary gland.

Consequently, to challenge the original model of the ecdysone receptor we first compiled a list of candidate receptors using a position specific iterative basic local alignment search tool (PSI-BLAST) algorithm. The amino acid sequence of EcR-A was used in the initial run of the PSI-BLAST to build a protein profile of all proteins in *Drosophila* with multiple alignments that generated high scoring pairs to one another. After five iterations of the PSI-BLAST, 21 total (including EcR) putative nuclear hormone receptors (Table 3-1) were detected above the e-value threshold. These results

confirmed previous data reported in a review of *Drosophila* nuclear receptors by King-Jones and Thummel [16], with the addition of three putative receptors with significant sequence similarity: knirps like (Knrl) (FBgn0001323), knirps (Kni) (FBgn0001320), and eagle (eg) (FBgn0000560). Because Knrl and Kni lack the ligand-binding domain, some do not consider these as true nuclear receptors [17]. This list was generated to create a database of putative nuclear receptors we could use to individually test for a role in glue synthesis. My hypothesis was that because expression of EcRi blocks glue synthesis, expression of an RNAi that targets each member of this list would uncover the other receptor involved in 20E-mediated glue synthesis. Assuming that glue synthesis is also controlled by a heterodimer, the approach was to find the other putative ecdysone receptor, partnering with EcR, by systematically screening this list for a block in glue synthesis using RNAi constructs available from the VDRC.

The VDRC has generated a collection of fly lines with RNAi constructs under *UAS* control that cover all 21 receptors (Table 3-1). The screening strategy we developed involved crossing virgin females carrying a nuclear location signal tagged to a GFP sequence (*GFP.nls*), *sgs-3* tagged with dsRED (*glueRED*) and a salivary gland specific driver (*sgGal4*) (abbreviated as *RG*; *sgGal4* as reported in [3]) to males from each VDRC line. If our glue synthesis model is correct, we would expect to see a block in glueRED synthesis in *EcRi* lines and also a block in synthesis in one of the other RNAi receptor lines. Under fluorescent microscopy, we monitored for glueRED expression in third instar larvae from each group. The screen confirmed that driving *EcRi* in the salivary gland does block glue synthesis and, additionally, that expressing an RNAi targeting *DHR96* (*DHR96i*) also blocked glue synthesis (Table 3-1 and Fig. 3-1).

Table 3-1: Nuclear receptors in *Drosophila* and VDRC stock numbers used in an RNAi screen for a block in glue synthesis.

Gene Symbol	Synonyms	Chromo	Isotforms	Cyto Location	RNAi Glue Synthesis	VDRC Stock #	Vertebrate Homolog
<i>EcR</i>	<i>CG1765</i>	2R	5	42A9-41A12	-	37058, 37059	HAR
<i>top</i>	<i>NR1B4</i>	X	1	2C7-2C7	+	16893	RXR
<i>HR39</i>	<i>CR8076</i>	2L	4	39B4-39C1	+	37694, 37695	LRH-1, SF-1
<i>Eip73B</i>	<i>E75</i>	3L	4	75A16-75B6	+	44851, 108399	REV-ERBA
<i>HR46</i>	<i>DHR3</i>	2R	3	46F5-46F7	+	12044, 20157, 106857	ROAlpha
<i>CG16801</i>	<i>PNR, HRM1</i>	2R	3	51F7-51F7	+	37617, 37618	PNR
<i>myf</i>	<i>NR2F3</i>	3R	3	87B4-87B5	+	37086, 37087, 100762	COUP TF-1
<i>hl</i>	<i>NR4E2</i>	3R	1	100A6-100A6	+	6236	TLX
<i>Hsp4</i>	<i>Homotetran Nucleolar Protein4</i>	2L	3	29E4-29E4	+	12692	HNF4A
<i>HR28</i>	<i>Estrogen Related Receptor</i>	2L	2	38D5-38E3	+	2970, 2971, 104178	NR4A, NURR1
<i>ERR</i>	<i>Receptor</i>	3L	2	66B11-66B11	+	108349	ERRb
<i>Eip78C</i>	<i>E78</i>	3L	3	78C2-78C3	+	10396	REV-ERBA
<i>dsf</i>	<i>disulfidation</i>	2L	1	26A1-26A2	+	33909	TLX
<i>Rb-F1</i>		3L	2	75D8-75E1	+	37694, 37695	LRH-1, SF-1
<i>HR78</i>		3L	4	78D4-78D4	+	37072, 37073, 48978, 48979, 109435	TR2
<i>HR96</i>	<i>NRL11</i>	3L	1	96B16-96B17	-	10958	VDR
<i>CG10290</i>	<i>Fant, HR83</i>	3R	1	83E4-83E4	+	31208, 31209, 103211	PNR
<i>HR4</i>	<i>GRF</i>	X	1	3C1-2C1	+	37066, 37067, 102096, 102361	GCNF
<i>Kat1</i>	<i>Knappa like</i>	3L	1	77D4-77E1	+	47216, 47217	
<i>Kat</i>	<i>Knappa, NR0A1</i>	3L	1	77E3-77E3	+	2980, 2981	
<i>Eg</i>	<i>Esple</i>	3L	2	78F2-78F3	+	7157, 21762	

21 putative nuclear hormone receptors revealed in a PSI BLAST and used in the RNAi screen for a block in glueRED synthesis are listed. The VDRC stock numbers for each gene are listed, with some genes containing more than one RNAi line. In the column labeled glue synthesis, we list the results of the screen, (-) indicates no glueRED detected in the late third instar stage and (+) indicates the presence of glueRED in the late third instar salivary gland cells. EcR and DHR96 RNAi lines were the only two receptor knockdowns to show a complete block in glue synthesis. No partial or late block in synthesis was detected in + lines.

Figure 3-1: Using RNAi to silence DHR96 in the salivary gland blocks glue synthesis.

Confocal images of dissected salivary glands from larvae expressing either (A) no UAS responder, (B) *USPi* or (C) *DHR96i*. Driving the expression of (B) *USPi* in salivary glands did not block glue synthesis as we expected from our reports in Costantino *et al.* 2008, but (C) driving the expression of *DHR96i* in the glands did block glue synthesis.

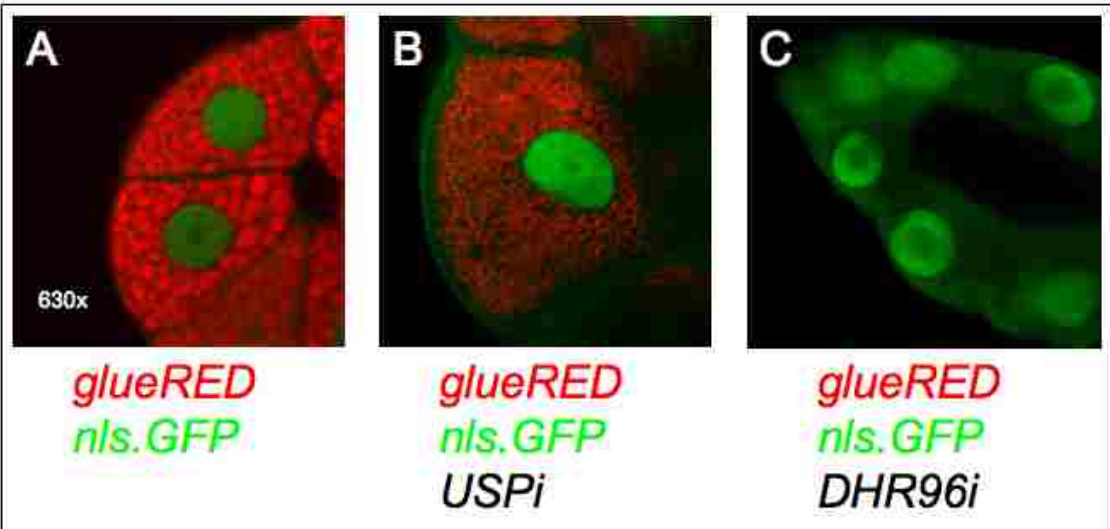

To be certain that *DHR96i* was indeed knocking down endogenous *DHR96* we performed tests using three different techniques to analyze both protein and *DHR96* mRNA levels. Initially, a Western blot was performed using a polyclonal antibody generously donated by the Thummel lab and described by King-Jones *et al.* 2005 [8]. We made use of an available full length *DHR96* cDNA construct under the control of a heat shock 70 promoter (hsDHR96) [8] to be a full-length reference for DHR96 migration in our western blot. Heat shocking the hsDHR96 larvae twice at 37°C for one hour, with an approximately one hour room temperature rest period, enriches full-length DHR96 amounts in the organism providing us with a reference band of DHR96 protein shown in lane 1 of Figure 3-3. Third instar larvae salivary glands were dissected from 30 individuals from either control (*RG; sgGal4*), or *DHR96i* (*RG; sgGal4/UAS-DHR96i*) and blotted [8]. The western blot indicates that DHR96 protein levels were >90% lower in salivary glands of DHR96i larvae (Fig. 3-3). Next, we wanted to evaluate levels of DHR96 in an immunostain from larvae expressing *DHR96i* only in the salivary gland cells compared to the neighboring fat body tissue dissected from the same animals.

Published reports of the DHR96 polyclonal antibody were validated in immunostains of different tissue types including the fat body and salivary gland [8]. Both the fat body and salivary glands were shown in these reports to be positive for DHR96 in the nuclei of these tissues. We repeated these experiments using salivary glands with attached fat body dissected from larvae that contained the *sgGal4* salivary gland specific driver to express *UAS-DHR96i* only in the salivary glands or *sgGal4* alone. Because we are driving the expression of *DHR96i* only in the salivary glands the cell nuclei show an absence of protein compared to the neighboring fat body cell nuclei (Fig. 3-2). This stain is a good

measure of the ability of *DHR96i* to silence DHR96 protein only in the salivary gland, because published reports describing DHR96 as a xenobiotic sensor in the fat body not only relied on this data, but also saw expression in the salivary gland and could not determine a salivary gland function for DHR96 [8]. Thus, we had an effective reagent that can silence *DHR96* only in the salivary gland.

Lastly, to measure the knockdown of *DHR96* transcripts throughout the whole larvae we drove the expression of *DHR96i* using a whole body driver (*Act5c-Gal4*) and quantitatively compared the levels of transcript between *DHR96i* (*Act5c-Gal4; UAS-DHR96i*) and a control (*Act5c-Gal4*). Flies can live without a functional DHR96 as demonstrated by the Thummel lab, so with this knowledge we could evaluate the effectiveness of the knockdown in the entire third instar larva without lethality as an obstacle. RNA preparations from the control group and *DHR96i* group were made as a template for reverse transcription. After quantification of the qRT-PCR we detected a 5-fold decrease of *DHR96* transcript in the *DHR96i* group compared to the control (Fig. 3-4). The qRT-PCR, western blot and tissue stain all convincingly validate the *UAS-DHR96i* reagent from VDRC, thus supporting the hypothesis that DHR96 is required for 20E induced glue synthesis in the larval salivary gland.

Figure 3-2: DHR96 immunohistochemical stain.

Fixed salivary glands from (A) wildtype or (B) *DHR96i* larvae were stained with a DHR96 polyclonal antibody. Nuclear staining was observed in the fatbody and salivary gland in wildtype tissue, but only in the fatbody in dissected tissue driving the expression of *DHR96i* only in the salivary gland. The white dashed line outlines the salivary gland.

A



B



Figure 3-3: Western blot of DHR96i salivary glands.

A Western blot was performed on homogenates prepared from 30 salivary glands dissected from either heat shocked hsDHR96, parental (sgGal4/+), or DHR96i (sgGal4/UAS-DHR96i). The hsDHR96 lane represents full length DHR96 and migrates at 98kD. When quantified and normalized to the wild type, DHR96 protein is undetectable.

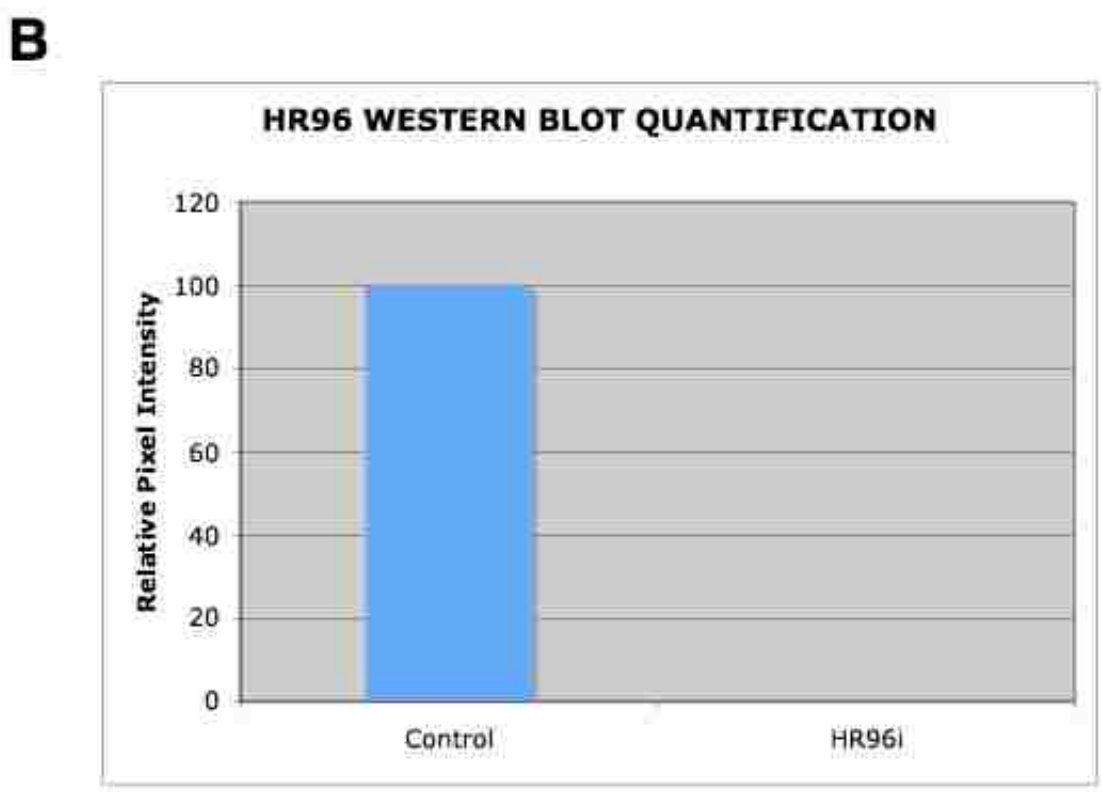
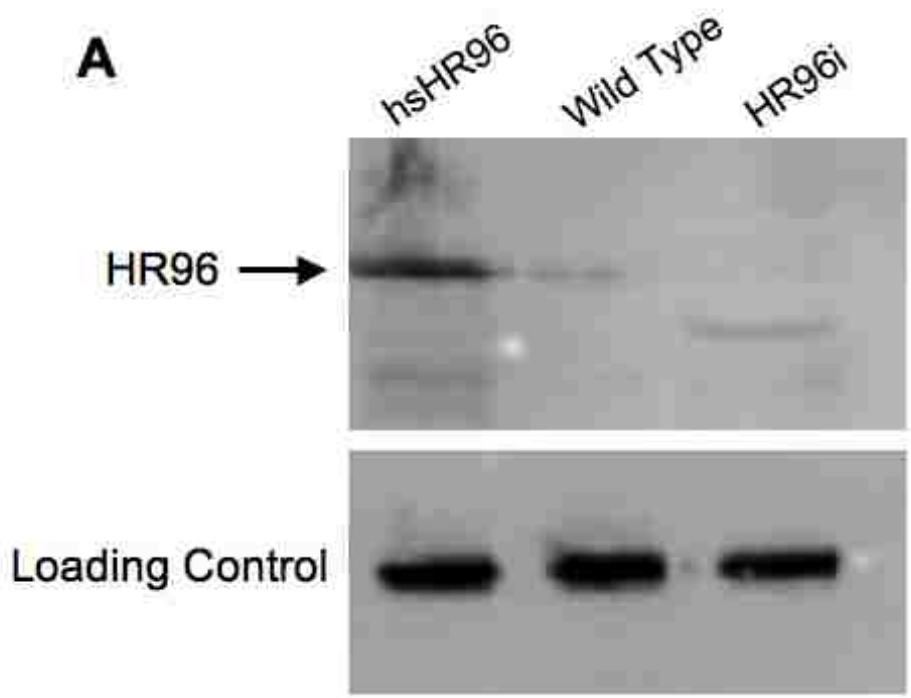
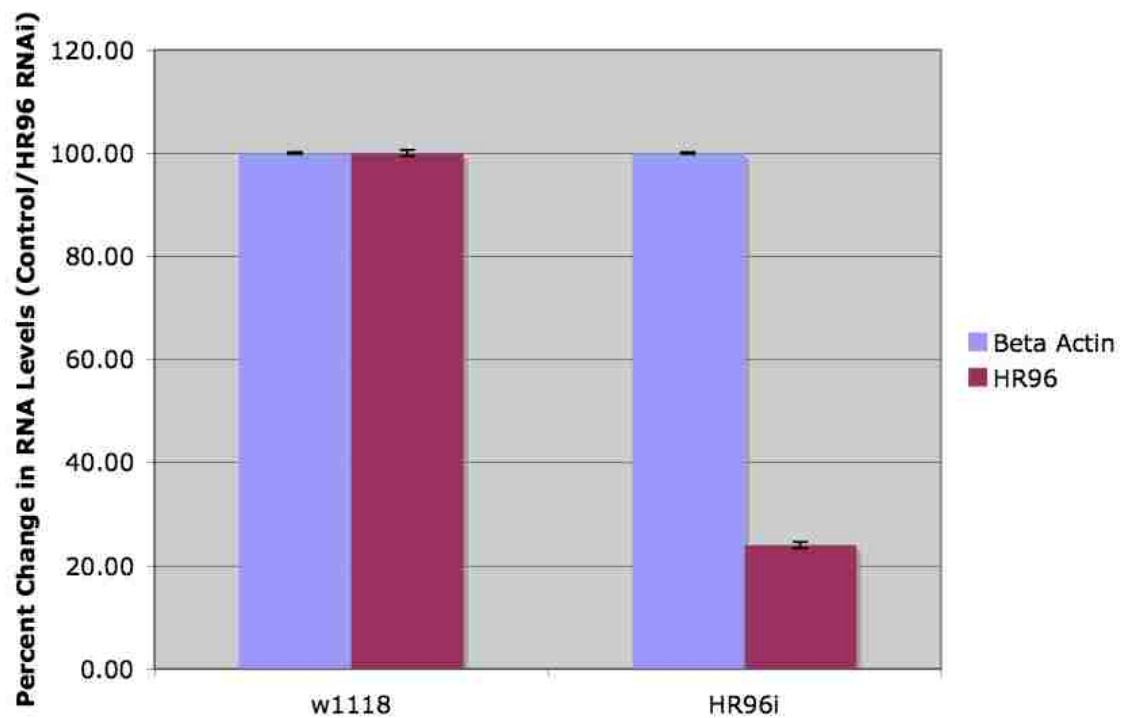

Figure 3-4: DHR96 transcript levels are reduced in *DHR96i* lines.

A qRT-PCR of DHR96 cDNA generated from RNA preparations from either control (*Actin5c-Gal4*) or DHR96i (*Actin5c-Gal4; UAS-DHR96i*) larvae indicate ~75% reduction in DHR96 transcript levels in DHR96i.

qRT-PCR Levels of HR96 RNA in Wildtype Cells vs. Cells Expressing HR96 RNAi



3.3.b: DHR96i is Not Affecting EcR Levels

A potential caveat with the *DHR96i* reagent was that it could perturb the natural EcR function due to an off-target *RNAi* effect. To address this, we made lines of flies that carried both a *UAS-EcR* isoform and *UAS-DHR96i* with the idea that if cross reactivity was not an issue then overexpressing EcR at the time *DHR96* is silenced would not have an effect on the phenotype and we would still see a block in glue synthesis. If the *DHR96i* reagent was affecting EcR function, then adding back EcR protein would recover the phenotype and we would see glueRED synthesized.

Our scheme was to monitor glueRED synthesis using three categories: no synthesis, partial synthesis (1-3 individual cells expressing glue) or complete synthesis. This approach was validated in Costantino *et al.* 2008. The EcR-B1 isoform is the receptor reported to be active in salivary glands, though both EcR-B isoforms can activate glue synthesis [3]. We drove the expression of the transgenes using the *sgGa4* driver. The results of overexpressing the EcR-B isoforms in *DHR96i*-expressing backgrounds show a block in glue synthesis similar to that observed in the larvae expressing *DHR96i* by itself (Table 3-2); indicating that DHR96 is necessary for glue synthesis to occur regardless of EcR rescue.

Table 3-2: Overexpressing EcR isoforms do not rescue the block in glue synthesis.

Genotype	No Synthesis	Partial Synthesis	Complete Synthesis	Total
RG; sgGal4/ +	0%	0%	100%	53
RG; UAS-HR96i/ sgGal4	100%	0%	0%	120
RG; UAS-EcRi/ sgGal4	100%	0%	0%	49
RG; UAS-EcR-B1, UAS-EcRi/ sgGal4	0%	0%	100%	51
RG; UAS-EcR-B1, UAS-HR96i/ sgGal4	68%	32%	0%	103
RG; UAS-EcR-B2, UAS-HR96i/ sgGal4	93%	7%	0%	101

3.3.c: The Block in Glue Synthesis Caused by DHR96i is Rescued by Broad Complex Isoforms

The *Broad Complex (BrC)* is a complex transcription unit that gives rise to several complementation groups coding for four isoforms of zinc-finger transcription factors known as BRC-Z1, BRC-Z2, BRC-Z3 and BRC-Z4. These transcription factors all play a role in the synthesis of glue proteins based on studies done on isoform-specific null or hypomorphic mutations [18-20]. For example, in mutants for the *BrC* complementation group *npr1* (*non-pupariating*) the expression of the glue genes *sgs-3*, *sgs-7*, and *sgs-8* is undetected [19]. Also, heterozygotic mutants of the *rbd* (*reduced bristles on palpus*) complementation group showed a severe reduction of *sgs-3*, *sgs-4* and *sgs-5* transcripts [19].

Genes of the *BRC* transcriptional unit are direct targets of 20E signaling, in the sense that the 20E activated receptor complex binds directly to regulatory elements upstream of *BRC* to induce the expression of the *BRC* isoforms [21]. These observations are convincing evidence that glue gene synthesis occurs as a secondary response to 20E signaling and the glue induction pathway involves 20E induction of the *BRC* isoforms [3, 22].

We have established that EcR fits into the glue synthesis pathway by performing experiments compromising EcR function [3]. The block in glue synthesis caused by a dominant negative version of EcR or *RNAi* targeting *EcR* can be rescued by overexpressing any one of the *BRC* isoforms in the salivary gland [3]. With this knowledge, if DHR96 is a component of a novel ecdysone receptor with EcR in the glue pathway, DHR96 would logically function upstream of the *BRC* pathway. This would

imply that the same rescue experiment done for EcR would produce similar results when done with flies expressing *DHR96i*.

To test the hypothesis that *BRC* isoforms can rescue the block in glue synthesis caused by *DHR96i* expression, we constructed a set of fly lines that contained versions of the *BRC* isoforms under the control of *UAS* and the *DHR96i* transgene. These flies were crossed to the *RG; sgGal4* tester stock and salivary glands were scored using three categories (no synthesis, partial synthesis or complete synthesis). As shown in Table 3-3, all *BRC* isoforms can rescue the *DHR96i* block in glue synthesis at varying levels. *BRC-Z1* showed the highest rescue (59%) and *BRC-Z4* showed the least (1.6%) (Table 3-3). These results are consistent with a similar analysis that we reported for EcR [3].

Table 3-3: Broad Complex overexpression rescues the block in glue caused by DHR96i.

Genotype	No Synthesis	Partial Synthesis	Complete Synthesis	Total
<i>sgGal4</i> <i>UAS-GFP.nls</i> <i>UAS-HR96i</i> <i>glueRED</i> <i>UAS-BRC-Z1</i>	15%	26%	59%	73
<i>sgGal4</i> <i>UAS-GFP.nls</i> <i>UAS-HR96i</i> <i>glueRED</i> <i>UAS-BRC-Z2</i>	48%	2%	50%	61
<i>sgGal4</i> <i>UAS-GFP.nls</i> <i>UAS-HR96i</i> <i>glueRED</i> <i>UAS-BRC-Z3</i>	42%	0%	58%	88
<i>sgGal4</i> <i>UAS-GFP.nls</i> <i>UAS-HR96i</i> <i>glueRED</i> <i>UAS-BRC-Z4</i>	86%	13%	1%	56

3.3.d: Overexpression of DHR96 Competes with USP in the Late Larval Salivary Gland

Demonstrating that DHR96 can be a viable heterodimeric partner with EcR is the key determinant to qualify the protein as a component in a putative novel ecdysone receptor functioning to mediate glue synthesis. We have shown that overexpressing USP prior to the mid-third instar pulse of 20E blocks the synthesis of glue [3]. We hypothesized that USP outcompetes the natural receptor required for glue synthesis for EcR binding. If the block in glue synthesis shown in Costantino *et al.* [3] is due to competition with another receptor for EcR dimerization, then it is reasonable to suggest that the reciprocal experiment would have the same effect on USP dependent events in the salivary gland. By showing that DHR96 can outcompete USP when USP is required for a 20E response, we can further validate the hypothesis that EcR and DHR96 could form a functional ecdysone receptor required for glue synthesis.

The EcR/USP heterodimer is required for glue secretion in response to a pre-metamorphic titer of 20E occurring 16 to 18 hours prior to pupariation (late third instar). To elucidate the possibility of DHR96 acting as a heterodimeric partner with EcR, we used heat shock inducible transgenic flies (hsDHR96) to overexpress DHR96 just after the onset of glue synthesis in the mid-third instar, but before the premetamorphic pulse of 20E. We hypothesized that overexpression of DHR96 would compete with USP for EcR binding and block USP-dependent glue secretion. Larvae were divided into four categories: unheated control (glueRED), heat shock control (glueRED), unheated hsDHR96, and heat shock hsDHR96. Larvae from all groups contained the glueRED marker that we used as a stage determinant. Glands not expressing the glueRED are <20 hours into the third instar and prior to the mid-third instar pulse of 20E, glands half full

with glueRED are ~24 hours into the third instar and have been exposed to the mid third instar pulse of 20E, glands completely full of glueRED are over 32 hours into the third instar and just prior to the premetamorphic high titer late third instar pulse of 20E. For this experiment, larvae from each group were monitored and selected at between 24 to 32 hours after the final molt, just prior to the premetamorphic pulse of 20E in which USP is required for glue secretion. Cohorts of larvae were either heat shocked twice for 1 hour at 36°C with a 2-hour break between (+heat shock) or not heat shocked and remained at 25°C (-heat shock). Secretion of glueRED was examined at the white prepupal (WPP) stage noting secretion as shown in Figure 3-7. Analysis of glueRED secretion in the groups indicate a greater than 75% block in secretion in the hsDHR96 heat shocked treated groups (Fig. 3-7). There was little to no effect of the actual heat shock treatment, and the full-length DHR96 produced by the hsHR96 transgene is functional as shown in gain-of-function studies [8]. This result is exciting because it provides evidence that DHR96 can outcompete USP for EcR binding and strengthens the earlier reciprocal experiments. Additionally, this experiment provides a model that other nuclear receptors have the potential to temporally modulate the 20E signal by binding to EcR and forming an ecdysone receptor.

Figure 3-5: Overexpressing DHR96 in the late third instar blocks glue secretion.

hsDHR96 was used to overexpress the full length DHR96 protein in late third instar larvae prior to the premetamorphic pulse of 20E. All larvae carried a glueRED marker; those larvae from each group that partially expressed glueRED were not exposed to the premetamorphic pulse of ecdysone yet and selected for the experiment. Wildtype and hsDHR96 groups were either given 2 heat shocks at 36°C with 1 hour recover in between or left at 25°C. After the final heat shock treatment WPP were scored based on expulsion/secretion of glueRED (A left) or absence of secreted glueRED (A right). (B) The scores are presented as percent secretion of glueRED and indicate absence of secretion greater than 75% in heat shocked hsDHR96 flies.

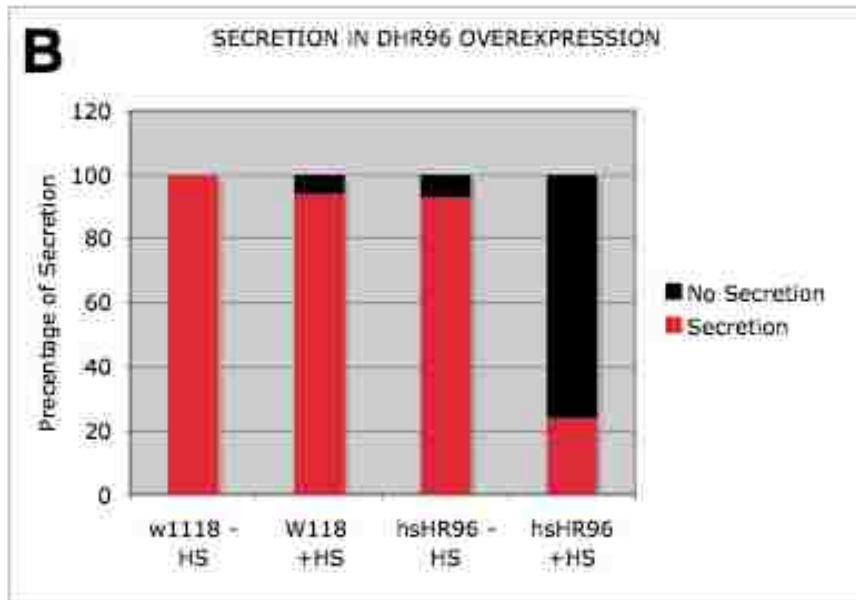
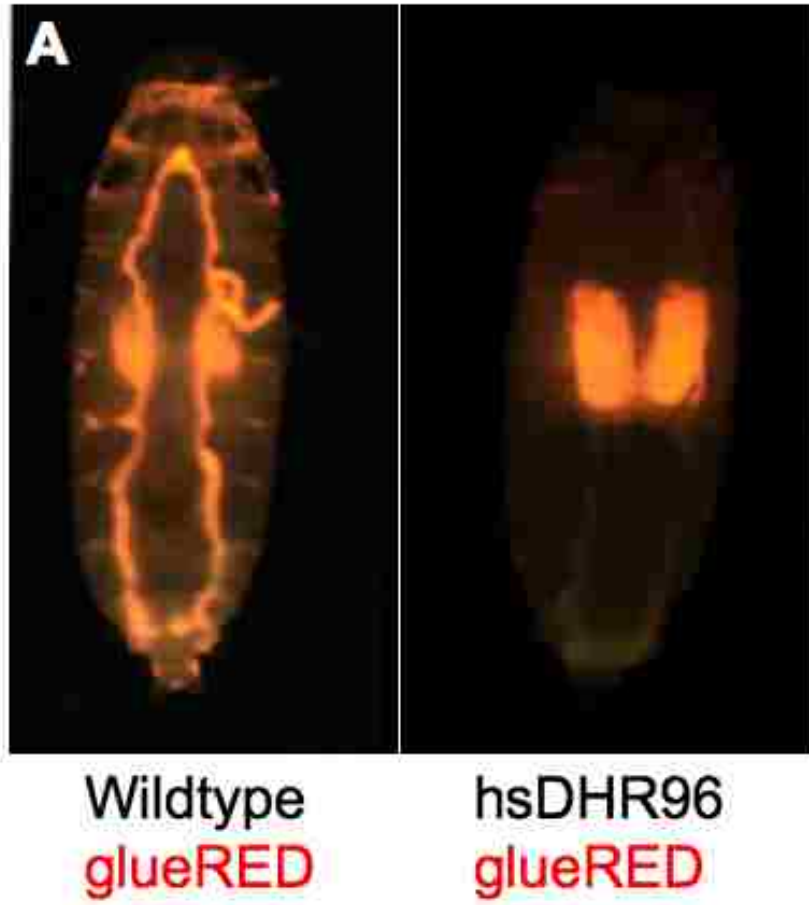

3.4: Discussion.

The 20E-responsive genes and the physiological requirement of the 20E cascade have been well characterized. However, the mechanism by which 20E spatially and temporally acts on specific tissues remains unclear. Our model considers a new ecdysone receptor in mediating a specific temporal change in the 20E response; the mid-third instar. The canonical model of the ecdysone receptor has always been thought of as a heterodimer between EcR and USP, but we have shown that USP is not required to synthesize glue and can block glue synthesis when USP is overexpressed at the mid-third instar stage [3]. To further define our hypothesis, we considered the possibility that another of the 19 nuclear receptors acts as a partner with EcR to form a novel ecdysone receptor that is required for glue synthesis in the mid-third instar stage of larval development. We show in Figure 3-1 that driving the expression of an RNAi to silence the DHR96 in the salivary gland was sufficient to block the synthesis of glue.

King-Jones et al. showed immunostaining of DHR96 in the nuclei of all metabolic tissues and the salivary gland [8]. Data from the Thummel lab indicate that DHR96 may act as a metabolic sensor capable of conferring xenobiotic resistance and cholesterol homeostasis. However, a role for DHR96 in the salivary gland was not known. Our data, suggests a new model of 20E regulation that involves a novel ecdysone receptor in which EcR and DHR96 are a primary composition. We validated previous experiments showing that DHR96 is found in the nuclei of fat body and salivary gland cells (Fig. 3-2) and that DHR96 has a temporal expression pattern in the salivary gland at a time required for glue synthesis. Furthermore, our data suggest that like EcR, DHR96 is upstream of

BRC activity that is required for glue synthesis, positioning DHR96 in the 20E mediated glue synthesis pathway (Table 3-3).

The screening strategy was comprehensive in that the VDRC has *RNAi* fly lines that target all putative *Drosophila* nuclear receptors (Table 3-1). Our approach can be a useful tool in other tissues that have a temporal 20E response, but a yet undetermined mechanism. For example, Bond found that the dissociation of fatbody tissue during metamorphosis is triggered by 20E, but it is USP independent (Bond dissertation 2009). Screening the fatbody using tissue specific drivers to drive the expression of the nuclear receptor *RNAi* lines could potentially reveal another novel 20E signaling mechanism.

Other nuclear receptors that may function as novel receptors for the 20E response in the third instar are DHR3, DHR38, DHR39 and DHR78. However, DHR78 may be the most interesting of these for a number of reasons. Much like DHR96, the temporal expression profile of DHR78 is closely related to that of the EcR [7, 17]. Both DHR78 and DHR96 are directly inducible by 20E in cultured late third-instar larval tissue [7, 17]. DHR78 is most similar to the TR2 orphan receptor and USP, with 74% amino acid identity to the TR2 receptor and 67% amino acid identity to USP.

Although only DHR96 is able to bind to the imperfect *hsp27EcRE* half-site AGtgCA and gGtTCA, the EcR/USP complex can bind DR-3, DR-4, DR-5 and TREpal DNA binding sequences all containing two AGGTCA half-sites [7]. Electromobility shift assays using purified DHR78 bound oligos representing these sites show three different size classes that may suggest a multimeric function of DHR78. As a result, like DHR96, DHR78 recognizes distinct binding sequences shared by the EcR/USP complex. These points support the possibility that DHR78 can be part of a novel ecdysone receptor to

temporally and spatially regulate the 20E response in tissues with 20E-regulated expression of DHR78, but no definable USP hormone response. Our screening strategy is perfectly suited to test this possibility in such tissues.

It was important to demonstrate the effectiveness of the VDRC *UAS-DHR96i* reagent. We have shown that the block in glue synthesis is indeed caused by the knockdown of *DHR96i* and not because of cross reactivity with EcR (Table 3-2). The knockdown was confirmed in both tissue stains and a western blot (Fig. 3-3). Yet there is a caveat, the Thummel lab has generated a mutant version of DHR96 that has been tested for glue synthesis. Our lab did not observe a block in glues synthesis, however, there are several possibilities why this is so. A limitation to consider in using the DHR96 mutant is the mutagenesis technique used in generating these fly lines; the “ends-in” site-directed mutagenesis technique [23].

“Ends-in” site-directed mutagenesis is a method used to target a gene of interest using homologous recombination using three components: A transgene expressing a FLP recombinase that recognizes an FRT site, a transgene expressing a site-specific endonuclease, and a transgenic donor sequence that has the FRT site and endonuclease site and a sequence from the gene to be targeted. In the case of the *DHR96* mutant, the donor DNA contained two deletions; a deletion in the translation start codon and a deletion in exon 4 that codes for the ligand binding domain. Southern blot analysis on the mutant revealed a deletion of the fourth exon. Whether this is enough to cause a genetic null is still debatable. We have analyzed the mutant in PCR fragment studies and can confirm that the fourth exon is absent, however, this does not enough evidence to confirm a null mutation. Western blots on *DHR96* mutant flies indicate multiple banding

in lower molecular weight migration patterns suggesting truncated forms of the protein (Supplementary material of [8]). A truncated form of DHR96 may harbor a function that could be enough to influence EcR conformational change resulting in transactivation of target genes.

Evidence for a functional heterodimeric nuclear hormone receptor without an RXR protein has been supported in vertebrate literature showing RAR/TR heterodimers can bind to relevant regulatory sites on DNA and activate target genes distinct from either RXR/RAR or RXR/TR receptors [6]. In *Drosophila*, using available molecular genetic tools we have shown that the vertebrate RAR homolog, EcR can function as a heterodimer with another receptor that is not an RXR protein, but is the vitamin D receptor homolog DHR96. The implication of the potential for nuclear receptors to form a diversity of heterodimers is profound in that it explains and profiles cell specific responses to systemic hormone exposure.

Finally, to demonstrate that DHR96 is acting as a heterodimer partner it will be necessary to perform a variety of biochemical assays. It would be important to show a protein-protein interaction between EcR and DHR96 that is biologically viable to transduce the 20E signal. Additionally, an electromobility shift assay performed with EcR and DHR96 proteins on EcRE sequences would prove valuable in placing the EcR/DHR96 heterodimer in a biological context.

3.5: References.

1. Warren JT, Yerushalmi Y, Shimell MJ, O'Connor MB, Restifo L, et al. (2006) Discrete pulses of molting hormone, 20-hydroxyecdysone, during late larval development of *Drosophila melanogaster*: correlations with changes in gene activity. *Developmental dynamics: an official publication of the American Association of Anatomists* 235: 315.
2. Ashburner M, Chihara C, Meltzer P, Richards G (1974) Temporal control of puffing activity in polytene chromosomes. In: *Cold Spring Harbor Symposia on Quantitative Biology*. . p. 655.
3. Costantino BFB, Bricker DK, Alexandre K, Shen K, Merriam JR, et al. (2008) A Novel Ecdysone Receptor Mediates Steroid-Regulated Developmental Events during the Mid-Third Instar of *Drosophila*. *PLoS Genet* 4.
4. Cao C, Liu Y, Lehmann M (2007) Fork head controls the timing and tissue selectivity of steroid-induced developmental cell death. *Journal of Cell Biology* 176: 843.
5. Koelle MR, Talbot WS, Segraves WA, Bender MT, Cherbas P, et al. (1991) The *Drosophila* EcR gene encodes an ecdysone receptor, a new member of the steroid receptor superfamily. *Cell* 67: 59–77.
6. Lee S, Privalsky ML (2005) Heterodimers of retinoic acid receptors and thyroid hormone receptors display unique combinatorial regulatory properties. *Molecular Endocrinology* 19: 863.
7. Fisk GJ, Thummel CS (1995) Isolation, regulation, and DNA-binding properties of three *Drosophila* nuclear hormone receptor superfamily members. *Proceedings of the National Academy of Sciences* 92: 10604.
8. King-Jones K, Horner MA, Lam G, Thummel CS (2006) The DHR96 nuclear receptor regulates xenobiotic responses in *Drosophila*. *Cell Metabolism* 4: 37–48.
9. Sieber MH, Thummel CS (2009) The DHR96 nuclear receptor controls triacylglycerol homeostasis in *Drosophila*. *Cell Metabolism* 10: 481–490.
10. Dietzl G, Chen D, Schnorrer F, Su KC, Barinova Y, et al. (2007) A genome-wide transgenic RNAi library for conditional gene inactivation in *Drosophila*. *Nature* 448: 151–156.
11. Zhou X, Zhou B, Truman JW, Riddiford LM (2004) Overexpression of broad: a new insight into its role in the *Drosophila* prothoracic gland cells. *Journal of Experimental Biology* 207: 1151.
12. Altschul SF, Madden TL, Schaffer AA, Zhang J, Zhang Z, et al. (1997) Gapped

- BLAST and PSI-BLAST: a new generation of protein database search programs. *Nucleic acids research* 25: 3389.
13. Vaskova M, Bentley AM, Marshall S, Reid P, Thummel CS, et al. (2000) Genetic Analysis of the *Drosophila* 63F Early Puff: Characterization of Mutations in E63-1 and maggie, a Putative Tom22. *Genetics* 156: 229-244.
 14. Yao TP, Forman BM, Jiang Z, Cherbas L, Chen JD, et al. (1993) Functional ecdysone receptor is the product of EcR and Ultraspiracle genes. .
 15. Yao TP, Segraves WA, Oro AE, McKeown M, Evans RM (1992) *Drosophila* ultraspiracle modulates ecdysone receptor function via heterodimer formation. *Cell* 71: 63–72.
 16. King-Jones K, Thummel CS (2005) Nuclear receptors—a perspective from *Drosophila*. *Nature Reviews Genetics* 6: 311–323.
 17. Horner MA, Chen T, Thummel CS (1995) Ecdysteroid Regulation and DNA Binding Properties of *Drosophila* Nuclear Hormone Receptor Superfamily Members. *Developmental Biology* 168: 490-502.
 18. Biyasheva A, Do TV, Lu Y, Vaskova M, Andres AJ (2001) Glue secretion in the *Drosophila* salivary gland: a model for steroid-regulated exocytosis. *Developmental Biology* 231: 234–251.
 19. Guay PS, Guild GM (1991) The ecdysone-induced puffing cascade in *Drosophila* salivary glands: a Broad-Complex early gene regulates intermolt and late gene transcription. *Genetics* 129: 169.
 20. Karim FD, Guild GM, Thummel CS (1993) The *Drosophila* Broad-Complex plays a key role in controlling ecdysone-regulated gene expression at the onset of metamorphosis. *Development* 118: 977.
 21. Chao AT, Guild GM (1986) Molecular analysis of the ecdysterone-inducible 2B5" early'puff in *Drosophila melanogaster*. *The EMBO Journal* 5: 143.
 22. Von Kalm L, Crossgrove K, Von Seggern D, Guild GM, Beckendorf SK (1994) The Broad-Complex directly controls a tissue-specific response to the steroid hormone ecdysone at the onset of *Drosophila* metamorphosis. *The EMBO Journal* 13: 3505.
 23. Rong YS, Golic KG (2000) Gene Targeting by Homologous Recombination in *Drosophila*. *Science* 288: 2013-2018.

CHAPTER 4

THE REQUIREMENT FOR BOTH THE CALCIUM BINDING PROTEIN E63-1 AND CALMODULIN IN GLUE SECRETION

4.1: Introduction.

Steroids belong to a class of lipophilic hormones synthesized from cholesterol precursors. The known steroid hormones include the sex hormones (estrogen, androgen), progestins, glucocorticoids, mineralocorticoids, vitamin D and the insect molting hormone 20-hydroxyecdysone (hereafter referred to as 20E) (reviewed in [1]). In *Drosophila melanogaster*, 20E mediates important developmental transitions such as molting at the end of each larval instar and metamorphosis (reviewed in [2]). The initial stages of these events involve receptor activation and the direct modulation of gene expression in target tissues ([3-5]). What is poorly understood is the molecular mechanisms underlying these changes in gene expression leading to tissue-specific physiological responses. Using the larval salivary gland as a model tissue we examine one such tissue-specific steroid response, glue secretion, triggered by the major pulse of 20E that occurs at the end of the last larval instar (the premetamorphic pulse).

In the salivary gland, the premetamorphic pulse of 20E initiates a complex hierarchy of gene activity involving the activation of the early and late genes, which were originally named because they form temporally specific puffs on the giant polytene chromosomes (reviewed in [6, 7]). Coincident with this period of gene activity is a robust exocytosis of glue glycoproteins that are secreted into the lumen of the gland. Previous studies have demonstrated glue secretion is induced in salivary glands *ex vivo* only if exogenous ecdysone is provided. Furthermore, exposure to 20E for at least two hours is required for

secretion to occur, and when cycloheximide (an inhibitor of protein translation) is added, secretion is completely blocked [8-10]. These observations suggest that glue secretion is a secondary response to the hormone, presumably because one or more early-gene proteins is required for the process.

Most of the early and early-late (primary-response) puff genes that have been identified encode DNA-binding proteins [11-16], and their link to the secretion processes, if it exists, has not been established [17]. In contrast, E63-1 (the product of the 63F early puff), is an EF-hand containing Ca^{2+} -binding protein [18], which can mediate salivary gland glue secretion in the presence of elevated Ca^{2+} levels [17]. E63-1 displays the highest degree of overall similarity to calmodulin (Cam) from many different species [18] and has a 58% positive amino acid identity to the *Drosophila melanogaster* Cam. However, in addition to its ability to activate target enzymes, Cam can also function as a regulatory light chain (RLC) for many unconventional myosin proteins [19-21].

Because E63-1 has the highest protein sequence similarity to Cam, we hypothesized that E63-1 may also have a similar functional role as a myosin RLC and act as the RLC component of an unconventional myosin complex required for 20E induced glue secretion in the salivary gland. Although ectopic expression of E63-1 can drive secretion in the presence of elevated Ca^{2+} levels, null mutations do not have drastic effects on the process. This may not be surprising due to the abundance of other EF hand proteins like Cam that are present in the salivary gland at the time of secretion. Thus E63-1 may function as a myosin light chain to secrete glue granules, but its function is probably redundant with other EF-hand proteins present in the tissue at the time of cargo delivery.

Here we present evidence that salivary glands compromised for E63–1 and Cam are secretion defective, suggesting that both proteins are involved in the process. Furthermore, because co-immunoprecipitation experiments demonstrated that E63–1 and Cam could associate in a complex with Myosin VI [22] we assayed glue secretion in glands compromised for Myosin VI. Our results are consistent with a model in which 20E stimulates secretion through a mechanism that involves at least two Calcium-binding proteins and at least two myosin motors.

4.2: Materials and Methods.

4.2.a: *Drosophila* Culture

The following fly stocks were obtained from the Bloomington Stock Center: *UAS-GFPi* (FBst0009331), *glueGal4* (FBst0006870), and *UAS-n-Syb.GFP* (FBst0006922).

Strains containing inverted repeats for RNAi against E63-1 (*UAS-E63i* = #102809), Cam (*UAS-Cami* = #102004), and individual myosin motor proteins (Table 4-1) were obtained from the Vienna *Drosophila* RNAi Center (VDRC). Stocks containing *Calmodulin* alleles trapped with *GFP* coding information (*Cam*^{GFP-ZCL2488} and *Cam*^{GFP-G00389}) were located in FlyTrap (<http://flytrap.med.yale.edu/>) and obtained from Lynn Cooley. Myosin VI-compromised lines (AM8-2 [containing an antisense orientation of Myosin VI heavy chain (*Mhc95F*) under *UAS* control]; a null allele of *Mhc95F* (*jag*³²²), and a chromosomal deletion uncovering *Mhc95F* [*Df(3R)S87-5*]) were obtained from Kathryn Miller. *E63-1* null mutants [*e63-1*^{dc449} = *e63-1*] are as described [23]. *GFP*- and *dsRed*-tagged versions of *Sgs3* are as described in [17, 24]. Animals were raised on standard cornmeal-molasses medium as previously described ([25, 26])

Table 4-1: RNAi lines directed against *Drosophila myosin* genes collected and tested in this work.

Myosin Gene Targeted	VDRC Stock Number	Location of Insert (Chromosome)	Stock Condition
Myosin II	7164	III	Homozygous
Myosin II	7819	II	Homozygous
Myosin VII	9265	III	Homozygous
Myosin 29D	12555	III	Homozygous
Myosin 29D	12556	III	Tm3
Myosin IA	12558	III	Homozygous
Myosin III	27359	X	Homozygous
Myosin III	27360	III	Homozygous
Myosin XV	33486	III	Homozygous
Myosin 95E	33775	III	Homozygous
Myosin 95E	33776	III	Tm3
Myosin XV	37530	III	Homozygous
Myosin VIIB	37531	II	Homozygous
Myosin VIIB	37532	III	Homozygous
Myosin IB	49345	III	Homozygous
Myosin 95E	51207	III	Tm3
Myosin VIIA	100010	II	Homozygous
Myosin VIIB	101016	II	Homozygous
Myosin I0A	101729	II	Homozygous
Myosin 29D	102550	II	Homozygous
Myosin 31DF	104089	II	Homozygous
Myosin II	105355	II	Homozygous

4.2.b: Protein Detection

For Western blots, salivary glands were dissected and processed from larvae before and after the *in vivo* ecdysone pulse, or were dissected from naïve animals and treated *in vitro* with ecdysone as described above. Blots were prepared as described previously ([23]). Antibodies were used at the following dilutions: 1:50,000 for R4694 (anti-E63–1 rabbit polyclonal); 1:100 for 3C7 [anti-Myosin VI mouse monoclonal (gift from K. Miller)]; 1:5000 for anti- α -tubulin (Sigma), 1:7500 for horseradish-peroxidase conjugated antibodies (Jackson ImmunoResearch Laboratories), 1:5000 for anti-GFP (Sigma).

For microscopic analyses, unfixed tissues were mounted in Schneider's medium (Sigma) and epifluorescent and confocal images were captured as described previously ([17]).

4.2.c: Secretion Assay

Larvae for secretion analyses were produced by crossing stocks containing multiple mutant alleles, deficiencies, and transgenes. Table 4-2 lists the genotypes analyzed in the secretion assays.

4.2.d: Microscopy

High-resolution images of dissected salivary glands were imaged on a LSM 510 Axioplan confocal microscope (Carl Zeiss SMT, Peabody, MA) equipped with LSM 510 image-analysis software.

Table 4-2: Genotypes of flies compromised for Cam and E63-1 proteins.

Shorthand Name	Endo <i>Cam</i> Alleles	Endo <i>E63-1</i> Alleles	Driver Trans-gene	Responder Trans-genes	Assay Trans-gene
Late Driver Experiment					
<i>Cam</i> ^{GFP+} ; <i>E63-1</i> ⁺	<u><i>Cam</i>⁺</u> <i>Cam</i> ^{GFP-ZCL2488}	<u><i>E63-1</i>⁺</u> <i>e63-1</i> ^{dc449}	<i>glueGal4</i>		<i>glueRED</i>
<i>Cam</i> ^{GFPi} ; <i>E63-1</i> ⁺	<u><i>Cam</i>^{GFP-ZCL2488}</u> <i>Cam</i> ^{GFP-G00398}	<u><i>E63-1</i>⁺</u> <i>e63-1</i> ^{dc449}	<i>glueGal4</i>	<i>UAS-GFPi</i>	<i>glueRED</i>
<i>Cam</i> ^{GFP+} ; <i>e63-1</i>	<u><i>Cam</i>⁺</u> CamGFP-ZCL2488	<u><i>e63-1</i>^{dc449}</u> <i>e63-1</i> ^{dc449}	<i>glueGal4</i>		<i>glueRED</i>
<i>Cam</i> ^{GFPi} ; <i>e63-1</i>	<u><i>Cam</i>^{GFP-ZCL2488}</u> <i>Cam</i> ^{GFP-G00398}	<u><i>e63-1</i>^{dc449}</u> <i>e63-1</i> ^{dc449}	<i>glueGal4</i>	<i>UAS-GFPi</i>	<i>glueRED</i>

Early Driver Experiment					
<i>Cam</i> ⁺ ; <i>E63</i> ⁺	<u><i>Cam</i>⁺</u> <i>Cam</i> ⁺	<u><i>E63</i>⁺</u> <i>E63</i> ⁺	<i>sgGal4</i>		<i>glueRED</i>
<i>Cami</i> ; <i>E63</i> ⁺	<u><i>Cam</i>⁺</u> <i>Cam</i> ⁺	<u><i>E63</i>⁺</u> <i>E63</i> ⁺	<i>sgGal4</i>	<i>UAS-Cami</i>	<i>glueRED</i>
<i>GCami</i> ; <i>E63</i> ⁺	<u><i>Cam</i>⁺</u> <i>Cam</i> ^{GFP-G00398}	<u><i>E63</i>⁺</u> <i>E63</i> ⁺	<i>sgGal4</i>	<i>UAS-Cami</i>	<i>glueRED</i>
<i>Cam</i> ⁺ ; <i>E63i</i>	<u><i>Cam</i>⁺</u> <i>Cam</i> ⁺	<u><i>E63</i>⁺</u> <i>E63</i> ⁺	<i>sgGal4</i>	<i>UAS-E63i</i>	<i>glueRED</i>
<i>GCami</i> ; <i>E63i</i>	<u><i>Cam</i>⁺</u> <i>Cam</i> ^{GFP-G00398}	<u><i>E63</i>⁺</u> <i>E63</i> ⁺	<i>sgGal4</i>	<i>UAS-Cami</i> ; <i>UAS-E63i</i>	<i>glueRED</i>

4.3: Results.

4.3.a: Compromising both Cam and E63-1 Perturbs 20E-Regulated Secretion

We have developed a convenient bioassay for monitoring salivary gland glue secretion *in vivo* and *in vitro* using a reagent in which the open reading frame of a glue gene (*Sgs3*), under the control of its own regulatory sequences, is fused in frame with either GFP (to produce a *glueGRN* stock) or DsRed (to produce a *glueRED* stock). Using these assays we have shown that *E63-1* null mutants (*e63-1*) look wildtype relative to glue secretion. However, *e63-1* mutants that are also compromised for Cam functions (using pharmacological inhibitors or *Cam* hypomorphic alleles) display partial secretion defects that are not observed when Cam functions alone are compromised. Presumably this occurs because E63-1 shares a functionally redundant role with Cam during glue secretion. However, neither of these experiments allowed us to monitor secretion functions under conditions in which Cam is completely compromised. *Drosophila* contains only one gene for CaM [27, 28], and *Cam* null mutants have been generated that die early in development as first-instar larvae [29, 30]. However, several hypomorphic alleles have been generated [30, 31] that survive to later stages. Thus, we employed a transgenic approach in which RNAi reagents specific to Cam were expressed only in larval salivary glands. These experiments were performed in backgrounds heterozygous or homozygous for *e63-1* null mutations.

We began this RNAi approach using *Cam* alleles containing an open-reading frame fused to GFP. These “trapped” Cam alleles (*Cam*^{GFP-ZCL2488} and *Cam*^{GFP-G00389}) are controlled by their own regulatory sequences, but they behave as hypomorphs because homozygotes or a hetero-allelic combination die during the pupal period of development.

However because they contain GFP sequences, they should be targets for RNA interference in the salivary gland when a transgene containing an inverted repeat of GFP (*UAS-GFPi*) is expressed in that tissue. As a proof of principal, we expressed two separate GFP-tagged genes (*glueGRN*, and *UAS-n-Syb.GFP*) with and without *GFPi* using the salivary gland specific drivers, sgGal4 and glueGal4. As shown in Figures 4-1C-D, *glueGRN* is silenced when the late salivary gland driver is present. A Western blot of n-SyB-GFP and Sgs3-GFP was performed on protein samples from salivary glands with an early or late driver. There is a greater than >90% reduction in the amount of both proteins when *GFPi* is driven by either driver (Fig. 4-1E).

Figure 4-1: Genes tagged with GFP can be silenced with an RNAi construct against GFP.

(A) An illustration of the transgenic tool used to assay GFP-tagged genes in the larval salivary gland. Regulatory and coding information necessary for tissue and stage specificity were fused to the coding information of Gal4 and dsRED. These transgenes were recombined on the second chromosome with an inverted repeat of GFP that would make a hairpin molecule for RNAi. A line was created that carried all three transgenes on the second chromosome (3T-2).

(B) Our approach was to silence GFP-tagged molecules in the salivary gland an assay secretion of the glueRED marker. Glands with normal secretion appear bloated and expanded. Conversely, glands with secretion blocked remain unchanged.

(C) Low resolution images of third instar larvae expressing glueGRN or (D) glueGRN and *GFPi* were taken to as proof of principle that *GFPi* can silence GFP activity. There is no detectable glueGRN in larvae that are driving *GFPi* (D).

(E) The degree of GFP silencing of two different GFP-tagged genes was documented in a Western blot. Protein samples were prepared from larvae that expressed *GFPi* or the driver alone and run on a 12% SDS gel. A blot was made and incubated with antibodies against GFP. GFP-tagged protein levels are dramatically reduced in lanes with the driver and *GFPi*.

A. Cross stocks to produce animal with appropriate genotype:

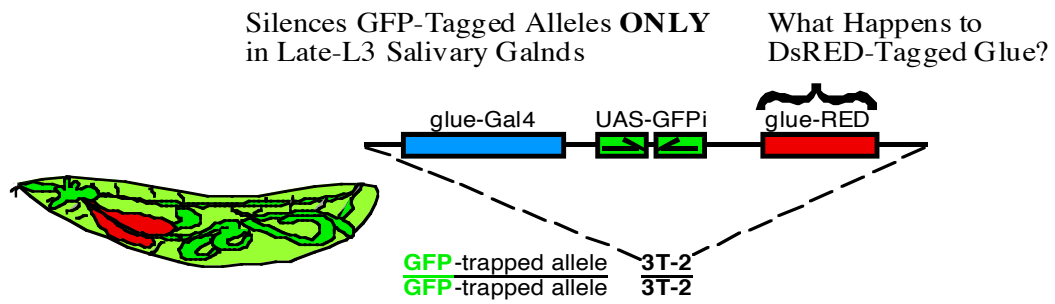

B. Assay fate of RED glue granules when tagged gene is silenced:

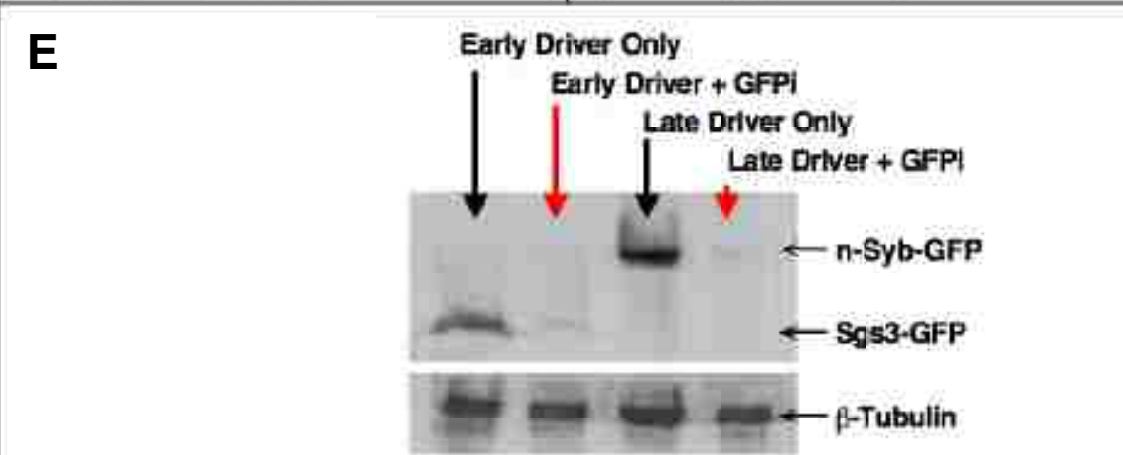

For the secretion analysis of the *Cam*^{GFP} alleles silenced with RNAi, we assayed four genotypes in which *Cam*, *E63-1* or both were compromised in the late larval salivary gland. The first group (*Cam*^{GFP+}; *E63-1*+) contained at least one wildtype allele for both *Cam* and *E63-1*. The second group (*Cam*^{GFPi}; *E63-1*+) was compromised for *Cam* using RNAi against the GFP tags, but it still contained a wildtype allele for *E63-1*. The third group (*Cam*^{GFP+}; *e63-1*) contained null mutations for *E63-1*, but had at least one wildtype allele for *Cam*. Finally the last group (*Cam*^{GFPi}; *e63-1*) was compromised for both *Cam* (using RNAi) and *E63-1* (using null mutations) [See Table 4-2 (late driver) for a complete description of the genotypes].

In each group, animals were scored at the white prepupal (WPP) stage using a simple assay that reported the location of the tagged *glueRED*. If all the glue was located outside the animal on the surface of the prepupa it was scored as completely secreted. If the glue was still entirely retained within the salivary glands, the WPP was scored as completely blocked. Animals with some glue outside and some retained were scored as partials. Figure 4-2 shows representative examples of the assay and the results of an analysis of each genotype that was scored.

Figure 4-2: Glue secretion is partially blocked when Cam and E63-1 are compromised in late-larval salivary glands.

The larvae assayed for secretion were the F1 offspring of the same parental lines: CamGFP/ CyO; e63-1 and CamGFP, GFPi/ CyO; e63-1. Each group was selected at an early third instar stage and counted at the white prepupal stage. Low-resolution images representing the secretion criteria are above each result. Note that animals also fluoresce green because of the presence of at least one GFP-tagged *Cam* allele in each group (see Table 4-2 for details of genotype).

Secretion Assay

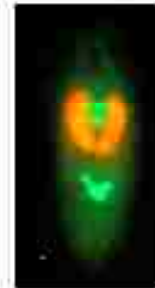
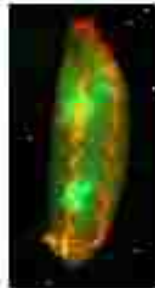

Assay Group	Complete	Partial	Blocked	N
<i>Cam^{GFP+}; E63-1+</i>	94%	0%	6%	47
<i>Cam^{GFPi}; E63-1+</i>	90%	7%	3%	78
<i>Cam^{GFP+}; e63-1</i>	87%	0%	13%	81
<i>Cam^{GFPi}; e63-1</i>	13%	3%	84%	62

From the results presented in Figure 4-2, it is apparent that compromising both *Cam* and *E63-1* affect the ability of the larvae to secrete glue. However, it is interesting to note that animals mutant for *E63-1* seem to be affected more severely than those in which only *Cam* is silenced with RNAi. One potential caveat of this experiment is the possibility that the late driver, *glueGal4*, is not able to completely knock down wildtype levels of *Cam*. Thus, in order to test the possibility that glands completely deficient in *Cam* can still secrete, we obtained *UAS-E63i* and *UAS-Cami* stocks from the VDRC and expressed them throughout larval development in the salivary gland with the *sgGal4* driver previously described [24].

To test the silencing ability of the *sgGal4* driver and the *UAS-E63i* responder, we performed a Western blot on the dissected salivary glands of animals at the WPP stage. As shown in Figure 4-3, no *E63-1* protein can be detected in the glands of *e63-1* null animals. Furthermore, the levels of *E63-1* are reduced to less than 7% of wildtype when the *UAS-E63i* transgene is driven with *sgGal4*.

Figure 4-3: *E63i* efficiently silences the endogenous *E63-1* gene.

(A) Protein extracts were prepared from salivary glands of four different groups of larvae at the white prepupal stage. *Cami* and *E63i* were expressed using the *sgGal4* driver. The parental line (*sgGal4*) and *Cami* larvae were used as positive controls and *e63-1* as a negative control. The samples were run on an SDS gel and blotted with antibodies against E63-1 or α -tubulin (loading/blotting control). The *E63i* lane shows a reduction in E63-1 protein compared to the parental amount.

(B) The quantification of a Western blot done on E63-1 shows that E63-1 is reduced in lanes expressing the *E63-Ii* transgene. There is a reduction of ~93% of E63-1 in *E63i* compared to the control lanes.

A

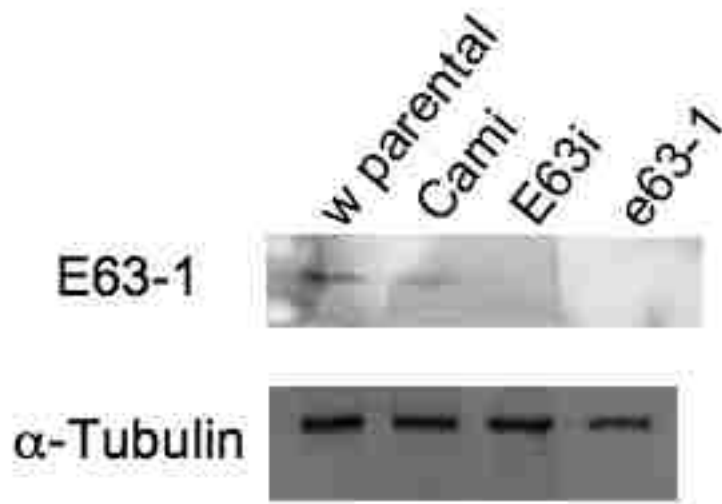

B

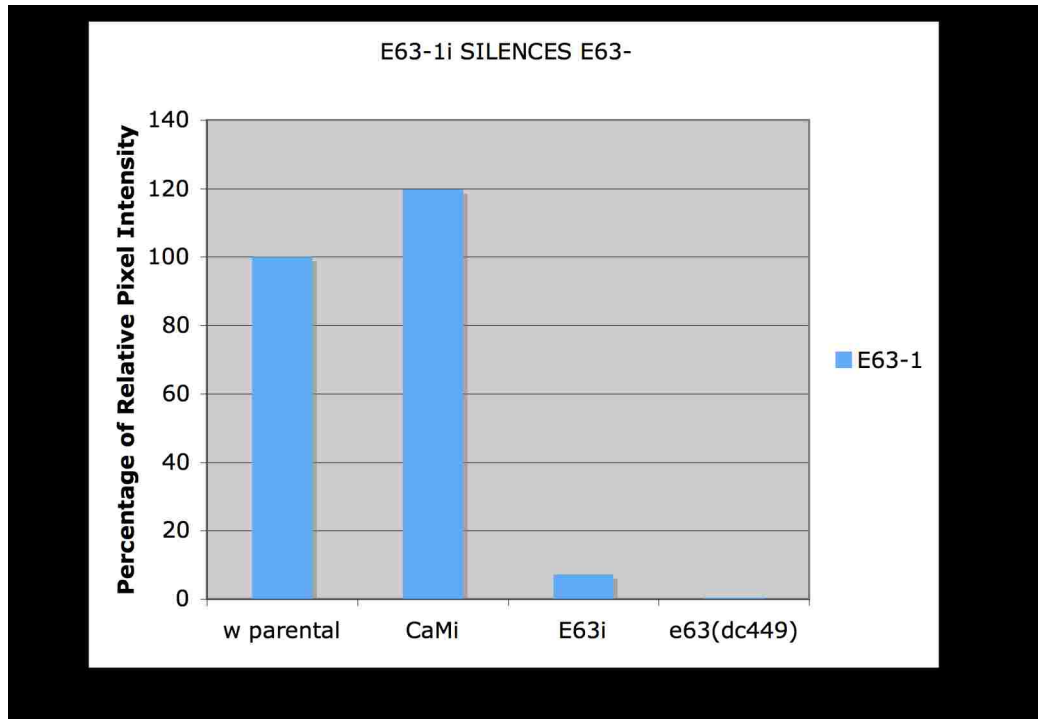

Although we had no antibody to test the levels of Cam in the salivary gland when *UAS-Cami* is driven with *sgGal4*, we assume a similar level of gene silencing for Cam as for *E63-1* for three reasons. First, both *E63i* and *Cami* were targeted to the same region of the genome using phiC31 integrase system [32], and both are reported to reside at the same location on chromosome 2. Second, when we crossed *UAS-Cami* to the ubiquitous *Actin5C-Gal4* driver, no progeny were recovered. This result is consistent with the observation that *Cami* is silencing the endogenous *Cam* gene needed for viability. Third, when *UAS-Cami* is driven in the salivary glands with *glueGal4*, very little fluorescence is detected in that tissue in animals also containing a *Cam*^{GFP-G00398} allele.

With the RNAi reagents in hand, the genotypes used for this analysis are as described in Table 4-2 (early drivers). This time five groups were assayed. The first group (*Cam*+, *E63*+) contains neither RNAi construct. The second group (*Cami*; *E63*+) contain the RNAi construct against *Cam*, but not *E63-1*. The third group (*GCami*; *E63*+) is similar to the second group except that *Cam* is heterozygous for the *Cam*^{GFP-G00398} allele. The fourth group (*Cam*+, *E63i*) contains the RNAi construct against *E63-1*, but not *Cam*. The final group (*GCami*; *E63i*) is heterozygous for *Cam* and contains RNAi constructs against both *Cam* and *E63-1*. In addition, four secretion phenotypes were described: no secretion (0), a small amount of secretion (+), a large but not fully complete amount of secretion (++) and complete secretion (+++). These categories allowed us to more accurately evaluate the assay.

The raw data are presented in Figure 4-4A. To graph these data, we combined the (0) and (+) groups as “secretion blocked,” and we combined the (++) and (+++) groups as

“secretion normal.” The percent of secretion normal for each group was then plotted (Fig. 4-4B) and statistically analyzed using a generalized linear model.

As shown in Figure 4-4B, there is a highly significant difference ($p < 0.001$) between the *Cam1; E63i* double knockdown and the parental controls. This result is consistent to those reported when *Cam* is compromised with pharmacological inhibitors, reduced in hypomorphic mutant backgrounds, and silenced with RNAi driven in late-larval salivary glands. In all cases, the impact on secretion is enhanced when *Cam* treatments/reagents are placed in an *E63-1* mutant background. However, in no case is secretion completely blocked, which suggests that perhaps yet a third Ca^{2+} -binding protein is needed for the full response (see Section 4.4).

Figure 4-4: Secretion is inhibited when both Cam and E63-1 are silenced in the salivary gland during the entire larval period.

(A) The percentage of WPP displaying each secretion phenotype is listed below a low-resolution representative. Categories included WPP that did not secrete glue (0), secreted < 50% of glue (+), secreted >50% of glue (++), and completely secreted glue (+++). Each group carried a glueRED marker and the salivary gland early driver *sgGal4* to drive the expression of *Cami*, *E63i* or both.

(B) The percent of animals that expel glue (++ and +++) were statistically analyzed using a binomial test for proportions and compared to wildtype (WT). All groups differ significantly in the percent of animals that expel glue in comparison to WT. Significance levels are *** $p < 0.001$ and ** $p < 0.01$. Note that the proportion of secreting *E63i* and *Cami* were also compared, and were not significantly different.

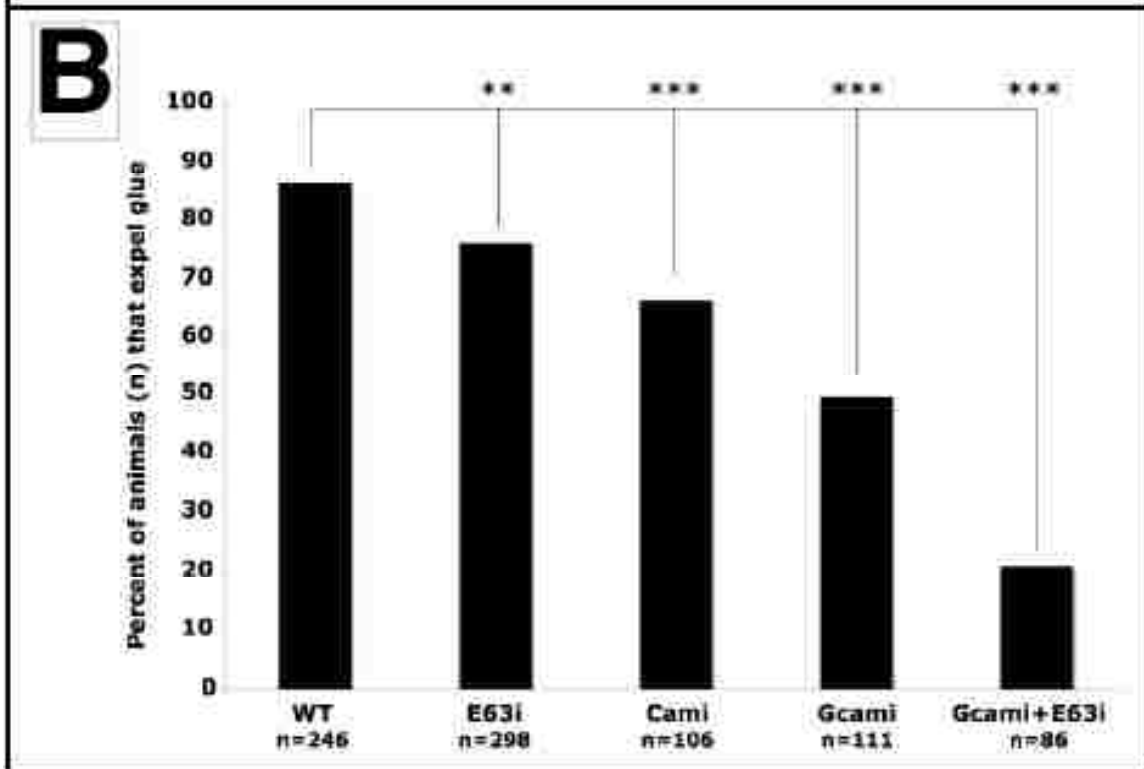
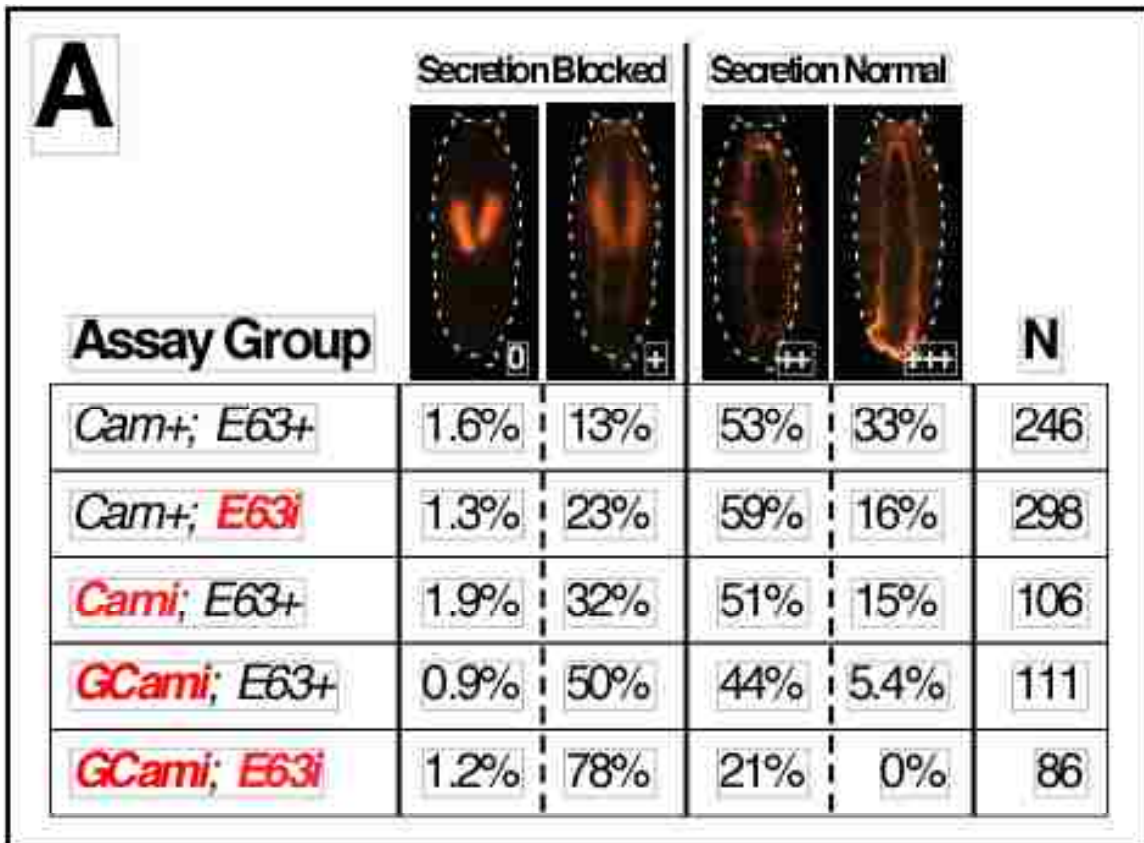

4.3.b: Driving Antisense Myosin VI Blocks Secretion, but Myosin VI Mutants have Little or No Effect

Because it was previously demonstrated that E63-1 and Cam can co-immunoprecipitate with Myosin VI [22], I was interested in testing whether Myosin VI is required for ecdysone-stimulated glue secretion in the salivary gland.

To test the requirement for Myosin VI, we used a method to compromise expression of the endogenous *Mhc95F* gene in late-larval salivary glands. Our strategy was to drive a *UAS-antisense-Mhc95F* construct (*AM8-2*) only in salivary glands using tissue- and temporal-specific drivers [33]. *AM8-2* has been shown to be very efficient at reducing myosin VI protein levels (perhaps as much as 90%) when it is expressed in whole animals or in specific tissues [34, 35]. Thus, we expressed large amounts of *AM8-2* only in third-instar salivary glands using the *glueGal4* driver.

All of the larvae expressing *AM8-2* showed a block in glue secretion (Fig. 4-5A). However, when we prepared a Western blot of salivary gland extracts using the Myosin VI specific antibody, 3C7, protein levels in parental and *AM8-2* knockdowns were similar (Fig. 4-5B,C). Thus, we performed an additional analysis using the *Mhc95F* null mutant (*jar*³²²).

Figure 4-5: Driving *AM8-2* in larval salivary glands blocks glue secretion.

(A) Glue secretion was assayed from two groups of white prepupae: a parental line carrying glueGRN and the late salivary gland driver (*glueGal4*), and *AM8-2* (UAS-Mhc95Fas). The percentage of WPP displaying each secretion phenotype is listed below a low-resolution representative.

(B) The level of myosin VI silencing was assessed in a Western blot performed on protein extracts from five groups of WPP. The samples were run on a 7.5% SDS gel and blotted on PVDF membrane. The blot was probed with myosin VI antibody and α -tubulin antibody (loading/blotting control).

(C) The Western blot was quantified using ImageQuant software (GE healthcare). The α -tubulin control was used to normalize the myosin VI bands and the relative pixel intensity was graphed.

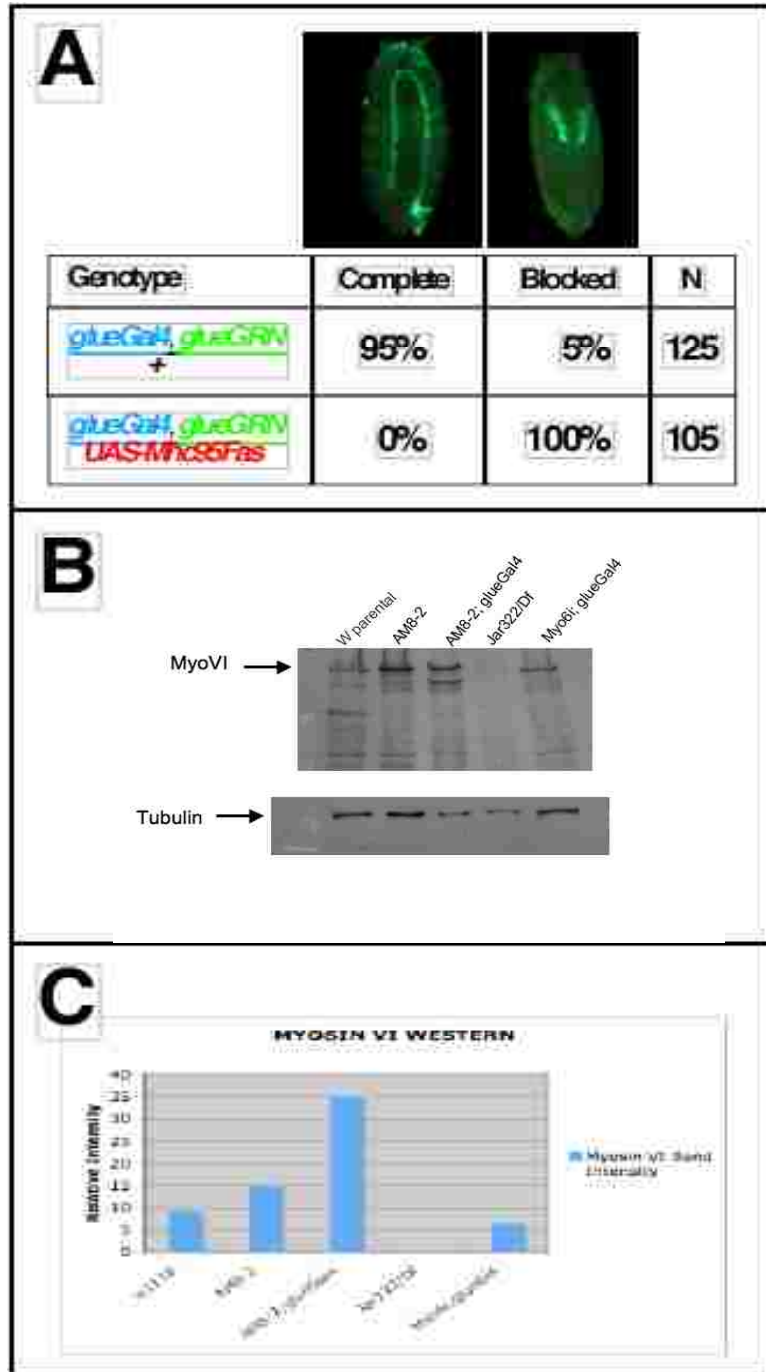

*jar*³²²-homozygous animals die during the second-instar larval stage due to a partial deletion in a the neighboring gene, *CG5706*. To overcome this lethal phenotype, we used a deficiency [*Df(3R)S87-5*] that spans only the *Mhc95F* gene region. Thus, animals of the genotype *jar*³²²/*Df(3R)S87-5* are male sterile, but viable for third-instar secretion assays. To facilitate the secretion assay, we crossed the *glueRED* transgene onto the deficiency chromosome. When animals of this genotype [*jar*³²²/*Df(3R)*, *glueRED*] were assayed for secretion, no impairments were observed, even though a Western analysis confirmed that Myosin VI protein was absent from these glands (Fig. 4-5B,C)

One explanation for the block in secretion when *AM8-2* is expressed in the salivary gland, is that this antisense reagent is non-specific or it cross reacts with other *myosin* genes. To test this hypothesis, we screened 13 *Drosophila* myosins using the *UAS* driven *RNAi* lines available from the VDRC (Table 4-1). The analysis involved crossing each *UAS-RNAi* line to an assay stock containing *sgGal4*, *glueRED*. Secretion was then monitored using the criteria described in Figure 4-4. However, the results of this analysis were disappointing, because we failed to identify a *myosin* line that by itself blocked secretion when it was silenced in the salivary gland during the larval period.

4.4: Discussion.

4.4a: E63-1 and CaM are Needed for Glue Secretion in the Salivary Gland

In both experiments that tested a loss of function in both *E63-1* and *Cam*, glue secretion was not inhibited completely. Another possibility is that a third myosin regulatory light chain is needed to completely secrete glue. To address this possibility we would ideally like to perform a screen of other possible regulatory light chains in *Drosophila*. As a starting point, we completed a pBLAST search of the *Drosophila* genome looking for sequence identities to E63-1.

The two protein sequences that displayed the highest overall sequence similarity in a pBLAST of E63-1 are calmodulin (CaM) and Androcam (Acam). An alignment of the three sequences was performed in clustalW and pairwise alignments were calculated (Fig. 4-6). CaM and Acam share a 67% overall sequence similarity, CaM and E63-1 34% similarity, and Acam and E63-1 32% similarity. From amino acids D127- L193 in the E63-1 C-terminus, there is a sequence identity of 45% between CaM and E63-1 and 42% between Acam and E63-1. To complete this analysis we would like to compromise all three proteins in a single fly. Currently the VDRC carries two line of *UAS-Acami* that will be used in future experiments.

Figure 4-6: Sequence comparison of E63-1, calmodulin and Androcam.

The complete amino acid sequences of E63-1, calmodulin and Androcam were analyzed using clustalW. Amino acid residues are colored accordingly: yellow represents proline, orange represents glycine, red represent basic residues, purple represent acidic residues, blue represent small hydrophobic residues, green represent basic residues with hydroxyl and amine groups. The quality of the sequence identity is shown. Highly conserved sequences are ranked higher and less conserved sequences are ranked lower. Below in black is the consensus match.

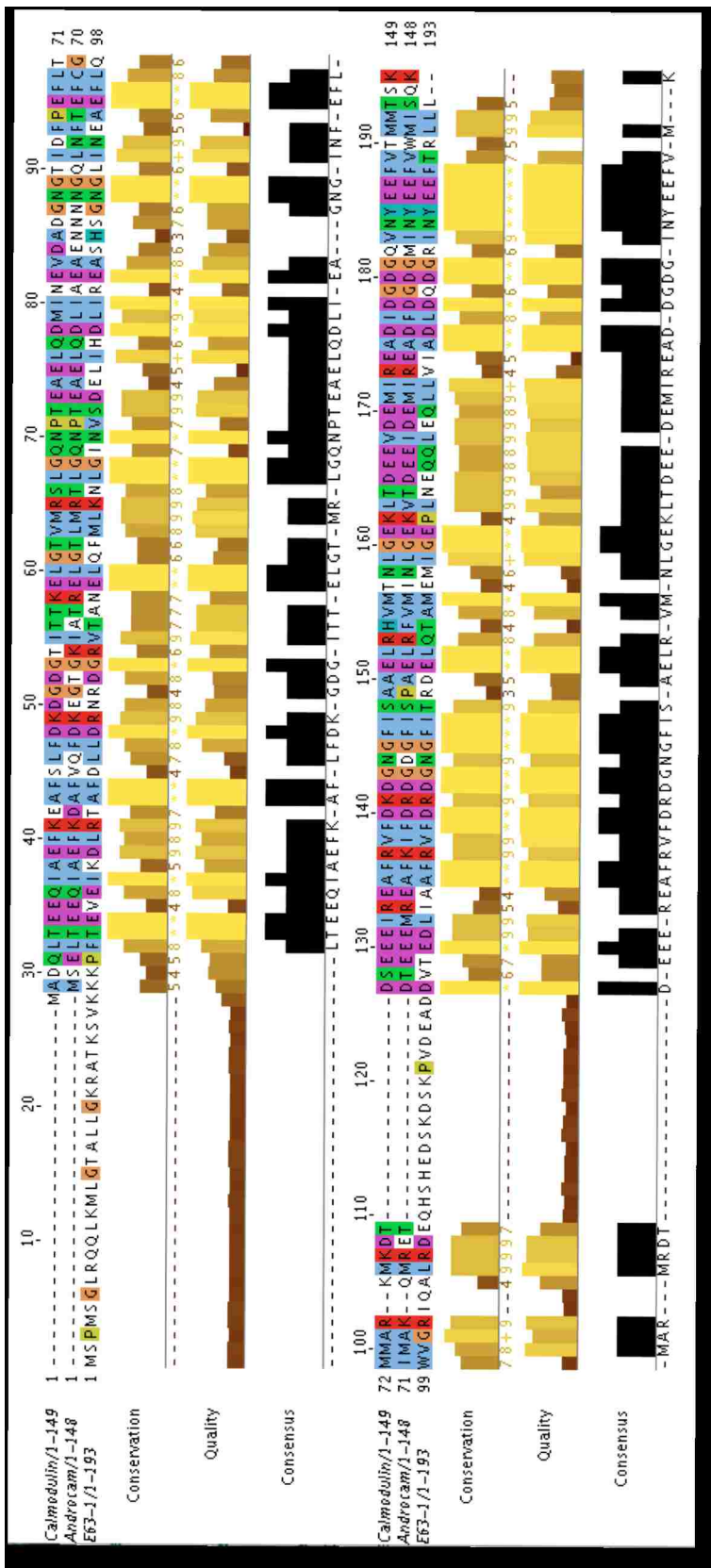

I have shown using different methods that salivary glands compromised for CaM and E63-1 are secretion defective. To support the *in vitro* tissue culture data published in [22], I employed an *in vivo* method of silencing the function of both E63-1 and CaM. By expressing *CaMi* and *E63-Ii* together, secretion was significantly inhibited (Fig. 4-4). Furthermore, the knockdown of *Cam.GFP* using *GFPi* in an e63-1 null background showed a similar block in secretion (Fig. 4-2). The severity of secretion inhibition when both proteins are removed or reduced was statistically significant compared to just one of the proteins compromised.

The inhibitory effect that *E63-Ii* and *CaMi* had on glue secretion was notable, however, it was not complete. Similar calcium sensing proteins or myosin light chains may be involved in the complete glue secretion pathway. In a pBLAST, *Acam* was identified as a close match with E63-2 and CaM. Future studies will be performed to assess the potential role *Acam* may have on secretion.

Myosin VI was an interesting target for CaM and E63-1 because it co-immunoprecipitated with the two proteins [22], and larvae expressing *AM8-2* in the salivary gland failed to secrete glue (Fig. 4-5). However, as we have shown, myosin VI null mutants secreted glue normally. We offer an explanation for these findings. First, that the *AM8-2* reagent is not behaving as expected in the salivary glands and is cross-reacting with another myosin that is required for glue secretion. However, we performed a simple screening experiment in which each known *Drosophila* myosin heavy chain gene was silenced to investigate the possibility of another myosin heavy chain as the regulator of glue secretion, but our results did not validate our hypothesis.

4.4.b: Other Putative Models for Secretion in Larval Salivary Glands

We know from Northern- [18] and Western-blot analyses [22] that E63-1 is ecdysone-inducible in larval salivary glands. However, CaM is expressed before and after the premetamorphic ecdysone pulse, and protein levels do not seem to be dramatically affected by the hormone titer [22]. Thus, one possibility is that a myosin heavy chain is regulated by distinct light chains at different times during development and CaM may act as the sole light chain prior to the premetamorphic pulse of ecdysone, perhaps to aid in the budding of glue granules from the *trans* golgi network. However, immediately prior to the premetamorphic pulse of ecdysone, most glue granules have been synthesized and matured [9, 36, 37]. Thus, when E63-1 and perhaps another Ca²⁺-binding protein are induced in response to 20E, they may compete with CaM for binding to the myosin heavy chain at a light chain binding domain, the conserved IQ motif. In this scenario, both E63-1 and CaM would act to regulate myosin function through the same IQ motif, but each protein would play a distinct regulatory role. This model, however, does not fit with our observed data and instead prompts a more cooperative model of secretion potentially involving multiple binding sites on a myosin heavy chain.

A cooperative model of binding can be imagined in which CaM may bind to the conserved IQ motif while E63-1 binds to another region of a myosin protein. In this case, both CaM and E63-1 would cooperatively bind to myosin only when ecdysone signaling initiates the expression of E63-1 as needed for secretion. The fact that E63-1 has a 27 amino acid long N-terminal extension prior to the first EF hand (Fig. 4-6) and a longer linker region than CaM may contribute to regulatory function or binding dynamic unique to E63-1.

However, we cannot rule out two other possible explanations for the observed genetic interaction between E63-1 and CaM. First, the interaction may be due to the disruption of CaM function in mediating the activity of multiple myosin motors. This would include the role CaM plays as a light chain for unconventional myosins as well as its role in regulating conventional myosins via the activation of the regulatory light chains [38]. Alternatively, E63-1 and CaM may have overlapping functions that are not associated with myosin regulation. To address the mechanism further, experiments would need to be done to determine whether myosin heavy chains are involved in the secretion process and if and where E63-1 and CaM bind to candidate myosin molecules. Fully understanding the process of secretion will guide other research into disease pathways associated with secretion defects.

4.5: References.

1. Whitfield GK, Jurutka PW, Haussler CA, Haussler MR (2000) Steroid hormone receptors: evolution, ligands, and molecular basis of biologic function. *Journal of Cellular Biochemistry* 75: 110–122.
2. Riddiford LM (1993) Hormones and *Drosophila* development. The development of *Drosophila melanogaster* 2: 899–939.
3. Aranda A, Pascual A (2001) Nuclear hormone receptors and gene expression. *Physiological Reviews* 81: 1269.
4. Cherbas P, Cherbas L (1996) Molecular aspects of ecdysteroid hormone action. *Metamorphosis: Postembryonic reprogramming of gene expression in amphibian and insect cells* : 175–221.
5. Freedman LP (2000) Strategies for transcriptional activation by steroid/nuclear receptors. *Journal of Cellular Biochemistry* 75: 103–109.
6. Russell S, Ashburner M (1996) Ecdysone-regulated chromosome puffing in *Drosophila melanogaster*. *Metamorphosis: Postembryonic Reprogramming of Gene Expression in Amphibian and Insect Cells* : 109–144.
7. Richards G (1997) The ecdysone regulatory cascades in *Drosophila*. *Advances in Developmental Biology* (1992) : 81–135.
8. Boyd M, Ashburner M (1977) The hormonal control of salivary gland secretion in *Drosophila melanogaster*: studies in vitro. *Journal of Insect Physiology* 23: 517–523.
9. Farkaš R, Šut'áková G (1998) Ultrastructural changes of *Drosophila* larval and prepupal salivary glands cultured in vitro with ecdysone. *In Vitro Cellular & Developmental Biology-Animal* 34: 813–823.
10. Zhimulev IF, Kolesnikov NN (1975) Synthesis and secretion of mucoprotein glue in the salivary gland of *Drosophila melanogaster*. *Development Genes and Evolution* 178: 15–28.
11. Burtis KC, Thummel CS, Jones CW, Karim FD, Hogness DS (1990) The *Drosophila* 74EF early puff contains E74, a complex ecdysone-inducible gene that encodes two ets-related proteins. *Cell* 61: 85–99.
12. Carney GE, Wade AA, Sapra R, Goldstein ES, Bender M (1997) DHR3, an ecdysone-inducible early-late gene encoding a *Drosophila* nuclear receptor, is required for embryogenesis. *Proceedings of the National Academy of Sciences of the United States of America* 94: 12024.

13. Chao AT, Guild GM (1986) Molecular analysis of the ecdysterone-inducible 2B5" early'puff in *Drosophila melanogaster*. *The EMBO Journal* 5: 143.
14. DiBello PR, Withers DA, Bayer CA, Fristrom JW, Guild GM (1991) The *Drosophila* Broad-Complex encodes a family of related proteins containing zinc fingers. *Genetics* 129: 385.
15. Segraves WA, Hogness DS (1990) The E75 ecdysone-inducible gene responsible for the 75B early puff in *Drosophila* encodes two new members of the steroid receptor superfamily. *Genes & development* 4: 204.
16. Stone BL, Thummel CS (1993) The *Drosophila* 78C early late puff contains E78, an ecdysone-inducible gene that encodes a novel member of the nuclear hormone receptor superfamily. *Cell* 75: 307–320.
17. Biyasheva A, Do TV, Lu Y, Vaskova M, Andres AJ (2001) Glue secretion in the *Drosophila* salivary gland: a model for steroid-regulated exocytosis. *Developmental Biology* 231: 234–251.
18. Andres AJ, Thummel CS (1995) The *Drosophila* 63F early puff contains E63-1, an ecdysone-inducible gene that encodes a novel Ca (2+)-binding protein. *Development* 121: 2667.
19. Bonafe NM, Sellers JR (1998) Calmodulin-binding proteins of the cytoskeleton. *Calmodulin and Signal Transduction* : 347.
20. Hasson T, Mooseker MS (1994) Porcine myosin-VI: characterization of a new mammalian unconventional myosin. *Journal of Cell Biology* 127: 425.
21. Mooseker MS, Cheney RE (1995) Unconventional myosins. *Annual Review of Cell and Developmental Biology* 11: 633–675.
22. Do T (2001) Steroid hormone regulation of glue secretion in *Drosophila melanogaster*. Northwestern University, Dissertation.
23. Vaskova M, Bentley AM, Marshall S, Reid P, Thummel CS, et al. (2000) Genetic analysis of the *Drosophila* 63F early puff: Characterization of mutations in E63-1 and maggie, a putative Tom22. *Genetics* 156: 229.
24. Costantino BFB, Bricker DK, Alexandre K, Shen K, Merriam JR, et al. (2008) A Novel Ecdysone Receptor Mediates Steroid-Regulated Developmental. .
25. Andres AJ, Thummel CS (1994) Methods for quantitative analysis of transcription in larvae and prepupae. *Methods in cell biology* 44: 565.
26. Maroni G, Stamey SC (1983) Use of blue food to select synchronous, late third instar

- larvae. *Dros. Inf. Serv* 59: 142–143.
27. Doyle KE, Kovalick GE, Lee E, Beckingham K (1990) *Drosophila melanogaster* contains a single calmodulin gene*: Further structure and expression studies. *Journal of molecular biology* 213: 599–605.
 28. Smith VL, Doyle KE, Maune JF, Munjaal RP, Beckingham K (1987) Structure and sequence of the *Drosophila melanogaster* calmodulin gene* 1. *Journal of molecular biology* 196: 471–485.
 29. Heiman RG, Atkinson RC, Andruss BF, Bolduc C, Kovalick GE, et al. (1996) Spontaneous avoidance behavior in *Drosophila* null for calmodulin expression. *Proceedings of the National Academy of Sciences* 93: 2420.
 30. Scott K, Sun Y, Beckingham K, Zuker CS (1997) Calmodulin regulation of *Drosophila* light-activated channels and receptor function mediates termination of the light response in vivo. *Cell* 91: 375–383.
 31. Nelson HB, Heiman RG, Bolduc C, Kovalick GE, Whitley P, et al. (1997) Calmodulin point mutations affect *Drosophila* development and behavior. *Genetics* 147: 1783.
 32. FlyBase Reference Report: Keleman et al., 2009.8.5, RNAi-phiC31 construct and insertion data submitted by the Vienna *Drosophila* RNAi Center. Available at: <http://flybase.org/reports/FBbrf0208510.html>. Accessed 5 July 2010.
 33. Brand AH, Perrimon N (1993) Targeted gene expression as a means of altering cell fates and generating dominant phenotypes. *Development* 118: 401.
 34. Deng W, Leaper K, Bownes M (1999) A targeted gene silencing technique shows that *Drosophila* myosin VI is required for egg chamber and imaginal disc morphogenesis. *J Cell Sci* 112: 3677–3690.
 35. Geisbrecht ER, Montell DJ (2002) Myosin VI is required for E-cadherin-mediated border cell migration. *Nat Cell Biol* 4: 616–620.
 36. Berendes HD, Ashburner M (1978) The salivary glands. *The genetics and biology of Drosophila* 2: 453–498.
 37. Lehmann M (2005) *Drosophila* Sgs genes: stage and tissue specificity of hormone responsiveness. *BioEssays* 18: 47–54.
 38. Stull JT, Kamm KE, Krueger JK, Lin PJ, Luby-Phelps K, et al. (1997) Ca²⁺/calmodulin-dependent myosin light-chain kinases. *Advances in second messenger and phosphoprotein research* 31: 141–150.

CHAPTER 5

THE SALIVARY GLAND CAN BE USED TO STUDY INTRACELLULAR TRAFFICKING

5.1: Introduction.

In the previous chapter, I presented data on a cooperative mechanism involving Ca^{2+} binding proteins and myosin motors that must be required for glue secretion by salivary glands. Presumably this mechanism is part of a trafficking network designed to transport newly synthesized glue to the site of secretion on the cytosolic side of the plasma membrane. Most of our knowledge about intracellular trafficking comes from yeast mutant studies or *in vitro* studies using purified mammalian components. My salivary gland assay, and the genetic tools available to manipulate *Drosophila* genomes, allows us to use fluorescently-tagged cargo markers in live cells before, during, and after glue secretion to characterize secretion defects at the subcellular level. To this end, I collected 31 stocks that contained compartmental markers tagged with GFP, dsRED, or YFP (Yellow Fluorescent Protein) (Table 5-1). I used these markers to characterize normal trafficking events before, during, and after the 20E-regulated secretion of glue (Fig. 5-1A-F).

By determining the localization of the compartments we should be able to evaluate secretion-defective phenotypes caused by any genetic disruption to the normal state of the cell. As proof of principle I analyzed a secretion defect caused by the overproduction of GDI (Guanine diphosphate Dissociator Inhibitor), a necessary component for recycling Rab GTPases from subcellular membranes [1]. When a *UAS-GDI* transgene is

overproduced in the larval salivary gland with the *glueGal4 driver*, abnormally shaped glue granules form that are not secreted (Fig. 5-2).

The normal function of GDI is to recycle GDP-bound Rab proteins from the acceptor membrane and return them to the donor membrane. The GDI bound Rab is separated by a GDI Displacement Factor allowing the Rab to interact with a GDP-GTP Exchange Factor, which in turn allows GDP to be replaced with GTP. This process is carefully regulated to insure proper trafficking of secretory or organelle cargoes.

The parental lines presented in Figure 5-1 were used to develop a profile of the compartmental markers. We then overexpressed GDI and compared the results to the parental lines. Several interesting effects were noted: expansion of the ER and a failure to acidify granules (Fig. 5-4 and Fig. 5-5). This is not a surprising conclusion because GDI is a non-specific effector of Rab proteins and overexpression of GDI probably disrupts multiple Rab proteins that are constituents of different compartments in the trafficking network.

5.2: Materials and Methods.

5.2.a: *Drosophila* Culture

Animals were raised on standard cornmeal-molasses medium as previously described ([2, 3]). The *UAS-GDI* transgenic line was generated in a transposon-mobilization screen designed to place *UAS* elements next to important genes that, when over- or mis-expressed, caused lethality (John Merriam, personal communication). The *UAS-GDI-tetra* stock was obtained from Clarrisa Cheney. It contains four tags (tetra) fused in frame to the C-terminus of GDI. These were placed there for biochemical analyses of purified GDI protein. Two GDI RNAi lines were acquired: *UAS-GDI-i108694*; *UAS-GDI-H68A4* (*i108694* and *H68A4*). All other stocks used for this analysis are listed in Table 5-1.

For the subcellular characterization, all marker stocks (*UAS-regulated* or exon trapped from Table 5-1) were crossed to the *sgGal4* driver that is expressed only in salivary glands during the larval stages as previously described in [4].

For the GDI analysis, an assay stock (*glue::GDI*) was constructed using two transgenes (*P[glueGal4]*, *P[UAS-GDI]*). Because these inserts were on the second chromosome they were recombined to produce a homozygous *glue::GDI* stock.

Table 5-1: Fluorescently labeled markers used in identifying cellular structures.

Stock	Flybase or Flytrap ID	UAS or Flytrap	Reported Compartment
UAS-GFP.nls, glueRED	FBst0004775	UAS	Nucleus; Glue
UAS-RedStinger	FBst0008545	UAS	Nucleus
UAS-YFP-Rab26	FBst0023244	UAS	Unreported
UAS-GFP.T10	FBst0001522	UAS	Nuclear
CaM ^{G00389.GFP}	G00389 (unavailable)	Flytrap	Calmodulin
b-tub56D	CC02069	Flytrap	Tubulin
UAS-GFP.aTub84D	FBst000737	UAS	Tubulin
UAS-GFP.Actin5C	FBst0009257	UAS	Actin
UAS-Syt.GFP	FBst0006925	UAS	Vesicle Membrane
UAS-gap.GFP	FBst0004522	UAS	Plasma Membrane
UAS-n-Syb.GFP	FBst0006922	UAS	Vesicle Membrane
UAS-n-Syb.GFP-pH	Gift from R. Davis	UAS	Vesicle Membrane (pH sensitive)
UAS-YFP-Rab6	FBst0023251	UAS	Golgi
UAS-Rab11-GFP	FBst0008506	UAS	Late Endosome
UAS-GFP.Clc	FBst0017428	UAS	Clatherin (Vesicles)
UAS-mito.GFP	FBst0008443	UAS	Mitochondria
UAS-GFP.KDEL	FBst0009898	UAS	Endoplasmic Reticulum
Sec61 α ^{ZCL0488.GFP}	FBst0307768	Flytrap	Endoplasmic Reticulum
Pdi ^{G00198.GFP}	FBst0006839	Flytrap	Endoplasmic Reticulum
Sqh-YFP-ER	FBst0007195	Expressed Transgene	Endoplasmic Reticulum
Sqh-YFP-Golgi	FBst0007193	Expressed Transgene	Golgi
UAS-Lamp1.GFP	Gift from J. Eissenberg	UAS	Golgi
UAS-spin-Myc.GFP	Gift from S. Sweeney	UAS	Late Endosome/ Lysosome
UAS-Rab4-RFP	FBst0008505	UAS	Endosome
UAS-YFP-Rab7	FBst0023270	UAS	Late Endosome
UAS-YFP-Rab5	FBst0024616	UAS	Early Endosome
UAS-YFP-Rab1	FBst0024104	UAS	Endoplasmic Reticulum
UAS-YFP-Rab10	FBst0009789	UAS	Unreported
UAS-YFP-Rab19	FBst0024150	UAS	Unreported
UAS-GGA-YFP	Gift from J. Eissenberg	UAS	Trans-Golgi

5.2.b: Microscopy and Imaging

Salivary glands were dissected in DPBS as previously described (see 2.2.e). High-resolution images of dissected salivary glands were imaged on a LSM 510 Axioplan confocal microscope (Carl Zeiss SMT, Peabody, MA) equipped with LSM 510 image-analysis software.

5.2.c: Western Blot and Quantification

Salivary glands were dissected and processed from larvae before and after the *in vivo* ecdysone pulse. Blots were prepared as described previously (chapter 4). Antibodies were used at the following dilutions: 1:1000 for anti-GDI mouse polyclonal (gift from Clarrisa Cheney); 1:5000 for anti- α -tubulin (Sigma), 1:10000 for horseradish-peroxidase conjugated goat anti-mouse antibodies (Jackson ImmunoResearch Laboratories). Quantification was done using ImageQuant software for Typhoon PhosphorImager (Molecular Dynamics).

5.3: Results.

5.3.a: Fluorescently Tagged Markers Can be Used to Analyze a Secretion Phenotype.

We acquired a collection of 31 compartmental markers to use in a descriptive analysis of the cellular compartments in the salivary gland cells. The salivary glands were dissected from staged larvae that represented a time in the third instar before 20E exposure, after 20E exposure but before secretion, and after secretion (Fig. 5-1). After surveying the images, several markers were notable and used to assay the effects of GDI overexpression on intracellular trafficking.

Figure 5-1: Confocal images of the molecular markers used to study secretion.

Salivary glands expressing the markers listed in Table 5-1 were staged and imaged on a confocal microscope. Each panel represents a different stage in the third instar that is relevant to glue secretion. The panels are chronologic and refer to either a time before 20E exposure (left), after 20E exposure but before glue secretion (middle), or after glue secretion (right). All images were taken at the same magnification, and the bar (indicated in A, first row) represents 50 μm . Markers used for the analysis are listed to the left of each row. YFP-tagged markers were colorized to distinguish between those labeled with GFP.

A

Early

Mid

Late

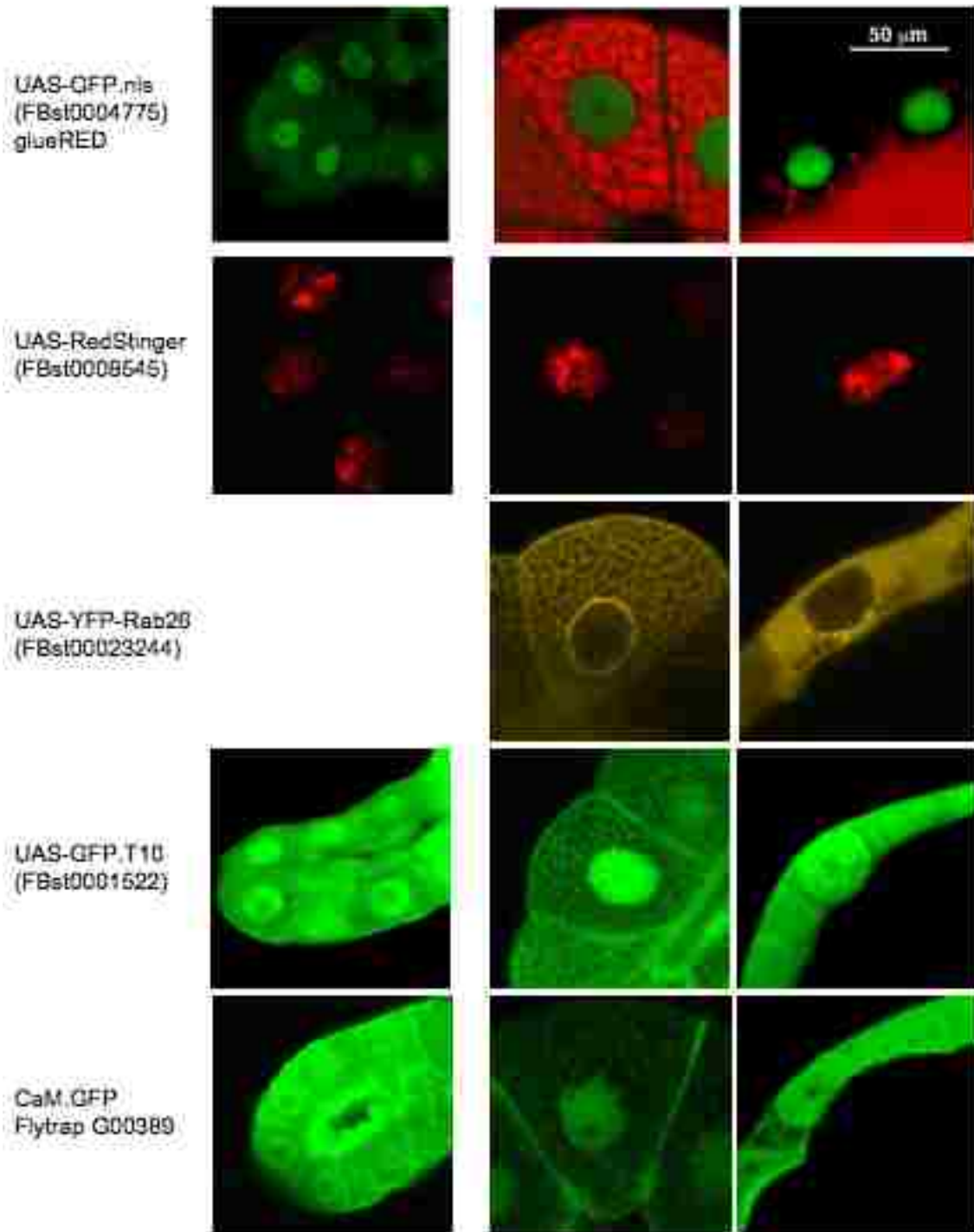

B

Early

Mid

Late

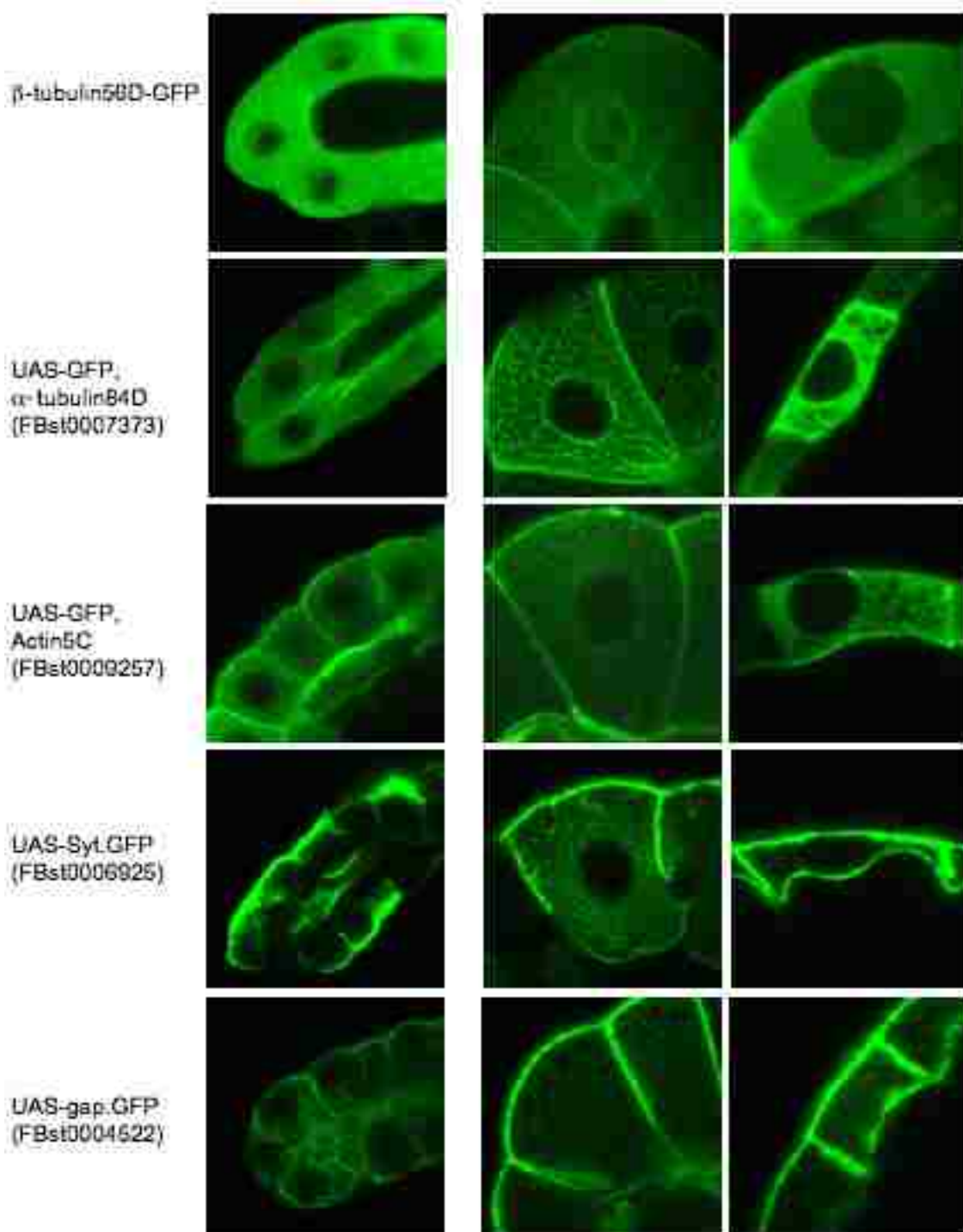

C

Early

Mid

Late

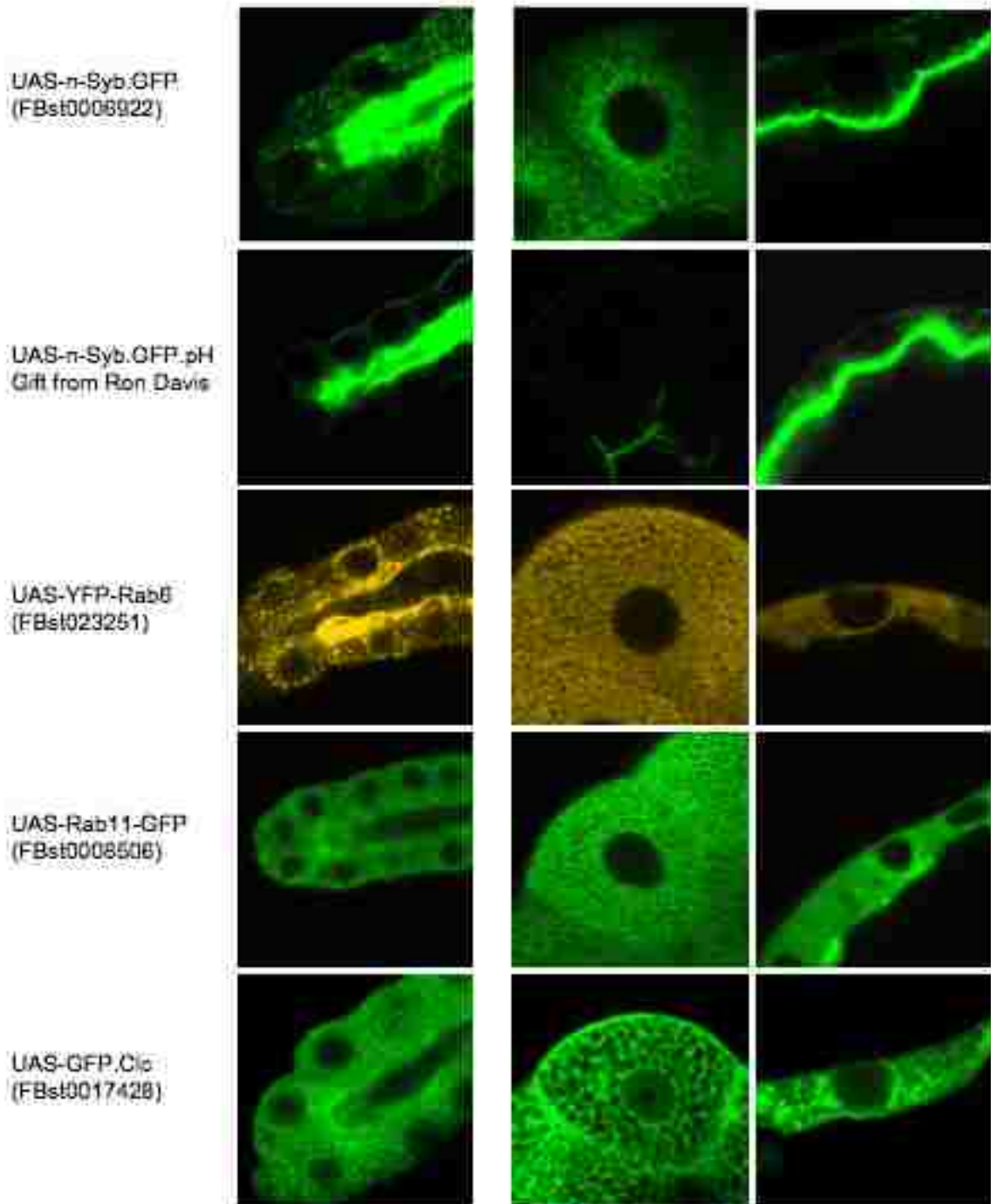

D

Early

Mid

Late

UAS-mito.GFP
(FBst0008443)

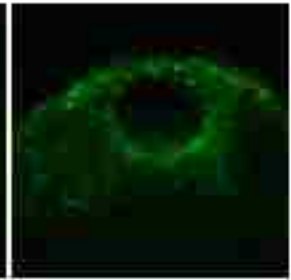
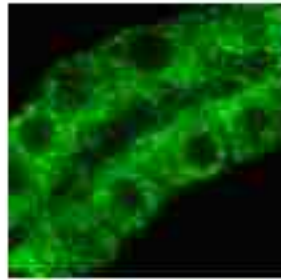

UAS-GFP.KDEL
(FBst0009808)

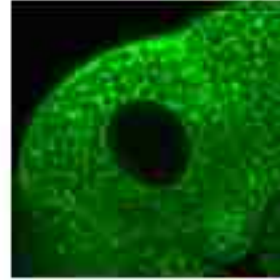
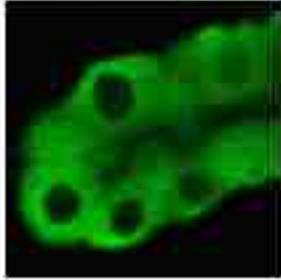

Sec61 α .GFP
Flytrap ZCL0488
(FBst0307768)

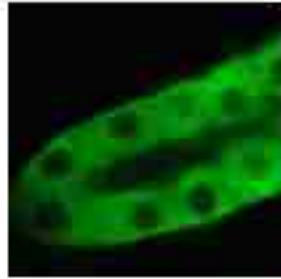

Pdi.GFP
Flytrap G00198
(FBst0008839)

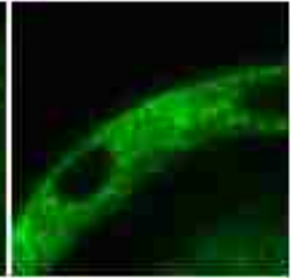
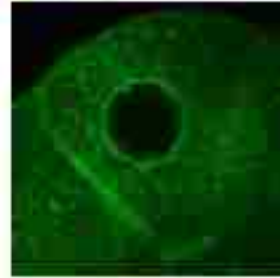
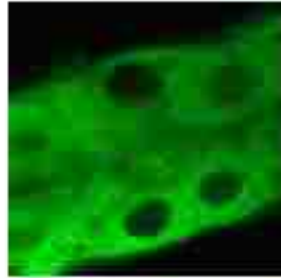

Sqh-YFP-ER
(FBst0007195)

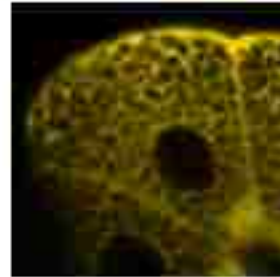
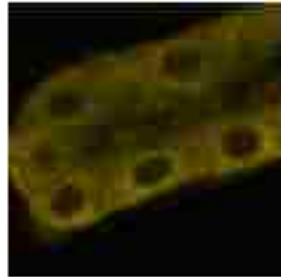

E

Early

Mid

Late

Sch-YFP-Golgi
(FBst007193)

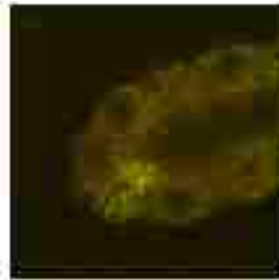

UAS-Lamp1-GFP
Gift from
Joel Eissenberg

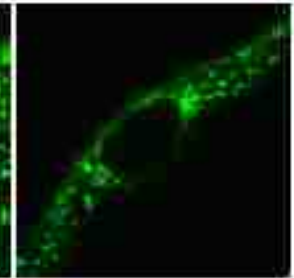
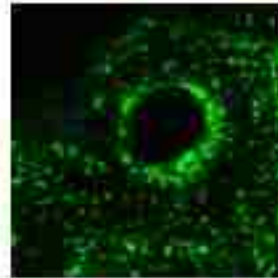

UAS-spin-Myc.GFP
Gift from
Sean Sweeney

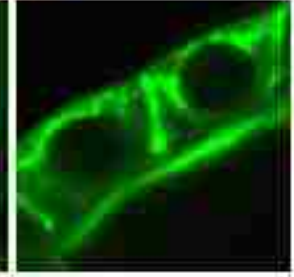
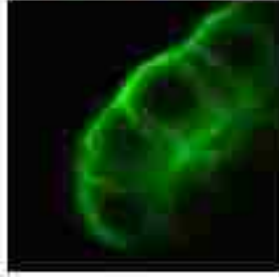

UAS-Rab4-RFP
(FBst0008505)

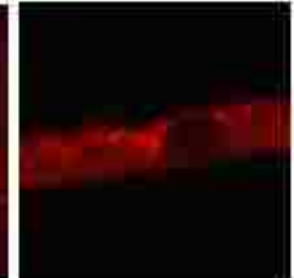

UAS-YFP-Rab7
(FBst0023270)



F

Early

Mid

Late

UAS-YFP-Rab5
(FBst0024616)

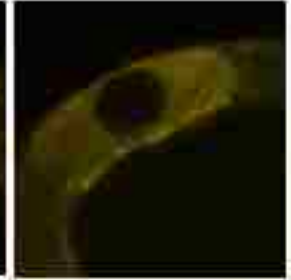
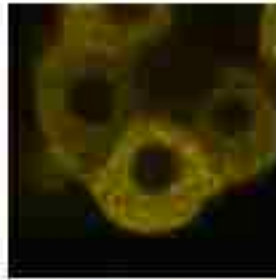

UAS-YFP-Rab1
(FBst0024104)

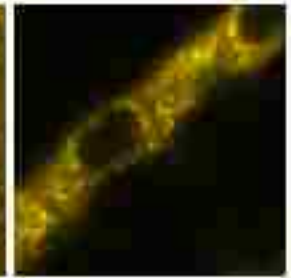
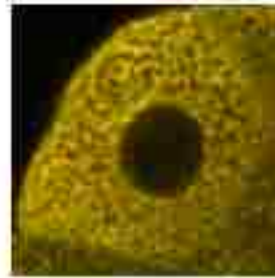

UAS-YFP-Rab10
(FBst0009789)

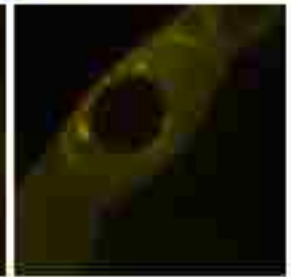
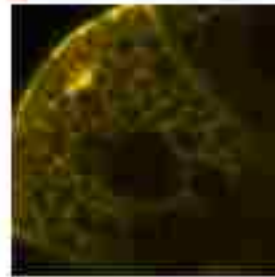

UAS-YFP-Rab19
(FBst0024150)

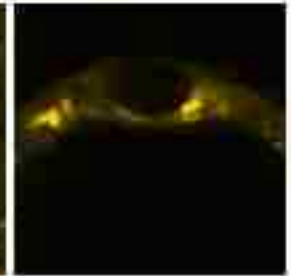
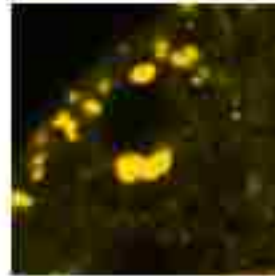
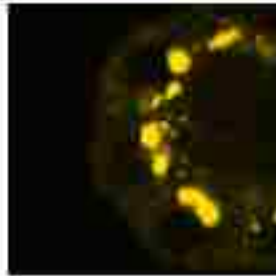

UAS-GGA-YFP
Gift from
Joel Eisenberg

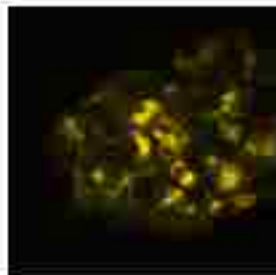

5.3.b: GDI Overexpression Inhibits Glue Secretion

With this catalog of cargo markers on hand we next attempted to characterize the secretion-defective phenotype produced when GDI is expressed in the salivary gland with *glueGal4*. The typical shape of the glue granules in the salivary gland is spherical with a diameter ranging from 3-8 μm (Fig. 5-2A). When *UAS-GDI* is expressed, not only is the granule shape distorted (Fig. 5-2B), but the misshapen cargoes never secrete. Thus we first wanted to investigate whether endogenous GDI was 20E regulated, and how much more GDI was produced under the conditions in which *UAS-GDI* is expressed by salivary gland drivers. We also wanted to evaluate the efficacy of another tagged-GDI line (*UAS-GDI-tetra*) and two RNAi lines containing inverted repeats of GDI (*UAS-GDIi-108694* and *UAS-GDIi-H68A4*).

The Western analysis shows that GDI does not appear to be 20E regulated because endogenous levels of protein do not change relative to the 20E-regulated secretion status of the gland (Fig. 5-3, lanes 1-4). In addition, GDI is overexpressed at least two-fold when *UAS-GDI* or *UAS-GDI-tetra* are driven with *glueGal4* (Fig 5-3, lanes 5 and 6 respectively). Interesting, overexpressing *GDI-tetra* did not cause a secretion-defective phenotype, perhaps because the tetra tag in the C-terminus of the molecule compromises some of its normal functions. Finally, the two RNAi lines (*GDIi-108694* and *GDIi-H68A4*) show a significant reduction in GDI protein (Fig. 5-3, lanes 7 and 8 respectively) indicating that they should be useful reagents for future loss-of-function analysis. As further proof of their silencing ability, when either *UAS-GDIi* line is expressed at the same time as *UAS-GDI* (the overexpression line), the secretion defect associated with that ectopic expression is rescued.

Figure 5-2: Overexpression of GDI causes misshapen granules that fail to secrete.

(A) Confocal image of salivary glands dissected from a gland in which the *glueGRN* transgene is expressed. (B) A similarly-staged gland in which *UAS-GDI and glueGRN* are expressed. In the wildtype cell (A), mature granules are spherical and uniformly shaped. When GDI is overexpressed (B), the granules are irregular shaped and inconstant in size.

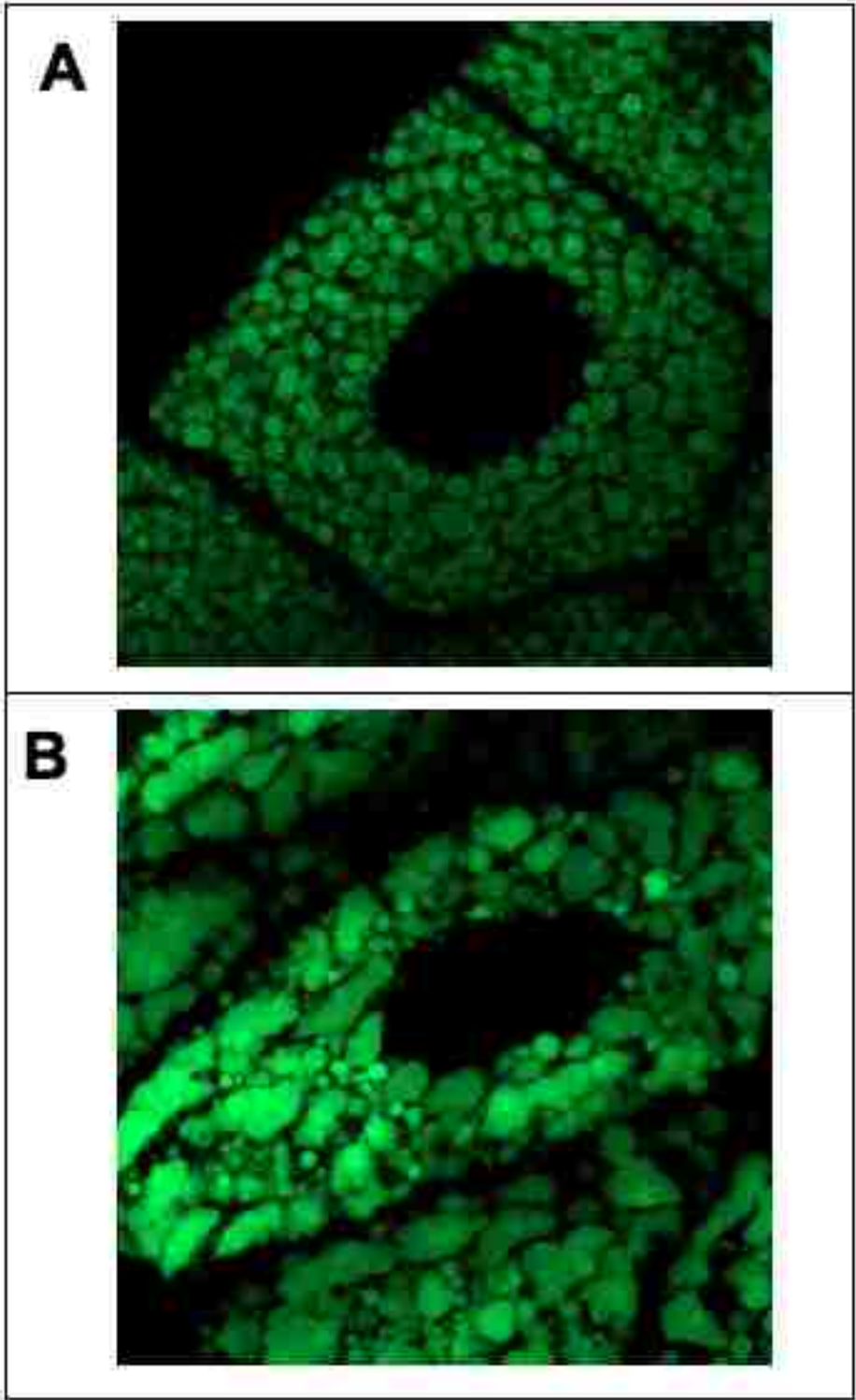
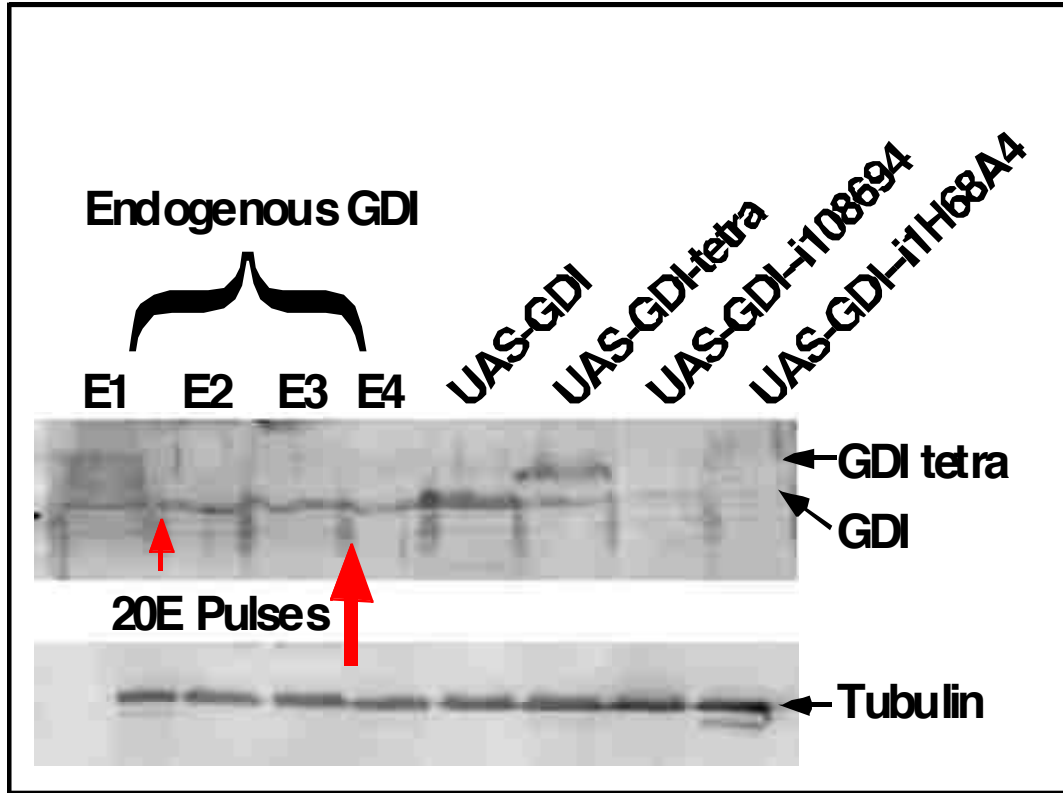

Figure 5-3: Western analysis of genetic reagents that affect GDI levels.

Protein from salivary glands dissected out of wildtype larvae before and after each of the two 20E pulses that occur during the last half of the third instar (E1-E2, the time and magnitude of each 20E pulse is indicated by the red arrows); GDI overexpressing larvae (*UAS-GDI*; *UAS-GDI-tetra*); and GDI RNAi (*UAS-GDI-i108694*; *UAS-GDIi-H68A4*) larvae were run on a 12% SDS gel and blotted. The blot was incubated with GDI antibody. Endogenous GDI is uniformly expressed throughout the third instar and does not appear to be affected by 20E pulses. GDI is enriched in the two overexpressing lanes, and the RNAi lanes show a reduction of GDI protein. α -Tubulin (bottom) was used as a control for loading and blotting.



I crossed several cargo lines to an assay stock in which GDI is being overexpressed (*glue::GDI*) to compare the effects on various compartments. Of particular interest are the ER markers GFP.KDEL (Fig. 5-1D, 2nd row), Sec61 α ^{ZCL0488.GFP} (Fig. 5-1D, 3rd row), Pdi-GFP (Fig. 5-1D, 4th row), and Sqh-ER-YFP (Fig. 5-1D, 5th row). Confocal images of the parental lines showed strong peri-nuclear staining in which the ER was clearly labeled. When GDI was overexpressed in these lines, we saw a distinct expansion of the ER compared to parental lines (Fig. 5-4).

The pH sensitive vesicle marker, n-Syb-pH (Fig. 5-1C, 2nd row), is a version of the secretory vesicle integral membrane protein, synaptobrevin, with a pH sensitive GFP tag. The GFP tag is located at the C-terminus, thereby allowing it to be internalized in the formation of the vesicle. The GFP is engineered to remain quenched in acidic environments. This characteristic was valuable to determine the status of the internal environment of the glue granules. Fluorescence inside of the granules changed when GDI was overexpressed in n-Syb-pH cells (Fig. 5-5, white arrows) compared to the quenched signal in the parental line. This change indicates a neutral pH environment inside the granules of GDI (Fig. 5-5), presumably caused by a failure of the granules to acidify.

Figure 5-4: Overexpression of GDI causes expansion of the ER.

The compartment of the endoplasmic reticulum is visualized using four different types of fluorescent markers. The images are taken at a time just before secretion would occur. The top row is an example of the markers in a wildtype background. Strong perinuclear staining is seen as an indication of the ER. Below each image is an example of the effect of GDI overexpression on the localization of the ER. In these panels, the ER is shown to be expanding deeper into the cytoplasm.

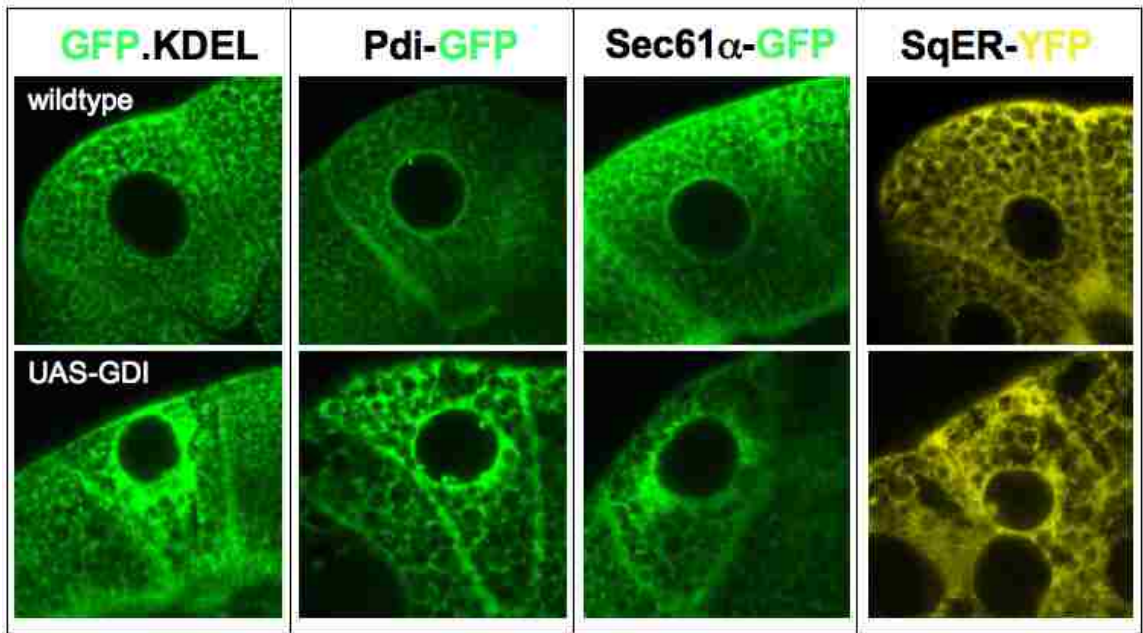
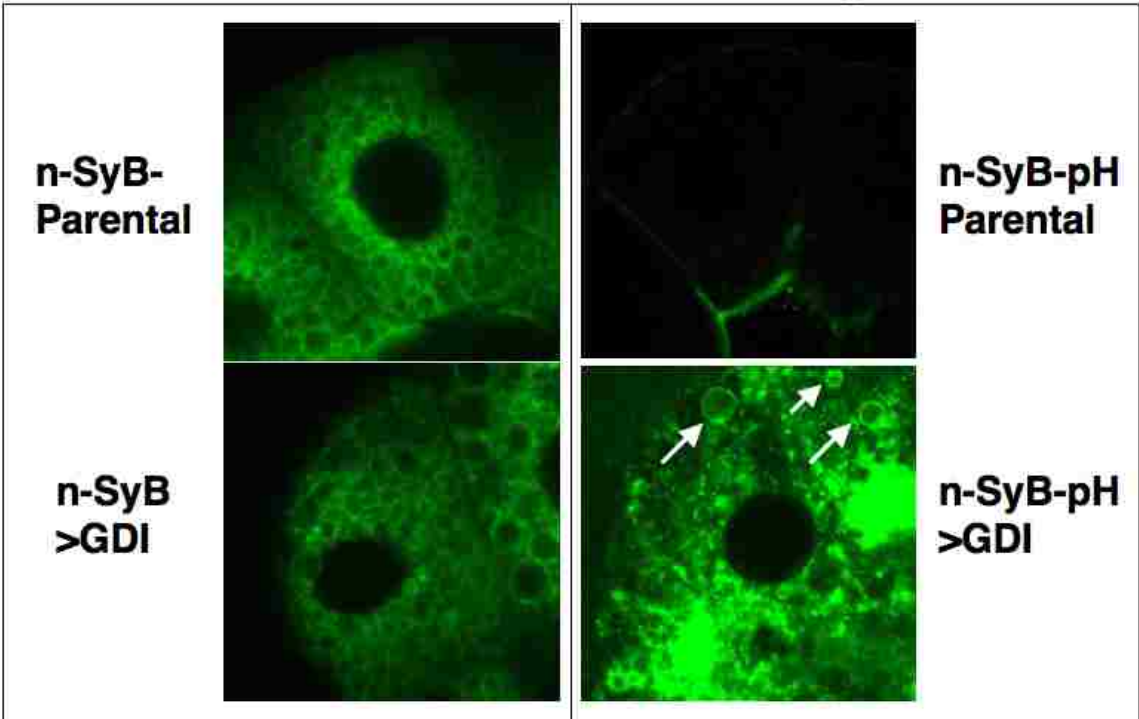

Figure 5-5: Granules fail to acidify when GDI is overexpressed.

Two versions of GFP tagged synaptobrevin were used to describe the glue granules: n-SyB and n-Syb-pH. n-SyB outlines the granules in both the parental line and GDI overexpressing lines (left panels). The size and shape of the granules differed. On the right, n-Syb-pH was used to investigate any difference in the pH inside of GDI overexpressing cells. The C-terminal pH sensitive GFP tag of n-SyB-pH is placed inside the vesicle, allowing for reactivity with the internal environment. In acidic conditions (top right), the GFP signal is quenched. GDI overexpression causes a change in fluorescence in n-Syb-pH and the GFP signal is seen in the granule structures (white arrows).



5.4: Discussion.

Intracellular trafficking can be studied using available fluorescently tagged cellular compartment markers. To validate this, I studied a secretion phenotype caused by GDI overexpression in cells expressing these markers. Using this approach, I showed that GDI overexpression has multiple effects on granule trafficking, but is primarily relegated to the ER. This was verified in Figures 5-4 and 5-5, where we observed ER expansion and a failure of granules to acidify compared to the parental lines.

The ER expansion observed in GDI overexpression could be due to a defect in Rab recycling at the ER membrane. One explanation is that vesicles containing glue peptides may not be able to be delivered to the next location for processing and instead be “stuck” at the ER. Alternatively, ER membrane may not be recycled properly and cause deformations in the glue granules and the ER itself.

Also observed in cells overexpressing GDI, is a failure of glue granules to acidify (Fig. 5-5). n-SyB-pH is a reagent that fluoresces green in neutral pH and was originally used to determine if the misshapen granules were lysosomes. Initially we thought that a perturbation in Rab trafficking caused glue granules to default into lysosomes. However, this was not the case when we examined lysosome markers (data not shown), but the n-SyB-pH reagent proved useful in showing that the pH environment of the glue granules is naturally acidic. When GDI was overexpressed, n-SyB-pH fluoresced inside the granules indicating a failure of the granules to acidify.

This study provides a powerful example of how the salivary gland can be used in a descriptive analysis of cellular trafficking. In the future, we would like to employ the same strategy to clarify the data in chapter 4 and to screen other reagents that cause a

defect in secretion. Also, there are 33 Rab proteins identified in the *Drosophila* genome, but many are as yet uncharacterized. Many of these Rabs have overlapping or redundant functions in the cell or have no function reported. By testing them for rescue in the GDI phenotype we may be able to ascribe more functions to each of them. We hope to continue developing a profile of compartment markers to use as a valuable reference and feel that this is an ideal system to investigate cell trafficking.

5.5: References.

1. Zhang J, Schulze KL, Hiesinger PR, Suyama K, Wang S, et al. (2007) 31 Flavors of *Drosophila* Rab Proteins. *Genetics*.
2. Andres AJ, Thummel CS (1994) Methods for quantitative analysis of transcription in larvae and prepupae. *Methods in cell biology* 44: 565.
3. Maroni G, Stamey SC (1983) Use of blue food to select synchronous, late third instar larvae. *Dros. Inf. Serv* 59: 142–143.
4. Costantino BFB, Bricker DK, Alexandre K, Shen K, Merriam JR, et al. (2008) A Novel Ecdysone Receptor Mediates Steroid-Regulated Developmental.

CHAPTER 6

GENERAL DISCUSSION

6.1: Introduction.

In discussion, I summarize the data presented in previous chapters and reiterate the major conclusions. I also detail the significance of these results as it relates to the value of the larval salivary gland as an ideal model tissue to study a nuclear hormone response and cell biology pathways.

6.2: Summary of the Glue Synthesis Model.

The model of 20-hydroxyecdysone regulation in *Drosophila* is constantly evolving. The initial 20E model proposed that 20E is the molecule responsible for hierarchical gene activation represented as early and late chromosomal puffs on polytenized chromosomes. This model was modified to include the ecdysone receptor as the signal mitigation component in the 20E response pathway. The ecdysone receptor was known at that time to be a heterodimer of the RXR homolog, USP, and the FXR homolog EcR. This was supported in vertebrate studies as well, since all nuclear receptor heterodimers in vertebrates were known to be between RXR and any number of different nuclear receptors (e.g. TR or ERR).

We can further modify the 20E model to include a functional ecdysone receptor without an RXR component. The data presented in chapter 2 describe a 20E response that operates through a novel nuclear receptor heterodimer, and show convincingly that glue synthesis in the mid-third instar salivary gland is regulated by 20E. Driving the expression of USPⁱ does not perturb glue synthesis (Fig. 2-6) and overexpressing USP blocks synthesis (Fig. 2-8). Taken together, this is strong evidence that USP is not

required in the 20E regulated glue synthesis response and that USP can outcompete the receptor required for glue synthesis.

The next logical step in the glue synthesis story was to identify the receptor that is required for glue synthesis. After an RNAi screen of all possible nuclear receptors, I identified DHR96 as a necessary nuclear receptor required for the USP independent 20E responsive glue synthesis described in chapter 2. DHR96 is the vertebrate homolog of the vitamin D receptor (VDR) and thus the screen seems to indicate that the steroid hormone 20E cannot function to synthesize glue without DHR96. Further modifying the 20E glue synthesis model to establish a novel ecdysone receptor required for glue synthesis.

This bold hypothesis demanded the efficacy of the *UAS-DHR96i* reagent be scrutinized and evaluated. I validated the knockdown of DHR96 protein levels using western blot and immunohisto chemistry (Figures 3-2 and 3-3) and also examined *DHR96* transcript levels in qRT-PCR (Fig. 3-4). Also, I show that *DHR96i* is specific to DHR96 and not EcR because, as shown in Table 3-2, glue synthesis was not rescued by overexpressing the EcR-B isoforms. Finally, members of the broad complex transcription factors that are 20E regulated and are necessary for glue induction did rescue the DHR96i phenotype. These experiments demonstrate that *DHR96i* specifically knocks down DHR96 protein and, like EcR, DHR96 is in the same pathway as BR-C for the induction of glue genes.

I show that overexpression of *DHR96* can inhibit USP function by inhibiting glue secretion (Fig. 3-7). This is a reciprocal experiment from Chapter 2 (Fig. 2-8) in-which USP overexpression during the mid-third instar blocks glue synthesis. Presumably, the

ectopic overexpression of these receptors competes with EcR binding that would be required for a temporal 20E response in the salivary gland, supporting the hypothesis that temporal regulation of the 20E response occurs through EcR and DHR96 in the mid-third instar salivary gland, but in the late third instar it occurs through EcR and USP.

6.3: Summary of Glue Secretion Model.

Following the same historical lines as the glue model, glue secretion was shown to respond to 20E in cultured salivary glands in the 1970s [1]. A number of 20E responsive genes were cloned and characterized during this time, much of them being transcription factors. While it was shown that mutations in EcR and USP would affect the regulation of some of these genes and in turn block glue secretion, it was never demonstrated how these changes in gene regulation were related to glue secretion. Chapter 4 of this dissertation is designed to address this missing information and present a model for 20E regulated glue secretion.

Biyasheva *et al.* show that E63-1 is induced by 20E and that ectopic expression of the protein at a time before 20E exposure causes precocious secretion of glue granules [2]. However, E63-1 mutants fail to block secretion. Using a combination of RNAi and pharmacological inhibitors, it was shown that E63-1 and calmodulin (CaM) may have a redundant function and are required for 20E regulated secretion in *ex vivo* tissue cultures [3]. Additionally, both proteins can co-immunoprecipitate with myosin VI [3]. I used transgenic reagents to perturb the functions of CaM and E63-1 in living larvae.

Silencing the functions of both CaM and E63-1 in the salivary gland showed a dramatic reduction in glue secretion. This result was expected, because of the sequence similarity shared by both proteins and the past research done using pharmacological

reagents. However, the inhibition of secretion was not complete. It is possible that a third calcium binding protein may be acting as a myosin light chain in concert with CaM and E63-1 to drive complete secretion. Further study of myosin heavy chains involved in secretion would be necessary to make definitive conclusions.

It was thought that myosin VI played a role in secretion, because an antisense version of myosin VI inhibits glue secretion. However, analysis of a null mutant forced us to reject that hypothesis. Alternatively, an RNAi screen of all other myosin heavy chains was performed. This screen proved fruitless, but this is not an ultimate scenario. To comprehensively investigate myosins it would be beneficial to describe the status of the compartments involved in trafficking and compare them to myosin mutants.

6.4: The Salivary Gland as a Model Tissue to Study Intercellular Trafficking.

Classically, cell trafficking has been studied using mutants in yeast systems or purified mammalian proteins. Yet, we have demonstrated the use of the salivary gland in studying a hormone signal that initiates the mass secretion of cellular cargo. The pathway was teased apart using transgenic lines, fluorescent markers and other molecular tools available for the salivary gland. This positions us to study the trafficking involved in glue secretion using the same genetic principles employed in the hormone study.

In chapter 5, I imaged a collection of fluorescently tagged cell compartment markers to create a profile of compartment localization. This profile can be compared against defects in glue secretion or trafficking to make hypotheses about the nature of the defect. This descriptive study was validated in a proof of principle analysis of a secretion defective phenotype introduced by the overexpression of GDI. By comparing the parent

lines to the secretion defective lines we saw a clear difference in ER morphology and cell cargo pH.

In future studies we can examine secretion defects caused by myosin molecules, myosin light chains, or other proteins in the salivary gland by evaluating the effect on the compartmental markers. This is a strong example of how the larval salivary gland of *Drosophila melanogaster* can be used to answer important biological questions.

6.5: References.

1. Boyd M, Ashburner M (1977) The hormonal control of salivary gland secretion in *Drosophila melanogaster*: studies in vitro. *Journal of Insect Physiology* 23: 517–523.
2. Biyasheva A, Do TV, Lu Y, Vaskova M, Andres AJ (2001) Glue secretion in the *Drosophila* salivary gland: a model for steroid-regulated exocytosis. *Developmental Biology* 231: 234–251.
3. Do TV (2001) Steroid hormone regulation of glue secretion in *Drosophila melanogaster*. Diss. Northwestern University: Evanston, Ill., 2001. Evanston, Ill.

VITA

Graduate College
University of Nevada, Las Vegas

Benjamin F.B. Costantino

Degrees:

Bachelor of Science, Biology, 2000
University of Nevada, Las Vegas

Special Honors and Awards:

2010, Spring, Graduate Access Scholarship
2008, Spring, BIOS Publication Award, UNLV
2004, Summer, GREAT Scholarship, UNLV
2003, Present, American Association for the Advancement of Science (AAAS)
2004, Present, Genetics Society of America (GSA)

Publications:

Costantino, B., Bricker, D., Alexandre, K., Shen, K., Merriam, J., Callender, J.,
Henrich, V., Presente, A., and A.J. Andres. "A novel ecdysone (20E) pathway
mediates the onset of glue synthesis in *Drosophila*." *PLoS Genetics*. 4 (6) 2008.

Dissertation Title: The Larval Salivary Gland of *Drosophila melanogaster*: A Model
System for Temporal and Spatial Steroid Hormone Regulation.

Dissertation Examination Committee:

Chairperson, Andrew J. Andres, Ph. D.
Committee Member, Frank van Breukelen, Ph. D.
Committee Member, Allen Gibbs, Ph. D.
Committee Member, Steven deBelle, Ph. D.
Graduate Faculty Representative, Ron Gary, Ph. D.