

Corticosterone-Induced Potentiation of Cocaine Seeking: A Potential Role for Organic Cation Transporter 3

Evan N. Graf
Marquette University

Recommended Citation

Graf, Evan N., "Corticosterone-Induced Potentiation of Cocaine Seeking: A Potential Role for Organic Cation Transporter 3" (2012). *Dissertations (2009 -)*. Paper 279.
http://epublications.marquette.edu/dissertations_mu/279

**CORTICOSTERONE-INDUCED POTENTIATION OF COCAINE SEEKING: A
POTENTIAL ROLE FOR ORGANIC CATION TRANSPORTER 3**

by
Evan N Graf, B.S.

A dissertation submitted to the Faculty of the Graduate School,
Marquette University,
in partial fulfillment of the requirements for
the degree of Doctor of Philosophy

Milwaukee, Wisconsin

December 2012

ABSTRACT

Corticosterone-Induced Potentiation of Cocaine Seeking: A Potential Role For Organic Cation Transporter 3

Evan N Graf

Marquette University, 2012

While it is known that stress plays a role in the relapse of cocaine-seeking behavior, recent studies demonstrate that stress may be acting as a “stage setter” rather than directly triggering further cocaine use. This model suggests stimuli that do not normally evoke relapse under stress-free conditions may result in drug seeking when the exposure occurs under stressful conditions. In this study, we examined the corticosterone-dependent potentiation of cocaine-induced reinstatement by a stressor, electric footshock (EFS), in rats following cocaine self-administration and extinction. We found that in rats with a history of drug exposure under low intake conditions, footshock alone did not reinstate cocaine seeking, but did result in a potentiation of reinstatement in response to a subthreshold dose of cocaine (2.5 mg/kg, ip.). This effect was abolished in adrenalectomized rats and reproduced in intact animals receiving a physiologically relevant dose of corticosterone (2.0 mg/kg, ip.). Administration of the glucocorticoid receptor (GR) antagonist RU-486 did not block these effects, suggesting a rapid, non-GR mediated mechanism. In order to determine the site of action, we performed *in vivo* microdialysis to measure dopamine levels in the nucleus accumbens (NAc) and found that, similar to its actions on cocaine-seeking behavior, corticosterone potentiated cocaine-induced increases in dopamine. In support of this evidence, direct administration of corticosterone into the NAc or prefrontal cortex (PFC) potentiated reinstatement to a subthreshold dose of cocaine, an effect that was blocked with pretreatment of the dopamine antagonist, fluphenazine. Through immunofluorescence studies, we have shown the presence of a high capacity, corticosterone sensitive, monoamine transporter, organic cation transporter 3 (OCT3), located in the NAc adjacent to tyrosine hydroxylase terminals, suggesting a potential interaction with dopamine clearance. Based on this, we hypothesize the mechanism involves corticosterone inhibition of OCT3-mediated dopamine clearance. In support of this mechanism, pretreatment of rats with normetanephrine, a non-glucocorticoid OCT3 inhibitor mimics the effect of corticosterone on reinstatement. These results suggest a novel mechanism through which stress may modulate dopaminergic signaling and promote drug-seeking behavior.

ACKNOWLEDGEMENTS

Evan N Graf

I would like to begin with thanking my advisor, Dr. John Mantsch, who has played an integral role in my growth as a scientist. Being a member of this laboratory has made my time as a graduate student truly enjoyable and I believe the knowledge I have gained in my time here will continue to serve me throughout my career. I would also like to thank Dr. Paul Gasser, who has provided tremendous guidance and support throughout this process. Additionally, the rest of my committee members, Drs. David Baker, Robert Wheeler and Michelle Mynlieff, who have offered invaluable advice and counsel. I would also like to thank the rest of students and faculty who have always been willing to lend a helping hand.

I am truly grateful to my family, especially my wife Kristen, for sticking with me during my time as a seemingly lifelong student, your support is deeply appreciated. Finally, I would like to thank my son, Elliott, for offering me a fun distraction throughout the writing process. Maybe someday I will read this to you when you have trouble sleeping.

TABLE OF CONTENTS

ACKNOWLEDGEMENTS.....	i
LIST OF TABLES.....	vi
LIST OF FIGURES.....	vii
CHAPTERS	
I. INTRODUCTION.....	1
Cocaine.....	1
Neurobiological Mechanisms of cocaine action.....	3
Mesolimbic dopamine system.....	4
Role of dopamine in motivated behavior.....	5
Dopamine response to aversive stimuli.....	7
Differential role of nucleus accumbens core and shell.....	8
Role of dopamine in drug use.....	10
Self-administration model.....	12
IV self-administration.....	13
Intake conditions.....	14

Extinction and reinstatement.....	15
Stress and drug use.....	18
Impact of stress on self-administration.....	18
Impact of stress on reinstatement.....	20
Circuitry of stress-induced reinstatement.....	21
Effect of level of drug intake on stress-induced reinstatement.....	24
Stress as a stage setter.....	26
Monoamines and other modulators of reinstatement.....	27
Dopamine.....	27
Norepinephrine.....	29
Serotonin.....	30
Kappa opioid system.....	31
Stress response and homeostasis.....	32
Corticosteroid receptors.....	35
Nongenomic mechanisms.....	37
Glucocorticoid hormones and cocaine abuse.....	38
Drug-induced plasticity.....	39

GR involvement in reinstatement.....	40
Non-GR mechanisms.....	42
Glucocorticoids and dopamine.....	43
Organic cation transporter 3 (OCT3).....	44
Specific aims.....	51
II. EFFECT OF GLUCOCORTICOIDS ON COCAINE-INDUCED REINSTATEMENT.....	53
Introduction.....	53
Materials and Methods.....	56
Results.....	62
Discussion.....	69
III. ROLE OF SITE SPECIFIC DOPAMINE IN CORTICOSTERONE-INDUCED.....	74
POTENTIATION OF COCAINE-INDUCED REINSTATEMENT	
Introduction.....	74
Materials and Methods.....	78
Results.....	82
Discussion.....	87
IV. ROLE OF ORGANIC CATION TRANSPORTER 3 IN CORTICOSTERONE –.....	93

INDUCED POTENTIATION OF COCAINE-INDUCED REINSTATEMENT	
Introduction.....	93
Materials and Methods.....	96
Results.....	98
Discussion.....	100
V. ROLE OF CORTICOSTERONE AND OCT3 IN COCAINE-INTAKE.....	104
DEPENDENT NEUROPLASTICITY	
Introduction.....	104
Materials and Methods.....	109
Results.....	115
Discussion.....	125
GENERAL DISCUSSION.....	131
SUMMARY OF FINDINGS.....	131
DISCUSSION.....	133
CONCLUSIONS.....	150
BIBLIOGRAPHY.....	151

LIST OF TABLES

1. The effects of experimental conditions on plasma corticosterone concentrations.....	65
2. Breakdown of behavioral responses during reinstatement testing in rats in which NAc shell and NAc core were targeted.....	85

LIST OF FIGURES

1. Diagram of the self-administration setup.....	13
2. Neural circuitry involved in reinstatement.....	24
3. Schematic of the hypothalamic pituitary adrenal axis.....	34
4. Model of organic cation transporter 3-mediated regulation of monoamine clearance.....	50
5. Effects of electric footshock on cocaine-induced reinstatement in intact rats....	63
6. Effects of EFS on cocaine-induced reinstatement in adrenalectomized rats.....	64
7. The effects of experimental manipulations on plasma corticosterone concentrations.....	66
8. Effects of the glucocorticoid receptor antagonist RU38486 and corticosterone treatment on cocaine-induced reinstatement.....	68
9. Effects of corticosterone on high dose cocaine-induced reinstatement.....	69
10. Site specific administration of corticosterone.....	83
11. Representation of cannulae placement into NAc and PFC.....	84

12. <i>In vivo</i> microdialysis measuring dopamine levels in the NAc.....	86
13. Effects of site specific fluphenazine treatment on cocaine-induced reinstatement following pretreatment with corticosterone.....	87
14. Photomicrograph of dual-label immunofluorescence for OCT3 and tyrosine hydroxylase in the nucleus accumbens.....	99
15. OCT3 inhibition enhances cocaine-induced reinstatement.....	99
16. Effects of cocaine self administration on OCT3 mRNA and protein levels.....	116
17. Plasma corticosterone levels during self administration sessions.....	120
18. Cocaine self administration and extinction in sham and adrenalectomy with diurnal corticosterone replacement-treated rats.....	121
19. Active lever responding during the reinstatement sessions preceded by 15 minutes of intermittent electric footshock or during the preceding extinction session in pre-self administration with corticosterone replacement, post-self administration with corticosterone replacement and sham-treated (n=16) rats following long access self administration.....	123
20. Corticotropin releasing factor-induced reinstatement in sham and ADX/C rats.....	125
21. Model of organic cation transporter-mediated regulation of monoamine clearance.....	141

I. BACKGROUND

Introduction

Drug addiction is a chronically relapsing disorder that is characterized by three traits: (1) Compulsion to seek and consume the drug, (2) an inability to control or limit intake of the drug, and (3) the presence of a negative emotional state, including anxiety and irritability, when the drug is not available (Koob and Le Moal 1997). This is distinct from occasional, recreational use of a drug, which, although it can still be detrimental to an individual's health, is not characterized as addiction. Drug abuse and addiction results in over \$160 billion worth of direct and indirect costs, including medical bills and societal issues (Bouchery, Harwood et al. 2001). This makes this disease a concern for a great number of individuals in our society and with no current, effective treatment strategy in place, it is the subject of intense research. Until we are able to gain a greater understanding of the condition and the neural mechanisms involved in the establishment, it is unlikely we will be able to effectively treat the individuals in need. It is the goal of this work to learn more about this disease and begin to explore potential new methods of treatment.

Cocaine

Cocaine is one of the most abused illicit drugs in America and is responsible for more emergency room visits than any other drug. Cocaine is an alkaloidal agent that was originally isolated from the leaves of the *Erythroxylon coca* bush primarily found in South America (Grabowski 1984). As one of the oldest known psycho stimulants, cocaine has been used for hundreds of years, originally coveted for its

ability to increase energy levels and decrease hunger (Kennedy 1985). Cocaine was primarily ingested by chewing on the coca leaf until it was isolated in the 1800s when there was an increase in use, including being added as an ingredient in many beverages as well as medicines.

Today, cocaine is labeled a Schedule II drug, meaning it has a high potential for abuse, but may still be prescribed for certain medical issues by physicians. Cocaine is a psychomotor stimulant that acts as an indirect sympathomimetic, similar to amphetamine. Psychomotor stimulants result in increases in arousal, alertness and overall motor activity and indirect sympathomimetics mimic the effects of sympathetic nervous system transmitters such as norepinephrine and dopamine (Koob and Le Moal 2006). Cocaine has also been used in medical situations as a local anesthetic during minor surgical procedures. Recently, however, other anesthetic drugs have largely taken its place.

Cocaine is most commonly abused in two different forms. As a hydrochloride salt it can be injected or snorted as a fine white powder. The freebase form, commonly referred to as “crack”, is created by precipitating cocaine hydrochloride into an alkaline solution and can be heated and smoked (Kennedy 1985). Cocaine hydrochloride is absorbed through mucous membranes or injected directly into the body. When administered nasally, peak concentrations in the plasma can be seen after approximately 60 minutes (Javaid, Fischman et al. 1978). When cocaine is transformed into freebase or crack and smoked, blood levels of the drug can reach levels seen following intravenous injection, the fastest route of entry, with peak

plasma concentrations seen within minutes (Jatlow 1987; Cook and Jeffcoat 1990). While the primary method of administration among users is snorting, all routes of administration can lead to serious health problems, including cardiovascular emergencies and seizure that can result in death.

Neurobiological Mechanisms of Cocaine Action

The rewarding properties of cocaine are a result of an increase in extracellular monoamine concentrations that occur within the brain (Taylor and Ho 1978; Ritz, Cone et al. 1990). In particular, cocaine blocks the reuptake of norepinephrine, dopamine and serotonin in the brain through inhibition of the respective transporters, with the greatest ability to block the reuptake of serotonin and the least being norepinephrine (Glowinski and Axelrod 1965; Iversen 1973; Rothman, Baumann et al. 2001). However, the actions on extracellular dopamine concentrations appear to be primarily responsible for most behavioral, physiological, and addicting actions of cocaine and it is the neurotransmitter examined in these studies.

Cocaine elevates dopamine levels through inhibition of a sodium and energy dependent transporter, the dopamine transporter (DAT) (Cao, Shamoo et al. 1990; Jones, Garris et al. 1995). Recent evidence suggests that the binding sites for cocaine and dopamine on DAT may overlap (Beuming, Kniazeff et al. 2008). This creates greater difficulty in treatment, as an antagonist used to block the binding site of cocaine would also prevent dopamine itself from interacting with its transporter. Other drugs of abuse, such as amphetamine, opiates and ethanol, also

exert their effects by altering dopamine levels, but through slightly different mechanisms. The common action of these drugs led to the dopamine hypothesis of drug abuse. This was hypothesized by Di Chiara and Imperato when they discovered an increase in dopamine levels in the nucleus accumbens (NAc) and dorsal caudate nucleus, both of which are terminal dopaminergic areas, using brain dialysis in freely moving rats (Di Chiara and Imperato 1988). In addition, positron emission tomography (PET) studies have shown radiolabeled cocaine distributed in the brain in areas that also contained dopamine, such as the striatum (Fowler, Volkow et al. 1989). Based on this work in these studies it was concluded that drugs readily abused by humans all produce an increase in dopamine concentrations, particularly in the NAc, which has led researchers to focus on this region and projections to and from the NAc.

Mesolimbic Dopamine System

Extensive studies using animal models of cocaine use indicate that the rewarding properties of psychostimulants, such as cocaine, are accompanied by increased neuronal activity in the mesolimbic dopamine system (Wise and Rompre 1989). The mesolimbic dopamine system is comprised of dopaminergic cell bodies in the ventral tegmental area (VTA) that project to the medial and orbital regions of the prefrontal cortex (PFC), nucleus accumbens (NAc), amygdala and the bed nucleus of the stria terminalis (BNST)(Wise 2004; Pierce and Kumaresan 2006). It has also been shown that some acute stressors, including exposure to footshock,

may also have effects on the mesolimbic dopamine system (Cabib and Puglisi-Allegra 1996).

Role of Dopamine in Motivated Behavior

Dopamine has long been demonstrated to be involved in movement and motor function (Campanella, Roy et al. 1987). While this role of dopamine in motor function is known, studies have shown that dopamine antagonists exert other functions on behavior at concentrations that do not alter movement or action. Blocking the actions of dopamine has been demonstrated to attenuate reward and motivational behavior. When treated with dopamine antagonists, rats exhibit a state of anhedonia including a reduced effort to receive either food or water, while overall motor function remained intact (Wise, Spindler et al. 1978; Gerber, Sing et al. 1981). Dopamine antagonists have also been shown to attenuate brain self-stimulation, a model of reward seeking, while not altering motor abilities (Fouriezos and Wise 1976; Fouriezos, Hansson et al. 1978). Additionally, treatment of rats with dopamine antagonists blocks the rewarding effects of drugs, such as cocaine (De Wit and Wise 1977). These results strongly implicate dopaminergic activity in reward-dependent learning and suggest that dopamine directly mediates the motivational processes underlying reinforcement. However, this does not mean that dopamine is the only reward transmitter in the brain. Dopamine antagonists and lesions to the dopamine systems do not completely eliminate rewarding effects of brain stimulation or drugs such as apomorphine (Simon, Stinus et al. 1979; Roberts and Vickers 1988). While dopamine may not be the only reward transmitter in the

brain, it does appear to play a critical role in the rewarding aspects of many hedonic stimuli, suggesting it may be an integral component of drug use.

Dopamine also appears to play a role in incentive motivation (Stewart, de Wit et al. 1984). Incentive motivation refers to the motivational aspects an otherwise neutral stimulus has acquired after prior association with a reward, causing the stimulus to drive behavior. If the dopamine system is not functioning properly, reward no longer places incentive-motivational value on otherwise predictable stimuli (Wise and Schwartz 1981; Spyraki, Fibiger et al. 1982; Stewart, de Wit et al. 1984; Spyraki, Nomikos et al. 1987). Once the relationship between stimulus and reward is established, incentive-motivational stimuli appear to be able to elicit behavioral responses even if the dopamine system is blocked, suggesting dopamine is required at the period involved in the formation of this relationship (Gerber, Sing et al. 1981; Wise and Colle 1984; McFarland and Ettenberg 1995; Dickinson, Smith et al. 2000). Over time, however, if tested under the condition of dopamine antagonism, the association will slowly diminish and become unlearned (Franklin and McCoy 1979; Dickinson, Smith et al. 2000). This suggests that dopamine is important both in reinforcement effects of a reward as well as the incentive motivation prior to earning a reward. The importance of dopamine in incentive motivation relies on the presence of dopamine at the time the reward is administered, thus causing reward related learning (Waelti, Dickinson et al. 2001).

As dopamine appears to be such a key neurotransmitter in motivated behavior, further studies were performed in order better understand its role.

Studies were performed in which recordings were taken from dopamine neurons in response to exposure to appetitive or aversive stimuli. These studies showed that appetitive, but not aversive stimuli resulted in a phasic activation of dopamine neurons, in most cases (Schultz 1986; Mirenowicz and Schultz 1996). Also of interest was the finding that after repeated pairings of visual or auditory cues with the presentation of a reward, activation of the dopaminergic neurons switched from just after onset of reward to the time the cue was received (Apicella, Scarnati et al. 1992; Ljungberg, Apicella et al. 1992). This suggests that the animal has learned to associate the cue with the reward and the cue is now responsible for the activation of dopamine neurons, not the reward itself. Furthermore, if the reward is not delivered following the cue, dopamine neurons decrease their firing rates below basal firing rates at the exact time the reward was expected. This suggests that dopaminergic activity is also involved in the timing of reward delivery (Hollerman, Tremblay et al. 1998).

Dopamine Response to Aversive Stimuli

Another layer of complexity involved in the actions of dopamine is whether or not it only signals aspects of reward or if dopamine can be a signal regardless of hedonic value. This is a topic of debate as there are data showing that aversive stimuli inhibit midbrain dopamine neurons (Ungless, Magill et al. 2004) while others have shown both the inhibition and activation of these neurons (Chiodo, Antelman et al. 1980; Mantz, Thierry et al. 1989). Recent evidence, however, suggests that these findings may be explained by the presence of two distinct groups

of VTA dopamine neurons (Brischoux, Chakraborty et al. 2009; Matsumoto and Hikosaka 2009). One group of dopamine neurons responds to stimuli that are rewarding or associated with reward, while the other group responds to any salient stimulus (Matsumoto and Hikosaka 2009). It has been suggested that the function of the dopamine neurons that respond to rewarding stimuli would be useful in learning to approach rewards while avoiding aversive situations, but the function of the neurons responsive to any salient stimuli remains unclear (Matsumoto and Hikosaka 2009). These data suggesting differential responding from different dopaminergic regions are in agreement with data demonstrating that the same pharmacological manipulations that will result in feeding when administered to the medial NAc shell, will stimulate defensive behaviors when administered more caudally (Reynolds and Berridge 2002; Reynolds and Berridge 2003). Together these data suggest a complex role of dopaminergic activity within the mesolimbic dopamine system. While dopamine does appear to play a central role in reward and reward related behaviors, it may be that dopamine is involved in many other processes as well, such as aversion, which will require further research to fully understand.

Differential role of Nucleus Accumbens core and shell

The NAc has long been considered to be a critical site for the locomotor and reinforcing actions of drugs of abuse (Wise and Bozarth 1987; Robbins and Everitt 1996), but there is some debate over the role of the two subdivisions, the nucleus accumbens core and shell (Di Chiara 2002; Ito, Robbins et al. 2004). The NAc shell

receives input from the basolateral amygdala and ventral subiculum and the core receives input from the basolateral amygdala and parahippocampal regions (Groenewegen, Wright et al. 1999; French and Totterdell 2003). It has been observed that drugs of abuse (Pontieri, Tanda et al. 1995; Cadoni and Di Chiara 1999), as well as other nondrug rewards, stimulate dopamine transmission predominantly in the shell of the NAc, opposed to the core (Bassareo and Di Chiara 1999). Based on these observations it has been postulated that dopamine in the NAc shell is involved in strengthening drug associations and matching the reward stimulus with the resulting biological outcome. In contrast to this it has been suggested that dopamine in the NAc core is involved the motivation to seek a reward and converting these motivations to action (Di Chiara 1999).

Intracerebral self-administration studies support the hypothesis that the NAc shell is the main site involved in the reinforcing actions of psychostimulants (McBride, Murphy et al. 1999). This is demonstrated by studies showing that amphetamine, as well as other drugs, are readily self-administered into the shell, but not other brain regions (Hoebel, Monaco et al. 1983). Additionally, some studies have been able to show self-administration of cocaine directly into the shell of the NAc (Carlezon, Devine et al. 1995; McKinzie, Rodd-Henricks et al. 1999). This effect is of some debate, however, as these findings are not always seen (Goeders and Smith 1993). The role of the shell in the reinforcing actions of drugs of abuse is further demonstrated by studies showing dopamine D₁ and D₂ receptor agonists will be self-administered into the shell, but not the core, when co-infused and will also cause reinstatement of cocaine seeking when administered to the shell (Ikemoto,

Glazier et al. 1997; Schmidt, Anderson et al. 2006). Additionally, cocaine and other psychostimulants have been shown to elevate dopamine levels in the NAc shell when measured through in vivo microdialysis (Pontieri, Tanda et al. 1995).

These studies demonstrate that the subdivisions of the NAc may play different roles in regulating drug self-administration as well as reinstatement. While the data presented here suggest that the shell is involved in the reinforcing effects of drug and the core to be involved in the motivational and action circuitry, this topic is still the subject of much debate. For the purpose of the studies presented here, this topic is largely left unexplored. Future studies may involve examining the role of the NAc subdivisions and how they may play different roles in the findings presented below.

Role of Dopamine in Drug Use

The importance of dopamine and the dopaminergic pathway as it relates to drugs of abuse was confirmed following evidence that selective lesions to the mesolimbic dopamine system prevent the reinforcing of effects of psychostimulants such as cocaine (McGregor and Roberts 1993). Interestingly, activation of this system does not appear to be necessary for the reinforcing effects of all drugs with abuse potential (Koob 1992), as studies have shown that robust morphine-induced reward, as measured by conditioned place preference, can still be seen in dopamine-deficient mice (Hnasko, Sotak et al. 2005), suggesting that this system is especially important in regards to psychostimulants.

Within the mesolimbic dopamine system, the nucleus accumbens and the prefrontal cortex have been specifically targeted in the work presented here, with the majority of the work being focused in the nucleus accumbens. There have been extensive studies using intracranial self-administration demonstrating the importance of these regions. In these studies, opioids, phencyclidine and psychostimulants are readily self-administered directly into the nucleus accumbens and cocaine and phencyclidine are directly administered into the prefrontal cortex of rats. Furthermore, activation of the nucleus accumbens neurons results in the creation of a conditioned place preference (McBride, Murphy et al. 1999). Additional drugs of abuse have been shown to involve this system of nuclei leading to the conclusion that most drugs of abuse activate the mesolimbic dopamine system making these featured structures the primary targets of the research done here.

The mesolimbic dopamine system also appears to play a key role in relapse of drug seeking, the most important area of drug addiction to study in order to discover an effective treatment. As will be discussed in greater detail to follow, dopaminergic activity within the mesolimbic dopamine system is involved in reinstatement in response to a stressor (Capriles, Rodaros et al. 2003; Thiel, Wenzel et al. 2010; Brown, Kupferschmidt et al. 2012) as well as cocaine-primed reinstatement (McFarland and Kalivas 2001; Anderson and Pierce 2005). Additionally, regions within this system appear to be influenced by stress as exposure to a stressor can alter extracellular dopamine concentrations within the NAc (Kalivas and Duffy 1995). These findings give strong support for the

mesolimbic dopamine system being heavily involved the results of the studies performed here. We believe activity within this system plays a key role in the reinstatement behaviors we have seen and will be further discussed in the sections to follow.

Self-Administration Model

Animal models are designed in order to reliably and predictably study behaviors seen in humans. The use of animal models to study aspects of drug addiction is possible due to the fact that the majority of drugs that have high abuse potential in humans can be predicted with the use of such models. There are multiple accepted models that are widely used to study the abuse-related effects of cocaine, including conditioned place preference and intracranial self-stimulation (Kornetsky and Esposito 1981; Hoffman 1989). In the work presented here the intravenous rat self-administration model was used, one of the more widely used models seen in addiction related research due to its ability to predict abuse potential (Collins, Weeks et al. 1984).

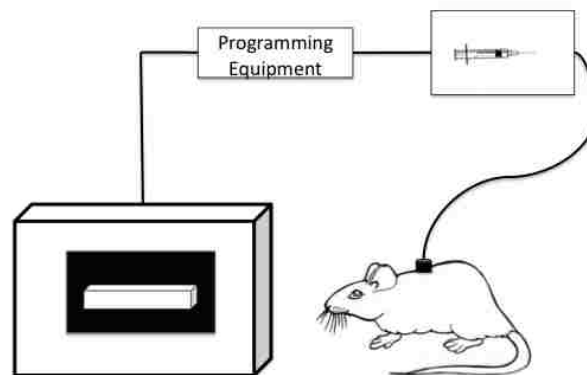

Figure 1. Drawing of self-administration setup for the rat. Responses on the lever activate the programming equipment that triggers an injection into the surgically implanted catheter in the rat.

IV Self-Administration

At first, animals and humans will both self-administer drugs for their rewarding properties, even if not entirely dependent upon the drug. The positive or reinforcing effects of drugs are an important part of beginning the addiction cycle. It is partly this reinforcing property of the drug being used that causes an individual to continue using despite negative consequences. In order to study this binge or intoxication stage we utilize the rat self-administration paradigm. In the rat self-administration model, a rat is implanted with an intravenous catheter and is trained to respond, in the form of a lever press, in order to receive an infusion of drug (cocaine). During the acquisition and maintenance phase of study the animals work to receive an infusion of drug. The requirement to receive an infusion is controlled by the experimenter and is most commonly set as a fixed ratio or a progressive ratio

schedule. There are other schedules that can be used, such as a second order schedule and a multiple schedule that use variations of the same principles (Goldberg, Kelleher et al. 1975; Caine and Koob 1994). In the fixed ratio schedule, as used in these studies, the number of responses required for a cocaine infusion remains the same throughout the session, in contrast to progressive ration in which the number of responses required for an infusion continually increases. Under fixed ration conditions, rats quickly establish a pattern of consistent behavior over a set duration of time and increasing the number of responses required for an infusion or examining patterns of responding relative to conditions where the drug is not available demonstrates that the animal is actively seeking the drug (Caine and Koob 1993). This model also uses an inactive lever to demonstrate selective behavior towards the drug-paired lever.

Intake Conditions

As is the case in human addicts, the pattern of intake using the rat self-administration model can vary with the history of prior drug intake (e.g. access conditions, dosage, number of prior testing sessions). In our hands, rats are allowed to self-administer cocaine under either limited, short-access (ShA; 2 hours/day) conditions or extended, long-access (LgA; 6 hours/day) conditions. Rats exposed to these different conditions exhibit characteristics unique to the level of drug intake when examined later (Ahmed and Koob 1999; Ahmed, Walker et al. 2000). Rats undergoing self-administration under LgA conditions show more traditional “addicted”-like behavior. These animals show an escalation of drug intake over the

course of the study, similar to a loss of control over the drug as one may see in a human addict, while ShA animals demonstrate relative consistency in intake throughout their sessions (Paterson and Markou 2003; Ferrario, Gorny et al. 2005). Furthermore, animals with a history of LgA SA display enhanced reinstatement when compared to ShA animals (Mantsch, Yuferov et al. 2004; Ferrario, Gorny et al. 2005). Thus the LgA model can be used to study the extreme effects of cocaine addiction and the underlying neuroplasticity.

While long-access SA approaches can be used to model addiction in its most extreme form, it is important to note that, as is the case in many cocaine users, self-administration in LgA rats is both compulsive and susceptible to reinstatement. Thus, although testing under long-access conditions is beneficial for studying addiction-related neuroplasticity and related mechanisms, it represents an extreme condition that may not be optimal for studying some processes that contribute to use in many individuals who abuse and/or are addicted to cocaine. For this reason the use of the ShA model is a better representation of the recreational cocaine user, which may be a better group to target for treatment.

Extinction and Reinstatement

The main focus of drug abuse research is to treat and prevent relapse of drug seeking. Relapse of cocaine use following periods of abstinence remains the biggest hurdle in the treatment of cocaine abuse (Gawin 1991). In order to begin to understand the mechanisms behind relapse, we must be able to use a reliable model and for this we use the extinction/reinstatement paradigm. To study relapse we

must first put the animals through an extinction phase in which they are no longer allowed access to the drug. During this phase the rats receive an inert substance, such as saline, instead of the drug when they respond on the lever previously associated with the drug. This eventually results in the cessation of lever pressing behavior.

Once the animals have gone through a period of extinction and the lever response rate has decreased to a stable, low level, they can be tested for reinstatement. Reinstatement occurs when the lever-pressing behavior returns following extinction, even in the absence of a cocaine reward and is meant to mimic the chronic, relapsing characteristics of addiction. It has been well studied that administration of an acute dose of cocaine as well as exposure to cues previously associated with drug delivery result in reinstatement of drug seeking (Gerber and Stretch 1975; de Wit and Stewart 1981; Slikker, Brocco et al. 1984; Meil and See 1997). Stress has also been shown to reliably produce reinstatement following extinction and this will be discussed in more detail to follow (Erb, Shaham et al. 1996; Ahmed and Koob 1997).

It is important to note the potential use of different circuitry and mechanisms involved in self-administration and reinstatement. Self-administration involves presence of a reward in the form of a drug infusion. This is linked to activation of the limbic circuitry, including the mesolimbic dopamine system (Robbins and Everitt 1996). Reinstatement testing, however, involves the presence of drug seeking behavior despite the absence of any reward. The circuitry involved in this

process in response to various treatments is beginning to be mapped out and appears to include the ventral tegmental area, dorsal prefrontal cortex, nucleus accumbens core and ventral pallidum (McFarland and Kalivas 2001), however, the mechanisms behind this behavior are not completely understood.

While there is no animal model that is able to perfectly mirror behavior seen in human addicts, the rat self-administration model is a very useful and productive tool in studying the behavior of an animal with drug exposure. The primary area for concern when using this model is that unlike humans, the rats used in these studies are given very little choice in their behavior as they are put in contact with the drug on a daily basis. As mentioned before, a hallmark of addiction is the use of drug despite negative consequences or choosing the drug over other pleasurable behaviors. The animals in this study do not experience the same social consequences a human would face and are therefore not choosing to use the drug despite the consequences. Additionally, the extinction and reinstatement model contains problems that are difficult to address. Unlike in humans, during the extinction phase the animals used in this model have no access to the drug and are, therefore, on forced abstinence. This obviously differs from human experiences where the drug may always be present, but the choice is made to stop using. While there are potential problems with this model, as in any animal model, it remains a well-studied and accepted model that has been shown to be a valid paradigm in the study of addiction.

Stress and Drug Use

Multiple studies have demonstrated that individuals with anxiety or stress related diseases, or going through stressful life events, are far more likely to relapse back into drug use suggesting a possible connection between stress and relapse (Kosten, Rounsaville et al. 1986; Brown, Vik et al. 1995; Shaham, Erb et al. 2000). While this has been an extensively studied subject, the exact mechanisms behind this link remain unknown. Extensive studies have been performed to better understand the involvement of stress throughout all phases of addiction and drug use.

Impact of Stress on Self-Administration

Stress is involved in every aspect of drug use and addiction. During the acquisition phase an animal experiences the rewarding effects of the drug for the first time and learns what is necessary to do in order to receive the drug (Goeders and Clampitt 2002). During the acquisition phase, exposure to a stressor, such as repeated tail pinch, electric footshock, social stress or food restriction enhances acquisition to the drug (Piazza, Deminiere et al. 1990; Goeders and Guerin 1994).

The ability of stress to influence acquisition is dependent upon release of corticosterone. Daily pretreatment with corticosterone results in similar increases in drug-intake as seen following exposure to a stressor, such as electric footshock (Mantsch, Saphier et al. 1998; Goeders 2003). Additionally, adrenalectomy prior to acquisition prevents cocaine self-administration while not affecting the ability to learn to press a lever for food pellets (Goeders and Guerin 1996).

The exact mechanism through which stress and corticosterone is regulating acquisition of cocaine seeking is not yet fully understood, but research is being done into this area. One possible mechanism being explored involves stress-induced activation of the dynorphin system. Dynorphin opioids are released in response to stress and activate the κ -opioid receptor (Chavkin, James et al. 1982; McLaughlin, Marton-Popovici et al. 2003; Land, Bruchas et al. 2008). Recent work has demonstrated that activation of the κ -opioid receptor prior to cocaine-associated cues can enhance the behaviors associated with the cues, suggesting that activation of this system may enhance the learning effects of cocaine and, therefore, may be involved in the regulation of acquisition of self-administration (Schindler, Li et al. 2010). Further work, however, needs to be done on the κ -opioid system as well as other potential mechanisms in order to better understand the role of stress in the acquisition of cocaine seeking.

During the maintenance phase of self-administration, when the animals have learned the drug is rewarding, we can learn what effect outside influences have on daily drug intake. It has been shown that during this period, daily exposure to electric footshock results in the escalation of drug intake over a two-week period (Mantsch and Katz 2007). This suggests that stress leads to increased drug intake, which may impact plasticity in the brain as will be discussed later. This is in agreement with studies in humans that suggest that individuals with a history of substance abuse who are going through periods of stress or experience higher levels of anxiety are more likely to crave drugs or alcohol (Sinha, Fuse et al. 2000; Sinha, Fox et al. 2011).

Impact of Stress on Reinstatement

Human studies suggest that stress is a key factor in relapse of drug seeking (Brown, Vik et al. 1990; Sinha, Catapano et al. 1999; Sinha, Fuse et al. 2000). These studies have shown that stressful life experiences lead to drug or alcohol use later in life, with a greater risk for those experiencing more significant stress. The human studies also show that exposure to stressful cues can lead to enhanced craving for drugs the individual had previously used. While the human data suggest a link between stress and relapse, the use of the animal model is needed in order to better understand the mechanism. Multiple stressors have shown the ability to reinstate drug seeking in non-humans. These stressors include electric footshock (Shaham and Stewart 1995; Erb, Shaham et al. 1996; Ahmed and Koob 1997; Mantsch and Goeders 1999), food deprivation (Carroll 1985) and cold swim stress (Conrad, McCutcheon et al. 2010). The prevention of relapse remains the primary goal in this line of research and since stress plays such a significant role in relapse, understanding the neurobiological mechanisms underlying stress-induced reinstatement is important in the pursuit of new therapies.

In addition to the use of physical stressors, pharmacological studies have been performed in efforts to explore the role of stress in reinstatement. Administration of the alpha-2 adrenoceptor antagonist yohimbine, a known anxiogenic drug, can induce reinstatement rats (Shepard, Bossert et al. 2004). Additionally, intercerebroventricular injections of corticotropin releasing factor

(CRF), at doses known to initiate the stress response, result in substantial reinstatement (Shaham, Funk et al. 1997; Erb, Petrovic et al. 2006; Mantsch, Baker et al. 2008). Evidence also suggests that administration of CRF antagonists are capable of blocking footshock-induced reinstatement (Erb, Shaham et al. 1998; Shaham, Erb et al. 1998).

Both the administration of pharmacological stressors (anxiogenic drugs) as well as exposure to physical stressors activate the hypothalamic pituitary adrenal (HPA) axis. These data suggest that it is not the stressor itself that is influencing reinstatement, but rather the body's response to the stressor. It is the activation of this system as well as the downstream effects of this activation that led us to explore its role in stress-induced reinstatement.

Circuitry of stress-induced reinstatement

The circuitry involved in stress-induced reinstatement appears to be somewhat distinct from that involved in cue- or cocaine-induced reinstatement. It has been demonstrated that inactivation of either the prefrontal cortex (PFC) or the NAc can prevent reinstatement in response to a stressor (Capriles, Rodaros et al. 2003). Separately, there appears to be involvement of the adrenergic system from neurons in the lateral tegmental nucleus to the bed nucleus of the stria terminalis (BNST) and central nucleus of the amygdala. It has been shown that α_2 -adrenoceptor agonists can attenuate footshock-induced reinstatement of drug seeking when administered systemically, implicating the norepinephrine (NE) pathways (Shaham, Erb et al. 2000). NE projections arise from the locus coeruleus

and the lateral tegmental nuclei, projecting to several forebrain regions and are responsible for NE innervation of the hippocampus, frontal cortex, hypothalamus, central nucleus of the amygdala, the septum, NAc and BNST (Moore and Bloom 1979; Foote, Bloom et al. 1983; Delfs, Zhu et al. 1998; Aston-Jones, Delfs et al. 1999). Additionally, the locus coeruleus is activated by exposure to stressors and plays a role in the stress response (Stanford 1995; Bremner, Krystal et al. 1996).

Initial studies have demonstrated that activation of locus coeruleus α_2 adrenergic receptors does not alter footshock-induced reinstatement, but lesions disrupting lateral tegmental NE innervation to the hypothalamus and BNST were able to decrease such reinstatement (Shaham, Highfield et al. 2000). These data suggest NE from the lateral tegmentum may be involved in stress-induced reinstatement.

The BNST and central nucleus of the amygdala receive NE innervation and are involved in the actions of CRF and the stress response (Davis, Walker et al. 1997; Delfs, Zhu et al. 2000). Both regions also contain CRF receptors (Potter, Sutton et al. 1994). Injections of CRF antagonists into the BNST prevent footshock-induced reinstatement, while administration of CRF itself into this region will induce reinstatement. No effect was seen in the amygdala using either treatment (Erb and Stewart 1999). This suggests that activation of CRF receptors in the BNST may be a critical step in footshock-induced cocaine seeking.

The role of CRF in stress-induced cocaine seeking was demonstrated by numerous studies (Erb, Shaham et al. 1998; Erb, Petrovic et al. 2006; Mantsch,

Baker et al. 2008; Shalev, Erb et al. 2010; Graf, Hoks et al. 2011). The ventral tegmental area (VTA) receives CRF projections from a number of brain regions, including the amygdala and BNST, and has been shown to have elevated levels of CRF following exposure to footshock (Wang, Shaham et al. 2005; Rodaros, Caruana et al. 2007). The exact receptor type responsible for the CRF dependent effect on stress-induced reinstatement remains controversial. Work in our lab has shown it is mediated by activation of VTA CRF-R1, not CRF-R2 as suggested by other studies (Wang, Shaham et al. 2005; Wang, You et al. 2007). As dopaminergic neurons from the VTA project to the PFC and NAc, CRF activation of VTA CRF-R1 receptors may stimulate dopamine release to the NAc and be a key mediator of stress-induced reinstatement (McFarland, Davidge et al. 2004; Wang, Shaham et al. 2005). Additionally, as discussed later, intracerebroventricular CRF-induced reinstatement is augmented by high cocaine intake conditions, suggesting that this system may undergo some level of neuroplasticity following exposure to cocaine (Mantsch, Baker et al. 2008).

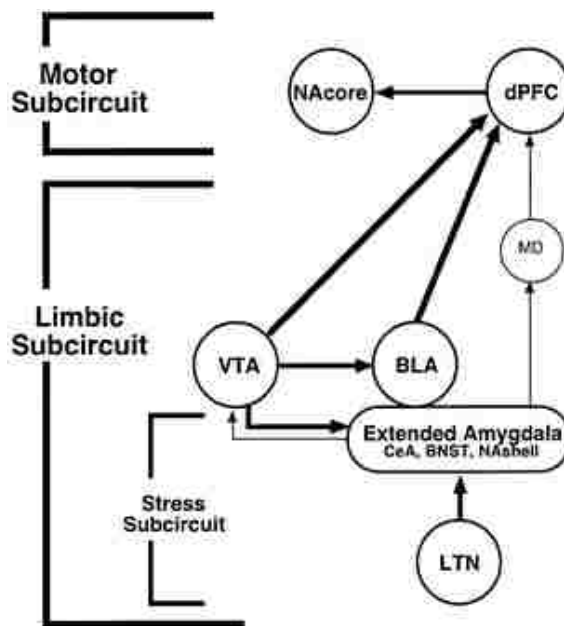

Figure 2. Circuitry involved in reinstatement to a primer (e.g. stress, cue, drug). It is proposed that the projection from the dorsal prefrontal cortex (dPFC) to the nucleus accumbens core (NAc core) is the final pathway in all primed reinstatement. VTA= ventral tegmental area, BLA= basolateral amygdala, CeA= central nucleus of the amygdala, BNST= bed nucleus of the stria terminalis, LTN= hypothalamic lateral tuberal nucleus. (Kalivas and McFarland 2003)

Effect of Level of Drug Intake on Stress-Induced Reinstatement

As is the case with relapse in human addicts, there is much variation in the ability of stress to directly trigger reinstatement of cocaine seeking in rats. A number of factors (genetics, environment, pharmacological history) likely play a role in determining if and how stress can contribute to drug use. Several labs have found that while there is a clear link between stress and relapse or reinstatement, it appears that the amount of prior drug intake influences the magnitude and likelihood of this occurring. The same stressor is capable of resulting in robust reinstatement under certain conditions, but has little effect in others (Ahmed, Walker et al. 2000; Mantsch, Baker et al. 2008). The level of drug intake and its

effect on later reinstatement is one of the topics addressed in this work and may be due to some level of drug-induced neuroplasticity, suggesting that the greater the drug intake, the more changes that may occur in the brain.

We have demonstrated that high intake rats that have undergone exposure to cocaine under long access (LgA; 6 hrs of cocaine exposure/day) conditions consistently reinstate when exposed to 15 minutes of electric footshock prior to a reinstatement session, whereas animals exposed to short access (ShA; 2 hrs of cocaine exposure/day) conditions do not. The animals undergoing LgA exposure to cocaine take in approximately 4X the amount of drug animals under ShA conditions do over the course of the study (800 mg/kg vs. 200 mg/kg cocaine) (Blacktop, Seubert et al. 2011). In addition, LgA self-administration results in a higher level of reinstatement when pretreated with CRF and reinstates at lower doses of CRF than do animals with ShA exposure to cocaine (Mantsch, Baker et al. 2008). This differs from studies that do see footshock-induced reinstatement in ShA animals, but is consistent with previous data showing a similar effect in rats exposed to footshock following LgA or ShA heroin self-administration (Erb, Shaham et al. 1996; Ahmed, Walker et al. 2000). These discrepancies may be explained by differences in SA and reinstatement conditions as well as different rat strains and other altered methods (Kupferschmidt, Brown et al. 2011) including differences in the shock intensity (Shaham 1996) or alterations in the withdrawal or extinction phase (Shalev, Morales et al. 2001). Surprisingly, the rats exposed to LgA SA of cocaine also showed behavior consistent with reduced anxiety when tested in open field, elevated plus maze and light/dark box when compared to ShA animals (Mantsch,

Baker et al. 2008). This may be explained by a change in circuitry in these high intake rats that leads to increased activity when confronted with stress as well as by the evidence that addicted individuals are more likely to engage in compulsive and high risk activities (Vanderschuren and Everitt 2004). Thus, understanding the neurobiological mechanisms that contribute to the differences in motivation between ShA and LgA rats may contribute to our understanding of the neuroplasticity underlying addiction. This question is further explored in chapter 4.

While these data demonstrate the variability in the ability of stress to act as a trigger of reinstatement, there is still a great deal to learn from the role of stress in reinstatement under ShA conditions. In low intake rats, stress may be acting more as a stage setter than a direct trigger of relapse. Studies using the anxiogenic drug yohimbine shows stress in addition to a drug-associated cue resulted in far greater reinstatement than either challenge presented alone (Feltenstein and See 2006). The same effect was seen using acute exposure to footshock prior to a cocaine-associated cue (Buffalari and See 2009). In both of these cases stress prior to exposure to a cue greatly elevated the level of reinstatement. This suggests that stress may make the individual more sensitive to relapse, even under ShA conditions.

Stress as a Stage Setter

While these data suggest a clear connection between stress and reinstatement of drug seeking, it is not clear that stress is always a direct trigger of relapse. Recent evidence suggests that stress may in fact act as a stage setter,

allowing for stimuli that may not result in relapse under non stress conditions to do so following periods of stress. It has been demonstrated that exposure to a stressor, in the form of electric footshock or administration of an anxiogenic drug such as yohimbine, can exacerbate cue- or context-induced reinstatement in various models (Liu and Weiss 2002; Liu and Weiss 2003; Buffalari and See 2009). Additionally, these effects of stress on reinstatement were seen in animals undergoing ShA SA, suggesting it is not dependent upon excessive drug intake as seen before. The work done here examines the ability of stress to potentiate the effect of drug-induced reinstatement in an effort to better understand the mechanism through which stress interacts with the relapse of drug seeking.

Monoamines and other modulators of Reinstatement

Extensive work has been done examining the circuitry involved in both the reward circuitry as well as the circuitry involved in reinstatement. While there is some amount of overlap between these two pathways, it is important to note that they are distinct circuits and involve various brain regions and neurotransmitters (Wise and Rompre 1989; McFarland and Kalivas 2001).

Dopamine

Monoamines, specifically dopamine, have been extensively studied in drug addiction because all known drugs of abuse acutely increase dopamine levels in the NAc, although through varying mechanisms. Because cocaine primarily acts through blockade of dopamine transporters (Povlock and Schenk 1997), it is important to study regions of the brain involved in the dopamine system. The

dopaminergic cell bodies originate in the VTA and substantia nigra and project to many brain regions known to be involved in reward and addiction, including the PFC, NAc, hippocampus and amygdala (Hyman, Malenka et al. 2006). In particular, it appears that activity in the VTA, dPFC, NAc and ventral pallidum are necessary for cocaine-induced reinstatement. This is seen by administration of GABA agonists into these regions, resulting in inactivation, that blocks cocaine-primed reinstatement, without blocking other goal directed actions (McFarland and Kalivas 2001). It was also demonstrated that inhibition of cocaine-primed reinstatement by GABA administration into the VTA could be reversed with dopamine directly into the dPFC. These data in addition to data showing dopamine alone into the dPFC results in reinstatement suggest a strong role for the dPFC in cocaine-induced reinstatement (McFarland and Kalivas 2001). Another region, the NAc is also heavily implicated in the reinforcing aspects of cocaine (Robbins and Everitt 1996; Wise 2008). This makes these two regions of particular interest and the focus of the work done here.

Studies have demonstrated that administration of dopamine or dopamine agonists, specifically targeting the dopamine D2 receptor, directly into the NAc is sufficient to reinstate drug seeking (Wise, Murray et al. 1990; Self, Barnhart et al. 1996; De Vries, Schoffelmeer et al. 1999; Cornish and Kalivas 2000). It has also been demonstrated that the level to which cocaine is able to increase dopamine levels during SA, influences the susceptibility to later reinstatement (Madayag, Kau et al. 2010). The exact mechanism behind these findings is still unclear, however. There is debate over the role of dopamine D1 and D2 receptors as well as the brain regions

involved. These questions are not addressed by this work, but rather are focused on manipulations of dopamine levels and its effect on reinstatement.

Also of note to the work performed here is the ability of stress to alter dopamine concentrations. Exposure to electric footshock has been shown to elevate dopamine levels in the NAc (Kalivas and Duffy 1995), and that corticosterone is necessary for this stress-induced elevation of dopamine as this effect can be blocked by either adrenalectomy or administration of a corticosterone synthesis inhibitor (Marinelli, Piazza et al. 1994; Rouge-Pont, Marinelli et al. 1995; Barrot, Marinelli et al. 2000). These data suggest that any mechanism capable of altering dopamine concentrations may play a key role in reinstatement behavior, especially as it relates to stress.

Norepinephrine

As mentioned earlier, the noradrenergic system plays a major role in drug use and relapse. As cocaine is a nonselective monoamine uptake inhibitor, it is important to examine the roles of these other transmitters (Glowinski and Axelrod 1965; Iversen 1973). Evidence suggests that drugs blocking the reuptake of norepinephrine are able to at least partially substitute for the actions of cocaine or enhance the actions of cocaine, suggesting a rewarding property of elevated norepinephrine (Cunningham and Callahan 1991; Baker, Riddle et al. 1993; Spealman 1995). Norepinephrine has also been implicated in reinstatement. As mentioned previously, administration of the α 2-adrenoceptor-antagonist yohimbine can result in reinstatement (Lee, Tiefenbacher et al. 2004; Shepard, Bossert et al.

2004). Also, systemic administration of $\alpha 2$ -agonists have been shown to block footshock-induced reinstatement of cocaine seeking (Erb, Hitchcott et al. 2000). This evidence suggests that the noradrenergic system may play a large role in drug use and stress-induced reinstatement and is a subject that will need to be addressed as this research continues.

Serotonin

Serotonin is synthesized in the raphe nuclei, whose projections innervate almost all regions of the brain, and is involved in the regulation of many vital functions of an organism (sleep, circadian rhythms, feeding, reproductive behaviors, etc...) (Barnes and Sharp 1999). Serotonergic neurons innervate structures involved in the actions of cocaine, such as the VTA, NAc and PFC and may play a role in influencing the effects of the drug (Halliday and Tork 1989). It has been demonstrated that cocaine elevates serotonin levels in the NAc through blockade of the serotonin transporter (SERT), similar to the effect cocaine has on dopamine (Ritz, Cone et al. 1990; Broderick, Hope et al. 2004). Elevations of serotonin have also been shown to be rewarding as pharmacological blockade of SERT, by a drug with no inherent rewarding properties, caused conditioned place preference in mice (Filip, Frankowska et al. 2005).

Substantial work has been done in order to better understand which of the many serotonin receptor subtypes are involved in cocaine use. Pharmacological blockade of 5-HT_{2A} receptors and activation of 5-HT_{2C} receptors block the locomotor effects of cocaine, while activation of 5-HT_{2A} and blockade of 5-HT_{2C} enhance it

(McCreary and Cunningham 1999; Fletcher, Grottick et al. 2002; Filip, Bubar et al. 2004). Additionally, 5-HT_{2A} antagonists have no effect on cocaine self-administration (Fletcher, Grottick et al. 2002), while 5-HT_{2C} antagonists increase and 5-HT_{2C} agonists decrease cocaine self-administration (Fletcher, Grottick et al. 2002; Fletcher, Chintoh et al. 2004). Finally, blockade of the 5-HT_{2A} receptor or stimulation of the 5-HT_{2C} attenuates cocaine and cue-induced reinstatement (Grottick, Corrigall et al. 2001; Fletcher, Grottick et al. 2002; Neisewander and Acosta 2007).

These data suggest a clear role of the serotonergic system in the reinstatement of cocaine-seeking behavior. While this system is not as well understood as others, such as the dopamine system, it still may play a key role in the reinstatement process and while not addressed in the work done here, may be important to examine in the future.

Kappa Opioid System

Another system involved in the stress response and reinstatement is the kappa opioid system. Stress, and activation of the HPA axis, results in activation of the endogenous κ opioid system (Przewlocki, Lason et al. 1987; Watanabe, Weiland et al. 1995). Increased activity of the κ opioid system has been demonstrated to be a key mediator of the ability of stress to alter the reinforcing properties of cocaine (McLaughlin, Marton-Popovici et al. 2003). Studies have shown that pretreatment with a kappa receptor antagonist prevents reinstatement of drug seeking following exposure to footshock or forced swim stress (Beardsley, Howard et al. 2005; Carey,

Borozny et al. 2007). Additionally, in a series of mouse studies, it has been shown that reinstatement of cocaine seeking following exposure to stress, but not a cocaine primer, is dependent upon kappa opioid receptor activation. Exposure to footshock or forced swim, as well as administration of a kappa agonist resulted in reinstatement under the mouse conditioned place preference model. This effect was completely blocked when done in the presence of a kappa antagonist or when performed in mice lacking kappa opioid receptors or the endogenous opioid, dynorphin (Redila and Chavkin 2008). This suggests that dynorphin and kappa receptor activation may play a role in stress-induced reinstatement.

Furthermore, there may be a connection between the kappa opioid system and CRF. Studies have shown that CRF and dynorphin are expressed in the same brain regions (Roth, Weber et al. 1983) and CRF can induce dynorphin release (Sirinathsinghji, Nikolarakis et al. 1989). Considering the significant role of CRF in stress-induced reinstatement, as discussed earlier, this connection may be an important aspect in this form of reinstatement and may need further examination in the future.

Stress Response and Homeostasis

The activation of the hypothalamic pituitary adrenal (HPA) axis is vital for an organism to be able to adapt and survive in the presence of real or perceived stress. Corticosteroid release exerts its adaptive and life-saving effects by mobilizing substrates needed for energy and shutting down systems involved in maintaining the immune system and inflammatory response. This prevents these responses

from being overactive and causing harm to the organism (Sapolsky, Romero et al. 2000). This may play a key role in addiction as well. As an individual consumes a drug, the body may need to adjust in order to account for the presence of the drug, resulting in a potential dysregulation of the HPA axis.

Exposure to a stressor, or any deviation from homeostasis past a certain point results in the activation of the HPA axis. This involves release of corticotropin releasing factor (CRF) from the parvocellular neurons in the paraventricular nucleus (PVN) of the hypothalamus (Figure 3). CRF release triggers activation of the HPA axis and results in a glucocorticoid response, which allows corticosteroids to reach every organ of the body and leads to a number of behavioral adaptations aimed at returning the organism to homeostasis (McEwen 1998; de Kloet, Joels et al. 2005). The release of glucocorticoids, including corticosterone in the case of rodents or cortisol in humans, allows for the organism to mount a response to the challenge presented, making this an important system in survival (McEwen and Stellar 1993).

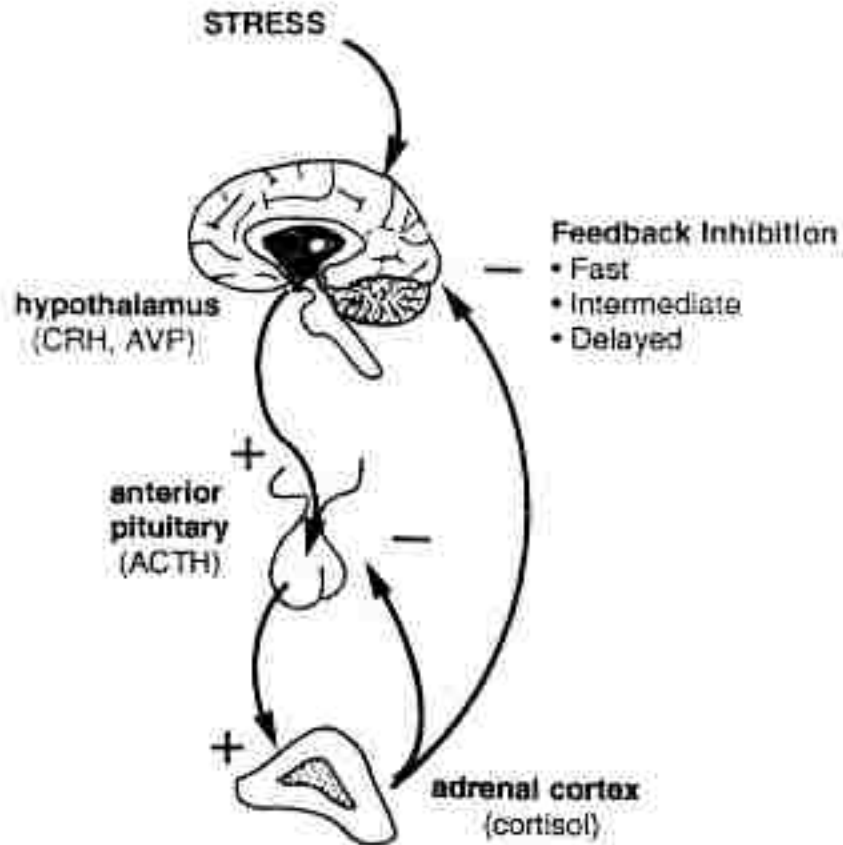

Figure 3. Schematic of the HPA axis. (Adapted from UCLA Center for Neurovisceral Sciences and Women’s Health)

The release of corticosteroids from the adrenal gland is regulated by adrenocorticotrophic hormone (ACTH) that originates from the anterior pituitary gland (Swanson, Sawchenko et al. 1987). The nature of the stress encountered has a major impact on the release of ACTH and processing of the stressor occurs in limbic structures such as the amygdala, hippocampus and frontal cortex, which modulate the PVN and surrounding areas (Herman, Cullinan et al. 2002). This pool of ACTH is then tightly regulated by CRF that originates from the hypothalamus. In addition, the corticosterone that is released from the adrenal gland exerts negative feedback

on the release of both ACTH and CRF at the pituitary and the PVN. Acutely, glucocorticoids inhibit the release of CRF relatively quickly, while chronically they downregulate expression of CRF expression in the PVN (Keller-Wood and Dallman 1984). All of these features allow for a well-balanced and tightly regulated stress response. This allows the organism to react differently to a wide variety of stressors (physical, psychological, real or imagined) in a different manner and return to homeostasis in a timely manner. In the studies presented here, we explored the role of these stress-related hormones in the mechanism involved in stress-induced reinstatement.

Corticosteroid Receptors

The mechanism involved in the response to corticosteroid release involves both rapid and slow responses. The system involved in the slow, genomic response typically consists of two different, but related receptors, the mineralocorticoid receptor (MR) and the glucocorticoid receptor (GR). Both receptors bind to the same hormone, cortisol in humans and corticosterone in the rat, but MR has a tenfold higher affinity (Reul and de Kloet 1985). MR affinity is much higher than that of GR, allowing it to remain activated at most times, even in between bursts of hormone secretion. GR, however, has a lower affinity for the hormone and appears to be primarily activated during times of stress and circadian rhythm induced elevations of corticosteroid concentrations (Kitchener, Di Blasi et al. 2004). This means stress-induced increases in glucocorticoid levels appear to have a greater impact on GR, making it the receptor of focus here.

GR are distributed throughout the brain in both neurons and glial cells. GR density is at its highest in the PVN and structures of the limbic system, making it readily accessible to the actions of the HPA axis (Miklos and Kovacs 2002; Herman, Figueiredo et al. 2003). Expression is also relatively high in areas such as the striatum (NAc) and BNST (Morimoto, Morita et al. 1996). The limbic structures also express a significant amount of MR and there are a number of regions, especially the hippocampus, that have a large amount of co-expression of MR and GR, which can be seen across many species (Patel, Lopez et al. 2000).

Upon interaction with corticosteroids, MR and GR are capable of forming heterodimers, homodimers and monomers, which allows the receptors to respond to a large variation in corticosteroid concentration (Trapp, Rupprecht et al. 1994). These activated corticosteroid receptors have the ability to regulate gene transcription and are capable of regulating the expression of a large number of genes, up to 100 in the hippocampus alone, with many being responsive to activation of either receptor (Datson, van der Perk et al. 2001). This is done when the activated receptors translocate into the nucleus of the cell and bind to DNA or interfere with the activity of various transcription factors (Deroche-Gamonet, Sillaber et al. 2003). Activation of these receptors and the subsequent regulation of gene transcription and translation is part of a system involved in managing many molecular and cellular changes that may play a role in a wide variety of behaviors, such as memory formation and motivated behaviors.

Nongenomic Mechanisms

Since activation of GR requires translocation to the nucleus and regulation of gene transcription, the process can take over an hour to develop and the effects can last days (Joels and Baram 2009). Corticosterone increases in the brain are also not immediate and when considered along with the time necessary for gene transcription and translation, GR-dependent genomic mechanisms may play little role in acute behavioral responses. This suggests the possibility of a stage setting effect for glucocorticoids opposed to a direct triggering mechanism. In addition, there is growing evidence of rapid glucocorticoid actions through nongenomic mechanisms, with actions occurring with seconds or minutes (Tasker, Di et al. 2006; Haller, Mikics et al. 2008). These effects include rapid increases in locomotor activity dependent upon nitric oxide release (Sandi, Venero et al. 1996) and suppression of male reproductive behavior through regulation glucocorticoid receptor activity (Rose, Moore et al. 1993; Rose and Moore 2002). Additionally, acute elevations in glucocorticoid levels can have advantageous effects on memory formation (Roozendaal 2003), while long term elevations can be harmful (de Quervain, Roozendaal et al. 1998).

In addition to the rapid inhibition of the HPA axis as mentioned earlier, glucocorticoids also appear to exert rapid effects through membrane-associated receptors distinct from the traditional mechanism of action (for review see, (Tasker, Di et al. 2006). The identity of these receptors is not yet fully understood, but it appears that glucocorticoids may be functioning through G protein-coupled

receptors (Orchinik, Murray et al. 1991). The behavioral effects seen in the data presented below occur relatively soon after glucocorticoid elevation suggesting a non-GR mediated mechanism. It is our goal to provide a potential mechanism through which these rapid effects are occurring in our model.

Glucocorticoid Hormones and Cocaine Abuse

Substantial research has been done examining a connection between glucocorticoid hormones and the vulnerability of an individual to cocaine addiction (Goeders 2002). Stress-induced activation of the HPA axis and the subsequent release of glucocorticoids result in actions throughout the brain, including neurons containing dopamine (Piazza and Le Moal 1996). Glucocorticoids play a key role in the acquisition, maintenance and reinstatement of cocaine self-administration, suggesting they are very important in all aspects of cocaine abuse (Goeders and Guerin 1996; Deroche, Marinelli et al. 1997; Mantsch and Goeders 1999). In addition, it has been demonstrated that giving rats repeated injections of corticosterone will allow them to acquire and self-administer cocaine at lower doses than animals not receiving corticosterone. Additionally, adrenalectomized rats self-administer cocaine at a lower rate when compared to animals with a functioning adrenal response (Piazza, Rouge-Pont et al. 1996; Mantsch, Saphier et al. 1998). In attempt to understand the mechanism behind this interaction, it has been hypothesized that the glucocorticoid response that occurs following drug exposure contributes to the neuroplasticity seen in rats with a history of drug intake (Kreek and Koob 1998).

Drug Induced Plasticity

Evidence suggests LgA exposure to cocaine results in some level of neuroplasticity not seen in ShA rats. There appears that cocaine SA produces intake dependent, long-term neuroadaptations that lead to an increased sensitivity to stress-induced reinstatement (Mantsch, Baker et al. 2008). It has been suggested that drug-induced alterations in the stress response may be responsible for the neuroplasticity seen in LgA animals (Kreek and Koob 1998; Koob and Kreek 2007). Like stressors, cocaine, whether administered non-contingently or self-administered, activates the HPA axis resulting in elevated plasma corticosterone levels. ShA and LgA conditions result in the same peak corticosterone level, but rats undergoing LgA drug intake show a sustained elevation of corticosterone for a significantly longer period of time over a 24-hour span (Mantsch, Baker et al. 2008). This sustained elevation and increase in overall corticosterone levels may create an environment that promotes addiction-related plasticity.

Interestingly, when this alteration in elevated glucocorticoids is prevented through adrenalectomy, the differences in behavior seen between ShA and LgA cocaine exposure is diminished. Rats adrenalectomized prior to LgA cocaine SA do not show reinstatement following exposure to footshock or i.c.v. administration of CRF (Graf, Hoks et al. 2011). In fact, animals without the glucocorticoid response behave similarly to ShA animals. This effect of adrenalectomy on later footshock-induced reinstatement was only seen when the surgery was performed prior to the beginning of the SA phase. When performed following SA, but prior to

reinstatement testing, the rats behaved responded to footshock similarly to intact animals. The reinstatement of cocaine-seeking behavior despite the lack of an active corticosterone response to stress is consistent with previous reports using both cocaine and heroin (Shaham, Funk et al. 1997; Erb, Shaham et al. 1998). This suggests that stress-induced relapse does not require acute stress-induced increases in corticosterone levels. It is important to note that while elevations in corticosterone are not necessary for reinstatement under these conditions, it is necessary in order to create the stage setting effect as will be seen in chapter 1. This further demonstrates the difference between stress acting as a stage setter or functioning as a trigger or mechanism responsible for neuroplasticity. The data also suggest that adrenal responses during the SA phase are necessary for the induction of plasticity that is seen under LgA conditions that contributes to later relapse. Failure to have normal cocaine-induced adrenal responses results in the lack of later footshock induced reinstatement normally seen in intact LgA animals. We hypothesize that this plasticity is a result of a chronic cocaine SA-induced elevation of glucocorticoid levels. This, however, requires more examination to fully understand the mechanism behind the adrenal response and its effect on neuroplasticity.

GR Involvement in Reinstatement

Multiple studies have shown a significant role of GR in cocaine self-administration and reinstatement. A mouse model in which GR has been knocked out specifically in the CNS demonstrates a severely blunted motivation to self-

administer cocaine as evidenced by a downward shift in a cocaine dose response curve (Deroche-Gamonet, Sillaber et al. 2003). These data may need additional analysis as the mice lacked GR throughout development and may have additional behavioral deficits.

Experiments using the GR competitive antagonist, mifepristone (or RU-38486), were also done to analyze the effect of GR in a progressive ratio model. In this model, the number of responses needed to receive one infusion of cocaine continually increases throughout the session and the amount of work they are willing to exert to receive an infusion, or “breaking point”, is recorded. It was found that acute mifepristone dose-dependently lowered the “breaking point” in rats with the highest motivation to self-administer (Deroche-Gamonet, Sillaber et al. 2003). This, together with data demonstrating a similar result in animals with decreased endogenous glucocorticoid levels, suggest that glucocorticoid activation of GR can increase the rewarding properties of cocaine (Deroche, Marinelli et al. 1997). Examination of these studies suggests a role for GR throughout addiction and reinstatement and altered gene regulation may have an impact on drug seeking. It is again worth noting that these studies involved chronic blockade of GR, creating a similar problem as seen in the GR knockout model. There is no current evidence for the ability of acute GR blockade to interfere with acute stress-, cocaine-, or cue-induced reinstatement. It appears as though such an effect would be unlikely considering the time course necessary for HPA activity and a genomic response to GR activation as it relates to behavior.

Non-GR Mechanisms

While many glucocorticoid interactions with GR demonstrate a slow, genomic mechanism, there are rapid, nongenomic, and in some cases GR-independent effects known to occur (Makara and Haller 2001). One of the first studies giving strong evidence for a nongenomic action of glucocorticoids used electrophysiological recordings of the PVN. In this study it was shown that glucocorticoids were able to very quickly inhibit glutamate release onto parvocellular neurons (Keller-Wood and Dallman 1984; Di, Malcher-Lopes et al. 2003). These effects occur in a time course suggesting that they are not associated with gene transcription, but the exact mechanisms are not yet fully understood. Potential nongenomic pathways include activation of the nitric oxide system, the release of endocannabinoids, and other non-traditional receptors. The work presented here aims to examine a potential GR-independent mechanism involved in modulating cocaine use.

One non-genomic mechanism of glucocorticoid action involves the endocannabinoid system. Endocannabinoids are retrograde messengers that are capable of modulating many behaviors (Wilson and Nicoll 2002). There are currently two identified cannabinoid receptors, CB₁ and CB₂, with CB₁ being expressed throughout the central nervous system and CB₂ primarily expressed in the periphery. When endocannabinoids are released from a postsynaptic cell following depolarization, the presynaptic CB₁ receptors are activated. This results

in the inhibition of neurotransmitter release, both excitatory and inhibitory (Maldonado, Valverde et al. 2006). Additionally, these receptors are abundantly expressed throughout the mesolimbic dopamine system, including the NAc and VTA, where they can influence glutamatergic and GABAergic signaling (Robbe, Kopf et al. 2002; Melis, Pistis et al. 2004).

These data suggest that the endocannabinoid system may play a key role in reward circuitry and addiction through regulation of neurotransmitter release. Interestingly, this system also appears to be heavily influenced by stress and glucocorticoids. Activation of glucocorticoid receptors, through a G protein-signaling cascade, has been shown to induce the synthesis of endocannabinoids, leading to presynaptic activation of the CB₁ receptor (Di, Malcher-Lopes et al. 2003). This rapid, stress-induced activation of the endocannabinoid system and the effects it has on reward circuitry may represent a potential mechanism behind stress-induced relapse, including some of the effects seen in the work presented here. This idea, however, is still poorly understood and requires further research by our lab and others before more definitive conclusions can be made.

Glucocorticoids and Dopamine

Previous work suggests that glucocorticoids may directly regulate dopamine levels by either pre- or post-synaptic mechanisms. A large population of dopamine neurons in the VTA also express corticosteroid receptors (Harfstrand, Fuxe et al. 1986). GR is expressed on most cell types throughout the reward circuitry, including the NAc and PFC (Barik, Parnaudeau et al. 2010). Glucocorticoids also

appear to play a role in dopamine-mediated behaviors as evidenced by a series of behavioral studies in adrenalectomized animals (Marinelli, Piazza et al. 1994). These dopamine-mediated behaviors have also shown to increase during periods of elevated corticosterone and coincide with elevations in extracellular levels of dopamine in the NAc (Piazza, Rouge-Pont et al. 1996). These studies suggest that glucocorticoids modulate NAc dopamine concentrations and may explain human findings showing glucocorticoid-induced psychosis (Hall, Popkin et al. 1979; Ling, Perry et al. 1981). The exact mechanism responsible for the impact of glucocorticoids on dopamine transmission is currently unknown and the work presented here may give a possible explanation.

Organic Cation Transporter 3

One potential mechanism by which glucocorticoids may alter dopamine clearance, and therefore influence behavior, is through inhibition of OCT3-mediated dopamine clearance. Organic cation transporter3 (OCT3) is a high capacity transporter involved in the bidirectional transport of dopamine and other monoamines including norepinephrine, epinephrine, histamine and serotonin (Grundemann, Schechinger et al. 1998; Grundemann, Liebich et al. 1999). OCT3 is expressed throughout the body, including the brain, and is highly sensitive to inhibition by glucocorticoids, such as corticosterone, making it an interesting mechanism of monoamine clearance to study (Simmonds and Gillis 1968; Grundemann, Koster et al. 1998; Gasser, Orchinik et al. 2009).

OCT3 is part of a group of transporters responsible for uptake₂ activity. Uptake₂ is a higher capacity, but lower affinity transport system when compared to uptake₁ transport, which is comprised of the specific transporters for norepinephrine (NET), dopamine (DAT) and serotonin (SERT) (Simmonds and Gillis 1968; Iversen and Salt 1970). For example, rat DAT binding affinity (K_m) for dopamine is in the range of 800 nM (Giros, el Mestikawy et al. 1991; Kilty, Lorang et al. 1991), compared to OCT3 affinity for dopamine at $\sim 1000 \mu\text{M}$ (Duan and Wang 2010). This significant difference in substrate affinity assures that OCT3 will act as a backup clearance mechanism, acting as a sink for monoamine spillover.

The significance of uptake₂-mediated clearance can be seen in studies in which these transporters are inhibited by bath application of corticosteroids in cardiac and smooth muscle tissue. In these studies corticosteroids acutely enhance the contractile effects of bath applied epinephrine, norepinephrine, serotonin or histamine (Kalsner 1975; Purdy, Weber et al. 1982; Purdy and Weber 1983; Horvath, Sutto et al. 2003). These data suggest that inhibition of uptake₂, during periods where primary transporters are saturated, can result in a significant alteration in activity. Uptake₂ is also unique in comparison to uptake₁ in that its activity is acutely inhibited by the stress hormone corticosterone, as well as other steroids (Simmonds and Gillis 1968; Iversen and Salt 1970; Grundemann, Schechinger et al. 1998). Uptake₂ can also be potently inhibited by normetanephrine. Normetanephrine is the O-methylated metabolite of norepinephrine and it has been found that its most prominent role is to inhibit the actions of uptake₂ (Goldstein, Eisenhofer et al. 2003; Rahman, Ring et al. 2008).

Furthermore, recent studies have indicated the presence of uptake₂ transporters in the brain, making this mechanism of great interest to our research regarding the role of stress and its ability to regulate dopamine concentrations (Engel, Zhou et al. 2004; Amphoux, Vialou et al. 2006; Gasser, Lowry et al. 2006; Gasser, Orchinik et al. 2009).

Uptake₂-mediated transport is thought to involve a number of transporters in addition to OCT₃. These include OCT₁, OCT₂ as well as the plasma membrane monoamine transporter (PMAT), which are expressed throughout the body, including the brain (Grundemann, Schechinger et al. 1998; Engel, Zhou et al. 2004; Gasser, Orchinik et al. 2009). The OCTs are part of the solute carrier 22 family and transport small, hydrophilic organic cations through a sodium-independent mechanism (Koepsell, Schmitt et al. 2003; Koepsell and Endou 2004). The OCTs share similar amino acid sequences as well as structures, including 12-transmembrane domains (Koepsell, Schmitt et al. 2003; Wright and Dantzler 2004). All of the OCTs are about 555 amino acids in length and are located in the plasma membrane (Schomig, Lazar et al. 2006). Additionally, all substrates for the OCTs must have a single positive charge and transport is not dependent upon a Na⁺ and Cl⁻ gradient (Schomig, Lazar et al. 2006). In humans, OCT₁ and OCT₂ are mainly found in the liver and kidney where they are involved in the process of organic cation elimination (Simmonds and Gillis 1968), whereas OCT₃ is found in the liver, heart, placenta, skeletal muscle, kidney and brain (Gorboulev, Ulzheimer et al. 1997; Zhang, Dresser et al. 1997; Grundemann, Schechinger et al. 1998). The membrane transporter PMAT is most abundantly expressed in the brain in humans, but can

also be found in the liver, kidney and heart (Engel, Zhou et al. 2004). While not genetically related to the OCTs, PMAT shares many functional similarities and hence they are grouped together in uptake2 activity.

Corticosterone-induced inhibition of uptake2 activity varies among the multiple transporters. The half-maximal inhibitory concentration (IC_{50}) values for corticosterone are $\sim 150 \mu\text{M}$ (rat OCT1), $\sim 4 \mu\text{M}$ (rat OCT2), $\sim 0.04 \mu\text{M}$ (rat OCT3) and $\sim 450 \mu\text{M}$ (PMAT) (Wu, Kekuda et al. 1998; Engel and Wang 2005; Schomig, Lazar et al. 2006). As OCT3 has the greatest sensitivity to inhibition by corticosterone, it may play the most important role in uptake2 mediated monoamine transport, especially during periods of stress. This also suggests that PMAT may not be inhibited by physiologically relevant levels of corticosterone and will, therefore, not be affected by stress-induced fluctuations (Engel and Wang 2005).

Additionally, all the transporters are capable of transporting norepinephrine, epinephrine, serotonin, dopamine, histamine and the neurotoxin 1-methyl-4-phenylpyridium (MPP^+) with varying efficiency and can also be inhibited by the compound decynium-22, while being unaffected by the GR antagonist RU38486 (Grundemann, Schechinger et al. 1998; Grundemann, Liebich et al. 1999; Hayer-Zillgen, Bruss et al. 2002; Horvath, Sutto et al. 2003; Engel, Zhou et al. 2004). In particular, PMAT has a higher affinity for serotonin and dopamine than norepinephrine and epinephrine (Engel, Zhou et al. 2004), in comparison to OCT3, which shows an opposite pattern of affinity (Grundemann, Schechinger et al. 1998).

OCT3 does, however, transport dopamine with greater affinity than either OCT1 or OCT2. As compared to transport of MPP⁺, OCT1 has a relative transport efficiency for dopamine of ~20%, and OCT2 <5%, whereas OCT3 has a relative transport efficiency of dopamine of ~30% that of MPP⁺ (Schomig, Lazar et al. 2006). It has also been shown that OCT3 is relatively insensitive to cocaine, as seen by an inhibition constant (K_i) above the millimolar range, whereas OCT1 and OCT2 can be inhibited by cocaine with the K_i ranging from 13.3 μ M (OCT1) to 23.8 μ M (OCT2) (Amphoux, Vialou et al. 2006). Based on these data we have chosen OCT3 as the transporter most likely to be involved in a mechanism for stress-induced elevations of dopamine and has, therefore, been the focus of this research. It is the most sensitive to elevations in corticosterone that may result from exposure to stress, especially when compared to PMAT, is located throughout the brain including the NAc and PFC and has a greater affinity for dopamine than the other members of the OCT family making it a good candidate for further examination.

All of the transporters involved in uptake₂ activity are expressed in the rodent and human brain, although at varying levels (Engel, Zhou et al. 2004; Amphoux, Vialou et al. 2006; Gasser, Lowry et al. 2006; Gasser, Orchinik et al. 2009). However, OCT3 appears to be the most abundant of the transporters expressed in the brain, making it the primary transporter of interest for the work done here (Vialou, Balasse et al. 2008; Gasser, Orchinik et al. 2009). Recent work suggests that within the brain, inhibition of uptake₂ activity significantly alters extracellular monoamine levels. Decynium-22 induced inhibition of uptake₂ has been shown to decrease the rate of serotonin clearance within the mouse hippocampus, which

could result in elevated serotonin levels (Baganz, Horton et al. 2008). In addition, treatment of rats with normetanephrine, the potent inhibitor of uptake₂, potentiates the elevation in extracellular norepinephrine caused by treatment with the serotonin-norepinephrine reuptake inhibitor (SNRI) venlafaxine (Rahman, Ring et al. 2008). Finally, knockout mice lacking the expression of OCT3, showed elevated levels of extracellular dopamine in the striatum (Cui, Aras et al. 2009). The results of these studies demonstrate the importance of uptake₂ activity in regulating the level of extracellular monoamines. Any disruption in OCT3 function has a significant impact on monoamine clearance and can result in elevated levels of monoamines, especially when OCT3 is inhibited in the presence of an uptake₁ blocker or saturation. This could have numerous impacts on multiple types of behavior.

As discussed earlier, reinstatement of drug seeking involves the elevation of dopamine in the NAc as well as the PFC, both areas in which OCT3 is expressed (Wise, Murray et al. 1990; Self, Barnhart et al. 1996; De Vries, Schoffelmeer et al. 2002). Additionally, OCT3 functions as a dopamine transporter and its actions are inhibited by corticosterone (Iversen and Salt 1970; Grundemann, Schechinger et al. 1998). Therefore, we propose that stress-induced elevations of corticosterone will result in the blockade of OCT3-mediated dopamine clearance, resulting in increased dopamine concentrations in the presence of other triggers (Figure 4). This suggests stress is acting as a stage setter, making the system more susceptible to elevations in dopamine, and allowing triggers that may not be able to cause reinstatement under non-stress conditions to do so in periods of stress. Furthermore, intake dependent

changes in OCT3 expression following LgA exposure to cocaine may be involved in determining susceptibility to reinstatement seen in animals with different histories of cocaine intake.

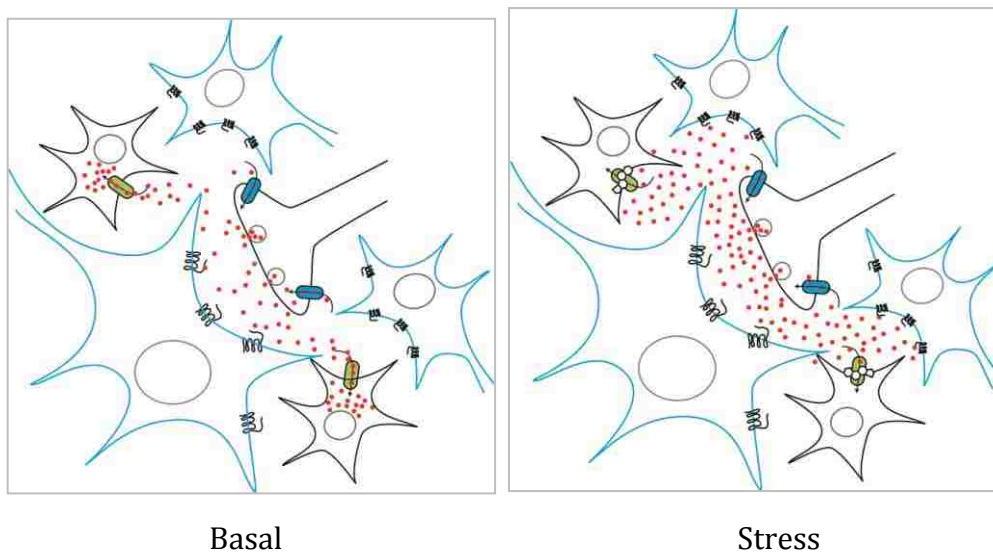

Figure 4. Model of OCT3-mediated regulation of monoamine clearance. Under basal conditions, OCT3 limits the spread of released monoamines. During stress, inhibition of OCT3-mediated monoamine clearance by corticosterone, in combination with increased local monoaminergic neuronal activity, leads to increases in local concentrations of monoamines. Red= Dopamine, Blue= Dopamine transporter, Green= OCT3

In the following studies we will demonstrate:

Chapter 1

-Stress potentiates cocaine-induced reinstatement through a GR-independent mechanism

Chapter 2

-The NAc and PFC are key structures involved in stress-induced potentiation of cocaine-induced reinstatement

-Corticosterone potentiates cocaine-induced elevations in extracellular dopamine in the NAc

Chapter 3

-OCT3 is expressed in proximity to TH-containing cells in the NAc

-Inhibition of OCT3 with normetanephrine potentiates cocaine-induced reinstatement

Chapter 4

-Chronic elevations in corticosterone and excessive cocaine intake result in neuroplasticity that alters later relapse potentially through a decrease in OCT3 expression

We hypothesize that stress acts to set the stage for subsequent reinstatement through corticosterone-induced inhibition of OCT3, making the individual vulnerable to elevations in dopamine levels capable of causing reinstatement.

**Chapter II. EFFECT OF GLUCOCORTICOIDS ON COCAINE-INDUCED
REINSTATEMENT OF COCAINE SEEKING**

Introduction

It has long been known that stress plays an important role in relapse of drug use in individuals recovering from drug addiction; however, the exact mechanism is still not fully understood. Early theories suggested a stress-coping model in which addictive substances are used in order to reduce the negative affect found during periods of stress (Shiffman 1982). Recent evidence suggests that in some cases, the role of stress may be far more complex than simply being a direct trigger for continued drug use (Sinha 2001). Studies have shown that reinstatement in response to physical stressors, such as electric footshock (EFS), can be context dependent such that they will not cause reinstatement when administered in a setting not connected with previous drug intake (Shaham, Erb et al. 2000), while others have shown stress affects reinstatement of different drugs of abuse in different ways (Sinha 2001).

The complexity of stress' role in reinstatement is demonstrated by our inability to observe reliable reinstatement with EFS in rats with a history of ShA cocaine self-administration in the absence of additional cues or cocaine at the time

of reinstatement testing (Mantsch, Baker et al. 2008). This effect has also been shown by others as well and suggests that stress may be acting as a stage setter, allowing for the potentiation of other reinstatement triggers, such as cues (Feltenstein and See 2006; Buffalari and See 2009). This stimulus, that would not cause reinstatement under stress-free conditions, may be able to result in the reinstatement of drug use if the exposure occurs during periods of stress. Gaining a better understanding of this relationship may allow us to gain further insight into the mechanisms through which stress can lead to further drug use.

The mechanisms behind the actions of stress in reinstatement of cocaine-seeking behavior are still relatively unknown despite a large amount of research focused on this area. Several studies have demonstrated that electric footshock is capable of causing reinstatement in animals with a history of excessive (LgA) cocaine use (Erb, Shaham et al. 1996; Ahmed and Koob 1997; Mantsch and Goeders 1999). Other stressors, such as food deprivation and the induction of a stressed-like state with administration of CRF can also result in reinstatement behavior (Shaham, Funk et al. 1997; Shalev, Highfield et al. 2000; Mantsch, Baker et al. 2008). This reinstatement behavior, however, appears to be influenced by the activity of glucocorticoids, especially corticosterone.

Interestingly, these elevations in glucocorticoid activity appear to play a different role at the time of reinstatement testing than during earlier phases of the addiction process. Blockade of acute increases in corticosterone in LgA animals by adrenalectomy after LgA SA, but prior to extinction and reinstatement showed no

effect on footshock-induced reinstatement (Graf, Hoks et al. 2011). Blocking the synthesis of corticosterone with metyrapone showed similar results. Under these conditions, footshock-induced reinstatement of heroin seeking was not affected (Shaham, Funk et al. 1997). While these data suggest that glucocorticoids are not directly involved in mediating reinstatement at the time of testing, their exact role has not been fully examined. It has been demonstrated that corticosterone is necessary in order for SA to occur as adrenalectomy prevents cocaine SA, and this effect can be reversed with corticosterone replacement (Deroche, Marinelli et al. 1997). We predict that stress, and elevations in glucocorticoid levels, has a potential stage setting effect in which they make the individual more susceptible to reinstatement from another trigger.

In order to better understand this point, substantial research has been done examining the actions of glucocorticoids on behavior through activation of the glucocorticoid receptor (GR). Through this pathway, glucocorticoids are able to alter neuronal activity through changes in gene expression, a process that does not occur on a rapid time scale. More recent research, however, has focused on the acute effects of glucocorticoids acting through rapid, non GR-mediated mechanisms, including the modulation of glutamate and GABA release as well activation of the mineralocorticoid receptor (Di, Maxson et al. 2009; Pasricha, Joels et al. 2011). This is of particular importance in order to better understand the ability of stress to influence behavior on a rapid time scale, before alterations in gene translation could alter behaviors such as reinstatement.

In the experiments performed here we examined the ability of acute stress to alter cocaine-induced reinstatement. We examined if the effects of acute stress on reinstatement are dependent upon elevations of glucocorticoid and if an increase in GR activation is required. The results of these experiments suggest a role for a corticosterone-dependent mechanism that potentiates cocaine-induced reinstatement independent of GR activation. These findings may aid in gaining a better understanding of the acute effects of stress on behaviors such as reinstatement.

Materials and Methods

Animals. Male Sprague-Dawley rats (Harlan Laboratories, Inc., St Louis, MO), weighing 275-325 g, were housed individually in a temperature- and humidity-controlled, AAALAC-accredited vivarium under a 12h/12h reversed light- dark cycle (lights off at 0700 h) with ad libitum access to food and water. Procedures were carried out in accordance with the NIH Guide for the Care and Use of Laboratory Animals.

Jugular catheterization. Rats received indwelling jugular catheters under ketamine/xylazine (100 mg/kg; 2 mg/kg, ip) anesthesia as previously described (Mantsch, Baker et al. 2008; Graf, Hoks et al. 2011). Briefly, a silicon-tubing catheter (Silastic, Dow Corning Co., Midland, MI; 0.64 mm i.d.; 1.19 mm o.d.) was inserted into the right posterior facial vein and down into the jugular vein, terminating at the right atrium. The catheter was then continued subcutaneously to the animal's back where it exited posterior to the scapula via a back mounted cannula. Lines from the

cannula were connected to syringe pumps (Razel, Stamford, CT) via fluid swivels (Instech Lab. Inc., Plymouth Meeting, PA) suspended above the chambers.

Swivel/leash assemblies were balanced to permit unrestrained movement.

Cocaine self-administration, extinction and reinstatement. Self-administration was conducted using computer- interfaced operant conditioning chambers contained in sound-attenuating cubicles (Med Associates, St. Albans, VT). Following recovery from surgery, rats were trained to self-administer cocaine (0.5 mg/kg/200 μ l, iv) by pressing a lever under a fixed ratio one schedule during daily 2-h sessions. Cocaine infusions were accompanied by illumination of a light followed by a 25-s time out period during which the light was extinguished but the lever remained extended. Responding on a second, inactive lever was also recorded. Once stable responding was observed (<10% variation in daily responding over ≥ 3 consecutive sessions) rats underwent an additional 14 days of daily self-administration prior to a period of extinction training consisting of daily sessions during which the cocaine solution was replaced with saline. Once extinction criterion was met (≤ 10 active responses/session across 3 sessions), each rat was tested for reinstatement. Reinstatement sessions were identical to extinction except that they were preceded by the delivery of an experimental treatment (e.g. footshock, corticosterone, or vehicle) and then the administration of a low dose of cocaine (2.5 mg/kg; i.p.) (or saline). Reinstatement was defined as an increase in responding on the lever previously reinforced by cocaine compared to the preceding extinction session. Inactive lever pressing was recorded during reinstatement but is not reported due to a lack of significant effects.

Experiment 1. Effects of stress on cocaine-seeking following administration of low-dose cocaine. Here we examined the influence of stress on the reinstatement to a subthreshold dose of cocaine that does not otherwise result in reinstatement. After extinction training, rats (n =7) were placed into self-administration chambers for 15 min, during which they received either no shocks (CTRL) or a series of intermittent uncontrollable electric footshocks (EFS: 0.5 mA, 0.5 s duration, mean intershock interval = 40 s (range 10-70 s)) through the grid floor. Response levers were retracted during this period. Immediately after EFS, rats received an injection of cocaine (2.5 mg/kg, i.p.), at a dose that does not reinstate when given alone, or saline, and were tested for reinstatement. All rats were tested four times in a counterbalanced sequence, such that each rat received each of the following treatments: EFS + saline; EFS + cocaine; CTRL + saline; CTRL + cocaine. Between consecutive reinstatement tests, rats underwent additional extinction sessions until they again met extinction criterion.

Experiment 2. Effects of adrenalectomy on the EFS- induced potentiation of cocaine-induced reinstatement. In this experiment we examined the effect of adrenalectomy on reinstatement following exposure to EFS prior to administration of low-dose cocaine, similar to the experimental setup seen in experiment 1. Six rats were tested for the role of elevated corticosterone in EFS-induced potentiation of cocaine-induced reinstatement. After acquiring stable self- administration, rats underwent bilateral adrenalectomy (ADX) under ketamine/xylazine anesthesia and were implanted with a subcutaneous 25% corticosterone (Sigma-Aldrich) pellet in the nape of the neck. This treatment results in plasma corticosterone concentrations

similar to those found at the nadir of the diurnal cycle, thus maintaining normal diurnal corticosterone fluctuations while eliminating evoked increases (Mantsch and Katz 2007). The rats received 0.025% corticosterone in the drinking water (ethanol concentration = 0.0001%). During the active phase, when most drinking occurs, this treatment results in plasma corticosterone concentrations similar to those observed at the circadian peak (Mantsch and Katz 2007). Drinking water also contained 0.9% NaCl. Upon recovery, rats underwent extinction training, followed by reinstatement testing. Each rat was tested for reinstatement four times in a counterbalanced sequence (once with each treatment: EFS + saline; EFS + cocaine (2.5 mg/kg, ip); CTRL + saline; CTRL + cocaine (2.5 mg/kg, ip)). Consecutive tests were separated by additional extinction sessions.

Experiment 3. Effects of corticosterone on cocaine-seeking following

administration of low-dose cocaine. In order to better understand the role of corticosterone in EFS effects in, we examined the effect of administration of stress level corticosterone on cocaine-induced reinstatement. After extinction training, adrenal- intact rats (n = 6) were tested for reinstatement following an injection of corticosterone (2.0 mg/kg, ip) or vehicle (0.03% EtOH, ip) 40 min prior to administration of cocaine (2.5 mg/kg, ip) or saline. This dose of corticosterone reproduces EFS- induced plasma levels (Table 1) as measured using RIA (see below). Each rat was tested four times in a counterbalanced sequence (once with each treatment: vehicle + saline; vehicle + cocaine; CORT + saline; CORT + cocaine) with consecutive tests separated by additional extinction sessions.

Experiment 4. Effects of RU38486 on corticosterone-induced potentiation of cocaine-induced reinstatement. To test the role of GR in corticosterone-induced potentiation of reinstatement, adrenal-intact rats (n = 10) received an injection of RU38486 (12.5 mg/kg, sc) or vehicle (45% hydroxypropyl β -cyclodextrin) one hour prior to administration of corticosterone (2 mg/kg, ip) or vehicle (0.03% ethanol). Forty minutes later, rats were tested for cocaine-induced reinstatement (2.5 mg/kg, ip). Each rat was tested 4 times in a counterbalanced sequence (once with each treatment: RU486 + Vehicle + cocaine; RU486 + CORT + cocaine; Vehicle + Vehicle + cocaine; Vehicle + CORT + cocaine), with consecutive tests separated by additional extinction sessions. In order to confirm that the dose of RU38486 used activated GR in the brain (Spiga, Knight et al. 2010), translocation of GR was measured using immunofluorescence.

Immunofluorescence. Previously adrenalectomized rats anesthetized with ketamine/xylazine/acepromazine (77/1.5/1.5 mg/ml/kg; ip) were transcardially perfused with 0.05 M PBS, followed by 4% paraformaldehyde in 0.1 M PB. Brains were removed, postfixed and cryoprotected as previously described (Gasser, Orchinik et al. 2009). Coronal sections (30 μ m) containing the dentate gyrus were immunostained using an antibody directed against GR (Santa Cruz Biotechnology, SC-1004 Lot:D0309). After rinsing in PBS containing 0.3% Triton X-100 (PBST), sections were rinsed, mounted onto SuperFrost microscope slides, dried and coverslipped with Vectashield medium (Vector Laboratories, Burlingame, CA). Photomicrographs were acquired using a Retiga 2000R digital camera (QImaging, Surrey, BC, Canada) on a Nikon 80i microscope using NIS Elements software (Nikon

Instruments, Melville, NY).

Experiment 5. Effects of corticosterone on high dose cocaine-induced

reinstatement. In order to determine if administration of corticosterone could potentiate the reinstatement effect of other doses of cocaine that do reinstate when given alone, we performed an experiment similar to that described in experiment 3 using a high dose of cocaine. Following extinction training, adrenal intact rats (n=9) received an injection of corticosterone (2.0 mg/kg, ip) 40 minutes prior to an injection of high dose cocaine (10 mg/kg, ip) (Mantsch and Goeders 1999) or saline. Each rat was tested twice in a counterbalanced sequence, once with each treatment (CORT+cocaine, CORT+saline).

Corticosterone assay. To determine the effects of experimental manipulations on plasma corticosterone concentrations, rats (n = 7) were subjected to the treatments in experiments 1-4 and 6, and blood samples were collected at time points corresponding to the beginning of self-administration. The plasma was isolated from the samples and corticosterone concentrations were determined using a commercial RIA kit (MP Biochemicals, Irvine, CA). RIA is used to measure the concentration of hormone molecules using a radioactive label that quantifies the amount of hormone by determining the extent to which it binds with a commercially produced antibody against corticosterone. The kit uses a limited amount of the specific antibody that reacts with corticosterone labeled with a tritium isotope. Upon addition of an increasing amount of corticosterone, a correspondingly decreasing fraction of radiolabeled corticosterone added is bound to the antibody.

Results

The rats used in these studies acquired stable self-administration in 9 ± 1.2 days, and reached extinction criteria in 8.4 ± 0.8 days. There was no significant difference in responding across all groups on either the last day of self-administration (121 ± 8 responses/session) or the last day of extinction (11 ± 1 responses/session). The effects of experimental manipulations on rat plasma corticosterone concentrations are shown in table 1. Both the corticosterone injection and EFS treatment resulted in significantly elevated corticosterone concentration when compared to a vehicle injection. Plasma corticosterone levels in the corticosterone treated group were not significantly different from levels seen following exposure to EFS.

Experiment 1. Effects of stress on cocaine-seeking following administration of low-dose cocaine. Exposure to EFS prior to administration of a subthreshold dose of cocaine results in reinstatement behavior not seen with injection of low-dose cocaine itself. Figure 5 shows the effects of exposure to EFS and systemic administration of a low dose of cocaine (2.5 mg/kg) given alone as well as in combination to intact rats. Data are shown as reinstatement of responding on the active lever. A repeated measures one-way ANOVA revealed that there is a significant main effect of treatment on active lever responding in this cohort ($p < 0.01$). *Post hoc* comparisons demonstrate that neither treatment with the low-dose of cocaine, nor exposure to EFS, resulted in an increase in active lever responding when compared to saline controls (Figure 5). There was however, a

significant effect in animals receiving low-dose cocaine in combination with exposure to EFS (Newman-Keuls, $p < 0.05$).

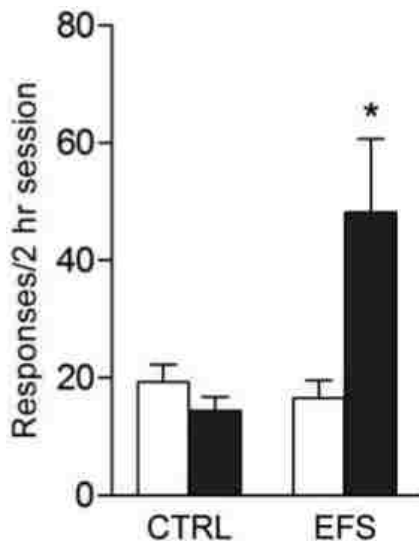

Figure 5. Effects of EFS on cocaine-induced reinstatement in intact rats. Data represent mean \pm SEM of active lever responding over a 2 hour period following exposure to 15 minutes of uncontrollable, intermittent electric footshock (EFS) or no shock (CTRL) followed by administration of cocaine (2.5 mg/kg, ip) or saline. $N=7$; * $p < 0.05$ compared to all other conditions.

Experiment 2. Effects of adrenalectomy on the EFS-induced potentiation of cocaine-induced reinstatement. EFS produced significant increases in plasma corticosterone levels (table 1). In order to determine if EFS-induced increases in corticosterone contributed to the EFS-induced potentiation of reinstatement, the effects of adrenalectomy were examined. Adrenalectomy treatment blocked the EFS-induced potentiation of cocaine-induced reinstatement seen in the prior experiment. In adrenalectomized rats, a repeated measures one-way ANOVA showed there is no main effect of treatment on active lever responding ($p > 0.10$) as was seen in intact rats. Similar to what was seen in intact rats, neither exposure to

EFS alone nor administration of low dose cocaine (2.5 mg/kg) alone led to a significant increase in responding on the active lever. Furthermore, in ADX rats, EFS did not potentiate low dose cocaine-induced reinstatement of active lever responding (Figure 6). This is in contrast with the effect seen in intact animals receiving the same treatment conditions.

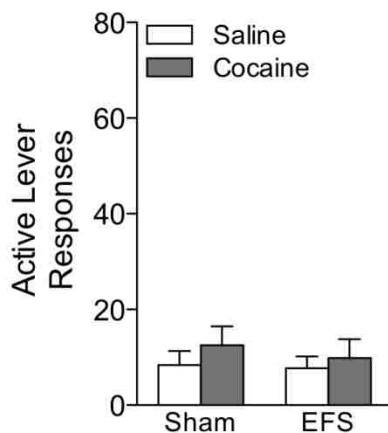

Figure 6. Effects of EFS on cocaine-induced reinstatement in adrenalectomized rats. Data represent mean \pm SEM of active lever responding over a 2 hour period following exposure to 15 minutes of uncontrollable, intermittent electric footshock (EFS) or no shock (CTRL) followed by administration of cocaine (2.5 mg/kg, ip) or saline. N=6; * $p < 0.05$ compared to all other conditions.

	Control	EFS	Corticosterone (2.0 mg/kg)	Normetanephrine (2.5 mg/kg)
Vehicle	122 ± 28	265 ± 57 *	384 ± 34*	93 ± 16
Cocaine (2.5 mg/kg)	129 ± 32	244 ± 47*	360 ± 46*	

Table 1. The effects of experimental conditions on plasma corticosterone concentrations. The table shows corticosterone concentrations (mean ± SEM) measured in the plasma of drug naïve rats (n=7) that had received the indicated treatments. Rats were subjected to each of the treatments and blood samples were recovered at a time point consistent with the initiation of reinstatement testing. Data were analyzed by one-way ANOVA with Bonferroni multiple comparisons post-hoc analysis. * p<0.05.

Experiment 3. Effects of corticosterone on cocaine-seeking following

administration of low-dose cocaine. Since adrenalectomy prevented the EFS-induced potentiation of reinstatement, the ability of corticosterone, at a dose that reproduces EFS-induced increases, was tested for its ability to potentiate cocaine-induced reinstatement. As seen in table 1, the dose of corticosterone chosen (2.0 mg/kg; i.p.) caused an increase in plasma corticosterone similar to that seen following exposure to EFS. Administration of corticosterone alone was sufficient to potentiate cocaine-induced reinstatement in a similar manner to EFS, resulting in reinstatement with a dose of cocaine that does not reinstate when given alone. Responding during reinstatement testing in rats treated with either cocaine or saline with or without a pretreatment of corticosterone can be seen in figure 7. Repeated measures one-way ANOVA reveals a significant main effect of treatment on active lever responding (p<0.0001). *Post hoc* comparisons reveal that neither

administration of low dose cocaine nor corticosterone alone was capable of inducing significant reinstatement as measured by active lever responding when compared to vehicle/saline treated control animals. There was however, significant reinstatement seen in animals that received an injection of low dose cocaine following a pretreatment with corticosterone (Newman-Keuls, $p < 0.01$).

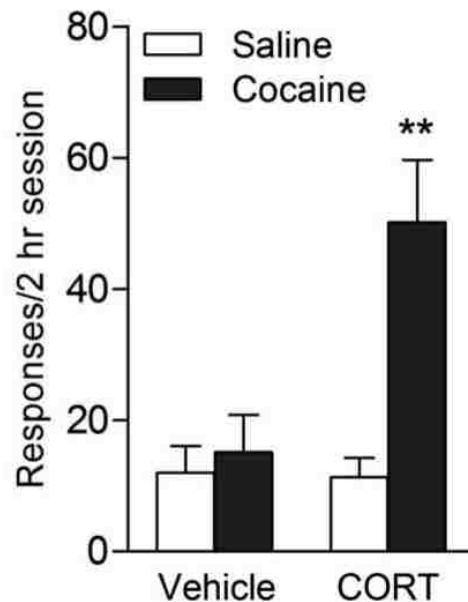

Figure 7. Effects of corticosterone treatment on basal and cocaine-primed reinstatement. Rats ($n=6$) received an injection of corticosterone (CORT; 2.0 mg/kg, ip) or vehicle, 40 minutes prior to an injection of cocaine (2.5 mg/kg, ip) or saline. Data represent mean \pm SEM of active lever responding over a 2-hour period following administration of cocaine or saline. Significant increases in responding were observed only in animals that received both corticosterone and cocaine. * $p < 0.01$ compared to all other conditions.

Experiment 4. Effects of RU38486 on corticosterone-induced potentiation of cocaine-induced reinstatement. Administration of the GR antagonist, RU38486 (12.5 mg/kg), failed to block the corticosterone-induced potentiation of cocaine-induced reinstatement. Active lever responding in cocaine-primed animals treated

with either corticosterone or vehicle with or without a pretreatment of RU38486 is shown in figure 8. All of the animals in this cohort were administered low-dose cocaine. Repeated measures one-way ANOVA revealed a main effect of treatment ($p < 0.001$) on active lever responding. *Post hoc* comparisons indicate that responding on the active lever during reinstatement testing was significantly greater in animals that received an injection of corticosterone prior to administration of low-dose cocaine when compared to animals that received a vehicle injection prior to cocaine (Newman-Keuls, $p < 0.01$). Active lever responding was also significantly greater when animals received both RU 38486 and corticosterone injections prior to administration of cocaine (Newman-Keuls, $p < 0.01$). There was no significant difference in active lever responding in animals treated with RU 38486 alone prior to low dose cocaine injection when compared to animals treated with vehicle prior to cocaine.

In order to determine whether the dose of RU38486 used in this study resulted in activation of central GR, immunofluorescence was used to examine the location of GR. Once activated, GR translocates to the nucleus and as shown in figure 8B, GR (in red) is predominantly located in the nucleus following administration of RU38486 (12.5 mg/kg, sc) indicating that our peripheral treatment resulted in GR binding in the brain.

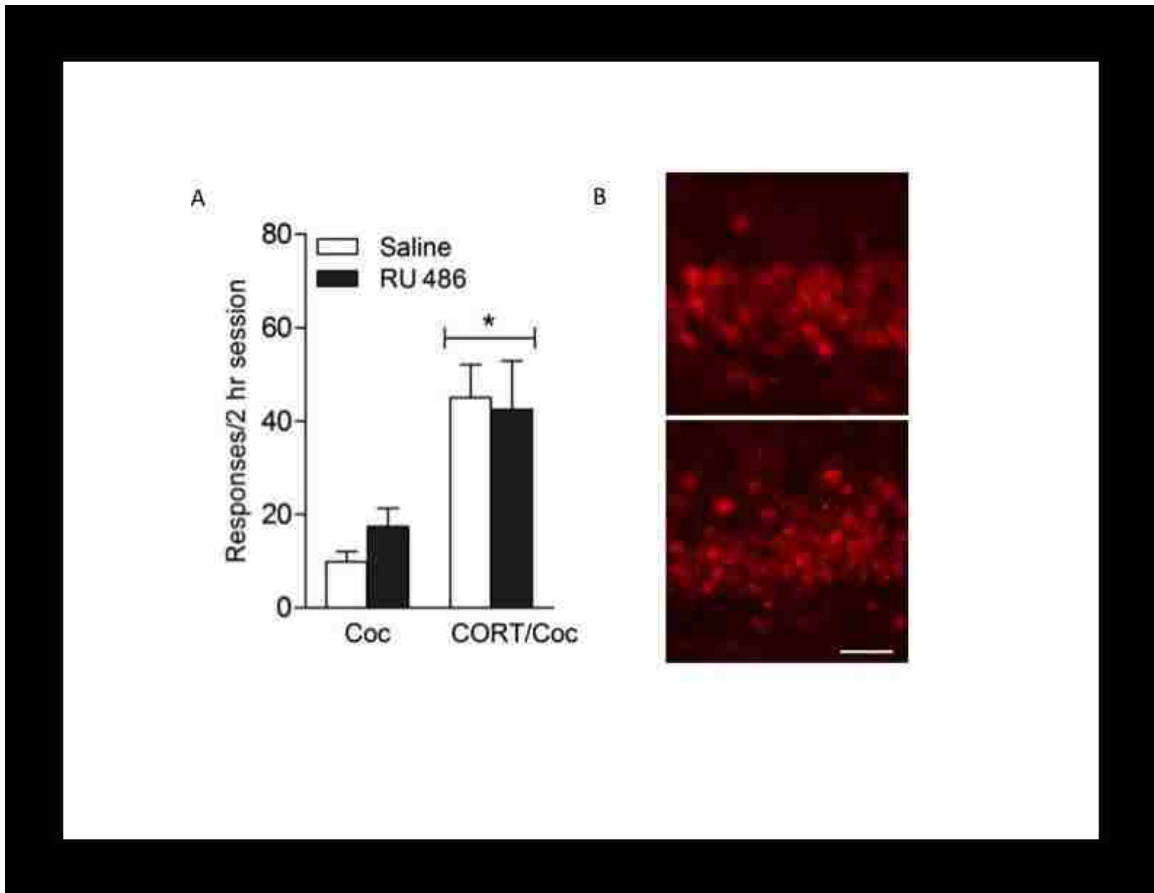

Figure 8. Effects of the glucocorticoid receptor antagonist RU38486 and corticosterone treatment on cocaine-induced reinstatement. (A) Rats (n=10) were given an injection of RU38486 (12.5 mg/kg, sc) or vehicle 60 minutes prior to an injection of corticosterone (2.0 mg/kg, ip) or vehicle. This was followed 40 minutes later by an injection of cocaine (2.5 mg/kg, ip). Data represent mean \pm SEM of active lever responses over a 2-hour period following the final injection. Significant increases in responding were seen in animals which received corticosterone and cocaine, regardless of RU38486 pretreatment. * $p < 0.05$ compared to saline/coc and RU38486/coc conditions. (B) Photomicrograph of GR immunofluorescence in the dentate gyrus of ADX rats treated with vehicle (top) or RU38486 (bottom). RU38486 induced nuclear translocation of GR. Scale bar = 25 μ m

Experiment 5. Effects of corticosterone on high dose cocaine-primed

reinstatement. In order to determine the ability of corticosterone to potentiate reinstatement induced by suprathreshold doses of cocaine, we examined the effect of corticosterone pretreatment on a high dose of cocaine (10 mg/kg, i.p.). No

difference was seen between the animals receiving corticosterone and those receiving the high dose of cocaine alone. Figure 9 shows active lever responses during reinstatement testing in rats treated with cocaine, with or without a corticosterone pretreatment. t-test reveals no effect of treatment ($p > 0.05$) suggesting the effect of corticosterone is non-additive, but rather acts to potentiate the effects of cocaine.

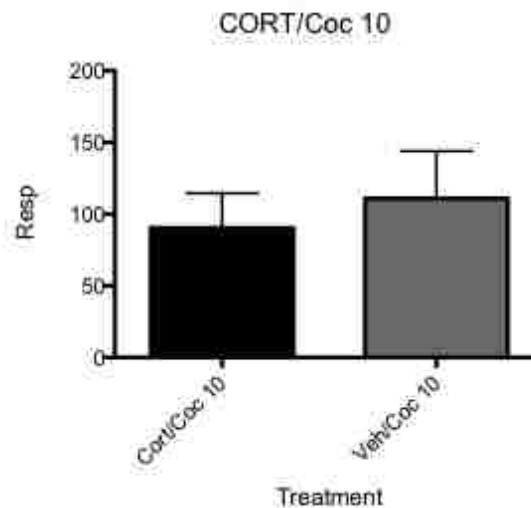

Figure 9. Effects of corticosterone on high dose cocaine-induced reinstatement. Rats ($n=9$) received an injection of cocaine (10 mg/kg, ip) 40 minutes after receiving an injection of corticosterone (2.0 mg/kg, ip) or saline. Data represent mean \pm SEM of active lever responding over a 2-hour testing period following the final injection. No significant effect was seen between the two groups. $p > 0.05$.

Discussion

While it has long been recognized that stress plays a significant role in addiction and relapse, the mechanism is not well understood. The results of these experiments demonstrate that stress is capable of acting as a stage setter, allowing stimuli that would not normally result in reinstatement or relapse behavior to do so

when exposure occurs under a period of stress. This is in agreement with previous work demonstrating the possibility of stress acting as a stage setter (Feltenstein and See 2006; Buffalari and See 2009). The data show that rats that have consumed cocaine under low-intake (short access) conditions do not reinstate when exposed to a footshock stress alone. This footshock stressor will, however, potentiate reinstatement when challenged with a low dose of cocaine (2.5 mg/kg) that will not otherwise result in reinstatement. Further support for the potentiation effect is demonstrated by the lack of an effect when corticosterone is given prior to administration of high-dose cocaine. This demonstrates the lack of an additive effect, suggesting corticosterone potentiates the effect of low dose cocaine. The potentiation effect of footshock can be blocked through elimination of escalation of adrenal hormones in response to stress. The effect can also be mimicked by administration of corticosterone at a dose that produces similar blood levels as those seen following exposure to a stressor. Of great interest to us, this effect of corticosterone is not blocked when given in the presence of the glucocorticoid receptor antagonist RU38486, suggesting that what we are seeing is independent of GR activation.

Stress-induced reinstatement has been an area of great interest due to the findings that reinstatement is only seen in a small range of treatment conditions (Epstein, Preston et al. 2006). Our lab has demonstrated that reinstatement in response to footshock is only seen in rats with a history of excessive drug-intake (long access), but not in rats with restricted intake (short access) (Mantsch, Baker et al. 2008). The data presented here confirm the lack of reinstatement in ShA animals

following exposure to footshock, but also demonstrate the ability of footshock to potentiate reinstatement in response to a non-reinstating dose of cocaine. These data suggest that stress may act to increase an individual's susceptibility to reinstatement by increasing the sensitivity to other triggers, instead of acting as a trigger itself.

The ability of footshock to potentiate cocaine-induced reinstatement in ShA animals appears to be dependent upon the elevation of corticosterone, which is not the case with footshock-induced reinstatement seen in LgA animals where reinstatement occurs even in adrenalectomized rats (Erb, Shaham et al. 1996; Graf, Hoks et al. 2011). In studies performed here, footshock was not able to potentiate reinstatement in rats that had undergone adrenalectomy with corticosterone replacement. Additionally, we have shown the effect of stress could be mimicked by administration of corticosterone at a dose that matched blood concentrations seen following footshock exposure. This suggests the effect of adrenalectomy is due to a loss of corticosterone and not other stress-responsive adrenal hormones, such as epinephrine and indicates that acute manipulations of corticosterone levels immediately prior to reinstatement testing indicate a possible mechanism through stress may increase susceptibility to cocaine-induced reinstatement.

It should be noted that these findings differ from previous studies in which intravenous administration of corticosterone alone resulted in reinstatement of drug seeking (Deroche, Marinelli et al. 1997). This study, however, differed in route of corticosterone delivery (intravenous vs. ip), formulation of corticosterone used,

as well as the experimental setup used. Our results are, however, consistent with previous demonstrating that corticosterone administration increased the reinforcing effects of the psychostimulant amphetamine (Piazza, Maccari et al. 1991) suggesting that while future work needs to be done in order to gain a better understanding, there is justification for the differences seen.

In order to further test the ability of stress level corticosterone to potentiate the effect of cocaine on reinstatement, we repeated this experiment with a high dose of cocaine (10 mg/kg, ip). Under these conditions we were not able to see any potentiation effect as we did with the subthreshold dose of cocaine. This, however, was not unexpected, as this dose of cocaine has been repeatedly shown to cause robust reinstatement. This suggests that the effect of corticosterone on reinstatement is not additive, but rather is able to potentiate the effects of cocaine to a point of reinstatement. It is possible that once a reinstatement threshold is reached, as is the case with administration of high dose cocaine alone, corticosterone has minimal effects on reinstatement behavior.

The potentiation of cocaine-induced reinstatement seen in our studies was not blocked with the pretreatment of the GR antagonist RU38486. This suggests that the stage setting effects of corticosterone we observed are not acting through a GR-dependent mechanism. This is of interest as multiple studies have shown the importance of GR at different stages of self-administration, but no work has been done in isolating the role of GR in rapid effects of stress on reinstatement (Ambroggi, Turiault et al. 2009).

The dose of RU38486 used (12.5 mg/kg, ip) was able to permeate the CNS and bound GR in the brain. The dose used is lower than what has been demonstrated to cause inhibition of a large percentage of GR (Spiga, Knight et al. 2011), but we were able to demonstrate the effectiveness of a lower dose. We were able to show the translocation of labeled GR to the nucleus in adrenalectomized rats, lacking any endogenous corticosterone. This demonstrated the ability of RU38486 to not only access the brain, but also interact with the majority of GR. It is important to note, however, that administration of RU486 may have other effects not accounted for in these studies. Along with its interactions with GR, RU486 also acts on the progesterone receptor with great affinity as well as the androgen receptor with lower affinity. RU486 does not, however, have any affinity for MR (Cadepond, Ulmann et al. 1997).

Recent work has shown a number of mechanisms through which glucocorticoids function independently of GR activation (Groeneweg, Karst et al. 2011). We propose that exposure to stress, and the resulting increase in plasma corticosterone levels, sets the stage for increased sensitivity to other known triggers of reinstatement. This is occurring through a GR-independent mechanism and at a relatively rapid time scale. Furthermore, it can be speculated that the site of action in the brain involves the NAc and/or the PFC as these are regions involved in reinstatement circuitry and appear to be required for cocaine-induced reinstatement (McFarland and Kalivas 2001). The work presented in the following chapters aims at gaining a better understanding of the mechanism behind this effect as well as the site of action responsible.

III. ROLE OF SITE SPECIFIC DOPAMINE IN CORTICOSTERONE-INDUCED POTENTIATION OF COCAINE-INDUCED REINSTATEMENT

Introduction

Previously, as seen in chapter 1, we have demonstrated the ability of stress to act as a stage setter, potentiating reinstatement behavior caused by another stimulus, such as acute cocaine treatment. We have shown that exposure to electric footshock (EFS) prior to administration of a sub-threshold dose of cocaine results in the reinstatement of cocaine seeking behavior. We then demonstrated that this footshock-induced effect was dependent upon glucocorticoid activity and could be mimicked with systemic administration of corticosterone. Finally, we showed that this potentiation effect was working through a non-glucocorticoid receptor (GR) mediated mechanism, as administration of the GR antagonist RU38486 did not block reinstatement. These data suggest that stress and glucocorticoid activity are able to potentiate cocaine-induced reinstatement by acting as a stage setter, making the individual susceptible to reinstatement in response to triggers such a sub-threshold dose of cocaine. The work done in the following experiments aims at gaining a better understanding of the neurobiological processes involved in the behavior we have observed, including the brain regions involved in mediating this behavior as well as the downstream mechanisms responsible.

It has been well established that cocaine seeking, both reinstatement and

reinforcement, involves activation of the mesocorticolimbic dopamine system (Wise and Rompre 1989; Kalivas and McFarland 2003; Pierce and Kumaresan 2006). This circuit involves cell bodies originating the VTA and projecting to regions such as the PFC and the NAC among others (Kalivas and McFarland 2003; Wise 2004).

Inactivation of this system through the use of GABA agonists administered directly into the VTA, PFC or NAc prevents the cocaine-primed reinstatement that can be seen following a period of cocaine self-administration (McFarland and Kalivas 2001). More specifically, administration of dopamine or dopamine agonists directly into the NAC or the PFC is sufficient to cause reinstatement of drug seeking (Self, Barnhart et al. 1996; De Vries, Schoffelmeer et al. 1999; Cornish and Kalivas 2000; McFarland and Kalivas 2001). Additionally, dopamine antagonists have been shown to block the rewarding properties of cocaine (De Wit and Wise 1977) as well as block cocaine-induced reinstatement when administered into the NAc prior to a systemic injection of cocaine (10 mg/kg i.p.) (Madayag, Kau et al. 2010). These data suggest a key role for the NAC, as well other regions involved in the mesolimbic dopamine system, such as the PFC, in reinstatement. Here we examined the role of both the NAc and PFC in order to determine the region or regions involved the corticosterone-dependent, stress-induced, potentiation of cocaine-induced reinstatement we observed in chapter 1.

The role of the NAc in reinstatement of cocaine seeking has further been examined in order to understand the contributions of its subdivisions, the core and the shell. It has been demonstrated that drugs of abuse, such as cocaine, will stimulate dopamine activity in the NAc shell, as measured with *in vivo* microdialysis

(Pontieri, Tanda et al. 1995; Cadoni and Di Chiara 1999). The elevation of dopamine in the NAc shell appears to be dependent upon corticosterone release. Prevention of corticosterone release through adrenalectomy blocks cocaine induced increased in NAc shell dopamine, resulting in dopamine levels similar to those seen in the NAc core, and the effect that can be brought back with corticosterone replacement (Barrot, Marinelli et al. 2000).

Cocaine will also be self-administered directly into the NAc shell, but not the core (Rodd-Henricks, McKinzie et al. 2002). Disruptions of the NAc core, however, have been shown to have other effects such as impaired pavlovian learning (Parkinson, Willoughby et al. 2000; Hall, Parkinson et al. 2001) as well cocaine-seeking (Ito, Robbins et al. 2004). Additionally, administration of dopamine agonists into the NAc core resulted in greater reinstatement compared to administration into the NAc shell (Schmidt, Anderson et al. 2006; Schmidt and Pierce 2006). Dopamine antagonists block cocaine-induced reinstatement when administered into the NAc shell and block reinstatement as a result of dopamine agonists when administered to either region (Bachtell, Whisler et al. 2005). Considering the exact role of these subdivisions in reinstatement of drug seeking is still a subject of debate, we examined both subdivisions in an effort to determine the region of interest for the results seen previously.

In addition to the role of the NAc in reinstatement, there is evidence that stress is capable of increasing dopamine levels in the NAc. Exposure to a brief episode of electric footshock has been shown to result in elevations in dopamine concentration when measured in the NAc (Kalivas and Duffy 1995). Electric footshock as well as

restraint stress has also been shown to elevate dopamine levels in the PFC by an even greater extent than the NAc (Abercrombie, Keefe et al. 1989; Imperato, Puglisi-Allegra et al. 1989).

Some evidence suggests that glucocorticoids may contribute to this effect (Marinelli, Piazza et al. 1994; Rouge-Pont, Marinelli et al. 1995). In these studies, inhibition of corticosterone synthesis by administration of metyrapone, blunted the ability of cocaine to elevate dopamine levels in the NAc. Additionally, it has been demonstrated that administration of the glucocorticoid receptor antagonist, RU38486, into the lateral ventricle, significantly attenuates stress-induced elevations in PFC dopamine, suggesting this effect is dependent upon glucocorticoid receptors (Marinelli, Aouizerate et al. 1998; Butts, Weinberg et al. 2011).

These findings, in combination with data demonstrating that dopamine agonists or administration of dopamine itself in the NAc and PFC is sufficient to cause reinstatement, led us to examine the role of dopamine in the corticosterone-dependent, stress-induced potentiation of reinstatement described in chapter 1 (Wise, Murray et al. 1990; Self, Barnhart et al. 1996; De Vries, Schoffelmeer et al. 1999; Cornish and Kalivas 2000).

In the present study, we examined the site of action involved in corticosterone-dependent potentiation of cocaine-induced reinstatement. To do this we administered corticosterone directly into the NAc or PFC prior to administration of a low-dose of cocaine to examine the effect on reinstatement. We also examined dopamine levels within the NAc following administration of corticosterone and low-dose cocaine to determine the role of dopamine in the reinstatement behaviors we

have observed. In addition, we used site-specific delivery of a dopamine antagonist, fluphenazine, in order to determine if dopamine activity in the NAc (core or shell) or PFC was required for the behavior we observed. We propose that the corticosterone-induced potentiation of cocaine-induced reinstatement involves dopaminergic activity within the NAc and PFC and the experiments done in this chapter will help to gain a better understanding of this behavior.

Materials and Methods

Animals. Male Sprague-Dawley rats (Harlan Laboratories, Inc., St Louis, MO), weighing 275-325 g, were housed individually in a temperature- and humidity-controlled, AAALAC-accredited vivarium under a 12h/12h reversed light- dark cycle (lights off at 0700 h) with ad libitum access to food and water. Procedures were carried out in accordance with the NIH Guide for the Care and Use of Laboratory Animals.

For experiments 1 and 3, the reinstatement of extinguished cocaine seeking was examined. These experiments used the methods described below.

Jugular catheterization. Rats received indwelling jugular catheters under ketamine/xylazine (100 mg/kg; 2 mg/kg, ip) anesthesia as previously described in chapter 2 (Mantsch, Baker et al. 2008; Graf, Hoks et al. 2011). Lines were connected to syringe pumps (Razel, Stamford, CT) via fluid swivels (Instech Lab. Inc., Plymouth Meeting, PA) suspended above the chambers. Swivel/leash assemblies were balanced to permit unrestrained movement.

Cocaine self-administration, extinction and reinstatement. Self-administration

was conducted using computer- interfaced operant conditioning chambers contained in sound-attenuating cubicles (Med Associates, St. Albans, VT). Following recovery from surgery, rats were trained to self-administer cocaine (0.5 mg/kg/200 μ l, iv) by pressing a lever under a fixed ratio one schedule during daily 2-h sessions. Cocaine infusions were accompanied by illumination of a light followed by a 25-s time out period during which the light was extinguished but the lever remained extended. Responding on a second, inactive lever was also recorded. Once stable responding was observed (<10% variation in daily responding over \geq 3 consecutive sessions) rats underwent an additional 14 days of daily self-administration prior to a period of extinction training consisting of daily sessions during which the cocaine solution was replaced with saline. Once extinction criterion was met (\leq 10 active responses/session across 3 sessions), each rat was tested for reinstatement. Reinstatement sessions were identical to extinction except that they were preceded by the delivery of an experimental treatment (e.g. intracranial injection) and then the administration of a low dose of cocaine (or saline). Reinstatement was defined as an increase in responding on the lever previously reinforced by cocaine compared to the preceding extinction session. Inactive lever pressing was recorded during reinstatement but is not reported due to a lack of significant effects.

Experiment 1. Effects of site-specific corticosterone delivery on cocaine seeking following low-dose cocaine administration. In order to determine the site of action involved in corticosterone-induced potentiation of cocaine-induced reinstatement, we attempted to reproduce the potentiation of cocaine-induced reinstatement seen with systemic corticosterone or EFS via site-specific delivery of

corticosterone. At the time of jugular implantation, rats received bilateral 11 mm, 26-gauge cannula aimed at the PFC or NAc for intracranial injections. The tips of the cannulae were aimed 0.5 mm above the target region and the following coordinates were used (Paxinos and Watson 1998): (NAc core: A/P: +1.0, M/L: \pm 2.2, D/V: -6.5 at 0°) (NAc shell: A/P: +2.5, M/L: \pm 0.75, D/V: -6.5 at 0°) (prelimbic division of the PFC: A/P: +2.5, M/L: \pm 1.0, D/V: -3.5 at 8° angle). Following SA and extinction training, rats were tested under five different treatment conditions. Rats were given an intracranial injection of corticosterone (HBC corticosterone was used to avoid the need to solubilize in EtOH; 0.05 μ g/side over 1 min) followed fifteen minutes later by an injection of cocaine (2.5 mg/kg, ip shown to be subthreshold for reinstatement) or saline immediately before reinstatement testing which was done in an identical manner as described in previous chapter. Rats were also tested for the effects of fluphenazine on cocaine-induced reinstatement as will be discussed in experiment 3. Histological analysis of the brains was performed following the completion of testing in order to confirm the placement of cannulae.

Experiment 2. Effects of corticosterone on cocaine-induced extracellular

dopamine in the NAc. In order to examine the effects of corticosterone on cocaine-induced elevations in extracellular dopamine levels, drug-naïve rats under ketamine/xylazine anesthesia were implanted with bilateral guide cannulae (20 gauge; 14 mm; Plastics One) directed at the nucleus accumbens, using the following coordinates (Paxinos and Watson 1998): +0.9 mm AP, \pm 2.5 mm ML to bregma, -4.4 mm from the surface of the skull, at an angle 6° from vertical, and allowed to recover for 5 days. The night before testing, rats were housed in self-administration

chambers. The following day, microdialysis probes constructed as previously described (Baker, McFarland et al. 2003) were inserted into guide cannulae and dialysis buffer (5 mM glucose, 140 mM NaCl, 1.4 mM CaCl₂, 1.2 mM MgCl₂, and 0.15% PBS, pH 7.4) was pumped through at a rate of 1 µl/min for ≥3 h to allow neurotransmitter levels to stabilize. Samples were collected at 20 min intervals throughout the study. After baseline samples were collected, rats received an injection of corticosterone (2.0 mg/kg ip; n = 13) or vehicle (0.03% EtOH; n = 12) followed, 40 min later, by an injection of cocaine (2.5 mg/kg ip). Samples were collected for an additional 2 h. After the study, rats were anesthetized with an overdose of pentobarbital (60 mg/kg ip) and transcardially perfused with 0.9% saline and 2.5% formalin. Brains were removed, postfixed and sectioned in the coronal plane (100 µm) for verification of probe placement.

Dopamine concentrations were quantified by comparing peak heights from samples and external standards using HPLC coupled to electrochemical detection. The mobile phase consisted of 15% acetonitrile, 10% methanol, 150 mM NaH₂PO₄, 4.76 mM citric acid, 3 mM SDS, and 50 µM EDTA, pH 5.6. Dopamine was separated using a reverse-phase column (3 µm; 80 X 3.2 mm; ESA) and detected using an ESA Coulochem II detector coupled to two electrodes set at -0.075 V and +0.25 V, respectively.

Experiment 3. Effects of site-specific dopamine receptor antagonism on the corticosterone-induced potentiation of cocaine seeking. In order to determine the brain regions involved in the effects seen as well as the role of dopamine in these effects, rats were given an injection of corticosterone (2.0 mg/kg, ip) or

vehicle (10% ETOH) followed 25 minutes later by an intracranial injection of the dopamine D1/D2 receptor antagonist fluphenazine (30 nmoles/side in 0.3 μ l injection over 1 minute) or vehicle (aCSF) and followed fifteen minutes later by an injection of cocaine (2.5 mg/kg, ip) and the start of reinstatement testing. All treatments were given in a counterbalanced sequence. Consecutive tests were separated by additional extinction sessions.

Results

Experiment 1. Effects of site-specific corticosterone delivery on cocaine seeking following low-dose cocaine administration. The potentiating effect of systemic corticosterone administration on cocaine-induced reinstatement was reproduced by corticosterone delivery directly into the NAc. As seen in table 1, there was no significant difference in reinstatement between animals in which the NAc shell was targeted in comparison to animals in which the NAc core was targeted ($p>0.05$). For this reason the data from these two groups were combined and presented as a single data set. A 2-way repeated measures treatment condition x reinstatement ANOVA showed a significant overall effect of treatment condition (Intra-NAc Veh vs. ip Coc/Intra-NAc Cort vs. ip Coc/Intra-NAc Cort + ip Veh; $F_{2,22}=4.460$; $p<0.05$) and reinstatement condition (reinstatement test session vs. previous extinction session; $F_{1,11}=7.374$; $p<0.05$) and a significant treatment x reinstatement interaction ($F_{2,22}=4.182$; $p<0.05$). Post-hoc testing showed that neither intra-NAc corticosterone in combination with ip saline nor low-dose cocaine in combination with intra-NAc vehicle produced significant reinstatement.

However, when rats received intra-NAc corticosterone prior to cocaine administration, significant reinstatement was observed (2-tailed $t_{11}=3.132$ vs. extinction; $p<0.05$).

Direct injection of corticosterone into the PFC also resulted in the potentiation of cocaine-induced reinstatement. A 2-way repeated measures treatment condition x reinstatement ANOVA showed a significant main effect of reinstatement ($F_{1,5}=8.022$; $P<0.05$), but not treatment. Significant reinstatement x treatment interaction ($F_{1,10}=4.137$; $P<0.05$). Post-hoc testing showed significant reinstatement only in the group receiving intra-PFC corticosterone + ip cocaine.

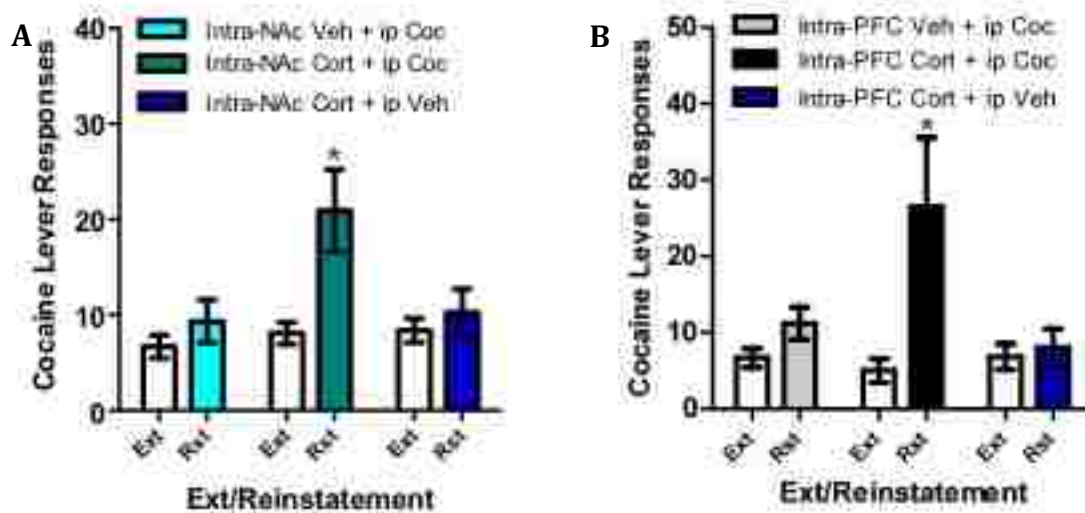

Figure 10. Site-specific administration of corticosterone. (A) Administration of corticosterone directly into the NAc results in the potentiation of cocaine-induced reinstatement. (B) Similar potentiation effects were seen in rats in which corticosterone was administered directly into the PFC. Data represent mean \pm SEM of active lever responding over a 2 hr period following administration of intracranial administration of corticosterone (0.05 μ g/side) or vehicle, followed 15 minutes later by administration of cocaine (2.5 mg/kg; ip) or vehicle. * $p<0.05$ compared to all other conditions.

The accuracy of intra-NAc and intra-PFC injections is shown in Figure 11.

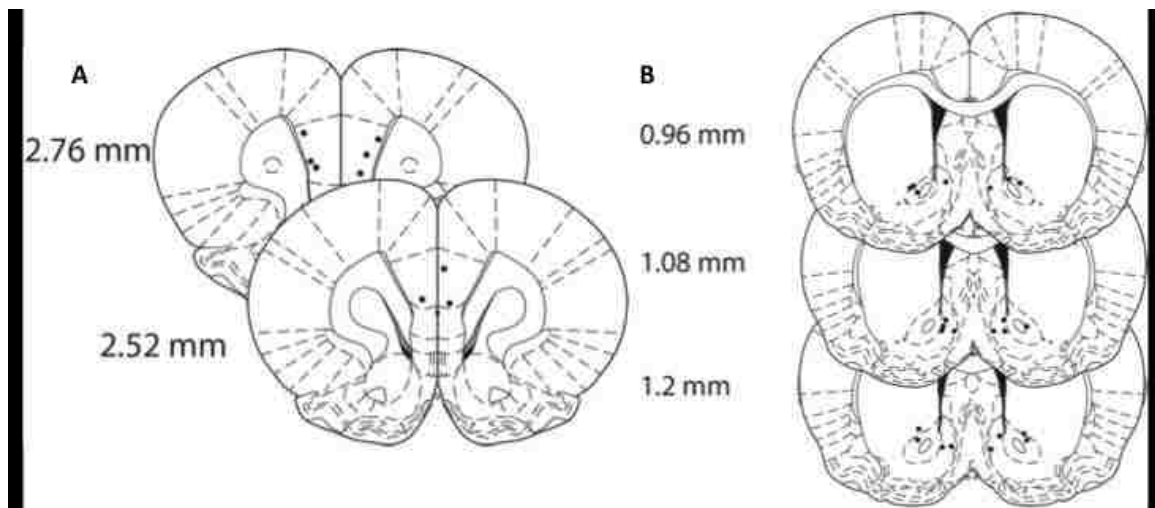

Figure 11. Representation of cannulae placement into PFC (A) and PFC (B). All rats in which cannulae that were not directed at the target brain region were not used in the data analysis. Coordinates relative to bregma.

	Extinction	Intra NAc Veh+ ip cocaine	Intra NAc corticosterone + ip cocaine	Intra NAc corticosterone + ip saline
--	------------	---------------------------------	---------------------------------------------	--------------------------------------------

NAc Shell	9.66 ± 1.7	17.71 ± 6.47	26.16 ± 6.4	15.28 ± 5.06
NAc Core	8.33 ± 1.7	8 ± 3.94	15.66 ± 4.77	8 ± 1.98

Table 2. Breakdown of responses during reinstatement testing in rats in which NAc shell and NAc core were targeted (mean ± SD). A 3-way reinstatement (extinction vs. reinstatement test) x treatment (ip cocaine + intra-NAc corticosterone, ip cocaine + intra-NAc vehicle, ip veh + intra-NAc corticosterone) x NAc subregion (core vs shell) failed to show a significant main effect of reinstatement site or significant interactions between the site and treatment, site and reinstatement, or site, treatment and reinstatement. Thus, data from the NAc core and shell were combined for all analyses.

Experiment 2. Effects of corticosterone pretreatment on cocaine-induced

increases in extracellular dopamine in the NAc. Figure 12 illustrates

extracellular dopamine levels in the NAc before and after a systemic injection of cocaine (2.5 mg/kg, ip) in animals pretreated with either corticosterone (2.0 mg/kg, ip) or vehicle. Corticosterone pretreatment potentiated elevations in NAc extracellular dopamine levels following administration of a low dose of cocaine. A 2-way ANOVA with pretreatment as a between-subjects factor and time (sample) as a repeated measure showed no significant interaction. However, cumulative post cocaine extracellular dopamine levels (calculated as areas under the curve using all post-cocaine samples) were significantly higher in corticosterone- than in vehicle-pretreated animals (unpaired t-test; $t_{(23)}=1.793$, $p=0.043$).

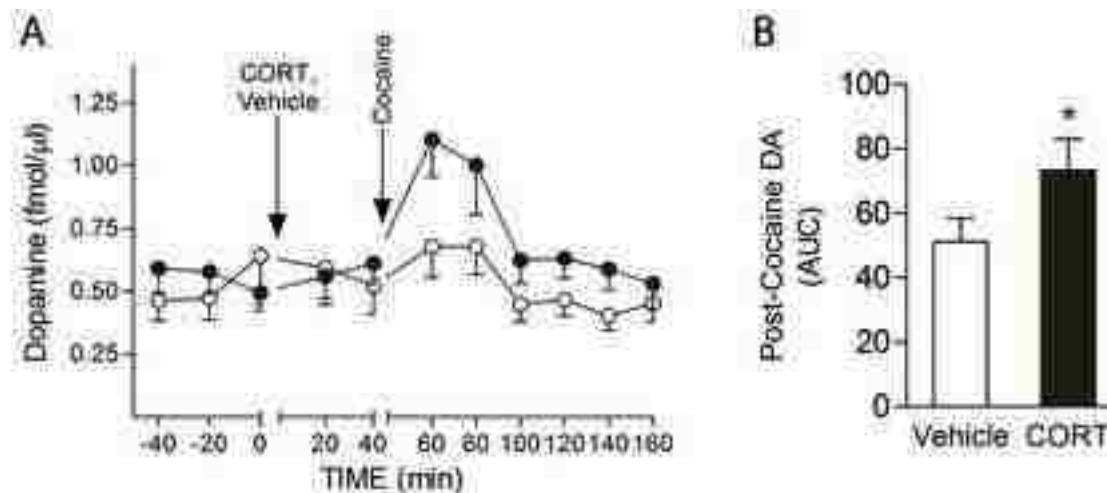

Figure 12. In vivo microdialysis measuring dopamine levels in the NAc. Samples taken in the first 60 min were used as baseline, followed by an injection of either CORT (2.0 mg/kg, i.p) or vehicle. 40 min later all animals received an injection of cocaine (2.5 mg/kg, i.p) and samples were collected for an additional 160 min. Inset: Dopamine area under the curve (AUC) for the 2-h period following cocaine injection.

Experiment 3. Effects of site-specific dopamine receptor antagonism on the corticosterone-induced potentiation of cocaine seeking. In order to determine if increases in NAc or PFC DA were required for potentiated reinstatement in rats that received ip corticosterone prior to administration of a low dose of cocaine. Rats were given the non-selective DA receptor antagonist, fluphenazine, into the NAc (n=13) or PFC (n=7) prior to reinstatement testing. Fluphenazine delivery into the NAc attenuated reinstatement. A 2-way repeated measure pretreatment condition (fluphenazine vs. vehicle) x reinstatement (ip cort + coc vs. extinction) ANOVA showed significant overall effects of fluphenazine pretreatment ($F_{1,12}=4.629$; $p=0.05$) and reinstatement ($F_{1,12}=8.708$; $p<0.05$) and a significant fluphenazine x reinstatement interaction ($F_{1,12}=6.007$; $p<0.05$)(figure 13). Cocaine administration

following corticosterone delivery reinstated cocaine seeking following intra-NAc pretreatment with vehicle (2-tailed $t_{12}=3.259$; $p<0.01$ vs. extinction) but not fluphenazine. Furthermore, cocaine seeking following fluphenazine was significantly reduced compared to intra-NAc vehicle pretreatment (2-tailed $t_{12}=2.406$; $p<0.05$).

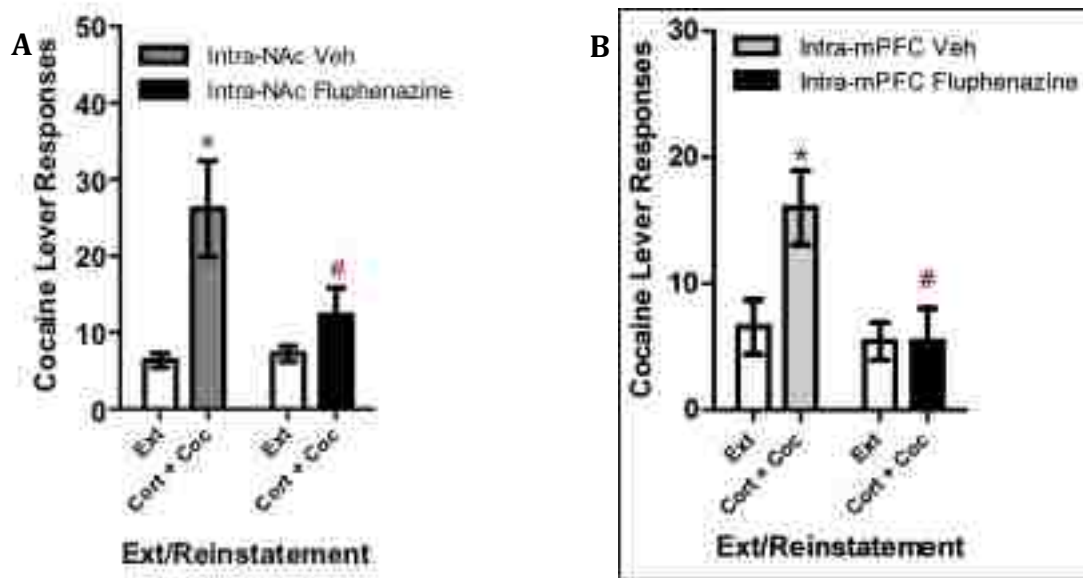

Figure 13. Effects of fluphenazine on cocaine-induced reinstatement following pretreatment with corticosterone. Data represent mean \pm SEM of active lever responding over a 2 hour period following administration of corticosterone (2.0 mg/kg; ip) followed 25 minutes later by (A) intra-NAc or (B) intra-PFC fluphenazine (30 nmoles/side) or vehicle, followed 15 minutes later by cocaine (2.5 mg/kg; ip). (A)* $p<0.01$ compared to extinction. # $p<0.05$ compared to intra-NAc veh. $N=13$. (B) * $p<0.02$ compared to extinction. # $p<0.001$ compared to intra-PFC veh. $N=7$.

Discussion

The role of stress in cocaine addiction and reinstatement has been well established, but the exact mechanism through which it exerts its effects is still unknown. Recent studies have suggested that, in some situations, stress may act as

a stage setter, allowing stimuli that normally do not result in reinstatement to do so under periods of stress (Feltenstein and See 2006; Buffalari and See 2009). We have shown in chapter 1 that rats with a history of cocaine intake under ShA (2 hours/day) conditions show a potentiation of cocaine-induced reinstatement when exposed to electric footshock or acute systemic corticosterone administration prior to reinstatement testing. These data demonstrated a role of corticosterone in the potentiation of reinstatement with a low-dose cocaine primer, however the site of action was not determined.

Here we demonstrate that corticosterone can act in for both the NAc and the PFC in the corticosterone-induced potentiation of cocaine-induced reinstatement. Like systemic corticosterone delivery, administration of corticosterone directly into either the NAc or PFC potentiates cocaine-induced reinstatement when rats are challenged with a dose of cocaine unable to trigger reinstatement when given alone. While various studies have demonstrated a differential role for the NAc core and shell in reinstatement (Anderson, Bari et al. 2003; Anderson, Schmidt et al. 2006; Schmidt, Anderson et al. 2006), the studies performed here showed no significant difference between the two regions.

Previous research has demonstrated that extinguished drug seeking can be reinstated with priming injections of either indirect or direct dopamine receptor agonists (Gerber and Stretch 1975; de Wit and Stewart 1981; Wise, Murray et al. 1990). Localization studies have gone on to show that these effects are mediated, at least in part, by the NAc as well as other areas of the mesocorticolimbic dopamine system (Stewart and Vezina 1988; McFarland and Kalivas 2001; Wise 2008). Based

on these findings we examined extracellular dopamine concentrations in the NAc following systemic administration of corticosterone prior to an injection of low-dose cocaine.

Cocaine-induced elevations in extracellular dopamine levels within the brain appear to dependent upon the release of corticosterone. Blockade of corticosterone synthesis or release prevents cocaine-induced dopamine increases and the effect can only be brought back when corticosterone is replaced (Marinelli, Piazza et al. 1994; Barrot, Marinelli et al. 2000). This would suggest that corticosterone is responsible, or at least required, for dopamine concentrations to increase in the brain in response to cocaine administration.

Here we have shown the ability of corticosterone to potentiate cocaine-induced dopamine elevations. The effects of corticosterone treatment on extracellular dopamine concentration in the NAc were measured using in vivo microdialysis. We have found that the potentiation in dopamine levels was very similar to the effect we saw on reinstatement suggesting that corticosterone potentiates cocaine-induced reinstatement in part by modulating dopaminergic neurotransmission in the NAc. This is in agreement with previous studies showing that acute stress (Kalivas and Duffy 1995) or corticosterone treatment (Marinelli, Piazza et al. 1994; Barrot, Marinelli et al. 2000) can elevate extracellular dopamine concentrations in the NAc. Future studies will also need to be done in order to determine the role of dopamine in other regions of the mesocorticolimbic dopamine system, especially the PFC.

Since corticosterone potentiated cocaine-induced increases in NAc dopamine,

we next decided to determine if this potentiated dopamine response was involved in the potentiation of cocaine-induced reinstatement. In these studies, we have shown that the potentiation effect of i.p. corticosterone can be blocked with pretreatment with the non-specific dopamine receptor antagonist fluphenazine into the NAc or PFC. This suggests a requirement for dopamine activity in the NAc and PFC in order to cause the behavioral effects observed. A role for dopamine is not surprising, as elevations of dopamine in these regions have been shown to be involved in reinstatement by numerous studies (Wise, Murray et al. 1990; Self, Barnhart et al. 1996; McFarland and Kalivas 2001).

The findings that corticosterone potentiates cocaine-induced increases in NAc dopamine taken together with the data showing blockade of the dopamine receptor in this region as well as the PFC prevents reinstatement suggests that corticosterone's ability to influence dopamine concentrations is what is responsible for this behavior. This is in agreement with previous studies showing that dopamine receptor activation is sufficient to reinstate drug seeking and the magnitude of cocaine-induced increases in NAc dopamine plays a key role in the magnitude of reinstatement (Cornish and Kalivas 2000; Bachtell, Whisler et al. 2005; Schmidt, Anderson et al. 2006; Madayag, Kau et al. 2010). Additionally, administration of dopamine antagonists directly into the NAc can block cocaine-induced reinstatement in response to a reinstating dose of cocaine, especially when administered into the NAc shell (Anderson, Bari et al. 2003; Bachtell, Whisler et al. 2005; Anderson, Schmidt et al. 2006).

In addition to the findings suggesting the role of the NAc in the reinstatement

of cocaine seeking, the PFC has also been strongly implicated in these behaviors. It has been shown that administration of dopamine itself into the PFC can enhance cocaine-induced reinstatement and administration of the dopamine antagonists into the PFC can prevent reinstatement (McFarland and Kalivas 2001; Sanchez, Bailie et al. 2003). Furthermore, it has been shown that administration of cocaine directly into the PFC can increase cocaine seeking, and this effect can be blocked with dopamine antagonists (Park, Bari et al. 2002). Additionally, stress and corticosterone can also increase dopamine levels in the PFC, possibly to an even greater extent than occurs in the NAc (Abercrombie, Keefe et al. 1989). Together these findings support our results suggesting inhibition of dopamine activity within the PFC, as well as the NAc, can alter reinstatement of cocaine seeking.

It is important to note, however, that the role of the infralimbic vs. prelimbic areas of the PFC were not examined in this study. Recent findings suggest an opposing role of these regions in the reinstatement of cocaine seeking. In agreement with the data presented here, previous work has demonstrated that inhibition of the prelimbic cortex will block reinstatement of drug seeking in response to cue, drug priming and stress-induced cocaine seeking (McFarland and Kalivas 2001; Capriles, Rodaros et al. 2003; McLaughlin and See 2003; McFarland, Davidge et al. 2004). In opposition to this, it has been shown that inhibition of the infralimbic cortex can induce cocaine seeking in extinguished rats (Peters, LaLumiere et al. 2008). The opposing roles of the subdivisions of the PFC may be due to involvement of different circuitry or expression levels of the different dopamine receptors, both issues that are not addressed by the work presented here

(Kebabian and Greengard 1971; Gaspar, Bloch et al. 1995; Caine, Negus et al. 2000).

In the studies shown here only the prelimbic cortex was targeted for direct administration and further studies would need to be performed in order to determine the role of these two regions in the behaviors seen here.

The results of these experiments suggest that increases in corticosterone during stress may augment the dopamine response to appetitive stimuli, such as cocaine. Without this dopamine response, corticosterone-induced potentiation of cocaine seeking is not observed, as is seen following administration of fluphenazine. Additionally, site-specific administration of corticosterone directly into the NAc and PFC demonstrates that these regions play a key role in the behavior we have observed here as well as in chapter 1. These findings suggest a mechanism through which corticosterone influences dopamine concentrations in order to regulate reinstatement behavior, however, additional work needs to be done in order to better understand the exact mechanism through which corticosterone is acting to regulate dopamine levels (see chapter 3).

IV. ROLE OF ORGANIC CATION TRANSPORTER 3 IN CORTICOSTERONE – INDUCED POTENTIATION OF COCAINE-INDUCED REINSTATEMENT

Introduction

Glucocorticoid hormones have been implicated in the mechanism through which stress may regulate drug use and relapse. Multiple studies have demonstrated the ability of glucocorticoids to influence all aspects of addiction related behaviors, including acquisition, maintenance and reinstatement of cocaine seeking (Deroche, Marinelli et al. 1997; Mantsch and Goeders 1999; Shalev, Marinelli et al. 2003; Mantsch, Baker et al. 2008). The ability of glucocorticoids to significantly influence reinstatement, however, is still not entirely understood. Previous studies have shown the ability of acute stressors to modulate cue-induced reinstatement, but the mechanism behind this effect has not been extensively studied (Feltenstein and See 2006; Buffalari and See 2009). In the experiments performed here, we examined a potential mechanism through which glucocorticoid activity may modulate reinstatement behavior.

The experiments described in chapters 1 and 2, demonstrated that stress and acute corticosterone administration can potentiate cocaine-induced reinstatement through a mechanism that is not dependent upon glucocorticoid receptor (GR) activation, since the GR antagonist, RU38486, does not block corticosterone-

potentiated reinstatement. Additionally, in agreement with previous studies, we have shown that this effect involves corticosterone-mediated elevations in dopamine levels within the NAc and PFC, brain regions implicated in reinstatement (Abercrombie, Keefe et al. 1989; Imperato, Puglisi-Allegra et al. 1989). The goal of the experiments performed here is to examine the mechanism through which corticosterone can regulate dopaminergic neurotransmission and, thereby, reinstatement.

Many of the actions of glucocorticoids can be attributed to activation of GR and resulting alterations in gene transcription and translation. However, many of the acute, rapid effects of glucocorticoids have been shown to act through mechanisms that act independently of GR activation, such as endocannabinoid or nitric oxide activity (Di, Maxson et al. 2009; Pasricha, Joels et al. 2011). The acute effects of stress occur in a rapid time course, suggesting alterations in gene transcription and translation may not be involved. One such mechanism by which glucocorticoids may rapidly influence drug seeking is through inhibition of monoamine clearance by organic cation transporter 3 (OCT3). OCT3 is a high capacity transporter involved in the extracellular clearance of dopamine as well as other monoamines (Grundemann, Liebich et al. 1999). This transporter has a lower affinity for monoamines than the primary, uptake 1 transporters suggesting that it may act as a secondary clearance mechanism (Simmonds and Gillis 1968; Iversen and Salt 1970). Additionally, OCT3 mediated clearance is inhibited by corticosterone through a GR-independent mechanism (Grundemann, Liebich et al. 1999). It has also been demonstrated that the concentration of corticosterone

needed to inhibit OCT3 mediated transport falls within physiological stress levels (Gasser, Lowry et al. 2006; Hill, Makky et al. 2011).

Previous work has shown OCT3 to be expressed throughout the brain, including regions involved in the regulation of drug seeking behavior, including the NAc and PFC (Cui, Aras et al. 2009; Gasser, Orchinik et al. 2009). Numerous studies have demonstrated the importance of dopamine activity in these regions as it relates to reinstatement of cocaine seeking (Self, Barnhart et al. 1996; De Vries, Schoffelmeer et al. 1999; Cornish and Kalivas 2000). Additionally, it has been shown that glucocorticoids are capable of elevating extracellular dopamine concentrations in the NAc (Rouge-Pont, Marinelli et al. 1995; Piazza, Rouge-Pont et al. 1996) and the PFC (Butts, Weinberg et al. 2011). Notably, in Chapter 2 we demonstrated that corticosterone-induced effects on DA in both regions is necessary for the potentiation of cocaine-induced reinstatement. While these data demonstrate the ability of increased dopamine levels to result in reinstatement and show that stress and glucocorticoids are involved in the regulation of dopamine levels, the exact mechanism behind dopamine elevations remains unknown. Previous studies have demonstrated that glucocorticoids may be involved in the reduction of dopamine clearance (Gilad, Rabey et al. 1987). In this study, administration of a synthetic glucocorticoid, methylprednisolone, decreased dopamine clearance as measured by a dopamine uptake study. Here we suggest that corticosterone-induced blockade of OCT3, a high capacity, low affinity clearance mechanism, may act to set the stage for other triggers to increase dopamine concentrations to levels that could result in reinstatement (see figure 12). The aim

of these studies is 1) examine the expression of OCT3 in the NAc in relation to dopamine terminals thus positioning it as a viable dopamine clearance mechanism in this region; and 2) to determine whether blockade of OCT3 by a non-glucocorticoid inhibitor mimics the potentiating effects of stress and corticosterone on reinstatement by low-dose cocaine.

Materials and Methods

Animals. Male Sprague-Dawley rats (Harlan Laboratories, Inc., St Louis, MO), weighing 275-325 g, were housed individually in a temperature- and humidity-controlled, AAALAC-accredited vivarium under a 12h/12h reversed light- dark cycle (lights off at 0700 h) with ad libitum access to food and water. Procedures were carried out in accordance with the NIH Guide for the Care and Use of Laboratory Animals.

Experiment 1. OCT3 immunoreactivity in the NAc. The expression of OCT3 within the NAc was examined in order to better understand its role within this region. Drug-naïve rats were anesthetized with ketamine/xylazine/acepromazine (77/1.5/1.5 mg/ml/kg; ip) and were transcardially perfused with 0.05 M PBS, followed 4% paraformaldehyde in 0.1 M PBS. Brains were removed, postfixed and cryoprotected as previously described (Gasser, Orchinik et al. 2009). Coronal sections (30 μ m) containing the NAc were immunostained using antibodies directed against OCT3 (Isolated from rabbit; OCT31A; ADI, San Antonio, TX) and tyrosine hydroxylase (TH; MAB 318, Millipore, Billerica, MA). After rinsing in PBS containing

0.3% Triton X-100 (PBST), sections were incubated overnight with anti-OCT3 antibody (1:250) and anti-TH antibody (1:1600) in 0.1% PBST. Sections were rinsed and incubated 2 hours with AlexaFlour594-conjugated donkey anti-rabbit and AlexaFlour488-conjugated donkey anti-mouse IgG antibodies (1:200; Invitrogen). Sections were rinsed, mounted onto SuperFrost microscope slides, dried and coverslipped with Vectasheild medium (Vector Laboratories, Burlingame, CA). Photomicrographs were acquired using a Retiga 2000R digital camera (QImaging, Surrey, BC, Canada) on a Nikon 80i microscope using NIS Elements software (Nikon Instruments, Melville, NY).

Experiment 2. Effects of the non-glucocorticoid inhibitor, normetanephrine, on low-dose cocaine-induced reinstatement. To examine the role of OCT3 in the potentiation of reinstatement, rats received indwelling jugular catheters under ketamine/xylazine (100 mg/kg; 2 mg/kg, ip) anesthesia as described in Chapter 1, and were trained to self-administer cocaine (0.5 mg/kg/200 μ l, iv) by pressing a lever under a fixed ratio one schedule during daily 2-h sessions. Once stable responding was observed (<10% variation in daily responding over \geq 3 consecutive sessions) rats underwent an additional 14 days of daily self-administration prior to a period of extinction training consisting of daily sessions during which the cocaine solution was replaced with saline as previously described in earlier chapters. Once extinction criterion was met each rat was tested for reinstatement. Reinstatement sessions were identical to extinction except that they were preceded by the delivery of an experimental treatment (e.g. injection of normetanephrine or vehicle) and then the administration of a low dose of cocaine (or saline). Reinstatement was

defined as an increase in responding on the lever previously reinforced by cocaine compared to the preceding extinction session. Inactive lever pressing was recorded during reinstatement but is not reported due to a lack of significant effects.

Following reinstatement and extinction, rats (n=10) were pretreated with the OCT3 inhibitor normetanephrine (2.5 mg/kg, ip) or vehicle (saline) 40 minutes prior to receiving an injection of cocaine (2.5 mg/kg, ip) or saline, and testing for reinstatement. Each rat was tested four times in a counterbalanced sequence (once with each treatment: Vehicle + saline; Vehicle + cocaine; normetanephrine + saline; normetanephrine + cocaine). Consecutive tests were separated by additional extinction sessions.

Results

Experiment 1. OCT3 immunoreactivity in the NAc. The presence of OCT3-like immunoreactivity (OCT3-ir) was examined within the NAc in order to determine its ability to act as a transporter within this region. OCT3-like immunoreactivity was observed as puncta distributed throughout the NAc core and shell, and was also concentrated in small diameter (6-8 μ m) perikarya (figure 14). Staining was not observed in sections incubated in the absence of the OCT3 antibody. In both regions, OCT3-ir puncta were observed in close proximity to tyrosine hydroxylase-immunoreactive fibers. This positions OCT3 to potentially serve as a clearance mechanism within this region.

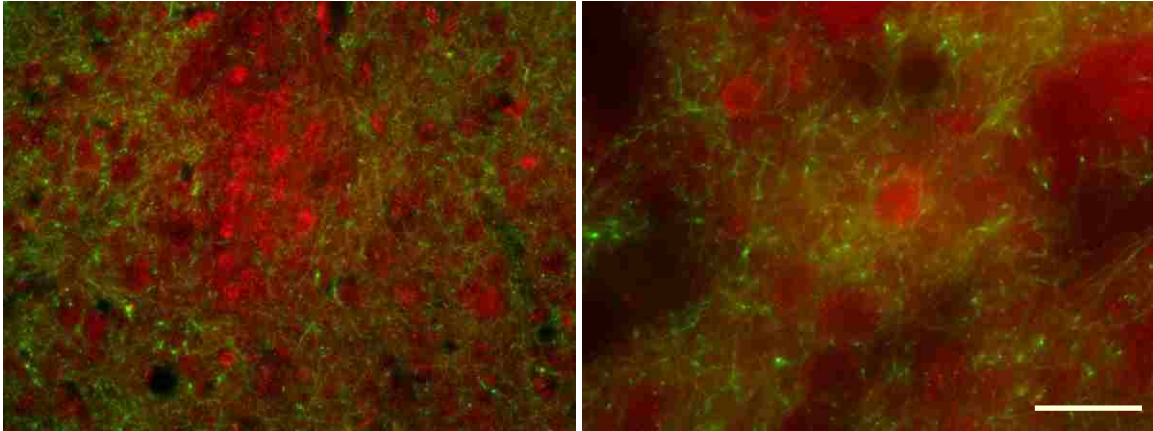

Figure 14. Photomicrograph of dual-label immunofluorescence for OCT3 (red) and tyrosine hydroxylase (green) in the nucleus accumbens. Punctate OCT3-like immunoreactivity was observed throughout the nucleus accumbens, and was concentrated in close proximity to TH-immunoreactive fibers. Left=40X, Right=100X. Scale bar= 50 μ m.

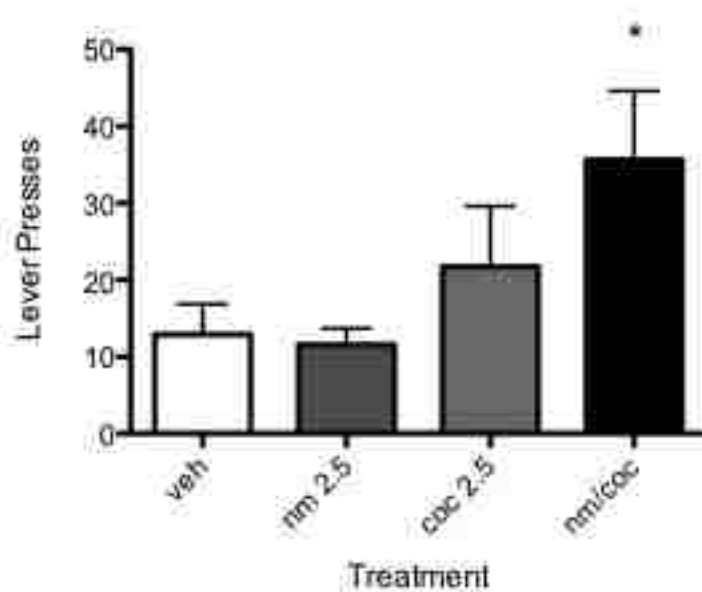

Figure 15. OCT3 inhibition enhances cocaine-induced reinstatement. Animals received vehicle or the OCT3 inhibitor normetanephrine (nm, 2.5 mg/kg, ip), followed by a low dose of cocaine (2.5 mg/kg) or vehicle. Normetanephrine potentiated low-dose cocaine-induced reinstatement. (Repeated measures ANOVA with Tukey post hoc test. * indicates $p < 0.05$ compared to veh and nm 2.5 groups).

Experiment 2. Effects of the non-glucocorticoid inhibitor, normetanephrine, on low-dose cocaine-induced reinstatement. In order to test the hypothesis that corticosterone-induced blockade of OCT3 contributes to the potentiation of cocaine-induced reinstatement, rats were tested for cocaine-induced reinstatement following administration of the non-glucocorticoid OCT3 inhibitor, normetanephrine. Figure 15 illustrates responding during reinstatement testing in rats treated with cocaine or saline in the presence or absence of the non-glucocorticoid OCT3 inhibitor normetanephrine. Repeated measures one-way ANOVA revealed a significant main effect of treatment on active lever responding ($p < 0.01$). Post-hoc comparisons indicated that neither normetanephrine nor low-dose cocaine treatment alone significantly increased active lever responding compared to the vehicle-treated condition. However, active lever responding was significantly increased over all other conditions when animals had received both normetanephrine and cocaine (Newman-Keuls, $p < 0.01$). These results are similar to the data previously reported following administration of corticosterone or EFS prior to a low-dose of cocaine.

Discussion

The role of stress in cocaine addiction and reinstatement has been extensively studied, but the mechanisms involved remain largely unknown. It has been demonstrated that glucocorticoids have the capability to elevate dopamine levels within the NAc and PFC and that increases in dopamine activity within this

region is key for reinstatement behavior (Rouge-Pont, Marinelli et al. 1995; Piazza, Rouge-Pont et al. 1996; Self, Barnhart et al. 1996; De Vries, Schoffelmeer et al. 1999; Cornish and Kalivas 2000; Butts, Weinberg et al. 2011). In the earlier chapters we have shown that corticosterone potentiates cocaine-induced reinstatement through a GR-independent mechanism that involves the elevation of dopamine levels in the NAc. Glucocorticoids are known to be able to alter neurotransmission through a number of GR-independent mechanisms (Di, Maxson et al. 2009; Groeneweg, Karst et al. 2011), and we propose that corticosterone potentiates cocaine actions on reinstatement behavior and dopamine levels through inhibition of OCT3-mediated dopamine clearance.

Here we have confirmed previous studies demonstrating the expression of OCT3 in the NAc (Gasser, Orchinik et al. 2009), and have demonstrated that OCT3-ir is in close proximity to cells containing tyrosine hydroxylase, the enzyme responsible for converting tyrosine to l-DOPA, the precursor to dopamine. This suggests that OCT3 is not only in areas of the brain important for reinstatement behavior, but very likely has an interaction with dopamine within this region. Further work needs to be done in order to determine the phenotype of OCT3-expressing cells within this region. Localization within astrocytes as opposed to neurons could allow a single transporter to interact with a number of synapses, magnifying the decrease in clearance when inhibited. Additionally, the localization of OCT3 would give further insight as to the proximity to dopamine receptors which may also regulate the effectiveness of the transporter.

Additionally, we have shown that administration of normetanephrine, the O-methylated metabolite of norepinephrine and potent inhibitor of OCT3 (Martel, Ribeiro et al. 1999), can potentiate the effects of a subthreshold dose of cocaine on reinstatement while having no effect when administered alone. This is in agreement with previous studies showing that peripherally administered normetanephrine could enhance acute venlafaxine-induced increases in PFC norepinephrine concentrations (Rahman, Ring et al. 2008). The results of our studies suggest that the behavioral effects of stress and corticosterone may be, at least in part, mediated by the inhibition of OCT3-mediated dopamine clearance within the NAc. Further work may need to be done, however, to confirm the role of OCT3 as normetanephrine has also been reported to act as a weak antagonist at α -adrenergic receptors (Langer and Rubio 1973). This action may in itself alter cocaine seeking in a manner that could confound the results seen here (Lee, Tiefenbacher et al. 2004). In order to further examine the role of OCT3, future studies will need to be done using a viral knockdown approach or a genetic knockout model. The use of these approaches would allow to us to examine behavior in an animal lacking any OCT3-mediated clearance and avoid the potential non-specificity of pharmacological inhibitors. Further work will also need to be done to explore the impact of other GR-independent, rapid glucocorticoid effects, including the role of the endocannabinoid system, which is also activated by elevated corticosterone levels. Examination of these other systems will aid in determining the exact role of OCT3 mediated clearance.

Taken together with previous data demonstrating corticosterone-induced potentiation of the effects of cocaine on reinstatement behavior, the data shown here suggest that inhibition of OCT3 may act to set the stage for later reinstatement. Both corticosterone and normetanephrine inhibit OCT3, a high capacity, low-affinity monoamine clearance mechanism, and this inhibition may make the system susceptible to elevations in dopamine as a result of another trigger, such as a low dose of cocaine. This would account for why administration of corticosterone or inhibition of OCT3 alone does not result in reinstatement as OCT3 may only be playing a significant role in clearance when the primary transporters (such as DAT) are saturated (see figure 4). Inhibition of OCT3 during periods of DAT saturation may lead to the elevation of the magnitude, duration and physical spread of dopamine (Grundemann, Schechinger et al. 1998). Based on these results we propose that blockade of OCT3-mediated monoamine clearance may represent a novel mechanism through which stress can influence the reinstatement of cocaine-seeking behavior.

V. ROLE OF CORTICOSTERONE AND OCT3 IN COCAINE-INTAKE DEPENDENT NEUROPLASTICITY

Introduction

The primary obstacle in the treatment of drug addiction is the unpredictable relapse that can occur even after prolonged periods of abstinence. The chronically relapsing nature of addiction is likely attributable to some level of neuroplasticity that occurs in an intake dependent manner following prolonged periods of excessive drug use. Evidence of this intake dependent neuroplasticity can be seen by altered sensitivity of rats exposed to various levels of cocaine to reinstatement. Rats provided long access (LgA; 6 hrs/day) exposure to cocaine, but not rats given short access (ShA; 2 hrs/day), escalate their drug use (Ahmed and Koob 1998) and show emergent or augmented reinstatement in response to stressors (Mantsch, Baker et al. 2008), cues (Kippin, Fuchs et al. 2006), and administration of a cocaine primer (Mantsch, Yuferov et al. 2004; Knackstedt and Kalivas 2007; Mantsch, Baker et al. 2008) compared to ShA rats, while having no effect on SA or extinction levels (figure 18). This altered susceptibility to reinstatement suggests that cocaine self-administration (SA) produces long-term intake-dependent neuroadaptations that can alter relapse vulnerability in response to a variety of stimuli. Gaining a greater

understanding of 1) the nature of the intake-dependent neuroplasticity that contributes to heightened relapse and drug use and 2) the mechanisms through which this neuroplasticity is put in place may aid in the advancement of treatment for cocaine addiction.

Another adaptation seen following excessive cocaine intake is an increase in CRF-induced reinstatement. Direct administration of the neuropeptide CRF into the brain results in the reinstatement of cocaine seeking (Erb, Petrovic et al. 2006; Mantsch, Baker et al. 2008). CRF also mediates stress-induced reinstatement as reinstatement can be blocked with pretreatment of CRF receptor antagonists prior to exposure to the stressor (Erb, Shaham et al. 1998; Graf, Hoks et al. 2011). Like reinstatement to other stimuli, CRF-induced reinstatement is augmented in LgA rats (Mantsch, Baker et al. 2008). Notably, in one key site, the VTA, delivery of CRF will only reinstate in rats with a history of LgA cocaine SA (Blacktop, Seubert et al. 2011). The actions of CRF in the VTA are likely due to increases in dopamine concentrations as it has been reported that administration of CRF to the VTA increases VTA dopamine cell firing (Wanat, Hopf et al. 2008) as well as stimulates dopamine-related behaviors, such as drug seeking (Wang, Shaham et al. 2005). Additionally, EFS-induced reinstatement in LgA rats is blocked following administration of a dopamine receptor antagonist (Figueroa-Guzman, Mueller et al. 2011), suggesting that stress-induced reinstatement, which is CRF-dependent, likely involves enhanced dopaminergic neurotransmission.

The goals of this chapter are to 1) examine the potential role of augmented dopamine neurotransmission due to the altered expression of OCT3 in augmented reinstatement and 2) to determine if elevated corticosterone during SA also represents a mechanism through which intake-dependent cocaine-induced neuroplasticity is put into place, potentially via the monoamine transporter, organic cation transporter 3 (OCT3).

To address the first goal, we examined the effect of both LgA and ShA cocaine exposure on the expression of a specific monoamine transporter, OCT3. Considering its role in regulating cocaine seeking, we hypothesized that intake-dependent alterations in OCT3 expression following LgA SA could account for the augmented reinstatement seen in these rats. OCT3 is a high capacity, uptake² transporter involved in the clearance of dopamine as well as other monoamines and is directly inhibited by corticosterone (Grundemann, Schechinger et al. 1998; Grundemann, Liebich et al. 1999). Previous work we have done (chapters 1-3) suggests that OCT3 is involved in the regulation of extracellular dopamine levels and inhibition of OCT3-mediated clearance may make an individual susceptible to reinstatement to other triggers. Based on this work, we examined the expression of OCT3 in both the NAc and PFC, regions known to be involved in the reinstatement of drug seeking (Wise, Murray et al. 1990; Self, Barnhart et al. 1996; Vialou, Balasse et al. 2008; Gasser, Orchinik et al. 2009). We propose that OCT3 expression may be altered in animals undergoing LgA cocaine exposure compared to animals with ShA exposure. This change in OCT3 expression may alter the ability to regulate dopamine concentrations within the brain and may represent one example of

cocaine-induced neuroplasticity that could represent an explanation for the intake dependent variations in reinstatement. OCT3 mRNA and protein levels will be examined in both the NAc and PFC in animals exposed to LgA SA, ShA SA and saline treatment.

In addition to acutely regulating cocaine seeking as demonstrated in chapter 2, there is much evidence that elevated corticosterone is critical for cocaine-induced neuroadaptations. Surgical adrenalectomy prior to LgA SA slows escalation of cocaine intake and attenuates the later reinstatement seen in intact rats (Mantsch, Baker et al. 2008). Also, blockade of corticosterone synthesis with metyrapone blocks cocaine-induced sensitization that occurs following repeated administration of the drug (Piazza, Marinelli et al. 1996). This implicates the need for cocaine-induced elevations in glucocorticoids in order to establish the neuroplasticity required for the augmentations in reinstatement behavior.

Elevations of corticosterone in response to cocaine SA vary depending on the level of drug intake. ShA and LgA exposure to cocaine increase plasma corticosterone to similar peak concentrations, however, LgA cocaine exposure sustains this elevation for greater duration each SA day (Mantsch, Yuferov et al. 2003). These findings raise the possibility that the neuroplasticity responsible for augmented reinstatement in LgA rats may be due to a prolonged elevation in corticosterone levels.

Several studies have examined the role of hormonal stress responses in addiction-related neuroplasticity (Kreek and Koob 1998; Koob and Kreek 2007).

Our lab has demonstrated that the adrenal response is necessary at the time of SA in order to establish the plasticity that is required to result in elevated cocaine seeking (Mantsch and Katz 2007; Mantsch, Baker et al. 2008). It has also been discovered that the elimination of cocaine-induced adrenal activity during SA prevents later stress- and cocaine-induced sensitization (Rouge-Pont, Marinelli et al. 1995; Prasad, Ulibarri et al. 1996; Przegalinski, Filip et al. 2000). Here we examine the role of adrenal activity in later i.c.v. CRF- and footshock-induced reinstatement by performing an adrenalectomy with corticosterone replacement (ADX/C) prior to 2 weeks of LgA cocaine SA. The reinstatement behavior of these rats was compared to those in which ADX/C was performed following the SA period, allowing cocaine-induced plasticity to occur, but before extinction and reinstatement testing.

Previously, it has been demonstrated that cocaine-induced elevations in corticosterone during LgA SA are necessary for the emergence of later augmented cocaine-induced reinstatement (Mantsch, Baker et al. 2008). In this study, surgical adrenalectomy with diurnal corticosterone replacement prior to, but not after repeated (14 day) cocaine SA prevented the augmentation of reinstatement seen in intact rats. This suggests that elevated corticosterone is necessary for the establishment of neuroplasticity that leads to heightened relapse. Since it has been previously shown that LgA SA also establishes the ability of EFS to reinstate and augments reinstatement in response to CRF (Mantsch, Baker et al. 2008), the goal of this experiment was to extend our previous findings showing corticosterone involvement in increased cocaine-induced reinstatement to EFS and CRF. Future

studies will need to be performed in order to examine the potential role of OCT3 in the corticosterone effects.

Materials and Methods

Subjects

Male Sprague-Dawley rats (Harlan Laboratories, St. Louis, MO), approximately 90 days old (325 g) were used. Rats were housed individually in a temperature and humidity-controlled, AAALAC-accredited facility under a 12h/12h reversed light cycle (lights off at 0700 hours) and had access to food and water at all times.

Jugular catheterization.

Rats received indwelling jugular catheters under ketamine/xylazine (100 mg/kg; 2 mg/kg, ip) anesthesia as previously described in chapters 1-3. Lines were connected to syringe pumps (Razel, Stamford, CT) via fluid swivels (Instech Lab. Inc., Plymouth Meeting, PA) suspended above the chambers. Swivel/leash assemblies were balanced to permit unrestrained movement.

Self-Administration and Extinction

Following recovery from surgery, rats were trained to self-administer cocaine (1.0 mg/kg/inf, i.v., NIDA Drug Supply Program, Bethesda, MD) by pressing a lever under an FR1 schedule during 2-hour sessions, within which the active lever was extended into the chamber and the corresponding stimulus light was illuminated. Pressing this lever resulted in a cocaine infusion (200 μ l over 5.0 s),

followed by a 25 s period during which the stimulus light was extinguished, but the lever remained extended. Inactive lever responding was recorded, but had no programmed consequences. Once significant SA under the FR1 schedule was observed (>10 infusions), the requirements for SA were gradually increased until rats were self-administering under an FR4 schedule. After stable responding was observed under the FR4 schedule (<10% variation from mean over three sessions), rats underwent ADX/C or sham procedures and/or were provided access to cocaine during 6-hour (long access) sessions for 14 days.

Experiment 1. Effects of cocaine SA on expression of OCT3. To examine intake-dependent changes in the expression of OCT3 following exposure to cocaine, we used both western blot and quantitative real time polymerase chain reaction (qPCR). Rats received jugular catheters and after recovery from surgery, were allowed to SA under with either long access (LgA, 6-hours daily) or short access (ShA, 2-hours daily) exposure to cocaine. An additional group received only saline for the 14 day testing period with all groups undergoing 10 days of extinction testing under 2 hour conditions. Following SA and extinction, rats were sacrificed and brains were dissected on ice. Tissue punches (2 mm in diameter) were obtained from the NAc (core and shell) and PFC (Il and PrL), then immediately frozen in dry ice and stored at -80°C until the experiments were performed (see figure 16).

Total RNA and protein were isolated from the punches using TRIzol reagent (Life Technologies). Isolated RNA samples were quantified spectrophotometrically

at 260 nm. RNA (1.2 µg/reaction) was used for cDNA synthesis using Promega Reverse Transcription System. To analyze OCT3 mRNA levels, quantitative PCR was used with gene-specific primers (rOCT3 Sense: 5'- CCA CCA TGA GCC AGT TT - 3'; rOCT3 Antisense- 5'-ACA CGA CAC CCC TGC CAC TA -3'). Real-time PCR amplification reactions were performed with Quanta SYBR Green Fastmix Rox. Reactions were run on an Applied Biosystem Step One Real Time PCR System according to the manufacturer's protocol.

Protein used for electrophoresis and western blot was also isolated using TRIzol reagent. Protein concentrations were determined using the BCA protein assay (Pierce, Rockford, IL). Approximately 25 µg of protein was electrophoresed on a tris-glycine SDS 10% polyacrylamide gel. Proteins were then electroblotted onto polyvinylidene difluoride (PVDF) membrane (Invitrogen, La Jolla, CA) using a semidry blotting apparatus. Membranes containing identical amounts of protein were incubated for 1 hour in Tris-buffered saline containing 0.1% Tween-20 (TBST) and 5% nonfat dry milk. They were then rinsed and incubated overnight at room temperature in TBST containing anti-OCT3 antiserum (Isolated from rat; catalog No. OCT31-A, lot No. 401516A3.3; ADI; 1:1000 in 2% milk). After rinsing, membranes were incubated for 1 hour in TBST containing secondary antibody (horseradish peroxidase (HRP)-conjugated goat anti-rabbit IgG; 1:10000) and 2% milk. Membranes were then rinsed and incubated with chemiluminescent substrate (SuperSignal West Femto; Pierce) and digital images were captured. Bands representing OCT3 were expected ~48-53 kD (Gasser, Orchinik et al. 2009). OCT3

bands were compared to bands representing GAPDH in order to control for variations in amount of protein loaded.

Experiment 2: Role of elevated corticosterone during LgA cocaine SA in the augmentation of later reinstatement.

In these experiments we examined the effect of adrenalectomy on later reinstatement to different stimuli in order to determine the role of corticosterone during SA on later reinstatement.

Experiment 2A. Effects of adrenalectomy and corticosterone replacement on footshock-induced reinstatement. To examine the potential role of corticosterone in the establishment and expression of footshock-induced reinstatement, rats underwent bilateral ADX via the dorsal approach under ketamine and xylazine anesthesia and received corticosterone replacement (ADX/C) (Mantsch and Katz 2007) before or after 14 days of cocaine SA or received sham operations. Diurnal corticosterone replacement consisted of s.c. implantation of a 25% corticosterone (Sigma-Aldrich) pellet in the nape of the neck to produce blood concentrations similar to those found at the nadir of the diurnal cycle along with the inclusion of 0.025% corticosterone in the drinking water to emulate the circadian peak observed during the active (dark) phase, within which most drinking occurs (Jacobson, Akana et al. 1988). Pellets were made by melting a 1:3 corticosterone:cholesterol ration mixture over a flame and pouring it into a mold, creating a 1.5 X 0.5 X 0.5 cm³ (l X w X h) pellet (Meyer, Micco et al. 1979).

Corticosterone was dissolved in ethanol before introduction into the drinking water, resulting in a final ethanol concentration of 1 ml/L (0.0001%). To replace depleted sodium secondary to the loss of aldosterone as a result of ADX, drinking water for all rats (ADX/C and sham) consisted of 0.9% NaCl solution. Corticosterone pellets were replaced every seven days under sodium methohexital (1.5 mg, i.v.) sedation. Sham rats were implanted with 100% cholesterol pellets. Sham operations were identical to ADX surgeries, except that, once exposed, the adrenal glands were not removed. Before undergoing ADX/C or sham procedures, rats were trained to self-administer cocaine during 2 hour sessions. After recovery, rats were allowed to self-administer again until stable patterns were re-established, at which time long-access SA began, followed by extinction and testing for footshock-induced reinstatement. A third group of rats were used to examine the effects of ADX/C after SA, but before extinction on later footshock-induced reinstatement. These rats underwent the ADX/C procedure after 14 days of SA and were allowed to recover before the 10-day extinction period and reinstatement testing.

Experiment 2B. Effects of adrenalectomy with corticosterone replacement on

CRF- and EFS-induced reinstatement. ADX/C effects on reinstatement by i.c.v.

CRF were tested in a separate group of rats implanted with a cannula into a lateral ventricle at the time of catheterization. Following recovery from surgery and SA training, these rats underwent ADX/C or sham operations before SA and extinction.

After extinction, each rat was tested for reinstatement in response to two concentrations of CRF and sterile water vehicle in counterbalanced sequence.

During the reinstatement testing rats received and i.c.v. 1- μ l infusion of CRF (0.5 or

1 µg; Sigma-Aldrich) or vehicle over a 1 minute period 15 minutes before placement into chambers for 2 hours (Mantsch, Baker et al. 2008). A third group of rats underwent ADX/C after 14-days of SA and, following a 3-4 day recovery period, went through 10 days of extinction before testing for CRF-induced reinstatement. In all cases, rats with confirmed injection sites outside the lateral ventricle were excluded from data analyses.

To examine the role of the adrenal response in the establishment and expression of footshock-induced reinstatement, rats underwent bilateral ADX under ketamine and xylazine anesthesia and received ADX/C before or after 14 days of cocaine SA or received sham treatments. All rats underwent SA training prior to surgery and those receiving ADX/C prior to SA were allowed to recover from surgery and demonstrate consistent lever-pressing behavior before beginning the 14-day SA period. Those receiving ADX/C post-SA, were allowed to recover from surgery and then began extinction testing.

EFS testing was performed after extinction criteria had been met (<~10 responses/2 hr session). EFS was delivered through the stainless steel grid floors of the SA chambers 15-min. prior to the 2 hr. testing session, which was otherwise identical to extinction conditions. Shocks (0.5 mA, 0.5 seconds in duration) were delivered an average of every 40 seconds, with a range of 10-70 second. Reinstatement was defined as responding on the previously active lever and compared to the preceding extinction session.

Measurement of Plasma Corticosterone

When possible, blood (100 μ l per sample) was acquired via the catheters for the measurement of plasma corticosterone under basal conditions and during SA. Samples were collected before (at 0800 hours, just after the start of the dark phase) and after the 6-hour SA sessions (at 1400 hours) and at the corresponding baseline time points. In addition, samples were acquired after 2 hours of SA (at 1000 hours) and at the corresponding baseline time points from a separate group of rats for examination of corticosterone at an earlier time during the SA sessions. The days on which blood samples were taken varied across the 14-day test period such that about half of the rats were sampled during the first seven days and the other half during the final seven days of SA. In addition, 12 rats (six ADX/C and six sham) implanted with a lateral ventricle cannula were used to examine the plasma corticosterone responses to footshock and i.c.v. CRF. These rats underwent i.c.v. cannula implantation and ADX/C or sham procedures before testing for footshock- and CRF-induced corticosterone responses. Corticosterone was measured using radioimmunoassay kits (MP Biomedicals, Irvine, CA). Blood was collected on ice in tubes containing heparin and centrifuged to separate plasma, which was frozen at -80°C. Samples were analyzed in duplicate.

Results

Experiment 1: Effects of cocaine exposure on OCT3 expression

Figure 16 illustrates the effects of cocaine SA (ShA and LgA) on the expression of OCT3. qPCR was used to detect changes in mRNA levels and western

blot was used to detect changes in protein measured after 10 days of extinction, a time point that corresponds to that at which heightened reinstatement was previously observed (Mantsch, Baker et al. 2008; Mantsch, Baker et al. 2008). Our findings show that there is no statistically significant difference in mRNA expression between rats exposed to either ShA or LgA SA conditions when compared to saline controls (One-way ANOVA; NAc $p=0.3443$; PFC $p=0.2963$). Interestingly however, there is a significant increase in OCT3 protein expression in the PFC in rats with a history of LgA SA (One-way ANOVA with unpaired t-test; $p=0.01$). While there appears to be a slight increase in OCT3 protein in the NAc in LgA, it is not statistically significant (One-way ANOVA; $p=0.6101$).

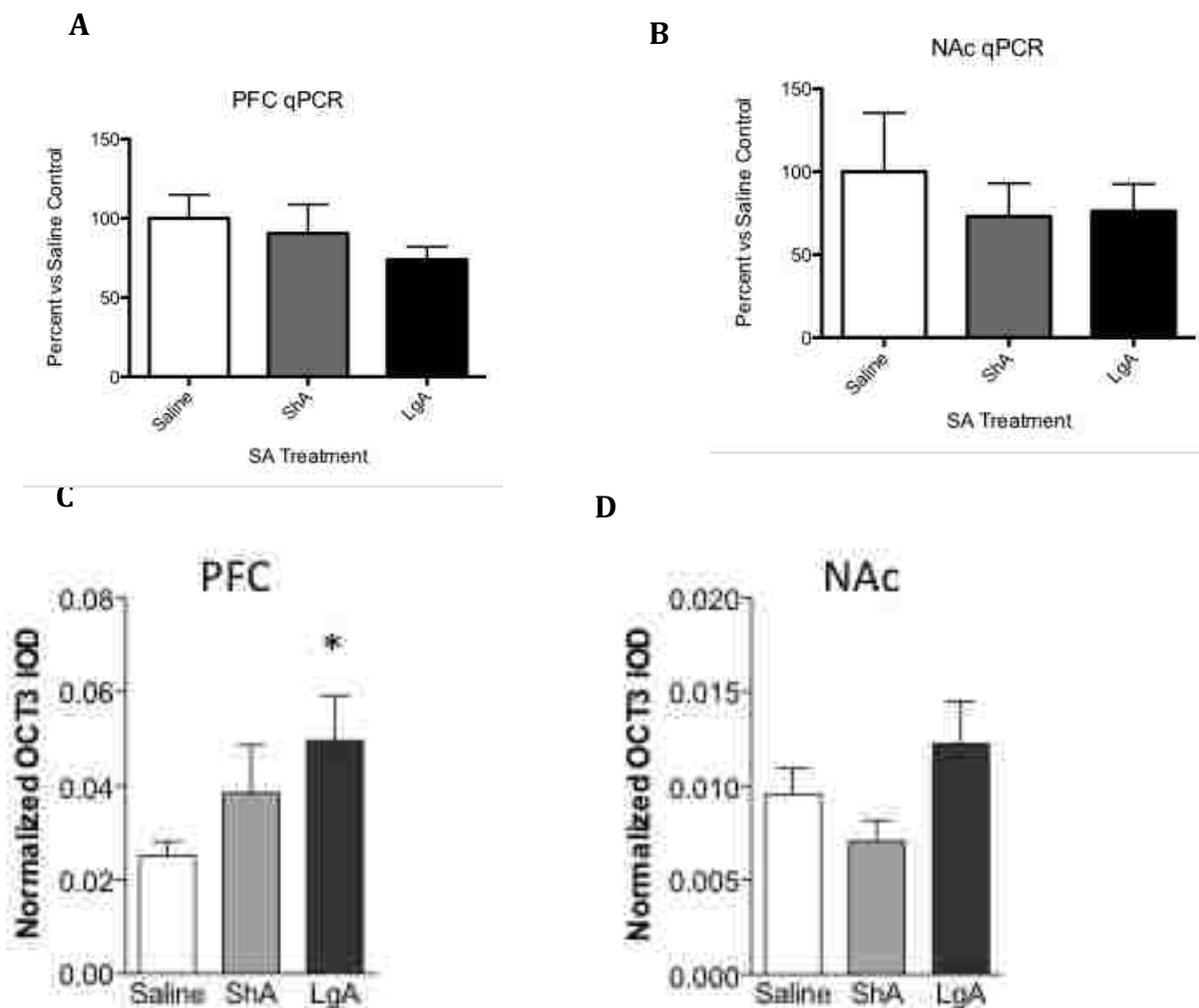

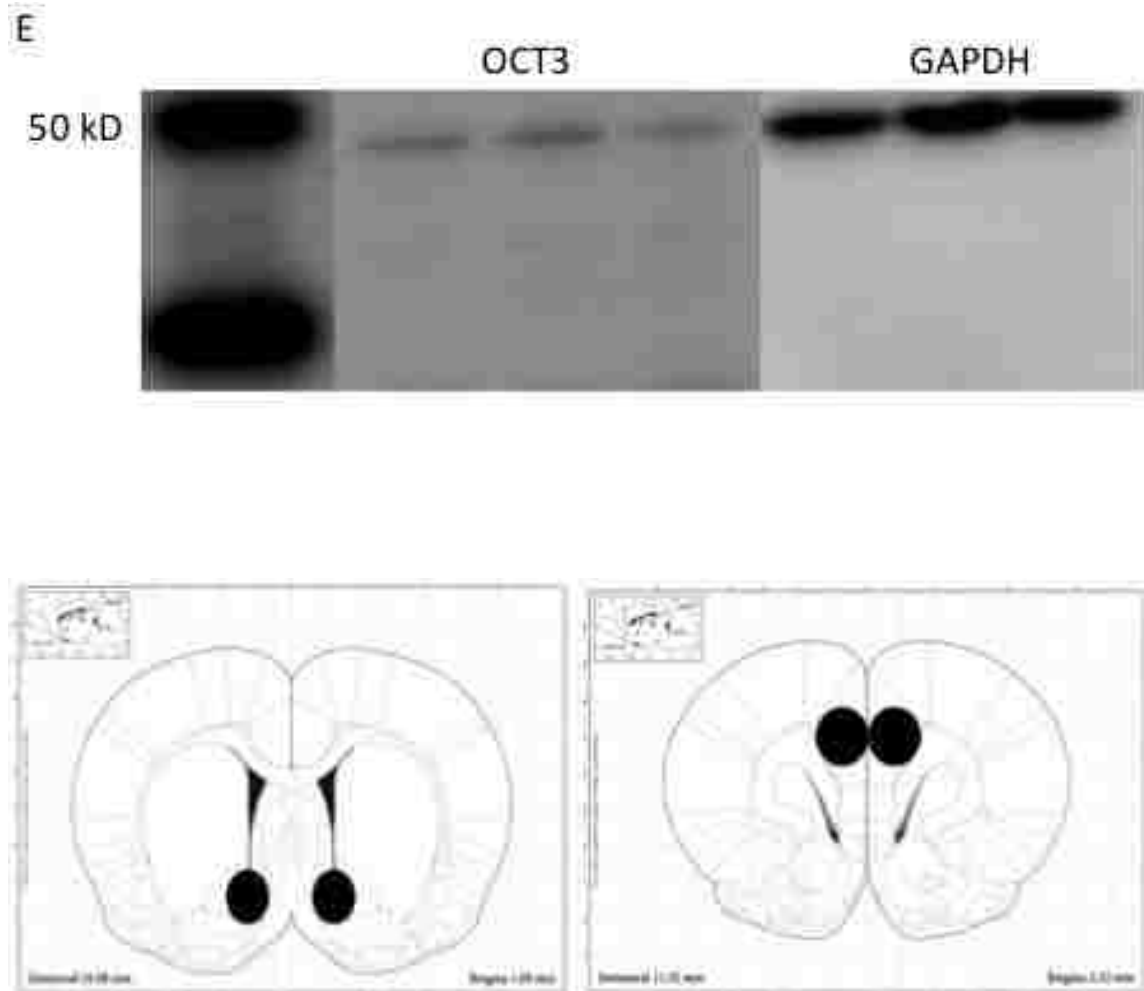

Figure 16. Effects of cocaine SA (ShA and LgA) on OCT3 mRNA and protein levels. OCT3 mRNA levels in the NAc (A) and PFC (B) are expressed as a percentage relative to saline controls. Data were analyzed using the $\Delta\Delta C_T$ method and are represented as mean \pm SE. No statistically significant difference was found although there is a trend suggesting cocaine exposure results in a decrease in OCT3 mRNA in both regions examined. OCT3 protein examined using western blot analysis in the NAc (C) and PFC (D). No statistically significant difference was found, although there again appears to be a trend toward cocaine-dependent decrease in OCT3 protein in the PFC. A representative western blot showing a OCT3-ir band at \sim 48 kD (E). Also shown: representation of punches taken from NAc (left) and PFC (right).

Experiment 2: Role of elevated corticosterone during LgA cocaine SA in the augmentation of later reinstatement.

SA-Induced increases in plasma corticosterone.

Figure 17 shows the SA-induced increases in plasma corticosterone in sham treated and ADX/C rats. As we did not acquire samples from every rat in each group at each time point, we used a 3 X 3 two-way independent measures ANOVA to examine corticosterone at three time points corresponding to the times just before SA testing (0800 hours), 2 hours into SA testing (1000 hours), and just after the 6 hour session (1400 hours) under basal conditions and in response to SA. The ANOVA did not show a significant overall effect of time-of-day, although a clear diurnal pattern of corticosterone fluctuation was observed under basal conditions in sham treated rats with peak levels at 0800 hours corresponding to the start of the dark phase, and the low point at 1400 hours, 6 hours into the dark phase. A significant overall effect of treatment condition (baseline vs sham SA vs ADX/C SA; $F_{2,182}=9.566$; $P<0.0001$) and a significant treatment condition X time-of-day interaction ($F_{4,186}=5.152$; $P<0.001$) were observed. Comparison across treatments using one-way ANOVA at each of the three times revealed significant main effects at the 1000 hours ($F_{2,30}=3.850$; $P<0.05$), but not the 0800 hours (pre-SA), time point. Overall, corticosterone levels were significantly higher in sham-treated rats during SA compared with basal conditions ($P<0.001$). SA-induced increases in corticosterone were prevented by ADX/C treatment. Corticosterone levels were

significantly reduced during SA in ADX/C rats compared with sham-treated controls ($P < 0.05$). By contrast, corticosterone levels in ADX/C rats during SA did not differ from basal values in sham-treated rats. At the 1400 hours time point, corticosterone levels in self-administering sham rats were also significantly higher than that during sham baseline conditions ($P < 0.05$). However, the difference between sham and ADX/C SA rats at this time point did not reach statistical significance.

Figure 18 demonstrates the effect of the three ADX/C conditions, sham ($n=28$), rats that underwent ADX/C prior to LgA SA ($n=30$; pre-SA ADX) and those who underwent ADX/C after LgA SA ($n=24$; post-SA ADX), on LgA SA as well as extinction. Two-way ANOVA showed a significant overall main effect of SA day ($F_{13,1027}=10.400$; $P < 0.001$) and ADX condition ($F_{2,79}=4.605$; $P < 0.05$), but did not show a significant SA day x ADX condition interaction (Figure 18a). SA was increased on days 4-14 compared to day 1 ($P < 0.05$) and, overall, SA was slightly, but significantly, reduced in rats that underwent ADX/C before SA compared with rats that underwent ADX/C post-SA ($P < 0.05$), but not when compared with sham controls.

The effects of pre-SA ADX/C, post-ADX/C and sham treated animals is shown in figure 18b,c. Two-way ANOVA showed significant main effects of extinction day (repeated measure; $F_{9,711}=67.704$; $P < 0.0001$) and ADX condition ($F_{9,79}=7.29$; $P < 0.001$), but no ADX condition x extinction day interaction. Overall, responding was significantly lower in pre-SA ADX rats when compared to sham treated and

post-SA ADX rats, suggesting that adrenal activity at the time of cocaine SA, but not during extinction itself, contributed to drug-seeking behavior during the extinction sessions.

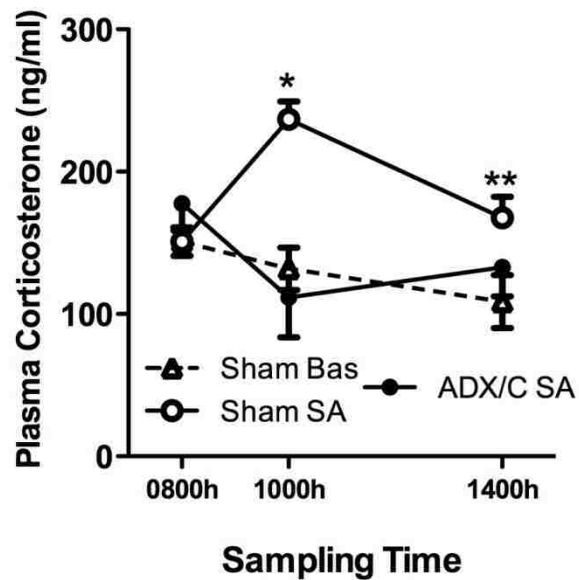

Figure 17. Plasma corticosterone (CORT) (ng/ml \pm SE) measured at 0800 hours (time corresponding to the start of daily SA session), 1000 hours (time corresponding to a point 2 hours into SA session), and 1400 hours (time corresponding to completion of SA session) in sham-treated rats under basal conditions (Sham Baseline) or during SA (Sham SA) or in ADX/C treated rats during SA (ADX/C SA). In sham-treated rats, cocaine SA increased plasma corticosterone relative to basal levels. During SA, ADX/C rats showed corticosterone levels that were similar to baseline levels and significantly lower than levels during SA in sham-treated rats (* $P < 0.001$ vs sham baseline and ADX/C SA; ** $P < 0.05$ vs sham SA only).

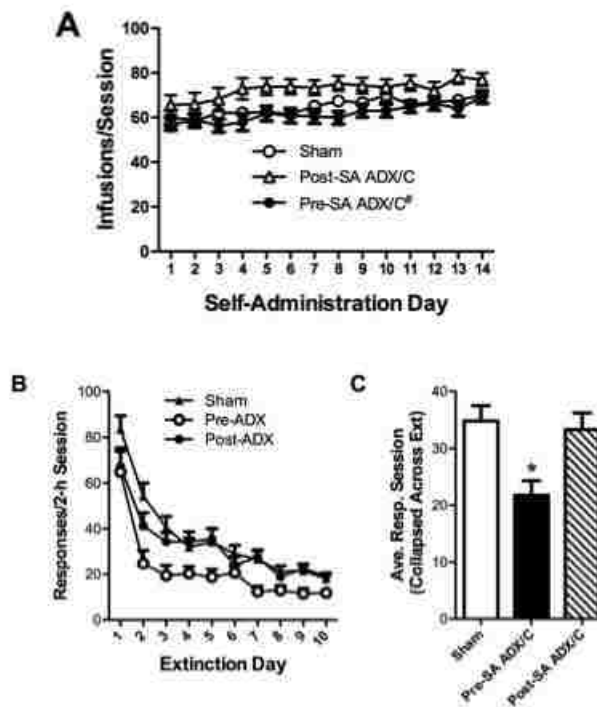

Figure 18. Cocaine SA and extinction in sham and adrenalectomy with diurnal corticosterone replacement (ADX/C)-treated rats. Data in (A) represent intravenous cocaine SA (LgA; 6 hours/day) in rats that underwent adrenalectomy and diurnal corticosterone replacement before 14 days of SA testing (pre-SA ADX/C; $n=30$) or after 14 days of SA, but before extinction and reinstatement testing (post-SA ADX/C; $n=24$) or underwent a sham treatment ($n=28$). Significant escalation of SA was observed in all groups and, overall, SA was reduced in pre-SA ADX/C rats relative to post-SA ADX/C, but not sham-treated rats ($\#p<0.05$). Data in (B) and (C) represent responding during extinction shown as daily responding during each of the days of extinction (responses/2-hour session \pm SE; A) or total responding collapsed across all 10 days (\pm SE; B). Overall, extinction responding was significantly decreased in pre-SA ADX/C rats compared with either post-SA ADX/C rat or sham-treated controls ($*p<0.05$; B).

Experiment 2A. Effects of adrenalectomy and corticosterone replacement on footshock-induced reinstatement.

We previously reported that EFS-induced reinstatement is established by LgA SA. Here we examined the effects of ADX/C on footshock-induced reinstatement in rats that underwent ADX/C before 14 days of long-access SA (n=18), rats that underwent ADX/C after 14 days of SA, but before extinction and reinstatement (N=15), and sham-treated rats (n=16), data shown in figure 19. A two-way footshock reinstatement X ADX condition ANOVA that included rats from all three ADX groups (sham, pre-SA ADX/C and post-SA ADX/C) showed significant main effects of shock ($F_{1,46}=27.730$; $P<0.001$) and ADX treatment ($F_{2,46}=3.768$; $P<0.05$) on cocaine seeking as well as a significant interaction between footshock and ADX treatment ($F_{2,46}=3.231$; $P<0.05$). Post hoc testing showed that significant footshock-induced reinstatement occurred in sham-treated and post-SA ADX/C, but not pre-ADX/C rats ($P<0.05$ vs extinction). Further, footshock-induced lever pressing was significantly reduced in pre-SA ADX/C, but not post-SA ADX/C rats, compared with sham controls ($P<0.01$), even though responding under extinction conditions was not different.

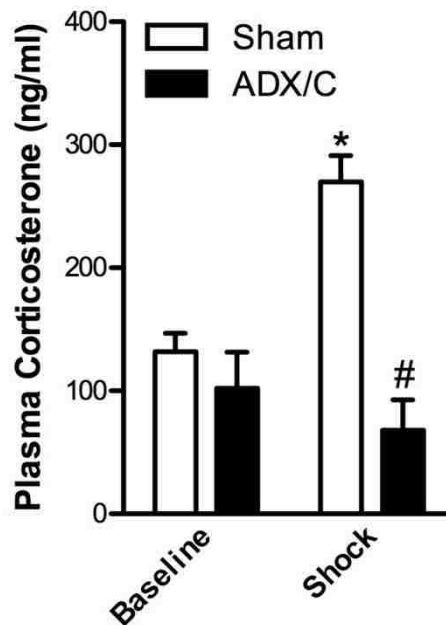

Figure 19. Responding during the reinstatement sessions preceded by 15 minutes of intermittent electric footshock or during the preceding extinction session in pre-SA ADX/C (n=18), post-SA ADX/C (n=15) and sham-treated (n=16) rats following LgA SA. Footshock-induced reinstatement was prevented by ADX/C before (pre-SA ADX/C), but not after (post-SA ADX/C) LgA cocaine SA (*significant reinstatement, $P < 0.05$ vs extinction; #significant decrease vs sham, $P < 0.05$).

Experiment 2B: Effects of adrenalectomy with diurnal corticosterone replacement on CRF-induced reinstatement.

We have previously reported that, like footshock, reinstatement by i.c.v. CRF is augmented after LgA SA (Mantsch, Baker et al. 2008). Figure 20, depicts the role of adrenal activation at the time of earlier SA on later CRF-induced reinstatement. The effects of ADX/C on CRF-induced reinstatement were examined in 12 rats that underwent ADX/C before 14 days of SA, 9 rats that underwent ADX/C after 14 days

of SA, but before extinction and reinstatement and 14 sham-treated rats. Two-way CRF X ADX condition ANOVA showed significant main effects of CRF delivery ($F_{2,60} = 5.396$; $P < 0.01$) and ADX condition ($F_{2,30} = 3.382$; $P < 0.05$), but did not show a significant CRF X ADX condition interaction. Post hoc testing showed overall dose-dependent reinstatement by CRF, with significant reinstatement observed at the 0.5 μg dose ($P < 0.05$), but not the 1.0 μg dose ($P = 0.058$), when compared with vehicle pretreatment. Overall, reinstatement was significantly reduced in the pre-SA ADX/C group compared to the sham-treated group ($P < 0.05$), but not in the post-SA ADX/C group. To determine if CRF induced reinstatement in each of the ADX groups, a planned analysis of reinstatement was conducted using one-way repeated measures ANOVA within each ADX group. Significant dose-dependent CRF-induced reinstatement was found in sham-treated ($P < 0.01$) vs vehicle), but not pre- or post-SA ADX/C rats.

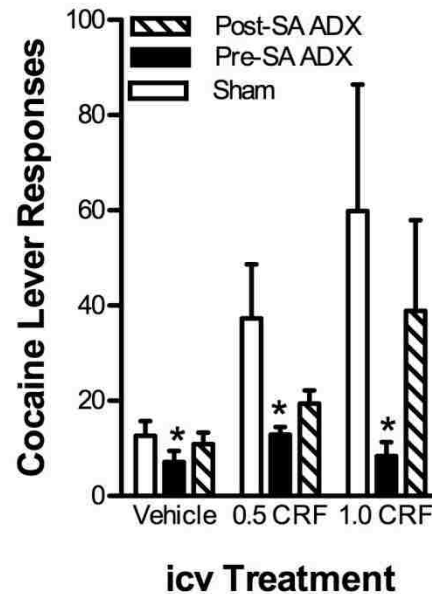

Figure 20. CRF-induced reinstatement in sham and ADX/C rats. Data shows responding during the reinstatement sessions preceded by i.c.v. injections of CRF (0.5 or 1 μ g) or vehicle in pre-self-administration (pre-SA) ADX/C (n=12), post-SA ADX/C (n=9) and sham-treated (n=14) rats following LgA SA. Overall, CRF-induced reinstatement was reduced by ADX/C before (pre-SA), but not after (post-SA) LgA cocaine SA compares with sham-treated rats (*significant overall decrease vs sham; $P < 0.05$).

Discussion

Previous work demonstrated that LgA exposure to cocaine results in the formation of addiction-related neuroplasticity. This can be seen in studies in which rats with a history of LgA SA demonstrate augmented reinstatement in response to cocaine (Mantsch, Yuferov et al. 2004; Knackstedt and Kalivas 2007; Mantsch, Baker et al. 2008), EFS, CRF (Mantsch, Baker et al. 2008) and cues (Kippin, Fuchs et al.

2006). The changes that result in the augmented vulnerability to reinstatement, as well as how these changes are put into place, remain poorly understood. The studies performed here aim to gain a better understanding of this process and the mechanism responsible.

One potential mechanism that may explain the intake-dependent neuroplasticity is alterations in expression of the monoamine transporter, OCT3. OCT3 is a high capacity dopamine transporter that has been shown to be involved in the regulation of cocaine seeking (see chapters 1-3). Earlier we showed that inhibition of OCT3 expression could reduce dopamine clearance efficiency and may result in an increase in susceptibility to reinstatement. We propose that cocaine intake-dependent decreases in OCT3 expression may represent one mechanism through which excessive cocaine intake alters later reinstatement.

Our results do not show any cocaine-induced reduction in OCT3 expression in either the PFC or NAc as measured using qPCR (mRNA) or western blot (protein). However, we did observe an increase in PFC protein expression following LgA SA, but no change in NAc protein expression. As a corticosterone-sensitive transporter, an increase in expression may have allowed for elevations in corticosterone to exert a greater impact as more OCT3-mediated dopamine clearance would be inhibited, which would be in agreement with the emergence of EFS-induced reinstatement in LgA rats. However, ADX had no effect on cocaine-induced reinstatement in LgA rats suggesting that a decrease in OCT3 expression may result in increased vulnerability to escalations in dopamine as the secondary, uptake₂-mediated clearance

mechanism would be diminished. Our findings, however, were not consistent with this hypothesis, suggesting that changes in OCT3 expression may not be involved in cocaine intake-dependent neuroplasticity.

The work done here also examined the mechanism through which the intake-dependent neuroadaptations occur. Previous reports have demonstrated that administration of cocaine elevates plasma corticosterone levels (Moldow and Fischman 1987; Mantsch, Yuferov et al. 2003; Mantsch, Cullinan et al. 2007). Here we demonstrated that these cocaine-induced elevations of corticosterone are prolonged in rats undergoing LgA SA. We then examined the role of these corticosterone elevations in the formation of the intake-dependent neuroplasticity. We examined the effect of adrenalectomy with diurnal corticosterone replacement prior to cocaine SA or after SA, but prior to reinstatement testing, in order to determine the role of corticosterone in the establishment of cocaine-induced neuroplasticity. Our findings indicate that adrenalectomy prior to the start of SA sessions slightly, but significantly alters cocaine intake and extinction and has substantial influence on later reinstatement. It is important to note, however, that sham treated animals had a slight decrease in SA that was not statistically significant, suggesting that the surgical procedure itself may have some impact on the behavior. Animals receiving the adrenalectomy prior to LgA SA do not exhibit reinstatement behavior in response to EFS or ICV CRF compared to those receiving adrenalectomy after LgA SA, but prior to reinstatement testing. This suggests that increased corticosterone is required at the time of LgA SA, but not at the time of reinstatement testing in order to produce the intake-dependent alterations in

reinstatement. This is consistent with previous reports indicating that adrenalectomy prior to LgA SA augments later cocaine-induced reinstatement (Mantsch, Baker et al. 2008) as well studies showing adrenalectomy prior to repeated stress blocks stressor-induced facilitation of cocaine SA (Goeders and Guerin 1996; Mantsch, Saphier et al. 1998) and stressor-induced locomotor sensitization (Rouge-Pont, Marinelli et al. 1995; Prasad, Ulibarri et al. 1998). Together, these data indicate that elevations in corticosterone are involved in the establishment of neuroplasticity that alters later behavioral responses, but are not required at the time of stress-induced reinstatement.

One interesting finding in our experiments was the lack of effect of surgical adrenalectomy post-SA, but prior to reinstatement testing. The results of the work done in the previous chapters using ShA rats shows acute, stress-induced increases in corticosterone at the time of reinstatement testing potentiate the reinstatement response to other stimuli. In these studies corticosterone-induced OCT3 inhibition appears to act as a stage setter, making the individual more susceptible to reinstatement, however corticosterone itself is not mediating reinstatement. The lack of a corticosterone requirement in LgA rats for reinstatement suggests that the neuroadaptations that occur during LgA SA alter the system in such a way that acute increases in corticosterone are not necessary. This, again, is another example for why we examined the expression of OCT3 following excessive cocaine intake.

While our current findings strongly implicate a role for corticosterone in cocaine intake-dependent neuroplasticity, it is important to note that other adrenal

hormones may be involved. Surgical adrenalectomy prevents the release of all adrenal hormones, not just corticosterone, and these other hormones may be involved in the behaviors seen following LgA cocaine exposure. Previous work has shown the ability corticosterone in combination with epinephrine to restore cocaine-induced sensitization that was diminished through ADX (de Jong, Steenbergen et al. 2009). This work suggests that there may be role for epinephrine, as well as corticosterone, in the establishment of cocaine-induced neuroplasticity and further examination is required in order to determine the role of epinephrine or other adrenal hormones in the results presented here.

The neuroadaptations put in place by excessive cocaine intake may be put in place through a variety of mechanisms. One potential mechanism is that sustained elevations of corticosterone may result in neuroplasticity through interactions with the glucocorticoid receptor (GR). Corticosterone is a substrate for GR and upon activation GR translocates into the nucleus of the cell and is involved in the regulation of transcription and translation for a large number of genes (Reul and de Kloet 1985; Datson, van der Perk et al. 2001; Deroche-Gamonet, Sillaber et al. 2003). Previous research has demonstrated that mice lacking GR activity within the central nervous system retain normal function in the periphery, but demonstrate altered cocaine SA dose-response behavior, but not acquisition behavior, and have blunted cocaine-induced behavioral sensitization (Deroche-Gamonet, Sillaber et al. 2003). These results strongly implicate GR involvement in establishing the neuroplasticity that forms as a result of long-term exposure to cocaine. Enhanced GR activation in LgA rats may result in alterations in the expression of multiple genes that could be

involved in the regulation of later reinstatement. Additionally, elevated levels of corticosterone may increase the inhibition of transporters, including OCT3, and lead to changes in expression through chronic inhibition. While our results do not show any decrease in OCT3 expression following cocaine exposure, and even show a slight increase in protein levels, further work will need to be done in order to confirm our findings and further explore the effect increased OCT3 expression may have.

GENERAL DISCUSSION

SUMMARY OF FINDINGS

Chapter 1:

Exposure to electric footshock prior to systemic administration of a subthreshold, non-reinstating dose of cocaine (2.5 mg/kg, i.p.) results in reinstatement of cocaine seeking. This effect is blocked in animals that have undergone adrenalectomy, which indicates the behavior requires stress-induced increases in corticosterone. The effects of electric footshock on reinstatement are mimicked by systemic administration of stress levels of corticosterone prior to administration of the subthreshold dose of cocaine. The corticosterone effect is not blocked by administration of the glucocorticoid receptor antagonist, RU38486, suggesting corticosterone is acting through a glucocorticoid receptor-independent mechanism.

Chapter 2:

Administration of corticosterone directly into either the NAc or PFC prior to administration of a subthreshold dose of cocaine (2.5 mg/kg, i.p.) results in reinstatement not seen with administration of cocaine alone at this dose. Systemic administration of stress level corticosterone prior to administration of a low dose of cocaine enhances cocaine-induced increases in extracellular dopamine concentrations in the NAc. Administration of the dopamine antagonist fluphenazine

into the NAc or PFC blocks the corticosterone-induced potentiation of cocaine-induced reinstatement.

Chapter 3:

The monoamine transporter organic cation transporter 3 (OCT3) is expressed within the NAc in close proximity to neurons expressing tyrosine hydroxylase, suggesting an interaction with dopamine. Systemic administration of the OCT3 inhibitor, normetanephrine, prior to an injection of low dose cocaine (2.5 mg/kg, i.p.) results in reinstatement similar to that seen with electric footshock or stress level corticosterone.

Chapter 4:

Long access cocaine self-administration (LgA SA) results in an escalation of drug intake throughout the period of SA that is not seen with short access (ShA) SA. During LgA SA sessions, plasma corticosterone levels are elevated for a prolonged period of time compared to ShA SA sessions. Exposure to electric footshock results in the reinstatement of drug seeking in rats exposed to LgA SA, but not those with ShA SA. LgA SA also enhances reinstatement in response to administration of the stress neuropeptide, CRF. Both of these augmentations to later reinstatement are a result of corticosterone-induced neuroplasticity as neither effect is observed in animals adrenalectomized prior to the start of SA. A change in OCT3 expression following LgA SA does not appear to be one of the LgA SA-induced neuroadaptations occurring.

DISCUSSION

The chronic relapsing nature of addiction remains the most difficult aspects of the disease to treat and there is no current, effective treatment available. The work presented here was designed to examine the role of stress in relapse as measured using the reinstatement approach. Studies in human addicts have suggested that there is a strong connection between stressful life experiences and the likelihood of relapse (Kosten, Rounsaville et al. 1986; Brown, Vik et al. 1995) and that exposure to acute stress can increase drug cravings (Sinha, Catapano et al. 1999). Extensive work has been done examining the role of stress in reinstatement using animal models, however the exact mechanisms through which stress can alter behavior in a rapid time course remains poorly understood. The work presented here proposes a novel mechanism through which stress can impact reinstatement behavior through a rapid, nongenomic process.

The results of the experiments performed here provide evidence that corticosterone released in response to exposure to a stressor can increase the vulnerability to cocaine seeking upon subsequent exposure to other triggers for reinstatement. This suggests that stress can act as a stage setter and potentiate the reinstating properties of other stimuli. While the role of stress in reinstatement is a heavily studied subject, its ability to act as a stage setter and influence the effects of other stimuli has not been thoroughly examined. Here we propose that stress is capable of altering dopamine concentrations through corticosterone-induced

inhibition of the monoamine transporter, organic cation transporter 3 (OCT3).

While further work is required in order to gain a better understanding of this system, this may represent a novel mechanism through which stress can influence the reinstatement of cocaine seeking behavior.

Previous work done in other models has demonstrated the ability of a stressor, such as electric footshock (EFS), to potentiate cue- or context-induced reinstatement (Liu and Weiss 2002; Buffalari and See 2009). In these studies, exposure to footshock stress prior to the introduction of a previously cocaine-associated cue, potentiated reinstatement to either alcohol or cocaine. We have shown in chapter 1 that exposure to EFS potentiates cocaine-induced reinstatement. This occurs through a glucocorticoid-dependent mechanism, as the effect is lost in animals receiving an adrenalectomy prior to reinstatement testing. The role of glucocorticoids in this reinstatement behavior, however, does not appear to rely on activation of the glucocorticoid receptor (GR). Activation of GR results in the alteration of transcription factor activity and can, therefore, influence the expression of a large number of genes, and therefore potentially alter behavior (Datson, van der Perk et al. 2001; Deroche-Gamonet, Sillaber et al. 2003). However, these studies demonstrate the effect of stress level corticosterone, a glucocorticoid that interacts with GR, on cocaine-induced reinstatement was not blocked following administration of the GR antagonist RU38486 suggesting that corticosterone is acting independently of GR activation.

This suggests that stress may act to increase the response to other appetitive stimuli. This allows for stimuli that would not normally result in reinstatement, such as a low dose of cocaine that does not cause reinstatement when administered alone, to do so when encountered following exposure to a stressor or when corticosterone levels are elevated. The stress itself does not result in reinstatement of cocaine seeking under our conditions, as exposure to electric footshock or administration of corticosterone alone did not result in reinstatement in the model used here, but rather acts to enhance the salience of other stimuli.

As has been previously demonstrated, stress influences behavior differently following different levels of cocaine exposure. Exposure to EFS results in reinstatement in rats with a history of LgA SA, but does not produce this effect in rats with a history of ShA SA (Mantsch, Baker et al. 2008), an effect that is dependent upon LgA SA-induced prolonged elevations in corticosterone (Mantsch, Baker et al. 2008). These findings led us to examine the role of stress in animals with a history of ShA SA and what effect it may have on reinstatement. Interestingly, these findings demonstrate a role of corticosterone in rats a history of ShA SA, not in stress-induced reinstatement, but rather acting as a stage-setter observed as a potentiation of cocaine-induced reinstatement. Our findings in chapter 4 show that elevations in corticosterone is not needed at the time of EFS-induced reinstatement in LgA rats, while the work in chapter 1 shows that corticosterone is required for the potentiation of as cocaine-induced reinstatement by the same stressor in ShA rats. This discrepancy may involve the different circuitry involved in the two forms of reinstatement. Cocaine-induced

reinstatement involves activity within the VTA-PFC-NAc core and ventral pallidum, while stress-induced reinstatement involves the activation of this circuitry along with the central extended amygdala (McFarland and Kalivas 2001; McFarland, Davidge et al. 2004). Additionally, stress-induced reinstatement involves a mechanism that includes the activity of CRF (Erb, Shaham et al. 1998; Graf, Hoks et al. 2011) that is not required for cocaine-induced reinstatement. In these studies, administration of CRF antagonists block stress-induced reinstatement, while having no effect on reinstatement in response to a cocaine-primer. The differing mechanisms and activated circuitry might allow for corticosterone to play a different role in two forms of reinstatement.

Another explanation for the lack of a requirement for elevated corticosterone in EFS-induced reinstatement in rats with a history of LgA SA may be cocaine intake-dependent neuroplasticity. The augmentation of later reinstatement in response to stressors (Mantsch, Baker et al. 2008), cues (Kippin, Fuchs et al. 2006), or administration of a cocaine primer (Mantsch, Yuferov et al. 2004; Knackstedt and Kalivas 2007; Mantsch, Baker et al. 2008) compared to ShA rats suggests the induction of neuroadaptations in these LgA rats. The cocaine-induced changes that occur during LgA SA may alter the contribution of corticosterone during reinstatement, however, the mechanism through which this occurs needs further examination.

The effects of corticosterone on potentiation of later reinstatement in ShA rats appears to involve an increase in dopaminergic activity within the NAc and PFC.

This is based on results showing that systemically administered corticosterone potentiates the cocaine-induced increase in NAc dopamine. Further support for dopaminergic activity within the brain is demonstrated by site-specific administration of corticosterone into these regions that potentiates cocaine-induced reinstatement through a mechanism that requires the activation of dopamine receptors, as this behavior can be blocked with dopamine antagonists (chapter 2). Both of these regions have been extensively studied in addiction and reinstatement and it has been demonstrated that dopamine activity within these structures plays a key role in reinstatement. Inactivation of the PFC by administration of GABA agonists blocks cocaine-primed reinstatement (McFarland and Kalivas 2001), while administration of dopamine or dopamine agonists directly into the NAc or PFC reinstates drug seeking (Wise, Murray et al. 1990; Self, Barnhart et al. 1996; Cornish and Kalivas 2000; McFarland and Kalivas 2001) and administration of dopamine antagonists into the NAc shell blocks cocaine-primed reinstatement (Bari and Pierce 2005). Systemic administration of dopamine antagonists has also been shown to prevent psychostimulant-induced reinstatement (De Vries, Schoffelmeer et al. 1999). This data strongly implicates a role of dopamine in the reinstatement of cocaine-seeking behavior. We have demonstrated that administration of corticosterone directly into the NAc or PFC potentiates cocaine-induced reinstatement. Our results also show that corticosterone potentiates the dopamine response to cocaine by increasing extracellular dopamine in the NAc following systemic administration of corticosterone and a low dose of cocaine. Furthermore, blockade of dopamine activity in either the NAc or PFC through administration of

the dopamine antagonist, fluphenazine, blocks corticosterone-induced potentiation of drug-primed. These findings indicate an action of corticosterone within these brain regions that works to increase dopamine concentration and signaling to facilitate reinstatement. We have not, however, examined other brain regions in order to determine if corticosterone is acting system-wide or if the actions are limited to these specific regions. Further work will need to be done, as it is possible that corticosterone exerts effects on monoamine levels more broadly in the brain.

Chronic activation of dopamine receptors could influence behavior through the downstream effects of dopamine receptor activation. Dopamine receptors influence the activity of adenylyl cyclase and cAMP accumulation, increasing or decreasing activity depending on the dopamine receptor activated, thereby altering the signal transduction within the cell (Monsma, Mahan et al. 1990; Cohen, Todd et al. 1992). Activation of dopamine receptors can also impact cell signaling through modulation of intracellular calcium stores (Undie and Friedman 1990), potassium currents (Kitai and Surmeier 1993), arachidonic acid release (Keefe and Gerfen 1995) and Na⁺-K⁺-ATPase (Bertorello, Hopfield et al. 1990). Additionally, chronic elevations in dopamine levels can influence gene expression, including that of immediate early genes and neuropeptides (Missale, Nash et al. 1998). These data indicate that alterations in dopamine levels, as would be seen with decreased dopamine clearance, may have profound impacts on cellular signaling and gene expression, which would impact behavior.

While these findings indicated that stress was capable of influencing cocaine-induced reinstatement through a GR-independent process, the exact mechanism had yet to be determined. Previous studies indicate that corticosterone is able to influence dopaminergic activity in the brain. Dopamine neurons express corticosteroid receptors (Harfstrand, Fuxe et al. 1986) and it has been demonstrated that a number dopamine-mediated behaviors are facilitated by glucocorticoids, including the psychomotor effects of drugs (Marinelli, Piazza et al. 1994; Piazza, Rouge-Pont et al. 1996), and that high levels of glucocorticoids and activation of glucocorticoid receptors are involved in the regulation of stress-evoked dopamine concentrations (Gilad, Rabey et al. 1987; Butts, Weinberg et al. 2011). Also, administration of metyrapone, which blocks the synthesis of corticosterone, prevents stress-induced elevations in dopamine concentrations (Rouge-Pont, Marinelli et al. 1995). Together, these data suggest an interaction between corticosterone and dopaminergic activity that may involve glucocorticoid regulation of clearance.

In order to gain a better understanding of the mechanisms underlying this interaction, we examined the role of the corticosterone sensitive, monoamine transporter, OCT3. OCT3 is expressed throughout the brain, including the NAc as demonstrated in chapter 3 (Gasser, Orchinik et al. 2009) and is expressed in close proximity to tyrosine hydroxylase (TH) positive neurons in the NAc, suggesting it is very likely to be an active dopamine transporter within this region. To examine the role of OCT3 in the corticosterone-dependent reinstatement behavior we have shown in earlier experiments, we tested the ability of the OCT3 inhibitor,

normetanephrine, to influence reinstatement. Administration of normetanephrine prior to an injection of low dose cocaine resulted in reinstatement similar to that seen following exposure to a stressor or administration of corticosterone. As OCT3 is an uptake₂ transporter capable of transporting dopamine and can be directly inhibited by corticosterone (Grundemann, Schechinger et al. 1998), this represents a viable mechanism through which stress can influence dopamine concentrations and alter behavior.

The exact localization of OCT3 is not yet fully understood. While it is shown to be expressed at varying levels throughout the brain (Gasser, Orchinik et al. 2009), the exact cell type and location on those cells has yet to be determined. Localization on astrocytes could position OCT3 to regulate monoamine levels across a large number of synapses and be involved in controlling the spread to other synapses. Further staining studies will have to be done in order to determine co-localization with astrocytic or neuronal markers, as well as markers identifying pre-or post-synaptic localization.

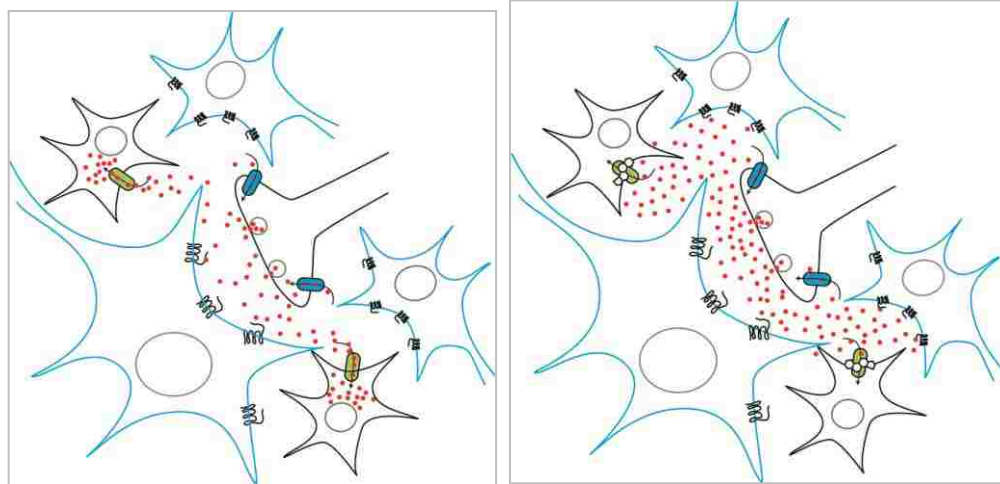

Figure 21. Model of OCT3-mediated regulation of monoamine clearance. Red= Dopamine, Blue= Dopamine transporter, Green= OCT3.

We propose that following exposure to a stressor, elevated corticosterone levels result in the inhibition of OCT3. This results in the loss of uptake2-mediated dopamine clearance and sets the stage for other stimuli to greatly influence behavior. Any stimulus, such as acute exposure to a drug such as cocaine that inhibits DAT, could elevate dopamine levels to a point where the primary transporters (DAT) are saturated and without the activity of OCT3, dopamine concentrations may be able to reach levels that result in changes in behavior, such as relapse. The ability of stress to act as a stage setter and alter the response to other stimuli may play a role in behaviors beyond those seen in addiction and may be involved in coping mechanisms during periods of stress. Activity in the mesolimbic dopamine system, which includes dopamine projections from the VTA to the PFC, NAc, amygdala and BNST (Pierce and Kumaresan 2006), has been shown to play a role in motivated behavior, including incentive motivation (Wise, Spindler

et al. 1978; Gerber, Sing et al. 1981; Stewart, de Wit et al. 1984), as well as responding to negative stimuli (Matsumoto and Hikosaka 2009). This suggests that during periods of stress and blockade of OCT3, the response to any salient stimulus may be exaggerated, which could aid in any survival situation by further reinforcing the positive or negative value assigned to a situation or environment. As corticosterone appears to have no effect of its own, only the potential coping or safety mechanisms receive enhanced value. This may represent a mechanism through which stress can influence behavior in a rapid, non GR-dependent manner and further demonstrates the importance of the body's stress response to an animal's survival.

Our findings represent a novel mechanism through which corticosterone can influence reinstatement behavior on a rapid time scale, independent of GR activation. Previous work has demonstrated the role of persistent GR activation in increasing the rewarding properties and enhancing the motivation for cocaine (Deroche, Marinelli et al. 1997; Deroche-Gamonet, Sillaber et al. 2003). These studies demonstrated that adrenalectomy significantly shifts the cocaine dose response curve downward and this effect can be reversed with administration of corticosterone. It was also demonstrated that antagonism of GR produces a similar decrease in motivation for cocaine. The data presented here, however, show a rapid effect of corticosterone that exerts effects on behavior in a time course not consistent with activation of GR and the effects we have shown are not blocked with the use of RU38486. These results demonstrate the ability of corticosterone to rapidly influence behavior, potentially through its interaction with OCT3, an

important finding considering the lack of research done on the acute effects of stress and the impact it has on behavioral processes.

In addition to influencing acute susceptibility to reinstatement, elevated glucocorticoids at the time of drug use appear to be critical for the establishment of addiction-related neuroplasticity. In humans this likely contributes to a loss of control over their ability regulate drug use and increases long-term susceptibility to relapse. Evidence suggests that humans who use cocaine with greater frequency show greater craving and relapse potential than those who use less frequently (Fox, Talih et al. 2005). In rats, this effect can be studied using the LgA SA approach. Like stressors, cocaine activates the HPA axis (Kuhn and Little 1995), and LgA SA prolongs this activity as a result of the longer periods of cocaine exposure (Mantsch, Yuferov et al. 2003; Mantsch and Katz 2007; Graf, Hoks et al. 2011). The pronounced HPA axis response in LgA rats compared to ShA rats, suggests that many of the addiction phenotypes that arise, such as augmented reinstatement sensitivity and escalation of drug use, may require glucocorticoid activity. This is supported by the studies we have performed demonstrating the need for cocaine-induced corticosterone elevations in the establishment of increased susceptibility to later stress- and CRF-induced reinstatement (Mantsch, Baker et al. 2008; Graf, Hoks et al. 2011). The exact mechanism through which corticosterone establishes this plasticity is not clear, but likely requires other stress and cocaine-activated systems as administration of corticosterone alone to ShA rats during SA does not produce the same effects (unpublished observation). The plasticity seen may involve glucocorticoid blockade of OCT3 since this is a system that requires activity of

monoamines in order to exert a behavioral effect, as we expect to see no effect with OCT3 inhibition alone (as seen in figure 21). Alterations in GR activity may also be involved as previous work has shown that inactivation of GR within the brain prevents cocaine-induced behavioral sensitization, another behavior dependent upon cocaine-induced neuroplasticity (Deroche-Gamonet, Sillaber et al. 2003).

In order to study the intake-dependent alterations in behavior, we examined reinstatement in rats exposed to either short access (ShA; 2 hours/day) or long access (LgA; 6 hours/day) cocaine self-administration (SA). We, and others, have previously shown that animals with a history of LgA SA escalate their drug use during the SA period (Ahmed and Koob 1998; Ahmed and Koob 1999; Mantsch, Ho et al. 2001) and later reinstatement by a number of stimuli, including stressors, is augmented (Mantsch, Yuferov et al. 2004; Ahmed and Cador 2006; Mantsch, Baker et al. 2008). We have also shown that animals undergoing LgA SA show prolonged elevations in plasma corticosterone levels that are required for the intake dependent alterations in reinstatement to EFS or i.c.v. CRF, the stress neuropeptide (Graf, Hoks et al. 2011), another example that the prolonged elevations in plasma corticosterone are required to establish neuroadaptations that allow for the augmented reinstatement.

We then tested the possibility that changes in Oct3 expression might account for the heightened relapse seen following LgA cocaine SA. Alterations in OCT3 expression may alter reinstatement behavior in LgA rats as it has been demonstrated that chronic cocaine exposure results in increases in cocaine-induced

dopamine concentrations (Henry, Greene et al. 1989; Ackerman and White 1990; Madayag, Kau et al. 2010). We hypothesized that intake-dependent alterations in OCT3 expression may render an individual more susceptible to elevations in dopamine that could lead to the reinstatement of cocaine seeking. In chapter 4 we examined the expression of OCT3 following ShA and LgA cocaine SA and compared it to levels seen in drug naïve rats. We proposed that chronic elevation of corticosterone could decrease OCT3 expression, thus producing a state similar to that seen following corticosterone-induced inhibition of OCT3, and may represent one means of neuroplasticity that could alter later reinstatement. This could occur as the result of chronic corticosterone-induced inhibition of OCT3 or alterations in OCT3 gene translation that occurred in response to prolonged activation of GR. Our findings, however, did not show any significant, intake-dependent changes to OCT3 mRNA in either region and only a slight increase in protein in the PFC. While further research needs to be done in order to confirm these findings, it does not come as a complete surprise. In order for an organism to maintain its ability to perform well and adapt to the environment during periods of stress, this system needs to remain functional. Any alterations in OCT3 expression could negatively affect an organism's ability to assign value to salient stimuli and decrease the ability to cope with stress.

While the work presented here strongly implicates the role of OCT3 in the acute effects of stress, further work needs to be done in order to confirm these findings. The pharmacological inhibitors of OCT3 used in these experiments, corticosterone and normetanephrine, have actions in addition to their ability to block OCT3-mediated clearance. Corticosterone interacts with the

mineralocorticoid receptor (MR) as well as GR, with much higher affinity for MR than GR (Reul and de Kloet 1985). The lack of an effect following administration of the GR antagonist, RU38486, suggests that GR does not play a role in the behavior we have seen, however, we have not examined a possible role for MR. The affinity of MR for corticosterone, however, would suggest that MR is bound by corticosterone even under basal conditions, allowing for no additional binding during periods of stress (de Kloet, Joels et al. 2005).

Additionally, normetanephrine has actions beyond inhibition of OCT3 that may influence reinstatement. It has been reported that normetanephrine is capable of acting as a weak agonist at α -adrenergic receptors (Langer and Rubio 1973), an action that could alter cocaine seeking itself (Lee, Tiefenbacher et al. 2004; Feltenstein and See 2006) through activation of central noradrenergic neurotransmission. While this is a concern that may need to be addressed in the future in order to confirm the role of OCT3, it is believed that the dose of normetanephrine used in these experiments would lead to a very low level of interaction with the α -adrenergic receptors compared to OCT3.

Because of the lack of specific, selective inhibitors of OCT3, in order to better examine the exact role of OCT3 in the behaviors seen here, an animal knockout or knockdown model will ultimately be necessary. The use of an adeno-associated virus (AAV) to temporarily knockdown the expression of OCT3 could be a useful tool for studying its role in reinstatement. If able to successfully knockdown OCT3 levels prior to reinstatement testing we would be able to determine if there are

other factors involved in the effects we have seen. If animals with decreased OCT3 functionality at the time of reinstatement testing reinstate to the subthreshold dose of cocaine (2.5 mg/kg, i.p.) used in chapter 1 alone, it would further support OCT3 as the mechanism responsible. If, however, corticosterone were still able to potentiate the reinstating effects of cocaine, it would suggest that other factors are involved in this process. Furthermore, the use of the OCT3 knockout mouse (Zwart, Verhaagh et al. 2001) could be beneficial in learning more about the behavior of an animal lacking this transporter, including the role of the α -adrenergic receptor, a issue that needs to be addressed in the studies using normetanephrine as an OCT3 inhibitor. This model would present a variety of other variables that would need to be considered prior to testing, however. As the knockout model currently only exists in mice, experimentation would involve a change in the species being studied. This may alter the experimental paradigms we are able to use and may impact the results found. Additionally, work would need to be done in order to examine the behavioral phenotype of mice lacking OCT3 expression throughout development. This may play a role in many behavioral processes, including the animals stress response system and could influence the results of the studies.

An additional area that needs to be further examined involves the exact mechanism through which dopamine concentrations are elevated following administration of corticosterone and cocaine, as seen in chapter 2 with the in vivo microdialysis experiments. While we propose that corticosterone-induced blockade of OCT3-mediated dopamine clearance accounts for the elevation in dopamine concentrations, we have yet to directly show a role for clearance in this process.

While previous work has suggested a role of glucocorticoids in alterations in the clearance of dopamine (Gilad, Rabey et al. 1987), the exact mechanism of dopamine alterations needs to be confirmed. Studies demonstrating the presence of GR on mesocorticolimbic dopamine cells suggests a potential for glucocorticoids to alter dopaminergic neurotransmission independent of changes in clearance (Harfstrand, Fuxe et al. 1986). In vivo microdialysis is useful in measuring the concentrations of dopamine over a period of time, it is not capable of differentiating between changes in release or alterations in clearance. The use of fast scan cyclic voltametry (FSCV) would aid in gaining a better understanding of this process. This technique would allow us to examine the clearance of dopamine under various treatment conditions on a very rapid time scale. The ability to demonstrate a decrease in dopamine clearance that is enhanced by corticosterone or normetanephrine would strongly implicate the role for a transporter and add further support for OCT3 being involved in the mechanism proposed here.

Furthermore, studies will need to be performed that examine the role of other monoamine neurotransmitters. Since cocaine is a nonspecific monoamine uptake inhibitor (Glowinski and Axelrod 1965; Iversen 1973; Rothman, Baumann et al. 2001) and OCT3 is involved in the clearance of norepinephrine, serotonin and histamine as well as dopamine (Grundemann, Schechinger et al. 1998; Grundemann, Liebich et al. 1999), other neurotransmitters will need to be examined, however, we have demonstrated a role for dopamine as systemic corticosterone effects were blocked by site specific fluphenazine administration. As previously stated, studies have demonstrated a role of noradrenergic activity in reinstatement (Erb, Hitchcott

et al. 2000; Lee, Tiefenbacher et al. 2004; Shepard, Bossert et al. 2004).

Additionally, elevations of serotonin have been shown to have rewarding properties (Filip, Frankowska et al. 2005) and inhibition of the 5-HT_{2A} receptor, or stimulation of the 5-HT_{2C} receptor have been shown to attenuate cocaine- and cue-induced reinstatement (Grottick, Corrigall et al. 2001; Fletcher, Grottick et al. 2002; Neisewander and Acosta 2007). In order to gain a better understanding of the mechanism behind corticosterone-induced potentiation of reinstatement, other neurotransmitters will need to be examined, as dopamine may not be the only monoamine affected through inhibition of OCT3.

CONCLUSIONS

The results from these experiments provide pre-clinical evidence that stress can act as a stage setter in making animals more likely to engage in compulsive cocaine seeking when exposed to a stimulus that would otherwise not elicit such a reaction. We believe that this effect involves inhibition of the monoamine transporter, OCT3, by corticosterone, leading to decreased dopamine clearance within brain regions involved in drug seeking. Overall, these data suggest that influencing the ability of OCT3 to regulate monoamine levels may represent an approach for treating relapse during periods of stress and may lead to an improvement in the treatment strategies aimed at managing cocaine addiction.

BIBLIOGRAPHY

- Abercrombie, E. D., K. A. Keefe, et al. (1989). "Differential effect of stress on in vivo dopamine release in striatum, nucleus accumbens, and medial frontal cortex." J Neurochem **52**(5): 1655-1658.
- Ackerman, J. M. and F. J. White (1990). "A10 somatodendritic dopamine autoreceptor sensitivity following withdrawal from repeated cocaine treatment." Neurosci Lett **117**(1-2): 181-187.
- Ahmed, S. H. and M. Cador (2006). "Dissociation of psychomotor sensitization from compulsive cocaine consumption." Neuropsychopharmacology **31**(3): 563-571.
- Ahmed, S. H. and G. F. Koob (1997). "Cocaine- but not food-seeking behavior is reinstated by stress after extinction." Psychopharmacology (Berl) **132**(3): 289-295.
- Ahmed, S. H. and G. F. Koob (1998). "Transition from moderate to excessive drug intake: change in hedonic set point." Science **282**(5387): 298-300.
- Ahmed, S. H. and G. F. Koob (1999). "Long-lasting increase in the set point for cocaine self-administration after escalation in rats." Psychopharmacology (Berl) **146**(3): 303-312.
- Ahmed, S. H., J. R. Walker, et al. (2000). "Persistent increase in the motivation to take heroin in rats with a history of drug escalation." Neuropsychopharmacology **22**(4): 413-421.
- Ambroggi, F., M. Turiault, et al. (2009). "Stress and addiction: glucocorticoid receptor in dopaminergic neurons facilitates cocaine seeking." Nat Neurosci **12**(3): 247-249.
- Amphoux, A., V. Vialou, et al. (2006). "Differential pharmacological in vitro properties of organic cation transporters and regional distribution in rat brain." Neuropharmacology **50**(8): 941-952.
- Anderson, S. M., A. A. Bari, et al. (2003). "Administration of the D1-like dopamine receptor antagonist SCH-23390 into the medial nucleus accumbens shell attenuates cocaine priming-induced reinstatement of drug-seeking behavior in rats." Psychopharmacology (Berl) **168**(1-2): 132-138.
- Anderson, S. M. and R. C. Pierce (2005). "Cocaine-induced alterations in dopamine receptor signaling: implications for reinforcement and reinstatement." Pharmacol Ther **106**(3): 389-403.

- Anderson, S. M., H. D. Schmidt, et al. (2006). "Administration of the D2 dopamine receptor antagonist sulpiride into the shell, but not the core, of the nucleus accumbens attenuates cocaine priming-induced reinstatement of drug seeking." Neuropsychopharmacology **31**(7): 1452-1461.
- Apicella, P., E. Scarnati, et al. (1992). "Neuronal activity in monkey striatum related to the expectation of predictable environmental events." J Neurophysiol **68**(3): 945-960.
- Aston-Jones, G., J. M. Delfs, et al. (1999). "The bed nucleus of the stria terminalis. A target site for noradrenergic actions in opiate withdrawal." Ann N Y Acad Sci **877**: 486-498.
- Bachtell, R. K., K. Whisler, et al. (2005). "Effects of intra-nucleus accumbens shell administration of dopamine agonists and antagonists on cocaine-taking and cocaine-seeking behaviors in the rat." Psychopharmacology (Berl) **183**(1): 41-53.
- Baganz, N. L., R. E. Horton, et al. (2008). "Organic cation transporter 3: Keeping the brake on extracellular serotonin in serotonin-transporter-deficient mice." Proc Natl Acad Sci U S A **105**(48): 18976-18981.
- Baker, D. A., K. McFarland, et al. (2003). "Neuroadaptations in cystine-glutamate exchange underlie cocaine relapse." Nat Neurosci **6**(7): 743-749.
- Baker, L. E., E. E. Riddle, et al. (1993). "The role of monoamine uptake in the discriminative stimulus effects of cocaine and related compounds." Behav Pharmacol **4**(1): 69-79.
- Bari, A. A. and R. C. Pierce (2005). "D1-like and D2 dopamine receptor antagonists administered into the shell subregion of the rat nucleus accumbens decrease cocaine, but not food, reinforcement." Neuroscience **135**(3): 959-968.
- Barik, J., S. Parnaudeau, et al. (2010). "Glucocorticoid receptors in dopaminergic neurons, key for cocaine, are dispensable for molecular and behavioral morphine responses." Biol Psychiatry **68**(3): 231-239.
- Barnes, N. M. and T. Sharp (1999). "A review of central 5-HT receptors and their function." Neuropharmacology **38**(8): 1083-1152.
- Barrot, M., M. Marinelli, et al. (2000). "The dopaminergic hyper-responsiveness of the shell of the nucleus accumbens is hormone-dependent." Eur J Neurosci **12**(3): 973-979.
- Bassareo, V. and G. Di Chiara (1999). "Differential responsiveness of dopamine transmission to food-stimuli in nucleus accumbens shell/core compartments." Neuroscience **89**(3): 637-641.

- Beardsley, P. M., J. L. Howard, et al. (2005). "Differential effects of the novel kappa opioid receptor antagonist, JD_{Tic}, on reinstatement of cocaine-seeking induced by footshock stressors vs cocaine primes and its antidepressant-like effects in rats." Psychopharmacology (Berl) **183**(1): 118-126.
- Bertorello, A. M., J. F. Hopfield, et al. (1990). "Inhibition by dopamine of (Na⁺)+K⁺)ATPase activity in neostriatal neurons through D1 and D2 dopamine receptor synergism." Nature **347**(6291): 386-388.
- Beuming, T., J. Kniazeff, et al. (2008). "The binding sites for cocaine and dopamine in the dopamine transporter overlap." Nat Neurosci **11**(7): 780-789.
- Blacktop, J. M., C. Seubert, et al. (2011). "Augmented cocaine seeking in response to stress or CRF delivered into the ventral tegmental area following long-access self-administration is mediated by CRF receptor type 1 but not CRF receptor type 2." J Neurosci **31**(31): 11396-11403.
- Bouchery, E., H. J. Harwood, et al. (2001). The economic costs of drug abuse in the United States, 1992-1998. Washington, D.C., Executive Office of the President, Office of National Drug Control Policy.
- Bremner, J. D., J. H. Krystal, et al. (1996). "Noradrenergic mechanisms in stress and anxiety: I. Preclinical studies." Synapse **23**(1): 28-38.
- Brischoux, F., S. Chakraborty, et al. (2009). "Phasic excitation of dopamine neurons in ventral VTA by noxious stimuli." Proc Natl Acad Sci U S A **106**(12): 4894-4899.
- Broderick, P. A., O. Hope, et al. (2004). "Clozapine and cocaine effects on dopamine and serotonin release in nucleus accumbens during psychostimulant behavior and withdrawal." Prog Neuropsychopharmacol Biol Psychiatry **28**(1): 157-171.
- Brown, S. A., P. W. Vik, et al. (1990). "Severity of psychosocial stress and outcome of alcoholism treatment." J Abnorm Psychol **99**(4): 344-348.
- Brown, S. A., P. W. Vik, et al. (1995). "Stress, vulnerability and adult alcohol relapse." J Stud Alcohol **56**(5): 538-545.
- Brown, Z. J., D. A. Kupferschmidt, et al. (2012). "Reinstatement of cocaine seeking in rats by the pharmacological stressors, corticotropin-releasing factor and yohimbine: role for D1/5 dopamine receptors." Psychopharmacology (Berl).
- Buffalari, D. M. and R. E. See (2009). "Footshock stress potentiates cue-induced cocaine-seeking in an animal model of relapse." Physiol Behav **98**(5): 614-617.

- Butts, K. A., J. Weinberg, et al. (2011). "Glucocorticoid receptors in the prefrontal cortex regulate stress-evoked dopamine efflux and aspects of executive function." Proc Natl Acad Sci U S A **108**(45): 18459-18464.
- Cabib, S. and S. Puglisi-Allegra (1996). "Stress, depression and the mesolimbic dopamine system." Psychopharmacology (Berl) **128**(4): 331-342.
- Cadepond, F., A. Ulmann, et al. (1997). "RU486 (mifepristone): mechanisms of action and clinical uses." Annu Rev Med **48**: 129-156.
- Cadoni, C. and G. Di Chiara (1999). "Reciprocal changes in dopamine responsiveness in the nucleus accumbens shell and core and in the dorsal caudate-putamen in rats sensitized to morphine." Neuroscience **90**(2): 447-455.
- Caine, S. B. and G. F. Koob (1993). "Modulation of cocaine self-administration in the rat through D-3 dopamine receptors." Science **260**(5115): 1814-1816.
- Caine, S. B. and G. F. Koob (1994). "Effects of mesolimbic dopamine depletion on responding maintained by cocaine and food." J Exp Anal Behav **61**(2): 213-221.
- Caine, S. B., S. S. Negus, et al. (2000). "Effects of dopamine D(1-like) and D(2-like) agonists on cocaine self-administration in rhesus monkeys: rapid assessment of cocaine dose-effect functions." Psychopharmacology (Berl) **148**(1): 41-51.
- Campanella, G., M. Roy, et al. (1987). "Drugs affecting movement disorders." Annu Rev Pharmacol Toxicol **27**: 113-136.
- Cao, C. J., A. E. Shamoo, et al. (1990). "Cocaine-sensitive, ATP-dependent dopamine uptake into striatal synaptosomes." Biochem Pharmacol **39**(6): R9-14.
- Capriles, N., D. Rodaros, et al. (2003). "A role for the prefrontal cortex in stress- and cocaine-induced reinstatement of cocaine seeking in rats." Psychopharmacology (Berl) **168**(1-2): 66-74.
- Carey, A. N., K. Borozny, et al. (2007). "Reinstatement of cocaine place-conditioning prevented by the peptide kappa-opioid receptor antagonist arodyn." Eur J Pharmacol **569**(1-2): 84-89.
- Carlezon, W. A., Jr., D. P. Devine, et al. (1995). "Habit-forming actions of nomifensine in nucleus accumbens." Psychopharmacology (Berl) **122**(2): 194-197.
- Carroll, M. E. (1985). "The role of food deprivation in the maintenance and reinstatement of cocaine-seeking behavior in rats." Drug Alcohol Depend **16**(2): 95-109.

- Chavkin, C., I. F. James, et al. (1982). "Dynorphin is a specific endogenous ligand of the kappa opioid receptor." Science **215**(4531): 413-415.
- Chiodo, L. A., S. M. Antelman, et al. (1980). "Sensory stimuli alter the discharge rate of dopamine (DA) neurons: evidence for two functional types of DA cells in the substantia nigra." Brain Res **189**(2): 544-549.
- Cohen, A. I., R. D. Todd, et al. (1992). "Photoreceptors of mouse retinas possess D4 receptors coupled to adenylate cyclase." Proc Natl Acad Sci U S A **89**(24): 12093-12097.
- Collins, R. J., J. R. Weeks, et al. (1984). "Prediction of abuse liability of drugs using IV self-administration by rats." Psychopharmacology (Berl) **82**(1-2): 6-13.
- Conrad, K. L., J. E. McCutcheon, et al. (2010). "Persistent increases in cocaine-seeking behavior after acute exposure to cold swim stress." Biol Psychiatry **68**(3): 303-305.
- Cook, C. E. and A. R. Jeffcoat (1990). "Pyrolytic degradation of heroin, phencyclidine, and cocaine: identification of products and some observations on their metabolism." NIDA Res Monogr **99**: 97-120.
- Cornish, J. L. and P. W. Kalivas (2000). "Glutamate transmission in the nucleus accumbens mediates relapse in cocaine addiction." J Neurosci **20**(15): RC89.
- Cui, M., R. Aras, et al. (2009). "The organic cation transporter-3 is a pivotal modulator of neurodegeneration in the nigrostriatal dopaminergic pathway." Proc Natl Acad Sci U S A **106**(19): 8043-8048.
- Cunningham, K. A. and P. M. Callahan (1991). "Monoamine reuptake inhibitors enhance the discriminative state induced by cocaine in the rat." Psychopharmacology (Berl) **104**(2): 177-180.
- Datson, N. A., J. van der Perk, et al. (2001). "Identification of corticosteroid-responsive genes in rat hippocampus using serial analysis of gene expression." Eur J Neurosci **14**(4): 675-689.
- Davis, M., D. L. Walker, et al. (1997). "Roles of the amygdala and bed nucleus of the stria terminalis in fear and anxiety measured with the acoustic startle reflex. Possible relevance to PTSD." Ann N Y Acad Sci **821**: 305-331.
- de Jong, I. E., P. J. Steenbergen, et al. (2009). "Behavioral sensitization to cocaine: cooperation between glucocorticoids and epinephrine." Psychopharmacology (Berl) **204**(4): 693-703.
- de Kloet, E. R., M. Joels, et al. (2005). "Stress and the brain: from adaptation to disease." Nat Rev Neurosci **6**(6): 463-475.

- de Quervain, D. J., B. Roozendaal, et al. (1998). "Stress and glucocorticoids impair retrieval of long-term spatial memory." Nature **394**(6695): 787-790.
- De Vries, T. J., A. N. Schoffelmeer, et al. (2002). "Relapse to cocaine- and heroin-seeking behavior mediated by dopamine D2 receptors is time-dependent and associated with behavioral sensitization." Neuropsychopharmacology **26**(1): 18-26.
- De Vries, T. J., A. N. Schoffelmeer, et al. (1999). "Dopaminergic mechanisms mediating the incentive to seek cocaine and heroin following long-term withdrawal of IV drug self-administration." Psychopharmacology (Berl) **143**(3): 254-260.
- de Wit, H. and J. Stewart (1981). "Reinstatement of cocaine-reinforced responding in the rat." Psychopharmacology (Berl) **75**(2): 134-143.
- De Wit, H. and R. A. Wise (1977). "Blockade of cocaine reinforcement in rats with the dopamine receptor blocker pimozide, but not with the noradrenergic blockers phentolamine or phenoxybenzamine." Can J Psychol **31**(4): 195-203.
- Delfs, J. M., Y. Zhu, et al. (2000). "Noradrenaline in the ventral forebrain is critical for opiate withdrawal-induced aversion." Nature **403**(6768): 430-434.
- Delfs, J. M., Y. Zhu, et al. (1998). "Origin of noradrenergic afferents to the shell subregion of the nucleus accumbens: anterograde and retrograde tract-tracing studies in the rat." Brain Res **806**(2): 127-140.
- Deroche, V., M. Marinelli, et al. (1997). "Glucocorticoids and behavioral effects of psychostimulants. II: cocaine intravenous self-administration and reinstatement depend on glucocorticoid levels." J Pharmacol Exp Ther **281**(3): 1401-1407.
- Deroche-Gamonet, V., I. Sillaber, et al. (2003). "The glucocorticoid receptor as a potential target to reduce cocaine abuse." J Neurosci **23**(11): 4785-4790.
- Di Chiara, G. (1999). "Drug addiction as dopamine-dependent associative learning disorder." Eur J Pharmacol **375**(1-3): 13-30.
- Di Chiara, G. (2002). "Nucleus accumbens shell and core dopamine: differential role in behavior and addiction." Behav Brain Res **137**(1-2): 75-114.
- Di Chiara, G. and A. Imperato (1988). "Drugs abused by humans preferentially increase synaptic dopamine concentrations in the mesolimbic system of freely moving rats." Proc Natl Acad Sci U S A **85**(14): 5274-5278.

- Di, S., R. Malcher-Lopes, et al. (2003). "Nongenomic glucocorticoid inhibition via endocannabinoid release in the hypothalamus: a fast feedback mechanism." J Neurosci **23**(12): 4850-4857.
- Di, S., M. M. Maxson, et al. (2009). "Glucocorticoids regulate glutamate and GABA synapse-specific retrograde transmission via divergent nongenomic signaling pathways." J Neurosci **29**(2): 393-401.
- Dickinson, A., J. Smith, et al. (2000). "Dissociation of Pavlovian and instrumental incentive learning under dopamine antagonists." Behav Neurosci **114**(3): 468-483.
- Duan, H. and J. Wang (2010). "Selective transport of monoamine neurotransmitters by human plasma membrane monoamine transporter and organic cation transporter 3." J Pharmacol Exp Ther **335**(3): 743-753.
- Engel, K. and J. Wang (2005). "Interaction of organic cations with a newly identified plasma membrane monoamine transporter." Mol Pharmacol **68**(5): 1397-1407.
- Engel, K., M. Zhou, et al. (2004). "Identification and characterization of a novel monoamine transporter in the human brain." J Biol Chem **279**(48): 50042-50049.
- Epstein, D. H., K. L. Preston, et al. (2006). "Toward a model of drug relapse: an assessment of the validity of the reinstatement procedure." Psychopharmacology (Berl) **189**(1): 1-16.
- Erb, S., P. K. Hitchcott, et al. (2000). "Alpha-2 adrenergic receptor agonists block stress-induced reinstatement of cocaine seeking." Neuropsychopharmacology **23**(2): 138-150.
- Erb, S., A. Petrovic, et al. (2006). "Central injections of CRF reinstate cocaine seeking in rats after postinjection delays of up to 3 h: an influence of time and environmental context." Psychopharmacology (Berl) **187**(1): 112-120.
- Erb, S., Y. Shaham, et al. (1996). "Stress reinstates cocaine-seeking behavior after prolonged extinction and a drug-free period." Psychopharmacology (Berl) **128**(4): 408-412.
- Erb, S., Y. Shaham, et al. (1998). "The role of corticotropin-releasing factor and corticosterone in stress- and cocaine-induced relapse to cocaine seeking in rats." J Neurosci **18**(14): 5529-5536.
- Erb, S. and J. Stewart (1999). "A role for the bed nucleus of the stria terminalis, but not the amygdala, in the effects of corticotropin-releasing factor on stress-induced reinstatement of cocaine seeking." J Neurosci **19**(20): RC35.

- Feltenstein, M. W. and R. E. See (2006). "Potentiation of cue-induced reinstatement of cocaine-seeking in rats by the anxiogenic drug yohimbine." Behav Brain Res **174**(1): 1-8.
- Ferrario, C. R., G. Gorny, et al. (2005). "Neural and behavioral plasticity associated with the transition from controlled to escalated cocaine use." Biol Psychiatry **58**(9): 751-759.
- Figuroa-Guzman, Y., C. Mueller, et al. (2011). "Oral administration of levotetrahypalmatine attenuates reinstatement of extinguished cocaine seeking by cocaine, stress or drug-associated cues in rats." Drug Alcohol Depend **116**(1-3): 72-79.
- Filip, M., M. J. Bubar, et al. (2004). "Contribution of serotonin (5-hydroxytryptamine; 5-HT) 5-HT₂ receptor subtypes to the hyperlocomotor effects of cocaine: acute and chronic pharmacological analyses." J Pharmacol Exp Ther **310**(3): 1246-1254.
- Filip, M., M. Frankowska, et al. (2005). "The serotonergic system and its role in cocaine addiction." Pharmacol Rep **57**(6): 685-700.
- Fletcher, P. J., A. F. Chintoh, et al. (2004). "Injection of the 5-HT_{2C} receptor agonist Ro60-0175 into the ventral tegmental area reduces cocaine-induced locomotor activity and cocaine self-administration." Neuropsychopharmacology **29**(2): 308-318.
- Fletcher, P. J., A. J. Grottick, et al. (2002). "Differential effects of the 5-HT_{2A} receptor antagonist M100907 and the 5-HT_{2C} receptor antagonist SB242084 on cocaine-induced locomotor activity, cocaine self-administration and cocaine-induced reinstatement of responding." Neuropsychopharmacology **27**(4): 576-586.
- Foote, S. L., F. E. Bloom, et al. (1983). "Nucleus locus ceruleus: new evidence of anatomical and physiological specificity." Physiol Rev **63**(3): 844-914.
- Fouriez, G., P. Hansson, et al. (1978). "Neuroleptic-induced attenuation of brain stimulation reward in rats." J Comp Physiol Psychol **92**(4): 661-671.
- Fouriez, G. and R. A. Wise (1976). "Pimozide-induced extinction of intracranial self-stimulation: response patterns rule out motor or performance deficits." Brain Res **103**(2): 377-380.
- Fowler, J. S., N. D. Volkow, et al. (1989). "Mapping cocaine binding sites in human and baboon brain in vivo." Synapse **4**(4): 371-377.

- Fox, H. C., M. Talih, et al. (2005). "Frequency of recent cocaine and alcohol use affects drug craving and associated responses to stress and drug-related cues." Psychoneuroendocrinology **30**(9): 880-891.
- Franklin, K. B. and S. N. McCoy (1979). "Pimozide-induced extinction in rats: stimulus control of responding rules out motor deficit." Pharmacol Biochem Behav **11**(1): 71-75.
- French, S. J. and S. Totterdell (2003). "Individual nucleus accumbens-projection neurons receive both basolateral amygdala and ventral subicular afferents in rats." Neuroscience **119**(1): 19-31.
- Gaspar, P., B. Bloch, et al. (1995). "D1 and D2 receptor gene expression in the rat frontal cortex: cellular localization in different classes of efferent neurons." Eur J Neurosci **7**(5): 1050-1063.
- Gasser, P. J., C. A. Lowry, et al. (2006). "Corticosterone-sensitive monoamine transport in the rat dorsomedial hypothalamus: potential role for organic cation transporter 3 in stress-induced modulation of monoaminergic neurotransmission." J Neurosci **26**(34): 8758-8766.
- Gasser, P. J., M. Orchinik, et al. (2009). "Distribution of organic cation transporter 3, a corticosterone-sensitive monoamine transporter, in the rat brain." J Comp Neurol **512**(4): 529-555.
- Gawin, F. H. (1991). "Cocaine addiction: psychology and neurophysiology." Science **251**(5001): 1580-1586.
- Gerber, G. J., J. Sing, et al. (1981). "Pimozide attenuates lever pressing for water reinforcement in rats." Pharmacol Biochem Behav **14**(2): 201-205.
- Gerber, G. J. and R. Stretch (1975). "Drug-induced reinstatement of extinguished self-administration behavior in monkeys." Pharmacol Biochem Behav **3**(6): 1055-1061.
- Gilad, G. M., J. M. Rabey, et al. (1987). "Presynaptic effects of glucocorticoids on dopaminergic and cholinergic synaptosomes. Implications for rapid endocrine-neural interactions in stress." Life Sci **40**(25): 2401-2408.
- Giros, B., S. el Mestikawy, et al. (1991). "Cloning and functional characterization of a cocaine-sensitive dopamine transporter." FEBS Lett **295**(1-3): 149-154.
- Glowinski, J. and J. Axelrod (1965). "Effect of Drugs on the Uptake, Release, and Metabolism of H3-Norepinephrine in the Rat Brain." J Pharmacol Exp Ther **149**: 43-49.

- Goeders, N. E. (2002). "The HPA axis and cocaine reinforcement." Psychoneuroendocrinology **27**(1-2): 13-33.
- Goeders, N. E. (2003). "The impact of stress on addiction." Eur Neuropsychopharmacol **13**(6): 435-441.
- Goeders, N. E. and D. M. Clampitt (2002). "Potential role for the hypothalamo-pituitary-adrenal axis in the conditioned reinforcer-induced reinstatement of extinguished cocaine seeking in rats." Psychopharmacology (Berl) **161**(3): 222-232.
- Goeders, N. E. and G. F. Guerin (1994). "Non-contingent electric footshock facilitates the acquisition of intravenous cocaine self-administration in rats." Psychopharmacology (Berl) **114**(1): 63-70.
- Goeders, N. E. and G. F. Guerin (1996). "Effects of surgical and pharmacological adrenalectomy on the initiation and maintenance of intravenous cocaine self-administration in rats." Brain Res **722**(1-2): 145-152.
- Goeders, N. E. and J. E. Smith (1993). "Intracranial cocaine self-administration into the medial prefrontal cortex increases dopamine turnover in the nucleus accumbens." J Pharmacol Exp Ther **265**(2): 592-600.
- Goldberg, S. R., R. T. Kelleher, et al. (1975). "Second-order schedules of drug injection." Fed Proc **34**(9): 1771-1776.
- Goldstein, D. S., G. Eisenhofer, et al. (2003). "Sources and significance of plasma levels of catechols and their metabolites in humans." J Pharmacol Exp Ther **305**(3): 800-811.
- Gorboulev, V., J. C. Ulzheimer, et al. (1997). "Cloning and characterization of two human polyspecific organic cation transporters." DNA Cell Biol **16**(7): 871-881.
- Grabowski, J. (1984). Cocaine : pharmacology, effects, and treatment of abuse. Rockville, Md.
- Washington, D.C., Dept. of Health and Human Services, Public Health Service, Alcohol, Drug Abuse, and Mental Health Administration
- For sale by the Supt. of Docs., U.S. G.P.O.
- Graf, E. N., M. A. Hoks, et al. (2011). "Adrenal activity during repeated long-access cocaine self-administration is required for later CRF-Induced and CRF-dependent stressor-induced reinstatement in rats." Neuropsychopharmacology **36**(7): 1444-1454.

- Groeneweg, F. L., H. Karst, et al. (2011). "Rapid non-genomic effects of corticosteroids and their role in the central stress response." J Endocrinol **209**(2): 153-167.
- Groenewegen, H. J., C. I. Wright, et al. (1999). "Convergence and segregation of ventral striatal inputs and outputs." Ann N Y Acad Sci **877**: 49-63.
- Grottick, A. J., W. A. Corrigall, et al. (2001). "Activation of 5-HT(2C) receptors reduces the locomotor and rewarding effects of nicotine." Psychopharmacology (Berl) **157**(3): 292-298.
- Grundemann, D., S. Koster, et al. (1998). "Transport of monoamine transmitters by the organic cation transporter type 2, OCT2." J Biol Chem **273**(47): 30915-30920.
- Grundemann, D., G. Liebich, et al. (1999). "Selective substrates for non-neuronal monoamine transporters." Mol Pharmacol **56**(1): 1-10.
- Grundemann, D., B. Schechinger, et al. (1998). "Molecular identification of the corticosterone-sensitive extraneuronal catecholamine transporter." Nat Neurosci **1**(5): 349-351.
- Hall, J., J. A. Parkinson, et al. (2001). "Involvement of the central nucleus of the amygdala and nucleus accumbens core in mediating Pavlovian influences on instrumental behaviour." Eur J Neurosci **13**(10): 1984-1992.
- Hall, R. C., M. K. Popkin, et al. (1979). "Presentation of the steroid psychoses." J Nerv Ment Dis **167**(4): 229-236.
- Halliday, G. M. and I. Tork (1989). "Serotonin-like immunoreactive cells and fibres in the rat ventromedial mesencephalic tegmentum." Brain Res Bull **22**(4): 725-735.
- Harfstrand, A., K. Fuxe, et al. (1986). "Glucocorticoid receptor immunoreactivity in monoaminergic neurons of rat brain." Proc Natl Acad Sci U S A **83**(24): 9779-9783.
- Hayer-Zillgen, M., M. Bruss, et al. (2002). "Expression and pharmacological profile of the human organic cation transporters hOCT1, hOCT2 and hOCT3." Br J Pharmacol **136**(6): 829-836.
- Henry, D. J., M. A. Greene, et al. (1989). "Electrophysiological effects of cocaine in the mesoaccumbens dopamine system: repeated administration." J Pharmacol Exp Ther **251**(3): 833-839.
- Herman, J. P., W. E. Cullinan, et al. (2002). "Role of the paraventricular nucleus microenvironment in stress integration." Eur J Neurosci **16**(3): 381-385.

- Herman, J. P., H. Figueiredo, et al. (2003). "Central mechanisms of stress integration: hierarchical circuitry controlling hypothalamo-pituitary-adrenocortical responsiveness." Front Neuroendocrinol **24**(3): 151-180.
- Hill, J. E., K. Makky, et al. (2011). "Natural and synthetic corticosteroids inhibit uptake 2-mediated transport in CNS neurons." Physiol Behav **104**(2): 306-311.
- Hnasko, T. S., B. N. Sotak, et al. (2005). "Morphine reward in dopamine-deficient mice." Nature **438**(7069): 854-857.
- Hoebel, B. G., A. P. Monaco, et al. (1983). "Self-injection of amphetamine directly into the brain." Psychopharmacology (Berl) **81**(2): 158-163.
- Hoffman, D. C. (1989). "The use of place conditioning in studying the neuropharmacology of drug reinforcement." Brain Res Bull **23**(4-5): 373-387.
- Hollerman, J. R., L. Tremblay, et al. (1998). "Influence of reward expectation on behavior-related neuronal activity in primate striatum." J Neurophysiol **80**(2): 947-963.
- Horvath, G., Z. Sutto, et al. (2003). "Norepinephrine transport by the extraneuronal monoamine transporter in human bronchial arterial smooth muscle cells." Am J Physiol Lung Cell Mol Physiol **285**(4): L829-837.
- Hyman, S. E., R. C. Malenka, et al. (2006). "Neural mechanisms of addiction: the role of reward-related learning and memory." Annu Rev Neurosci **29**: 565-598.
- Ikemoto, S., B. S. Glazier, et al. (1997). "Role of dopamine D1 and D2 receptors in the nucleus accumbens in mediating reward." J Neurosci **17**(21): 8580-8587.
- Imperato, A., S. Puglisi-Allegra, et al. (1989). "Stress-induced enhancement of dopamine and acetylcholine release in limbic structures: role of corticosterone." Eur J Pharmacol **165**(2-3): 337-338.
- Ito, R., T. W. Robbins, et al. (2004). "Differential control over cocaine-seeking behavior by nucleus accumbens core and shell." Nat Neurosci **7**(4): 389-397.
- Iversen, L. L. (1973). "Catecholamine uptake processes." Br Med Bull **29**(2): 130-135.
- Iversen, L. L. and P. J. Salt (1970). "Inhibition of catecholamine Uptake-2 by steroids in the isolated rat heart." Br J Pharmacol **40**(3): 528-530.

- Jacobson, L., S. F. Akana, et al. (1988). "Circadian variations in plasma corticosterone permit normal termination of adrenocorticotropin responses to stress." Endocrinology **122**(4): 1343-1348.
- Jatlow, P. I. (1987). "Drug of abuse profile: cocaine." Clin Chem **33**(11 Suppl): 66B-71B.
- Javaid, J. I., M. W. Fischman, et al. (1978). "Cocaine plasma concentration: relation to physiological and subjective effects in humans." Science **202**(4364): 227-228.
- Joels, M. and T. Z. Baram (2009). "The neuro-symphony of stress." Nat Rev Neurosci **10**(6): 459-466.
- Jones, S. R., P. A. Garris, et al. (1995). "Different effects of cocaine and nomifensine on dopamine uptake in the caudate-putamen and nucleus accumbens." J Pharmacol Exp Ther **274**(1): 396-403.
- Kalivas, P. W. and P. Duffy (1995). "Selective activation of dopamine transmission in the shell of the nucleus accumbens by stress." Brain Res **675**(1-2): 325-328.
- Kalivas, P. W. and K. McFarland (2003). "Brain circuitry and the reinstatement of cocaine-seeking behavior." Psychopharmacology (Berl) **168**(1-2): 44-56.
- Kalsner, S. (1975). "Role of extraneuronal mechanisms in the termination of contractile responses to amines in vascular tissue." Br J Pharmacol **53**(2): 267-277.
- Kebabian, J. W. and P. Greengard (1971). "Dopamine-sensitive adenylyl cyclase: possible role in synaptic transmission." Science **174**(4016): 1346-1349.
- Keefe, K. A. and C. R. Gerfen (1995). "D1-D2 dopamine receptor synergy in striatum: effects of intrastriatal infusions of dopamine agonists and antagonists on immediate early gene expression." Neuroscience **66**(4): 903-913.
- Keller-Wood, M. E. and M. F. Dallman (1984). "Corticosteroid inhibition of ACTH secretion." Endocr Rev **5**(1): 1-24.
- Kennedy, J. (1985). Coca Exotica: The Illustrated Story of Cocaine. Rutherford, New Jersey, Fairleigh Dickinson University Press.
- Kilty, J. E., D. Lorang, et al. (1991). "Cloning and expression of a cocaine-sensitive rat dopamine transporter." Science **254**(5031): 578-579.
- Kippin, T. E., R. A. Fuchs, et al. (2006). "Contributions of prolonged contingent and noncontingent cocaine exposure to enhanced reinstatement of cocaine seeking in rats." Psychopharmacology (Berl) **187**(1): 60-67.

- Kitai, S. T. and D. J. Surmeier (1993). "Cholinergic and dopaminergic modulation of potassium conductances in neostriatal neurons." Adv Neurol **60**: 40-52.
- Kitchener, P., F. Di Blasi, et al. (2004). "Differences between brain structures in nuclear translocation and DNA binding of the glucocorticoid receptor during stress and the circadian cycle." Eur J Neurosci **19**(7): 1837-1846.
- Knackstedt, L. A. and P. W. Kalivas (2007). "Extended access to cocaine self-administration enhances drug-primed reinstatement but not behavioral sensitization." J Pharmacol Exp Ther **322**(3): 1103-1109.
- Koepsell, H. and H. Endou (2004). "The SLC22 drug transporter family." Pflugers Arch **447**(5): 666-676.
- Koepsell, H., B. M. Schmitt, et al. (2003). "Organic cation transporters." Rev Physiol Biochem Pharmacol **150**: 36-90.
- Koob, G. and M. J. Kreek (2007). "Stress, dysregulation of drug reward pathways, and the transition to drug dependence." Am J Psychiatry **164**(8): 1149-1159.
- Koob, G. F. (1992). "Drugs of abuse: anatomy, pharmacology and function of reward pathways." Trends Pharmacol Sci **13**(5): 177-184.
- Koob, G. F. and M. Le Moal (1997). "Drug abuse: hedonic homeostatic dysregulation." Science **278**(5335): 52-58.
- Koob, G. F. and M. Le Moal (2006). Neurobiology of addiction. Amsterdam ; Boston, Elsevier/Academic Press.
- Kornetsky, C. and R. U. Esposito (1981). "Reward and detection thresholds for brain stimulation: dissociative effects of cocaine." Brain Res **209**(2): 496-500.
- Kosten, T. R., B. J. Rounsaville, et al. (1986). "A 2.5-year follow-up of depression, life crises, and treatment effects on abstinence among opioid addicts." Arch Gen Psychiatry **43**(8): 733-738.
- Kreek, M. J. and G. F. Koob (1998). "Drug dependence: stress and dysregulation of brain reward pathways." Drug Alcohol Depend **51**(1-2): 23-47.
- Kuhn, C. and P. Little, Eds. (1995). Neuroendocrine effects of cocaine. Boca Raton, FL, CRC Press.
- Kupferschmidt, D. A., Z. J. Brown, et al. (2011). "A procedure for studying the footshock-induced reinstatement of cocaine seeking in laboratory rats." J Vis Exp(47).

- Land, B. B., M. R. Bruchas, et al. (2008). "The dysphoric component of stress is encoded by activation of the dynorphin kappa-opioid system." J Neurosci **28**(2): 407-414.
- Langer, S. Z. and M. C. Rubio (1973). "Effects of the noradrenaline metabolites on the adrenergic receptors." Naunyn Schmiedebergs Arch Pharmacol **276**(1): 71-88.
- Lee, B., S. Tiefenbacher, et al. (2004). "Pharmacological blockade of alpha2-adrenoceptors induces reinstatement of cocaine-seeking behavior in squirrel monkeys." Neuropsychopharmacology **29**(4): 686-693.
- Ling, M. H., P. J. Perry, et al. (1981). "Side effects of corticosteroid therapy. Psychiatric aspects." Arch Gen Psychiatry **38**(4): 471-477.
- Liu, X. and F. Weiss (2002). "Additive effect of stress and drug cues on reinstatement of ethanol seeking: exacerbation by history of dependence and role of concurrent activation of corticotropin-releasing factor and opioid mechanisms." J Neurosci **22**(18): 7856-7861.
- Liu, X. and F. Weiss (2003). "Stimulus conditioned to foot-shock stress reinstates alcohol-seeking behavior in an animal model of relapse." Psychopharmacology (Berl) **168**(1-2): 184-191.
- Ljungberg, T., P. Apicella, et al. (1992). "Responses of monkey dopamine neurons during learning of behavioral reactions." J Neurophysiol **67**(1): 145-163.
- Madayag, A., K. S. Kau, et al. (2010). "Drug-induced plasticity contributing to heightened relapse susceptibility: neurochemical changes and augmented reinstatement in high-intake rats." J Neurosci **30**(1): 210-217.
- Makara, G. B. and J. Haller (2001). "Non-genomic effects of glucocorticoids in the neural system. Evidence, mechanisms and implications." Prog Neurobiol **65**(4): 367-390.
- Maldonado, R., O. Valverde, et al. (2006). "Involvement of the endocannabinoid system in drug addiction." Trends Neurosci **29**(4): 225-232.
- Mantsch, J. R., D. A. Baker, et al. (2008). "Stressor- and corticotropin releasing factor-induced reinstatement and active stress-related behavioral responses are augmented following long-access cocaine self-administration by rats." Psychopharmacology (Berl) **195**(4): 591-603.
- Mantsch, J. R., D. A. Baker, et al. (2008). "Surgical adrenalectomy with diurnal corticosterone replacement slows escalation and prevents the augmentation of cocaine-induced reinstatement in rats self-administering cocaine under long-access conditions." Neuropsychopharmacology **33**(4): 814-826.

- Mantsch, J. R., W. E. Cullinan, et al. (2007). "Daily cocaine self-administration under long-access conditions augments restraint-induced increases in plasma corticosterone and impairs glucocorticoid receptor-mediated negative feedback in rats." Brain Res **1167**: 101-111.
- Mantsch, J. R. and N. E. Goeders (1999). "Ketoconazole blocks the stress-induced reinstatement of cocaine-seeking behavior in rats: relationship to the discriminative stimulus effects of cocaine." Psychopharmacology (Berl) **142**(4): 399-407.
- Mantsch, J. R. and N. E. Goeders (1999). "Ketoconazole does not block cocaine discrimination or the cocaine-induced reinstatement of cocaine-seeking behavior." Pharmacol Biochem Behav **64**(1): 65-73.
- Mantsch, J. R., A. Ho, et al. (2001). "Predictable individual differences in the initiation of cocaine self-administration by rats under extended-access conditions are dose-dependent." Psychopharmacology (Berl) **157**(1): 31-39.
- Mantsch, J. R. and E. S. Katz (2007). "Elevation of glucocorticoids is necessary but not sufficient for the escalation of cocaine self-administration by chronic electric footshock stress in rats." Neuropsychopharmacology **32**(2): 367-376.
- Mantsch, J. R., D. Saphier, et al. (1998). "Corticosterone facilitates the acquisition of cocaine self-administration in rats: opposite effects of the type II glucocorticoid receptor agonist dexamethasone." J Pharmacol Exp Ther **287**(1): 72-80.
- Mantsch, J. R., V. Yuferov, et al. (2003). "Neuroendocrine alterations in a high-dose, extended-access rat self-administration model of escalating cocaine use." Psychoneuroendocrinology **28**(7): 836-862.
- Mantsch, J. R., V. Yuferov, et al. (2004). "Effects of extended access to high versus low cocaine doses on self-administration, cocaine-induced reinstatement and brain mRNA levels in rats." Psychopharmacology (Berl) **175**(1): 26-36.
- Mantz, J., A. M. Thierry, et al. (1989). "Effect of noxious tail pinch on the discharge rate of mesocortical and mesolimbic dopamine neurons: selective activation of the mesocortical system." Brain Res **476**(2): 377-381.
- Marinelli, M., B. Aouizerate, et al. (1998). "Dopamine-dependent responses to morphine depend on glucocorticoid receptors." Proc Natl Acad Sci U S A **95**(13): 7742-7747.
- Marinelli, M., P. V. Piazza, et al. (1994). "Corticosterone circadian secretion differentially facilitates dopamine-mediated psychomotor effect of cocaine and morphine." J Neurosci **14**(5 Pt 1): 2724-2731.

- Martel, F., L. Ribeiro, et al. (1999). "Comparison between uptake2 and rOCT1: effects of catecholamines, metanephrines and corticosterone." Naunyn Schmiedebergs Arch Pharmacol **359**(4): 303-309.
- Matsumoto, M. and O. Hikosaka (2009). "Two types of dopamine neuron distinctly convey positive and negative motivational signals." Nature **459**(7248): 837-841.
- McBride, W. J., J. M. Murphy, et al. (1999). "Localization of brain reinforcement mechanisms: intracranial self-administration and intracranial place-conditioning studies." Behav Brain Res **101**(2): 129-152.
- McCreary, A. C. and K. A. Cunningham (1999). "Effects of the 5-HT_{2C/2B} antagonist SB 206553 on hyperactivity induced by cocaine." Neuropsychopharmacology **20**(6): 556-564.
- McEwen, B. S. (1998). "Protective and damaging effects of stress mediators." N Engl J Med **338**(3): 171-179.
- McEwen, B. S. and E. Stellar (1993). "Stress and the individual. Mechanisms leading to disease." Arch Intern Med **153**(18): 2093-2101.
- McFarland, K., S. B. Davidge, et al. (2004). "Limbic and motor circuitry underlying footshock-induced reinstatement of cocaine-seeking behavior." J Neurosci **24**(7): 1551-1560.
- McFarland, K. and A. Ettenberg (1995). "Haloperidol differentially affects reinforcement and motivational processes in rats running an alley for intravenous heroin." Psychopharmacology (Berl) **122**(4): 346-350.
- McFarland, K. and P. W. Kalivas (2001). "The circuitry mediating cocaine-induced reinstatement of drug-seeking behavior." J Neurosci **21**(21): 8655-8663.
- McGregor, A. and D. C. Roberts (1993). "Dopaminergic antagonism within the nucleus accumbens or the amygdala produces differential effects on intravenous cocaine self-administration under fixed and progressive ratio schedules of reinforcement." Brain Res **624**(1-2): 245-252.
- McKinzie, D. L., Z. A. Rodd-Henricks, et al. (1999). "Cocaine is self-administered into the shell region of the nucleus accumbens in Wistar rats." Ann N Y Acad Sci **877**: 788-791.
- McLaughlin, J. and R. E. See (2003). "Selective inactivation of the dorsomedial prefrontal cortex and the basolateral amygdala attenuates conditioned-cued reinstatement of extinguished cocaine-seeking behavior in rats." Psychopharmacology (Berl) **168**(1-2): 57-65.

- McLaughlin, J. P., M. Marton-Popovici, et al. (2003). "Kappa opioid receptor antagonism and prodynorphin gene disruption block stress-induced behavioral responses." J Neurosci **23**(13): 5674-5683.
- Meil, W. M. and R. E. See (1997). "Lesions of the basolateral amygdala abolish the ability of drug associated cues to reinstate responding during withdrawal from self-administered cocaine." Behav Brain Res **87**(2): 139-148.
- Melis, M., M. Pistis, et al. (2004). "Endocannabinoids mediate presynaptic inhibition of glutamatergic transmission in rat ventral tegmental area dopamine neurons through activation of CB1 receptors." J Neurosci **24**(1): 53-62.
- Meyer, J. S., D. J. Micco, et al. (1979). "Subcutaneous implantation method for chronic glucocorticoid replacement therapy." Physiol Behav **22**(5): 867-870.
- Miklos, I. H. and K. J. Kovacs (2002). "GABAergic innervation of corticotropin-releasing hormone (CRH)-secreting parvocellular neurons and its plasticity as demonstrated by quantitative immunoelectron microscopy." Neuroscience **113**(3): 581-592.
- Mirenowicz, J. and W. Schultz (1996). "Preferential activation of midbrain dopamine neurons by appetitive rather than aversive stimuli." Nature **379**(6564): 449-451.
- Missale, C., S. R. Nash, et al. (1998). "Dopamine receptors: from structure to function." Physiol Rev **78**(1): 189-225.
- Moldow, R. L. and A. J. Fischman (1987). "Cocaine induced secretion of ACTH, beta-endorphin, and corticosterone." Peptides **8**(5): 819-822.
- Monsma, F. J., Jr., L. C. Mahan, et al. (1990). "Molecular cloning and expression of a D1 dopamine receptor linked to adenylyl cyclase activation." Proc Natl Acad Sci U S A **87**(17): 6723-6727.
- Moore, R. Y. and F. E. Bloom (1979). "Central catecholamine neuron systems: anatomy and physiology of the norepinephrine and epinephrine systems." Annu Rev Neurosci **2**: 113-168.
- Morimoto, M., N. Morita, et al. (1996). "Distribution of glucocorticoid receptor immunoreactivity and mRNA in the rat brain: an immunohistochemical and in situ hybridization study." Neurosci Res **26**(3): 235-269.
- Neisewander, J. L. and J. I. Acosta (2007). "Stimulation of 5-HT_{2C} receptors attenuates cue and cocaine-primed reinstatement of cocaine-seeking behavior in rats." Behav Pharmacol **18**(8): 791-800.

- Orchinik, M., T. F. Murray, et al. (1991). "A corticosteroid receptor in neuronal membranes." Science **252**(5014): 1848-1851.
- Park, W. K., A. A. Bari, et al. (2002). "Cocaine administered into the medial prefrontal cortex reinstates cocaine-seeking behavior by increasing AMPA receptor-mediated glutamate transmission in the nucleus accumbens." J Neurosci **22**(7): 2916-2925.
- Parkinson, J. A., P. J. Willoughby, et al. (2000). "Disconnection of the anterior cingulate cortex and nucleus accumbens core impairs Pavlovian approach behavior: further evidence for limbic cortical-ventral striatopallidal systems." Behav Neurosci **114**(1): 42-63.
- Pasricha, N., M. Joels, et al. (2011). "Rapid effects of corticosterone in the mouse dentate gyrus via a nongenomic pathway." J Neuroendocrinol **23**(2): 143-147.
- Patel, P. D., J. F. Lopez, et al. (2000). "Glucocorticoid and mineralocorticoid receptor mRNA expression in squirrel monkey brain." J Psychiatr Res **34**(6): 383-392.
- Paterson, N. E. and A. Markou (2003). "Increased motivation for self-administered cocaine after escalated cocaine intake." Neuroreport **14**(17): 2229-2232.
- Paxinos, G. and C. Watson (1998). The rat brain in stereotaxic coordinates. San Diego, Academic Press.
- Peters, J., R. T. LaLumiere, et al. (2008). "Infralimbic prefrontal cortex is responsible for inhibiting cocaine seeking in extinguished rats." J Neurosci **28**(23): 6046-6053.
- Piazza, P. V., J. M. Deminiere, et al. (1990). "Stress- and pharmacologically-induced behavioral sensitization increases vulnerability to acquisition of amphetamine self-administration." Brain Res **514**(1): 22-26.
- Piazza, P. V. and M. L. Le Moal (1996). "Pathophysiological basis of vulnerability to drug abuse: role of an interaction between stress, glucocorticoids, and dopaminergic neurons." Annu Rev Pharmacol Toxicol **36**: 359-378.
- Piazza, P. V., S. Maccari, et al. (1991). "Corticosterone levels determine individual vulnerability to amphetamine self-administration." Proc Natl Acad Sci U S A **88**(6): 2088-2092.
- Piazza, P. V., M. Marinelli, et al. (1996). "Stress, glucocorticoids, and mesencephalic dopaminergic neurons: a pathophysiological chain determining vulnerability to psychostimulant abuse." NIDA Res Monogr **163**: 277-299.

- Piazza, P. V., F. Rouge-Pont, et al. (1996). "Glucocorticoids have state-dependent stimulant effects on the mesencephalic dopaminergic transmission." Proc Natl Acad Sci U S A **93**(16): 8716-8720.
- Pierce, R. C. and V. Kumaresan (2006). "The mesolimbic dopamine system: the final common pathway for the reinforcing effect of drugs of abuse?" Neurosci Biobehav Rev **30**(2): 215-238.
- Pontieri, F. E., G. Tanda, et al. (1995). "Intravenous cocaine, morphine, and amphetamine preferentially increase extracellular dopamine in the "shell" as compared with the "core" of the rat nucleus accumbens." Proc Natl Acad Sci U S A **92**(26): 12304-12308.
- Potter, E., S. Sutton, et al. (1994). "Distribution of corticotropin-releasing factor receptor mRNA expression in the rat brain and pituitary." Proc Natl Acad Sci U S A **91**(19): 8777-8781.
- Povlock, S. L. and J. O. Schenk (1997). "A multisubstrate kinetic mechanism of dopamine transport in the nucleus accumbens and its inhibition by cocaine." J Neurochem **69**(3): 1093-1105.
- Prasad, B. M., C. Ulibarri, et al. (1996). "Effect of adrenalectomy on the initiation and expression of cocaine-induced sensitization." Psychopharmacology (Berl) **125**(3): 265-273.
- Prasad, B. M., C. Ulibarri, et al. (1998). "Stress-induced cross-sensitization to cocaine: effect of adrenalectomy and corticosterone after short- and long-term withdrawal." Psychopharmacology (Berl) **136**(1): 24-33.
- Przegalinski, E., M. Filip, et al. (2000). "Effect of adrenalectomy and corticosterone on cocaine-induced sensitization in rats." J Physiol Pharmacol **51**(2): 193-204.
- Przewlocki, R., W. Lason, et al. (1987). "The influence of chronic stress on multiple opioid peptide systems in the rat: pronounced effects upon dynorphin in spinal cord." Brain Res **413**(2): 213-219.
- Purdy, R. E. and M. A. Weber (1983). "Enhancement and prolongation of vascular smooth muscle contraction by aldosterone." Blood Vessels **20**(1): 34-43.
- Purdy, R. E., M. A. Weber, et al. (1982). "Vasoconstrictor effects of aldosterone in isolated vascular tissue." Clin Exp Hypertens A **4**(9-10): 1583-1591.
- Rahman, Z., R. H. Ring, et al. (2008). "Inhibition of uptake 2 (or extraneuronal monoamine transporter) by normetanephrine potentiates the neurochemical effects of venlafaxine." Brain Res **1203**: 68-78.

- Redila, V. A. and C. Chavkin (2008). "Stress-induced reinstatement of cocaine seeking is mediated by the kappa opioid system." Psychopharmacology (Berl) **200**(1): 59-70.
- Reul, J. M. and E. R. de Kloet (1985). "Two receptor systems for corticosterone in rat brain: microdistribution and differential occupation." Endocrinology **117**(6): 2505-2511.
- Reynolds, S. M. and K. C. Berridge (2002). "Positive and negative motivation in nucleus accumbens shell: bivalent rostrocaudal gradients for GABA-elicited eating, taste "liking"/"disliking" reactions, place preference/avoidance, and fear." J Neurosci **22**(16): 7308-7320.
- Reynolds, S. M. and K. C. Berridge (2003). "Glutamate motivational ensembles in nucleus accumbens: rostrocaudal shell gradients of fear and feeding." Eur J Neurosci **17**(10): 2187-2200.
- Ritz, M. C., E. J. Cone, et al. (1990). "Cocaine inhibition of ligand binding at dopamine, norepinephrine and serotonin transporters: a structure-activity study." Life Sci **46**(9): 635-645.
- Robbe, D., M. Kopf, et al. (2002). "Endogenous cannabinoids mediate long-term synaptic depression in the nucleus accumbens." Proc Natl Acad Sci U S A **99**(12): 8384-8388.
- Robbins, T. W. and B. J. Everitt (1996). "Neurobehavioural mechanisms of reward and motivation." Curr Opin Neurobiol **6**(2): 228-236.
- Roberts, D. C. and G. Vickers (1988). "Increased motivation to self-administer apomorphine following 6-hydroxydopamine lesions of the nucleus accumbens." Ann. NY Acad. Sci.
- .
- Rodaros, D., D. A. Caruana, et al. (2007). "Corticotropin-releasing factor projections from limbic forebrain and paraventricular nucleus of the hypothalamus to the region of the ventral tegmental area." Neuroscience **150**(1): 8-13.
- Rodd-Henricks, Z. A., D. L. McKinzie, et al. (2002). "Cocaine is self-administered into the shell but not the core of the nucleus accumbens of Wistar rats." J Pharmacol Exp Ther **303**(3): 1216-1226.
- Roosendaal, B. (2003). "Systems mediating acute glucocorticoid effects on memory consolidation and retrieval." Prog Neuropsychopharmacol Biol Psychiatry **27**(8): 1213-1223.

- Roth, K. A., E. Weber, et al. (1983). "Immunoreactive dynorphin-(1-8) and corticotropin-releasing factor in subpopulation of hypothalamic neurons." Science **219**(4581): 189-191.
- Rothman, R. B., M. H. Baumann, et al. (2001). "Amphetamine-type central nervous system stimulants release norepinephrine more potently than they release dopamine and serotonin." Synapse **39**(1): 32-41.
- Rouge-Pont, F., M. Marinelli, et al. (1995). "Stress-induced sensitization and glucocorticoids. II. Sensitization of the increase in extracellular dopamine induced by cocaine depends on stress-induced corticosterone secretion." J Neurosci **15**(11): 7189-7195.
- Sanchez, C. J., T. M. Bailie, et al. (2003). "Manipulation of dopamine d1-like receptor activation in the rat medial prefrontal cortex alters stress- and cocaine-induced reinstatement of conditioned place preference behavior." Neuroscience **119**(2): 497-505.
- Sandi, C., C. Venero, et al. (1996). "Nitric oxide synthesis inhibitors prevent rapid behavioral effects of corticosterone in rats." Neuroendocrinology **63**(5): 446-453.
- Sapolsky, R. M., L. M. Romero, et al. (2000). "How do glucocorticoids influence stress responses? Integrating permissive, suppressive, stimulatory, and preparative actions." Endocr Rev **21**(1): 55-89.
- Schindler, A. G., S. Li, et al. (2010). "Behavioral stress may increase the rewarding valence of cocaine-associated cues through a dynorphin/kappa-opioid receptor-mediated mechanism without affecting associative learning or memory retrieval mechanisms." Neuropsychopharmacology **35**(9): 1932-1942.
- Schmidt, H. D., S. M. Anderson, et al. (2006). "Stimulation of D1-like or D2 dopamine receptors in the shell, but not the core, of the nucleus accumbens reinstates cocaine-seeking behaviour in the rat." Eur J Neurosci **23**(1): 219-228.
- Schmidt, H. D. and R. C. Pierce (2006). "Cooperative activation of D1-like and D2-like dopamine receptors in the nucleus accumbens shell is required for the reinstatement of cocaine-seeking behavior in the rat." Neuroscience **142**(2): 451-461.
- Schomig, E., A. Lazar, et al. (2006). "Extraneuronal monoamine transporter and organic cation transporters 1 and 2: a review of transport efficiency." Handb Exp Pharmacol(175): 151-180.
- Schultz, W. (1986). "Responses of midbrain dopamine neurons to behavioral trigger stimuli in the monkey." J Neurophysiol **56**(5): 1439-1461.

- Self, D. W., W. J. Barnhart, et al. (1996). "Opposite modulation of cocaine-seeking behavior by D1- and D2-like dopamine receptor agonists." Science **271**(5255): 1586-1589.
- Shaham, Y. (1996). "Effect of stress on opioid-seeking behavior: evidence from studies with rats." Ann Behav Med **18**(4): 255-263.
- Shaham, Y., S. Erb, et al. (1998). "CP-154,526, a selective, non-peptide antagonist of the corticotropin-releasing factor1 receptor attenuates stress-induced relapse to drug seeking in cocaine- and heroin-trained rats." Psychopharmacology (Berl) **137**(2): 184-190.
- Shaham, Y., S. Erb, et al. (2000). "Stress-induced relapse to heroin and cocaine seeking in rats: a review." Brain Res Brain Res Rev **33**(1): 13-33.
- Shaham, Y., D. Funk, et al. (1997). "Corticotropin-releasing factor, but not corticosterone, is involved in stress-induced relapse to heroin-seeking in rats." J Neurosci **17**(7): 2605-2614.
- Shaham, Y., D. Highfield, et al. (2000). "Clonidine blocks stress-induced reinstatement of heroin seeking in rats: an effect independent of locus coeruleus noradrenergic neurons." Eur J Neurosci **12**(1): 292-302.
- Shaham, Y. and J. Stewart (1995). "Stress reinstates heroin-seeking in drug-free animals: an effect mimicking heroin, not withdrawal." Psychopharmacology (Berl) **119**(3): 334-341.
- Shalev, U., S. Erb, et al. (2010). "Role of CRF and other neuropeptides in stress-induced reinstatement of drug seeking." Brain Res **1314**: 15-28.
- Shalev, U., D. Highfield, et al. (2000). "Stress and relapse to drug seeking in rats: studies on the generality of the effect." Psychopharmacology (Berl) **150**(3): 337-346.
- Shalev, U., M. Marinelli, et al. (2003). "The role of corticosterone in food deprivation-induced reinstatement of cocaine seeking in the rat." Psychopharmacology (Berl) **168**(1-2): 170-176.
- Shalev, U., M. Morales, et al. (2001). "Time-dependent changes in extinction behavior and stress-induced reinstatement of drug seeking following withdrawal from heroin in rats." Psychopharmacology(156): 98-107.
- Shepard, J. D., J. M. Bossert, et al. (2004). "The anxiogenic drug yohimbine reinstates methamphetamine seeking in a rat model of drug relapse." Biol Psychiatry **55**(11): 1082-1089.

- Shiffman, S. (1982). "Relapse following smoking cessation: a situational analysis." J Consult Clin Psychol **50**(1): 71-86.
- Simmonds, M. A. and C. N. Gillis (1968). "Uptake of normetanephrine and norepinephrine by cocaine-treated rat heart." J Pharmacol Exp Ther **159**(2): 283-289.
- Simon, H., L. Stinus, et al. (1979). "Is the dopaminergic mesocorticolimbic system necessary for intracranial self-stimulation? Biochemical and behavioral studies from A10 cell bodies and terminals." Behav Neural Biol **27**(2): 125-145.
- Sinha, R. (2001). "How does stress increase risk of drug abuse and relapse?" Psychopharmacology (Berl) **158**(4): 343-359.
- Sinha, R., D. Catapano, et al. (1999). "Stress-induced craving and stress response in cocaine dependent individuals." Psychopharmacology (Berl) **142**(4): 343-351.
- Sinha, R., H. C. Fox, et al. (2011). "Effects of adrenal sensitivity, stress- and cue-induced craving, and anxiety on subsequent alcohol relapse and treatment outcomes." Arch Gen Psychiatry **68**(9): 942-952.
- Sinha, R., T. Fuse, et al. (2000). "Psychological stress, drug-related cues and cocaine craving." Psychopharmacology (Berl) **152**(2): 140-148.
- Sirinathsinghji, D. J., K. E. Nikolarakis, et al. (1989). "Corticotropin-releasing factor stimulates the release of methionine-enkephalin and dynorphin from the neostriatum and globus pallidus of the rat: in vitro and in vivo studies." Brain Res **490**(2): 276-291.
- Slikker, W., Jr., M. J. Brocco, et al. (1984). "Reinstatement of responding maintained by cocaine or thiamylal." J Pharmacol Exp Ther **228**(1): 43-52.
- Spealman, R. D. (1995). "Noradrenergic involvement in the discriminative stimulus effects of cocaine in squirrel monkeys." J Pharmacol Exp Ther **275**(1): 53-62.
- Spiga, F., D. M. Knight, et al. (2010). "Differential effect of glucocorticoid receptor antagonists on glucocorticoid receptor nuclear translocation and DNA binding." J Psychopharmacol.
- Spiga, F., D. M. Knight, et al. (2011). "Differential effect of glucocorticoid receptor antagonists on glucocorticoid receptor nuclear translocation and DNA binding." J Psychopharmacol **25**(2): 211-221.

- Spyraki, C., H. C. Fibiger, et al. (1982). "Attenuation by haloperidol of place preference conditioning using food reinforcement." Psychopharmacology (Berl) **77**(4): 379-382.
- Spyraki, C., G. G. Nomikos, et al. (1987). "Intravenous cocaine-induced place preference: attenuation by haloperidol." Behav Brain Res **26**(1): 57-62.
- Stanford, S. C. (1995). "Central noradrenergic neurones and stress." Pharmacol Ther **68**(2): 297-242.
- Stewart, J., H. de Wit, et al. (1984). "Role of unconditioned and conditioned drug effects in the self-administration of opiates and stimulants." Psychol Rev **91**(2): 251-268.
- Stewart, J. and P. Vezina (1988). "A comparison of the effects of intra-accumbens injections of amphetamine and morphine on reinstatement of heroin intravenous self-administration behavior." Brain Res **457**(2): 287-294.
- Swanson, L. W., P. E. Sawchenko, et al. (1987). "The CRH motoneuron: differential peptide regulation in neurons with possible synaptic, paracrine, and endocrine outputs." Ann N Y Acad Sci **512**: 12-23.
- Tasker, J. G., S. Di, et al. (2006). "Minireview: rapid glucocorticoid signaling via membrane-associated receptors." Endocrinology **147**(12): 5549-5556.
- Taylor, D. and B. T. Ho (1978). "Comparison of inhibition of monoamine uptake by cocaine, methylphenidate and amphetamine." Res Commun Chem Pathol Pharmacol **21**(1): 67-75.
- Thiel, K. J., J. M. Wenzel, et al. (2010). "Stimulation of dopamine D2/D3 but not D1 receptors in the central amygdala decreases cocaine-seeking behavior." Behav Brain Res **214**(2): 386-394.
- Trapp, T., R. Rupprecht, et al. (1994). "Heterodimerization between mineralocorticoid and glucocorticoid receptor: a new principle of glucocorticoid action in the CNS." Neuron **13**(6): 1457-1462.
- Ungless, M. A., P. J. Magill, et al. (2004). "Uniform inhibition of dopamine neurons in the ventral tegmental area by aversive stimuli." Science **303**(5666): 2040-2042.
- Vanderschuren, L. J. and B. J. Everitt (2004). "Drug seeking becomes compulsive after prolonged cocaine self-administration." Science **305**(5686): 1017-1019.
- Vialou, V., L. Balasse, et al. (2008). "Altered aminergic neurotransmission in the brain of organic cation transporter 3-deficient mice." J Neurochem **106**(3): 1471-1482.

- Waelti, P., A. Dickinson, et al. (2001). "Dopamine responses comply with basic assumptions of formal learning theory." Nature **412**(6842): 43-48.
- Wanat, M. J., F. W. Hopf, et al. (2008). "Corticotropin-releasing factor increases mouse ventral tegmental area dopamine neuron firing through a protein kinase C-dependent enhancement of Ih." J Physiol **586**(8): 2157-2170.
- Wang, B., Y. Shaham, et al. (2005). "Cocaine experience establishes control of midbrain glutamate and dopamine by corticotropin-releasing factor: a role in stress-induced relapse to drug seeking." J Neurosci **25**(22): 5389-5396.
- Wang, B., Z. B. You, et al. (2007). "Stress-induced relapse to cocaine seeking: roles for the CRF(2) receptor and CRF-binding protein in the ventral tegmental area of the rat." Psychopharmacology (Berl) **193**(2): 283-294.
- Watanabe, Y., N. G. Weiland, et al. (1995). "Effects of adrenal steroid manipulations and repeated restraint stress on dynorphin mRNA levels and excitatory amino acid receptor binding in hippocampus." Brain Res **680**(1-2): 217-225.
- Wilson, R. I. and R. A. Nicoll (2002). "Endocannabinoid signaling in the brain." Science **296**(5568): 678-682.
- Wise, R. A. (2004). "Dopamine, learning and motivation." Nat Rev Neurosci **5**(6): 483-494.
- Wise, R. A. (2008). "Dopamine and reward: the anhedonia hypothesis 30 years on." Neurotox Res **14**(2-3): 169-183.
- Wise, R. A. and M. A. Bozarth (1987). "A psychomotor stimulant theory of addiction." Psychol Rev **94**(4): 469-492.
- Wise, R. A. and L. M. Colle (1984). "Pimozide attenuates free feeding: best scores analysis reveals a motivational deficit." Psychopharmacology (Berl) **84**(4): 446-451.
- Wise, R. A., A. Murray, et al. (1990). "Bromocriptine self-administration and bromocriptine-reinstatement of cocaine-trained and heroin-trained lever pressing in rats." Psychopharmacology (Berl) **100**(3): 355-360.
- Wise, R. A. and P. P. Rompre (1989). "Brain dopamine and reward." Annu Rev Psychol **40**: 191-225.
- Wise, R. A. and H. V. Schwartz (1981). "Pimozide attenuates acquisition of lever-pressing for food in rats." Pharmacol Biochem Behav **15**(4): 655-656.
- Wise, R. A., J. Spindler, et al. (1978). "Neuroleptic-induced "anhedonia" in rats: pimozide blocks reward quality of food." Science **201**(4352): 262-264.

- Wright, S. H. and W. H. Dantzer (2004). "Molecular and cellular physiology of renal organic cation and anion transport." Physiol Rev **84**(3): 987-1049.
- Wu, X., R. Kekuda, et al. (1998). "Identity of the organic cation transporter OCT3 as the extraneuronal monoamine transporter (uptake2) and evidence for the expression of the transporter in the brain." J Biol Chem **273**(49): 32776-32786.
- Zhang, L., M. J. Dresser, et al. (1997). "Cloning and functional expression of a human liver organic cation transporter." Mol Pharmacol **51**(6): 913-921.
- Zwart, R., S. Verhaagh, et al. (2001). "Impaired activity of the extraneuronal monoamine transporter system known as uptake-2 in Orct3/Slc22a3-deficient mice." Mol Cell Biol **21**(13): 4188-4196.