



Durham E-Theses

Short duration reservoir-release impacts on impounded upland rivers

TOSNEY, JONAH,JAMES

How to cite:

TOSNEY, JONAH,JAMES (2013) *Short duration reservoir-release impacts on impounded upland rivers*, Durham theses, Durham University. Available at Durham E-Theses Online: <http://etheses.dur.ac.uk/6976/>

Use policy

The full-text may be used and/or reproduced, and given to third parties in any format or medium, without prior permission or charge, for personal research or study, educational, or not-for-profit purposes provided that:

- a full bibliographic reference is made to the original source
- a [link](#) is made to the metadata record in Durham E-Theses
- the full-text is not changed in any way

The full-text must not be sold in any format or medium without the formal permission of the copyright holders.

Please consult the [full Durham E-Theses policy](#) for further details.

**Short duration reservoir-release impacts on impounded
upland rivers**

Jonah James Tosney

Thesis submitted for the degree of Doctor of Philosophy

Durham University

December 2012

Abstract

The increasing number and scale of river impoundments throughout the 19th and 20th centuries means that the management of these impoundments is crucial to the future of global riverine biota. Impoundments such as reservoirs can affect rivers in a variety of ways, not least through the reduction in amplitude of the natural hydrograph, depriving rivers of ecologically important spate flows.

Many reservoir operators conduct regular safety tests, known as scour releases, during which large quantities of impounded water are released directly into rivers. This project assesses the impact of these releases on the hydrology and physio-chemistry of the receiving water bodies as well as upon fish movements and benthic macroinvertebrate abundance and diversity downstream of the reservoirs. The potential of such releases to mimic natural spate flows for ecological gain is also examined.

The work took place in the Yorkshire Water catchment area in northern England between 2007 and 2010. Passive Integrated Transponder (PIT) telemetry was used to assess the responses of brown trout *Salmo trutta* to these short-duration releases. Tagged fish were able to maintain position during the releases and showed no evidence of wash-out or upstream migratory movements associated with the releases.

Changes to macroinvertebrate abundance, diversity and community structure associated with the release were also examined. Some sites showed significant wash-out and community change following the releases while other sites were unchanged. Communities at impacted sites returned to pre-release structures within weeks of the releases.

Analysis of habitat use and characteristics suggest the responses of fish and macroinvertebrates to these reservoir releases were linked to habitat heterogeneity and the use of flow refugia. The negative impacts associated with the scour releases were minimal, while mimicked spate releases may improve salmonid spawning habitat and could re-introduce valuable flow variability to impounded catchments.

Acknowledgments

Thank you to my supervisors Stuart Lane, Martyn Lucas and Mark Tinsdeall, without whom this study would not have been possible.

Throughout the course of this PhD I have been assisted by a number of people at Yorkshire Water Services, the Environment Agency and Durham University. At Yorkshire Water I would like to thank Sarah Gledhill, James Kitson, Simon Womersley and Simon Firth who have given me a lot of time and assistance. At the Environment Agency Julie Winterbottom, Dan Smallwood and Rob Wood have been extremely generous with their support. For their assistance with field work and general support I would also like to thank David Higgins, Josh Gibb and Carly Maynard.

Most importantly, I would like to thank Penny, Hetty, Ned, and both our families for their support and patience.

Chapter 1: An introduction to the ecological impacts of reservoirs and reservoir releases ...7	
1.1 Project background.....7	7
1.2 Physical consequences of impoundment.....10	10
1.2.1 Changes to flow10	10
1.2.2 Changes to water quality10	10
1.2.3 Changes to sediment regime12	12
1.3 Ecological consequences of impoundment13	13
1.3.1 Effects on macroinvertebrate populations.....13	13
1.3.2 Effects on fish15	15
1.4 The history of flow management16	16
1.5 Spate flows and the need for flow variability17	17
1.6 Floods, engineered spates and reservoir releases18	18
1.7 The hydrological and physiochemical impacts of short duration reservoir releases.....19	19
1.7.1 Suspended sediment.....20	20
1.7.2 Water temperature.....23	23
1.7.3 Dissolved oxygen24	24
1.7.4 pH.....26	26
1.7.5 Summary of possible physio-chemical effects of reservoir releases28	28
1.8 Study catchment ecology and potential ecological impacts.....30	30
1.8.1 Macroinvertebrate populations.....30	30
1.8.2 Fish populations36	36
1.9 The influence of habitat type.....42	42
1.9.1 Habitat heterogeneity and the concept of flow refugia43	43
1.10 Summary44	44
1.11 Key research questions.....45	45
Chapter 2: Field site selection and methodological overview47	47
2.1 Introduction47	47
2.2 Field site selection and naming47	47
2.3 Fieldwork rationale50	50
Chapter 3: Properties of the study site reservoirs and releases54	54
3.1 Introduction54	54
3.2 Reservoir design.....54	54
3.2.1 Mechanism of release.....57	57
3.3 Spate design57	57
3.4 Effects of the study reservoirs on stream flow.....60	60
3.5 Effects on water quality62	62
3.6 Inlet and outlet temperatures.....64	64
3.7 Sediment accumulation and release64	64
3.8 Water quality summary and implications65	65
3.9 Conclusions65	65
Chapter 4: Understanding the physiochemical impacts of short-duration reservoir releases66	66
4.1 Introduction66	66
4.2 Methodology66	66
4.2.1 Flow67	67
4.2.2 Water temperature.....73	73

4.2.3	pH and dissolved oxygen	73
4.2.4	Suspended sediment	73
4.3	Results	75
4.3.1	Pilot investigations	75
4.3.2	Scour releases, Catchment 1 Autumn 2008	80
4.3.3	Scour releases, Catchment 1 Spring 2009	84
4.3.4	Scour and spate releases, Catchment 2, Autumn 2009	92
4.4	Discussion	101
4.5	Conclusions	104
Chapter 5:	Macroinvertebrate responses to reservoir releases	106
5.1	Introduction	106
5.2	Methodology	106
5.2.1	Fieldwork timeline	106
5.2.2	Site selection	106
5.2.3	Sampling techniques	108
5.2.4	Measurement of physical characteristics	111
5.2.5	Macroinvertebrate identification	112
5.2.6	Univariate and multivariate analysis	113
5.3	Results	115
5.3.1	Validation data	115
5.3.2	Scour releases, Catchment 1, Autumn 2008	119
5.3.3	Scour releases, Catchment 1, Spring 2009	122
5.3.4	Scour and spate releases, Catchment 2, Autumn 2009	129
5.3.5	Correlation of results with physical data	139
5.3.6	Summary of results	140
5.4	Discussion	140
5.5	Conclusions	142
Chapter 6:	Brown trout responses to reservoir releases	144
6.1	Introduction	144
6.2	Methodology	144
6.2.1	Tracking fish movements	144
6.2.2	Site selection	146
6.3.3.	Fish tagging	149
6.3.4	Fish habitat measurements	157
6.3.5	Recruitment success	158
6.4	Results	158
6.4.1	Scour releases, Catchment 1, Autumn 2008	159
6.4.2	Scour releases, Catchment 1, Spring 2009	161
6.4.3	Scour and spate releases, Catchment 2, Autumn 2009	163
6.4.4	Recruitment effects	169
6.5	Discussion	170
6.5.1	Home range data	170
6.5.2	Responses to reservoir releases	171
6.5.3	Responses to natural spates	174
6.5.4	Recruitment effects	174
6.6	Conclusions	175
Chapter 7:	Habitat heterogeneity, flow refugia and brown trout habitat usage	176
7.1	Introduction	176
7.2	Study site habitat characteristics	176
7.3	Methodology	178

7.3.1	Catchment habitat surveys	178
7.3.2	Trout habitat usage surveys.....	179
7.4	Results	180
7.4.1	General site habitat results	180
7.4.2	Trout habitat usage results	183
7.4.3	Multivariate habitat analyses.....	194
7.5	Discussion	194
7.6	Conclusions	195
Chapter 8: Synthesis, conclusions and recommendations.....		197
8.1	Introduction	197
8.2	Summary of results	197
8.2.1.	How do the releases affect the hydrology of the receiving water bodies?.....	197
8.2.2.	Do the releases have any impact upon water quality downstream of the reservoirs?	198
8.2.3.	What are the impacts of the releases upon downstream fish and invertebrates?	200
8.2.4	What role does in-stream habitat play in determining these impacts?.....	202
8.2.5	Could it be ecologically beneficial to use the scour releases to mimic natural spate events?.....	203
8.3	Future reservoir release management.....	205
8.4	A wider perspective.....	207
8.5	Potential for further research.....	208
References		211

Chapter 1: An introduction to the ecological impacts of reservoirs and reservoir releases

1.1 Project background

The majority of rivers in the UK and the developed world are now impounded in some way. The purposes of these impoundments vary from drinking water supply to irrigation, hydropower and flood protection (Petts 1984, Dynesius and Nilsson 1994). The hydrological and ecological impacts are profound and diverse, and are continually growing as our demand for water across the globe increases (Pearce 2006).

Historically, the impoundment of rivers and the consequential modification of hydrological regimes has been potentially disastrous for downstream users of river water. Under the laws governing reservoir construction in the UK and elsewhere the operators have often been obliged to release sufficient water (known as compensation flow) from the impoundments to prevent problems further downstream (Gore and Nestler 1988, Mould 2006, Old and Acreman 2006, Acreman 2007). These compensation flow agreements often only required the release of water during working hours (although in practice round the clock steady flows have been the norm), and were usually based upon a minimum proportion of the average daily pre-impoundment flow, often one quarter to one third (Old and Acreman 2006).

Following the construction of the first large reservoirs it became apparent that the impoundments were preventing the passage of migrating fish and leading to declines in stock levels (Raymond 1979, Burt and Mundie 1986), and subsequently pressure has been growing to manage the flows with as much sensitivity to riverine ecology as possible. This pressure has resulted in attempts around the globe to set ecologically friendly flow regimes (Petts 1984, Craig and Kemper 1985, Gibbins et al. 2001, Robinson and Uehlinger 2003, Mould 2006, Old and Acreman 2006, Acreman 2007, Sophocleous 2007, Petts 2009, Olden and Naiman 2010a). As a consequence, compensation flows are now commonly known as “environmental flows”.

Compensation flows from UK reservoirs have remained largely unchanged since construction. In recent years both water supply companies and regulatory bodies have

recognised the need and the potential to improve the health of impounded rivers by altering compensation flow regimes. This recognition has resulted in a series of flow trials, followed by permanent alterations to flows in some catchments with the aim of benefiting the downstream biota (Gibbins et al. 2001, Mould 2006). This project aims to build on that work by assessing the potential for and consequences of re-introducing essential variability to the existing flow regimes in the form of mimicked spate flows.

This study is set in the catchment of UK water provider Yorkshire Water Services in northern England. Every major river in the Yorkshire Water region has been impounded for many decades, mostly by reservoirs now used for water supply but often originally built to power downstream industries. Yorkshire Water Services now operate more than 120 impounding reservoirs in a catchment area of approximately 11900 km². The vast majority of Yorkshire's reservoirs were constructed to their present design under acts of parliament in the period between 1800 and 1950.

In conjunction with the England and Wales regulatory body the Environment Agency, Yorkshire Water has been exploring the possibilities of re-designing reservoir releases to improve downstream ecology for the past decade. In addition to re-modelling basal compensation flows, Yorkshire Water also introduced annual trial spate flows to Study Catchment 2 (Section 2.2) in 2005. These releases were designed in conjunction with the Environment Agency and Durham University in response to the growing understanding of the need to re-introduce flow variability to impounded rivers (Old and Acreman 2006, Acreman 2007) and are designed to mimic natural high-flow events. The potential benefits of these spate flows are discussed in Section 1.5.

Following the introduction of the European Water Framework Directive (2000) to the UK, it became apparent that the work undertaken on compensation and spate flows might be used to bring these impounded rivers to the newly required ecological condition. The receiving rivers are termed "heavily modified water bodies" under the directive and as such are required to achieve "good ecological potential" by 2015. The ecological status of a water body is judged on "*the composition and abundance of aquatic flora, invertebrate and fish fauna. Hydromorphological contributors to these elements include hydrological regime, river continuity and morphological conditions. The chemical and physio-chemical elements supporting the biological elements include thermal, oxygenation and nutrient*

conditions” (Annex V of Water Framework Directive, 2000), all of which may be influenced to a degree by reservoir discharge. As the directive is applicable across the European Union and will possibly encourage similar legislation around the globe the original project took on a much broader context, as practices adopted here may be transferable to other water supply companies.

Although the introduction of the spate releases by Yorkshire Water in 2005 had theoretical benefits for the receiving water body, it was essential to understand the precise ecological impacts before the releases could be introduced to further catchments. If spate releases were to be introduced to UK reservoirs then the point of the release at most sites would be the scour valve with which the vast majority of reservoirs are equipped. This valve is designed to allow the draw-down of the reservoirs at a rapid rate if required (for example if structural problems were detected in a dam wall). These scour valves are also commonly used to remove fine sediment accumulated on the reservoir bed (hence the name), and often also to deliver compensation flows where necessary. The valves typically draw water from deep in the reservoir, and are tested twice yearly as part of UK water companies’ safety responsibilities under the Reservoirs Act (1975). During the tests these discharge valves are opened to their full extent and then fully closed, causing rapid changes to the hydrology of the receiving water body. If the spate releases were to be introduced to more catchments they would be performed in the same way as these scour tests, but over a longer duration and with a steadily graded opening and closing of the release valve. Table 1 below summarises the types of releases from Yorkshire Water reservoirs.

Table 1: Types of reservoir releases performed by Yorkshire Water Services. Pseudonyms are used for reservoir and catchment names due to a confidentiality agreement (Section 2.2).

Release Type	Duration	Regularity	Location	Purpose
Scour release	Typically 20 mins to 4 hours	Twice yearly	All YW reservoirs	Ensure valves and pipes are fully operational
Spate release	Full day	Once yearly	Dipper and Blackbird reservoirs (Study Catchment 2) only	Trial releases aimed at enhancing river ecology
Compensation release	Constant	Constant	Majority of YW reservoirs	Maintain in-stream base flow

1.2 Physical consequences of impoundment

1.2.1 Changes to flow

The most obvious physical consequence of river impoundment is the change to the flow regime downstream of the dam. As the purpose of reservoirs is to store and harvest water, the water bodies downstream of reservoir dams generally receive less water than they naturally would. The flow regime is also often altered dramatically as the dams hold back water during periods of heavy rain until they are full, diminishing or removing natural floods. Conversely, if abstraction is low a full reservoir may continue to overspill after a flood event would naturally have ceased.

The importance of flow to aquatic ecosystems (with particular reference to setting environmental flows) was described by Bunn and Arthington (2002) using the following four key principles:

1. Flow is a major determinant of physical habitat in streams which in turn is a major determinant of biotic composition.
2. Aquatic species have evolved life history strategies primarily in direct response to the natural flow regimes.
3. Maintenance of natural patterns of longitudinal and lateral connectivity is essential to the viability of populations of many riverine species.
4. The invasion and success of exotic and introduced species in rivers is facilitated by the alteration of flow regimes.

These principles describe well the problems faced by riverine biota due to changes in flow regime associated with major impoundments and illustrate many of the problems seen in the Yorkshire Water catchment. How the impoundments affect the hydrology of the rivers examined in this study is described in Chapter 3.

1.2.2 Changes to water quality

In addition to simply changing the flow regime of the receiving river, reservoirs are also capable of changing water quality (Tiessen et al. 2011). The reservoirs in the Yorkshire Water catchment are typically between 10 and 40 metres deep, with relatively low outflows (compensation flows usually set at less than 0.5% of total reservoir volume per

day). Water generally has a long residence time in the reservoirs, and is subject to little perturbation, even at the inlets where stilling ponds (known as residuum lodges) and baffles are often constructed to decrease sedimentation in the reservoir and to prevent damage to the reservoir structure during periods of heavy rain. Consequently the reservoirs display many of the physical characteristics of deep lakes.

Upland streams such as those in the study area are typically fast flowing, oxygen rich (due to their shallow depth and good aeration), and responsive to changes in air temperature, especially on the de-forested moorlands (Crisp and Howson 1982, Webb and Crisp 2006). The retention of water by the reservoirs, however, can change these properties dramatically. As with lakes, reservoirs can be subject to thermal and chemical stratification (Craig and Kemper 1985, Petts 1986, Moss 1998). In the Summer months the sun warms the upper layers of the water, and the less dense warm water traps the denser, cooler water in the hypolimnion below. In the Winter months, if the water temperature sinks below the 4°C at which water is most dense, the colder water rises to the top, covering a layer of warmer water. As compensation water (and also the water from scour and spate releases) is typically released from deep in the reservoir, the temperature of water entering the stream may be markedly different from that seen prior to impoundment, and reservoirs therefore not only regulate river flow, but also river water temperature (Petts 1986, Webb and Walling 1993, Lowney 2000, Lessard and Hayes 2003, Archer 2008a, Olden and Naiman 2010a). Typical effects upon the temperature of the river water downstream are:

1. a delay to natural seasonal warming and cooling as the reservoir is slow to warm in Spring and slow to cool in Autumn,
2. a change in the mean temperature, and
3. a diminution of the variation in water temperatures both daily and annually as the reservoir water is protected from the higher frequency variations in air temperature that have such a strong influence of the temperature of unregulated streams (Webb and Walling 1993, 1996).

During Summer, the upper layers of the reservoir are also likely to contain far greater levels of dissolved oxygen than the lower layers due to atmospheric mixing, input from photosynthesising phytoplankton, and also possible production by plants in the upper layers where sufficient light penetrates. The lower layers contain far less oxygen, due to

the lack of mixing with the surface waters, the lack of oxygen production at depth, and the use of the available oxygen by the decaying detritus, which sinks to the bottom.

Due to the prolonged residence time and lack of mixing, a variety of other chemical changes may also be seen in the deep reservoir waters. For example, the stilling of the waters often allows an accumulation and growth of phytoplankton not normally seen in running waters (Petts 1984, Echevarria and Rodriguez 1994). The plankton fixes nutrients which would otherwise be flushed through the system, and as both living and dead plankton are exported with the reservoir releases, the water often contains unnaturally high quantities of carbon, nitrogen and phosphorus (Baldwin et al. 2010). Equally, the acidity of the reservoir water may be affected - as dead organic matter accumulates on the reservoir bed and decays anaerobically, pH levels fall. This decaying matter releases carbon dioxide and hydrogen sulphide, both of which are toxic in high concentrations. The water from deep reservoirs is also often characterised by enhanced levels of ammonia and phosphate (Foulger and Petts 1984, Petts 1986). Acidification of the water also allows the dissolution of heavy metals which may be present in the sediment or bedrock (Petts 1984), particularly in areas which have previously been mined, as the Pennines have, for both lead and coal.

1.2.3 Changes to sediment regime

In addition to affecting the water chemistry, reservoirs also have an impact upon the sediment budget of the impounded river. An unimpounded river acts as a continuous conveyor of sediment, which shapes channel morphology (Petts 1980, 1984, Craig and Kemper 1985), and also provides an essential nutrient input for the resident biota in the form of particulate organic matter (Cummins 1973, Cummins and Klug 1979, Vannote et al. 1980, Allen 1995, Moss 1998). As a stream enters a reservoir the water slows, losing energy and depositing its sediment onto the reservoir bed. As the compensation water is extracted from above the bed and towards the front end of the reservoirs, it carries very little coarse sediment, and even in flood events the water spilling from a full reservoir comes from the upper levels and carries very little suspended material. This can result in the starvation of the downstream river bed of its sediment supply, and along with the changes to flow can alter the morphology and therefore the habitat type (Greenwood et al. 1999, Gilvear 2004, Petts and Gurnell 2005). The loss of natural spate events also poses

problems by removing the mechanism that cleanses fine sediment that does accumulate from gravel beds, allowing choking of the interstitial spaces utilised by fish and invertebrates (Owens et al. 2005, Petticrew et al. 2007). This choking of the gravel beds can decrease the quality and quantity of salmonid spawning habitat, and can become a limiting factor in salmonid population density (Heywood and Walling 2006).

1.3 Ecological consequences of impoundment

The physical changes imposed on a river following the construction of a dam have equally pronounced ecological impacts. These have been recognised since the industrial revolution, when it became apparent that the construction of large dams was preventing migratory fish such as trout and salmon from returning to their spawning grounds (Old and Acreman 2006). The diverse ecological impacts have now been studied in detail and are reasonably well understood (Petts 1984, Craig and Kemper 1985, Bunn and Arthington 2002). Vannote's River Continuum Concept (1980) recognises that the changing gradients of biotic and abiotic factors from headwater to sea are the chief determinants of community make-up at any given point on a natural river. The disruption of this continuum by impoundment has the potential to change both the biotic and abiotic character of the river, and it is the serial discontinuity concept (Ward and Stanford 1983, Stanford and Ward 2001) which provides a conceptual basis for understanding the impacts impoundments have on natural river systems. The changes to flow, water quality, nutrient and resource delivery and sediment regime caused by this discontinuity impact upon almost all aspects of the ecology of the water bodies downstream of impoundments. These effects can be so great that impounded rivers may be markedly ecologically different from their pre-impoundment state. This is particularly well highlighted in the work of Trevor Crisp on the effects of the impoundment of the River Tees by Cow Green Reservoir in northern England (Crisp et al. 1978, Crisp et al. 1983, 1990, Crisp and Mann 1991, Crisp 1994) which is considered later in this chapter. The vast majority of the ecological impacts recorded in the literature focus upon benthic macroinvertebrates and fish, however impacts upon periphyton (Collier 2002) and macrophyte life (Garcia De Jalon et al. 1994, Richardson et al. 2002) have also been demonstrated.

1.3.1 Effects on macroinvertebrate populations

River impoundment can have serious impacts on macroinvertebrate communities. In the case of fish, the organisms are usually large enough and their biology sufficiently well

understood to allow the study and understanding of the effects of impoundment upon a single species (Section 1.3.2). This is not usually the case with macroinvertebrates; nevertheless studies at the community level show marked changes in both abundance and diversity of invertebrates in rivers following impoundment.

The study of the effects of the construction of Cow Green Reservoir in northern England is particularly instructive. The work of Patrick Armitage on the changes to the invertebrate fauna downstream of the reservoir reveals a number of critical impacts. The alteration and stabilisation of environmental conditions over the 30 years following impoundment favoured a proportion of the taxa at the expense of others, with 19 out of 31 abundant taxa declining in abundance by a factor of five or more following dam construction (Armitage 2006). Chironomidae proliferated in the reservoir itself (Armitage 1983) and began to comprise a greater part of the diet of the fish downstream (Crisp et al. 1978). The quantity of drifting benthos also increased below the reservoir, with a distinct increase in algae and micro-crustacea from the reservoir (Armitage 1977b). This probably accounted for the increased growth rates recorded in brown trout *Salmo trutta* and bullhead *Cottus gobio* post impoundment (Crisp and Mann, 1991). The biomass of macroinvertebrates in the river below the reservoir increased following impoundment (Armitage 1977a), possibly as a result of nutrient enrichment and more stable flow conditions allowing the proliferation of moss and algae on the river bed (Armitage 1976).

The findings from Cow Green reflect the patterns seen in other studies from all round the world, with an increase in macroinvertebrate abundance and decrease in diversity being commonly seen downstream of impoundments. In a similar study to those of Armitage, Spence and Hynes (1971) likened the community changes below a reservoir to those seen in cases of organic enrichment, while Raddum (1985) attributed community changes to a warming due to the increased temperature of compensation release water. Jackson et al (2007) found temperature and flow to be the two strongest contributing factors to community changes in the River Lyon (UK) post impoundment. Each of these studies records certain plecopteran (stonefly) taxa as declining downstream of the reservoirs post-impoundment and Saltveit et al (1987) note that this order are particularly sensitive to the changes wrought by impoundment.

1.3.2 Effects on fish

The most obvious and possibly the best understood impact of river impoundment upon fish is the prevention of migration following the introduction of a large, impassable barrier. A large proportion of river-dwelling freshwater fish migrate at some point in their life cycle and impassable dams may completely isolate certain species from upstream spawning grounds, and can lead to population fragmentation or complete exclusion of these species from impounded sections of the river (Lucas and Baras 2001). The number of affected species in the UK alone is long, including, amongst others, brown trout (Aarestrup and Jepsen 1998), Atlantic salmon *Salmo salar* (Thorstad et al. 2008), barbel *Barbus barbus* (Lucas and Frear 1997), river lamprey *Lampetra fluviatilis* (Lucas et al. 2009), bullhead (Utzinger et al. 1998) and European eel *Anguilla anguilla* (Acou et al. 2008). Even in situations where impoundments do not prevent migration, the presence of the barrier may delay migrations and cause injury and mortality amongst fish attempting to pass (Raymond 1979).

Other less obvious effects of impoundment are also seen. As flow is a major determining factor of fish habitat selection and impoundment can dramatically alter the flow regime, the type of fish to which the river reach is best suited may change following impoundment, leading to changes in fish assemblages (Bunn and Arthington 2002, Gido et al. 2002).

In a catchment similar to those studied here, Crisp (1978) found that the diets of brown trout, bullhead and minnow *Phoxinus phoxinus* in the River Tees all changed significantly following impoundment of the river. Chironomidae became increasingly important in the diet post-impoundment, while the proportion of terrestrial organisms in the diet of the trout decreased as supply from upstream decreased. The length-for-age of minnows decreased, along with their fecundity, while length-for-age of the bullheads increased (Crisp and Mann 1991). Numbers of bullhead in the river basin downstream of the impoundment increased following impoundment, but the effects on minnow populations are unrecorded (Crisp et al. 1983). Crisp's studies show the brown trout populations adapted well to the damming of the river. Although the return of sea-trout (the anadromous form of brown trout) to the headwaters was no longer possible, adult brown trout migrated into the reservoir to feed prior to returning to the headwaters to spawn, and numbers of trout in the catchment increased overall in the years following impoundment (Crisp et al. 1990). The

life-cycle of the brown trout allows for this kind of adaptation (Section 1.8.2), however species that require time at sea, such as the Atlantic salmon would have been permanently excluded from potential upstream spawning grounds.

This pattern of extirpation of migratory species upstream of impoundments and re-balancing of community make-up as the habitat becomes more favourable for some species than others downstream is also observed amongst a totally different fauna in impounded upland streams in the southern USA (Kashiwagi and Miranda 2009), where blackside darter *Percina maculate* were extirpated above impoundments and the balance of cyprinids to centrarchids changed both upstream and downstream following impoundment. Similar results are seen in a variety of other studies including Edwards (1978), Quinn and Kwak (2003) and Guenther and Spacie (2006).

1.4 The history of flow management

As described in Section 1.1, the original purpose of many early reservoir releases was to serve the needs of industrial downstream water users with little or no consideration given to the ecological welfare of the waterbody (Gore and Nestler 1988, Old and Acreman 2006, Acreman 2007). Subsequent attempts at flow management have built upon these severely altered or minimal flow regimes. Early management plans were often based on perceived minimum flow requirements of a single species, typically a fish of sporting or commercial value such as a species of salmon or trout (Poff et al. 1997). Methods used to gauge these minimum flows have advanced from basic estimates of the volume of release required to maintain a continuous flow downstream of the impoundment to complex models used to gauge the effects of varying flows on areas of available habitat. The most commonly used of the modelling approaches is perhaps Instream Flow Incremental Methodology (IFIM) (Bovee and Milhous 1978, Orth and Maughan 1982, Stalnaker et al. 1995), developed by the United States government in the 1970s and 1980s. IFIM uses a Physical Habitat Simulation (PHABSIM) model to predict the effects that changing flows will have upon the area of habitat available to a particular species. The species habitat requirements are based upon recorded preferences for depth, velocity and substrate type. This approach is limited by the assumption that habitat availability is the limiting factor for the species of interest, and generally only considers a single species but has nevertheless provided a science-based starting point for flow restoration and has been adopted in many rivers (Spence and Hickley 2000).

More recently, the recognition that flow-setting for a single species is not necessarily beneficial for the wider biota has led to a number of more holistic approaches, based on returning impounded flows to as close to their original regimes as possible. The natural flow paradigm (Poff et al. 1997, Enders et al. 2009) recognises the needs of the ecosystem, rather than the species, and is based on the inherent dynamism of natural fluvial systems. The recognition of the importance of each component of a natural flow regime (droughts, floods etc.) has allowed the development of more complex flow regime models for impounded systems, notably the building block methodology (King et al. 2008), a move away from steady state flows to regimes incorporating periods of high and low flows based on a natural hydrograph. These building blocks are now frequently used in designing compensation releases. At their most basic they allow for periods of high or low flows to suit the habitat requirements of a single species at certain times of year, as seen in the remodelled flows in Yorkshire Water catchments in Mould (2006). At a more advanced level, this technique is the beginnings of a return to an ecologically sustainable, more natural flow regime which takes into account the needs of an entire ecosystem.

1.5 Spate flows and the need for flow variability

Natural spate flows play an essential part in the ecological maintenance of rivers (Junk et al. 1989, Tockner et al. 2000), providing necessary environmental disturbance (Resh et al. 1988, Lake 2000), acting as triggers to migration (Frost and Brown 1967, Elliott 1994) or drift (Brittain and Eikeland 1988, Gibbins et al. 2007) and maintaining habitat for the riverine biota (Reiser et al. 1987, Milhous 1998, Benke 2001). Engineered spate flows have been recognised as a possible solution to some of the problems caused by impoundment for some time (Huntsman 1948, Hayes 1953) and have been used for habitat restoration, such as at Glen Canyon dam, USA (Robinson and Uehlinger 2003) and encouraging upstream migration of salmonids to spawning grounds for example on the North Tyne, UK (Archer 2008b). Spate releases now form a recognised part of global reservoir management plans and are now considered one of the building blocks required to restore acceptable environmental flows (Tharme 2003, Acreman and Dunbar 2004, King et al. 2008). The Water Framework Directive has brought about a surge of interest in the use of spate flows to restore ecological potential in the UK, resulting in a number of reports and recommendations (Black et al. 2005, Old and Acreman 2006, Acreman 2007, Acreman et al. 2009, Acreman and Ferguson 2010) but, as yet, the number of spate releases

implemented in the UK appears to be minimal, and the only spate releases on which studies have been published are from Kielder Reservoir in the Tyne catchment (Gibbins et al. 2001, Archer 2008b) and Roadford Reservoir in south-west England (Sambrook and Gilkes 1994). Kielder is by far the biggest reservoir in the UK in terms of capacity (at 200,000 thousand cubic metres (tcm) it holds approximately 40 times more water than Yorkshire Water's largest reservoir and discharges compensation at $1.3 \text{ m}^3 \text{ sec}^{-1}$, about 20 times the Yorkshire Water norm. Roadford is also much larger than any Yorkshire Water reservoir with a capacity of 34,500 tcm). Should engineered spate flows prove to be a successful tool for restoring ecological potential, their scope for introduction in the UK alone is substantial, with well over 1000 reservoirs around the country, the majority of which are in upland catchments and of a size similar to those studied here.

1.6 Floods, engineered spates and reservoir releases

The existing literature on the physical and ecological impacts of high flow events relevant to this project can be divided into three categories: studies examining natural high flow events such as floods and spates (Dudgeon 1993, Lobón-Cerviá 1996, Benke 2001, Gibbins et al. 2007), studies examining engineered spates designed for ecological benefit (Hayes 1953, Nelson et al. 1987, Ortlepp and Mürle 2003, Scheurer and Molinari 2003, Old and Acreman 2006, Robinson and Uehlinger 2008, Rolls et al. 2011), and studies examining the effects of other types of reservoir release (primarily hydro-peaking releases used for power generation) (Garcia De Jalon et al. 1994, Valentin et al. 1996, Cereghino et al. 2002, Flodmark et al. 2006). The physical impacts and the impacts upon macroinvertebrate and fish populations of each of these types of releases are reviewed in detail in Section 1.8 below.

Although the scour and spate releases examined here share similarities with the flow events in each of the above categories, there are also clear distinctions. In both scour and spate releases the changes in water level approximate those seen in natural high-flow events, although initial observations suggested the rates of change of flow, the duration of peak flow and the maximum flow attained may be different from those expected following a natural high rainfall event. Equally, the quality of water released was expected to differ from a natural event due to the effects of prolonged storage in the reservoirs. The available literature on natural flow events could therefore be used to predict possible biotic impacts, although the differing abiotic factors may lead to differing results.

The engineered spate events described in the literature also shared similarities with the releases examined in this project, however, again, the scour and spate releases differed considerably in two key aspects. Firstly, the engineered spates described were designed for ecological or geo-morphological benefit, and the rates of change of flow were intended to mimic natural spate events, unlike the scour releases. These releases therefore tend to be of a longer duration with lesser rates of relative change of discharge. Secondly, no literature could be found on releases from reservoirs of a comparable size to those in the study area. Although the larger releases studied were more likely to have a measurable ecological impact, reservoirs of comparable size to those in the literature are uncommon in the UK and the results of releases from these smaller, more typically sized reservoirs would have greater transferability. The majority of studies also concentrate on changes to either water temperature caused by deep water releases from stratified reservoirs (Raddum 1985, Barillier et al. 1993, Paller and Saul 1996, Carron and Rajaram 2001, Jackson et al. 2007, Rader et al. 2008), or from the increases in suspended sediment caused by sediment released from the reservoir itself or scoured from the river bed and banks by the elevated flows (Gilvear and Petts 1984, Petts et al. 1985, Barillier et al. 1993, Petticrew et al. 2007).

The scour releases performed by UK reservoir operators are perhaps most directly comparable to hydro-peaking flows used for power generation, however unlike hydro-peaking releases, both the scour and spate releases are relatively rare events, possibly with sufficient time between releases to allow the biota to recover. The reaches below the release reservoirs are therefore less likely to be denuded by repeated extreme disturbance than those below hydropower dams. As with the other engineered releases, the hydro-peaking flows studied in the available literature are of greater magnitude than the releases from the study catchment reservoirs.

1.7 The hydrological and physiochemical impacts of short duration reservoir releases

In order to achieve a broad understanding of the physiochemical impacts of releases from the smaller reservoirs typical of the study area an analysis of the expected impacts was undertaken, considering both the available literature and expected impacts based on the reservoir structures and the mode of operation of the releases planned in this study.

1.7.1 Suspended sediment

One of the more obvious expected physical impacts of both spate and scour releases is an increase in the concentration of suspended sediment in the water column during the elevated flows, accompanied by a possible scouring of sediment from the bed and banks close to the release source and a deposition downstream as the wave subsides. One of the original purposes of the UK scour releases was to flush the release pipes of accumulated sediment, and a darkening of river water has frequently been reported by the public during reservoir releases in England. Additionally, each of the study reservoirs empties into a stilling pool prior to the water entering the river, and each of these pools is designed to act as a sediment trap. It was expected that the force of the release would be sufficient to mobilise at least some of this sediment. It was also expected that the release wave may have sufficient energy to entrain sediment from the river banks and river bed, further increasing the amount of sediment carried by the stream, although a study of a scour release from a Welsh reservoir with a far greater maximum discharge (Llyn Clywedog, Wales, discharge up to $36 \text{ m}^3\text{s}^{-1}$) showed that while considerable changes to quantities of suspended sediment did occur, changes to bed sediment and channel morphology were limited (Leeks and Newson 1989). Although the release monitored in the Leeks and Newson study failed to impact significantly upon bed sediment, the release was preceded by large natural floods which may have removed loose sediment, and the authors cite an earlier unpublished report in which a scour release did transport large quantities of bed sediment and also alter the channel morphology.

One would expect the longitudinal extent of the increase in suspended sediment concentration to be determined by the force of the release (a product of the diameter of the outflow pipe and the head produced by the volume of water in the reservoir on release day), and also by the geomorphology of the receiving channel (gradient, bed roughness, vegetation, channel braiding, channel straightness, presence of weirs and draw-off channels). For these reasons it was important to measure not just the quantity of sediment in the water at the release site, but also at sites further downstream to attempt to determine both the origin and the fate of the transported sediment. An increase in suspended sediment concentration may also impact upon the water chemistry, particularly if a large proportion of the sediment is organic. Baldwin (2010) noted an increase in carbon, nitrogen and phosphorus downstream of a reservoir release, caused by the mass export of

phytoplankton, while other studies have recorded an increase in organic carbon again associated with mobilised plankton and periphyton (Gilvear and Petts 1984, Dionne and Thérien 1997). If this carbon-rich sediment is deposited on the river bed downstream of the dam it may lead to an increase in biological oxygen demand, depriving the resident biota of oxygen.

The impacts that anthropogenic increases in suspended sediment levels have upon fish are diverse, ranging from short term behavioural changes to long term population decline (Kemp et al. 2011). Solbé (1997) notes that suspended sediment concentrations of up to 25 mg l⁻¹ seem to have no harmful effect upon fish, but may cause problems if the sediment settles out over spawning beds, and a further study found that no harmful effects were seen in coho salmon *Oncorhynchus kisutch* below 40 g l⁻¹, but concentrations above this could cause gill and soft tissue damage, and mortality was recorded at concentrations above 100 g l⁻¹ (an order of magnitude greater than concentrations typically found in salmonid rivers) (Lake and Hinch 1999). A study on sediment flushing from an Italian reservoir (Crosa et al. 2010) where sediment was not regularly removed by reservoir releases found increases in in-stream suspended sediment concentrations of up to 70 – 80 g l⁻¹, an associated reduction of fish densities (measured by electric fishing surveys) and an overall decrease in biomass. The same author recommended concentrations of sediment during releases should be restricted to a daily average of 10 g l⁻¹.

Despite the negative effects generally associated with an increase in suspended sediment levels (described as “a correlate of imperilment for native riverine fishes” (Sutherland and Meyer 2007)), Robertson et al (2007) found increased foraging behaviour in Atlantic salmon at increasing concentrations from 0 to 180 mg l⁻¹ with a decline in this behaviour seen at higher concentrations. The increased invertebrate drift associated with increasing flows could certainly provide enhanced feeding opportunities for brown trout in the study area if they are capable of taking advantage. Despite this initial improved foraging opportunity, the decline in activity at higher concentrations supports the reports that high concentrations of suspended sediment are physically harmful to salmonids, and any gain in feeding potential is countered by the risk of physical harm at higher concentrations.

The effects of increasing suspended sediment concentrations and depositions upon macroinvertebrate communities have also been widely studied, and it is known that

increased quantities of fine sediment can lead to decreasing abundance and diversity (Lemley 1982, Kaller and Hartman 2004, Rabeni et al. 2005). Again, however, the majority of studies examine community responses over long time periods and prolonged exposure rather than short term events. In order to understand the possible impacts of the changing sediment budget associated with the Yorkshire Water reservoir releases it is necessary to understand the impacts on individuals, as well as communities. As with fish, increased concentrations of fine sediments in the water can affect feeding and respiration of benthic macroinvertebrates by clogging filters and respiratory surfaces (Wood and Armitage 1997, Bryce et al. 2010) and can lead to an increase in drift, which may be a voluntary response to changing habitat conditions (Larsen and Ormerod 2010) or a result of the washout of substrata (Gomi et al. 2010). Whatever the cause of the increased drift, any increase in sediment levels associated with the reservoir releases might lead to an immediate decrease in local abundance and possibly a long term decrease in diversity associated with deposition of the sediment. As the trigger levels for drift or physiological damage vary from species to species, no guideline figure for a dangerous threshold is available.

A key consideration in understanding the impacts of these releases upon the study rivers' sediment budgets is that in the absence of the reservoirs more frequent natural floods could also cause increases in suspended sediment levels, river bed scour and the delivery of nutrients, and so any changes brought about by the reservoir releases must be considered in this context. A paper examining a reservoir release with a similar magnitude of change to those in this study (although with a much larger initial and final discharge) found that the changes in organic sediment delivery to the river during an experimental release were roughly equivalent to the amount of soil that would be delivered through run-off and from the banks during a natural flood event (Barillier et al. 1993). The authors note that in the event of a natural flood any impoundment would act as a trap for suspended sediment, starving the stream of a natural input, and that any sediment released from a reservoir may compensate for this loss of delivery from upstream caused by the impoundment.

Due to the brief and irregular nature of the reservoir releases it was initially decided to measure only changes in suspended sediment. However as the project developed it became clear that the origin and fate of this sediment was important in ascertaining the impacts of these releases. With this in mind, Yorkshire Water employed a Masters student, Simon

DeSmet, to carry out bed-sediment analysis associated with a scour release. This work was performed in Spring 2010, and an overview is provided in Chapter 4.

1.7.2 Water temperature

Water temperature may also change during the releases, particularly if reservoirs are stratified at the time of release. Release water in Summer may be cooler than that in the receiving streams, or may be warmer in Winter. As water temperature is a key driver of metabolism in ectotherms and influences the quantity of dissolved oxygen the water can hold, the consequences of sudden temperature change for riverine biota could be critical. Given the increased volume and velocity of the stream input during the releases, it was possible that the released water may take longer to adjust to ambient temperatures as it travelled downstream, so again it was important to determine the longitudinal extent of any effects.

Brown trout are naturally a cool water species with many northern latitude populations regularly experiencing Winter temperatures just above zero (Solbé 1997). Similarly, the resident macroinvertebrate communities in the study streams have evolved in an environment where the water temperature regularly approaches zero during the Winter months. The data in Section 4.3 shows that water temperatures in these streams can vary by several degrees throughout the day. However, despite the natural tolerance of the biota to cold or variable temperatures, a key danger associated with a sudden decrease in water temperature would be a sudden decrease in swimming / crawling ability (Videler 1993) due to rapidly decreased body temperatures and metabolism. If this were to occur at the exact time the flow increases, it would theoretically increase the risk of dislodgment or washout. Similarly, a pulse of warm water may suddenly reduce swimming capabilities by removing vital oxygen from the water (Smale and Rabeni 1995, Solbé 1997). The literature also shows that trout mortality can occur at water temperatures above 25°C, although higher temperatures may be tolerated for short durations (Dickerson and Vinyard 1999, Elliott 2000, Wehrly et al. 2007). As air temperature in the study catchments rarely exceeds 20 °C, mortality due to over-heating did not appear to be a threat.

Several studies show that long term, small changes in temperature alone have minimal effects on macroinvertebrate communities (Arthur et al. 1982, Wright et al. 2000, Feuchtmayr et al. 2007). Temperature regime acts as a key influence on community

structure (Jackson et al. 2007), and individual species have certain tolerance ranges within which they can survive. Brittain (1982) described the wide temperature ranges over which certain species of mayfly are able to develop (for example 3 - 25 °C for *Baetis rhodani*, a common species in the study area), and showed that growth was temperature independent for many species within this range. However, water temperature thresholds are important triggers for the emergence of adults, and a warm flush may trigger premature emergence. A number of studies have examined the upper thermal tolerances for a wide variety of temperate region macroinvertebrate taxa, typically finding that prolonged exposure to water of a temperature higher than 24 – 34 °C proved lethal (Moulton et al. 1993, Quinn et al. 1994, Cox 2000). These studies rely on exposure times of days rather than minutes or hours, and the results of shorter exposure times are less well understood. Literature on thermal minima is harder to find, although as the air temperature in the study catchments regularly falls well below zero, and the temperature loggers regularly recorded water temperatures close to 0 °C (Chapter 3) it can be assumed that the invertebrates survive anything above freezing and the lower lethal limit are likely to be defined by freezing point (Bowler and Cossins 1987). As the water temperature in the reservoirs is unlikely to reach the lethal temperatures described in these experiments it seems unlikely that the releases will be a danger to the macroinvertebrate communities in terms of lethal temperature effects alone, however changes may induce emergence or drift (Brittain 1982, Brittain and Eikeland 1988) or, as with the fish, may affect the swimming ability or attachment capability of individual invertebrates, and therefore their capacity to resist the increased flows.

Although there is little doubt that reservoirs can alter the thermal regime and thereby the ecology of a stream it is unlikely that the thermal effects of the releases would be long lasting as water temperatures should return to pre-release levels very shortly after the releases are completed. The danger from regular bi-annual scour releases perhaps lies in repeated short-term damage to the populations of the more sensitive taxa, as the bi-annual releases may prevent re-colonisation.

1.7.3 Dissolved oxygen

A decrease in the quantity of dissolved oxygen in the river during and possibly after the releases was also considered a risk for biota downstream, as the release water is typically drawn from deep, still water which is characteristically short of dissolved oxygen. The

reservoirs contain few macrophytes and light penetration into the peat-stained water is poor, so photosynthesis at the draw-off depths was likely to be minimal. As with a change in temperature, the concern with a change in levels of dissolved oxygen, albeit short in duration, was that it may impede metabolic activity (and therefore responses such as locomotion) of the resident organisms, or even lead to asphyxiation (Smale and Rabeni 1995, Linton et al. 2005, Nilsson and Ostlund-Nilsson 2008). In addition to a possible wave of oxygen-poor water, the released water may also contain high levels of organic matter which has been deposited on the reservoir bed. This decaying matter is likely to have a high biological oxygen demand (Section 1.2.2) and if deposited on the stream bed may cause a prolonged decrease in the oxygen available to the resident organisms.

These high-gradient, rocky upland streams are typically high in oxygen content due to their high turbulence and associated aeration capacity (Bicudo and Giorgetti 1991, Kucukali and Cokgor 2008), and unlike in lowland rivers or still waters many of their biota depend upon the constant availability of this oxygen (Allen 1995, Moss 1998). The EIFAC guidance (European Inland Fisheries Advisory Commission, 1978) suggested an annual 50th percentile DO concentration of at least 9 mg l⁻¹ (approximately 70% saturation at 5°C) for salmonid waters, with a 5th percentile of 2 mg l⁻¹ (15% saturation) (Solbé 1997). This recommendation may in fact be dangerously low, as salmonid mortalities have been recorded at concentrations of 1 – 3 mg l⁻¹ during warm Summer droughts, and higher levels are known to cause sub-lethal stresses (Elliott 2000). Although the EIFAC guidance fails to suggest a minimum concentration for a short-duration event such as a reservoir release, the concentrations recorded by Elliott are clearly low enough to be dangerous, and as with mammals, asphyxiation in fish can occur rapidly, so even a very short-lived pulse of water with a low oxygen content may be dangerous.

Macroinvertebrates are similarly sensitive to oxygen levels. As with fish, tolerances vary between taxa (Allen 1995, Moss 1998, Connolly et al. 2004, Irving et al. 2004). Mayflies, common in the study catchments and known to require highly oxygenated water, showed lethal effects at oxygen saturations below 20%, while less sensitive chironomid species began to die below 8% saturation (Connolly et al. 2004). Stream dwelling invertebrates are able to respond to a lack of oxygen by entering the water column to drift to areas where oxygen is more freely available (Brittain and Eikeland 1988, Connolly et al. 2004), although Connolly et al (2004) showed that drift commences at low DO levels ($\approx 10\%$),

approaching the levels at which mortality was observed, suggesting this response is a last resort. Prior to taking this measure, macroinvertebrates can take action to maximise their oxygen intake as concentrations fall, such as the “push-up” behaviour demonstrated by stonefly nymphs to increase water passage over the gills (Genkai-Kato et al. 2000). As with mayfly, stonefly nymphs are generally oxygen-sensitive and show stress responses at oxygen concentrations ranging from 2 to 7 mg l⁻¹ at 8°C (approximately 16 to 66% saturation) depending on species (Nagell 1973).

As with temperature effects, the extent and persistence of any decrease in dissolved oxygen associated with a reservoir release will be dictated by the hydrology and morphology of the receiving water body. In the case of the study catchments, the high gradients, low depths, rapid water velocities and broken flows associated with the boulders and cobbles should allow rapid re-aeration of water released from the reservoir, so any effect would be expected to be temporally and spatially limited.

1.7.4 pH

In addition to water temperature and oxygen concentration it was decided to record pH changes during the releases, as not only are these millstone grit catchments naturally acidic, but also the microbial activity in the decomposing detritus on the reservoir floor could increase the water’s acidity leading to dangerous changes in pH when the water is released into the river (Barillier et al. 1993, Wei et al. 2008). An alternative study (Chung et al. 2008) recorded an increase in ammonia concentrations during a release, presumably increasing the pH of the water downstream. In addition to the possible acidic nature of the water being released, the natural acidity of the study catchments may already mean that the trout and many of the invertebrates are close to the lower end of their pH tolerance limits, and any further acidification of the stream water may be fatal. Solbé (1997) notes that lifetime exposure of most fish species to pH between 5.5 and 9 is generally harmless, and species such as brown trout are often found in catchments where the nature of the bedrock (in this case the acidic sandstone) and inputs from water that has drained through acidic peat can often cause stream pH to drop below 4 naturally. Despite the presence of brown trout in naturally acidic waters, the EC directive on the quality of fresh waters needing protection or improvement to support fish life (1978) specifies a pH range of between 7 and 9 for salmonid fish. Although acidic water may not be directly toxic to the biota itself, it may change the chemical state of heavy metals or other compounds present in the

catchment which may be toxic (Solbé 1997). In particular metals such as aluminium become soluble at lower pH and have been shown to be physiologically harmful to brown trout (Brown 1983). This may be a particular concern in impounded catchments where the naturally acidic water has a long residence time in the reservoirs, increasing interaction time with the substrate and possibly allowing higher levels of dangerous metals to dissolve. The Pennines have a long history of lead mining, and the waters may therefore be metal-rich. Although there is no obvious evidence of metal mining in the study catchments, there is much evidence of quarrying, not least for the construction of the reservoirs themselves, exposing large areas of bare rock to erosion.

As the waters of the study catchments are naturally acidic, the resident trout populations are likely to have high tolerances of both the acidic waters and their chemical contents, and similarly the macroinvertebrate fauna will have evolved specifically to suit the prevalent conditions. During a natural flood the run-off water entering the streams will have run through and over the highly acidic peat in the upstream areas of the catchments and will probably decrease the streams' pHs temporarily (Abrahams et al. 1989, Buffam et al. 2007). In addition, scour releases have been performed twice yearly at the majority of these reservoirs for several decades and the macroinvertebrate faunas and trout populations remain healthy (see Section 1.8, below). For these reasons it seems likely that the biota will be unharmed by an influx of water from the reservoirs with a slightly lower pH than that of the stream water. However, a rapid and dramatic change in the water's acidity could nevertheless prove damaging. In addition to the danger of the water entraining toxic substances in the reservoir, it is also possible that the acidic water will leach substances from the increased levels of sediment associated with the reservoir releases.

Studies on the effects of water acidification and heavy metals on stream macroinvertebrates in general (Gerhardt 1993) and *Leptophlebia* in particular (a mayfly family common in the study catchments) (Gerhardt 1994) showed the invertebrates to be susceptible to heavy metal poisoning by a variety of metals including lead, iron, cadmium, copper and zinc, and that these metals became more harmful at low pHs. As with oxygen stress, macroinvertebrates show a range of responses to decreasing pH, including increased locomotion and ventilation as "early warning signals" (Macedo - Sousa et al. 2008) followed by increased levels of drift and mortality as stress increases (Ormerod et al. 1987, Kratz et al. 1994). Again, no threshold danger level can be established as different toxins

have differing solubility curves, and responses and tolerances across the communities are diverse, but experiments show common taxa responding to pHs in the 4 to 5 range (Brown 1983, Gerhardt 1993, 1994, Solbé 1997, Macedo - Sousa et al. 2008).

1.7.5 Summary of possible physio-chemical effects of reservoir releases

Table 2 below summarises the main physio-chemical changes that the literature suggests may be associated with the scour and spate releases. Following the review of information in the literature reviewed above the following hypotheses relating to the physical effects of the scour and spate releases were developed, and are tested in Chapter 4:

1. Reservoir releases cause sufficiently large changes to the hydrology of the receiving streams to affect the resident biota for several kilometres downstream
2. Reservoir releases cause changes to pH, temperature, dissolved oxygen and suspended sediment levels in the receiving stream
3. Reservoir releases are capable of reducing the quantities of fine sediment or algae entrained in the river bed

Table 2: Possible physio-chemical effects of scour and spate releases

Parameter	Possible change	Duration	Possible ecological outcome
Flow	Very rapid increase in volume and velocity followed by equally rapid decline	Opening to closing of release valve	Washout and stranding of fish and invertebrates
Sediment	Increase of suspended sediment from reservoir, stilling basin and river bed, scouring close to outlet and deposition downstream	From valve opening until wave subsides	Physiological damage to fish and invertebrates, enforced migration and drift, cleansing of proximal gravel beds, choking of distal gravels
Water temperature	Increase or decrease dependent on time of year	From opening of valve until dilution or acclimatisation of release water	Possible change to organism motility and position holding capability, respiration and life cycle, possible drop in dissolved oxygen
Dissolved oxygen	Decrease	Immediate decrease possibly prolonged by deposition of high BOD organic matter	Decreased respiration, possible asphyxiation
pH	Possible decrease, dependent on reservoir characteristics	From opening of valve until dilution of release water	Possible physiological damage and increase in dissolved toxins

1.8 Study catchment ecology and potential ecological impacts

In order to understand the likely ecological impacts of the physical changes associated with the reservoir releases it is necessary to ascertain the nature of the communities resident in the receiving water-bodies. The streams studied in this project are typical fast flowing upland water bodies, lacking macrophytes due to the potential for changeable flows and relying primarily on allochthonous material for nutrient input (Allen 1995, Moss 1998). Typically these streams would be expected to contain minimal amounts of algal growth for the same reason, but due to the stabilising of flows resulting from impoundment perhaps contain more than would be expected (Collier 2002). The fauna is adapted to live in the high-gradient fast flowing stream often characterised as the “trout zone” (Varley 1967, Whitton 1975). The trout zone is generally described as being in the upper catchment close to the headwaters and its characteristics are described in Table 3, below (for a fuller description of study catchment habitat characteristics see Chapter 7).

Table 3: Habitat characteristics of "the trout zone" and study catchments 1 and 2. Study catchment data summarised from Chapter 7.

River characteristic	Trout zone	Catchment 1	Catchment 2
Flow speed	Fast	Mean 0.54 cm s ⁻¹	Mean 0.27 cm s ⁻¹
Depth	Shallow	Mean 19cm	Mean 20 cm
Oxygen levels	High	≈ 100% saturation	>100% saturation
Gradient	High	2%	2%
Substrate	Coarse	Predominantly cobble	Predominantly boulder
Fish species present	Trout, bullhead, minnow, stone loach	Trout	Trout, bullhead

1.8.1 Macroinvertebrate populations

Regular Environment Agency sampling showed that the macroinvertebrate populations in the study catchments were representative of those found in the region’s upland millstone grit streams. Twice-yearly sample results are available for each of the catchments dating back to 2004 and Environment Agency analysis shows an average ASPT (Average Score Per Taxon, based on organic pollution tolerances of each taxon found) of 6.6 in Catchment 1 and 6.0 in Catchment 2. Average numbers of taxa recorded were 18.6 in Catchment 1 and 19.5 in Catchment 2. Typical scores for this region are ASPT 5 to 6.5, with anything over 7 suggesting a very healthy stream (J. Winterbottom, Environment Agency, pers. comm.).

It is difficult to characterise these streams in terms of macroinvertebrate populations, and analysis shows that each of the sites is significantly different in terms of community makeup (Chapter 5), despite some sites only being separated by a few hundred metres and sharing very similar habitat characteristics. However, despite the differences between the sites, the invertebrate populations at each share certain characteristics. At each site the communities are dominated by the EPT (Ephemeroptera, Plecoptera, Trichoptera) nymphs typical of shallow, fast flowing oxygen rich streams (Allen 1995, Moss 1998). The ten most frequently occurring taxa from each catchment appear in Table 4 below. Another key feature of these millstone grit streams is the lack of crustacea commonly found in less acidic streams such as in the limestone and chalk catchments to the east. Crustacea are limited in these streams, as the lack of available calcium and the acidic nature of the water hamper the growth of the exoskeleton.

Table 4: Ranked ten most commonly occurring taxa in the study catchments, from Environment Agency data

Catchment 1	Catchment 2
Polycentropopidae (Caddis)	Perlodidae (Stonefly)
Nemouridae (Stonefly)	Chironomidae (Non-biting midge)
Perlodidae (Stonefly)	Hydropsychidae (Caddis)
Leuctridae (Stonefly)	Rhyacophilidae (Caddis)
Baetidae (Mayfly)	Dytiscidae (Water beetle)
Rhyacophilidae (Caddis)	Glossosomatidae (Caddis)
Elmidae (Riffle beetle)	Pediciidae (Crane fly)
Hydracarina (Water mite)	Leuctridae (Stonefly)
Simulidae (Black fly)	Hydracarina (Water mite)
Chironomidae (Non-biting midge)	Nemouridae (Stonefly)

Macroinvertebrate habitat requirements

As the life styles and life cycles of the many taxa present vary widely, it is difficult to define habitat requirements, however in order to maintain community structure and diversity certain conditions must be met. Each of the species present has environmental limits within which it can survive and it is important that these conditions are maintained. These factors, such as water velocity, depth, pH, oxygen content, sediment content and temperature define the biota of a particular habitat patch (Cummins 1973, Cummins and Klug 1979, Allen 1995, Moss 1998). However, in order to maintain community diversity it is important that the habitat retains a degree of heterogeneity in terms of the factors listed above. A narrowing of the environmental conditions and a lack of disturbance, as may be seen following impoundment, allows dominance by the species best equipped to exploit the new more stable conditions, eliminating the taxa existing at the edges of their tolerance

limits and leading to a loss of biodiversity, as recorded in a number of studies (Armitage 1976, 1977a, Saltveit et al. 1987, Bunn and Arthington 2002, Armitage 2006, Jackson et al. 2007). The use of variable reservoir releases, including seasonal and spate releases is a recognised way of overcoming some of the problems macroinvertebrate populations face following river regulation (Bunn and Arthington 2002, Robinson and Uehlinger 2003, Robinson et al. 2003, Acreman and Dunbar 2004, Mould 2006).

Macroinvertebrate responses to changing flows

The literature shows that benthic macroinvertebrates respond to rapid changes in river discharge in a variety of ways, depending on the type of change experienced, the prevailing environmental conditions at the time of change and the taxon or community in question (Malmqvist and Brönmark 1985, Cortes et al. 1998, Extence et al. 1999, Rader and Belish 1999, McCabe and Gotelli 2000, Rempel et al. 2000, Downes et al. 2003, Lepori and Malmqvist 2007). The modes of response to changing flows can be categorised into two types – voluntary responses where individuals swim, crawl or actively enter the water column to drift, and involuntary responses where individuals are detached from the river bed and drift in the water column. The reasons for these responses are also diverse, ranging from involuntary displacement where invertebrates are unable to hold on during increasing velocities or are dislodged by passing sediment being carried in floods (Scullion and Sinton 1983, Imbert and Perry 2000, Lancaster et al. 2006, Gibbins et al. 2007) to actively initiated drift at certain life stages or in certain conditions (Allen 1995, Faulkner and Copp 2001, Dahms and Qian 2004) to swimming or crawling towards or away from a stimulus such as a food source or preferred water velocity or oxygen level (Hay et al. 2008). Changes in flow alter the locations of desired habitats as both depths and velocities at a given point in the channel change and habitat at the margins may become available or disappear, requiring the biota to move with the changing habitat.

In the case of the reservoir releases studied in this project it seemed likely that the possible stimuli to any behavioural response would be the increasing water velocity and the increasing danger of being dislodged by passing particulate matter, or a possible change in water quality, and that any response recorded might be dictated by time of year (a determinant of life stage for the majority of the taxa present) and the preceding flow conditions, specifically how recently a high flow event has occurred.

The recorded responses of stream-dwelling macroinvertebrates to short-duration reservoir releases and natural floods are generally characterised by a decline in overall abundance with mixed effect amongst taxa depending on their ability to withstand the changing flows (Scullion and Sinton 1983, Imbert and Perry 2000, Thomson 2002, Robinson et al. 2003, Stubbington et al. 2009). The extreme reduction in abundance caused by high flow events which decimate populations has been described as “catastrophic drift” and is usually associated with high levels of debris in the water column (Gibbins et al. 2007). This may even be a direct result of an increase in suspended sediment concentrations rather than increased flow (Crosa et al. 2010). The ways in which the individual invertebrates respond to rising flows has been studied in a variety of taxa in a number of ways (Winterbottom et al. 1997, Lancaster 1999, Imbert and Perry 2000, Lancaster 2000), and demonstrates the varying abilities of different taxa to withstand increasing water velocities.

The ability of populations to survive such events depends largely upon the resistance of the constituent taxa to the changing flows and the ability to re-colonise the river following the event (Thomson 2002). The ability to resist high flows is dependent not only upon the anatomy of the invertebrate but also upon the morphology of the river bed, as invertebrates have been shown to use flow refugia on the river bed during elevated flows (Palmer et al. 1995, Winterbottom et al. 1997, Lancaster 1999, Lake 2000, Lancaster 2000), returning to their previous habitats when it is safe to do so. Re-colonisation following a high flow event can also be achieved by invertebrates drifting from upstream, swimming or crawling from downstream, hatching from eggs remaining in the river, or, in the case of the numerous insects found in these particular streams by mature, winged adults from elsewhere in the vicinity laying eggs following the flood event (Scrimgeour et al. 1988, Allen 1995, Thomson 2002, Gibbins et al. 2007). Deposition and hatching of eggs are clearly seasonal events in most streams. Boulton et al (1992) found that re-colonisation of desert streams was fastest in Summer, and speculated that seasonal changes in recovery rate may be related to the rate at which primary production recovers following a scouring flood (see also Shannon et al 2001) and it may be that the initial impact is partly influenced by seasonal stability of the algal mats on which a high proportion of the invertebrate population depend.

Given that the vast majority of creatures in the upland study streams are well adapted to life in flashy streams where severe spates are (or should be) commonplace and that the

cobbled, heterogeneous river-bed habitats would seem to provide a wealth of potential flow refugia (Lancaster and Hildrew (1993), see Section 1.9), the ability to resist the elevated flows of the reservoir releases could be expected to be high.

Yorkshire Water hydrographs for the study catchments (examined in Chapter 4) show that despite the presence of the impounding reservoirs some of these streams still receive a number of high flow events each year, and Table 4 shows the invertebrate communities consist of creatures with a preference for fast flowing waters. As such, their ability to withstand the reservoir releases should be reasonably high, as should the ability to re-colonise from refugia and from nearby streams, although re-colonisation from upstream may be hindered by the presence of the reservoirs. During a natural flood, displaced organisms may be replaced by similar taxa displaced from upstream. However the presence of the reservoir again limits the input of stream-dwelling creatures from upstream, and may in fact produce an input of taxa associated with the still waters of the reservoirs.

A study by Scullion and Sinton (1983) on invertebrate life in riffles below reservoirs in impounded upland Welsh rivers showed a consistent but not statistically significant decrease in abundance of several taxa following reservoir releases. However, the substrate in these rivers contained a high proportion of gravel and was therefore possibly more prone to scouring than the Yorkshire streams studied here, and the magnitude of change from compensation flow to peak discharge was far less in the Welsh streams.

Imbert and Perry (2000) showed that sudden increases in flow in experimental man-made streams resulted in an increase in the numbers of invertebrates drifting in the water column. The rates of drift were greatly increased when abrupt changes were made to the flow, as opposed to slower step-wise increases which they believed allowed the invertebrates time to respond to the changing conditions. Again the difference between regular and peak discharge in this experiment was not comparable to that seen at the Yorkshire reservoirs.

In summary, existing evidence allows development of a conceptual model of macroinvertebrate responses to short-duration reservoir releases. Firstly, the most obvious response would be a decrease in abundance of the benthic macroinvertebrates caused by

the increasing flows and associated dislodgement and drift, as observed in many of the above studies. If such a reduction is seen, it is likely that the taxa which are most poorly equipped to resist high flows, or which are most exposed to the high flows due to their lifestyles, will be the most sensitive to high flow events and may even disappear. Alternatively, as the resident taxa should be equipped to withstand high flows it may be that resident organisms are able to remain in place and numbers of individuals and taxa actually increase as creatures washed from the reservoirs settle on the river bed. Any such colonisation from the reservoir would presumably be short lived as these taxa would be unlikely to thrive in the fast flowing waters of the streams.

It seems likely given the findings of Imbert and Perry (2000), that the invertebrate populations in the study streams would show a lesser response to the spate flows than the scours, as the gradual increase to maximum discharge would allow time to respond, although the sustained high flows associated with the spates may compensate by removing invertebrates over a longer time period.

The speed of re-colonisation after a wash-out may be limited by the reservoir preventing inflow of organisms from upstream, and the possible loss of primary production associated with the a reduction in algal cover, but should be rapid from creatures remaining in refugia and from airborne adults depositing eggs in the warmer months. The number of airborne plecoptera and trichoptera was noticeable during the Autumn releases (and to a lesser extent the Spring releases) in the study catchments.

The spatial extent of any effects should be dictated by the strength of the discharge, as seen in Jakob et al (2003). Any washout effect should be limited to a few kilometres below the reservoirs, but changes to populations caused by individuals drifting in from upstream could be expected to continue for some distance.

Following the review of the literature above and a hypothetical application of this knowledge to the study sites, the following hypotheses were developed, and are tested in Chapter 5:

1. That flow releases from upland Yorkshire reservoirs decrease benthic macroinvertebrate abundances immediately downstream of the reservoirs.
2. That certain taxa are more vulnerable to displacement by such flows.
3. That scour releases will have a greater effect than spate releases at these sites due to the more rapid increase in discharge.
4. That any displacement effects on benthic macroinvertebrates will decrease as distance from the release site increases.

1.8.2 Fish populations

Environment Agency data from 2000 to 2007 show brown trout to be the dominant fish species in the study area, and the only species present at many sites. In each catchment fish species richness increases with distance downstream. At the sites eventually selected for gauging fish responses (Chapter 6), brown trout were the only species present at sites 1, 2, 3, 4, and 6, with bullheads also found at sites 5 and 7 (locations of sites shown in Figures 52 and 53). The Environment Agency data show the trout were present in densities averaging 0.4 individuals m⁻² in Catchment 1 and 0.3 individuals m⁻² in Catchment 2. These populations are regarded as good for Pennine streams, with Catchment 1 being particularly productive (D. Smallwood, Environment Agency, pers. comm.). The Environment Agency data divides the fish into categories by approximate age class and body length. In Catchment 1: 0+ and >0+ categories are used. In Catchment 2 three categories are used: 0+, .0+ to 20 cm, and 20 cm+. Proportions of each class in each study catchment appear in Table 5 below.

Table 5: Age / length class proportions of brown trout in study catchments from Environment Agency data, 2000 to 2007

Class	0+,	>0+ to 20 cm	20 cm +	>0+ total
Catchment 1	30%	Not recorded	Not recorded	70%
Catchment 2	43%	51%	6%	57%

The data show healthy recruitment, with substantial proportions of fry (0+) fish present as would be expected in the spawning habitat typically found in the trout zone. Although each catchment contains numbers of >20cm adult fish, neither the Environment Agency nor the local angling clubs reported anadromous “sea” trout in these streams, probably due to the large number of obstructions between the catchment areas and the estuary mouth.

Ecology of the brown trout

The brown trout is a widespread, sometimes anadromous fish, found in a variety of habitats from upland streams to deep lakes and seas (Frost and Brown 1967, Elliott 1994). It is considered an excellent sporting fish by anglers and is also farmed commercially for its flesh and has been introduced to countries around the world. Despite being resident in a large proportion of UK water bodies, the brown trout is now a UK Biodiversity Action Plan priority species due to a decline in population, particularly in Scotland (UKBAP 2008). Due to their commercial value and global distribution (MacCrimmon and Marshall 1968), brown trout are one of the most studied and best understood freshwater fish.

The brown trout species contains a number of genetically indistinguishable co-habiting morphs (Hindar et al. 1991, Charles et al. 2005), each of which displays a different life cycle. Each of these morphs spawns in the fast flowing, oxygen rich gravels typical of upland streams, usually in late Autumn and early Winter in the UK (Frost and Brown 1967). Eggs hatch in the gravel, and fry emerge in the Spring. The newly emerged fry remain in the streams, feeding off invertebrates and suffering heavy population losses due to predation, flooding or a congenital inability to feed once the egg yolk is fully absorbed (Elliott 1994). Fry tend to remain close to their emergence sites or may migrate short distances upstream (Elliott 1994). Trout reaching one year are known as parr, and generally remain in their nursery streams. From two years onwards the different morphs and life cycles become apparent. Individuals that become sea trout may begin the smolting process at this age, migrating to the sea where they feed in rich coastal waters, growing rapidly. These fish typically return to their streams of origin after one or more years to spawn again. The return migration is driven by a number of factors including elevated flows, changing water temperatures and olfactory cues (Lucas and Baras 2001, Archer 2008b) The migratory process and sea feeding allows the adults to attain much greater weights and therefore much greater fecundity while also leaving resources in the stream for the fry and parr (Frost and Brown 1967, Elliott 1994).

The lacustrine morph exhibits a similar life cycle, however this form is potamodromous rather than anadromous, spawning in streams before migrating to lakes to feed and grow.

A third morph, the resident brown trout, does not migrate outside of its spawning streams, where it reaches sexual maturity and spawns without attaining the size of the other morphs. It is not known what causes a young trout to smolt, and within a given population a proportion may smolt while others remain in the river. The morphs interbreed, with offspring of any given pairing capable of producing both anadromous and non-anadromous siblings, and it is known that precocious resident males will fertilise the eggs of returning lake or sea trout, with males as small as 7.1cm showing signs of gonad maturation (Dziewulska and Domagala 2006).

In the study catchments it is likely that sea trout are prevented from return migration due to a number of large downstream weirs. Lacustrine morphs probably exist in areas upstream of the reservoirs, using the reservoirs as feeding grounds as shown in Crisp (1994), but are unlikely to pass into the study areas downstream of the reservoirs due to filter grids over outlet pipes and the dangers of swimming down the spillway of a full reservoir. The Environment Agency data and personal observations during the tagging process suggest that the vast majority of fish in the study streams are resident brown trout. Although returning anadromous fish are unlikely to spawn in the study area, this does not negate the possibility that high flows attract trout from deeper waters downstream.

Habitat requirements of the brown trout

Due to the diverse range of habitats utilised during the brown trout's life cycle and by the different eco-morphs, habitat studies tend to be life-stage specific, and most have generally focused on river habitat, rather than marine or lacustrine requirements and identified water depth, velocity, substrate type, temperature, oxygen availability and cover as key variables (Elsø and Greenberg 2001, Heggenes et al. 2002, Armstrong et al. 2003, Molin et al. 2010). As the streams of the study catchments are upland headwaters providing spawning and nursery habitat (as demonstrated by the high numbers of parr, fry and slow growing adults found in Environment Agency electric fishing surveys) as opposed to the downstream feeding areas to which larger trout may migrate, the review here will focus on the requirements for spawning and early growth.

The brown trout habitat requirements for spawning and nursery habitats taken from Armstrong (2003) are shown in Tables 6 and 7 below. Comparison of these requirements with the study site characteristics shown in Table 8 shows that the study catchments should

contain good spawning and nursery habitat. The study catchments also contain suitable spawning and nursery habitat for Atlantic salmon (as described in Armstrong (2003)), should they ever return to these streams.

Table 6: Reported nursery habitat used by brown trout, adapted from Armstrong et al. 2003

Habitat Variable	Measure	Values	Source
Mean water column velocity	Range (fry)	0 – 20 cm s ⁻¹	Bardonnet and Heland (1994)
	Range (parr)	20 – 50 cm s ⁻¹	Heggenes (1993) Crisp (1993)
Water depth	Preference	<20 – 30 cm	Bohlin (1977) Kennedy and Strange (1982) Bardonnet and Heland (1994)
	Range	5 – 35 cm	Maki – Petays et al (1997)
Substrate size	Range	50 – 70 mm	Heggenes (1988)
	Range	10 – 90 mm	Bardonnet and Heland (1994)

Table 7: Reported habitats used by spawning brown trout, adapted from Armstrong et al. 2003

Habitat Variable	Measure	Values	Source
Water velocity	Mean	39.4 cm s ⁻¹	Shirvell and Dungey (1983)
	Range	15 – 75 cm s ⁻¹	Shirvell and Dungey (1983)
	Mean	46.7 cm s ⁻¹	Witzel and MacCrimmon (1983)
	Range	10.8 – 80.2 cm s ⁻¹	Witzel and MacCrimmon (1983)
Water depth	Mean	31.7 cm	Shirvell and Dungey (1983)
	Range	6 – 82 cm	Shirvell and Dungey (1983)
	Mean	25.5 cm	Witzel and MacCrimmon (1983)
Substrate size	Mean	6.9 mm	Witzel and MacCrimmon (1983)
	Range	8 – 128 mm	Ottaway and Clarke (1981) Chapman (1988) Shirvell and Dungey (1983)

Table 8: Study catchment habitat characteristics (summarised data from Section 7.4.1)

Habitat Variable	Catchment	Measure	Values
Water velocity	1	Mean	0.54 cm s ⁻¹
		Range	0 – 1.78 cm s ⁻¹
	2	Mean	0.27 cm s ⁻¹
		Range	0 – 1.04 cm s ⁻¹
Water depth	1	Mean	19cm
		Range	0 – 65 cm
	2	Mean	20 cm
		Range	0 – 77 cm
Substrate size	1	Modal Wentworth category	Cobbles (64 – 256 mm)
		Range	Sand to boulder
	2	Modal Wentworth category	Boulders (>256 mm)
		Range	Silt to boulder

The differing habitat requirements of the different life stages illustrate the importance of habitat heterogeneity and it is noticeable in these streams that the large numbers of boulders and varying gradients provide a wide range of water velocities (pers. obs.). The way in which the trout exploit this heterogeneity will be explored in Chapter 7. It is these same characteristics that regulate two of the trout's other habitat requirements: water temperature and oxygen availability. The shallow, turbulent streams are naturally high in oxygen and the constant flow reduces the temperature ranges seen in standing waters.

Brown trout responses to elevated flows

Many salmonid species commonly spend their earlier life stages in flashy upland streams and are well adapted to deal with spates (Roghair et al. 2002), being both strong swimmers and capable of holding position on the river bed with minimal energy expenditure in high flows (Przybilla et al. 2010). As a consequence there are few reports of trout populations being affected by wash-out during natural spates, although it is certainly possible in situations such as those described in Sato (2006), where a population of the salmonid Kirikuchi charr *Salvelinus leucomaenis* was displaced by an extreme flood containing large amounts of debris. Trout mortality and disappearance have also been recorded as a consequence of raised suspended sediment levels during a reservoir flushing release in a stream of comparable size to the ones examined here (Crosa et al. 2010).

It is well known that, in regions where Autumnal floods and spates are common, for example in temperate oceanic climates, upstream migrations of adult brown trout and other salmonids often coincide with these high flow events which act as a stimulating factor to fish downstream of spawning grounds (Frost and Brown 1967, Elliott 1994, Lucas and

Baras 2001, Archer 2008b). Successful attempts have been made to encourage salmonids to migrate upstream in regulated rivers by performing controlled spate releases (Archer 2008b). It is also known that downstream migration of smolting juveniles in Spring can be associated with higher flows, although triggers for these migrations are less well understood (Frost and Brown 1967, Elliott 1994). With this in mind, it was considered possible that reservoir releases could act as triggers to migration – either an upstream migration of adults in the Autumn spawning season, or a downstream migration of parr in Spring.

Alternatively, it was possible that the rapid increases in flow may prove too strong for the fish, and that individuals may either be carried involuntarily downstream or actively swim downstream to find more hospitable habitats. Observations below hydropower plants have shown that emergent juvenile brown trout and Atlantic salmon may be displaced during rapid flow changes, and even left stranded on sections of dry bed when high flows are cut off (Saltveit et al. 1995, Halleraker et al. 2003). Elliott (1994) did note that large numbers of brown trout fry are subject to downstream drift and displacement, and that up to 80% of emergent fry may be lost from headwaters in this way. However, of these 80% the vast majority had not fed post emergence and were in fact moribund, while the fish that had fed successfully since hatching did not drift and were much more likely to remain in or just upstream of spawning areas. It was also possible that fish may be forced to move away from the release sites due to changes in water quality, such as possible decreases in dissolved oxygen levels or pH, or changes to temperature either decreasing the fishes' swimming capabilities or reducing the oxygen content of the water.

The available literature suggests a number of ways in which the brown trout in the study streams may respond to the scour and spate releases. Following the literature review, a hypothesis relating to the responses of the fish was developed, and is tested in Chapter 6: that brown trout will make unusual movements in response to the reservoir releases, either by migrating upstream or downstream, or being washed downstream during the enhanced flows.

1.9 The influence of habitat type

The physical nature of the receiving water bodies may be a key factor in determining the impacts of short-duration reservoir releases. Factors such as stream gradient, channel shape, substrate type and the presence of barriers all influence the speed at which the released water will travel downstream and also have more subtle but equally important effects on factors such as re-aeration of de-oxygenated water (Bicudo and Giorgetti 1991), equilibration of water temperature (Lowney 2000, Carron and Rajaram 2001) and the rate at which sediment is either entrained or deposited (Petticrew et al. 2007, Batalla and Vericat 2009). These influences may in turn determine the extent to which the releases impact upon the in-stream biota. Furthermore, the responses of individual organisms to the changing environmental conditions may be determined to a large extent by habitat type, and in particular the presence of refugia (Pearsons et al. 1992, Lancaster and Hildrew 1993, Lobón-Cerviá 1996) in which organisms may “sit-out” the releases. Physical habitat characteristics may therefore determine both the resistance and resilience of the downstream communities to reservoir releases, and understanding the nature of the in-stream habitat may be as important as understanding the nature of the releases and resident communities when examining the ecological impacts. The influence of habitat on biotic responses, and specifically the importance and use of flow refugia are discussed in detail in Section 1.9.1 below.

In the context of this study, the sudden increase in flow downstream of the reservoirs during the scour and spate releases followed by an equally rapid decrease and coupled with the possible changes to water physio-chemistry and sediment transport represent a significant and almost instantaneous change to the habitat of the fish in the study reaches. In such a situation, in order to minimise the energy expenditure required to maintain position and possibly to avoid physical harm from entrained sediment or even complete displacement it may be that the organisms need to make rapid changes of position to locate less threatening habitat. If they are able to make such changes, exploiting the varying characteristics of a changing, heterogeneous habitat, then responses to the changing water velocity and turbulence alone may be minimal provided the releases are not sufficiently large to entrain larger cobbles and boulders.

1.9.1 Habitat heterogeneity and the concept of flow refugia

Habitat heterogeneity is recognised as a key factor in maintaining community diversity and providing resilience to disturbance (Meffe and Carroll 1994, Sutherland and Hill 1996, Brown 2007). This concept is particularly well illustrated in river and stream environments where the complex nature of a river bed is reflected in the complexity of the flow pattern it creates (Buffin-Belanger et al. 2006). The diversion of the flow around boulders, cobbles and smaller particles, along with friction with the river banks and backwaters, pools and eddies, provides a wide range of flow conditions, potentially meeting the habitat requirements for a wide range of species. As flows increase or decrease velocity and depth patterns may change. However, a complex habitat may remain usable at the reach scale even if the portions of usable habitat migrate with the changing hydrological conditions (Pearsons et al. 1992, Heggenes et al. 1996, Negishi et al. 2002). Mobile species can survive temporarily adverse environmental conditions by moving to flow refugia, areas that remain or become suitable to an individual's requirements as surrounding conditions change.

Refugia have previously been characterised as “habitats or environments that convey spatial and temporal resistance and / or resilience to biotic communities that have been impacted by biophysical disturbances” (Sedell et al. 1990). In the context of this project the simpler, more specific definition of *flow* refugia provided by Lancaster and Hildrew (1993) of “places not subject to raised hydraulic stress during spates” is appropriate, and equally applicable to both fish and invertebrates.

The use of such refugia has been used to explain the persistence of a wide variety of organisms during various disturbances, such as riverine diatoms during scouring flows (Bergey 1999), macroinvertebrates during high flows (Winterbottom et al. 1997, Lancaster 1999, 2000, Holomuzki and Biggs 2003, Lancaster et al. 2006) and fish during both high flows (Pearsons et al. 1992, Lobón-Cerviá 1996, Dare and Hubert 2003) and low flows (Elliott 2000, Magoulick and Kobza 2003).

Although it is not possible to ascertain *in vivo* whether individual macroinvertebrates seek out refugia during floods or high flows, work has been undertaken in flumes with changeable flows and substrates that closely mimic those of the invertebrates' natural

habitat. Using these flume experiments and field observations a number of studies have found that individuals inhabiting potential high-flow refugia are less likely to drift than those in exposed habitats (Winterbottom et al. 1997, Lancaster 2000, Negishi and Richardson 2006, Oldmeadow et al. 2010), and that individuals may actively seek these areas (Lancaster 1999).

Similarly, fish have been shown to use refugia for predator avoidance (Eklov and Persson 1996, Anderson 2001), drought avoidance (Elliott 2000, Rayner et al. 2009) and to avoid the increasing velocities (Gerstner 1998, Schwartz and Herricks 2005, Johansen et al. 2008). Although fish are well known to use refugia in this way, and salmonid populations persist in spate-prone high velocity streams, it is not known whether salmonids exploit these flow refugia during high flow events or are able to simply hold position in their usual habitats. However, salmonids seem to be able to sense and to respond to changes in both water velocity and turbulence (Kroese and Schellart 1992, Cotel et al. 2006, Liao 2007).

Given that:

1. fish are known to utilise refugia;
2. that refugia should be readily available in the bouldery study catchments; and
3. that the releases appear to produce sufficiently high flows to displace fish;

it is reasonable to hypothesise that the trout may utilise refugia during the releases, allowing persistence of their populations during high flows, and specifically that:

1. Brown trout exhibit preference for specific habitat conditions relative to the range available within the study streams
2. Brown trout will alter their locations to maintain these habitat preferences as in-stream conditions change during elevated flows

These hypotheses are explored in Chapter 7.

As the availability of refugia is determined by the characteristics of the habitat in question, it is essential to fully understand the nature of the in-stream habitats below the reservoirs. A full description of these habitats will appear in Chapter 7, Section 7.2.

1.10 Summary

This chapter reviews the impacts that impoundments have upon freshwater ecosystems and highlights the need for increased flow variability in impounded systems. The chapter

shows how impoundment of rivers commonly affects fish and macroinvertebrate populations by changes to the natural hydrograph, the natural sediment regime and also to the quality of the water being released into the river. Impoundment of rivers may lead to reduced levels of dissolved oxygen, and changes to water temperature and chemistry. These changes in turn may impact upon fish and invertebrate communities.

The introduction of mimicked spate flows through the use of reservoir releases may alleviate some of the problems associated with impoundment, particularly the lack of flushing flows in salmonid spawning gravels and the lack of high flows that may be required to stimulate spawning migrations. The use of mimicked spate flows is seen as a key way to restore ecological potential in impounded rivers, and may help water authorities meet their obligations under the European Water Framework Directive. However, short – duration reservoir releases may equally be ecologically harmful if water quality is poor or if flows change so rapidly as to displace fish and invertebrates in the receiving watercourses, as seen in hydro-peaking releases.

Although previous work has been undertaken examining the impacts of reservoir releases and the use of reservoir releases to mimic natural spate flows the majority of this work has focussed on much larger reservoirs than those typically seen in the United Kingdom. Equally importantly, most of this work focuses on experimental spate releases or releases from hydro-power stations, with very little work carried out on the effects of regular operational releases such as the scour tests.

The need to assess the impacts of the short duration scour releases was identified as key to ascertaining the possible effects and potential of the longer duration spate releases and therefore a full physio-chemical, hydrological and ecological audit of both scour and mimicked spate releases was undertaken.

1.11 Key research questions

The principal aim of the study was to understand the effects of the scour releases upon water quality and stream flow and the resulting ecological impacts in impounded upland streams. This information was then to be used to assess the potential of releases from the scour valve to mimic natural spates. In addition, it was felt that understanding impacts upon the small millstone grit streams typical of the Yorkshire Water region, and the

habitats and biota therein, was particularly important. In order to better understand the impacts of the scour valve tests and the potential of the spate releases it was necessary to address the following key questions:

1. How do the releases affect the hydrology of the receiving water bodies?
2. Do the releases have any impact upon water quality downstream of the reservoirs?
3. What are the impacts of the releases upon downstream fish and invertebrates?
4. What role does in-stream habitat play in determining these impacts?
5. Could it be ecologically beneficial to use the scour releases to mimic natural spate events?

Each of these questions was addressed through the examination of the hypotheses set out in Sections 1.7, 1.8 and 1.9. Work to establish the physical and ecological effects of the scour and spate releases took place simultaneously. As ecological impacts were likely to be dictated by the physio-chemical nature of the releases, flow and water chemistry are examined first, in Chapter 4. The effects which these physical and chemical changes have upon the downstream biota are also explored in self contained chapters examining effects upon macroinvertebrates (Chapter 5) and upon brown trout *Salmo trutta* (Chapter 6). The extent to which habitat may determine these responses is then examined in Chapter 7.

Chapter 2: Field site selection and methodological overview

2.1 Introduction

This chapter introduces the methodological approach taken to assessing the impacts of the reservoir releases. The rationale for field site selection is also discussed here.

2.2 Field site selection and naming

Due to a confidentiality agreement with Yorkshire Water Services, the study sites cannot be named or identified precisely by map or grid reference. Consequently the names of each of the reservoirs have been changed and catchments and rivers are identified simply as “Catchment 1” or “Stream 2”. For the same reason, satellite images from Google Earth are used in place of Ordnance Survey maps, as place names are not given.

The field sites where the investigations would take place had to meet a number of criteria. Firstly, the reservoirs chosen had to be representative of the other hundred or so reservoirs operated by Yorkshire Water Services. An examination of the locations of these reservoirs (Figure 1, below) showed the vast majority to be located on the western edge of the Yorkshire Water catchment, on the east-facing millstone grit slopes of the South Pennines, feeding the formerly industrial urban areas of Leeds, Bradford, Sheffield and Huddersfield. The location of these towns is in part due to the surrounding geology, as both fast flowing streams and upland pasture were widely available to power the mills and supply the wool for the 19th century industry. No reservoirs are found in the east of the catchment where the millstone grit gives way to permeable chalks and limestones. This region is also supplied by the Pennine reservoirs, as well as by borehole and river abstractions.

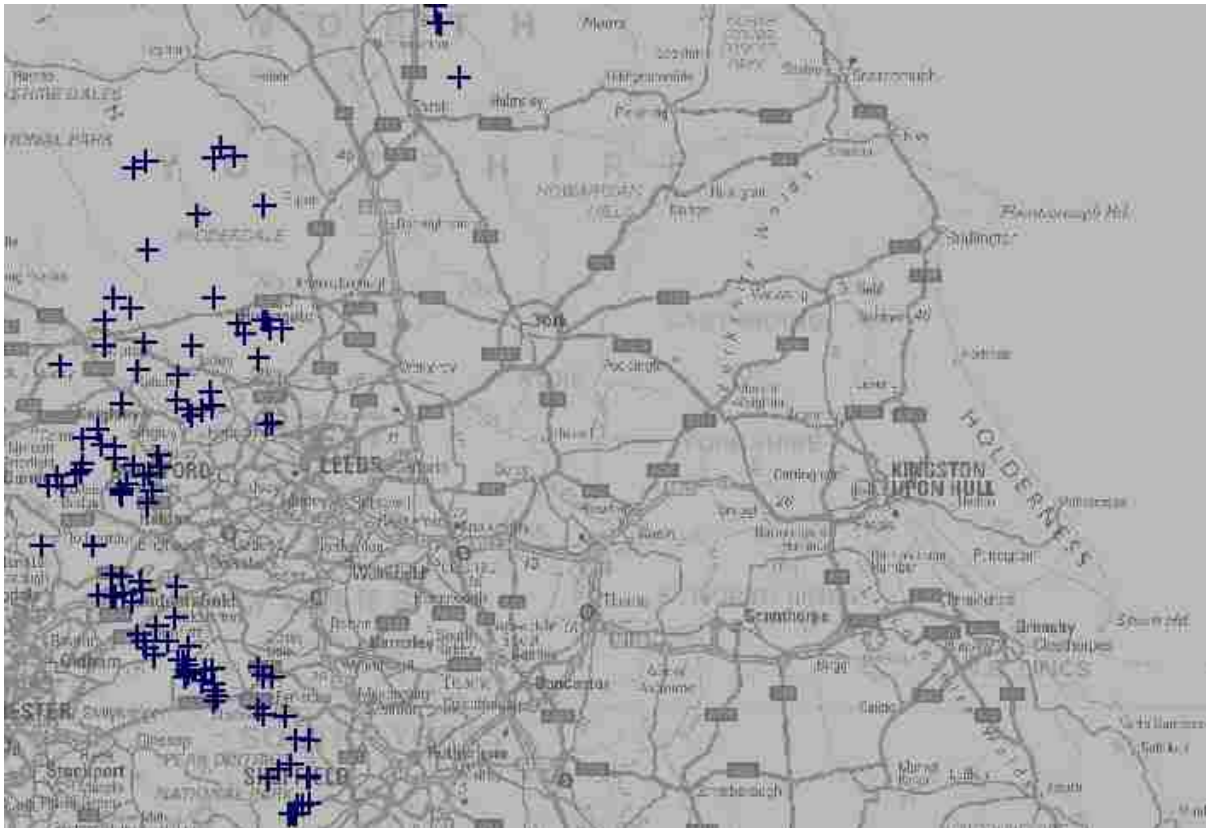

Figure 1: map showing the locations of Yorkshire Water Services impounding reservoirs, scale 1:100,000

In addition, the receiving water bodies also had to be broadly representative in terms of ecology and hydro-morphology. This meant that the streams should be of a relatively high gradient, fast flowing and relatively small at the point where they exit the reservoirs.

Ecologically, the streams had to support communities representative of the Pennine millstone grit area. The Environment Agency data showed that these streams typically support substantial populations of brown trout often supplemented by bullhead, stone loach *Barbatula barbatula*, and lamprey. Further downstream and in the urban areas where stocked fisheries are common grayling *Thymalus thymalus*, barbel, perch *Perca fluviatilis*, pike *Esox lucius*, roach *Rutilus rutilus*, dace *Leuciscus leuciscus*, minnows, eels and carp *Cyprinus carpio* are common, with occasional salmon also being reported.

As it was anticipated that the effects of the reservoir releases would not extend more than a few kilometres, only the upper catchment characteristics were considered, hence study areas with substantial brown trout populations were required. The trout had to be present in sufficient numbers to allow a viable study on their responses to the reservoir releases.

The Environment Agency kick-sample data showed that invertebrate populations varied considerably between sampling sites. As the long term objective is to bring all these water bodies to good ecological potential it was important that the field sites had as healthy invertebrate communities as possible, to assess the response of a healthy system to a reservoir release, rather than that of a system already suffering from the adverse impacts of other human activities. The Environment Agency Average Score Per Taxon (ASPT) scores showed that the sites furthest from the industrialised areas generally scored highest. As most of the reservoirs were in the headwaters of their catchments, invertebrate populations usually scored well for some kilometres downstream.

A further requirement was that, if required, reservoir releases could be manipulated for experimental purposes. The original acts governing the reservoirs' constructions still dictate how much compensation flow is legally required and at what point downstream it must be measured. In situations where groups of reservoirs were constructed in a single catchment, compensation is often measured as a combined output from all the reservoirs in the group, rather than from each reservoir individually. This allows the adjustment of releases from individual reservoirs in a group providing that any increase or decrease in compensation flow is counterbalanced by releases from another reservoir in the same group, as seen in Mould (2006).

It was also necessary to carry out the work in more than one catchment, to replicate results and discount any confounding factors that may be associated with a single particular catchment.

During the planning stages of the project the stakeholders at Yorkshire Water, the Environment Agency and Durham University expressed a desire to continue the work in the Rivelin / Loxley catchment, described in Mould (2006), as the catchment had undergone continuous monitoring since the start of the project. For this reason many of the reservoirs examined in the pilot studies described in Chapter 4 were in this catchment. However, after discussions with the Yorkshire Water water resources team it became apparent that there was no scope for further changes to the reservoir outputs in this catchment. This particular catchment was also very heavily impounded, with continuous weirs, mill-ponds and out-takes beginning almost immediately below the reservoirs. In

addition, the catchment had recently undergone significant hydrological changes, to which the resident biota may still be responding. Fish populations were also affected by numerous escapees from the stocked reservoirs and a nearby stocked lake, and working conditions in the river were possibly unsafe due to the various industrial outflows and the presence of a combined sewer overflow.

Consequently, a number of other catchments had to be considered. The possible catchments were determined by the scope for Yorkshire Water to adjust reservoir releases for the purposes of the study. Including the Rivelin / Loxley reservoir group, five possible catchments were discussed. Of these, one possible site was rejected due to its geology (limestone downstream of the reservoirs potentially changing water chemistry and ecology). A further catchment satisfied most of the required criteria but was historically heavily industrialised in the upper reaches, possibly affecting both invertebrate and fish populations and did not have the benefit of extensive historical Environment Agency survey data.

Of the two remaining catchments, Catchment 1 had previously been identified by Yorkshire Water and the Environment Agency as one in which flows could be manipulated for ecological gain, although no changes had yet been made, providing a blank canvas for the study. The Environment Agency already had several years of ecological data for several points around the catchment, and the rivers contained substantial trout populations and a diverse invertebrate fauna. Public access was limited, allowing the use of stationary monitoring equipment and site access was relatively easy.

Catchment 2 was a similarly obvious choice. The water budget allowed for trial spate releases, which had been on-going since 2005. The brown trout populations were again substantial and invertebrate communities healthy. Yorkshire Water owned much of the land in the upper catchment, and public access was limited. The catchment also fitted all the criteria described above, and the reservoirs themselves were of a design, size and output as close as possible to the Yorkshire Water norm.

2.3 *Fieldwork rationale*

Scour releases are typically very short in duration (20 minutes to 4 hours) and are scheduled to be undertaken twice each year at each reservoir, generally in Spring and

Autumn. Each release requires a minimum of two engineers, or up to five at the more difficult reservoirs if full valve inspections are required. The releases are only repeated in exceptional circumstances due to the cost of the engineers, the difficulty in scheduling numerous members of staff, and the unknown environmental effects. The spate releases require nearer 12 hours of engineering, typically requiring three Yorkshire Water engineers to operate the valves, two more staff to monitor the reservoir output and two external contractors to perform ultrasonic flow monitoring on the release pipes. In addition to staffing costs and scheduling difficulties, a full day spate release also uses a considerable amount of raw water – Yorkshire Water’s primary asset and source of income, so the water resources team are understandably reluctant to repeat releases.

It was important to plan the field work to allow for the short-duration, unrepeatable nature of the releases as opportunities to gather data would be limited, and missed or failed opportunities could not be repeated easily. In addition to problems associated with monitoring one-off events, it would clearly not be possible to work in the rivers during high flows for health and safety reasons. As the precise impacts of the releases were unknown at the time of planning, it was also essential to gather as wide a range of data as possible, covering not only the physical impacts associated with the releases, but also the impacts upon the ecology of the receiving streams. Additionally these effects needed to be set in the context of “natural” flow variation caused by rainfall and run-off episodes.

To determine the likely major physiochemical and hydrological (and subsequent likely ecological) changes associated with the releases it was decided to undertake a series of preliminary investigations at a variety of reservoirs shortly after the project began in early 2008. These investigations, described in Chapter 4, helped determine the future direction of the project, particularly the nature of the ecological monitoring to be undertaken. A review of the Environment Agency data for the region along with the literature on upland streams (Chapter 1) showed that the best described taxa were fish and macroinvertebrate populations, and it was these groups that were targeted.

As invertebrate surveys can be carried out anywhere, and the sampling is relatively straightforward it was theoretically possible to monitor the effects on invertebrates at a variety of sites and on numerous occasions, limited only by the time taken to sort and identify the samples. Recording impacts that the releases had on the movements of the trout, on the other hand, required either some sort of capture-mark-recapture method, or a

tagging and telemetry method (see Chapter 6). The preparatory work for either of these types of surveys is time consuming and expensive, and once fish are marked or tagged they cannot be transferred to an alternative location. For this reason it was decided to focus on two catchments, over two years, allowing detailed recording of precise impacts on two different populations.

All techniques used in the surveys had to be capable of identifying changes that occurred during the releases without requiring the operator to enter the river during high flows. Although preparation time for the work was unlimited, all work that was required on the day of release had to be completed quickly and accurately, with as little potential for error as possible. For this reason, as much remote telemetry was used as possible, minimising the work required during the hectic release days, whilst facilitating the gathering of as broad a range of data as possible. The use of pre-existing Yorkshire Water and Environment Agency telemetered flow gauging weirs greatly assisted in the hands-off gathering of the hydrological data, while the use of water-quality probes which could be set and left to record allowed concentration on the ecological data. The selection of PIT tagging and the use of the monitoring stations to detect impacts upon the behaviour of trout populations, described in Chapter 6, also minimised the amount of work required during the releases.

For the macro-invertebrate monitoring, the decision to use “before and after” population data removed the need to work in the river during the high flows and meant the majority of work could be undertaken immediately before and after the release, as opposed to during. Despite the planning to make the monitoring of each release as easy and reliable as possible, release days remained extremely work-intensive, requiring several personnel. A timetable for a typical release appears in Table 9 below:

Table 9: typical scour release day timetable

Time	Action
Afternoon prior to release	<ul style="list-style-type: none">• Collect pre-release invertebrate samples, sort and preserve• Change PIT station batteries and check operation
06:00	<ul style="list-style-type: none">• Install water quality probes• Start water samplers• Check PIT station operation
08:45	<ul style="list-style-type: none">• Locate and map fish with mobile detector• Out of water
09:00	<ul style="list-style-type: none">• Liaise with engineers• Release begins• Depth and velocity measurements• Check probes and fish stations
11:00 onwards	<ul style="list-style-type: none">• Release photographs• Release ends• Relocate tagged fish• Post –release invertebrate samples• Stop water quality probes• Download PIT station data• Sort and preserve invertebrate samples

Chapter 3: Properties of the study site reservoirs and releases

3.1 Introduction

This chapter examines the properties of the reservoirs in the study catchments, drawing on a combination of data from Yorkshire Water and the Environment Agency and data collected in the field. In order to predict the impacts of reservoir releases it is necessary to understand the designs of the study reservoirs and the effects that impoundment has on the quality of water to be released. The mechanism by which the water is released is also critical, and is discussed in Section 3.2.1.

3.2 Reservoir design

Site characteristics for each of the reservoirs used in the study appear in Table 10. The reservoirs selected for the study have maximum depths of between 6 and 40 m, with storage volumes ranging from 18 to 5105 thousand cubic metres (tcm). The reservoirs were constructed to their present designs between 1848 and 1953. The design drawings show that the locations and numbers of the intakes of the release pipes vary, although each reservoir has at least one intake at the base of the dam wall, allowing almost complete drainage of the reservoirs. The reservoirs usually reach maximum depth at the bottom of a basin some metres behind the dam wall and this area cannot be drained. The numbers of intakes to the release pipes vary from a single intake close to the base of the dam wall to several intakes at increasing depths between the top and bottom of the dam wall. In the cases of the reservoirs with multiple intakes, the design allows draw off from any or all of the intakes. The intakes then enter a joint manifold pipe leading to the point of release. As with the intakes, the numbers and design of the outlets vary markedly. The majority of Yorkshire Water reservoirs have either one or two release valves connected to the manifold. These valves can be used independently or concurrently, and empty into stilling basins where water settles prior to entering the streams. Outflow from the stilling basins constitutes the only stream flow below the reservoirs.

Table 10: Characteristics of the study reservoirs. Note use of pseudonyms for all reservoirs and catchments.

Reservoir name	Catchment	Year constructed	Height AOD (m)	Depth (m)	Volume (tcm)	Maximum discharge rate (tcmd)	Direct catchment area (km²)	Indirect catchment area (km²)	Compensation flow (tcmd)	Winter compensation flow (tcmd)
Wagtail Lower	1	1907	300	20	657	225	9.409	n/a	3.78	15.12
Greenshank	1	1934	298	26	1214	74	6.695	1.255	2.7	2.7
Whinchat	1	1878	320	19	2770	116	2.845	6.151	3.24	12.96
Blackbird	2	1932	219	31	1242	79	9.7	n/a	5.4	6.819
Dipper	2	1953	244	40	3443	475	9.72	n/a	5.1	6.56
Avocet	Pilot	1869	196	25	2901	170	12.15	n/a	n/a	n/a
Dabchick	Pilot	1896	153	27	5105	186	43.2	n/a	18	18
Redshank depositing ponds	Pilot	1869	167	6	18	Unrecorded	19.82	n/a	10.3	10.3
Raven	Pilot	1849	325	12	628	102	3.85	6.34	5	15
Redshank	Pilot	1848	204	15	615	101	17.4	n/a	10.3	10.3

Figures 2 and 3 below show the relative positions of the study reservoirs within study catchments 1 and 2.

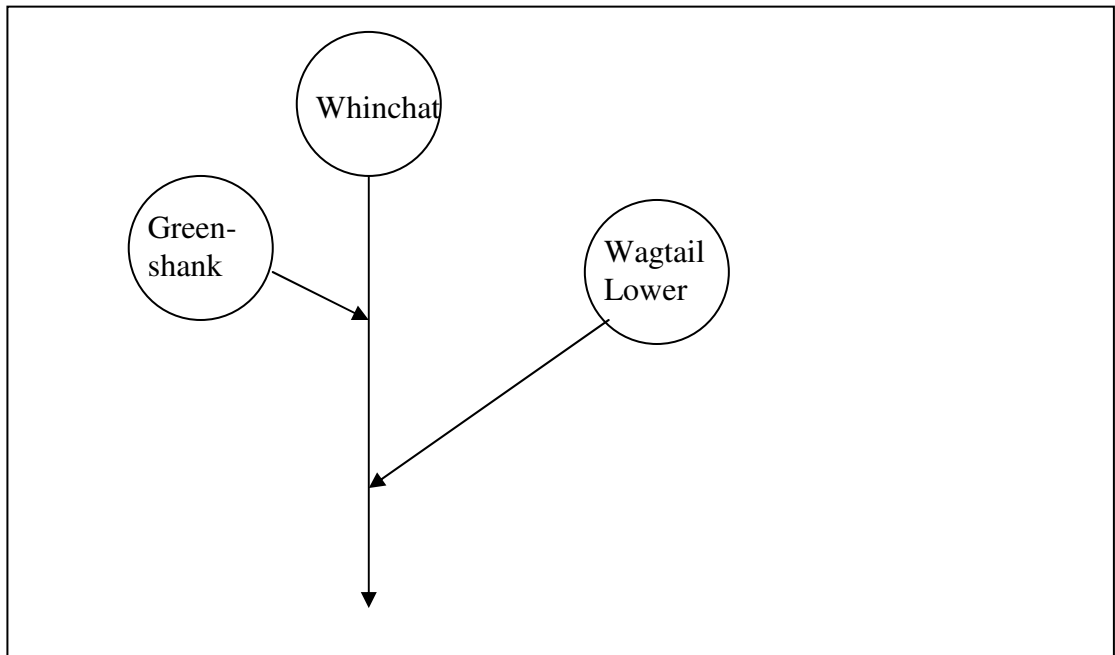

Figure 2: schematic map showing locations of reservoirs in Study Catchment 1

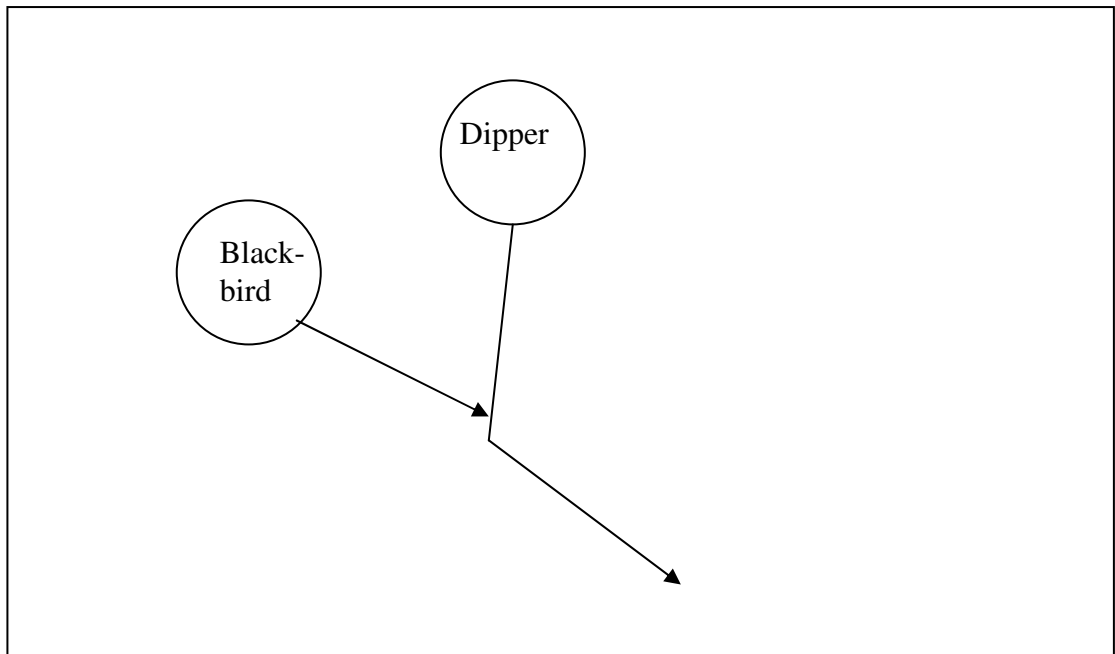

Figure 3: schematic map showing locations of reservoirs in Study Catchment 2

3.2.1 Mechanism of release

During a scour release by Yorkshire Water each of the release valves is opened to its full extent, releasing water directly into the stilling basin and subsequently into the downstream watercourse. At reservoirs with more than one release valve, the valves are opened sequentially, rather than concurrently. During a scour release, the deepest intake point will typically be used in situations where a number of intakes are available, creating the maximum discharge pressure and removing the maximum quantity of sediment from the reservoir. Periodically, each of the intake valves is also tested, prolonging the duration of the release, and possibly changing the quality of the release water from a stratified reservoir (see Section 3.5).

During spate releases by Yorkshire Water the same release valves are used, and the lowermost intakes are used in order to generate the maximum possible discharge. In the event that the discharge does not reach the intended level (Section 3.3), higher intakes may also be used. In practice this would only happen during the peak flow during the Dipper Reservoir spate release and not at all at Blackbird Reservoir. The initial pulse of water at both sites comes exclusively from the deepest intake, as does the vast majority of water throughout the duration of the releases.

3.3 Spate design

As artificial spate designs are intended to mimic natural high flow events, their design should vary from site to site, determined by local climate and catchment characteristics and by the nature of the impoundment. In practice, limitations are placed upon the spate design by reservoir engineering constraints and water resource budgeting. The magnitude and frequency of the spate releases is also determined by its perceived purpose. Spate releases intended to assist adult salmonid migration (either through provision of a stimulus to migrate (Thorstad and Heggberget 1998, Archer 2008b) or through temporary assistance in passing obstacles via enhanced flows (Reiser et al. 2006)) or to cleanse gravel beds of fine sediment (Nelson et al. 1987) should usually be performed annually, but may not be required in wet years when reservoirs over-spill. In situations such as that seen at Glen Canyon dam, where the releases are intended improve river geomorphology (Robinson and Uehlinger 2003) the ideal frequency may be lower but the magnitude of the release greater.

The original purpose of the Yorkshire Water spate releases was to cleanse gravel beds of fine sediment and to encourage upstream migration of brown trout at the start of the spawning season. Following initial planning conducted by Yorkshire Water and the Environment Agency, Stuart Lane and David Mould of Leeds University were contracted to design a release program for Dipper and Blackbird reservoirs (Mould and Lane 2003). The proposed spate hydrograph was designed using data from the Flood Estimation Handbook (FEH) produced by the Institute of Hydrology, UK (1999) to estimate the characteristics of natural spates in the Blackbird and Dipper reservoir catchments in the absence of the reservoirs. The design was based on a one in two year storm event of five to eight hours duration, producing flows with a maximum discharge of $3.4 \text{ m}^3 \text{ sec}^{-1}$ per metre width of the river bed, and appears in Figure 4 below. As the catchment characteristics for each reservoir are very similar (similar catchment size, micro-climate, geology, land-use) the same hydrograph was proposed for each reservoir. However, it was immediately apparent that neither reservoir could achieve the required peak discharge due to release valves having insufficient maximum discharge capabilities. The typical channel width at each site was between 2.5 and 6 m requiring theoretical discharges of up to $18 \text{ m}^3 \text{ sec}^{-1}$ to achieve the modelled flow rates. Consequently, the spates were redesigned to consider maximum achievable reservoir discharges. The actual releases hydrographs are stepped rather than curved due to the manual operation of release valves, reflecting the time taken to achieve and record a given discharge.

The maximum achievable discharge at Dipper reservoir is approximately one third to one half the flow at the peak of the proposed hydrograph, while at Blackbird an even smaller spate was achievable. Spates were planned for October each year to minimise disturbance to new trout redds while allowing the previous year's trout fry to achieve maximum growth prior to the flow events.

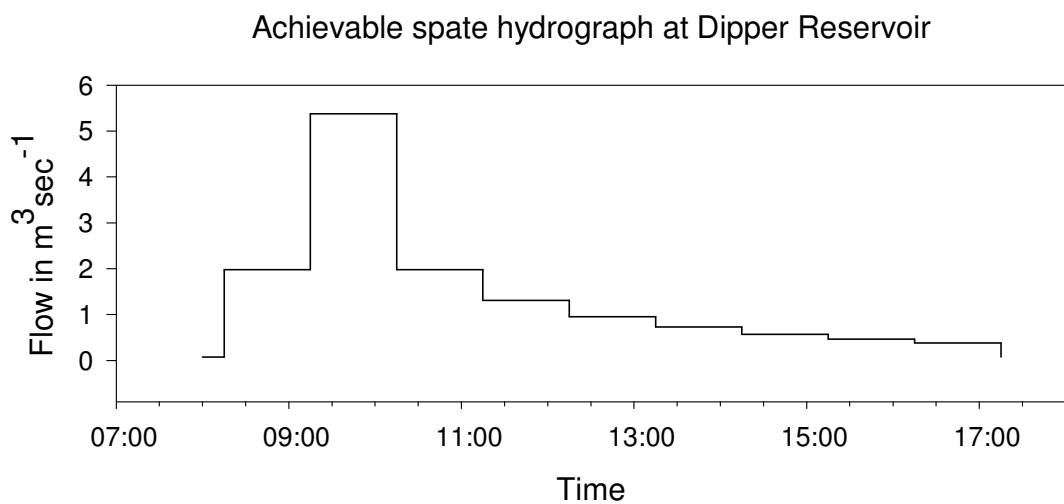
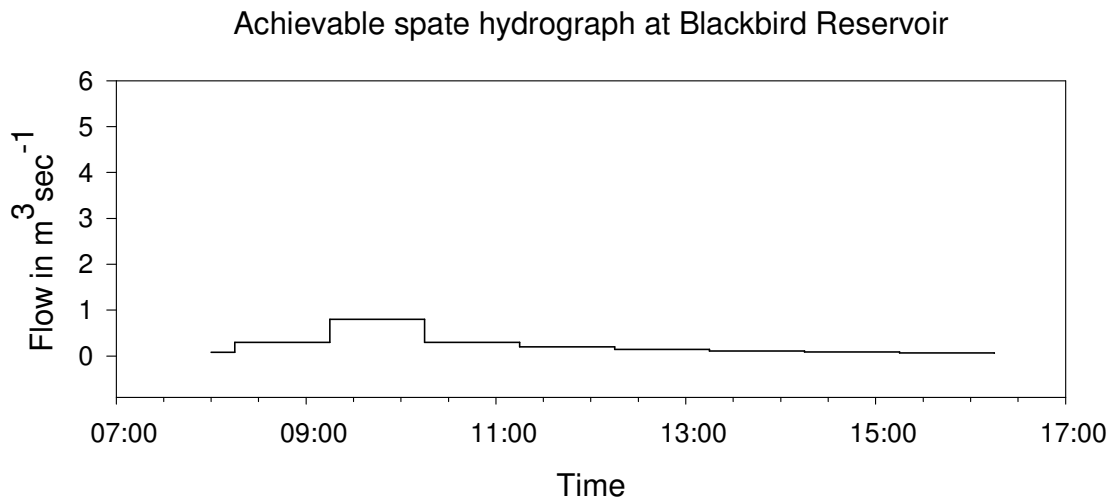
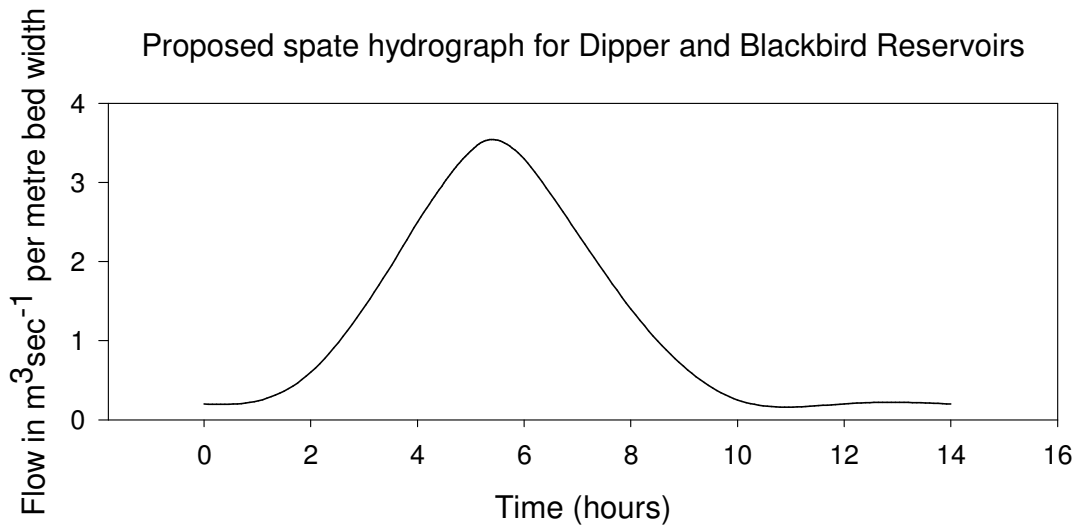

Figure 4: proposed and achievable spate hydrographs for Blackbird and Dipper reservoirs, study catchment 2. (Data from Mould and Lane, 2003)

3.4 *Effects of the study reservoirs on stream flow*

Yorkshire Water operates rain gauges at three of the five reservoirs in Catchments 1 and 2. Comparisons of rainfall and reservoir overflow (the point at which flood water enters the stream downstream of the reservoirs, a good indicator of flow variability below the reservoirs) appear in Figures 4 and 5 below. The figures show that a high-rainfall event is not always the trigger for an overflow-event.

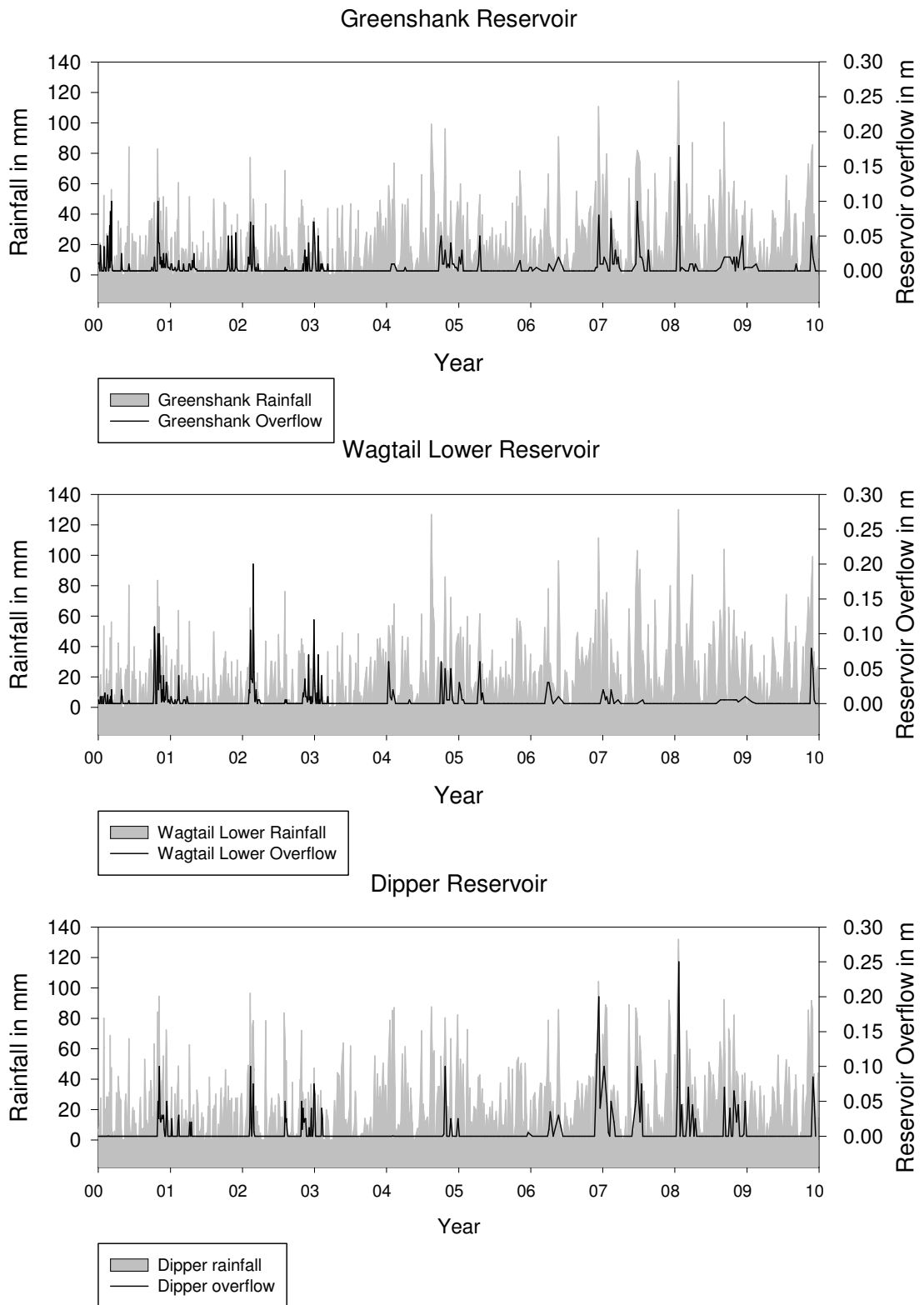

Figure 5: rainfall and reservoir overflows at Greenshank, Whinchat and Dipper Reservoirs, 2000 to 2009

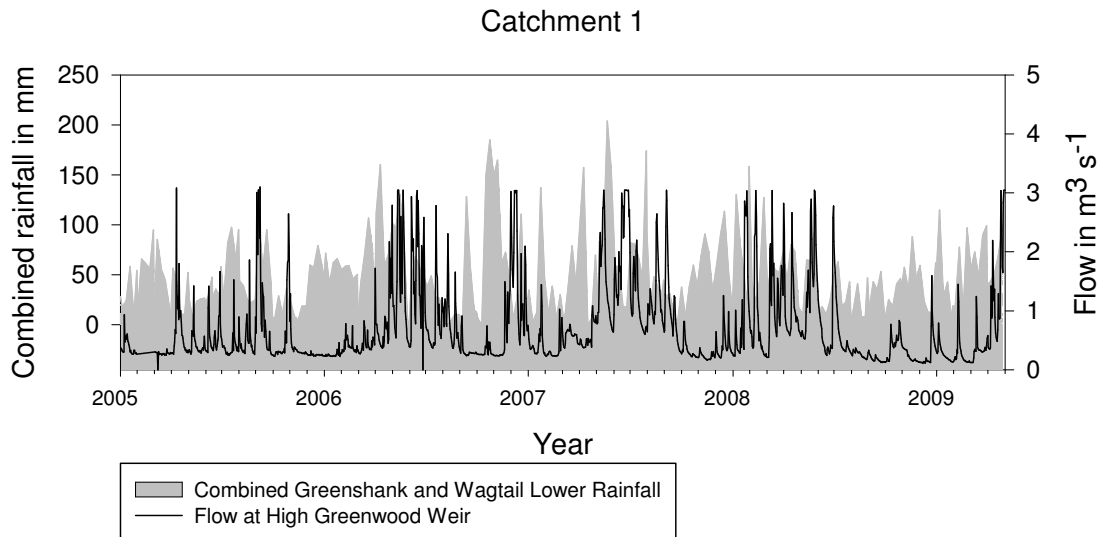

Figure 6: rainfall and river flow in Catchment 1, 2005 to 2009. The flow gauge at High Greenwood weir is downstream of Greenshank and Wagtail Lower reservoirs and provides an estimate of the combined discharge of both reservoir catchments plus that of Whinchat

3.5 Effects on water quality

Despite regular monitoring of water quality in the Yorkshire Water catchment by the Environment Agency, and the monitoring of water quality upon entry to and exit from treatment works, data on the effects of the reservoirs upon river water quality is limited. One unpublished data set does exist (YWS 1992), examining the differences in water quality at the surface and at the bottom of Sparrow reservoir (23.7 m maximum depth, 175m AOD, 555 tcm capacity). The data in Figure 7 below (from YWS, 1992) show that the surface waters were warmer than the bottom waters by up to 9 °C in the Summer and Autumn months, but differences were minimal from late Autumn through to early Summer, and in particularly cold conditions the lower layers may be warmer than the surface waters. Dissolved oxygen levels were consistently higher at the surface during the two year monitoring period, however levels appeared to rise from Autumn until Spring, when differences between the layers were least. The increase in dissolved oxygen in the lower layers appeared to coincide with the disappearance of the thermocline as the waters cooled and became more homogenous. pH data taken during the same period showed no difference in pH at the different depths.

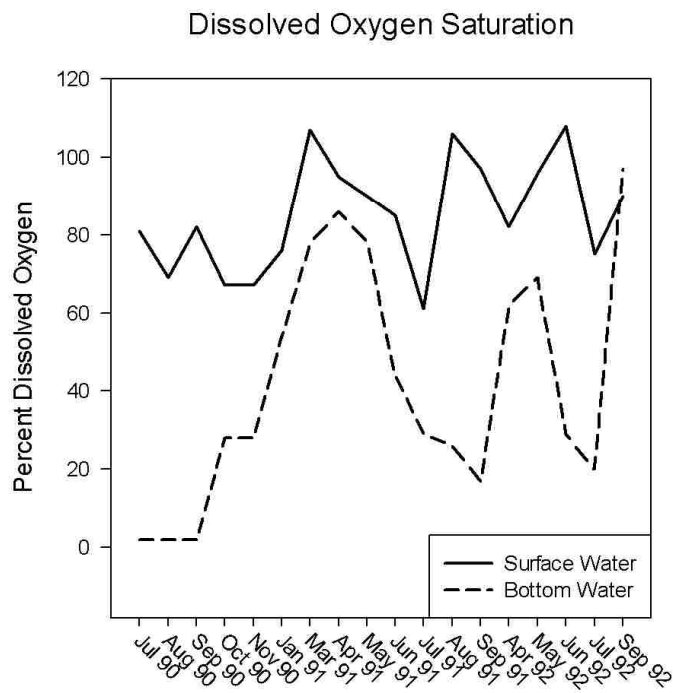
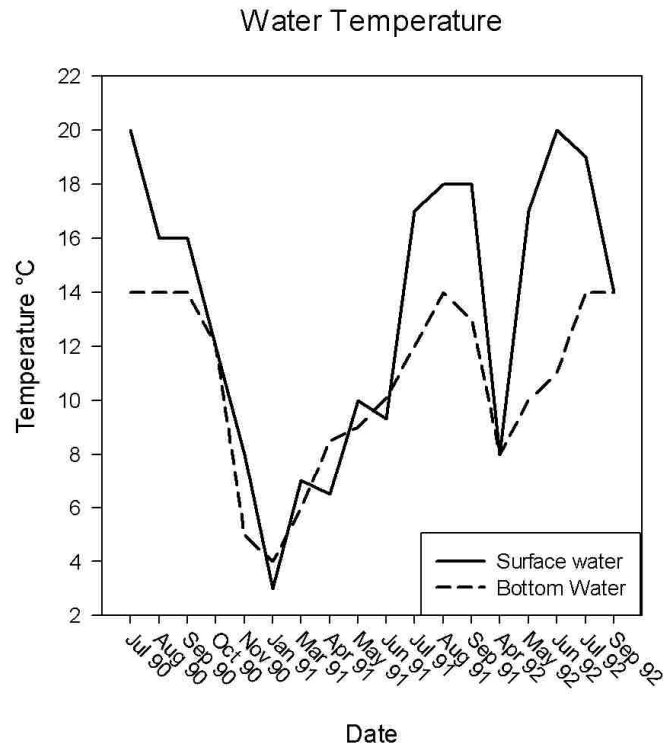

Figure 7: differences in water temperature and dissolved oxygen between the surface (upper lines) and bottom water (lower lines) of Sparrow Reservoir

3.6 Inlet and outlet temperatures

Temperature loggers were deployed at the inlets and outlets of Dipper and Whinchat reservoirs (for locations see Figures 2 and 3) between November 2, 2009 and January 29, 2010 to attempt to assess the effects of the reservoir on the water temperature downstream. The data are summarised in Table 11, below.

Table 11: Differences in inlet and outlet temperatures at Whinchat and Dipper reservoirs.

Site	Mean Temp °C	Standard Deviation °C	Paired two-tailed t-test
Whinchat Inlet	2.7	3.5	$t = 4631843$
Whinchat Outlet	2.0	3.9	$n = 2106$ $p = <0.001$
Dipper Inlet	2.5	3.9	$t = 4244003$
Dipper Outlet	3.1	3.6	$n = 2106$ $p = <0.001$

The data show that the water temperatures at the inlet and outlet were significantly different at each of the reservoirs. However, while Whinchat has a cooling effect in Winter, Dipper has a warming effect. In both cases the differences in mean temperature over the course of the study period were less than 1 °C.

3.7 Sediment accumulation and release

A number of studies have examined sediment delivery and storage in Yorkshire Water reservoirs (White et al. 1996, Yeloff et al. 2005, Kay et al. 2009), reporting depositional rates of up to 28 tonnes per square kilometre of reservoir bed per year. Internal Yorkshire Water studies (unpublished) have estimated Greenfinch Reservoir, an upland reservoir with a particularly large peaty catchment, accumulates up to 34 tcm of sediment per year, and it was partly with the intention of removing accumulating fine sediment that the scour releases were designed. The rate of accumulation and type of sediment is dependent on the nature of the catchment and the presence of residuum lodges upstream (White et al. 1996, Kay et al. 2009), and will vary greatly between reservoirs. Similarly the amount of sediment released during the scour releases will depend largely upon the positioning of the intakes of the scour pipes and the turbulence and force generated on the reservoir bed by the release. Visual reports note a significant increase in turbidity during scour releases as some of the sediment is mobilised, occasionally leading to pollution investigations.

3.8 Water quality summary and implications

Although the amount of data on the water quality within and immediately downstream of the reservoirs is limited, the above data on dissolved oxygen and temperature suggest that released water may be low in dissolved oxygen and of a different temperature to water in the receiving streams, and that the extent of any differences may vary depending upon the time of year, design of reservoir and level of stratification. The pH data for these reservoirs are also limited, and fail to identify changes in pH due to stratification, however, as with other physio-chemical factors, pH of release water is likely to vary from site to site.

The study-catchment reservoirs are known to accumulate fine sediment and also to release it during scour releases and this represents a cause for concern due to possible physiological impacts on both fish and invertebrates (Chapter 1) and the detrimental effects it may have on salmonid spawning gravel quality and macroinvertebrate habitat quality.

3.9 Conclusions

The reservoirs of the Yorkshire Water catchment are relatively small (typically < 6000 tcm) in comparison to those studied in the wider scientific literature, but are representative in size and design of a great number of reservoirs around the globe. Due to the varying designs and environmental conditions associated with any particular reservoir it is difficult to predict the effects it will have on water quality and therefore the impacts that short duration releases may have.

The rainfall and overflow data shown in Section 3.4 highlight one of the key aspects of impoundment, showing the diminished frequency of overspilling events in contrast to high rainfall events, leading to a dampening of the natural hydrograph and emphasising the need for mimicked spate flows.

The data in this chapter show that there may be impacts associated with a lack of dissolved oxygen, variable water temperature and fine suspended sediment load associated with releases from the study reservoirs, and that water quality, and therefore release impact may vary throughout the year. The study reservoirs vary in both their storage capacity and maximum discharge rate, so any responses seen to changes in flow are also likely to vary from site to site.

Chapter 4: Understanding the physiochemical impacts of short-duration reservoir releases

4.1 Introduction

This chapter examines the hydrological and physio-chemical changes associated with the scour and spate releases, testing the following hypotheses:

1. reservoir releases cause sufficiently large changes to the hydrology of the receiving streams to affect the resident biota for several kilometres downstream
2. reservoir releases cause changes to pH, temperature, dissolved oxygen and suspended sediment levels in the receiving stream
3. reservoir releases are capable of reducing the quantities of fine sediment or algae entrained in the river bed

4.2 Methodology

In order to ascertain the likely ecological effects of the reservoir releases it was necessary to gain an understanding of the magnitude and the temporal and spatial extent of any hydrological and physio-chemical changes. To achieve this, a pilot study was undertaken monitoring a number of releases at various sites in the Yorkshire Water catchment in early 2008. Analysis of the results of the pilot study allowed targeted monitoring of the full ecological and physio-chemical impacts of reservoir releases in Catchments 1 and 2 from Autumn 2008 to Autumn 2009. The choice of the pilot reservoirs, and the subsequent use of the Catchment 1 and 2 reservoirs are described in Chapter 2.

Table 12: Yorkshire Water reservoir releases monitored 2008 to 2009

Date	Reservoir	Catchment	Release type	Physio-chemical data gathered?	Ecological data gathered?
30/01/08	Avocet	Pilot	Scour	Yes	
12/02/08	Dabchick	Pilot	Scour	Yes	
13/02/08	Redshank	Pilot	Scour	Yes	
	depositing ponds				
20/02/08	Raven	Pilot	Scour	Yes	
27/02/08	Redshank Dams	Pilot	Scour	Yes	
18/03/08	Wagtail Lower	1	Scour	Yes	
19/03/08	Greenshank	1	Scour	Yes	
01/04/08	Whinchat	1	Scour	Yes	
10/09/08	Greenshank	1	Scour	Yes	Yes
17/09/08	Wagtail Lower	1	Scour	Yes	Yes
24/09/08	Whinchat	1	Scour	Yes	Yes
18/03/09	Greenshank	1	Scour	Yes	Yes
25/03/09	Wagtail Lower	1	Scour	Yes	Yes
12/05/09	Whinchat	1	Scour	Yes	Yes
16/09/09	Dipper	2	Scour	Yes	Yes
23/09/09	Blackbird	2	Scour	Yes	Yes
13/10/09	Blackbird	2	Spate	Yes	Yes
14/10/09	Dipper	2	Spate	Yes	Yes

For the pilot releases prior to September 2008 only flow, physio-chemical and sediment data were recorded. For the subsequent releases, once a good understanding of the physio-chemical changes had been attained, the ecological data described in Chapters 5 and 6 were also recorded. At every release the following physical data were recorded:

- Changes to flow
- Water temperature
- pH of stream water
- Dissolved oxygen levels
- Suspended sediment levels

4.2.1 Flow

Flow data were recorded using telemetered release pipes and gauging weirs owned by Yorkshire Water or the Environment Agency at the sites shown in Figures 8 and 9 below.



Figure 8: locations of gauging weirs in Catchment 1. Approximate scale 1:15000



Figure 9: locations of gauging weirs in Catchment 2. Approximate scale 1:15000

The weirs record stream stage at 15 minute intervals and are subject to regular maintenance. These stage measurements are then converted to flow measures, recorded in thousand cubic metres per day (tcmd) and recorded on Yorkshire Water and Environment Agency databases as part of the statutory requirement to maintain and monitor compensation flows. Stage measurements at the weirs are converted to flow measurements using conversion curves specific to each weir, calibrated on installation and re-assessed at intervals since.

The downstream gauging weir in Catchment 1 is only capable of reading flows below 3000 m³ s⁻¹. However, in order to provide a picture of the true magnitude of the natural floods that occurred in Autumn 2008, the peak flows have been modelled based on the recorded outputs of Greenshank and Whinchat reservoirs. At flows below the 3000 m³s⁻¹ threshold, the average flow at the gauging weir was 1.8 times the sum of the mean flows from Whinchat and Greenshank. Any flows above the recording threshold have therefore been replaced with values calculated using the formula:

$$E_f = 1.8 * (G_f + W_f)$$

Where E_f = estimated flow at site 4 gauging weir (Figure 10, below)

G_f = recorded flow at Greenshank

W_f = recorded flow at Whinchat

Although Wagtail reservoir is equipped with a flow gauge, the gauge only measures compensation flows, and excludes output from the scour valve and overspill from a full reservoir. Although it would have been possible to present calculated flow rates as opposed to measured depths for the Wagtail reservoir releases, the doubtful value of the velocity readings in high flows (see below) makes depth the more reliable measure of in-channel hydrological change. Similarly, at Dipper reservoir the gauging equipment in the stilling basin could not reliably read the peak flows achieved during scour releases due to growing levels of turbulence in the stilling basin as the release rate increased. In this case Yorkshire Water contracted a hydrologist to record flow rates through the release pipe using an ultrasonic flow meter.

In addition to the flow data, velocity and depth measurements were also taken with a ruler and flow meter at regular intervals throughout the releases at the sites shown in Figures 10

and 11 below. The use of the velocity meters was abandoned following the pilot studies after it became apparent that measuring velocity at a fixed point in the channel during the elevated flows was a health and safety risk, and that bank-side measurements gave a poor picture of velocity changes in the channel due to eddying currents and increased friction and turbulence close to the bank. It also became apparent that in natural channel sections the location of the thalweg changed as flows increased. Graphs showing the changes to velocities recorded at fish tag sites 1 and 3 (see Figure 10) below Greenshank and Wagtail Lower reservoirs appear below. A series of five velocity readings were taken at approximately one third of depth at five minute intervals and the average readings are plotted with water depth below. The data for the Greenshank release (Figure 12) show that peak velocities at the measuring point were recorded shortly before peak depths and then began to drop off as discharge increased. Visual observations showed that the velocity did in fact appear to continue to increase in mid-channel, but the thalweg moved further from the measuring point, leaving a distorted picture of flow changes in the stream. Similarly during the Wagtail Lower release velocity initially fell as depth increased, again as a result of the thalweg moving as the channel dynamics change, and also as a result of the creation of eddies close to the bank at the measuring site during the elevated flows.



Figure 10: sites used for depth and velocity measurements in Catchment 1

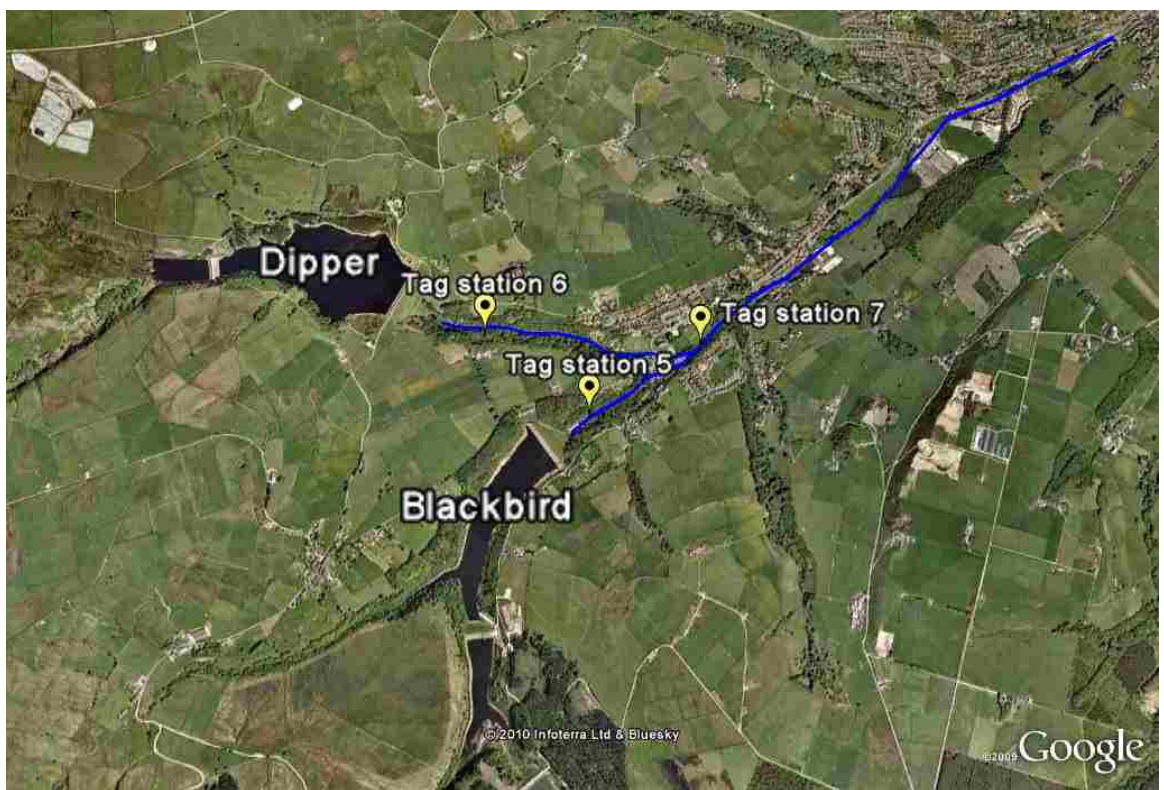

Figure 11: sites used for depth and velocity measurements in Catchment 2

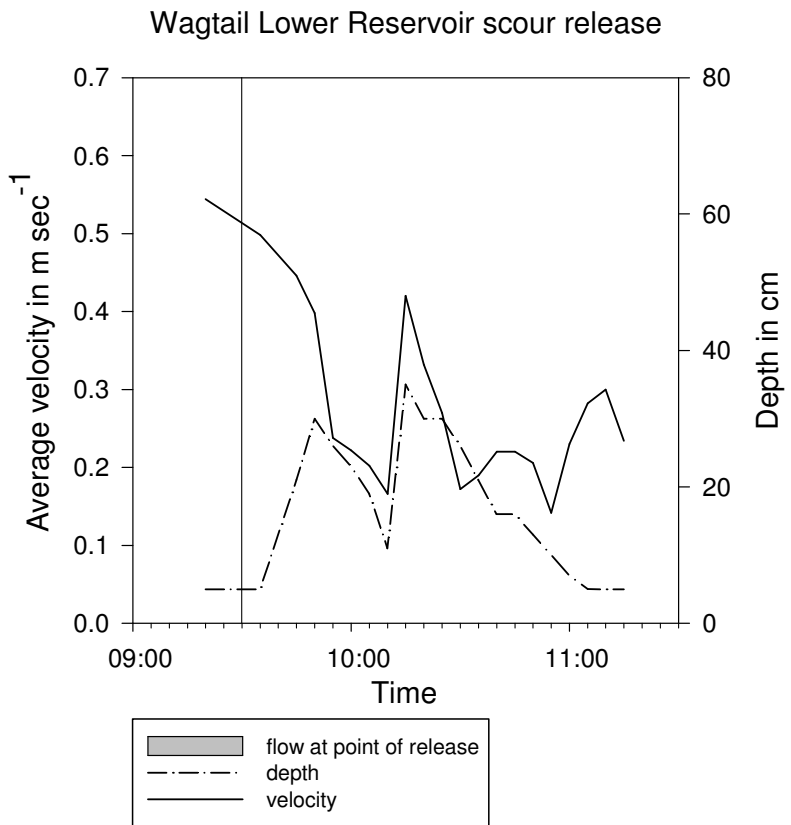
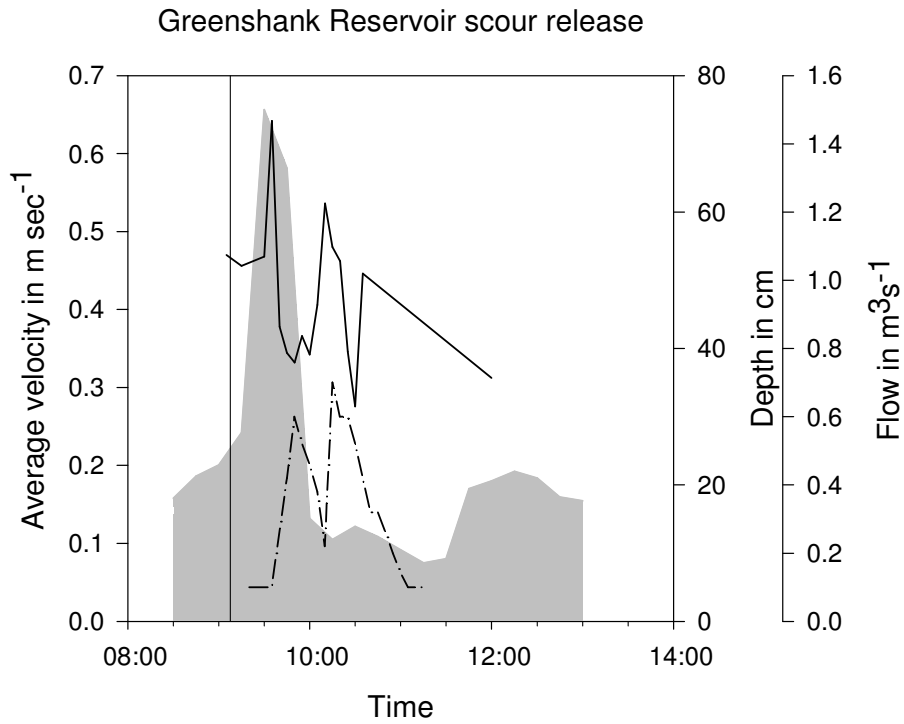

Figure 12: changes to depths and velocities at recording stations during scour releases at Greenshank and Wagtail Lower reservoirs. Vertical lines indicate valve opening times. Flows for Greenshank reservoir were recorded at a telemetered weir at the reservoir outlet. No telemetered data were available for Wagtail Lower.

4.2.2 Water temperature

Water temperature was recorded at each of the sites in Figures 10 and 11 during each of the releases using a YSI 556 multiprobe submerged in the stream in flowing water and set to record at 30 second intervals. Readings began approximately one hour prior to the opening of the release valves and continued for a minimum of one hour after the flow had subsided at the recording site. No calibration of the YSI thermometer function is necessary (YSI-Environmental 2002).

In addition to the recording on release days, permanent temperature loggers were deployed at each of the sites shown in Figures 10 and 11 throughout the Spring 2008 and Autumn 2009 monitoring periods. These loggers were also deployed at the inlet and outlet of Dipper and Whinchat reservoirs for several months from Autumn 2009 to Spring 2010 to investigate the effects of impoundment upon stream water temperature.

4.2.3 pH and dissolved oxygen

pH and DO were also recorded using the YSI 556 probes as above during the reservoir releases, beginning a minimum of one hour prior to release and ending at least one hour after the flow subsided. Probes were calibrated and cleaned by Durham University Geography Department laboratory staff less than 24 hours prior to deployment and positioned in running water at sufficient depths to completely submerge probes at low flows. No specific calibration times of the pH and DO function are recommended by the manufacturers, however calibration is recommended if readings become inaccurate (YSI-Environmental 2002). To check probe reliability each of the two or three probes used at each release were run synchronously in still water prior to release to check for consistency of pH and DO readings. Problems did occur when probes were washed out of the water or temperatures were extremely low. These events are discussed in the results section below.

4.2.4 Suspended sediment

One litre water samples were taken below the reservoirs at upstream and downstream sites at each of the releases at 15 minute intervals beginning one hour before the releases and ceasing one hour after the flows subsided. The upstream sites were as close to the point of release as possible while the downstream sites varied in their distance from the reservoir

(Figures 10 and 11). In the cases of Whinchat, Dipper and Blackbird reservoirs it was possible to install a Rock & Taylor automatic water sampler to take samples directly from the stilling basin, very close to the point at which the water is released into the stream. These machines drew samples approximately every 10 minutes through the duration of the releases. It was not possible to use the samplers at downstream sites or at other reservoirs due to the remote and rugged locations, and the difficulty in installing the sample tube without a stilling well, which would have defeated the purpose of the sampling.

Samples were processed in the Geography Department laboratories by the author. The volume of each sample was measured and the samples then passed through pre-weighed, dry filter papers (1.2 μ m pore size). The remaining filtrands were desiccated along with the filter papers at 120°C for a minimum of 12 hours to remove all moisture. The filter papers were then removed and weighed, giving a mass of sediment which was then divided by the original sample volume to produce a concentration in g l⁻¹.

In addition to the suspended sediment samples visual recordings of percentage cover of fine sediment and algal growth were made in riffles in Catchment 2 immediately before and after each of the Autumn 2009 releases to ascertain the flushing effects of the releases upon the river bed. These measurements were not possible in Catchment 1 due to the dark colouring of the water, which made the bed practically invisible, even at shallow depths.

Concentrations of fine sediment in the river bed were also recorded before and after Dipper reservoir releases as part of Simon DeSmet's Master's thesis (DeSmet 2010). An open ended circular metal tube of known bore was pushed into the river bed at eight evenly spaced comparable sites between 100 m and 2 km from the release site 24 hours before and immediately after each release. Sample locations were chosen to allow entry of the sampler into the bed (i.e. no bedrock substrate) and to be similar in terms of water depth, velocity, channel position and substrate type. Sediment was then vigorously disturbed for 30 seconds within the tube and a water sample taken immediately, also from within the tube. These samples were processed in the same manner as the earlier suspended sediment samples by Simon DeSmet at Leeds University and were used to provide an estimate of the volumes of fine sediment in the river bed. Although this technique obviously has limitations, relying on a limited number of small samples to represent large areas of river bed and also due to the heterogeneity of the river bed making it difficult to compare

samples, the selection of the sample sites minimised these problems to the extent that if a clear effect took place it should be detectable in the results.

4.3 Results

The results below are presented in chronological order, beginning with the initial pilot studies in 2008 and followed by the studies in Catchment 1 (scour releases in Autumn 2008 and Spring 2009) and Catchment 2 (scour and spate releases in Autumn 2009).

4.3.1 Pilot investigations

Flow

The 15 minute telemetered flow data from six of the pilot study reservoirs appear in Figure 13 below. Where flow gauges were not available depth measurements are presented (Section 4.2.1). Unfortunately release data is not available for Wagtail Lower reservoir, where only flow through the compensation flow pipe is recorded, and scour releases at this site are performed through a separate scour pipe. At four of the six sites the scour tests constituted a double release, visible in the twin peaks seen on the graphs. At each site the rates of change in flow were high (up to $0.04 \text{ m}^3 \text{ s}^{-1} \text{ min}^{-1}$, or approximately a threefold increase over 15 minutes). The maximum discharges were variable, depending on reservoir design, ranging from $0.016 \text{ m}^3 \text{ s}^{-1}$ at Avocet (a small reservoir with no compensation release) to almost $4 \text{ m}^3 \text{ s}^{-1}$ at Whinchat.

Where available, the flow changes recorded at downstream gauging weirs also appear. The wave produced by the releases was visible at up to 5650 m downstream (Redshank Depositing Ponds), and diminished with increasing distance from the reservoir. The largest of the releases, from Whinchat reservoir was not detected at the gauging weir 4890 m downstream, possibly due to preceding heavy rainfall and high flows masking the effects of the release. At several sites, notably Greenshank, Redshank and Whinchat, increasing flows and confluence effects mask the effects of the releases at the downstream gauges as the increase due the release becomes an increasingly small proportion of overall flow.

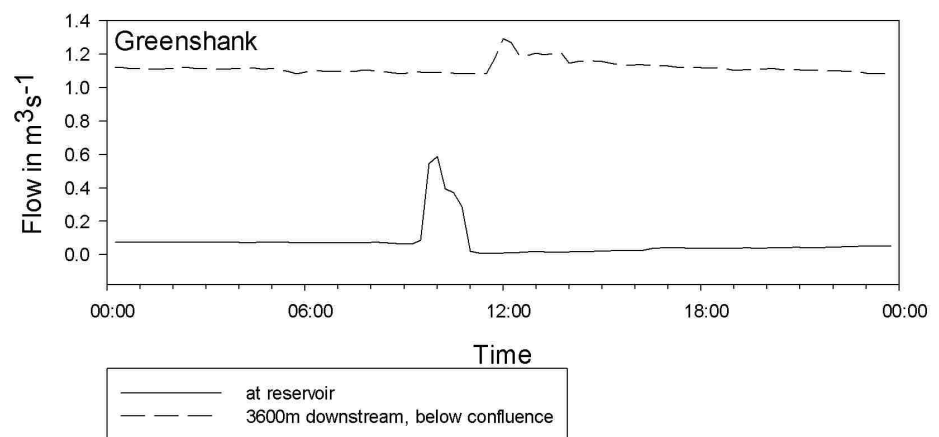
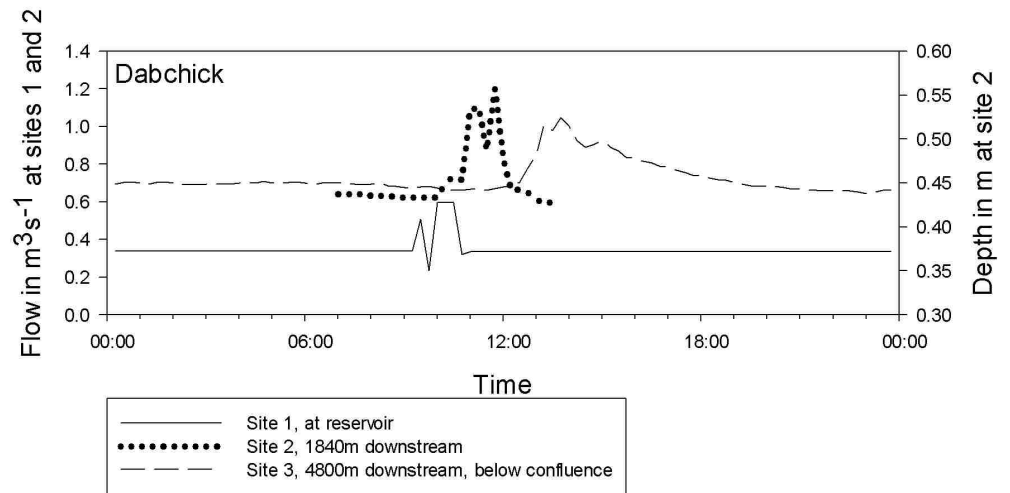
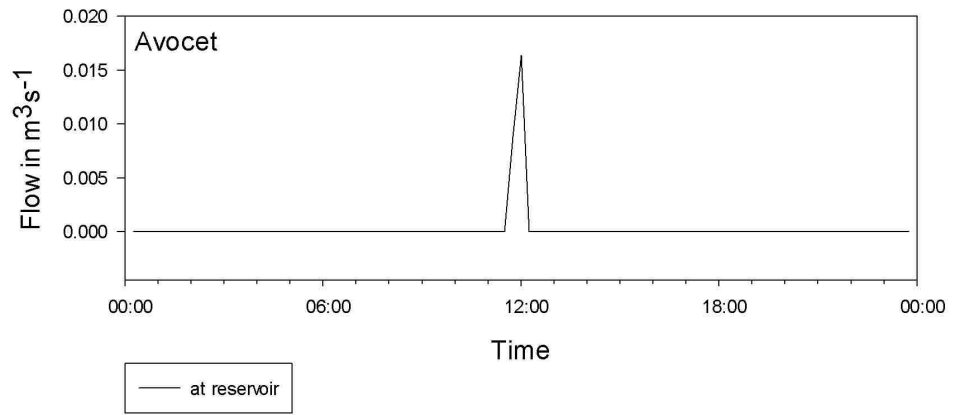

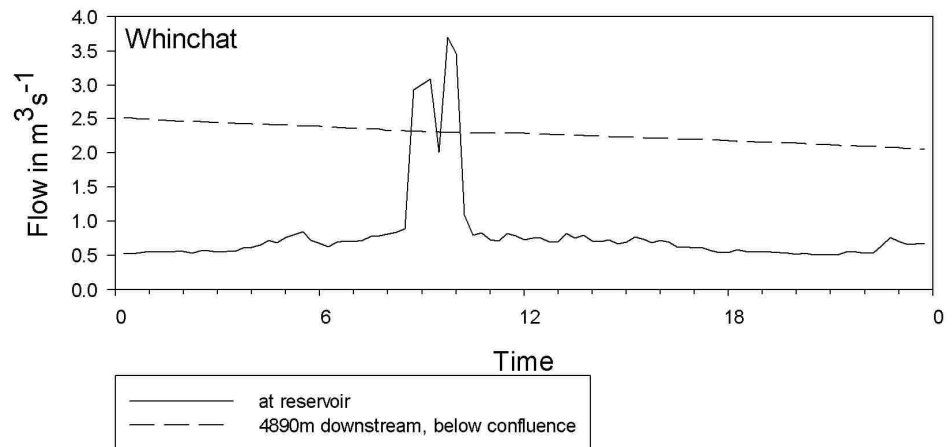
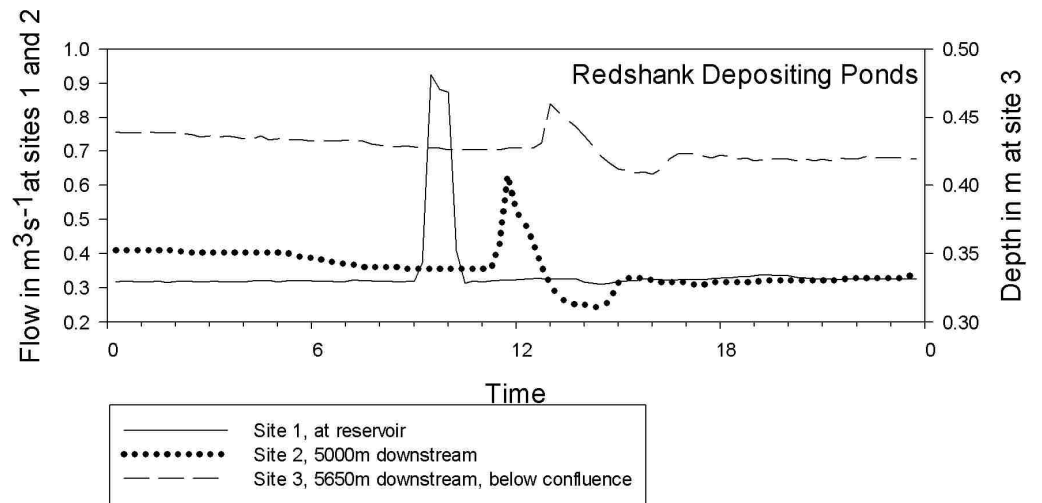
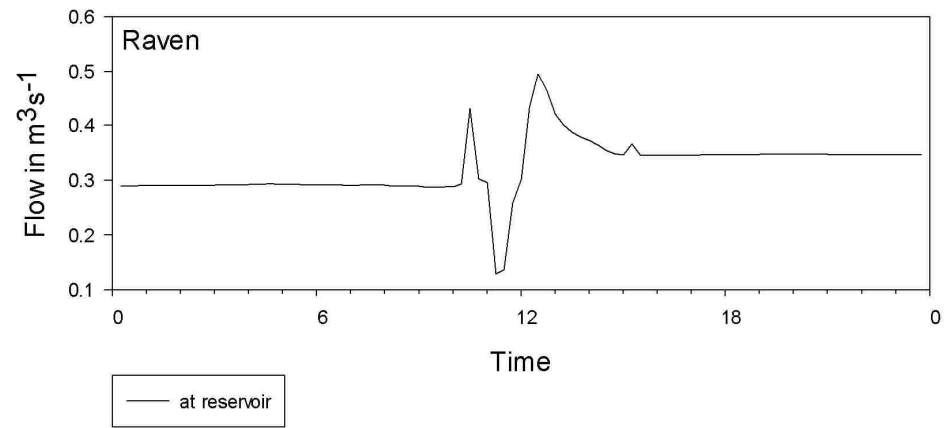

Figure 13: telemetered flow data from points of release and downstream weirs for pilot study reservoirs

The metrics of each release are described in Table 13 below. The flow metrics chosen were those which were likely to be most relevant to the downstream biota. Of most ecological relevance are the magnitude of change and the rate of change descriptors, as high discharges are not necessarily damaging provided the biota has time to respond (see Sections 1.8 and 1.9).

Table 13: flow metrics for pilot scour releases

Reservoir	Avocet	Dabchick	Greenshank	Raven	Redshank depositing ponds	Whinchat
Base flow (m ³ s ⁻¹)	0	0.35	0.08	0.29	0.32	0.51
Peak Flow, Qmax (m ³ s ⁻¹)	0.02	unknown	0.6	0.50	0.92	3.7
Magnitude of change (peak flow / base flow)	n/a	unknown	7.5	1.7	2.9	7.3
Time to Qmax (mins)	30	55	50	160	15	100
Rate of change (magnitude of change per minute)	n/a	unknown	0.15	0.01	0.19	0.07
Release duration (mins)	50	110	110	250	100	120

Water physio-chemistry and suspended sediment

Summary water quality data from the pilot reservoir scour releases appear in Table 14, below.

Table 14: summary of physio-chemical changes recorded during pilot scour release monitoring, January to April 2008

Variable	Mean change at point of release	Maximum change at point of release	Furthest distance downstream change detected
Temperature	-0.7 °C	-1.6 °C	1800 m
DO	+5 %	+15 %	600 m
pH	Direction of change variable, most commonly < 0.5 pH decrease	+1 pH	1800 m
Suspended sediment	+45 mg/L	+103 mg/L	6500 m

Water Temperature

The data from the pilot studies showed an immediate but short-lived drop in water temperature downstream of six of the seven study reservoirs following the opening of the

scour valve. The reservoir at which no change was recorded, Redshank Depositing Ponds was much shallower with a far lesser volume than the other reservoirs (Table 10). The maximum fall in temperature was 1.6 °C, recorded at Raven reservoir. At each site temperatures returned to pre-release levels once the valves were closed and compensation flows resumed. The drop in temperature was detected some distance downstream of two of the reservoirs (Raven and Greenshank reservoirs, 0.2 and 0.1°C respectively) but was not detected further than 1800 m downstream of the release sites. No problems with thermometers were detected.

Dissolved oxygen

The dissolved oxygen results were variable, showing peaks in oxygen levels at release times at Dabchick, Greenshank and Raven reservoirs, a drop at Redshank Dams and no change at Avocet or Redshank Depositing Ponds. No readings below 100% saturation were recorded at any time, and no changes were seen further than 600 m from the point of release. It was apparent that the force with which the water exited the release pipes and the subsequent turbulence allowed instant oxygenation of the released water (the exception to this was Redshank Depositing Ponds where very little release pressure was generated due to its shallow depth and multiple release pipes). Oxygen levels typically decreased slowly as the day progressed. This steady decrease was matched by a gradual increase in water temperature and resultant decrease in the water's oxygen-carrying capacity.

pH

The pH results showed considerably more variation than either the temperature or dissolved oxygen results, varying mostly within the pH 5 to 8 range. The results from Raven reservoir did not appear to be reliable, possibly due to an air temperature of -8°C and water temperature falling to 1.5°C during monitoring. Three of the seven sites appeared to show a drop in pH of up to 1 pH unit associated with the releases. With the exception of Raven reservoir, where the readings were unreliable, pH generally increased with distance downstream, and although care should again be taken when comparing results from different probes, this effect was relatively consistent.

Suspended sediment

The results showed a clear increase in suspended sediment concentrations below each reservoir following the opening of the release valves, with the exception of Redshank

Depositing Ponds which is the shallowest by far of the study reservoirs at just over 6 m, and located immediately downstream of a much larger reservoir group. The magnitude of change and peak concentrations seen below each reservoir varied greatly with Raven reservoir discharging water containing 120 mg/l of suspended sediment. The changes downstream were generally less pronounced, although unlike changes to temperature, DO or pH, they could be detected for up to 6.5km downstream. At the sites where post-release samples were taken (Wagtail Lower, Greenshank, Dabchick and Redshank Depositing Ponds), levels fell rapidly after the valves were closed.

Pilot study summary

The pilot studies showed that the changes to in-river flows seen during the scour releases were both rapid and large in the locality of the reservoir outflows, and a potential threat to both fish and macroinvertebrates, highlighting the need to assess wash-out and stranding effects on these groups. The physio-chemical data showed that although the releases undoubtedly affected the water quality in the receiving rivers the changes were not as great as initially suspected. The changes were however of sufficient magnitude to warrant further monitoring of each of the chosen variables during the continuing studies. The suspended sediment data in particular appeared to warrant further study as the pilot data were limited but did reveal large changes to sediment transport during the releases which could have ecological consequences.

4.3.2 Scour releases, Catchment 1 Autumn 2008

Flow

Hydrographs showing the changes in flow on scour release days appear in Figure 14 below. The flows for Greenshank and Whinchat reservoir were taken from the telemetered on-site flow gauges. Only compensation flows were recorded at Wagtail Lower, as opposed to total amount released, so in this case depths are shown, measured at recording site 1 (Figure 10).

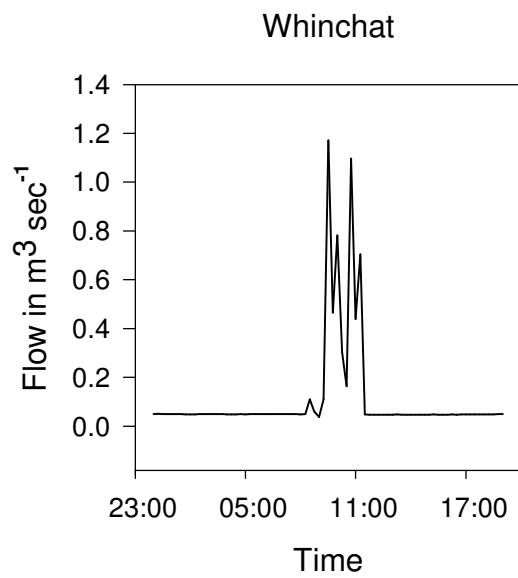
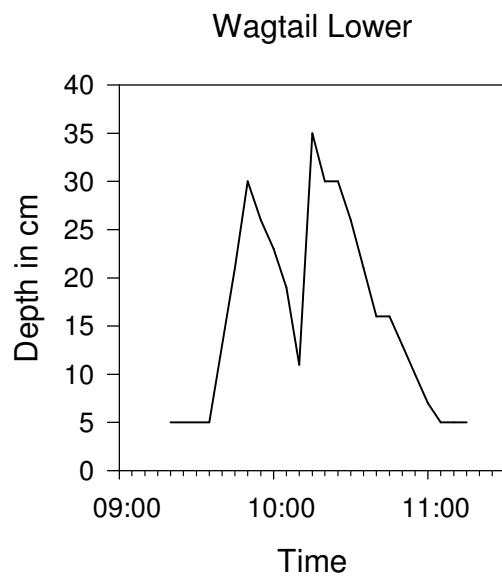
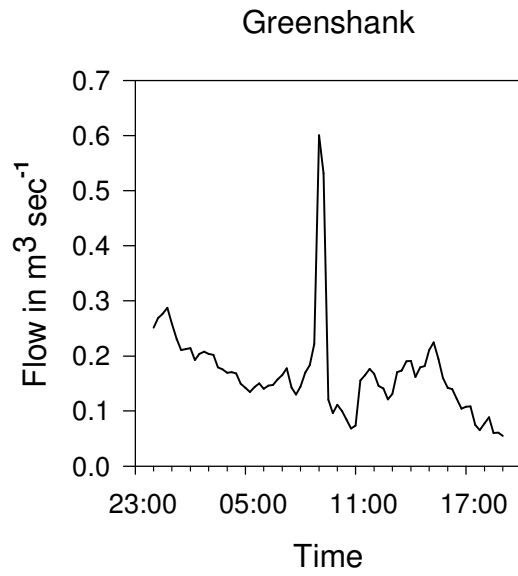

Figure 14: scour release hydrographs, Catchment 1, Autumn 2008

The graphs show changes in magnitude of flow of up to 16 times (Whinchat reservoir) in a space of 15 minutes, with a similarly rapid decrease in flow as the valves were closed. The two peaks in discharge at Whinchat and Wagtail Lower represent the opening of the two different scour valves at each of these reservoirs in quick succession, while Greenshank only has a single scour valve. The irregular discharge preceding and following the release at Greenshank is a product of the overspilling reservoir on the day. The rate of overspill varies according to wind speed and direction, and the rate of input from the catchment.

The changes in flow recorded at the downstream gauging weir downstream of site 4 appear in Figure 15 below. At this point the stream receives input from each of the study reservoirs.

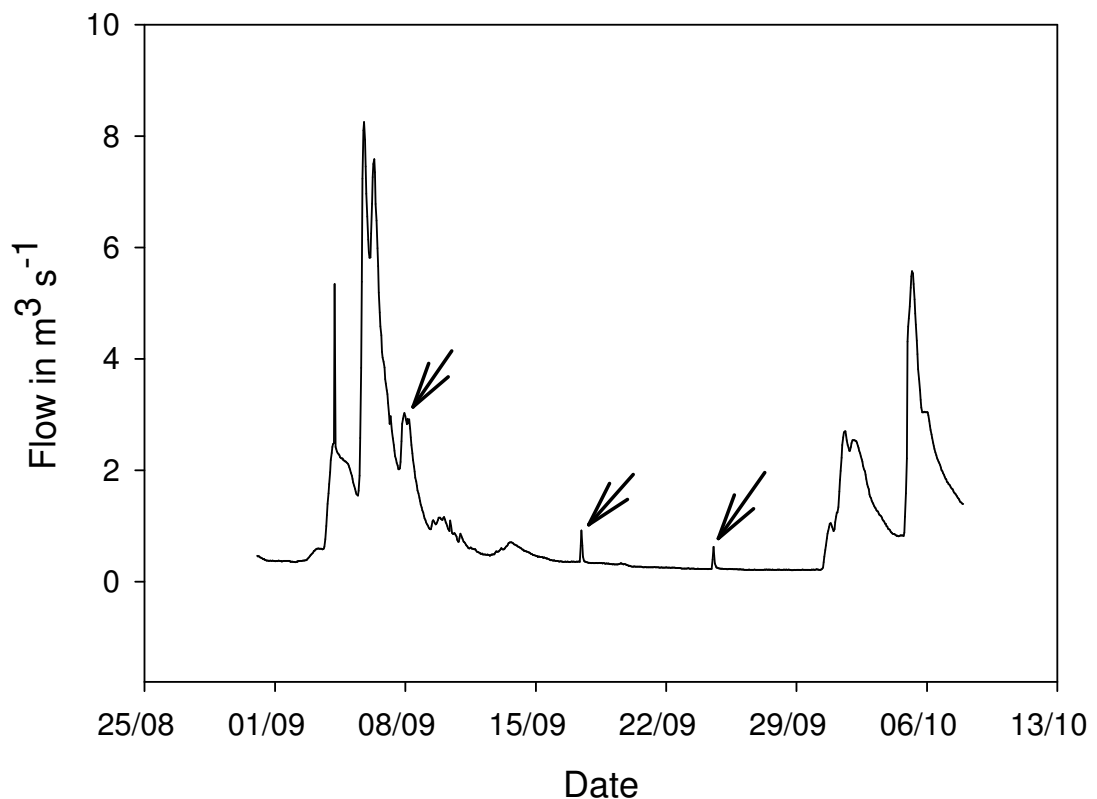

Figure 15: hydrograph from High Greenwood Gauging Weir, Autumn 2008, scour releases (Greenshank 10/09/08, Wagtail Lower 17/09/08, Whinchat 24/09/08) are marked with arrows – note magnitude compared to earlier and later natural rainfall events

Although the scour releases from Wagtail Lower and Whinchat reservoirs can be clearly seen in Figure 15, the effects of the Greenshank scour are hidden by a peak associated with a natural spate event in September 2008. The spates in early September and early October

both dwarfed the scour releases in terms of magnitude and longevity, and grew in magnitude at a similar rate as the reservoirs began to overspill following the heavy rains. The data for the above hydrograph from site 4, between 4 km and 6 km from the Catchment 1 reservoirs, was recorded hourly. If the same hydrograph is plotted using daily average flow data the effects of the scour releases cannot be picked out this far downstream. Similarly, a hydrograph for the output from Whinchat reservoir (from which the greatest discharge was achieved) for the whole of the monitoring period (Figure 16) shows that the scour release was dwarfed by the over-spilling events during the floods.

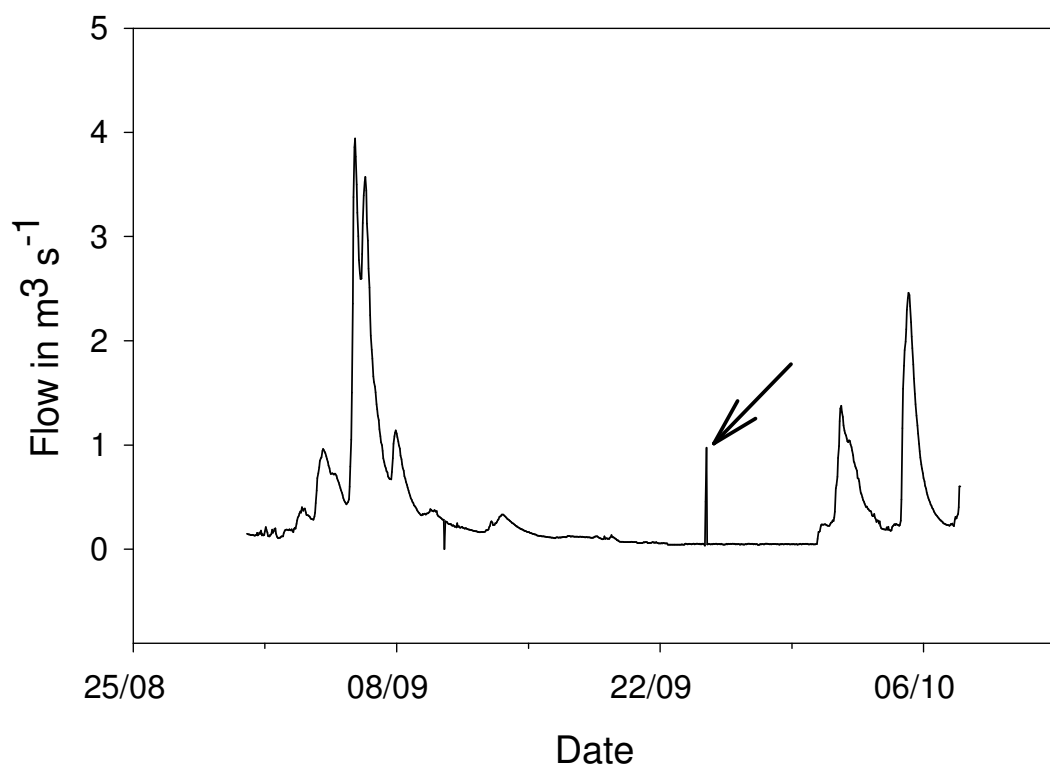

Figure 16: hydrograph for the output from Whinchat reservoir, Autumn 2008. Scour release indicated by arrow

Rates of change of flow

Table 15 below shows the beginning and maximum flow measurements and rates of change for the Greenshank and Whinchat scour releases, and also for the period of the September 2008 flood at which change was most rapid.

Table 15: rates of flow change for scour releases and a major flood in study period 1. * Maximum rates of change were attained from the steepest part of the hydrograph.

Flow event	Start point $\text{m}^3 \text{S}^{-1}$	Maximum discharge $\text{m}^3 \text{S}^{-1}$	Time elapsed in hours	Maximum rate of change in $\text{m}^3 \text{S}^{-1}$ per minute*	Rate of change as a percentage of starting flow per minute
Greenshank Scour	221.4	600.2	0.25	25.3	11.4
Whinchat Scour	55.0	1142.9	0.5	36.3	65.9
Flood at High Greenwood Weir	906.9	2070.2	1	19.4	2.1

The data show that despite the massive overall change in magnitude of flow during the September 2008 flood, the rate of change at the point at which the flood was rising fastest was exceeded by the rate of change during both the Greenshank and Whinchat scour releases.

Physiochemical changes and suspended sediment

Unfortunately due to the time taken to reconstruct the damaged PIT tag detection sites and prepare for the invertebrate sampling following the flood at the beginning of September 2008, it was not possible to collect either the physiochemical or suspended sediment data. However, data was taken for this catchment in both the preliminary trials described above, and also in study period 2, described below.

4.3.3 Scour releases, Catchment 1 Spring 2009

Flow

For Spring 2009 the greatest discharge and magnitude of change of flow were seen at Whinchat, and the twin peaks were visible at Whinchat and Wagtail Lower (Figure 17).

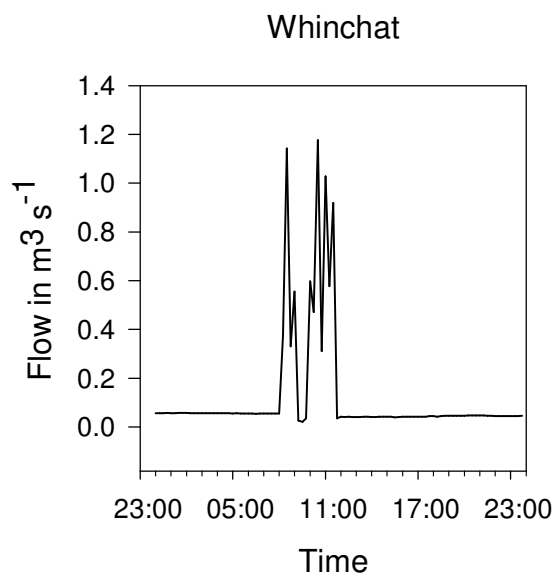
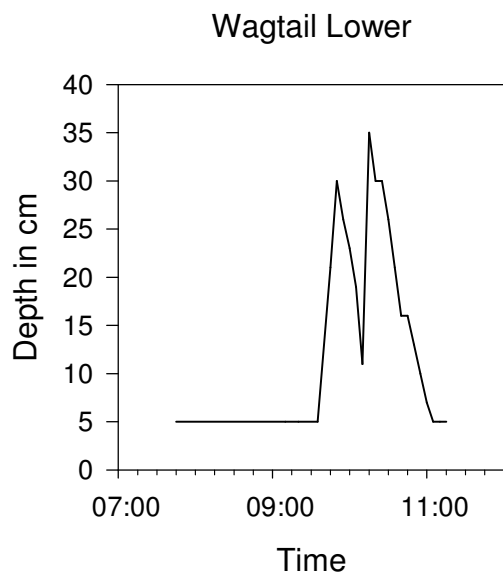
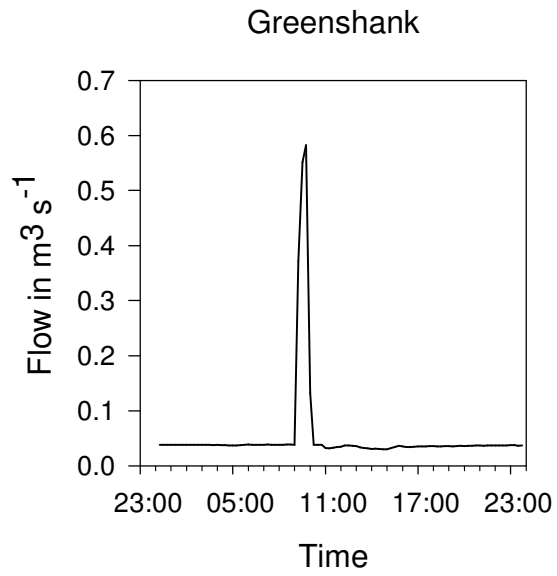

Figure 17: scour release flows in Catchment 2, Spring 2009

The hydrograph from below site 4 (Figure 18) shows that the Spring 2009 monitoring period was much less flood rich, although high flows were seen from early May. Even in this lower-flow period, the magnitude of the scours was regularly exceeded by natural variations in flow.

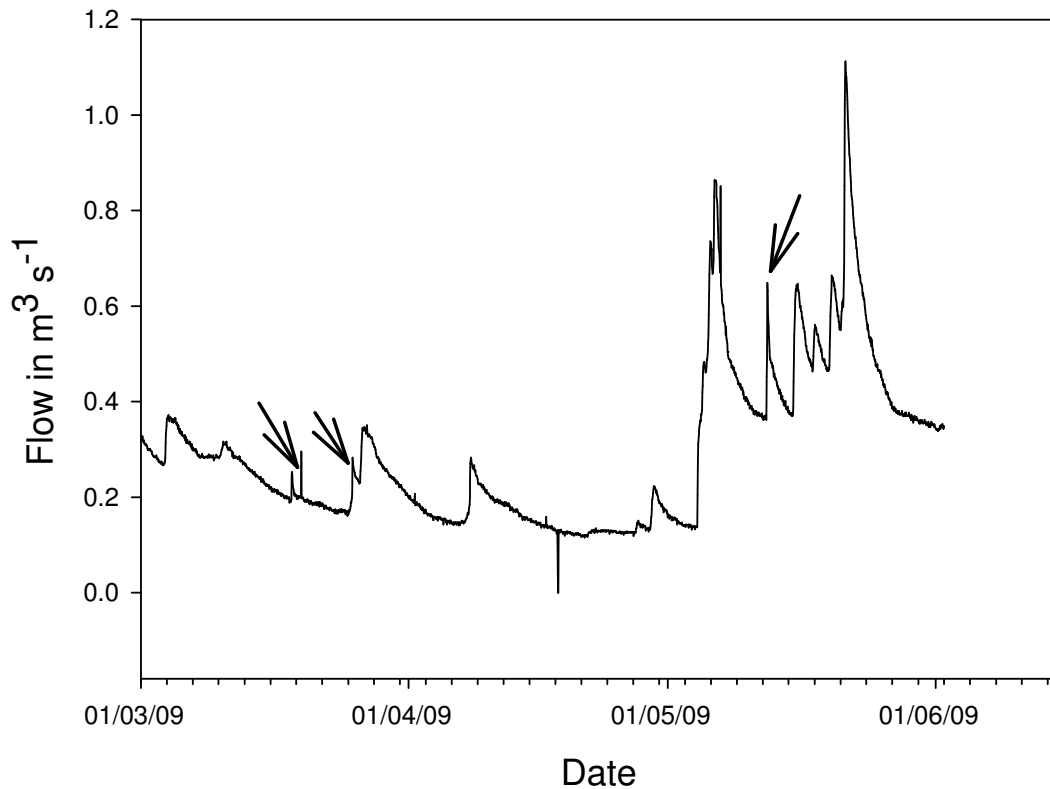

Figure 18: hydrograph from High Greenwood Gauging Weir (d/s site 4), Spring 2009, scour releases (Greenshank 18/03/09, Wagtail Lower 25/03/09, Whinchat 12/05/09) are marked with arrows

Despite the relatively small impact at the downstream gauging weir, Figure 19 below shows the scour release dwarfed all the overspilling events, providing a relatively large flow event downstream of the release source.

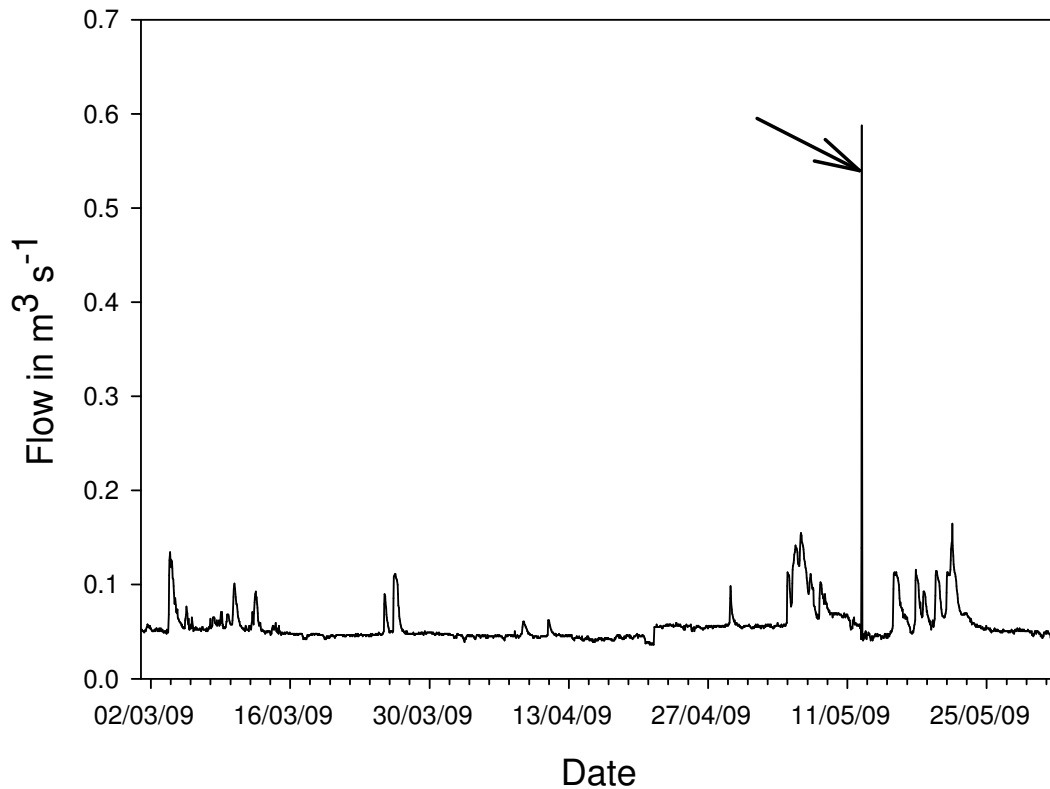

Figure 19: hydrograph for the output from Whinchat reservoir, Spring 2009. Scour release indicated by arrow

Rates of change of flow

The rates of change for the Spring 2009 scour releases from Whinchat and Greenshank reservoirs appear in Table 16, along with the data from the Autumn 2008 flood for comparison. The Whinchat rate of change was similar to that in study period 1; however the rate of change at Greenshank was much higher than in the Autumn, rising from 11% to 58% due to the much drier antecedent conditions and therefore lower base-flows.

Table 16: rates of flow change for scour releases in Spring 2009.

Flow event	Start point m^3s^{-1}	Maximum discharge m^3s^{-1}	Time elapsed in hours	Rate of change in m^3s^{-1} per minute	Rate of change in percentage of starting flow per minute
Greenshank scour	38.2	372.2	0.25	22.3	58.3
Whinchat scour	36.2	1176.2	0.75	25.3	70.0
Flood at High Greenwood Weir Autumn 2008	906.9	2070.2	1	19.4	2.1

Physiochemical changes

Temperatures showed a general upward trend as the day progressed, probably unassociated with the reservoir releases. The rapid drop and subsequent rise in temperature at Wagtail was caused by the probe being washed out of the water during the release wave, before being replaced (Figure 20).

As in the pilot studies, pH probes were slow to adjust to ambient conditions, explaining the rapid fall at Greenshank and rise at Whinchat in the first few minutes of monitoring (Figure 20). The subsequent fluctuations in pH at all sites are difficult to link to the reservoir releases (as pre and post releases values also fluctuate) and were probably associated with the equipment or varying levels caused by turbulence around the probe.

The streams below Greenshank and Wagtail reservoirs remained super-saturated with oxygen throughout the day of release. Oxygen levels were lower below Whinchat reservoir, beginning at just above 81% and increasing slowly as the day continued, but seemingly unaffected by the release.

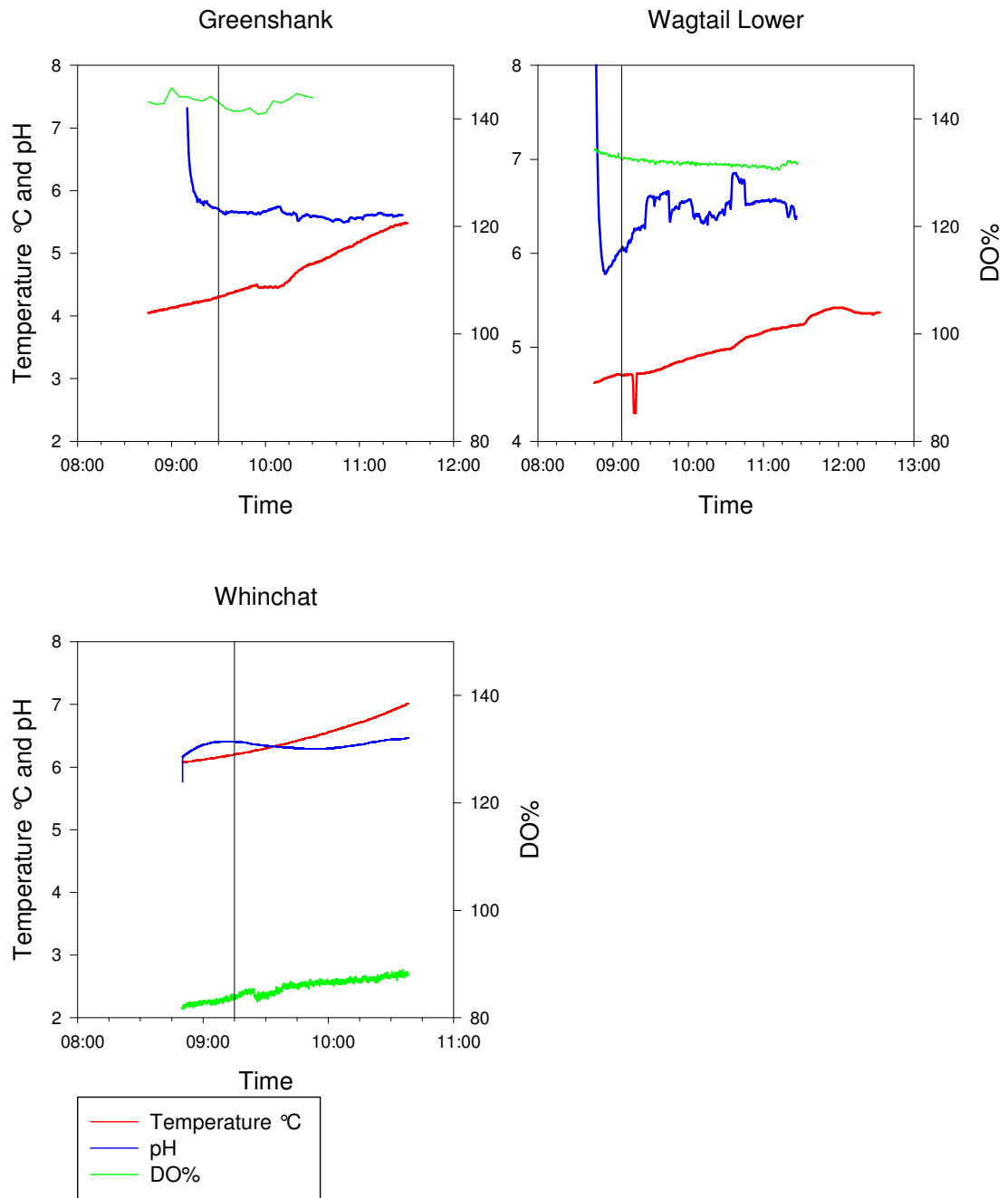

Figure 20: water quality changes during Spring 2009 scour releases, Catchment 1. Vertical lines indicate time of valve openings

Temperature loggers

Figure 21 shows the data from the temperature loggers at sites 1 to 4 (Figure 10) during the May 2009 scour monitoring periods in Catchment 1. The arrows highlighting the timing of the scour releases show no change to the normal pattern of daily variation on release days.

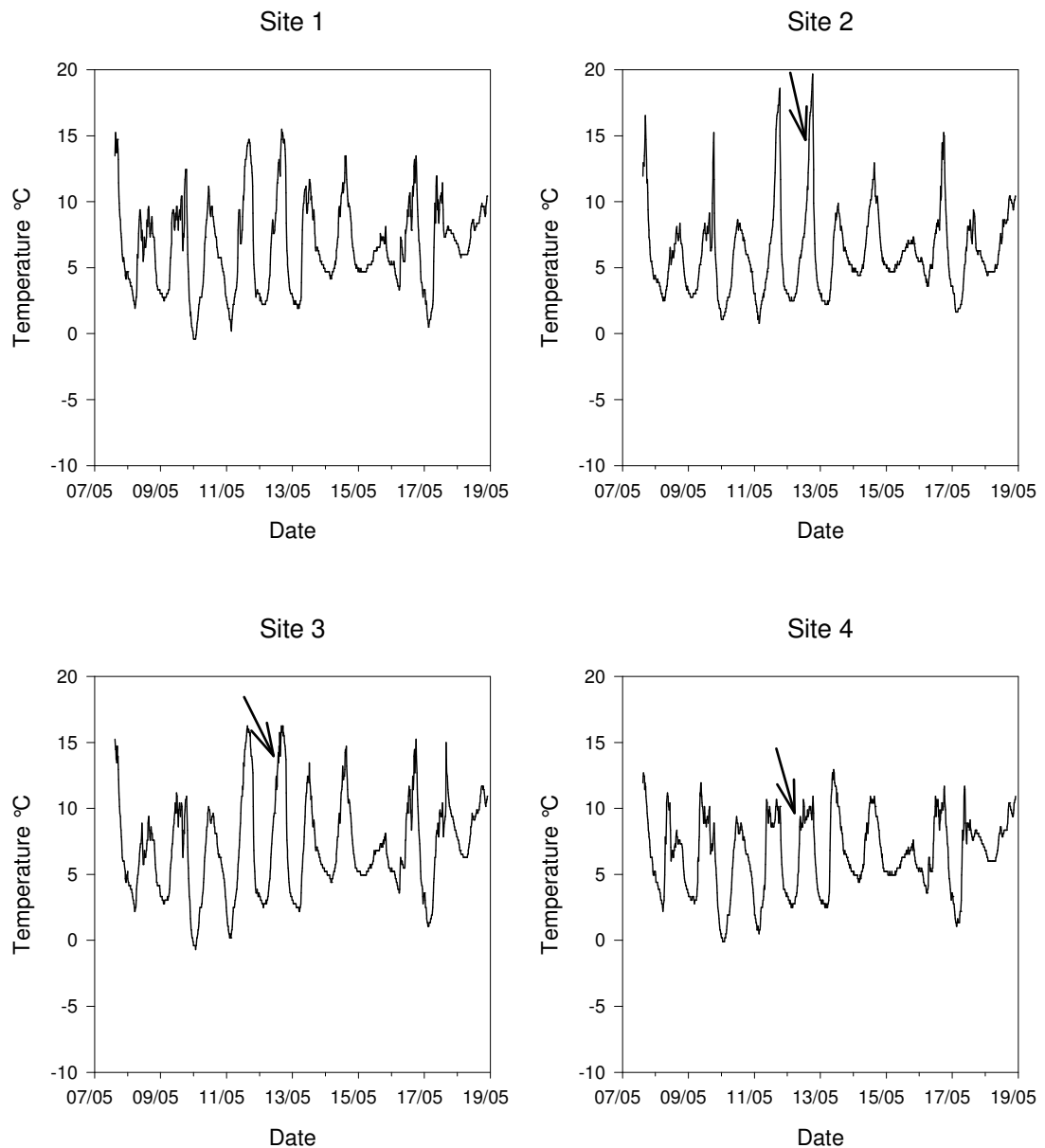

Figure 21: water temperature logger recordings for May 2009, Catchment 1. Scour release indicated by arrows. (No release at site 1 in this period)

Table 17 shows the water temperature ranges and means at each of the sites during these periods. Although there appears to be a considerable range in the temperatures recorded, the data from the different probes are consistent, with water temperatures averaging between 6.1 °C and 7.0 °C in the May period. The ranges recorded by the YSI probes during the scour releases are well within the typical daily ranges seen here. Loggers recorded accurately in a temperature controlled room in the 15 °C to 20 °C range before and after deployment, although occasional readings between 0°C and -1°C show field readings were not perfectly accurate. There does not appear to have been any warming

effect associated with distance downstream, with site 3, the intermediate site, being the warmest in the monitoring period (although only marginally), and Site 1, below Whinchat reservoir was the coldest, again only by a slender margin.

Table 17: temperature statistics for Catchment 1, May 2009. Sites illustrated in Figure 10.

Site	Period	Mean Temp °C	Standard Deviation	Range
1	May 2009	6.6	3.3	-0.4 to 15.5
2	May 2009	6.1	3.2	0.8 to 19.7
3	May 2009	7.0	3.6	-0.7 to 16.3
4	May 2009	6.5	2.8	-0.1 to 12.9

Suspended sediment

The graphs below show the changes to suspended sediment concentrations during the Spring 2009 scour releases in Catchment 1. The automatic sampler situated by the stilling basin below Whinchat reservoir ceased to function shortly after the valve was opened. This malfunction was possibly due to high volumes of sediment blocking the unprotected sample pipe. It is not known whether the peak seen in the data shortly after 0900 was recorded before or after the valve was opened, so unfortunately no inferences can be made from the data at the reservoir outflow. The peak at the downstream Whinchat site, in excess of 200 mg/l is greater than any of the values recorded being released from any of the study reservoirs, and is only matched by the concentrations downstream of Dipper reservoir in Autumn 2009. The values from Greenshank were low, probably as the nearest safe location to the release site to take samples was in fact 600 m downstream, and below a confluence. An increase in sediment load is still seen shortly after the scour valve opens, quickly followed by a return to pre-release levels. At Wagtail reservoir, two peaks in sediment concentration, probably associated with the opening of the two valves, can be seen. At Wagtail the upstream site was below a spillway and two sediment traps, perhaps preventing the peaks seen below Whinchat reservoir, however, concentrations still approach 50 mg/l at the upstream site, and rise slightly higher at the downstream site.

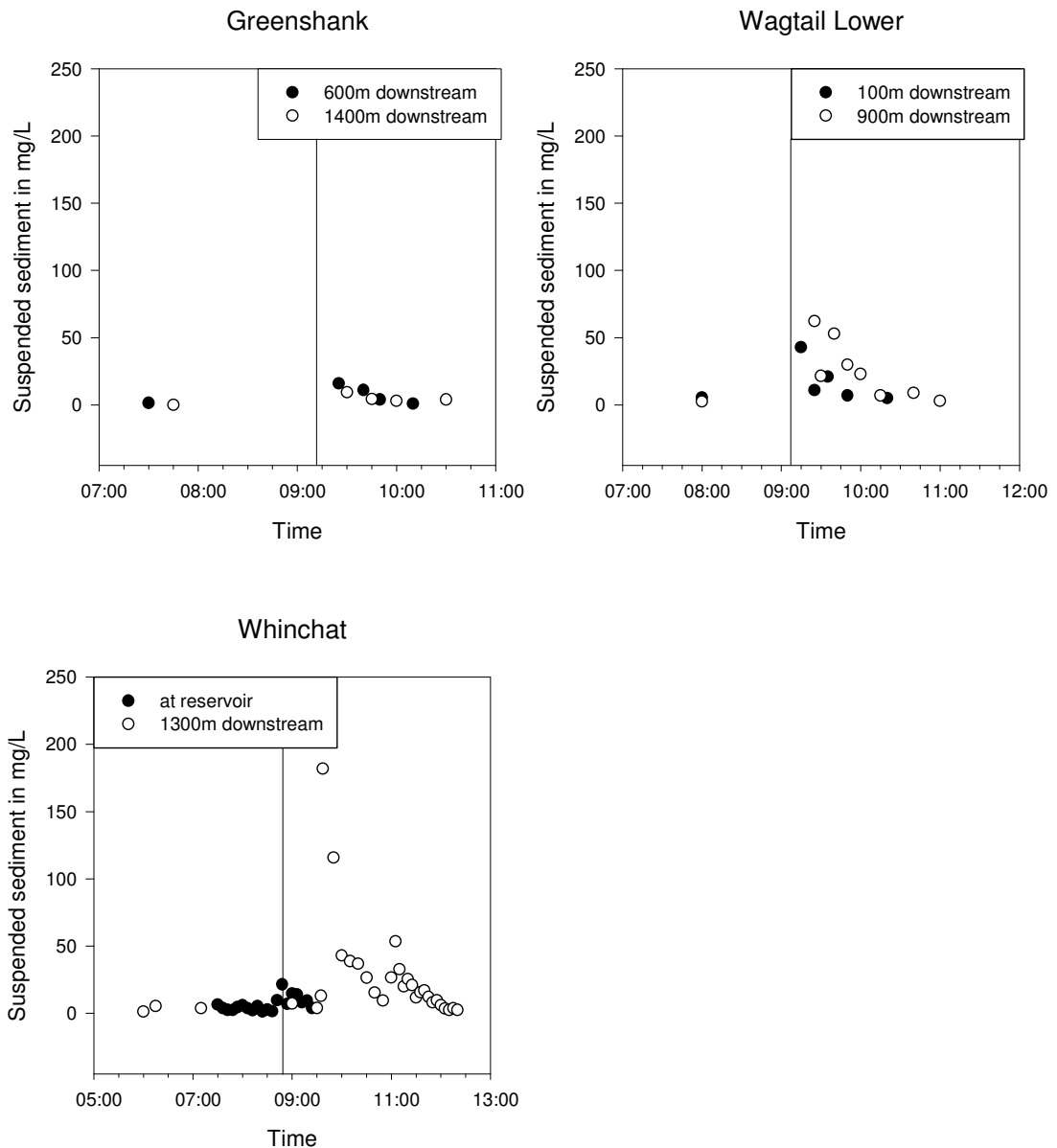

Figure 22: suspended sediment concentrations during Spring 2009 scour releases, Catchment 1. Vertical lines indicate valve opening times

4.3.4 Scour and spate releases, Catchment 2, Autumn 2009

Flow

Scour and spate releases from Dipper reservoir were the largest achieved from any of the trial reservoirs (Figure 23). The spate release failed to reach the target discharge of $5.4 \text{ m}^3 \text{ s}^{-1}$ due to depleted reservoir stocks providing insufficient head. A discharge of $4.3 \text{ m}^3 \text{ s}^{-1}$ was achieved. The stepped design of the release did not go entirely to plan, as the engineers misread the step down from maximum discharge to $1.9 \text{ m}^3 \text{ s}^{-1}$ by a power of 10, producing a discharge of $0.19 \text{ m}^3 \text{ s}^{-1}$. This mistake was rectified approximately half

way through the hour, and flows returned to closer to the original target. The releases at Blackbird achieved a maximum discharge of $0.79 \text{ m}^3 \text{ s}^{-1}$ due to the smaller release valve.

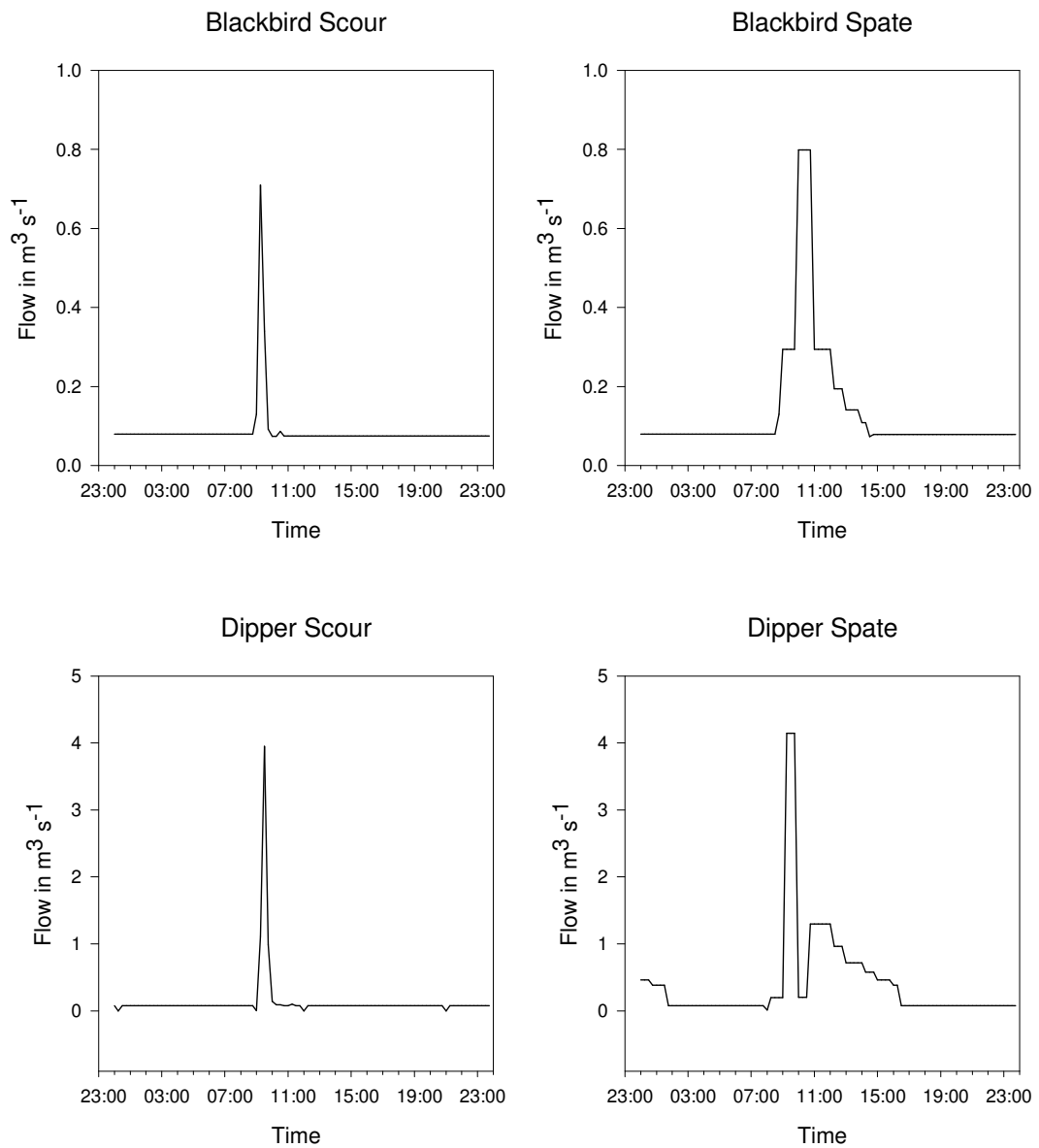

Figure 23: scour and spate hydrographs from Blackbird and Dipper reservoirs, Catchment 2, Autumn 2009

The hydrograph for the whole of 2009 (Figure 24) shows the Dipper spate to have been by far the largest flow event of the year, completely dwarfing the natural flow events. However, examination of the hydrograph for the past three years (Figure 25) shows that the spate release was directly comparable in magnitude to the large floods seen in 2007 and 2008.

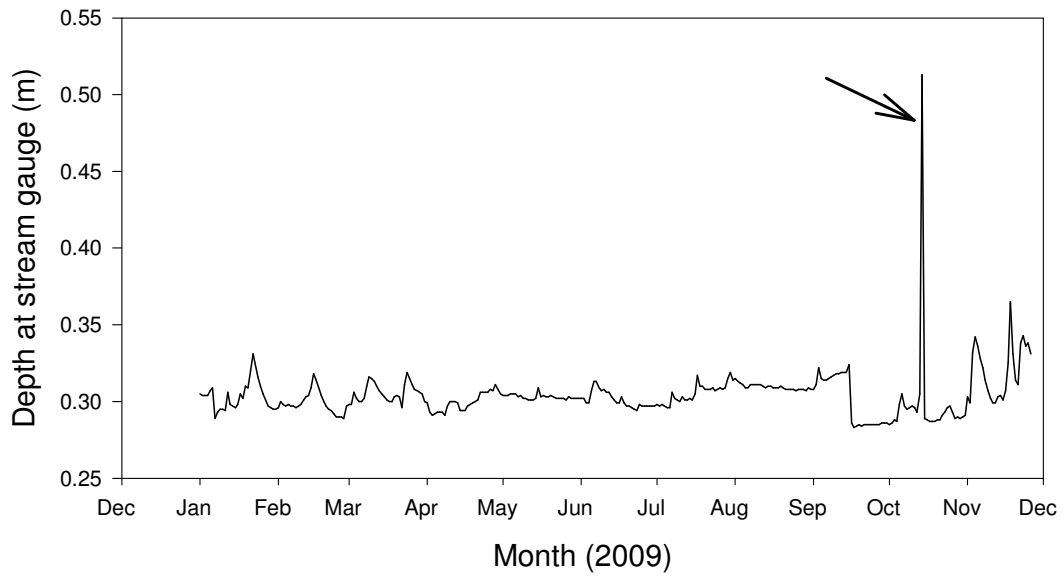

Figure 24: hydrograph for 2009 from Dipper Stream gauge, 1km below reservoir. Spate release indicated by arrow

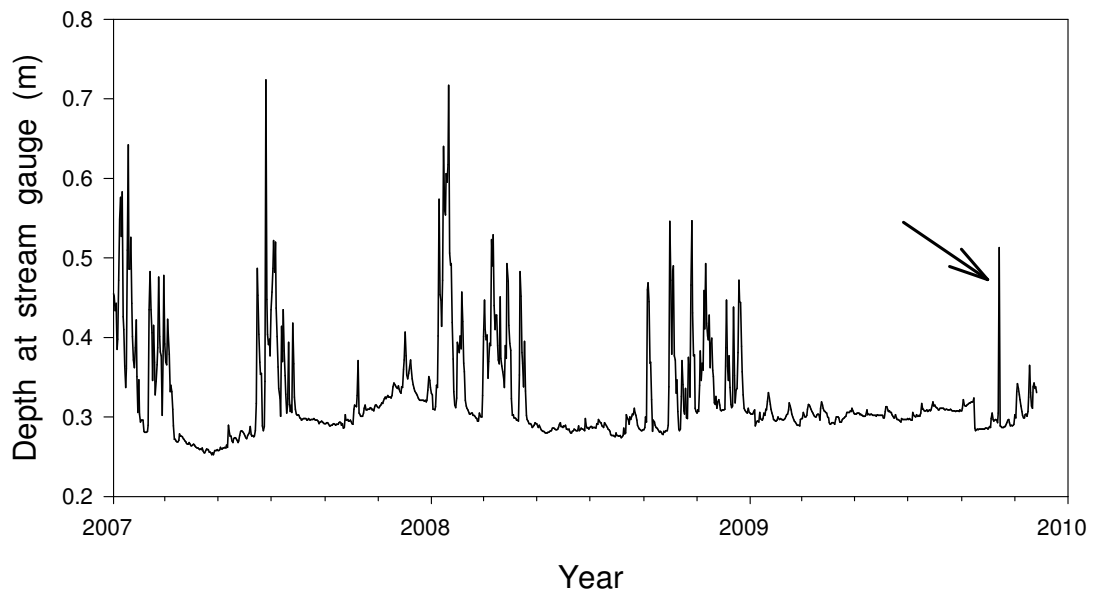

Figure 25: three year hydrograph from Dipper stream gauge. 2009 spate releases indicated by arrow.

Rates of change of flow

Table 18 shows the rates of change of flow for the scour and spate releases from Dipper reservoir along with the Autumn 2008 Catchment 1 flood for comparison. It is difficult to compare release data with flood data in Catchment 2 as stream discharge is recorded daily in the form of river stage, as opposed to the flow data recorded every 15 minutes in tcmd

from the reservoir. The releases from Dipper reservoir exceed both the Catchment 1 releases and the natural flood in terms of rate of change of discharge due to the greater release capacity through the Dipper scour valve.

Table 18: rates of flow change for scour releases in study period 3.

Flow event	Start point m³s⁻¹	Maximum discharge m³s⁻¹	Time elapsed in hours	Rate of change in m³s⁻¹ per minute	Rate of change in percentage of starting flow per minute
Dipper Scour	75.9	4143	0.25	271.2	357
Dipper Spate	75.9	1980	0.25	127.0	167
Flood at High Greenwood Weir Autumn 2008	906.9	2070	1	19.4	2.1

Physiochemical changes

During the Autumn 2009 scour and spate releases temperature remained largely unchanged during all four releases, despite a minor upward fluctuation at the start of the Blackbird scour and spate releases and the Dipper spate, but remained within one degree of the starting temperature all through each of the release days (Figure 26). pH fluctuated slightly more, dropping by 0.2 to 0.5 of a unit at the beginning of both the Dipper releases, but again remains relatively constant throughout each of the release days. Dissolved oxygen levels fluctuated, and were noticeably lower than at any of the pilot or Catchment 1 reservoirs. DO dropped noticeably during the scour release at Blackbird reservoir, falling from a pre-release average of approximately 56 % to a post release average of approximately 46 %, and fluctuating markedly during the other releases.

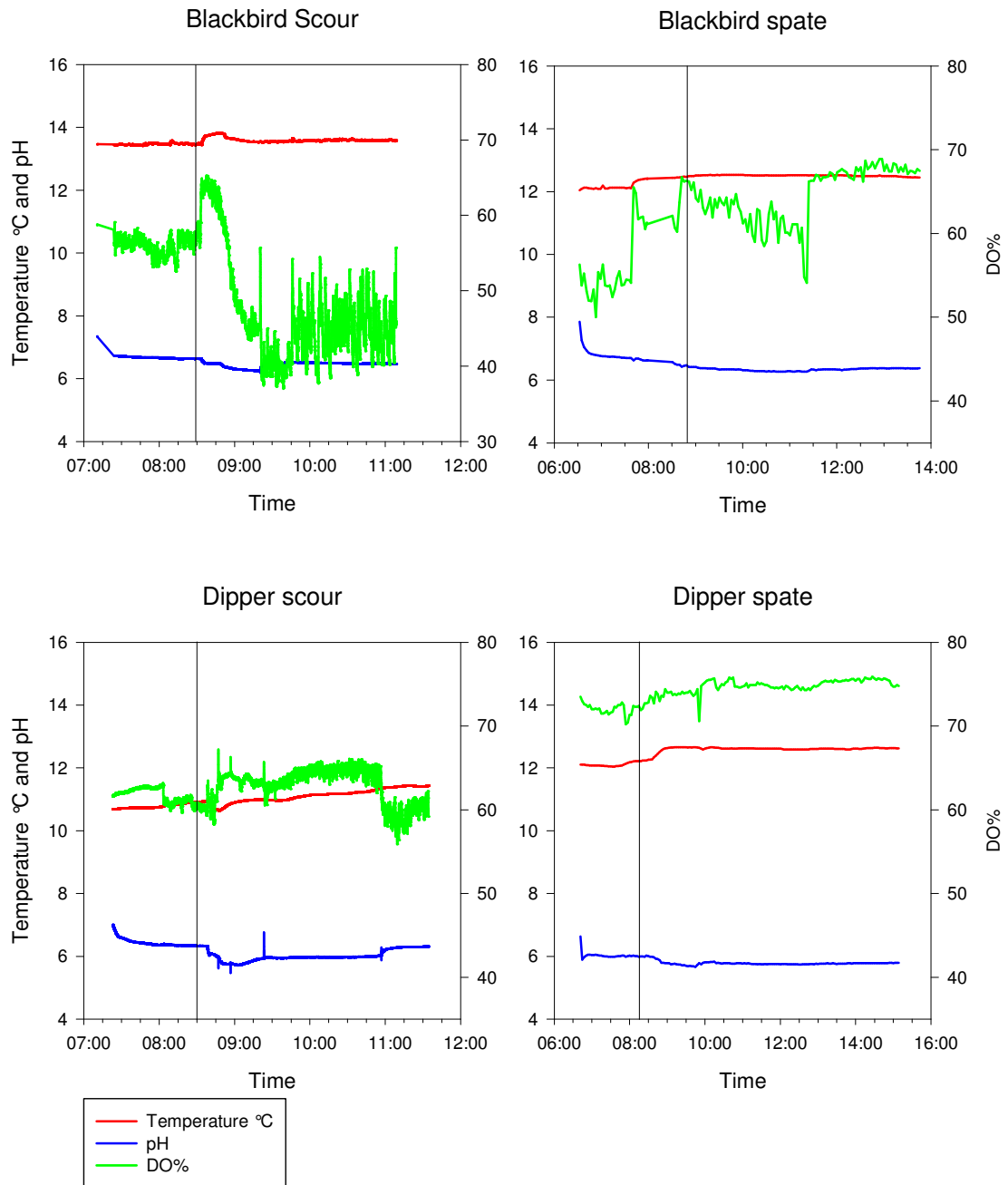

Figure 26: water quality changes during Autumn 2009 scour and spate releases, Catchment 2. Vertical lines indicate times of valve openings.

Temperature loggers

Figure 27 below shows the data from the temperature loggers at sites 5 to 7 (Figure 11) during the Autumn 2009 scour and spate monitoring period in Catchment 2. The arrows highlight the timing of the scour releases. No change to the normal pattern of daily variation on release days was detected.

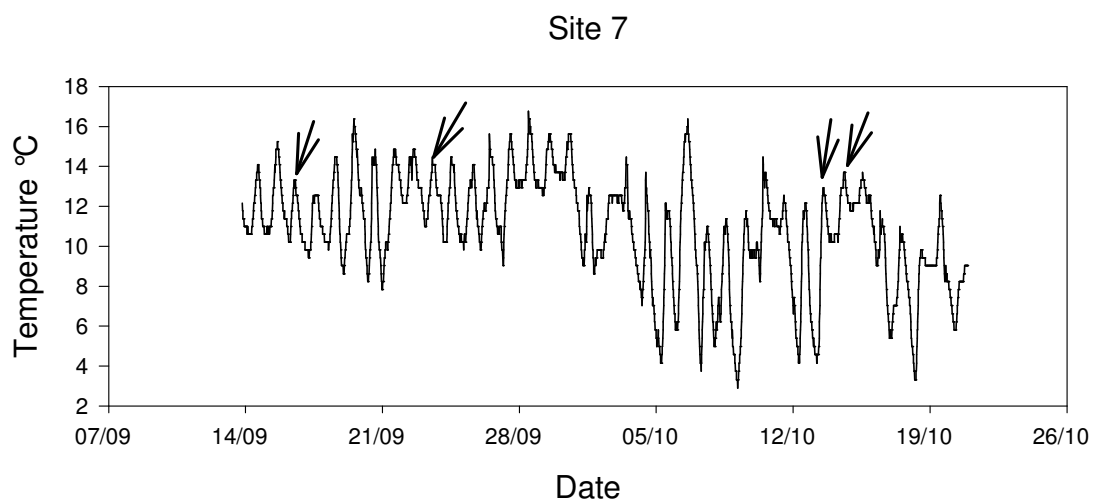
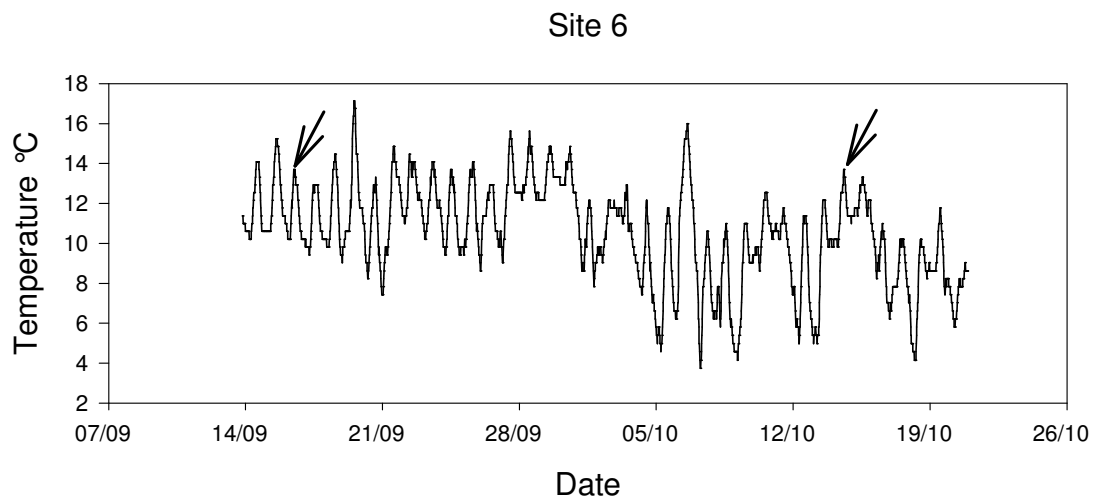
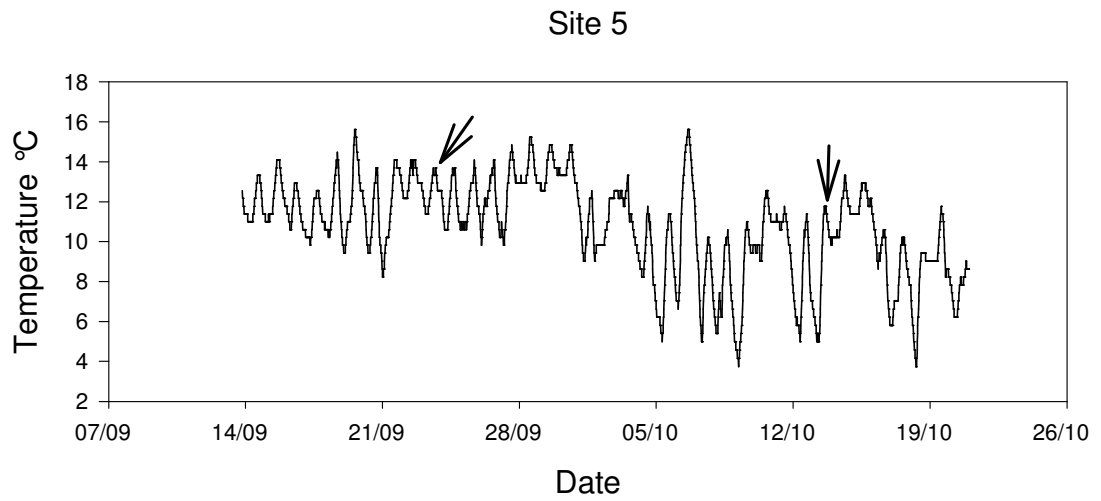

Figure 27: water temperature logger recordings for Autumn 2009, Catchment 2. Scour and spate release indicated by arrows.

Table 19 shows the ranges and means at each of the sites during these periods.

Table 19: temperature statistics for Catchment 2, Autumn 2009

Site	Period	Mean Temp °C	Standard Deviation	Range
5	Autumn 2009	10.8	2.4	3.7 to 15.6
6	Autumn 2009	10.6	2.4	3.7 to 17.1
7	Autumn 2009	10.9	2.7	2.9 to 16.8

The temperatures recorded in the densely shaded Catchment 2 showed less variation than those recorded in the unshaded Catchment 1, as expected. Mean temperature increases marginally with distance downstream, although the effect is so small as to be negligible.

Suspended sediment

The sediment results for the Autumn 2009 releases appear in Figure 28. Each release showed a clear peak in suspended sediment concentration associated with the opening of the valve, followed quickly by a return to pre-release levels. It is noticeable that the peaks were highest at the sites downstream of the reservoirs during each of the four releases, as opposed to the sites at the reservoir outflows, and also that at both these reservoirs the levels were much higher during the scour releases than the spate releases. The peak concentration during the Dipper scour release was particularly high, exceeding 500 mg/l.

Samples taken from the reservoir overflows at Dipper and Blackbird reservoirs showed that the water entering the streams carried sediment concentrations of 1.6 (Dipper) and 1.7 (Blackbird) mg/l, comparable with the levels seen in the compensation flows before and after the reservoir releases.

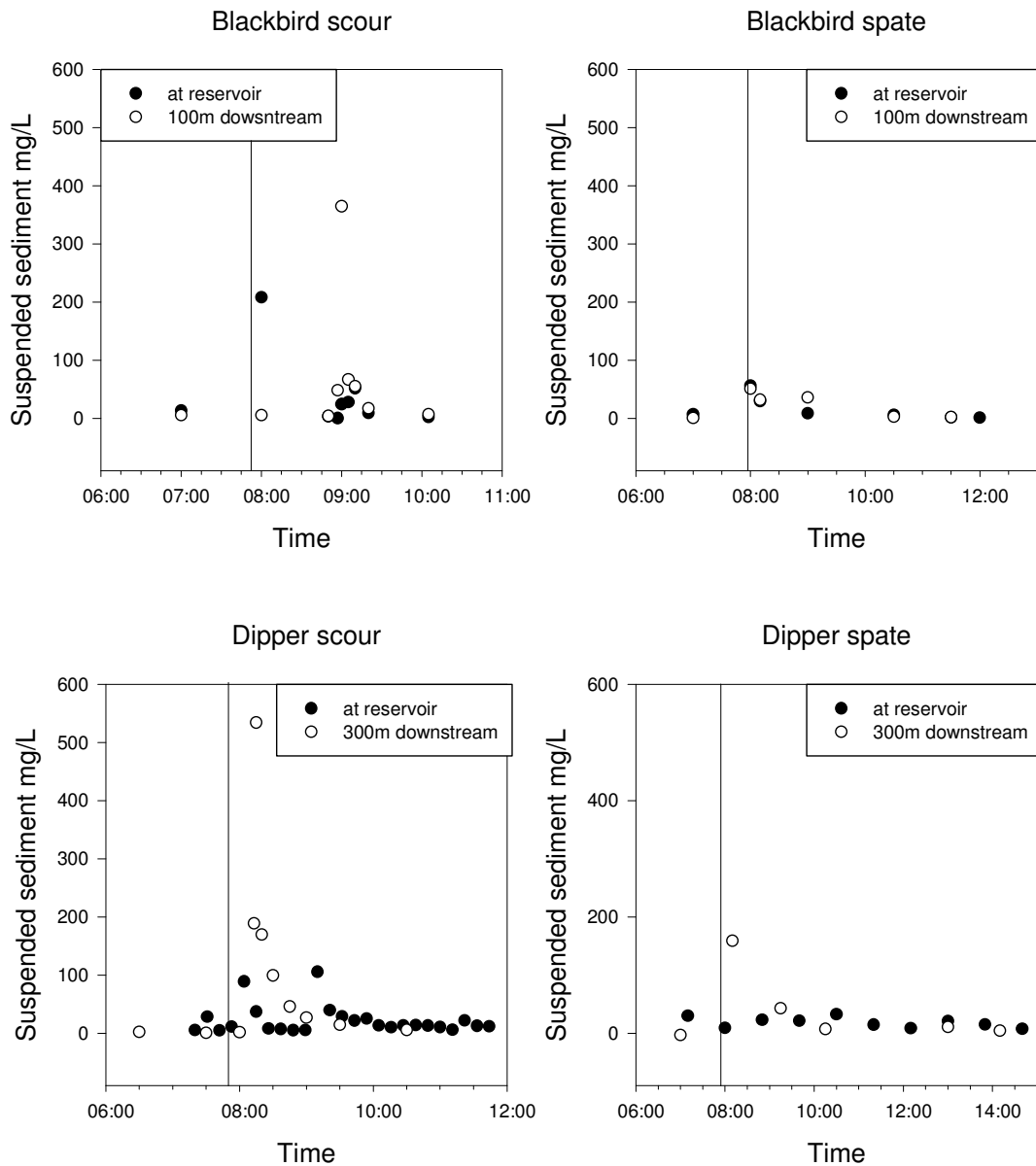

Figure 28: suspended sediment concentrations during Autumn 2009 scour and spate releases, Catchment 2. Vertical lines indicate valve opening times.

Fine sediment and algal cover

Visual recording showed reductions of up to 75% in the percentage cover of algae and fine sediment on the gravel beds for up to 2 km downstream of Dipper and Blackbird reservoirs after scour and spate releases (Table 20 below). As may be expected, the scour releases had the greater effect, as they preceded the spate releases and hence more sediment was available to shift.

Table 20: Reduction in cover of algae and fine sediment following scour and spate releases in Catchment 2, Autumn 2009

Reservoir	Release type	Distance from reservoir (m)	Cover before release	Cover after release	Percentage reduction
Blackbird	Scour	100	80	20	60
Blackbird	Scour	2000	70	70	0
Blackbird	Spate	100	35	30	5
Blackbird	Spate	2000	60	60	0
Dipper	Scour	300	95	20	75
Dipper	Scour	2000	70	40	30
Dipper	Spate	300	30	15	15
Dipper	Spate	2000	60	30	30

Gravel bed sediment content

The results from the scour release at Dipper reservoir showed an increase in bed fine sediment immediately below the reservoir followed by a consistent reduction at the other downstream sites, while the spate results showed no clear pattern (Figure 29). The bed contents prior to the spate are similar to those found following the scour release.

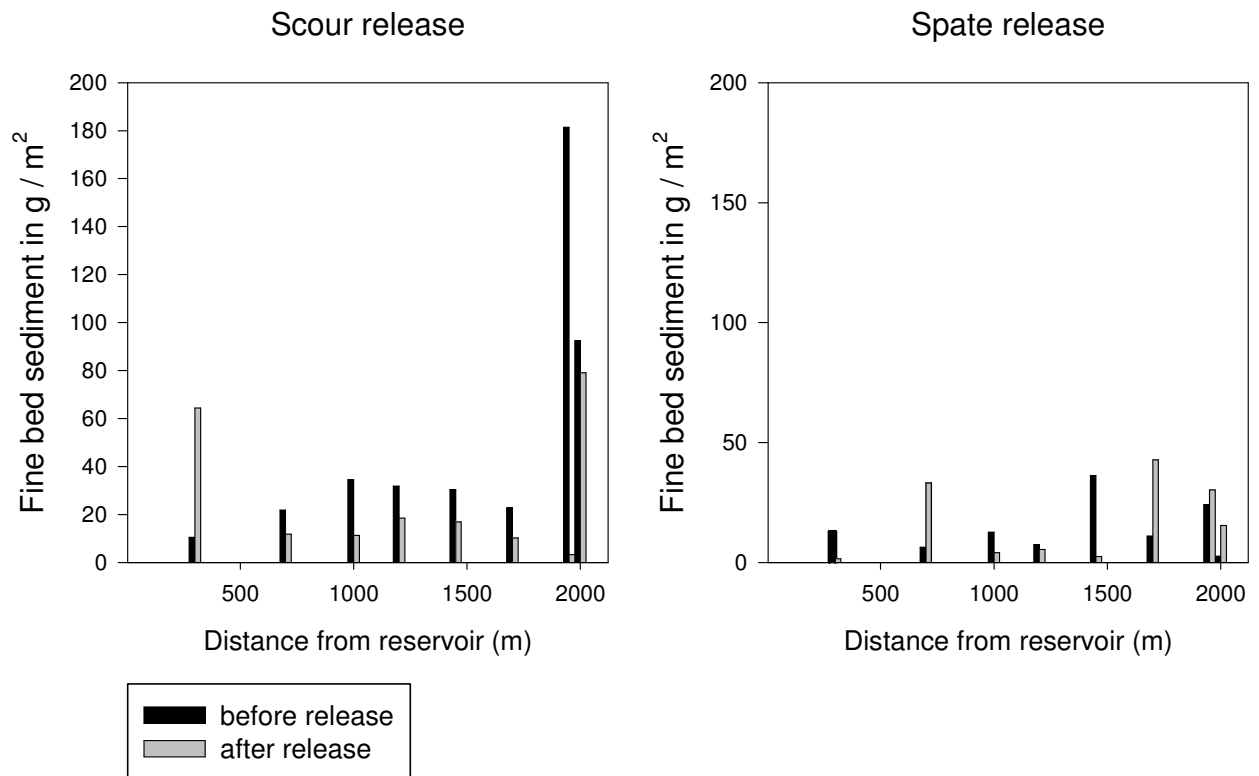

Figure 29: fine sediment entrained in river bed before and after scour and spate releases from Dipper reservoir

4.4 Discussion

The data clearly show that short duration reservoir releases from small reservoirs can have effects on flow, sediment transport and water physio-chemistry in the receiving water-bodies. The most dramatic changes are those to the quantity of water passing down the streams, and the rates at which the flows increase and decrease. Theoretically, this could present a threat to the biota, as the sudden increase followed by the equally rapid decrease could cause washout and stranding of both fish and invertebrates as described in Chapter 1. However, when the study reservoir release data are compared to the flood hydrographs it can be seen that the releases do not usually approach the magnitude of floods (although in Catchment 2 the Dipper reservoir spate release was of similar magnitude if not duration to high flow episodes seen in 2007 and 2008) so the quantity of water entering the streams should not pose a threat in itself. However, the rate of change of flow during the reservoir releases far exceeds the rate of change seen in the floods recorded in Catchment 1, and may be greater than that to which the biota are capable of responding.

As the hydrographs for the study catchments show, these streams are naturally very flashy and spates do rise very quickly as the reservoirs begin to overflow. As the reservoirs have been operational for several decades and the overflowing events and reservoir releases have been continuous since their construction the biota must have adapted to live with these events, even if a proportion of the population is lost during each natural spate or release. Perhaps more importantly, these upland millstone grit catchments are naturally very flashy (as are many brown trout nursery streams in upland catchments), and the floods are a necessary part of the life-cycle of biota, for which they are well adapted. As events greater in magnitude than the reservoir releases usually occur through overflowing and natural flooding several times each year, it is unlikely that the changes in flow alone would cause significant ecological damage, and that the resident communities would be well adapted to resist and recover from such events. The ability of the biota to withstand these events will be explored in the coming chapters.

Although the releases may appear harmless in terms of changes to volume of discharge alone, it could be that the accompanying changes to water chemistry coupled with the very rapid flow changes may be damaging. Both the initial exploratory data and the data recorded in the release periods in catchments 1 and 2 show that water quality does change

during the releases. Although the physiochemical changes vary from reservoir to reservoir (probably dependent on factors such as depth, water retention time, time of year and catchment characteristics), water temperature, pH and oxygen content each clearly fall at several reservoirs when the release valves are opened. Although these decreases are clear they are minimal, and spatially and temporally limited. Temperature during releases very rarely fell by more than 1°C and never by more than 2 °C, and always remained within the daily ranges recorded by the temperature loggers and those suggested in Solbé (1997) as agreeable to salmonids (and therefore the other creatures that typically inhabit the same streams). No change to water temperature was recorded further than 1800 m downstream of a reservoir. As the changes are minimal, short lived and well within the tolerance ranges of the resident communities, it is unlikely that they will be ecologically damaging.

The effect of short-term water releases from the study reservoirs on dissolved oxygen are less clear than those on temperature due to the greater variability in the recordings. Fluctuations were seen during almost all the reservoir releases, and most sites show a gradual decrease as the day progresses, probably linked to the naturally increasing water temperature. Dips in DO levels can be seen below a few of the reservoirs at the time the valves open. Conversely peaks in DO were recorded at both Dabchick and Greenshank. The peaks and dips were only recorded up to a few hundred metres downstream. It appears that oxygen-poor water may be being released from the reservoir, however the mechanism of release (high pressure through a pipe followed by release into the air above the stilling pool rather than directly into the water) coupled with the high velocity and the turbulence caused by the bouldery, high gradient beds (Chapter 7) allows almost immediate re-oxygenation (Bott 1996, Mulholland et al. 2005).

It is noticeable that dissolved oxygen levels were generally lower in Catchment 2, where the gradients are lower, flow less broken and average velocities lower than those seen in Catchment 1. Critically for the ecology of the streams, the DO levels in Catchment 1 remained very high throughout the release days, not falling below 100%. In Catchment 2 the pre-release saturation levels varied between 55 % and 80 %, slightly above the EIFAC recommended 50 percentile level, but clearly not low enough to prevent the trout populations persisting. During the Blackbird scour release, the recorded levels fell as low as 40%, not low enough to cause the fish mortality recorded in Elliott (2000) but low enough to distress salmonids and the more oxygen-hungry macroinvertebrates (Nagell

1973, Genkai-Kato et al. 2000, Connolly et al. 2004). However, as may be expected, the invertebrate fauna in Catchment 2 reflects the lower oxygen levels in the water (Section 4.3) and the residents are therefore less likely to suffer during a low-oxygen event.

The pH results varied from reservoir to reservoir, showing varying levels of fluctuation and impact from the release, with some reservoirs showing no changes during the monitoring period and others showing considerable variation through the course of the release days. Due to the sensitive nature of pH probes it may be that these differences were due to positioning of the probe in the water – although the probes remained submerged during the releases it may be that those in more turbulent positions recorded greater fluctuation due to buffeting and intrusion of air bubbles. It is noticeable that the less turbulent Catchment 2 provided steadier pH readings. As would be expected, the pre-release pH reading varied, mostly registering just below neutral, and despite the variation seen in the results, changes rarely exceeded 1 unit. Although the levels were often below the 7 to 9 EIFAC recommendations, they were consistently within those recorded by Solbé as suitable for trout, and natural for sandstone moorland catchments. The slight variations in pH may have knock-on effects on the quantities of various toxins soluble in the water, but as the changes in pH were limited these effects are unlikely to be particularly harmful.

The lack of substantial variation in the water physio-chemistry is perhaps not surprising, given that the release water usually comes from the same source as the compensation water which accounts for a high proportion of the streams' usual inputs. However, as reservoir discharge increases, the percentage of reservoir-sourced water will increase in comparison to water gathered through run-off and ground-water input, so any negative properties associated with the reservoir water would be expected to be enhanced as dilution decreases.

The suspended sediment results show that sediment levels carried by the water clearly increase below the reservoir during a valve release, although as with the other physio-chemical effects, the changes are spatially limited, diminishing as the power of the wave decreases with increasing distance from the source. The results from Catchments 1 and 2, where the upstream and downstream sites were closer than in the initial exploratory surveys suggest that rather than the sediment coming out of the reservoir as was suspected, the majority of it is picked up from the river bed immediately downstream of the release

sites. This should have positive consequences for the potential impacts of a release, as if this sediment comes from the river bed as opposed to the reservoir bed it is less likely to contain the heavy metals and other toxins sometimes seen in reservoir sediments and less likely to contain large quantities of organic material with a high biological oxygen demand.

The low levels of sediment seen in the reservoir overspill water during the natural floods were to be expected, as the reservoir acts as a sediment trap for the waters flowing through it, and the majority of water in a flood event comes from surface overspill, rather than from deep in the reservoir. As there is less sediment input from the reservoir during a natural flood compared with a reservoir release, it is likely that the flood has the potential for a greater scouring effect downstream of the reservoir, although input from land run-off may compensate for the sediment removed.

The bed sediment and gravel-bed cover results from the scour release in Catchment 2 support these findings, showing a reduction in algal and fine sediment cover of gravel beds as well as a reduction in the amount of fine sediment entrained in the river bed for more than 2 km downstream. This is clearly beneficial for the macroinvertebrate communities living in the interstices in the gravel beds, as well as the trout who spawn there, allowing better oxygenation.

The results from the Dipper reservoir spate release showed no clear effect upon the bed sediment, probably due to antecedent conditions as described in Leeks and Newson (1989), in this case a spate release removing a significant proportion of the loose sediment. The stepped nature of the spate design should not affect the ability of the release to remove sediment, as the maximum discharge is equal to that of a scour and the duration longer.

4.5 Conclusions

The data show that the reservoir releases rarely match natural high flow events in terms of volume of water travelling down the streams, but greatly exceed the floods in terms of rate of change of flow, and it is the rate of change, rather than the level of discharge achieved that could pose a threat to the resident biota. The spate releases did not approach the natural high flow events in terms of duration, and are unlikely ever to become more than a single-day event due to the economic cost of the releases. Hypothesis 1, that releases

cause sufficiently large changes to the hydrology of the receiving streams to affect the resident biota for several kilometres downstream is unproven – in terms of water volume alone biota are unlikely to be affected, however the rate of change may be problematic. Impacts are likely to be limited to hundreds of metres, rather than kilometres, as release waves dissipate quickly.

The physiochemical data show that the water quality remains more constant than was expected, as the release water is generally from the same source as the compensation water. Small changes are seen, however, and both pH and dissolved oxygen levels drop towards the lower boundaries of fish and invertebrate tolerance ranges without crossing them. Whether or not these changes are great enough to have any ecological impact will be examined in the next chapters. Hypothesis 2, that releases cause changes to pH, temperature, dissolved oxygen and suspended sediment levels in the receiving stream is verified, although again the effects are less than anticipated and associated ecological impacts may be minimal. Hypothesis 4, that releases are capable of reducing the quantities of fine sediment or algae entrained in the river bed is also verified, providing the first evidence of a possible beneficial effect of the releases.

The variation in water quality and hydrology of the releases between the various reservoirs shows that it is difficult to predict the physical changes a release from a given reservoir may cause based on results from another reservoir, and although no obviously harmful effects were seen here it is certainly possible that releases from other reservoirs may have more serious consequences.

Chapter 5: Macroinvertebrate responses to reservoir releases

5.1 Introduction

This chapter examines the responses of the downstream benthic macroinvertebrate populations to the reservoir releases, analysing both quantitative and qualitative changes associated with the releases. Changes to the communities in the weeks following the releases are also assessed. This chapter examines whether the abundance or community structures of benthic macroinvertebrates are affected by reservoir releases, testing the hypotheses:

1. That flow releases from upland Yorkshire reservoirs decrease benthic macroinvertebrate abundances immediately downstream of the reservoirs.
2. That certain taxa are more vulnerable to displacement by such flows.
3. That scour releases will have a greater effect than spate releases at these sites due to the more rapid increase in discharge.
4. That any displacement effects on benthic macroinvertebrates will decrease as distance from the release site increases.

5.2 Methodology

5.2.1 Fieldwork timeline

As with the physical data presented in Chapter 4, the work described below was timetabled in accordance with the Yorkshire Water reservoir release programme. The three periods of data gathering are detailed in Table 21.

Table 21: macroinvertebrate data collection periods

Fieldwork period	Catchment	Release type	Data collected
Autumn 2008	1	2 scours	Before and after
Spring 2009	1	3 scours	Before and after + recovery
Autumn 2009	2	2 scours + 2 spates	Before and after + recovery

5.2.2 Site selection

Maps of Catchments 1 and 2 showing macroinvertebrate sampling sites appear in Figures 30 and 31. Samples were taken from two sites below each reservoir before and after each reservoir release. The use of one proximal and one distal site for each release was intended to assess the spatial extent of any wash-out effect. Upstream sites were situated as close to

the release sites as practically possible. Downstream sites were located at varying distances from the reservoirs. In Catchment 1 they were located upstream of the first major downstream confluence to avoid the dampening effects of the confluences on the high flows. In Catchment 2 the distal sites were located upstream of the first confluence for assessment of the scour releases, and downstream of the confluence for assessment of the spate releases which were expected to have further-reaching effects. Validation samples were taken from the same sites to provide control data to determine whether invertebrate populations in these streams altered significantly during a comparable time period on non-release days.



Figure 30: macroinvertebrate sampling sites in Catchment 1. Map scale 1:25000

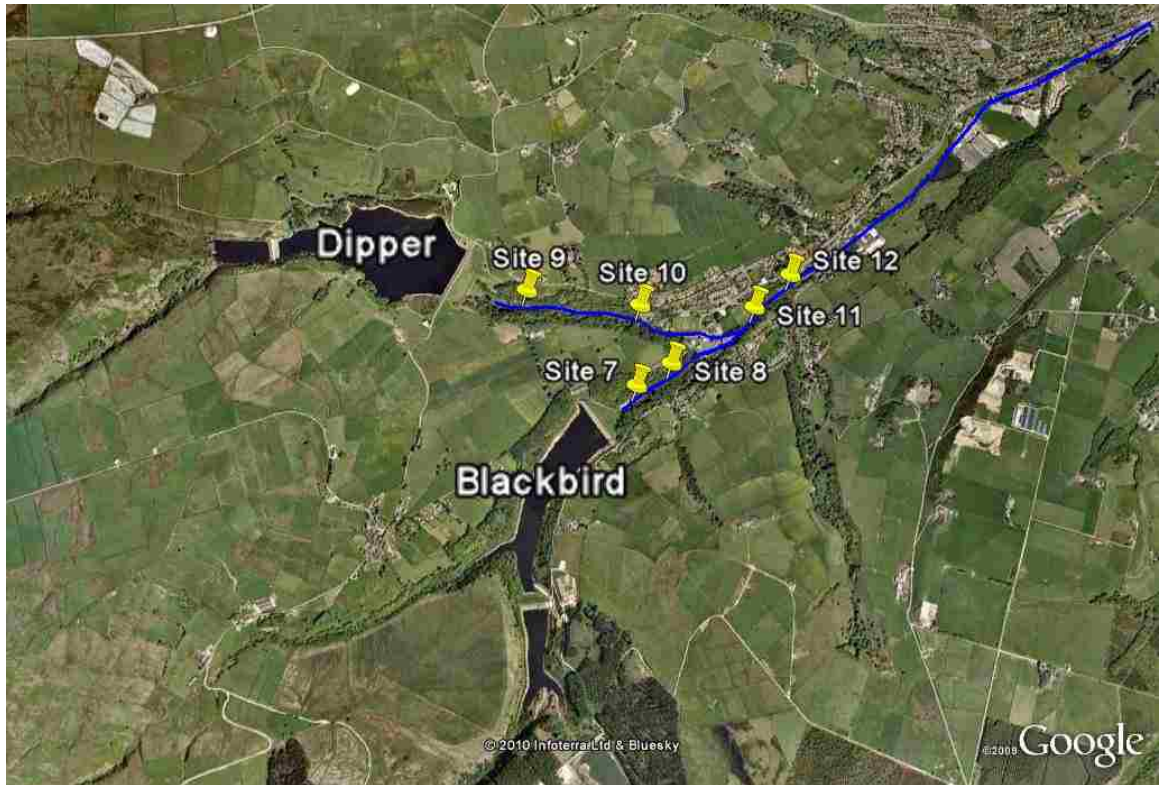

Figure 31: macroinvertebrate sampling sites in Catchment 2. Map scale 1:25000

5.2.3 Sampling techniques

The typical method for sampling benthic macroinvertebrate populations in small streams (and that generally employed by the Environment Agency) is the kick-sample, which allows the sampling of all micro-habitats at a stream site and provides a qualitative sample of the stream's biota (Armitage et al. 1983, Wright 2000, Mould 2006). However, despite providing a crude indication of abundance through the use of a fixed size net and sampling for a fixed time period, kick sampling is unable to provide quantitative estimates of invertebrate populations. As one of the possible outcomes was that macroinvertebrate populations downstream of the reservoirs may change quantitatively but remain relatively qualitatively stable the decision was made to use Surber samples (Elliott 1977, Storey et al. 1991, Whitehurst 1991, Mould 2006) as the means of measurement. A Surber sample consists of a mesh bag (in this study the mesh size was 900 μm) attached to one end of a square frame. The frame is worked into the river bed and sediment within the square disturbed by hand. The operator removes all stones from within the frame and brushes off any macroinvertebrates. All invertebrates disturbed by the sampling enter the water column and drift into the Surber net. The Surber sample thus provides both a quantitative and qualitative measure of macroinvertebrates within the square Surber frame, allowing a

calculation of invertebrate densities per unit area. Surber samples cannot be used in deep water but, unlike with kick samples which can sample a variety of habitats in a single kick, the results are dependent entirely on the habitat sampled (Cummins 1973, Cummins and Klug 1979, Vannote et al. 1980, Moss 1998, Downes et al. 2003). For these reasons it was necessary to target a single habitat type within the streams, rather than use the Surber samplers at random. Riffles were targeted as they represented the most common habitat type in these catchments, and allowed safe use of the Surber samplers. The number of samples taken was dictated by time constraints on release days and also by the number of invertebrates it would be possible to process in the laboratory in the following weeks. All samples were bagged in stream water on site to prevent desiccation. Invertebrates from each sample were then picked out and the invertebrates preserved in alcohol on the day of release to minimise losses by predation and optimise the condition of the samples for identification.

Initial attempts were also made to measure changes in invertebrate drift during the reservoir releases using fixed drift nets (Faulkner and Copp 2001, Dahms and Qian 2004, Hay et al. 2008) secured to the river bed. However, no reliable way could be found of securing the samplers to the river beds during the elevated flows, so this method could not be used. Similarly, attempts to measure invertebrate colonisation of previously dry habitats during the high flows using colonisation traps (Winterbottom et al. 1997, Negishi and Richardson 2006) were also abandoned as these samplers were intended to work over much longer time periods, and again it was not possible to secure the samplers to the river bed during the elevated flows.

Due to the disturbance to the river-bed habitat during sampling and removal of invertebrates, Surbers cannot be repeated in the same location, which presented a difficulty in this study where before and after samples were required in order to measure impact at a single site. As the disturbed sediment and biota may also affect the river bed immediately downstream of the sample site it was necessary to ensure that the repeat “after” sample sites had not been disturbed by the “before” sampling. For this reason “before” samples were taken at intervals along the left bank, while “after” samples were taken from the right bank (Figure 32). To minimise habitat variation between sample sites, samples were initially taken a fixed distance from the bank (30 cm) and at 1 m intervals, with care being taken not to disturb the river bed upstream of the sample sites. Straight sections of river

channel were selected to avoid the effects of differing flow patterns influencing the ecology on the inside and outside of the bends. Overhanging vegetation was also avoided, as shading and increased input of allochthonous organic matter could seriously affect production in even a small area.

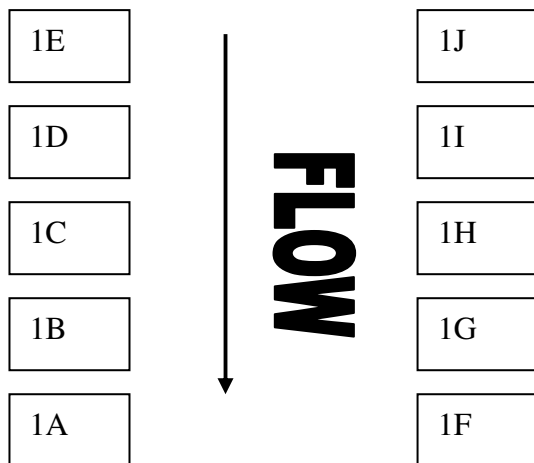

Figure 32: Surber sampling pattern, Autumn 2008, samples A to E taken pre release, samples F to J taken post release

“Before” samples were taken the afternoon before the reservoir release, and “after” samples taken as soon as possible after the release valves were closed, *i.e.* between 15 minutes and 3 hours after the flows subsided.

Validation samples taken using this technique showed that pooled “before and after” samples taken in this way from either bank at the same time were indistinguishable in terms of macroinvertebrate communities.

As analysis of the Autumn 2008 samples progressed, it became apparent that variation between individual samples taken in this way was still large, apparently due to micro-scale variations in substrate and hydrology at the sampling site (Rempel et al. 2000, Brooks et al. 2005). For example, a sample taken at a site consisting of cobbles and gravel could be far richer than one taken at a site composed mostly of bedrock and boulders. Similarly, patches of moss greatly affected invertebrate abundance. For this reason further steps were taken to standardise sampling sites in the subsequent Spring and Autumn 2009 release

periods. The sampling grid pattern remained similar, but instead of sites being determined by fixed distances, they had to meet the following criteria:

- Water depth between one half and one third of the depth of the Surber frame
- Sufficient current to distend the sample net
- No boulders or bedrock present in substrate
- No significant moss or macrophyte coverage
- No overhanging vegetation

Post release samples were again taken immediately upstream of pre release samples to avoid unnecessary disturbance effects.

In Spring and Autumn 2009 additional “recovery” samples were taken at intervals of 3, 10, 17 and 24 days following the reservoir releases in order to examine longer term responses to the releases and to monitor recovery from possible wash-out. Each set of samples was taken progressively further upstream without leaving the original riffles, and typically within 10 m to 15 m of the first sample. The length of time for which the recovery sampling continued after the release was determined partly by the ability to process the large number of samples taken and partly by the timing of the next major flow event, for example recovery sampling for the Autumn 2009 scour releases ceased when the spate releases were performed, and recovery samples following the spate releases ceased when natural high flows provided further disturbance 10 days after the releases.

5.2.4 Measurement of physical characteristics

A suite of physical measurements was taken at each of the sample sites, namely:

- Five depth measurements at even intervals across channel cross-sections at 1m intervals along the riffle
- Velocity measurements, taken slightly below the surface at the same intervals as depth measurements
- Channel width – wetted channel width on day of survey at 1 m intervals along the riffle
- Substrate – percentages of bedrock, boulders, cobbles, gravel, sand and manmade material at 1 m intervals

- Percentage cover of moss, algae and macrophytes
- Percentage cover of overhanging vegetation

For the data analysis in Section 5.4 each of these variables was averaged to provide a mean value for the site as a whole.

5.2.5 Macroinvertebrate identification

Autumn 2008

In Autumn 2008, all invertebrates were identified to species level where possible. Identification took place in the Environment Agency laboratories in Leeds, using Freshwater Biological Association, Environment Agency and Field Studies Council keys (Macan and Douglas Cooper 1960, Gledhill et al. 1976, Croft 1986, Elliott et al. 1988, Savage 1989, Hynes 1993, Wallace et al. 2003, Edington and Hildrew 2005, Wallace 2006, Pryce et al. 2007). Identification was overseen by Environment Agency staff, who checked random samples for quality control purposes. In cases where identification to species level was not possible (mostly Chironomidae, Oligochaeta, Hydracarina and individuals that were either too small or damaged in the collection process) specimens were assigned to the highest taxonomic level possible. In these situations the data were included in taxon counts where possible, for example oligochaetes were counted as a single taxon, although several families were probably present that were not possible to distinguish. On the other hand a damaged stonefly larva that could not be identified was recorded as “unknown stonefly” and appears in the individual organism count but not in the taxon count, as it is likely that its family was already represented by intact individuals. In a few cases organisms had been broken in two, so if a head and tail end of a mayfly or two closely matching parts of a worm were found they were counted as a single organism.

Spring and Autumn 2009

As identification to species level did not appear to enhance the analysis of Autumn 2008 samples (Section 5.3.1) and was not possible for a significant proportion of the individuals sampled, a decision was taken to identify all further samples to family level and re-process the Autumn 2008 data at family level. This did not substantially reduce the number of taxa recorded for a given sample (as none of the recorded families contained more than three species), and saved significantly on time, allowing for the processing of the recovery

samples. It also reduced error associated with mis-identification, and by grouping the taxa to family level reduced the chances of misinterpreting data from the species that are found very infrequently. An analysis of the data lost when analysing family as opposed to species data appears in the validation section, below.

5.2.6 Univariate and multivariate analysis

A number of metrics were used to assess the impacts of the releases upon the downstream macroinvertebrate populations. The most basic of these were counts of individual invertebrates and counts of taxa per site before and after each release, providing measures of abundance and taxonomic richness respectively. However, despite the obvious benefits of these metrics in identifying overall impacts, they are unable to show precisely how sites differ, and cannot pick out subtle changes, such as the loss of small proportions of certain taxa, or the replacement of a particular taxon with another one. For this reason, both multivariate and univariate methods are used here to examine the impacts of releases. Multivariate techniques are used to pick out more subtle changes, such as differences in community structure measured by the presence or absence of individual taxa, or small but repeated changes to the abundance of certain taxa.

Non-metric multi-dimensional scaling (MDS) ordinations (Clarke and Warwick 2001, Clarke and Gormley 2006) were used to identify pre and post release impacts. These plots are a two dimensional representation of a multi-dimensional plot of the numbers of individuals in each taxon in a sample, with each taxon represented by one axis of the multi-dimensional graph. In the final 2D output, each sample is represented by a single point, and the similarity of the samples represented by their proximity. In this way, the numbers of individuals present in each taxon can be represented in a single plot. It should be noted that the 2D MDS plots are visual representations of the highly complex multi-dimensional plots and are therefore a “best-fit” used as visual representations rather than statistical tools. In order to analyse the information provided by the multi-dimensional scaling, ANOSIM statistics (Clarke and Warwick 2001, Clarke and Gormley 2006) must be calculated.

The ANOSIM (Analysis Of Similarity) statistic is a development of the MDS plots, providing a measure of the distance between the samples when plotted in multidimensional

space (i.e. their dissimilarity), and the probability of this dissimilarity having occurred by chance. This value is calculated by plotting the points at random a given number of times (in these cases 999) and calculating how many times the dissimilarity statistic for the actual ordination is exceeded. The test produces a “Global R ” statistic, a value between -1 and 1, which is effectively a measure of the distance between sample sets using arbitrary units and also a p value representing the probability of the dissimilarity between the two samples having occurred by chance. (Clarke and Warwick 2001, Clarke and Gormley 2006).

Once an ANOSIM test has established a significant difference between two sets of samples the contributions of individual taxa to this difference may be assessed using the Primer-E SIMPER routine, which scores each taxon present on its contribution to the dissimilarity between samples (Clarke and Warwick 2001, Clarke and Gormley 2006, Mould 2006). This test is used here to assess which taxa changed in abundance most greatly following the reservoir releases at sites where before and after samples were found to be significantly different.

Although both the ANOSIM and SIMPER tests are often performed on transformed data (e.g. data where the abundance values have been square-rooted) for the purposes of this study the data remain untransformed. In these catchments, the distribution of individuals between taxa was relatively even, so no taxa entirely dominated or dramatically skewed the results, although the changes in abundance of the more common taxa still contribute more strongly to the ANOSIM test results than those of the less well represented taxa. To determine if changes were occurring to the taxa that comprise the communities as well as the numbers of the constituent taxa, ANOSIM tests were performed on presence / absence data for each set of samples. SIMPER tests, by their nature, cannot be performed on presence / absence data as each taxon receives equal weighting.

In order to examine the correlations between invertebrate results and the physical characteristics of the sampling sites, the invertebrate results at each site were assigned two metrics – the presence or absence of a significant ANOSIM result, and the percentage change in overall abundance. Correlations were then sought between these metrics and the physical variables measured at each site. As the physical data measurements were recorded in a variety of units (depth in cm, substrate cover as a percentage etc.), the

physical data were normalised using Primer-e to give each variable a value between -1 and 1 and therefore equal weighting.

5.3 Results

5.3.1 Validation data

The validation data for Catchment 1 in Autumn 2008 are summarised in Table 22 below. Two sets of five samples were taken to represent the “before” and “after” samples taken during later reservoir releases. No significant differences ($p \leq 0.05$) were found between “before” and “after” samples in terms of either numbers of individuals or numbers of taxa recorded.

Table 22: summary statistics for Autumn 2008 invertebrate validation data. As with later study sampling, five replicate samples were taken “before” and “after” at each site.

Validation Sample Site	1	2
Mean number individuals per sample “before” \pm SD	27.4 \pm 14.9	35.0 \pm 8.9
Mean number individuals per sample “after” \pm SD	22.6 \pm 14.6	38.2 \pm 15.2
Number taxa “before”	15	19
Number taxa “after”	14	17
2 tailed t-test on numbers of individuals per sample “before” and “after” (t, n, P)	0.278, 5, 0.788	0.850, 5, 0.420
2 tailed t-test on numbers of taxa per sample “before” and “after” (t, n, P)	0.849, 5, 0.421	0.446, 5, 0.151
ANOSIM R value (p)	-0.052 (60.3%)	-0.152 (84.9%)
ANOSIM R value (p) for taxa presence / absence data	-0.14 (85.7%)	-0.088 (78.6%)

Following the change in sampling procedure in Spring 2009 the variation between the numbers of individuals per Surber unit within each sample was reduced, and differences between numbers of families and individuals are insignificant. ANOSIM tests were still unable to distinguish between “before” and “after” samples.

Table 23: summary statistics for Spring 2009 invertebrate validation data

Validation Sample Site	3	4
Mean number individuals per sample “before” ± SD	28.6 ± 11.5	24.6 ± 8.4
Mean number individuals per sample “after” ± SD	26.8 ± 7.3	26.2 ± 8.4
Number taxa “before”	15	13
Number taxa “after”	14	11
2 tailed t-test on numbers of individuals per sample “before” and “after” (t, n, P)	0.301, 5, 0.771	0.296, 5, 0.775
2 tailed t-test on numbers of taxa per sample “before” and “after” (t, n, P)	0.632, 5, 0.545	1.200, 5, 0.264
ANOSIM R value (p)	0.03 (38.1%)	0.034 (36.5%)
ANOSIM R value (p) for taxa presence / absence data	-0.126 (79.4%)	-0.128 (53.2%)

An analysis of the variations between samples using the two sampling methods in Autumn 2008 and Spring 2009 at the same sites shows that standard deviation as a proportion of the mean numbers of individuals recorded decreases markedly at 6 of the 8 sites (Figure 31) using the targeted sampling method in Spring 2009, showing that the targeted sampling provided a more consistent and reliable picture of community structure and mitigated against the inherent heterogeneity of any given section of stream bed. The targeted sampling method was adopted for subsequent surveys to improve the probability of identifying community changes associated with the reservoir releases.

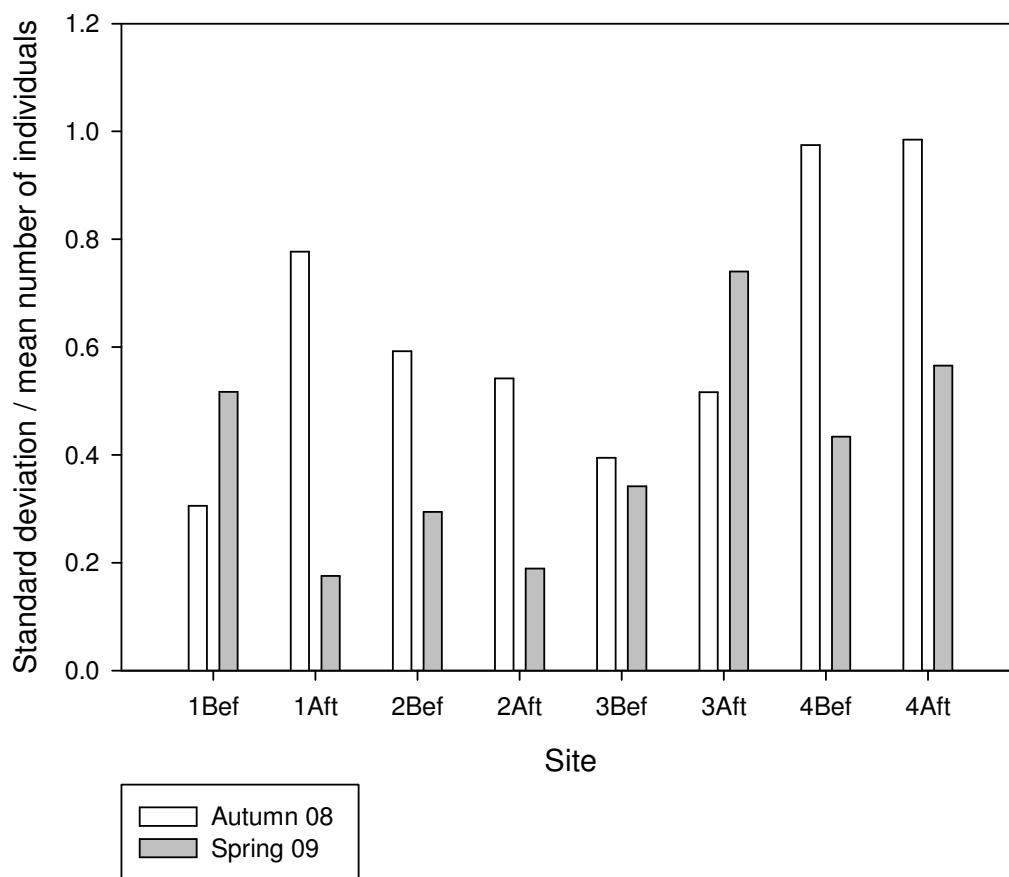

Figure 33: standard deviation as a proportion of the mean number of individuals recorded per standard Surber using the Autumn 2008 and Spring 2009 sampling techniques

Family versus species analysis

It was not possible to differentiate between the family and species data using either counts of individuals (as they are the same) or counts of taxa (as they are inherently incomparable). Using ANOSIM tests it was possible to assess the samples taken before and after the scour releases in Autumn 2008 from which both species and family data are available and compare the outcomes, as shown in Table 24. Species and family level data again produce the same results, showing a significant difference at site 1 and no significant result at the other three sites.

Table 24: a comparison of the ANOSIM results for Autumn 2008 Catchment 1 scour release data using family and species level data from sites 1, 2, 3 and 4 (Figure 30).

Site	1	2	3	4
Family data ANOSIM R (p)	0.41 (0.8%)	-0.148 (97.6%)	-0.032 (57.9%)	-0.006 (54.8%)
Significant difference?	Yes	No	No	No
Species data Global R (p)	0.3 (2.4%)	-0.114 (88.1%)	0.072 (27.0%)	-0.121 (92.1%)
Significant difference?	Yes	No	No	No
Different result?	No	Yes	No	No

By transforming the same data to presence / absence level (as opposed to counts of individuals) it is possible to further analyse the differences found using the two levels of identification, as seen in Table 25.

Table 25: a comparison of ANOSIM results for family and species presence/absence data for Autumn 2008 scour releases, Catchment 1.

Site	Stream 1 up	Stream 1 down	Stream 2 up	Stream 2 down
Family data ANOSIM R	0.16	-0.09	0.174	0.03
Family data p	13.5%	90.5%	4.8%	42.9%
Significant difference?	No	No	Yes	No
Species data ANOSIM R	0.218	-0.02	0.154	-0.108
Species data p	8.7%	61.9%	10.3%	90.5%
Significant difference?	No	No	No	No
Different result?	No	No	Yes	No

In this case the only significant result found is the difference in family data at the upstream Stream 2 site. This is in fact a “false positive” which arises because the before and after samples at this site contain a number of unique families, but these families only appear a single time. When families appearing only once are removed the result changes to R 0.15, p 10.3%, making the communities statistically indistinguishable. Using the species data, the number of taxa unique to either of the before / after sample sets contains sufficient variation within the samples of the before and after sample sets to prevent a significant difference between the two groups from being shown. Again, in this situation, the presence of the large numbers of scarcely found taxa in the species data proves to be a hindrance rather than a help in identifying post-event effects, as the noise created by these taxa overpowers the differences found in the family-level data. However, care must be taken with the pooled data to avoid showing false positive results created by the presence or absence of poorly represented families.

In summary, using the data collected in Autumn 2008, the family level data proved equally effective at identifying community change as the species level data and may also reduce the noise associated with the higher numbers of less abundant taxa found in the species level data. The analysis of both sets of data shown above justifies the decision to identify Spring and Autumn 2009 data sets only to family level.

5.3.2 Scour releases, Catchment 1, Autumn 2008

The locations of the sampling sites in Catchment 1 are shown Figure 34 below.

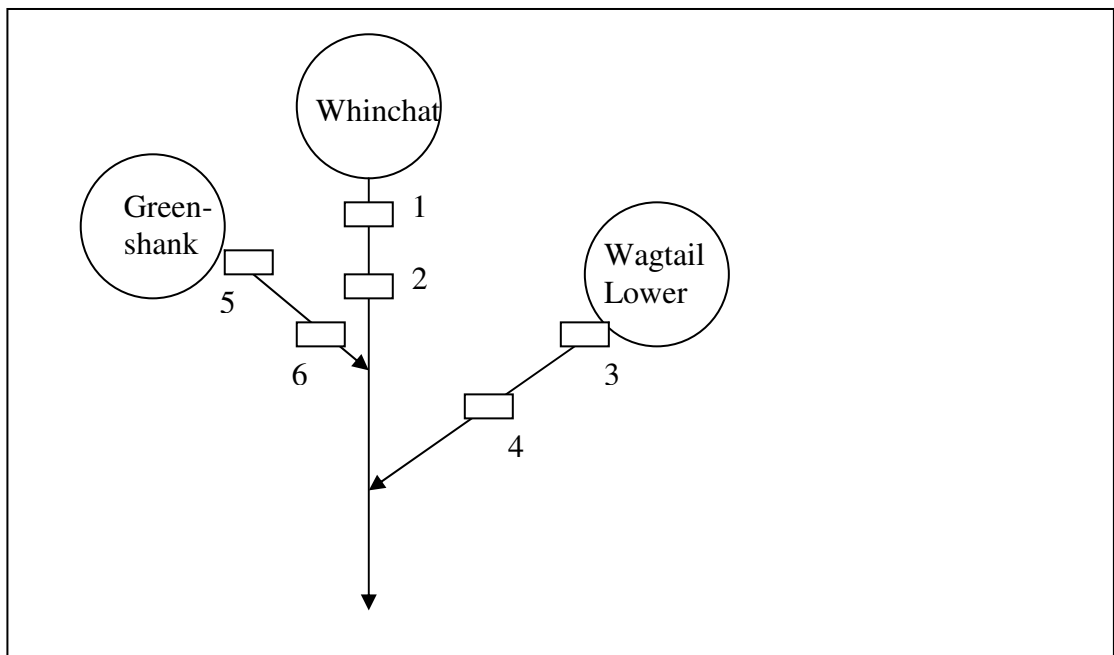

Figure 34: schematic representation of Surber sampling sites, Catchment 1

Due to the flood in early September 2008 it was not possible to collect invertebrate samples before or after the scour release from sites 5 and 6 below Greenshank reservoir. The invertebrate abundances from sites 1, 2, 3 and 4 below Whinchat and Wagtail Lower reservoirs appear in Figure 35 below.

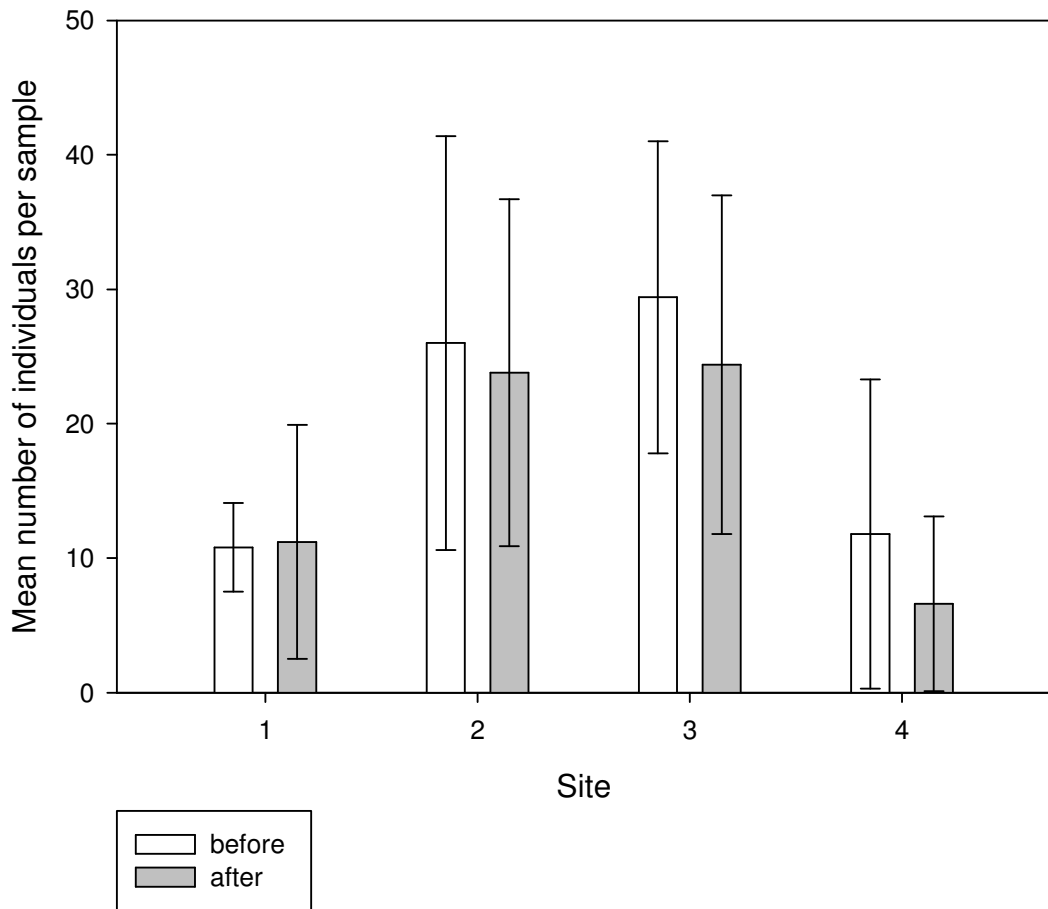

Figure 35: mean numbers of individuals per Surber sample showing standard deviations before and after Autumn 2008 scour releases, Catchment 1. For each sample set $n = 5$. For site locations refer to Figure 30.

Although the numbers of individuals at sites 2, 3 and 4 fell following the scour releases, the variation between samples (as illustrated in the error bars, above) is such that no significant differences in the numbers of individuals present are found using one-tailed t-tests ($p \leq 0.05$). In the case of the numbers of taxa recorded at each site (Figure 36), numbers actually increased marginally at two sites and remained constant at the other two sites.

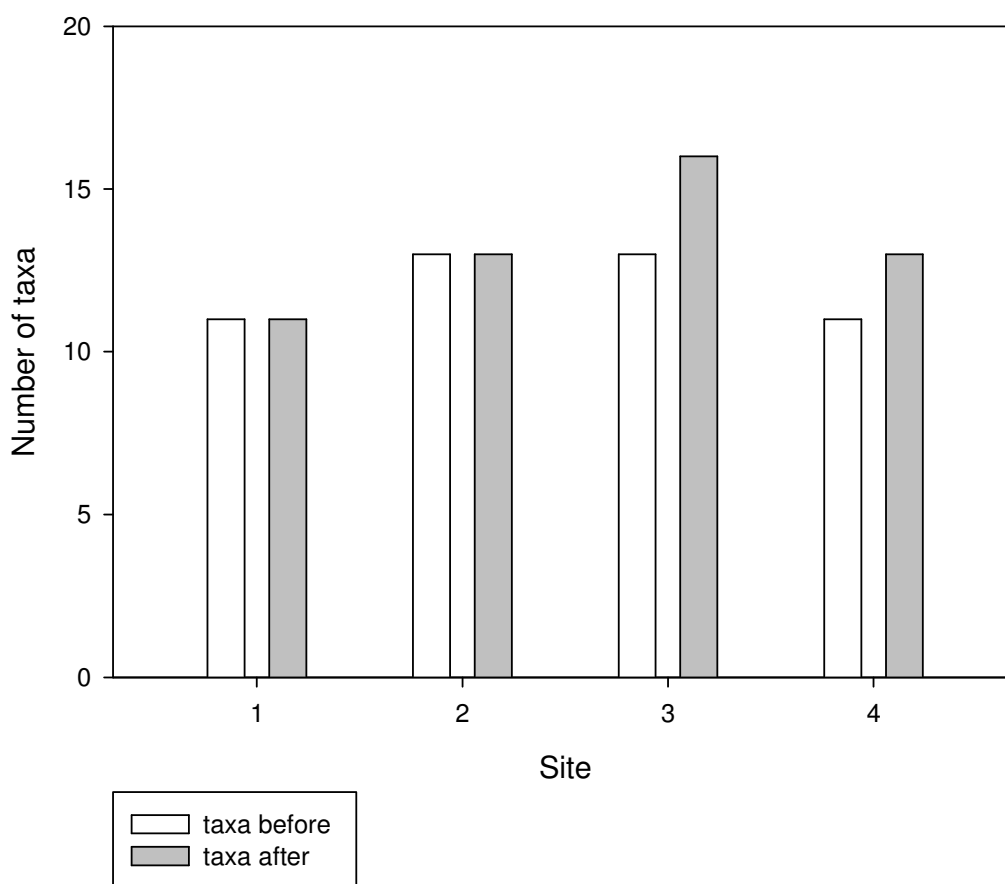

Figure 36: numbers of taxa found at each site before and after Autumn 2008 scour releases, Catchment 1. For sites identified refer to Figure 30.

Multivariate data

Table 26: ANOSIM analyses of community changes during Autumn 2008 scour releases, Catchment 1.

	Site	1	2	3	4
Full data	Global R	0.41	-0.231	-0.036	-0.006
	<i>p</i>	0.8%	97.6%	57.1%	54.8%
	Significant?	Yes	No	No	No
Taxa presence / absence data	Global R	0.16	-0.09	0.174	0.03
	<i>p</i>	13.5%	90.5%	4.8%	42.9%
	Significant?	No	No	Yes	No

Despite the lack of significant changes to overall abundance or numbers of taxa, the ANOSIM analyses identified significant changes to community structure at site 1. When reduced to presence / absence of taxa data these changes were not significant, suggesting that the changes occurred within the proportions of the same taxa, rather than a replacement of original taxa by new.

Conversely, at site 3, no significant change was seen in the full data set, but the presence / absence data showed a significant change. In this case the change is accounted for by the presence or absence of rarer taxa such as Gammaridae and Chaoboridae appearing in single numbers before or after the release, rather than a washout or wash-in of a common taxon.

An examination of the SIMPER results (Table 27) and raw data shows that at this site the depletion of Nemouridae following the Autumn 2008 scour release contributed most strongly to the overall difference. Another stonefly family, Leuctridae and the blackfly larvae (Simulidae) also declined following the release, while numbers of Polycentropopidae (a caseless caddis) and Elmidae (riffle beetles) increased.

Table 27: SIMPER contributions of top five taxa at site 1, Autumn 2008, Catchment 1

Taxon	Increase or decrease in absolute abundance	Percentage contribution to difference between before and after samples	Percentage contribution to community prior to scour
Nemouridae	↓	17.24	24
Polycentropopidae	↑	16.42	13
Leuctridae	↓	14.36	7
Elmidae	↑	10.63	11
Simulidae	↓	9.60	15

5.3.3 Scour releases, Catchment 1, Spring 2009

A schematic diagram showing the locations of the sampling sites from Spring 2009 appears in Figure 34, above.

A full data set, including post-release recovery samples, was collected in Spring 2009. Figures 37 and 38 below present the changes to abundance of individuals per sample and the numbers of families per site pre and post release. Following the Spring 2009 scour releases, abundance of individual macroinvertebrates decreased at sites 1, 2, 4, 5 and 6 and increased at site 3. In the cases of sites 1 and 4, one-tailed t-tests assuming unequal variance between samples showed significant results of $p = 0.0480$ and 0.0481 respectively. Other sites produced insignificant results and mean abundance pre and post release were similar (Figure 37).

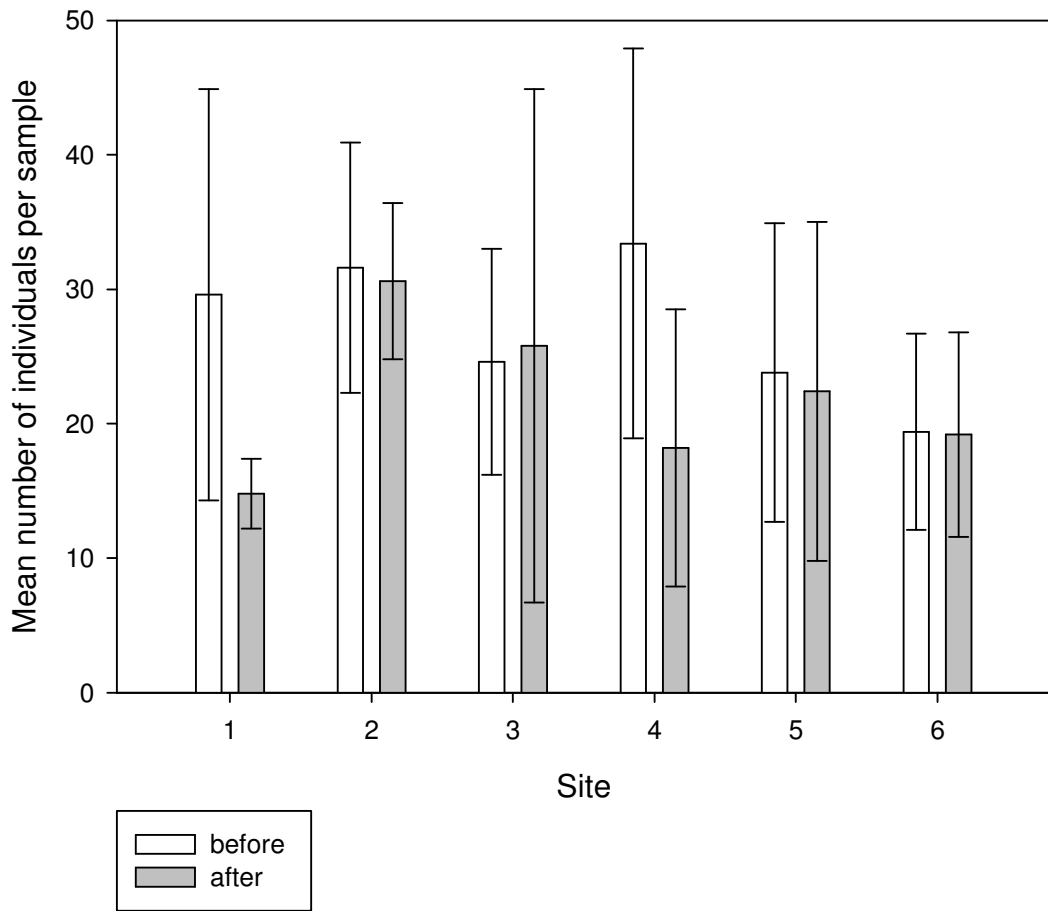

Figure 37: mean numbers of individuals per sample showing standard deviations before and after Spring 2009 scour releases, Catchment 1. n = 5 in each case. For sites identified refer to Figure 30.

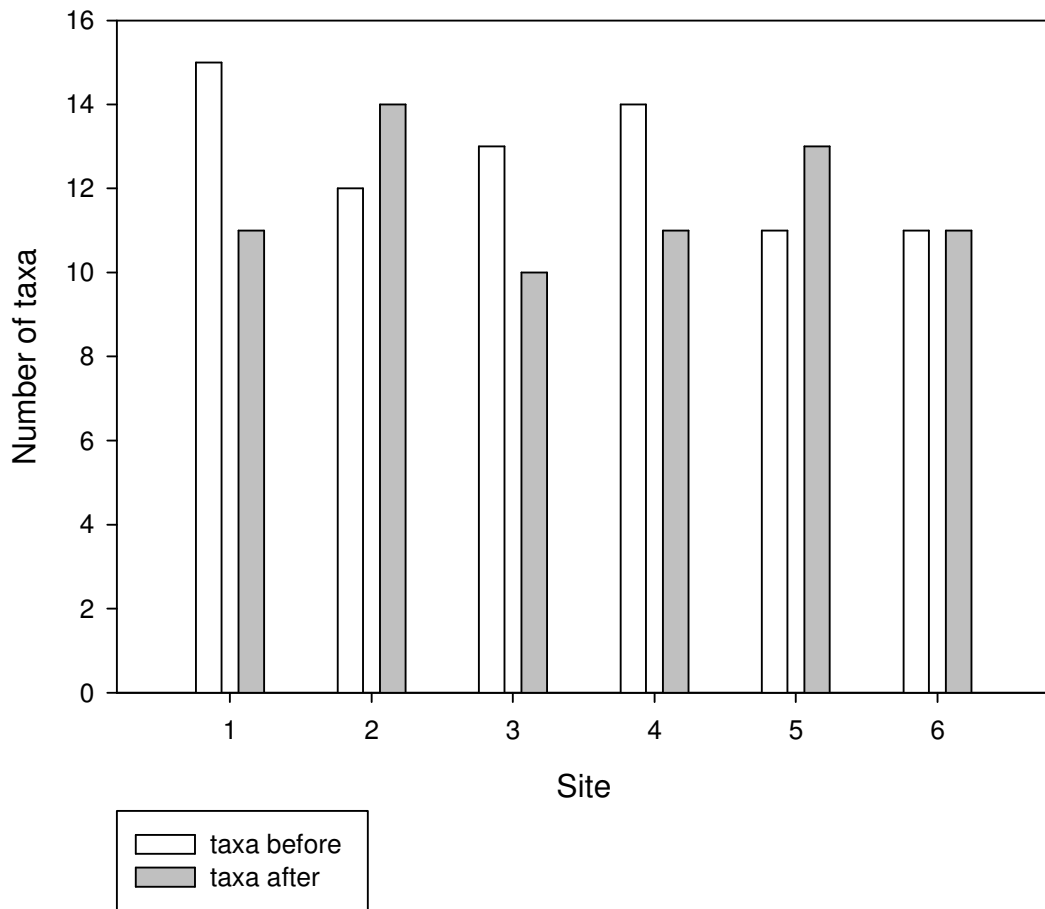

Figure 38: numbers of taxa found at each site before and after Spring 2009 scour releases, Catchment 1. For sites identified refer to Figure 30.

Multivariate data

The ANOSIM results in Table 28 confirm the community change at site 1, with significant results for both the full data and presence / absence data. The SIMPER data (Table 29) and raw data show the family Nemouridae are again the most heavily impacted taxon, with the greatest proportional loss and the greatest contribution to the difference between before and after samples, as in Autumn 2008. The three other stonefly families present, the Perlodidae, Chloroperlidae and Leuctridae also suffer losses in terms of numbers of individuals. The mayfly family Baetidae also declined in abundance. Again the significant result in the presence / absence data was produced by the rarer taxa appearing in single numbers. No other site shows a significant change for this set of scour releases. An examination of the data for site 4, which revealed a significant difference in abundance shows reductions to 8 of the 14 taxa found, no change to 4 and an increase in 2. However

the changes are less dramatic than those seen at sites showing significant ANOSIMs, and more of a general reduction in numbers of individuals than a change to community structure. Again the Perlodidae and Leuctridae show the greatest losses, along with the Chironomidae. No other site shows a significant change.

Table 28: ANOSIM analyses of community changes during Spring 2009 scour releases, Catchment 1

	Site	1	2	3	4	5	6
Full data	Global R	0.592	-0.132	0.034	0.166	-0.042	0.006
	p	3.2%	82.5%	38.1%	9.5%	52.4%	43.7%
	Significant?	Yes	No	No	No	No	No
Taxa presence / absence data	Global R	0.266	-0.016	0.028	0.248	0.094	-0.038
	p	1.6%	46.8%	38.1%	5.6%	19.8%	59.5%
	Significant?	Yes	No	No	No	No	No

Table 29: SIMPER contributions of top five taxa at site 1, Spring 2009, Catchment 1

Taxon	Increase or decrease in absolute abundance	Percentage contribution to difference between before and after samples	Percentage contribution to community prior to scour
Nemouridae	↓	21.05	28
Polycentropopidae	↑	17.98	3
Chironomidae	↓	10.50	16
Baetidae	↓	9.56	11
Chloroperlidae	↓	8.57	11

Recovery data

Following the Spring 2009 scour events, recovery samples were taken 3, 10 and 17 days after each reservoir release at each of the sampling sites. Figures 39 and 40 show abundance and taxa counts during the recovery period. There are no consistent patterns to changes in overall abundance or taxonomic richness per site during the 17 days following the scour releases.

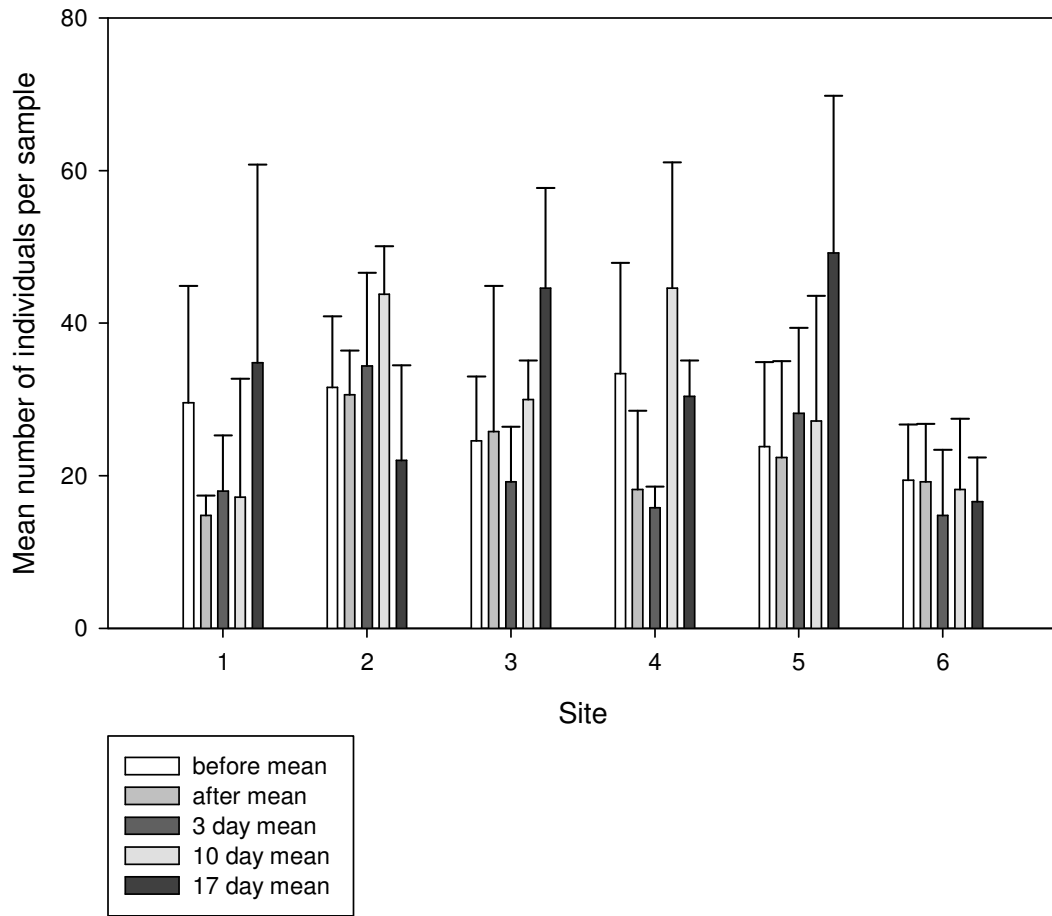

Figure 39: mean and standard deviation of abundance of individuals during a 17 day recovery period following Spring 2009 scour releases, Catchment 1. For location of sites refer to Figure 30.

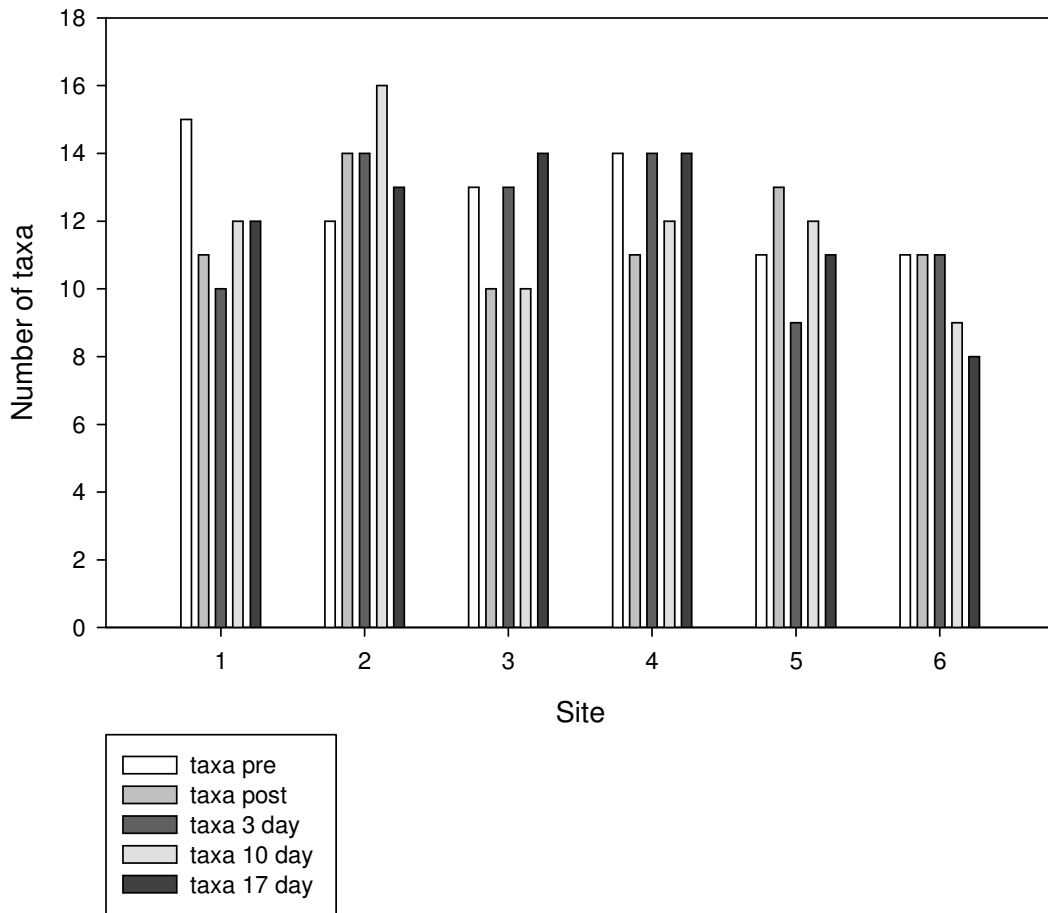

Figure 40: taxa counts during 17 day recovery period following Spring 2009 scour releases, Catchment 1. For location of sites refer to Figure 30.

Despite the lack of detectable patterns in the changes in abundance and richness during the sampling period, ANOSIM tests and MDS plots show that the community at the impacted site 1 continued to change during the sampling period (Figure 41). The other sites, which did not show significant impacts in Table 28, do not show this level of change during the recovery period, although site 4 which showed a significant change in abundance but not community structure changes significantly between 3 and 10 days and again between 10 and 17 days. The communities at every site except site 4 change significantly through the 17 day period, with the final samples all being distinguishable from the original “pre” samples. A summary of the changes at each site during the 17 day sampling period appears in Table 30 below.

Table 30: significant community changes as defined by ANOSIM test during the recovery period following the Spring 2009 scour releases, Catchment 1

Site	1	2	3	4	5	6
Pre scour to post scour	Yes	No	No	No	No	No
Post scour to 3 day	Yes	No	No	No	No	Yes
3 day to 10 day	Yes	No	Yes	Yes	No	No
10 day to 17 day	Yes	Yes	No	Yes	Yes	No
17 day sample different to pre sample?	Yes	Yes	Yes	No	Yes	Yes

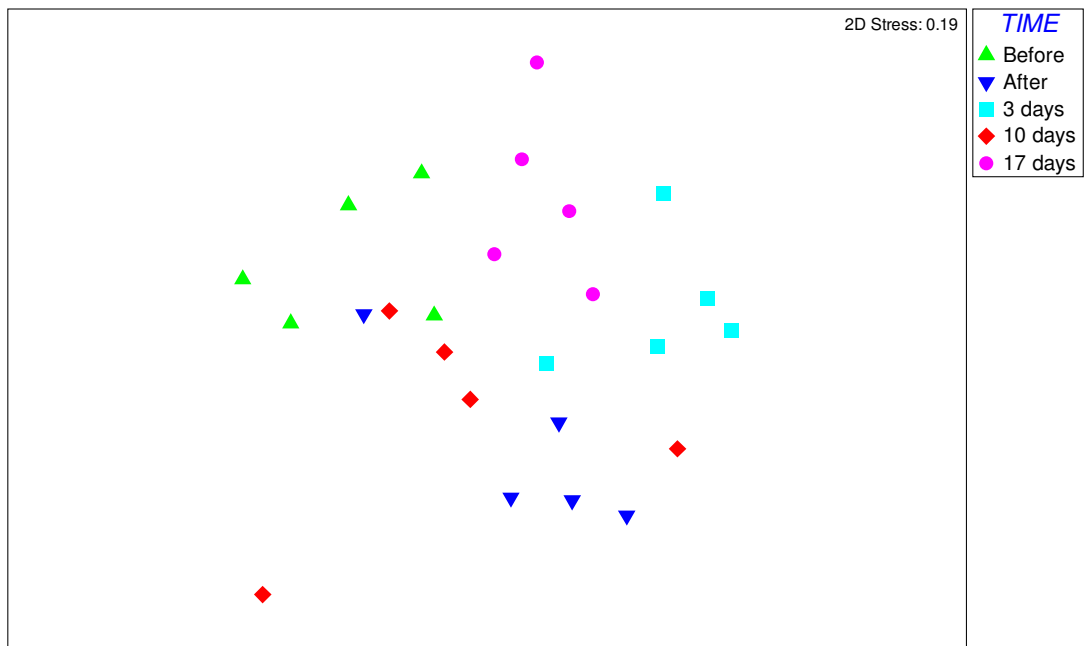

Figure 41: MDS plot showing similarity of samples throughout recovery period at site 1

5.3.4 Scour and spate releases, Catchment 2, Autumn 2009

The locations of the sampling sites used in Catchment 2 in Autumn 2009 appears in Figure 42, below.

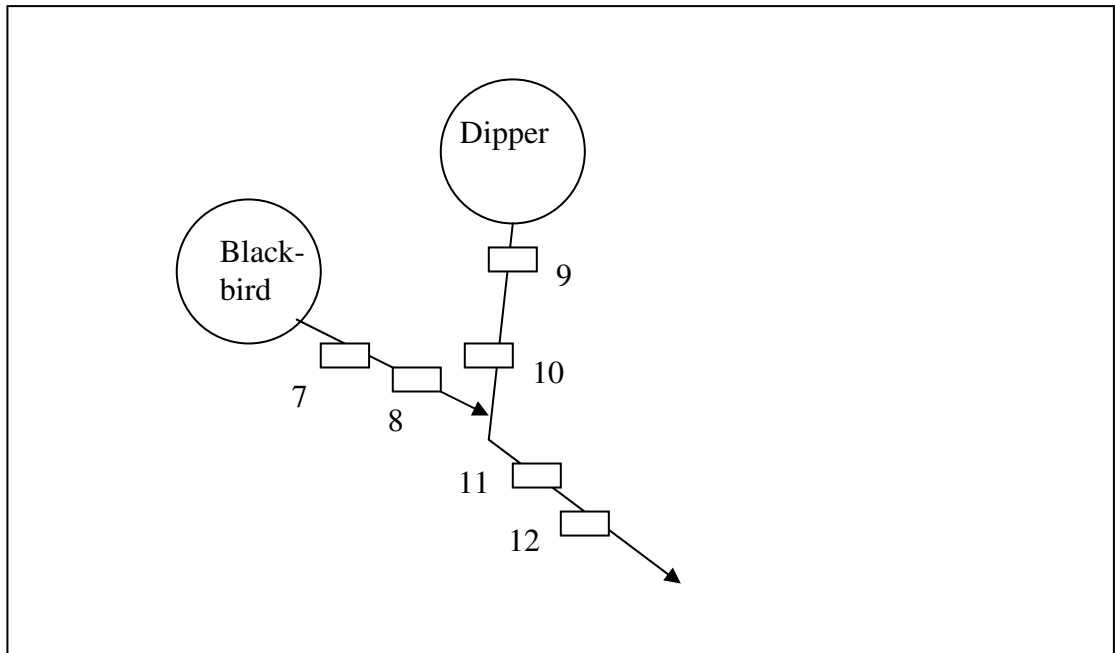

Figure 42: schematic representation of the Surber sampling sites in Catchment 2, Autumn 2009

Scour releases

A full data set, including post-release recovery samples, was collected in Autumn 2009 from sites 7, 8, 9 and 10. Figures 43 and 44 show the changes in the abundance of individuals per sample and the numbers of families per site pre and post release.

Following the Autumn 2009 scour releases abundance of individual macroinvertebrates increased at three of the four sites, decreasing only at the downstream site at site 6. None of the changes were shown to be significant using t-tests at $p \leq 0.05$.

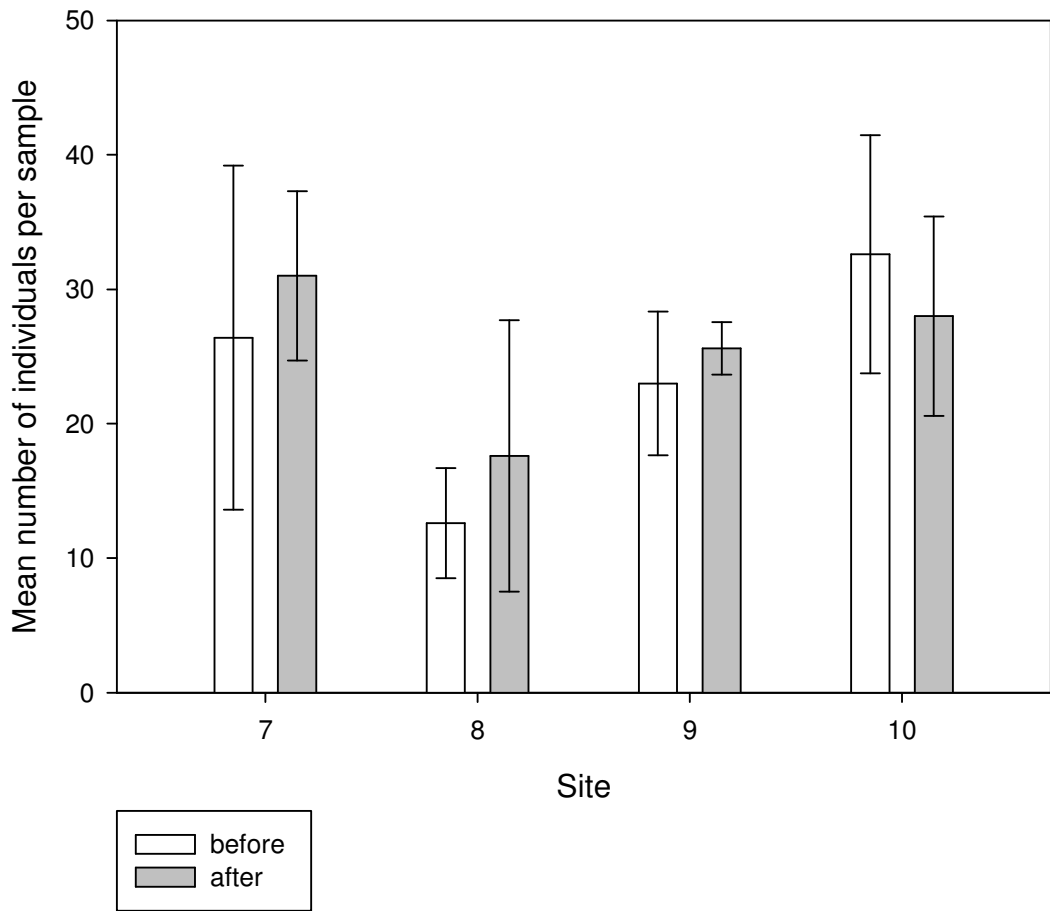

Figure 43: mean numbers of individuals per sample showing standard deviations before and after Autumn 2009 scour releases, Catchment 2

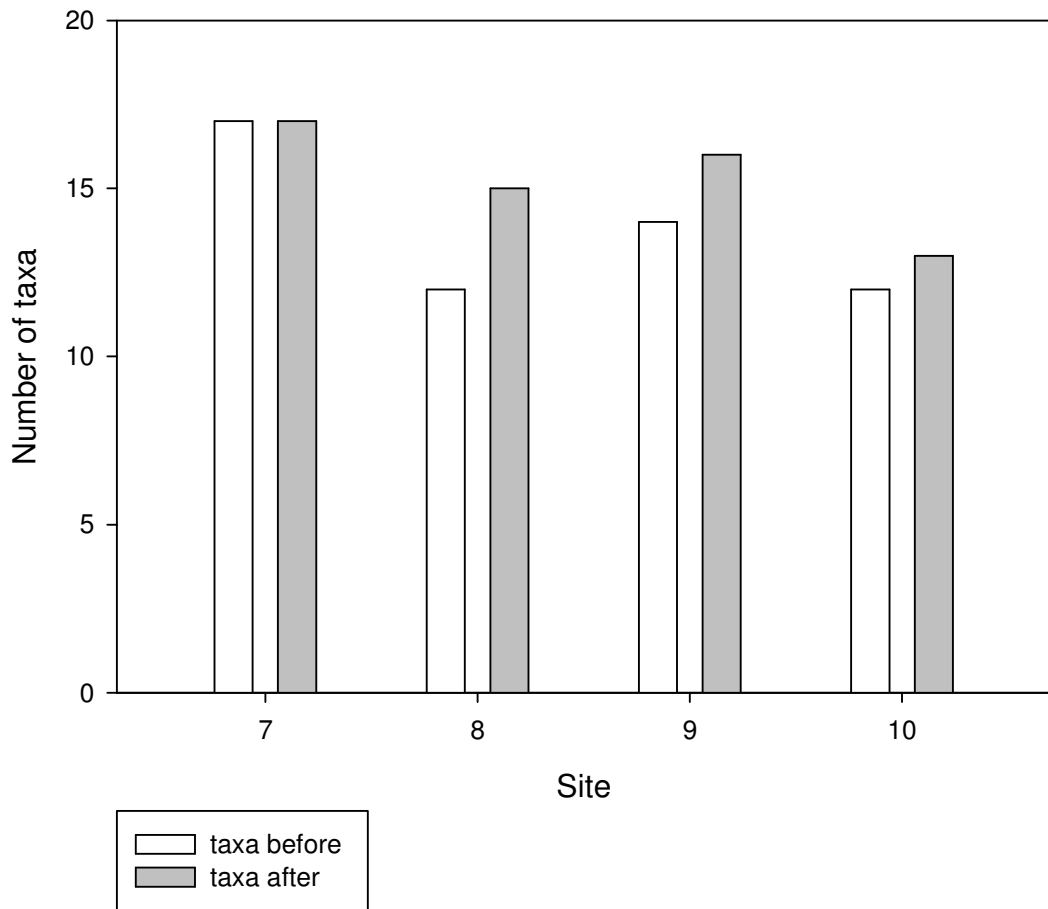

Figure 44: numbers of taxa found at each site before and after Autumn 2009 scour releases, Catchment 2. For site locations refer to Figure 31.

Multivariate data

The ANOSIM data in Table 31 confirms that none of the sites were heavily impacted during the Autumn 2009 scour releases, although site 9 showed a change in the presence / absence data. Again, this was affected mostly by the rarer taxa, although the ephemereidid mayflies decreased from 6 to 0.

Table 31: ANOSIM analyses of community changes during Autumn 2009 scour releases, Catchment 2. For site locations refer to Figure 31.

Full data	Reservoir	Blackbird			Dipper
	Site	7	8	9	10
	Global R	0.004	0.21	0.054	-0.116
	p	45.2%	8.7%	27.8%	80.2%
Taxa presence / absence data	Significant?	No	No	No	No
	Global R	-0.028	0.088	0.42	0.05
	p	46.8%	25.4%	0.8%	34.1%
	Significant?	No	No	Yes	No

Recovery data

Following the Autumn 2009 scour releases, recovery samples were taken at 3, 10, 17 and 24 days after each reservoir release at sampling sites 7 to 10. Figures 45 and 46 show abundance and taxa counts during the recovery period. There were no consistent patterns to changes in overall abundance or taxonomic richness per site during the 24 days following the scour releases.

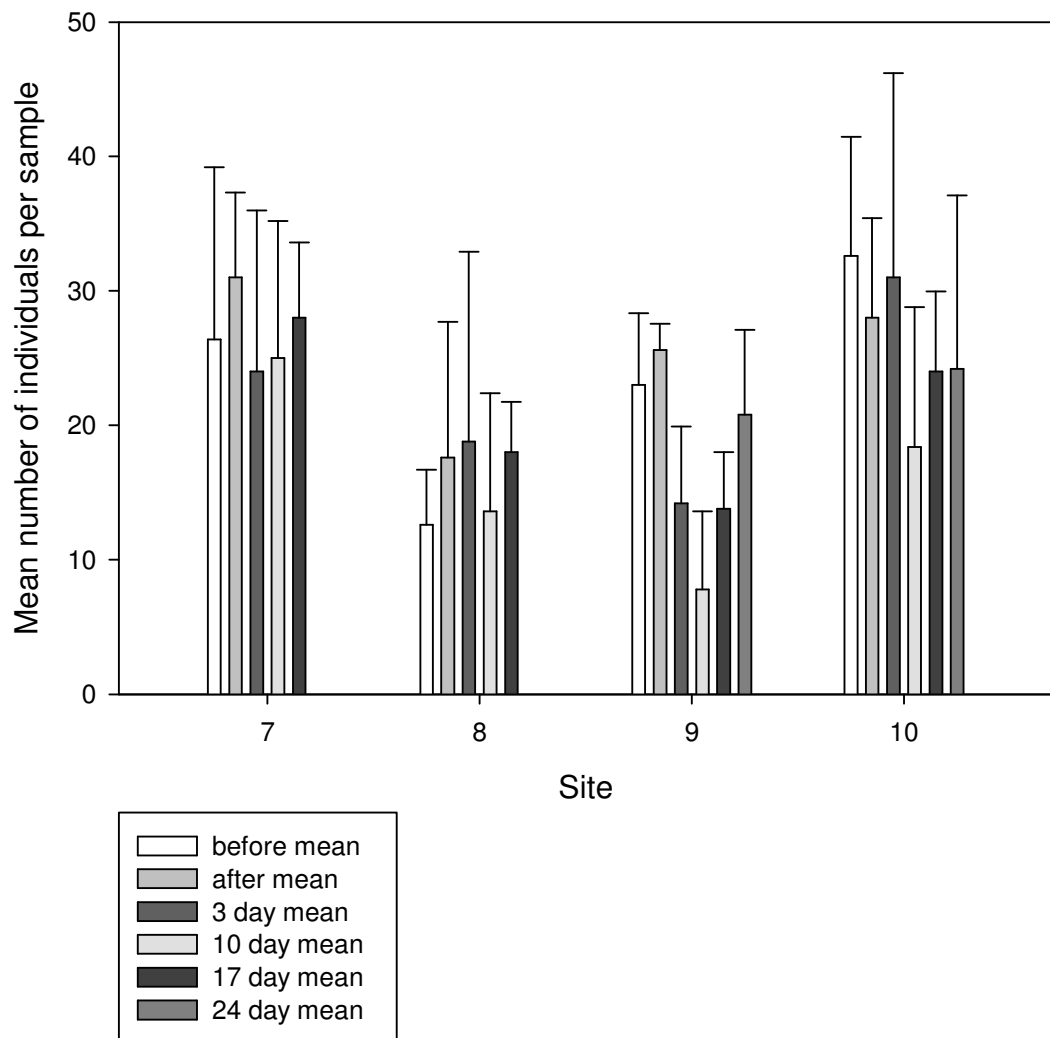

Figure 45: abundance of individuals during recovery period following Autumn 2009 scour releases, Catchment 2. For site locations refer to Figure 31.

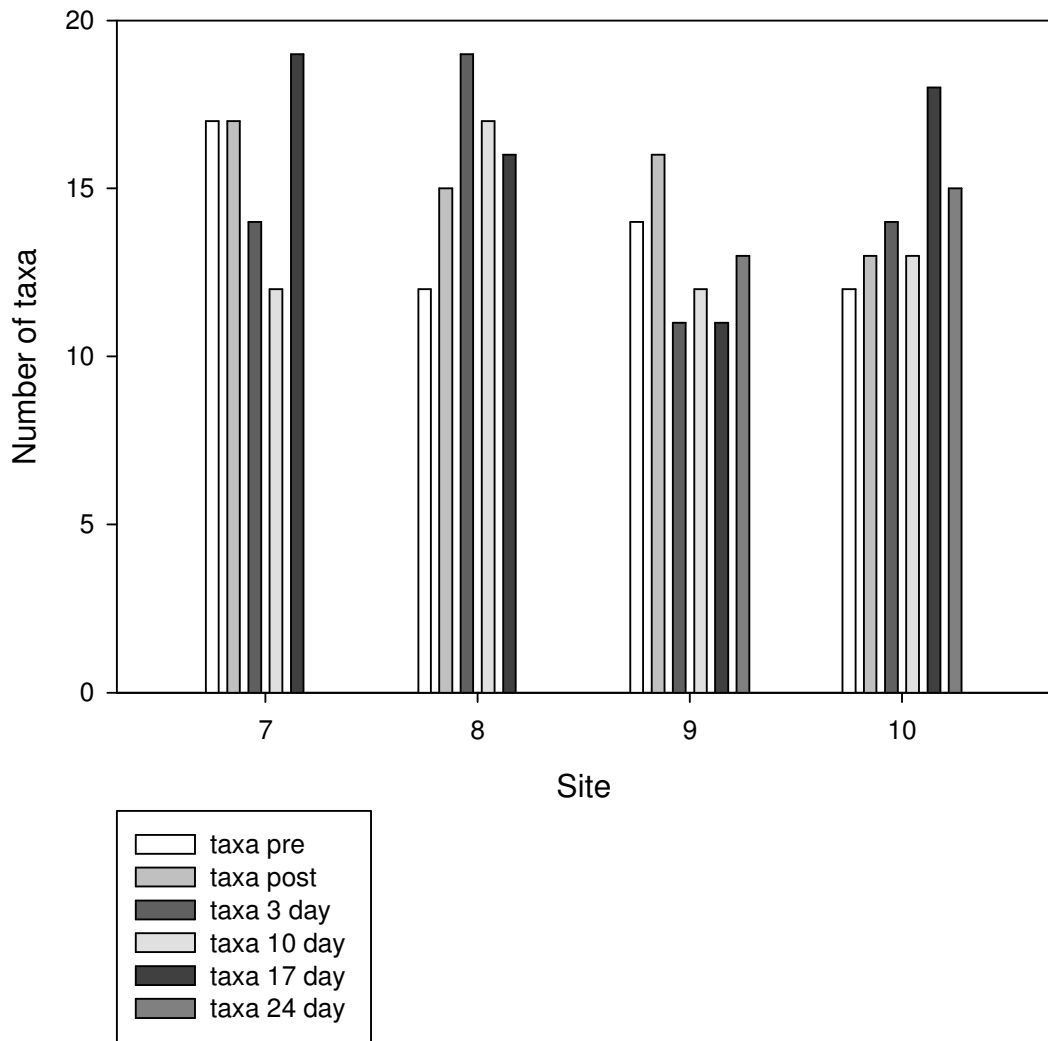

Figure 46: taxa counts during recovery period following Autumn 2009 scour releases, Catchment 2

Despite the lack of significant differences to abundance or richness between the pre and post samples, ANOSIM tests again pick out occasional differences between sample periods in the recovery samples, most notably at site 9, which displayed changes between each set of samples from Day 3 through to the final sample on Day 24. These changes are partly a result of the low overall abundance on day 10. Presence / absence analysis of taxa for this site shows that the community constituents do not change significantly during this period, and the changes seen are due to changing abundances of certain taxa rather than a change in the taxa themselves.

Table 32: significant community changes during the recovery period following the Autumn 2009 scour releases, Catchment 2

Reservoir	Blackbird			Dipper
Site	7	8	9	10
Pre scour to post scour	No	No	No	No
Post scour to 3 day	No	No	No	No
3 day to 10 day	No	Yes	Yes	No
10 day to 17 day	No	No	Yes	No
17 day to 24 day	-	-	Yes	Yes
Final sample different to pre sample?	No	Yes	Yes	No

Spate releases

Spate releases took place on 13 October 2009 (Blackbird Reservoir) and 14 October 2009 (Dipper Reservoir) in the month following the scour releases in Catchment 2. Invertebrate samples were collected from sites 7, 9, 11 and 12 (Figure 42). Figures 47 and 48 illustrate the changes to abundance of individuals per sample and the numbers of taxa per site pre and post release. Following the Autumn 2009 spate releases, abundance of individual macroinvertebrates increased at sites 7 and 12 and decreased at sites 9 and 11. No significant changes to numbers of individuals were detected using two-tailed t-tests.

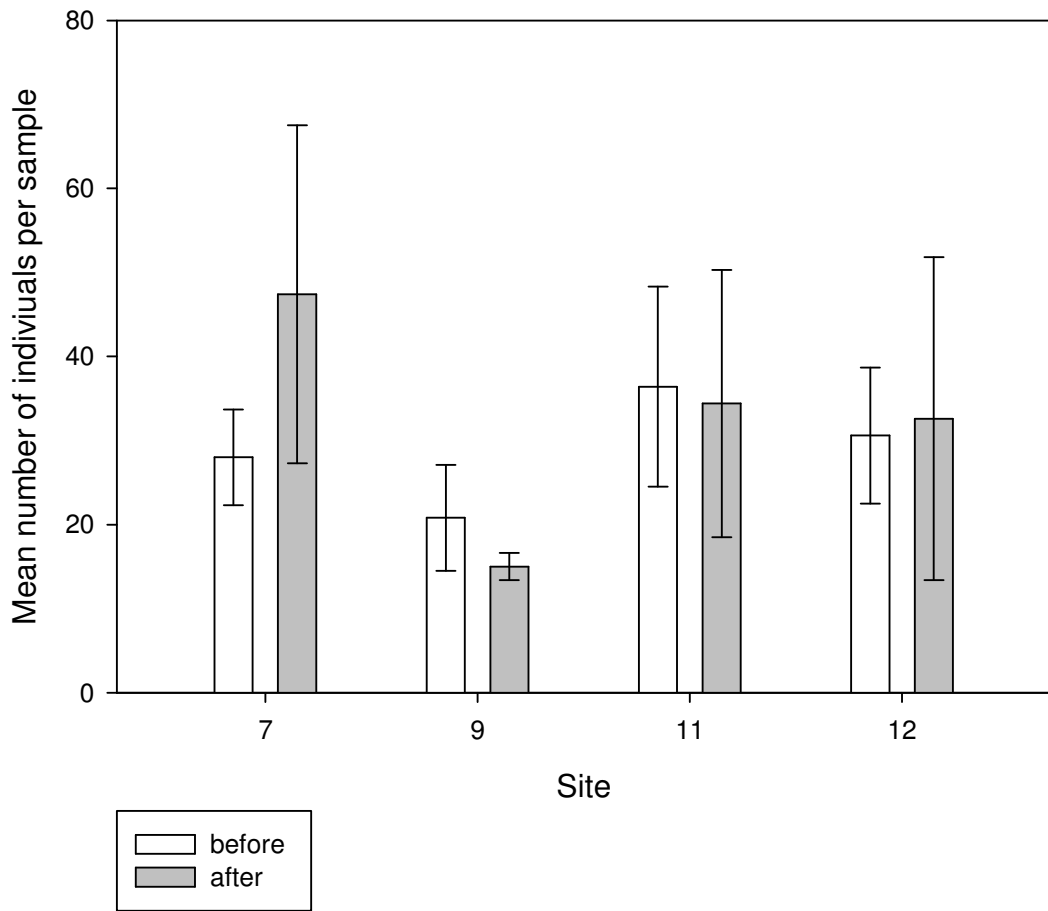

Figure 47: mean numbers of individuals per sample showing standard deviations before and after Autumn 2009 spate releases, Catchment 2. For site locations refer to Figure 31.

Family counts increased at the two upstream sites immediately below the reservoirs and decreased at the two sites below the confluence.

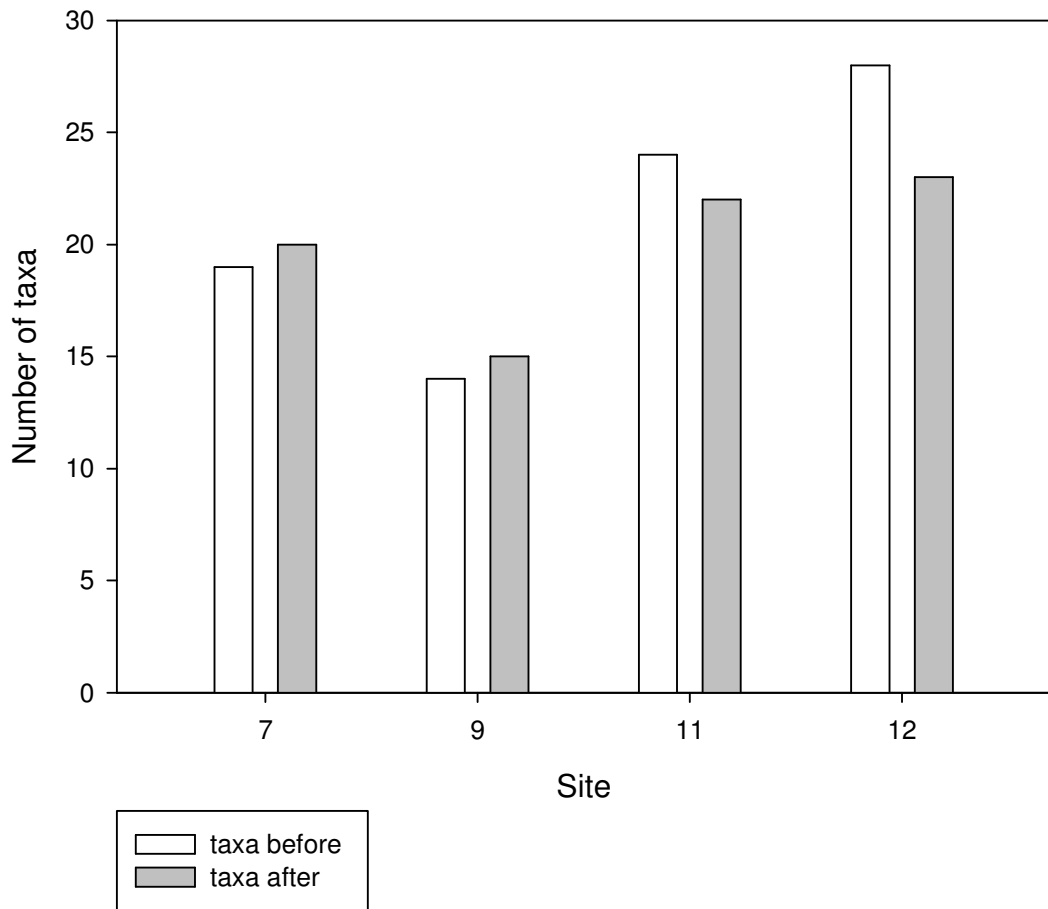

Figure 48: numbers of taxa found at each site before and after Autumn 2009 spate releases. For site locations refer to Figure 31.

Multivariate data

The data in Table 33 show no significant changes to the full data sets despite the marked increase in overall abundance at site 7. This site was slightly richer in most taxa rather than significantly richer in particular taxa, although Asellidae, Gammaridae and Hydracarina all increased noticeably. The change in the presence / absence at site 11 was once again due to the rarer taxa.

Table 33: ANOSIM analyses of community changes during Autumn 2009 spate releases

	Site	7	9	11	12
Full data	Global R	0.014	0.164	0.272	0.14
	p	43.7%	12.7%	5.6%	19%
	Significant change?	No	No	No	No
Taxa presence / absence data	Global R	0.138	0.068	0.242	-0.134
	p	16.7%	31%	4%	84.9%
	Significant change?	No	No	Yes	No

Recovery data

Following the Autumn 2009 spate events recovery samples were taken at 3 and 10 days after each reservoir release at sampling sites 7, 9, 11 and 12. Figures 49 and 50 show abundance and taxa counts during the recovery period. There are no consistent patterns to changes in overall abundance or taxonomic richness per site during the recovery period.

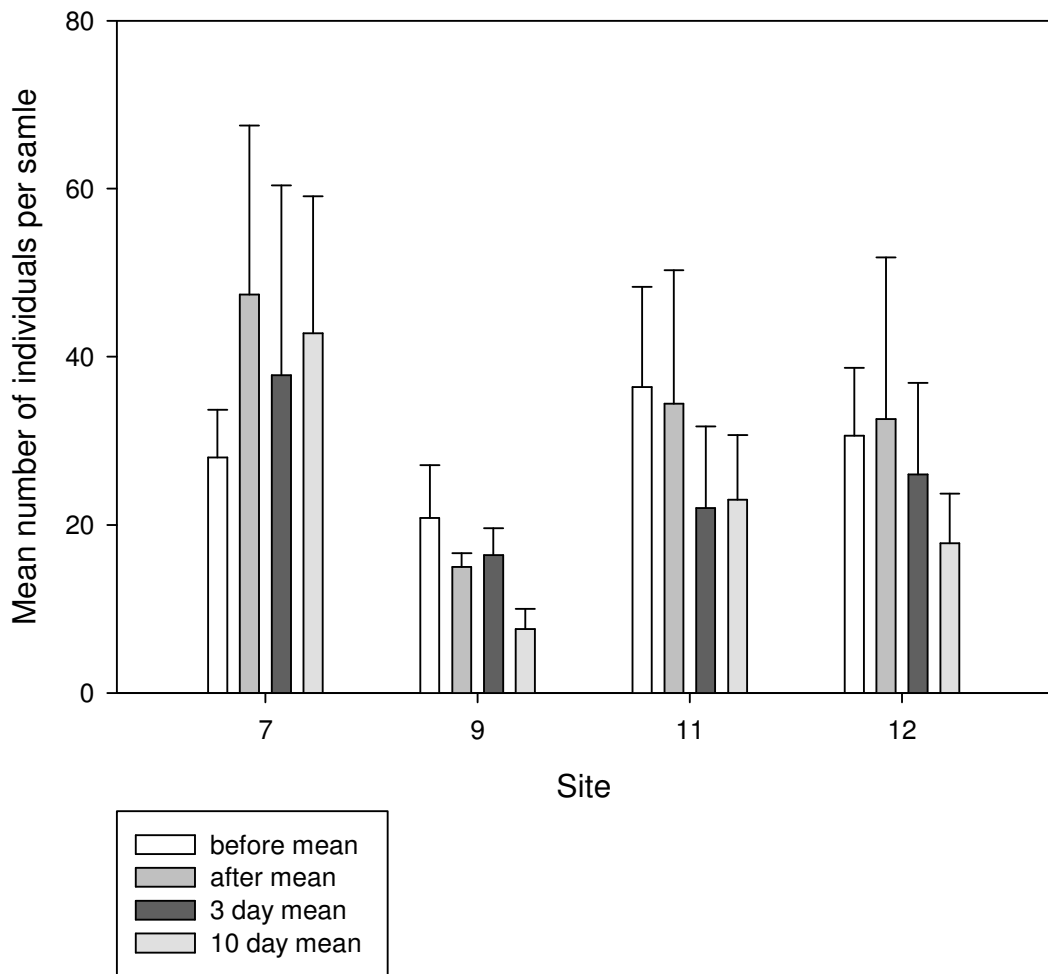

Figure 49: abundance of individuals during 10 day recovery period following Autumn 2009 spate releases. For site locations refer to Figure 31.

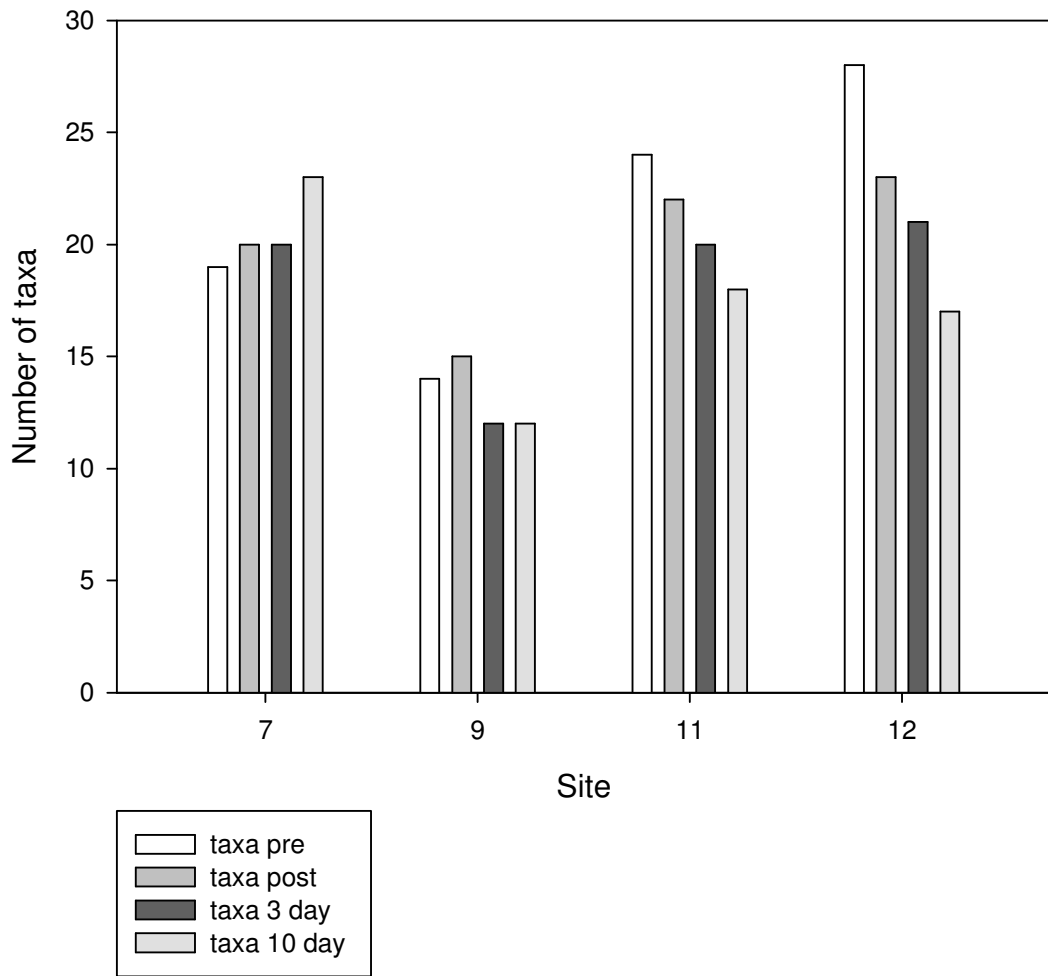

Figure 50: taxa counts during recovery period following Autumn 2009 spate releases. For site locations refer to Figure 31.

Following the spate releases the only significant difference that could be detected between any of the samples was seen at site 9, where the final sample was significantly different to the “pre” sample.

Table 34: significant community changes as defined by ANOSIM during the recovery period following the Autumn 2009 spate releases

Site	7	9	11	12
Pre scour to post scour	No	No	No	No
Post scour to 3 day	No	No	No	No
3 day to 10 day	No	No	No	No
Final sample different to pre sample?	No	Yes	No	No

5.3.5 Correlation of results with physical data

Although there is no metric of community change against which to measure the influence of single physical variables, the presence or absence of significant change can be plotted against the full suite of physical variables described in Section 5.2.4, allowing the identification of the most influential factors. Using the presence or absence of a significant ANOSIM result as a measure of the effects of the reservoir releases at each site, the MDS in Figure 51 illustrates the degree of physical similarity between the sites at which significant community change was recorded and those at which it was not.

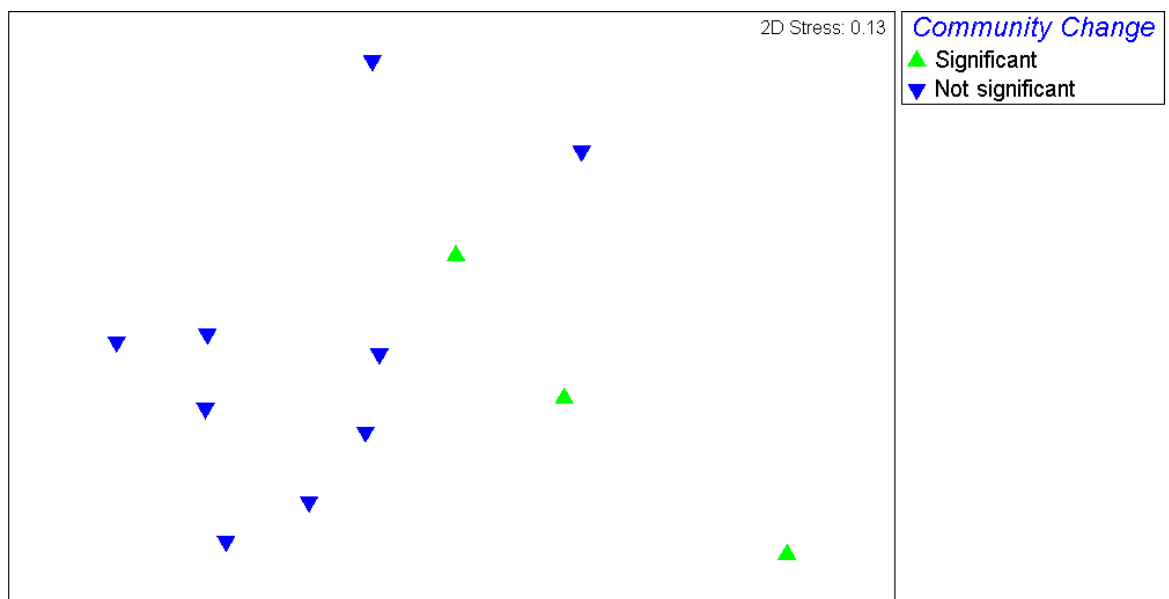

Figure 51: MDS plot demonstrating the physical similarity between sites with and without significant population changes

An ANOSIM (Section 5.2.6) shows the dissimilarity between the affected and unaffected sites to be significant (Global R 0.406, p 4.1%). A SIMPER (Section 5.2.6) routine shows that the factors contributing most to the dissimilarity between the sites are water velocity, contributing 16.11% of the difference, followed by the coverage of boulders (11.16%), average depth (10.21%), and coverage of cobbles (10.09%).

Using the percentage of the community lost during the releases as a single variable fails to produce any relationships with the physical variables, neither is percentage population loss a reliable predictor of significant community change, as sites 3, 7 and 10 all suffered losses similar in proportion to sites 1, 2 and 4, where the significant changes were seen but did not display significant changes to community make-up.

5.3.6 Summary of results

The scour tests in Catchment 1 caused a significant change to the invertebrate community at site 1 (Autumn 2008 and Spring 2009). Invertebrate abundance was diminished at some other sites, but ANOSIM tests failed to find significant differences between the sites before and after the reservoir releases. Neither the scour nor the spate releases in Catchment 2 had a significant effect on the invertebrate communities at any of the sites.

The recovery data showed that, at the most heavily impacted site (Site 1, Spring 2009), the community continued to change significantly in the 17 days following the scour release, with the “pre” sample and final recovery sample being more similar than the pre and post samples. Recovery samples at other sites did show significant differences from sample group to sample group in some instances, but none repeated the consistent changes seen at site 1. There was no overall pattern to changes in abundance and taxonomic richness in the period following the releases.

5.4 Discussion

The data clearly show that the scour releases had an effect upon the macroinvertebrate community at site 1 downstream of Whinchat reservoir in both Autumn 2008 and Spring 2009. Results at other sites show changes to both abundance and taxonomic richness, but the natural variation between samples is such that no other site shows a statistically significant change to community structure.

Despite site 1 being situated close to Whinchat reservoir outlet, the magnitude of impact is clearly not solely a function of proximity to the release site, as sites 3, 5, 7 and 9 were equidistant or nearer to the release site.. Nor is impact proportionate to magnitude of change in flow, as Dipper reservoir exhibited the greatest changes in flow but no impact was seen on its downstream fauna in either the scour or spate releases.

The multivariate analysis in Section 5.3.5 shows that water velocity (prior to release), depth, and the percentage cover of boulders are the three most important factors in predicting a significant change. The fact that depth and velocity contributed most strongly to change shows that impacts are likely to be greatest at sites with deep narrow channels where flow is unimpeded. These sites would seem stronger candidates to suffer from sediment scour during the releases causing involuntary invertebrate drift (Gibbins et al.

2007). The presence of boulders as a contributing factor is also unsurprising – bouldery habitats offer fewer refugia for macroinvertebrates than the more cobblely or gravelly habitats where interstices are more common, and the distance to these refugia from creatures feeding on the boulder surfaces will be greater. As the percentage of both cobbles and gravel increase, the likelihood of a site being impacted decrease. Similarly, in the more bouldery and fast flowing habitats it is more likely that the moss and algae upon and within which many of invertebrates live will be removed from the sheer surfaces in high flow.

Of the releases for which recovery data were taken, the impacted site (site 1, Spring 2009) shows the greatest change following the releases, with the community changing significantly from sample to sample over the following 17 days. Other sites showed change between sets of samples, but none showed post-release change comparable to the impacted site. This suggests that not only was the original ANOSIM assessment correct in identifying this as the most heavily impacted site, but also that the degree of change in the recovery period is determined by the degree of change caused by the release. Ecologically, this supports the theory that stable communities will see little change in structure over a given time period (Boulton et al. 1992), but a disturbance event such as the reservoir releases will provide sufficient disruption to allow increases in less abundant taxa or immigration of taxa not previously seen. The greater the degree of disturbance, the greater the opportunities for these taxa, hence the greater levels of change at the site which demonstrated the greatest original impact. As conditions stabilise following the scour release the MDS in Figure 41 shows the community structure moving closer to that seen prior to the scour, as the taxa most suited to the usual conditions at this site begin to dominate once more. This may also be due to the slow disappearance of taxa that have been washed in from the reservoir but are unsuited to life in the fast-flowing stream.

The general level of variation seen in the recovery samples presents a picture of general community variability rather than changes related to the scour release, and highlights the difficulty in indentifying a definite impact in macro-invertebrate communities (Milner et al. 2006).

It is clear from the SIMPER data that the taxa which contribute most heavily to the differences between before and after samples at the significantly impacted sites are the taxa

which were most numerous prior to the releases, notably the Nemouridae, Polycentropodidae, and to a lesser extent the other plecopteran families. This suggests that, contrary to expectations, all taxa are equally affected by washout at the affected sites, rather than more supposedly vulnerable taxa suffering a heavier impact.

The data show no response to either scour or spate releases in catchment 2, despite the large quantities of water released and change to algal and fine sediment cover. The fact that the scours failed to change the invertebrate communities significantly in these streams suggests that the communities may also have been capable of withstanding the longer lasting, higher volume spate releases and were possibly assisted by the step-wise increase in flow, as described in Imbert and Perry (2000). The expected loss of invertebrates due to the changes in algal and fine sediment cover and the volumes of fine suspended sediment in the water column may be compensated for by the general smaller particle size and wider, shallower channels in this catchment creating more interstices in the substrata and dissipating the power of the flow. This makes sense when compared to the heavily impacted Stream 1, with the narrower deeper channel and lesser proportion of smaller substrate particles.

There appear to be no seasonal affects associated with the scour releases, although two of the three significant impacts were recorded in the Autumn releases. Evolution in these streams has presumably prepared the biota to contend with spates through most of the year, and the numbers of organisms remaining even at the heavily impacted sites suggests that recovery time would be rapid at most times of year, as seen in the recovery at Site 1 in Spring 2009.

5.5 Conclusions

The data show that short-duration reservoir releases can change both the abundance and community make-up of benthic macroinvertebrate populations, and that the response of a population may be predicted by site characteristics rather than the magnitude of release or proximity to the release site. Hypothesis 1, that releases from upland Yorkshire reservoirs decrease benthic macroinvertebrate abundances immediately downstream of the reservoirs has been shown to be correct in some situations. Insufficient impacts were recorded to accurately judge hypothesis 4, that impact will decrease with distance from release point,

however given that the force of the release wave decreases with distance from the reservoir this would still appear logical. Similarly, hypothesis 3, that scour releases will have a greater impact than spate releases also remains unproven, as neither type of release in Catchment 2 had a measurable impact.

The data also show that even at the more heavily impacted of these particular sites a substantial quantity of all the major taxa remain in the substrate following the releases and recovery and re colonisation are rapid. Hypothesis 2, that certain taxa are more vulnerable to displacement by such flows is not proven. Although at a number of sites losses of certain taxa (typically Nemouridae) were responsible for the overall community change, at other sites the changes were seen as a general loss amongst all taxa.

It is likely that impacts may be much greater at other similar sites if the channel morphology or capacity for release differ, but neither scour nor spate releases appear to have any long-term harmful effects on macroinvertebrate populations at these particular sites. It may be that in drier years such as 2009, or in more heavily abstracted catchments where over-spilling events are rare such as in Catchment 2, these releases provide an element of disturbance that would otherwise be provided by the natural floods which the impoundments are preventing. It is also possible that, as with brown trout, the releases mimic natural floods sufficiently well to trigger important physiological changes in certain taxa, and certainly likely that the flushing effects renews interstitial habitats for a substantial number of these stream-dwelling organisms.

As the spate releases fail to cause any catastrophic drift, or even any detectable wash-out in the invertebrate communities and appear to enhance the habitats downstream for both invertebrates and fish it is recommended that these continue. Caution should be applied when introducing spate flows to a new site as site characteristics may not be so favourable and alternative sites less resilient. An examination of the channel morphology and an examination of the effects of the mandatory scour releases are recommended before introduction at future sites, along with an assessment of the particular reservoir's water quality.

Chapter 6: Brown trout responses to reservoir releases

6.1 Introduction

This chapter examines the responses of the brown trout *Salmo trutta* to the reservoir releases using PIT tracking technology to record the movements of individual fish. The chapter examines the hypothesis that brown trout make unusual movements in response to reservoir releases, either by migrating upstream or downstream, or being washed downstream during the enhanced flows.

6.2 Methodology

6.2.1 Tracking fish movements

Several methods are available to track fish movements, including capture independent methods such as visual observations or hydro-acoustic techniques, or capture dependent methods such as catch-per-unit-area electric fishing, capture-mark-recapture methods, or telemetry by tagging (Lucas and Baras 2000, Lucas and Baras 2001). For this study it was necessary to be able to record the movements of known individual fish, to be able to record the movements of several fish at once and to be able to track fish movements during the reservoir releases. Observational and hydro-acoustic methods were not suited to this type of work as they could not reliably track individual fish in these conditions, nor are they suited to turbulent and turbid streams. Capture-mark-recapture methods such as using Visible Elastomer Implants (Roberts and Angermeier 2007, Bolland et al. 2009, 2010) were unsuitable for studying responses to these releases due to the time taken to locate and capture fish before and after releases, and the possibility that no marked fish may be recaptured. Although radio and acoustic telemetry allow the operator to follow fish movements at any given time with minimal disturbance (Thorstad and Heggberget 1998, Ovidio et al. 2000, Enders et al. 2007, Hegggenes et al. 2007), the number of fish that can be tracked at one time is limited by the number of operators and the equipment available, as well as by the cost of the radio tags. Although Passive Integrated Transponder (PIT) telemetry (Lucas et al. 1999, Gibbons and Andrews 2004, Zydlewski et al. 2006) is reliant on the tagged fish passing through fixed-point detection stations or the operator detecting the fish at close range (typically less than 1m) with a mobile detector, it has the advantage of offering constant recording at the fixed stations, and is ideal for detecting mass-movements such as upstream migrations or downstream washout. The relatively cheap

PIT tags also allow the tagging of several hundred fish. PIT telemetry was therefore employed in this study.

PIT tags consist of an individually coded microchip and copper coil encased in a cylindrical glass or plastic housing and can be as small as 10mm * 2mm. However smaller tags have a reduced detection range compared to larger ones (Cucherousset et al. 2005, Zydlewski et al. 2006, Connolly et al. 2008, Cookingham and Ruetz III 2008, Riley et al. 2010), so tag choice is determined both by the size of the target fish and by the required range of detection. For this study it was felt that 23 mm tags would provide a sufficient detection range (up to 100 cm, dependent upon detection loop configuration (Roussel et al. 2000, Hill et al. 2006, Linnansaari et al. 2007)) while still allowing the tagging of trout larger than ca. 10 cm in the two target catchments.

PIT tags carry no charge (hence: passive) and are only activated when they pass within range of a transmitting antenna, which induces the coil to transmit the tag's individual code (Lucas and Baras 2001, Gibbons and Andrews 2004). The code, and time and date of transmission are recorded and stored. If an upstream and downstream antenna are placed across the stream channel at a fixed PIT station it is also possible to derive the direction of movement, determined by the timing of the detection of the fish at each antenna.

Two types of detection system are available, full duplex or half duplex. Half duplex systems generate a pulsed radio frequency field, with the tag transmitting back its identity between pulses. Half duplex systems can typically interrogate at rates of up to 14 times per second. Full duplex systems transmit continuously and can typically read tags at a rate of 32 times per second (Lucas and Baras 2001, Zydlewski et al. 2006), however half-duplex systems have the advantage of greater detection distances due to reduced noise sensitivity (Haro 2002).

As the tags are passive they last longer than the lifetime of the fish, and are unlikely to be damaged once implanted into the fish's body cavity. Twenty-three mm tags have been successfully used in salmonids as small as 64 mm fork length. However, mortality of tagged fish occurred in fish between 64 mm and 84 mm (Roussel et al. 2000), and generally only fish larger than 84mm are tagged with 23mm tags (Zydlewski et al. 2001,

Roussel et al. 2004, Hill et al. 2006, Stickler et al. 2008). Unlike studies in which external tags are used (Lucas and Baras 2000, Lucas and Baras 2001) behavioural changes are rarely recorded in PIT tagging experiments, one exception being an impeded swimming ability in tagged Chinook salmon *Oncorhynchus tshawytscha* with fork lengths below 120 mm (Adams et al. 1998).

A number of studies on the effects of tagging on trout mortality, growth and behaviour (Acolas et al. 2007, Bateman et al. 2009, Dieterman and Hoxmeier 2009) have shown that intra-peritoneal PIT tags are generally well retained in the body cavity (retention rates of up to 100% after 12 months), although they are eventually encapsulated in the body tissue and may be expelled either through the gastro-intestinal tract or the body wall (Gheorghiu et al. 2010). Expulsion rates appear to be higher in younger fish, with smaller fork lengths than those of the fish tagged in this study (Acolas et al. 2007). Further studies show that where effects on growth and survival are recorded, it is again the smaller fish that suffer (Ombredane et al. 1998, Jepsen et al. 2008) .

Movement of tagged fish can be recorded either by fixed position antennae placed strategically across the river channel, often in constrained parts of the channel such as fishways or culverts (Castro-Santos et al. 1996, Lucas et al. 1999, Zydlewski et al. 2001, Zydlewski et al. 2006, Connolly et al. 2008) or by locating the fish with a mobile antenna fixed to a backpack (Roussel et al. 2000, Zydlewski et al. 2001, Bubb et al. 2002, Roussel et al. 2004, Hill et al. 2006, Linnansaari et al. 2007).

6.2.2 Site selection

Maps of catchments 1 and 2 showing locations of PIT detection stations appear in Figures 52 and 53, below.



Figure 52: 1:25000 map of Catchment 1 showing PIT tag recording stations

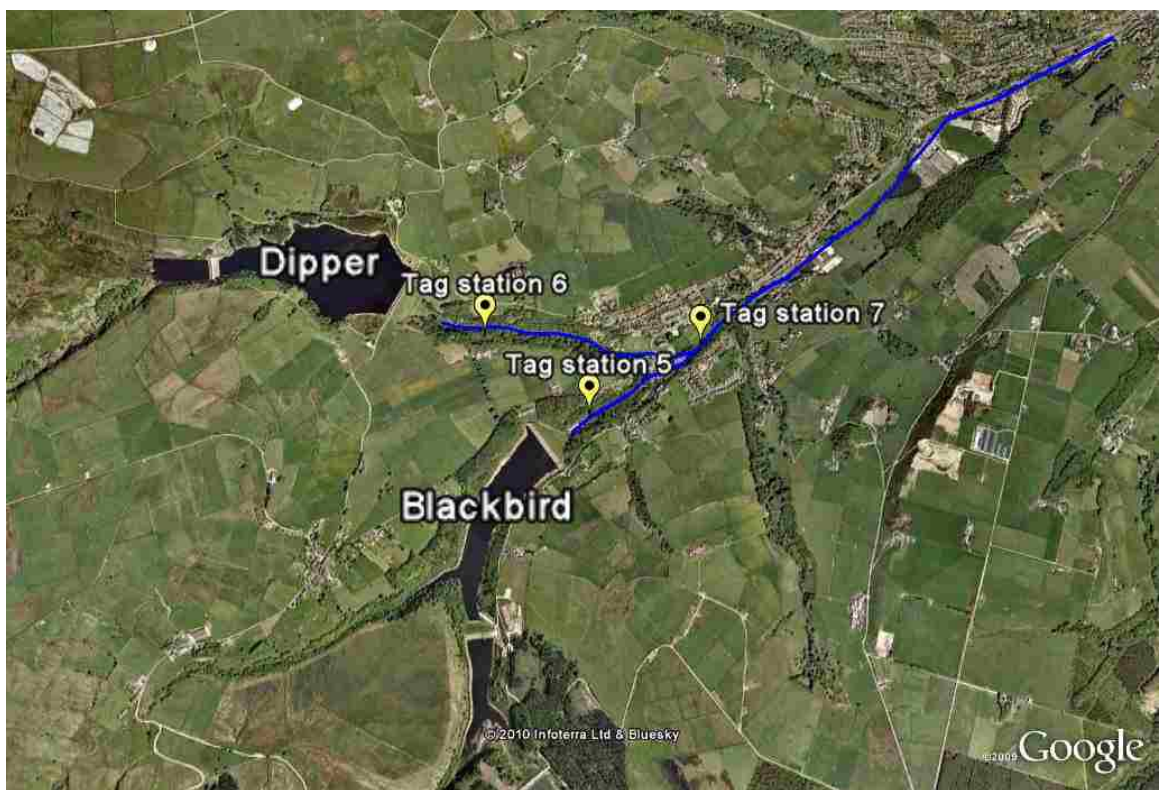

Figure 53: 1:25000 map of Catchment 2 showing PIT tag recording stations

Site selections for the experiments and the positioning of the PIT detectors were partly determined by practicality, as they had to be accessible for regular changing of heavy batteries, and in areas with a suitable channel size and shape to allow construction of efficient stations. They also required a sufficient density of suitably sized fish for tagging (determined from Environment Agency data, personal observations, and trial electro-fishing) and had to be sufficiently hidden from public view to avoid interference or vandalism. A final requirement was a lack of barriers to fish passage between the stations in each catchment that would prevent the detection of any longer range migratory or wash-out effects. In both catchments sites were chosen to be near enough the reservoirs for large changes in flow to be observed during the reservoir releases. In each catchment a downstream site distal from the point of release was also used both to test the hypotheses that fish from downstream may swim upstream in response to the increased flows, or that fish from upstream move downstream, voluntarily or otherwise. The downstream sites were also used to investigate the possibility that responses may be lesser further from the release sites, where some of the energy from the release has dissipated. Following the lack of response from the fish in catchment 1 in Autumn 2008 (Section 6.4.1), sites closer to the reservoirs were used in catchment 2 (Figure 53) to allow maximum exposure to changing flows. Distances of each of the recording stations from their upstream reservoir(s) are shown in Table 35.

Table 35: reservoirs upstream of PIT recording stations and distances of stations from reservoir outflows

Site	Catchment	Upstream reservoirs	Distance from outflow (m)
1	1	Wagtail Lower	750
2	1	Whinchat	1293
3	1	Greenshank, Whinchat	1315 (Greenshank), 3291 (Whinchat)
4	1	Wagtail Lower, Whinchat, Greenshank	1954 (Wagtail Lower) 2015 (Greenshank) 3991 (Whinchat)
5	2	Blackbird	52
6	2	Dipper	161
7	2	Blackbird, Dipper	503 (Blackbird) 986 (Dipper)

6.3.3. Fish tagging

Brown trout were tagged at each site on the dates shown in Table 36 below.

Table 36: dates of fish tagging and numbers of fish tagged at each site

Site No.	1	2	3	4	5	6	7
Tagging date	31 Aug 2008	18 Sep 2008	19 Sep 2008	01 Sep 2008	08 Sep 2009	08 Sep 2009	08 Sep 2009
No. fish tagged	33	68	51	69	46	27	45

Fish were captured by electric fishing with pulsed current, using an Electracatch control box and bank-side 1KVA Honda generator. At sites 1 to 6 sections of between 40 and 100 m were fished upstream and downstream of the tag detection stations. The length of river fished at each site varied depending on the apparent density of fish, in order to provide an adequate sample (>25 fish). For example, site 1, where fishing was difficult due to high flows and highly coloured water, and fish appeared to be scarce, was much longer than site 5, where fishing was easy, the water was low and clear, and fish were numerous. At site 7 fish were only captured upstream of the detection station due to access and site positioning difficulties. No fish were captured within 5 m of detection stations at the Catchment 1 sites (1 to 4) to avoid tagging fish that may be resident at the antenna loops and therefore create large numbers of repeat readings without making movements. This effect can also reduce the efficiency of detection of other tags (Haro 2002). Following the lack of detections at the Catchment 1 sites, this rule was discarded for sites 5 to 7, in Catchment 2.

Once captured, fish were retained in keep nets in flowing water in a shaded location several tens of metres from the continuing electro-fishing. Prior to tagging fish were anaesthetised using tricaine methane-sulphonate (MS-222) at 0.1 g L⁻¹. The weight and fork length (FL) of each fish was then recorded. Any fish under 110 mm FL was discarded at this point as being below the ideal size for tagging (Section 6.2.1) and placed in a recovery tub of stream water. A 4 mm incision was made into the peritoneal cavity anterior to the pelvic fins of the remaining fish using a sterile scalpel. A tag was then removed from sterile casing and inserted through the incision. 23 mm PIT tags were used (half-duplex, Texas Instruments model RI-TRP-RRHP, 23.0-mm long x 3.4-mm diameter, 0.6 g in weight, 134.2 kHz, RFID components Ltd, Bedford, UK). Incisions in the smaller

fish (<14 cm) were then closed with a single absorbable suture. Tagging was carried out by M. Lucas under Home Office licence. The identity of each tag was recorded using a hand-held tag reader and recorded for each fish along with the fish's length and weight data. Fish were then placed in the recovery tub and left in the shade to recover. Water in this bucket was stirred and changed regularly to maintain oxygen levels. Following recovery fish were released as near as possible to their capture sites to minimise disturbance and reduce unnecessary movements. At the Catchment 1 sites (Figure 52) as well as site 5 in Catchment 2 (Figure 53) fish caught upstream and downstream of the recording station were kept separate and released close to the middle of their original ranges. At sites 6 and 7, where the stations had not yet been installed and fishing reaches were short (80 m) no distinction was made between upstream and downstream fish and all were released close to the middle of the site. A summary of the weight and length data from each site appears in Table 37.

Table 37: weight and fork length summaries for brown trout tagged at each site

Site number	No. fish tagged	Mean weight (g) ± SD	Mean fork length (mm) ± SD	Min – max weight (g)	Min – max fork length (mm)
1	33	50 ± 24	158 ± 27	18 – 112	113 – 210
2	68	39 ± 15	152 ± 21	17 – 94	112 – 201
3	51	46 ± 19	158 ± 22	18 – 92	120 – 208
4	69	44 ± 20	153 ± 23	18 – 106	113 – 207
5	46	116 ± 180	191 ± 81	19 – 848	123 – 459
6	27	30 ± 15	140 ± 21	12 – 71	106 – 184
7	45	49 ± 29	153 ± 30	15 – 120	110 – 215

Scale reading data from the Environment Agency from Autumn 2007 (unpublished) shows these fish to be between 1 and 3+ years old, i.e. parr to adults. (Table 38).

Table 38: Environment Agency length to age data for Catchments 1 and 2 from Autumn 2007

Catchment	0+ mean length (mm)	1+ mean length (mm)	2+ mean length (mm)	3+ mean length (mm)
1	69	129	169	214
2	59	128	187	230

Permanent tag detection stations

The PIT detection stations were based on those described in Zydlewski et al.(2001) and similar to stations described in Castro-Santos et al (1996), Zydlewski et al. (2006) and Connolly et al (2008). Each station consisted of two antenna loops (one upstream, one downstream, separated by approximately 1.5 to 5 m to allow recording of the direction of movements and run as master and slave to minimise interference between loops). The

antennae consisted of 4 – 6 mm diameter linear crystal oxygen free copper Hi-Fi speaker cable, and were attached to half-duplex reader boxes (TIRIS RI-RFM-008) run from a TIRIS control box (TIRIS RI-CTL_MB2A). The stations were powered by two 12V 120 Ah deep cycle leisure batteries. Batteries were connected in parallel giving an operational life cycle of up to 5 days, dependent upon loop configuration and the read-rate used (see below).

Each antenna ran in a single loop from the control box along the river bed and back across the channel at a height deemed sufficient to avoid high flows but no greater than 110 cm, to prevent tags passing undetected through the centres of the loops. Bank-to-bank widths of antenna loops varied from approximately 1.75 m to 6.5 m, depending on channel morphology at the chosen sites. Loops were positioned to allow free fish-passage in the river-channel, but to prevent fish movement round the outside of the loops.

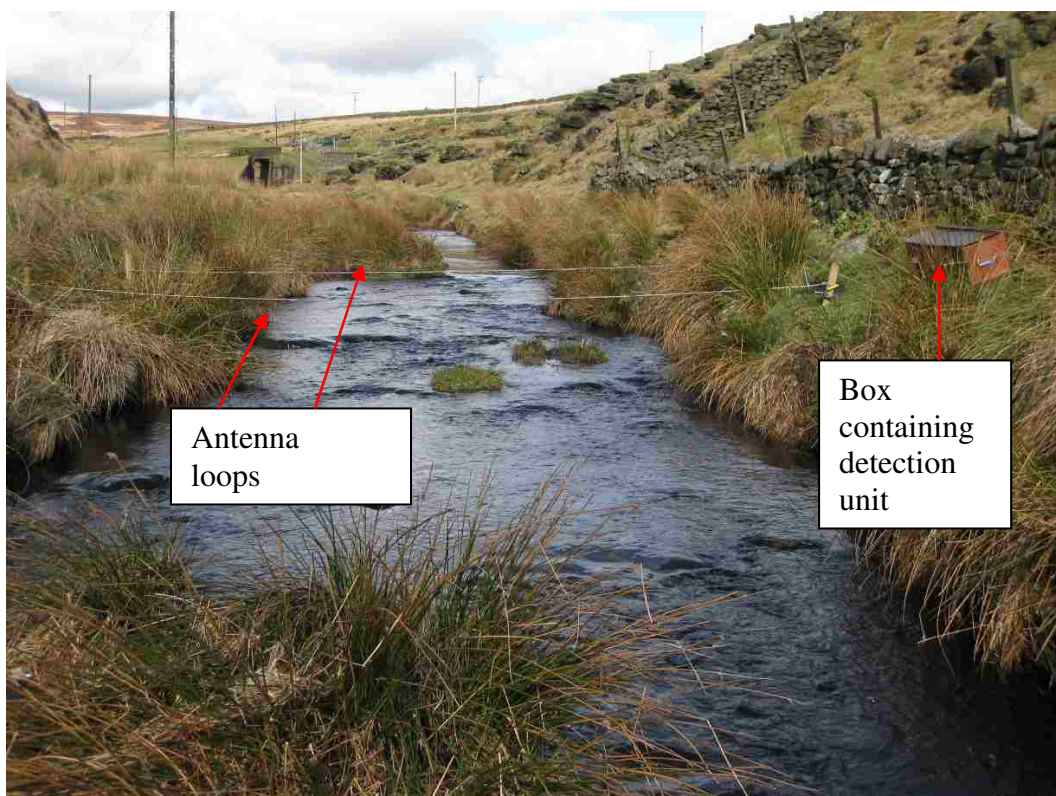

Figure 54: PIT antenna loops and box containing detection station, site 2

Control boxes were attached to flash-card writers (Flinka Fiska, Sweden), and recorded time and date and identity of tag detections, as well as direction of movement provided a tag was detected at both upstream and downstream antennae. The control box was set to

interrogate eight times per second and detected 100% of approximately perpendicularly aligned tags at a distance of up to 0.5 m and the majority of tags up to a distance of 1 m from the transverse plane of the antenna, theoretically allowing detection of a tag passing through at up to 16 m sec^{-1} . Maximum recorded water velocity in the monitoring period was 1.78 m sec^{-1} and maximum brown trout swimming speed found in literature is 1.26 m sec^{-1} for trout no larger than 8 cm (Tudorache et al. 2008) or 440 cm sec^{-1} for fish of unspecified body size (Hynes 1970). It was therefore unlikely that a fish could pass through the loop too quickly to be detected.

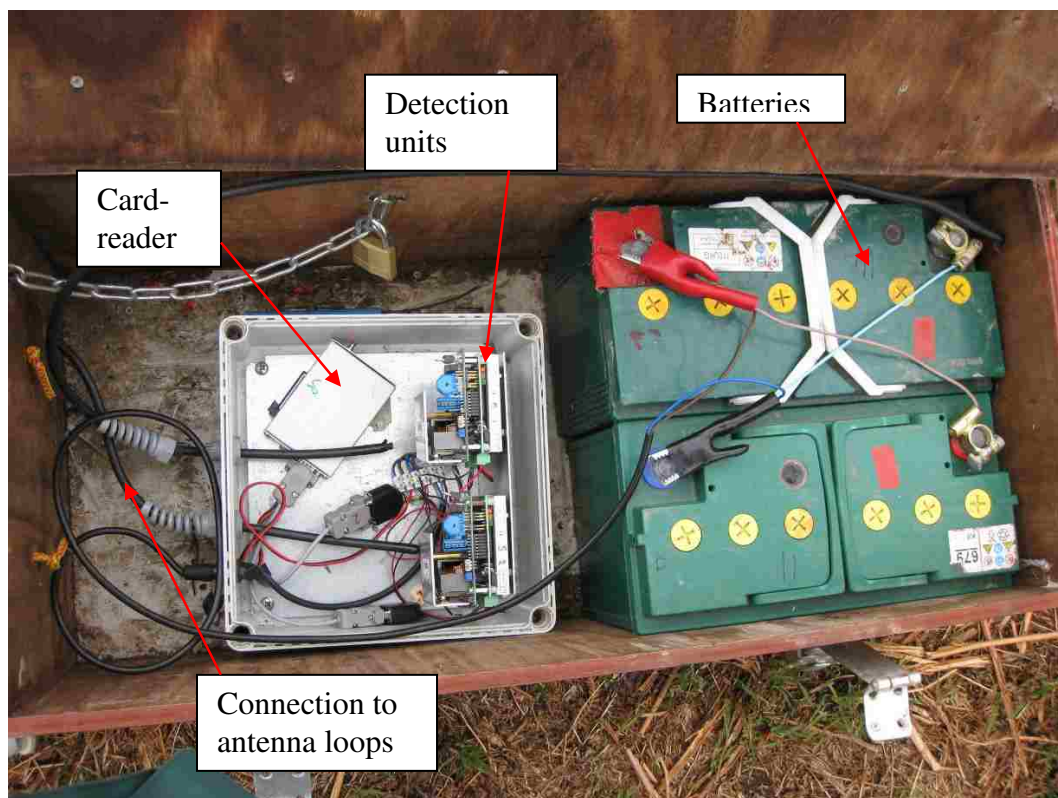

Figure 55: PIT tag detection station components

Data were downloaded from the flash cards each time the batteries were changed (every 2 to 5 days). The data were converted to a text file using Flinka Fiska Split-time 2 software. At each change of batteries the detection ability of each antenna was tested by passing a tag of known identification number through the loop immediately after inserting and immediately prior to removing the flash cards. At the Catchment 1 sites (1 to 4) where very few detections were recorded efficacy of the stations was also tested by floating a tag through the loop in the fastest part of the stream each time data were downloaded to provide proof that any passing tags would be recorded. At no point were any recording difficulties found.

The stations were active for the periods shown in Table 39, below. Antenna loops at sites 1 and 3 had to be removed during the flood in the first week of September 2008, and could not be replaced until 16 September 2008 due to continued high flows. This prevented any fish data from being recorded during the Greenshank release on 10th September.

Table 39: operational dates for stationary PIT recorders

Station	Autumn 2008	Spring 2009	Autumn 2010
1	31 Aug 08 to 06 Sep 08, 16 Sep 08 to 06 Oct 08	16 Mar 09 to 03 Mar 09, 10 May 09 to 16 May 09	N/A
2	18 Sep 08 to 06 Oct 08	16 Mar 09 to 03 Apr 09, 10 May 09 to 16 May 09	N/A
3	22 Sep 08 to 01 Oct 08	16 Mar 09 to 03 Apr 09, 10 May 09 to 16 May 09	N/A
4	01 Sep 08 to 06 Sep 08, 16 Sep 08 to 01 Oct 08	16 Mar 09 to 03 Apr 09, 10 May 09 to 16 May 09	N/A
5	N/A	N/A	10 Sep 09 to 21 Oct 09
6	N/A	N/A	11 Sep 09 to 21 Oct 09
7	N/A	N/A	10 Sep 09 to 21 Oct 09

Mobile Tag Detector

The mobile detector employed in this study has previously been used in Bubb et al (2006) and Bolland (2008) and was similar in design to those described in a number of other studies (Roussel et al. 2000, Zydlewski et al. 2001, Hill et al. 2006, Linnansaari et al. 2007, Cookingham and Ruetz III 2008). The detector consisted of a tuned multiple loop antenna cable wound round a supporting plastic loop attached to a retractable 2 m carbon-fibre pole, linked to a reader-unit and 12V gel-battery in splash-proof casing carried on a back-pack frame. The reader unit was attached to a Texas Instruments palm-top computer running a logging program (Haro, 2002) which emitted an audible beep through an earpiece and displayed tag identity number and time of detection each time a tag was detected. The mobile unit had similar detection capabilities to the stationary antenna, detecting tags through water at a maximum distance of approximately 1 m when the tag's

axis was perpendicular to the loop's flat plane. Field trials with hidden stationary tags showed the unit could detect through wood and stone, as found in Linnansaari et al (2007), but seemed to have more limited ability through a concrete overhang at site 5, possibly due to steel reinforcing disturbing the electro-magnetic field. In clear water trout positions could be located precisely, but in deeper water, faster water or more coloured water tags could only be located with certainty to within a one metre diameter circle centred on the perceived point of strongest detection.



Figure 56: mobile PIT tag detector

The detector was carried up the stream course beginning at the downstream end of survey sites (to minimise disturbance, assuming most fish were facing upstream) and the antenna swept just above the water surface, approximately 1 m in front of the surveyor. The surveyor moved slowly upstream sweeping the antenna from side to side and attempting to cover the whole stream bed. In deeper water or in situations where a more precise location was required the loop was swept under the water. In situations where a tag did not appear to move, sediment was disturbed around the tag location until movement was detected to ensure that tags were still implanted and that tagged fish were still alive. Surveying was easier in shallower, slower, clearer water where visibility was good and footing steadier, and detection success appeared to be higher at these sites.

On two occasions (Autumn 2008 in Catchment 1 at sites 1 and 3 and Autumn 2009 in Catchment 2 at site 5) efficiency of the detector with live tagged fish was tested by first sweeping a stop-netted 50 m section of stream with the detector then electric fishing the sites with three passes. Detection efficiencies for these two sites appear in Table 40, below.

Table 40: estimated efficiencies of the mobile detector when compared to electro-fishing catches

Site	No. tags detected	No. tagged fish caught	Estimated efficiency of mobile detector (%)
1	3	4	75
3	3	5	60
5	11	8	100

Trials at sites 1 and 3 were hampered by high flows and turbid water producing difficult fishing and detecting conditions, and failed to produce a depletion of catch at site 3 by the third pass. Environment Agency regulations prevented a further pass. At site 3 one tag code was detected that escaped the electro fishing. At site 5 three more fish tags were detected than tagged fish caught, possibly due to the difficulty of catching fish under a concrete overhang through which the detector regularly picked up tags. A further measure of efficiency was provided at site 6, the easiest to survey with the detector, at which >85 % of the fish originally tagged were detected and found regularly.

The mobile detector was initially used following the floods in September 2008 to ensure that sufficient tagged fish remained in the study area to allow continued viability of the study. However, as the study developed and it became apparent that fish movements were far more limited than initially suspected the mobile detector was used to locate individual fish immediately prior to and following the reservoir releases in Spring 2009 and Autumn 2009. In addition the mobile unit was used to locate individual fish in order to record habitat usage in both catchments, and also to record fish locations several times per week in the period around the Autumn 2009 releases in order to attempt to estimate home range sizes and determine whether the minor movements recorded were outside of the fishes' usual activity patterns. Every survey with the mobile PIT detector began 30 m downstream of the original tagging area and continued 30 m upstream from the top of the tagging area, and was conducted in an upstream direction in order to minimise disturbance to upstream-facing fish. Additional survey runs were conducted at intervals covering areas outside the original tagging areas to attempt to find fish that had strayed from their original

locations. These runs typically extended the sweeps by 100 m at either end of the original tagging sites in Catchment 1, and covered the entire area between the downstream site (7) and upstream sites (5 and 6) in Catchment 2. Fish often sought refuge under banks or boulders and appeared immobile. Surveys could only be conducted in daylight hours (earliest start time 07:30, latest 17:00) and were stratified so that each site was surveyed at as wide a variety of times as possible. Dates and locations of sweeps appear in Table 41, below.

Due to the lack of movement through the fixed stations in the Spring 2009 monitoring period the mobile detector was used along with a Leica Differential Global Positioning System (dGPS) to locate and map the positions of individual fish in order to demonstrate by repeat detections that fish were not moving through the loops undetected. During the Autumn 2009 releases in Catchment 2 the dGPS could not be used due to the lack of satellite coverage in the deep, heavily wooded valley. Instead fish positions were recorded on 1 in 500 maps on which major features such as boulders, trees, riffles and pools were marked. When using the mobile detector prior to and following each reservoir release searching began approximately 90 minutes before the release valves were opened and continued until 10 minutes before the release began. Due to high flows it was not possible to work in the river during the releases. Post-release scanning began as soon as the water levels were low enough to allow safe working, typically within 10 minutes of the valve closing. In the case of the spate releases this meant fish could be located during the “tail-off period” while the release was still continuing but flows were decreasing. On release days it was only possible to search sites nearest to the release points due to time constraints. However downstream sites were searched as soon as possible after the releases and in Catchment 2 the stretches of stream between site 7 and sites 5 and 6 were searched on the days following releases to locate fish that may have been washed downstream or swum upstream.

Table 41: dates and locations of mobile detector surveys

Site	Date	Description
4	11 Sep 08	Site + 30 m
1	16 Sep 08	Site + 30 m
1	08 Oct 08	Site + 30 m
2, 4	09 Oct 08	Site + 30 m
1, 3	10 Oct 08	50 m netted and electro-fished with HIFI in full
2, 4	21 Jan 09	Site + 30 m
3	12 Feb 09	Site + 30 m
1, 3	18 Feb 09	Site + 30 m
2	20 Feb 09	Site + 30 m
3	18 Mar 09	Site only
1	25 Mar 09	Site only
2, 4	01 Apr 09	Site only
2	12 May 09	Site only
2	22 May 09	Site + 30 m
5, 6, 7	10 Sep 09	Full catchment from 30 m downstream of site 7.
5,6	11 Sep 09	Site + 30 m
5, 6	12 Sep 09	Site + 30 m
5, 6	13 Sep 09	Site + 30 m
5, 6	14 Sep 09	Site + 30 m
5, 6	15 Sep 09	Site + 30 m
5, 6	16 Sep 09	Site only
5, 7	17 Sep 09	Site + 30 m
5, 6	19 Sep 09	Site + 30 m
5, 6	20 Sep 09	Site + 30 m
5, 6	21 Sep 09	Site + 30 m
5, 7	22 Sep 09	Site + 30 m
5, 7	23 Sep 09	Site only
5, 6	24 Sep 09	Site + 30 m
5, 6	27 Sep 09	Site + 30 m
5, 6	29 Sep 09	Site + 30 m
5, 6	30 Sep 09	Site + 30 m
6, 7	02 Oct 09	Site + 30 m
5, 6	05 Oct 09	Site + 30 m
5	06 Oct 09	Site + 30 m
6	08 Oct 09	Site + 30 m
5, 6	09 Oct 09	Site + 30 m
7	11 Oct 09	Site + 30 m
5	12 Oct 09	Site + 30 m
5	13 Oct 09	Site only
6	14 Oct 09	Site only
5, 6, 7	15 Oct 09	Site + 30 m
5	09 Mar 10	Site + 30 m

6.3.4 Fish habitat measurements

In Autumn 2008, Spring and Autumn 2009 the mobile detector was also used to detect fish locations in order to enable microhabitat measurements around individual fish to be taken. Fish were located at sites 1, 2, 5 and 7. Depth and velocity measurements were recorded as close as possible to the actual fish location and at the four points of a one metre square centred on the fish position. In addition to depth and velocity measurements, recordings

were also taken of substrate type (visually estimated percentages of sand, gravel, cobbles, boulders, bedrock and manmade), percentage cover of moss, algae and macrophytes, percentage cover and type of any overhanging vegetation, distance from either bank, distance from thalweg, and morphology of river bank (straight, sloped, undercut). The same measurements were taken at 10 m intervals throughout the tagging sites (see Chapter 5). These data are examined in Chapter 7.

6.3.5 Recruitment success

In an attempt to measure the effects of introducing spate flows on brown trout recruitment the Environment Agency targeted sites below Dipper and Blackbird reservoirs in Catchment 2 (Figure 53) for annual electric fishing surveys conducted in September of each year from 2000 to the present. Spate flows were introduced in Autumn 2004. Fifty metre sections of stream within tagging sites 5 and 6 were stop-netted and fished with a triple pass. All captured fish were measured and divided into classes; fry (0+), <20 cm fork length, and >20 cm fork length. Densities were estimated using the depletion method (Mahon 1980, Edwards et al. 2003).

6.4 Results

Throughout the following sections the numbers of individual fish detected at each station per day is used as a measure of overall fish movement. At the stations with most detections, tags were detected by the antenna thousands of times a day, but the vast majority of these detections were made by a small number of fish resident close to the antenna. Despite this, the use of test tags showed that the proximity of resident fish had negligible effect on the detection of other tags. Similarly, high numbers of upstream and downstream movements were recorded each day at the stations at which a single fish or small number of fish were resident. It was therefore felt that the numbers of different fish detected at each station per day provided the best estimate of overall fish movement, and would increase dramatically if a migration or washout associated with a reservoir release occurred.

6.4.1 Scour releases, Catchment 1, Autumn 2008

The locations of the field sites used in Autumn 2008 and Spring 2009 in Catchment 1 appear in Figure 57, below.

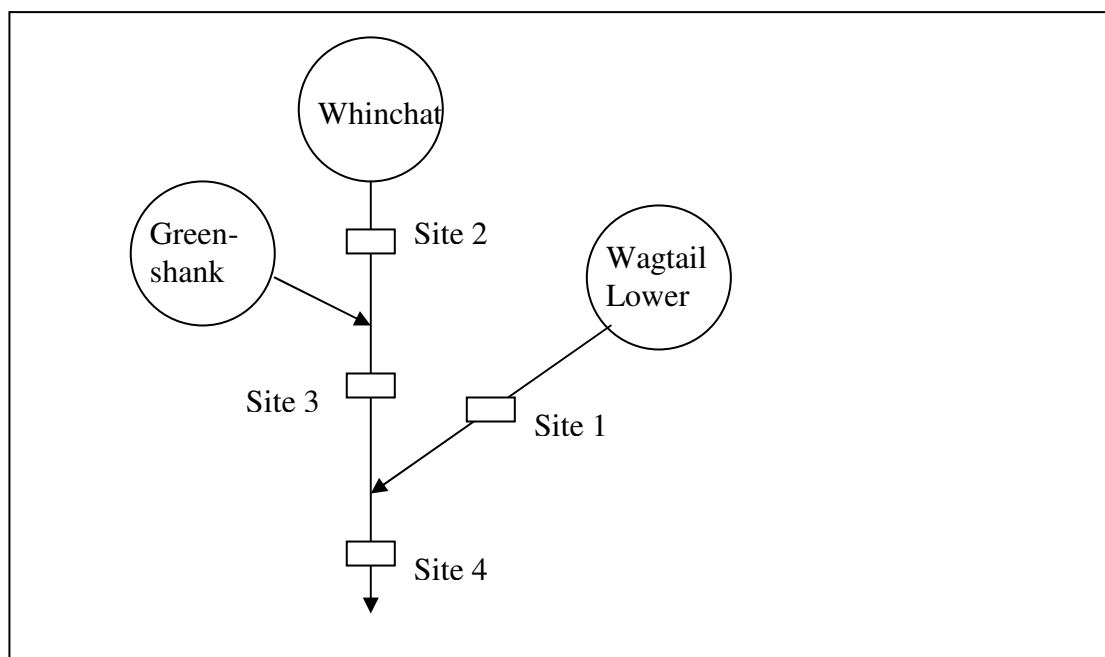

Figure 57: locations of PIT detection stations in Catchment 1

Due to the large natural flood which occurred in early September 2008 the monitoring stations had to be removed from the rivers between 6 and 16 September (sites 1 and 4), 6 and 18 September (site 2) and 6 and 22 September (site 3). As a result no movement data could be collected for the release from Greenshank reservoir (Site 3, see Figure 52) on September 10. To ensure that sufficient fish remained in the streams following the floods, the backpack detector was employed to count fish remaining at each site. Results appear in Table 42 below.

Table 42: percentages of fish remaining in situ following the September 2008 flood

Site Number	No. Tagged fish found	No. fish tagged	Minimum percentage remaining <i>in situ</i>
1	19	33	58
2	47	67	70
3	31	51	61
4	50	69	72

The searches showed a sufficient number of fish remained at the sites for the study to remain viable. It should also be noted that difficult searching conditions in continuing high flows make it likely that a substantial proportion of fish remained undetected, and the numbers recorded are therefore a minimum estimate of the true numbers remaining, rather than an accurate count.

Figure 60 shows the flow and number of different fish detected at each site on each day that the antennae were operational during the recording period. At sites 1, 3 and 4 no fish movements were recorded on the days of scour releases. At site 2 a single fish was detected at the station on the day of the scour. This fish was resident close to the recording station and recorded regularly throughout the monitoring period.

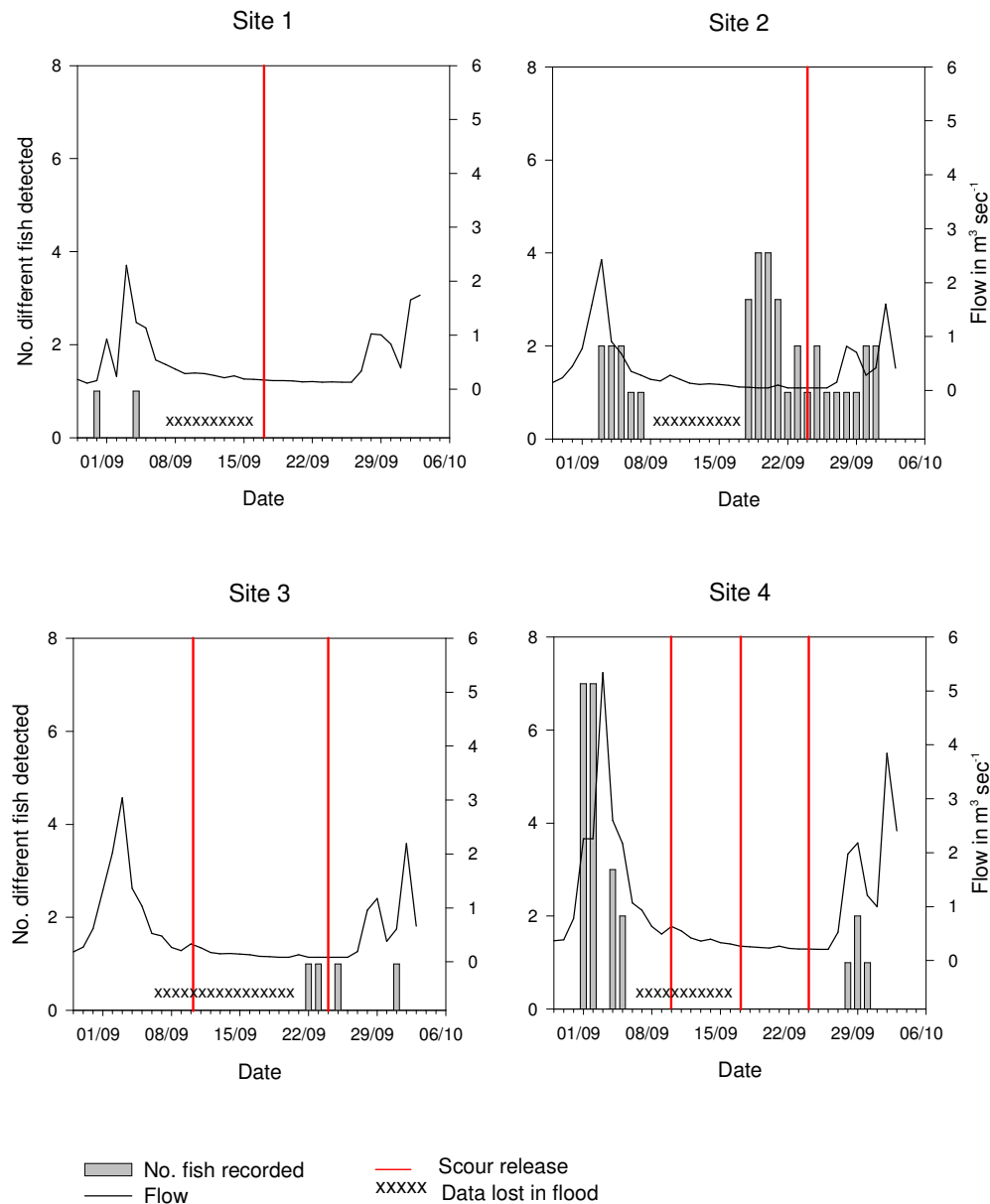

Figure 58: graphs showing numbers of individual fish detected at detection stations and average daily flow taken from nearest gauging weir, Catchment 1, Autumn 2008. Note scour releases not visible in daily average flows.

Correlation coefficients for fish movements and flow appear in Table 43, below. For Autumn 2008 there was a significant positive correlation between number of fish detected per day and flow at site 4. No relationships were found at other sites.

Table 43: Spearman's rank correlation coefficients for relationships between daily average flow and numbers of fish detected at sites 1 to 4, Autumn 2008

Site	1	2	3	4
Spearman's ρ	0.116	-0.331	-0.284	0.661
<i>p</i>	0.592	0.112	0.404	0.003
<i>n</i>	23	24	10	22

No significant relationships were observed between the numbers of fish movements recorded at each site during the Autumn 2008 monitoring period (Table 44).

Table 44: relationships between fish movements at sites 1 to 4, Autumn 2008

Site		2	3	4
1	Spearman's ρ	-0.178	n/a	0.371
	<i>p</i>	0.457	n/a	0.097
	<i>n</i>	19	10	21
2	Spearman's ρ		0.583	-0.473
	<i>p</i>		0.067	0.041
	<i>n</i>		10	19
3	Spearman's ρ			-0.257
	<i>p</i>			0.466
	<i>n</i>			10

6.4.2 Scour releases, Catchment 1, Spring 2009

The locations of the PIT detection stations used in Catchment 1 in Spring 2009 are shown in Figure 52, above.

Prior to re-installation of the recording stations in Spring 2009, the mobile detector was used to ascertain the number of fish remaining at each site. Results appear in Table 45. As in the Autumn, it is likely that further fish remained undetected and the figures below are a minimum estimate. Of the 134 tagged fish found only four fish were found outside of the area in which they were released post-tagging, and each of these had only moved within its site, rather than between sites.

Table 45: tagged fish found in catchment 1 prior to Spring 09 releases

Site	1	2	3	4	Total
No. fish found	15	55	25	39	134
No. originally tagged	33	68	51	69	221
Minimum percentage remaining	45	81	49	57	61

Despite the high numbers of tagged fish remaining in the catchment and the continued successful testing of recording station function only two fish were detected by the recording stations throughout the Spring 2009 period. Both of these fish remained in range of the antenna for some time, one fish detected upstream and downstream several times over three days at Site 2, the other remaining in the vicinity of the downstream antenna for several hours at Site 3, but not passing as far as the upstream antenna. No fish were recorded at the stations during scour releases in this time period.

Due to the fact that only two fish were detected at the recording stations no correlations can be made between numbers of fish movements and flow for this time period.

Table 46 below summarises numbers of fish found using the mobile detector before and after each release and the distances moved. At sites 1 and 3 the majority of fish did not move, while at site 2 11 out of 12 fish that were located both before and after the scour release had moved. The average distance moved at site 2 was 2.71 m (\pm 2.58 m SD). There was no general directional pattern in the movements, with upstream movements being roughly equal to downstream movements in both frequency and magnitude. The maximum recorded movement was 8 m, however as a number of fish were only located before or after the event, it is possible longer movements may have been made. Even if this was the case, the fish were not detected at the recording stations which were found to be fully functional before, during and after the releases.

Table 46: summary of fish movements during scour releases in Spring 2009

Site	1	2	3
No. fish located before water release	6	18	5
No. fish located after water release	8	18	7
No. fish located both before and after	6	12	4
Maximum recorded movement (m)	1	8	0
Average distance moved (m) \pm SD	0.2 \pm 0.4	0.8 \pm 2.6	0
No. upstream movements	1	4	0
No. downstream movements	0	7	0

6.4.3 Scour and spate releases, Catchment 2, Autumn 2009

The locations of the PIT detection stations used in Catchment 2 in Autumn 2009 are shown in Figure 59, below.

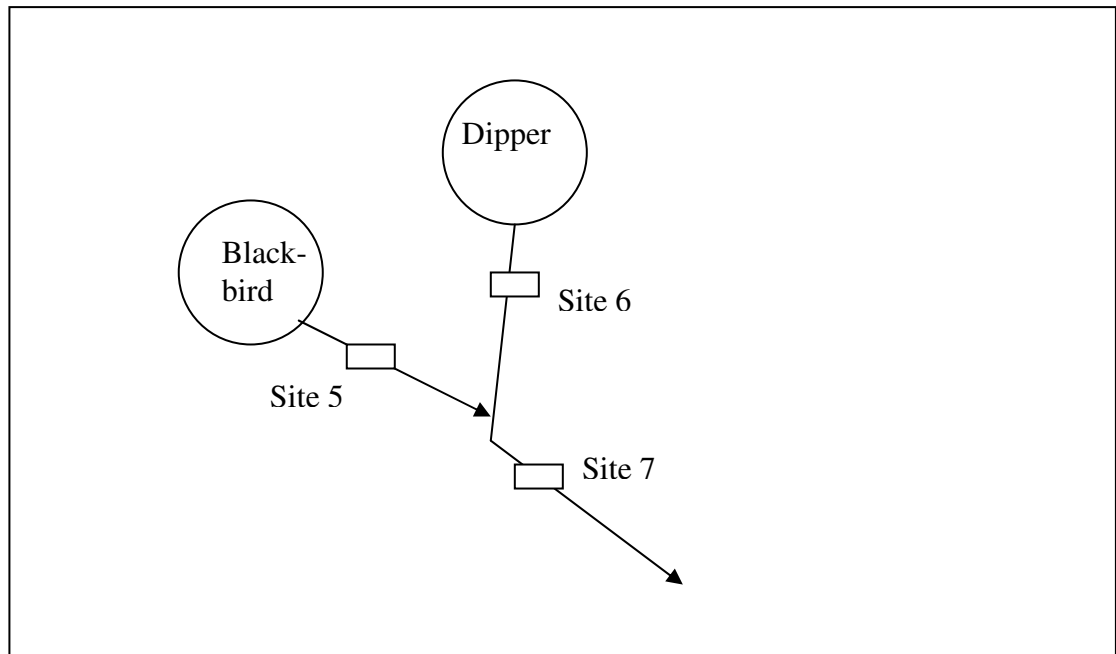

Figure 59: locations of the PIT detection stations in Catchment 2

Home range data

As no long-range movements had been recorded during the Autumn 2008 and Spring 2009 study periods, the decision was made to examine movements at a smaller scale in Autumn 2009. In order to do this, attempts were made to establish the home ranges of the tagged fish and thereby assess whether, even if the fish were not responding to the reservoir releases with long-range movements, they may nevertheless make unusual movements beyond their regular home ranges in response to the releases.

Despite locating large numbers of tagged fish on a daily or twice daily basis for most of the monitoring period, very few movements were recorded, with fish almost always being found in the same locations time after time, typically under or behind rocks or overhanging vegetation. Water clarity in Catchment 2 was greater than in Catchment 1 and fish could occasionally be seen dashing short distances to cover where they were subsequently detected. Throughout this period 27 fish were located 20 or more times, 47 fish were located more than 15 times and 55 fish were located more than 10 times.

Of the occasional movements that were recorded, one fish at site 6 was found 30 m from its habitual refuge, but returned to its usual position the following day. The fish in the pool at the head of site 5 roamed within the pool, and three were detected at the antenna some 40 m downstream. The antenna showed that a minority of fish did make occasional movements past the monitoring stations, typically at night, but were still found in consistent locations using the mobile detector during daylight hours, and none of the above movements were related to reservoir releases.

Despite the frequency of fish detections being suitable to attempt home range estimation, the lack of variance in location for most fish prevented traditional home range analysis such as that described in Knight et al (2009).

Responses to releases

Figures 60 and 61 show the relationships between numbers of fish recorded daily at each site and mean daily flows and water temperatures. In contrast to the work in Catchment 1, the highest daily numbers of fish recorded per day at each of sites 5 to 7 were on release days, although each of these counts was equalled on a non-release day.

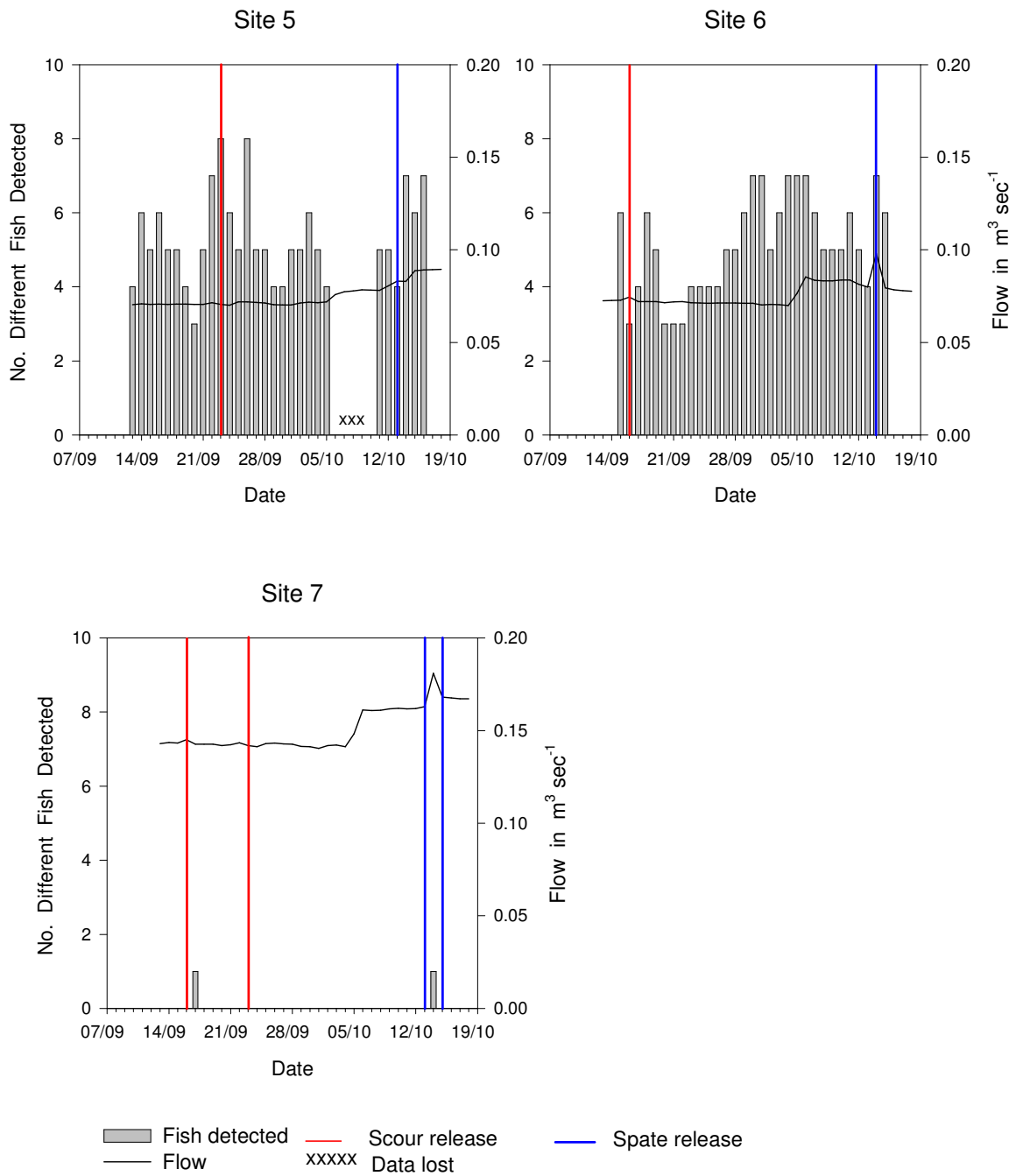

Figure 60: graphs showing numbers of individual fish detected at detection stations and average daily flow taken from nearest gauging weir, Catchment 2, Autumn 2009

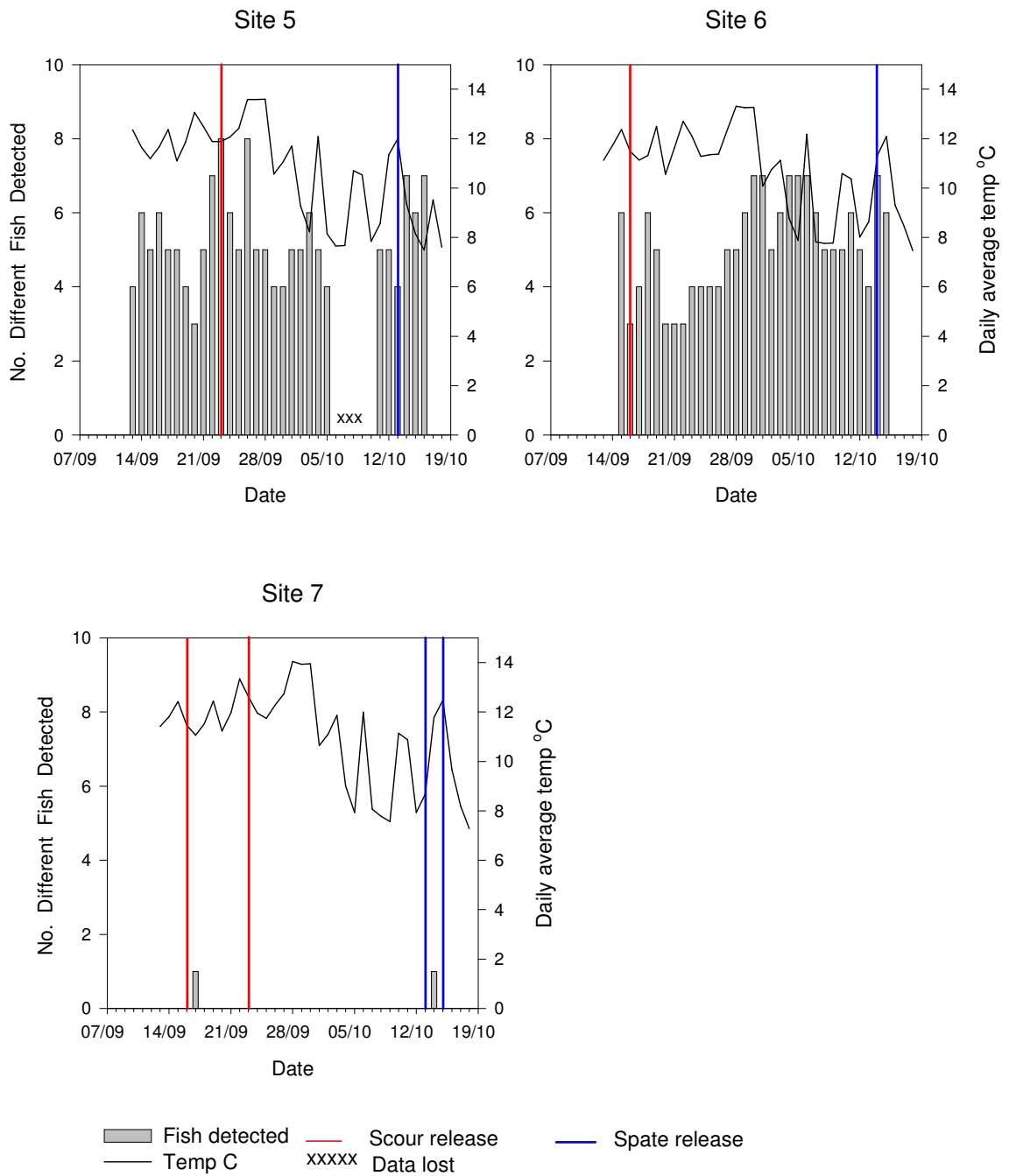

Figure 61: graphs showing numbers of individual fish detected at detection stations and average daily temperature, Catchment 2, Autumn 2009

There were no significant relationships between the numbers of fish detected and daily average flows (Table 47). However at each site the correlation of numbers of fish found against flow was positive and the correlation against temperature was marginally negative.

Table 47: relationships between numbers of fish detected and daily average flows and temperatures at sites 5 to 7, Autumn 2009 – Spearman’s rank correlation analysis

Site	Flow Site 5	Flow Site 6	Flow Site 7	Temp Site 5	Temp Site 6	Temp Site 7
Spearman’s ρ	0.302			-0.112		
<i>p</i>	0.110			0.560		
<i>n</i>	29			29		
Spearman’s ρ		0.069			-0.087	
<i>p</i>		0.710			0.637	
<i>n</i>		31			31	
Spearman’s ρ			0.127			-0.064
<i>p</i>			0.470			0.718
<i>n</i>			34			34

There were no significant relationships between the numbers of fish movements per day at each site (Table 48).

Table 48: relationships between fish movements at sites 5 to 7, Autumn 2009

Site	5	6	7
Spearman’s ρ		-0.190	0.162
<i>P</i>		0.349	0.399
<i>n</i>		26	29
Spearman’s ρ			0.060
<i>P</i>			0.715
<i>n</i>			31

Table 49 summarises numbers of fish found by mobile PIT surveying before and after each release and distances moved. As in Spring 2009, the majority of fish did not move, either during the spates or the scour releases, and there was no directional patterns to the movements that were recorded. The maximum distance moved was 12 m.

Table 49: summary of fish movements during scour and spate releases in Autumn 2009

Site	5 scour	6 scour	5 spate	6 spate
No. fish found before release	25	25	21	23
No. fish found after release	27	25	23	20
No. fish found both before and after release	21	23	17	20
Maximum recorded movement (m)	12	4	3	3
Average distance moved (m) \pm SD	0.90 \pm 2.77	0.61 \pm 1.27	0.35 \pm 0.86	0.70 \pm 1.22
No. upstream movements	2	3	2	2
No. downstream movements	2	3	1	4

Although generally fish locations did not change dramatically following the reservoir releases, a number of trout were seen to jump at a 130 cm weir immediately below

Blackbird reservoir (Figure 53, above) shortly after the flows began to fall after maximum discharge was achieved during the spate flow. Numbers of fish recorded by the monitoring station were relatively low on this day (4), and of the 17 fish recorded both before and after the release only 3 had moved. However approximately 20 attempts were made by a number of fish to jump the weir. The identities of these fish could not be recorded as they ceased to jump when the flows returned to workable levels. The jumping fish ranged in size from approximately 15 cm to 40 cm.

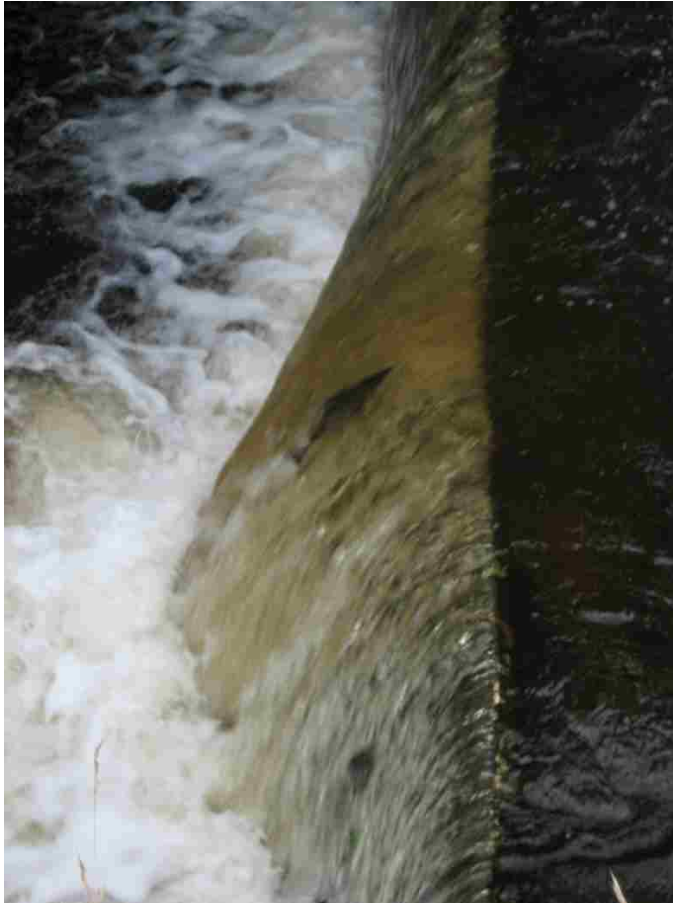

Figure 62: trout jumping during spate release below Blackbird reservoir

Two fish were seen to clear the weir, and fish no. 983 (410 mm, 650 g) was subsequently found in the stilling pool upstream of the weir. Fish 988 (152 mm, 44 g) disappeared from the monitoring area during the spate release and did not pass through downstream through the station. A similar sized fish was seen to clear the weir but the tag could not be found in the stilling pool.

On the days following the two scour releases and the second of the spate releases the areas between the release sites and the downstream station at site 7 were searched using the mobile detector. No fish were found outside their original tagging stretches.

Autumn 2009 flood

The Autumn 2009 monitoring period was followed by a period of sustained rain and high flows. During this period, as during the Autumn 2008 flood it was not possible to work in the river. However sites 5 and 6 were searched as soon as conditions permitted following the floods. Numbers of fish found at these sites appear in Table 50 below.

Table 50: numbers of tagged fish remaining at sites 5 and 6 following Autumn 2009 flood

Site	5	6
No. of fish found post flood	18	20
No. of fish tagged	46	27
No. of fish found pre flood	22	25
No. of fish lost during flood	4	5
No. of fish found outside original tagging areas	0	0

6.4.4 Recruitment effects

Environment Agency figures for brown trout catches before (2000 – 2004, n = 5) and after (2005 – 2010, n = 6) the introduction of the spate releases appear in the Table 51 below. Data were tested for normal distribution using a Shapiro-Wilk test. Normally distributed data were compared using t-tests, and non-normally distributed data were compared with Mann-Whitney U tests. All tests were calculated using SigmaPlot v 11.0.

Table 51: electric fishing results before and after the introduction of spate releases

Site	7				Site 5		8		Site 6	
Fish Size	9	0+	0+ to 20cm	>20cm	All fish	10	0+	0+ to 20cm	>20cm	All fish
Average catch before \pm SD	31 \pm 12	30 \pm 13	3 \pm 2	64 \pm 2	3 \pm 2	18 \pm 9	0	21 \pm 8		
Average catch after \pm SD	29 \pm 23	16 \pm 6	6 \pm 1	50 \pm 19	4 \pm 4	18 \pm 4	0	22 \pm 5		
<i>t</i>	-0.119	N/A	N/A	N/A	-0.909	0.115	N/A	-0.467		
<i>n</i>	4				4	4		4		
<i>P</i>	0.908				0.393	0.912		0.655		
<i>U</i>	N/A	0.000	2.000	10	N/A	N/A	9.0	N/A		
<i>n</i>		4	4	4			4			
<i>P</i>		0.016	0.063	1			0.905			
Statistical difference (<i>P</i> < 0.05)?	No	Yes	No	No	No	No	No	No	No	No

There were no significant differences between the pre and post spate introduction catches at the majority of sites. The exception was a significant decrease in the numbers of 0+ to 20 cm fish at site 5 following the introduction of the spate releases. Catch variability from year to year was high and the number of sampling years limited, lessening the possibility of finding a significant difference.

6.5 Discussion

6.5.1 Home range data

The home range data collected with the mobile detector suggest that the fish in these catchments live relatively sedentary lives during the seasons and at the locations studied. The data from the stationary recorders do show that a small number of fish do roam the sites, mostly at night. The fact that movements are recorded by the antenna, and that when fish are located with the mobile detector they are typically under or behind rocks or vegetation suggests that movements may actually be far more wide-ranging than those recorded, and that the fish may retreat to known refugia within their home ranges when they become aware of human disturbance on the bank or in the water, making it difficult to estimate true home range size. This theory is supported by observations from the bridge at site 5, where fish were frequently seen in mid-stream, but could be seen moving towards a man-made overhang supporting the bridge, where they were subsequently detected.

The literature on home range sizes on brown trout varies greatly, and the results will be heavily influenced by a variety of factors including life-stage of the observed fish, time of year, and prevalent environmental conditions during the recording. Studies from comparable populations in comparable habitats show that ranges frequently overlap (Bachman 1984, Hojesjo et al. 2007) and that individual fish may not move from a particular station for periods of several months (Bridcut and Giller 1993) or may occupy ranges of up to 50 m² (Hesthagen 1990). Ovidio (1999) found home ranges to be proportional to fish size. Each of these studies found that size and use of home range varied substantially between individuals. For the purposes of this experiment, given the limited fish movement recorded, it can be assumed that if a fish that had only previously been recorded as stationary could be shown to make any substantial movement at all during the reservoir releases, that movement could be considered a deviation from usual behaviour. Such movements were not seen and the hypothesis that fish make unusual movements in response to the releases is disproven.

6.5.2 Responses to reservoir releases

Despite the rapid and substantial changes in flows during reservoir releases (Section 4.3) the fish showed no evidence of either washout or upstream migration. No movement patterns relating to the releases were detectable at the recording stations, and although the mobile detector was used regularly throughout the monitoring periods only one fish was found outside the area in which it was originally tagged.

All the data collected suggests that the brown trout of the sizes studied in these catchments at these times of year move very little. Gradually increasing numbers of fish did disappear from the sites throughout the monitoring period, but as the recording stations were fully functional throughout, these losses appear to be attributable to predation (possibly by herons, mink, otters and other trout), natural mortality, tag expulsion or tag failure rather than migration. A study on a similar upland stream showed that losses of 0+ and 1+ fish in any given year were more likely to be caused by predation and death than migration, and while older fish were increasingly likely to migrate, the majority of losses in 2+ fish continued to be a result of death or predation (Elliott 1994).

The lack of response to the releases shows that the trout clearly possessed the swimming capabilities to allow them to remain in their home ranges during the varying flows. Their

ability to maintain position during peak flows may be partly attributable to their use of flow refugia created by the heterogeneous habitat on the river beds of these boulder and cobble strewn streams, a possibility which is investigated further in Chapter 7.

The spate release at Blackbird reservoir appeared to initiate a jumping response in the fish in the pool below the reservoir stilling basin, and at least two fish managed to clear a 130 cm weir. This response was not seen at any other site, nor at the earlier scour release at this reservoir, and did not appear to extend to the fish below the recording station, about 60 m downstream. During tagging at this site the pool below this weir was particularly rich in trout, and contained several trout larger than the catchment average. It is possible that these fish had migrated upstream prior to tagging (which took place on the 8 of September), had reached this weir, which is the highest obstacle for at least 7 km downstream of the study site, and been unable to proceed any further. The enhanced flows allowed the fish to clear the weir, although further progress was blocked by the reservoir, and it should be noted that the majority of jump attempts were unsuccessful. An alternative possibility is that these larger fish were stocked fish that had escaped from one of the upstream reservoirs and been unwilling to move further downstream through the shallower riffles. However, the reservoirs upstream are stocked with far more rainbow trout than brown trout, and no escaped rainbows were found during electro-fishing.

Although the Autumn releases took place in what is considered to be the period immediately prior to brown trout spawning season it is possible that fish tagged were not yet in spawning condition at the time of the releases. However, visual inspection of fish captured during Environment Agency and HIFI electro-fishing surveys in the monitoring period showed that male fish were producing milt in both catchments at the time of the releases, suggesting that the fish were or would soon be ready to spawn. In the clearer waters at site 5 possible trout spawning redds also appeared in the gravels shortly after the spate releases, although their origin could not be confirmed.

Another possibility is that fish in these upland systems have no need to migrate upstream to reproduce. The fish are already in the headwaters where spawning habitat appears to be as good as in any location further upstream, and migration further upstream is blocked by the reservoirs. Although the streams studied lack the classic gravel beds associated with trout spawning habitat, small pockets of gravel are commonplace. Deeper gravel beds are

absent from most of the Pennine catchments although these are still highly productive trout waters. The waters are generally well oxygenated and macro-invertebrate abundance is high, so it may be that trout already resident in the study areas are already in optimal spawning habitat and have no need to migrate upstream.

The likelihood that trout in the study areas do not migrate prior to spawning may be increased by the fragmentation of the catchments by reservoirs and weirs all the way from the uplands to the Humber Estuary. These impoundments make it unlikely that any trout that do smolt will be able to return to their original birthing grounds from the sea. If there is a genetic component to smolting behaviour it may be that through time the tendency to migrate lessens as smolting fish are unable to return and their genes are lost from the headwater populations.

A further possibility is that the fish respond to some cue that is not produced during the spate and scour releases. Recent work at Kielder reservoir has shown that Atlantic salmon are far less likely to migrate in response to a reservoir release than to a natural flood. It is known that fish respond to olfactory cues (Lucas and Baras 2001, Shelton 2009), and it is possible that water straight from the reservoirs may smell or taste different to flood water which has drained through the soils of the whole catchment, and may not be recognised by the fish. It has also been suggested that salmonids respond to the changes in air pressure that proceed a heavy downpour (Lucas and Baras 2001, Shelton 2009), so may spot a mimicked flood as a “fake”.

It is certainly possible that trout further down the catchment are responding to these releases, and returning sea trout or resident river-dwelling adult trout may be stimulated to swim upstream, however, due to the increasing size of the river downstream, and the numbers of fish that would have to be tagged to produce any likelihood of one appearing at a recording station in any given tributary, the responses of these downstream fish could not be recorded in this study. Furthermore, as these releases are only from single reservoirs the effects diminish rapidly downstream, particularly in the more heavily impounded catchments where water “backs up” behind weirs, it is possible that trout more than a few kilometres downstream are completely unaware of the releases.

The lack of significant correlations between numbers of fish detected, average daily flows and temperatures supports the findings of a similar study on Norwegian brown trout (Rustadbakken et al. 2004) and suggests that even at the higher flows seen during the monitoring periods the trout remain within their chosen habitats, and following the floods of Autumn 2008 the majority of tagged fish remained in their original home reaches. Although no significant correlations were found between numbers of fish recorded and average daily temperature, each of the three correlation coefficients calculated was weakly negative, hinting that at colder temperatures the fish may be less mobile, as expected. This may lead to a differing response to a reservoir release from a deeper reservoir in Summer if large quantities of cooler stratified water are released into a stream, or possibly in the depths of winter, although in this case water from deep in the reservoir would be likely to be warmer than that in the stream. This does not appear to be a concern in these Pennine catchments where no significant changes in temperature have been recorded during this study. Similarly, a problem may arise if anoxic water is released without aeration, although given the mechanism of release (Section 3.2.1) this is unlikely.

6.5.3 Responses to natural spates

Although it was not possible to track the movements of fish during the natural spates seen in Autumn 2008 and Autumn 2009 the data gained before and after the high flows again shows that the majority of fish showed strong site fidelity, and overall population losses from the monitoring areas during the high flows were minimal. Intriguingly, of the four fish lost from site 5 during the Autumn 2009 floods three were resident in the pool below the stilling basin at the upper limit of the stream and were much larger fish than the catchment average, possibly supporting the theory that these larger fish had migrated upstream for the spawning season, been unable to progress beyond the reservoir and returned downstream when the breeding season was over, or when the higher flows allowed easier passage.

6.5.4 Recruitment effects

Variability between years is too large and the data set too short-term to detect any changes in recruitment following the introduction of the spate flows, and average catches of 0+ fish remain similar. The hydrographs in Chapter 4 show that the annual variation in flows at these two sites is high, and may override any effects associated with the spate flows.

6.6 Conclusions

Although the releases did not trigger upstream migrations, no negative impacts upon the fish populations were found. The releases allowed a (very small) number of fish to pass a major obstacle to migration below Blackbird reservoir and also cleaned gravel beds for some distance downstream (Section 4.3), and therefore appear to mitigate some of the effects of river impoundment, particularly in less flashy or more heavily abstracted catchments, or in drier years when reservoirs fail to overflow.

Although there has been no clear improvement to recruitment since the introduction of the spate releases, the releases studied here may help to maintain trout populations in years where pressures such as droughts or choked gravel beds threaten recruitment by maintaining good spawning habitats and assisting fish in the passage of barriers. It could be argued that poor recruitment years are a part of the natural cycle, however due to the extra strain of abstraction and the reduction in the number of natural cleansing spates any assistance to recruitment in these impounded catchments should be welcomed.

Chapter 7: Habitat heterogeneity, flow refugia and brown trout habitat usage

7.1 Introduction

This chapter explores how the nature of the habitat in the study streams may influence the responses to the reservoir releases recorded in Chapters 5 and 6. It also examines the heterogeneous nature of the in-stream habitats with reference to how the biota may exploit the resulting availability of flow refugia. Using habitat survey data and the data gathered on the in-stream locations of trout the following hypotheses, developed in Chapter 1, are tested:

1. Brown trout exhibit preference for specific habitat conditions relative to the range available within the study streams
2. Brown trout will alter their locations to maintain these habitat preferences as in-stream conditions change during elevated flows

Throughout this chapter, meso- and micro-habitat characteristics, rather than macro habitat characteristics are considered, as the responses of the biota are likely to be determined by the conditions in their immediate vicinity, rather than changes at the reach or catchment scale. Equally, the biota may be capable of moving between habitat units (for example from a pool to a riffle) in the time-scale of the releases, but are unlikely to be able to move greater distances. The terms “habitat use” and “habitat preference” are both used here, with “use” referring to the habitat in which the brown trout are found, and how they exploit its varying characteristics, while the term “preference” is used where it can be seen that the fish have positively selected one or more habitat variables over others.

7.2 Study site habitat characteristics

In order to investigate the above hypotheses, it is necessary to examine the habitat available to the trout in the study streams. As the trout tagged in this study varied in size between 106 and 459 mm (mean 158 mm \pm 23 mm S.D., typical estimated age 1 – 2 years, see Chapter 6) it is the habitat usage of parr that is the focus of the analysis. A summary of the habitat requirements described in the literature for this age group appears in Table 52, below.

Table 52: recorded brown trout parr habitat requirements, adapted from Summer et al, 1996 and Armstrong et al, 2003

Depth	Velocity	Substrate Size	Reference
About 30 cm	<40 cm sec ⁻¹ but 0 cm sec ⁻¹ preferred		Belaud et al 1989
<90 cm	<50 cm sec ⁻¹ but about 0 to 10 cm sec ⁻¹ preferred		Bovee 1978
Preference >50 cm	Range 10 – 70 cm sec ⁻¹	8 – 128 mm Maximum >128mm	Eklov et al 1999 Heggenes 1998
30 – 60 cm	5 to 30 cm sec ⁻¹ . Snout velocity, 5 to 10 cm sec ⁻¹		Heggenes and Saltveit (1990)
25 – 55 cm	15 to 60 cm sec ⁻¹		Johnson et al 1995
About 30 cm	<30 cm sec ⁻¹ but 0 cm sec ⁻¹ most preferred		Loar 1985
Range 40 – 75 cm			Maki-Petays et al 1997
About 30 cm	0 to 50 cm sec ⁻¹		Moyle et al 1983
27 – 57 cm	9 to 45 cm sec ⁻¹ by day but 3 to 45 cm sec ⁻¹ at night		Schuler et al 1994
Range 14 – 122 cm, mean preference 65cm	Range 0 – 65 cm sec ⁻¹ , mean 26.7 cm sec ⁻¹		Shirvell and Dungey 1983

The data in Table 52 vary slightly, probably a result of recording different populations at different times of year. The data do all fall within a similar range, however, and are summarised in Table 53, below.

Table 53: summarised brown trout parr habitat requirements

Habitat variable	Average recorded brown trout preference
Depth	14 – 122cm, mean 39cm
Velocity	0 – 70 cm sec ⁻¹ , mean 26 cm sec ⁻¹
Substrate size	8 – 128 mm (gravel to cobble on Wentworth scale)

In order to understand how the resident biota utilised the in-stream habitats of the study catchments, and whether the nature of these habitats contributed to the resilience and resistance of these communities to the reservoir releases, a full habitat survey was undertaken. This was followed by the high resolution mapping of a section of stream bed to attempt to illustrate the availability of flow refugia. In conjunction with the mapping of the positions of individual fish in this section prior to and immediately after the releases, it was anticipated that these data would further the understanding of habitat use by fish in response to high flows.

7.3 Methodology

7.3.1 Catchment habitat surveys

Following the identification of the tagging and invertebrate sampling sites in Autumn 2008, Spring 2009 and Autumn 2009 full habitat surveys were conducted in Catchments 1 and 2. As channel depth, width, habitat type and water velocity are flow dependent, the fish habitat usage data described in Section 7.4.2 was taken on the same days as the overall habitat data, allowing comparison of the data sets. 150 m stretches of river centred on each of the tag recording stations shown in Figures 52 and 53 were surveyed, allowing coverage of all the habitat types immediately available to the fish while providing sufficient resolution to be relevant when examining the fishes' responses to releases. The following variables were recorded at 10 m intervals.

1. Habitat type – pool, riffle, glide, slack, cascade, waterfall or man-made channel or culvert.
2. Wetted channel width at time of measurement.
3. Depth in cm – an average of five readings taken at equal distances across the channel.
4. Velocity – an average of five readings taken at the same points as the depth recordings slightly below the water surface to minimise the effects of friction with the bed, banks and air currents.
5. Riverine vegetation – percentage cover of macrophytes, moss, algae and filamentous algae.
6. Overhanging vegetation – presence of overhanging vegetation, e.g. trees, grass, and percentage cover
7. Bank morphology – vertical, sloping, undercut or man-made.
8. Substrate type – using a modified Wentworth scale (Wentworth 1922) shown in Table 54 below. Classification was done by sight rather than precise measurement. Each transect was assigned a percentage cover figure for each type.

Table 54: modified Wentworth scale used for sediment classification

Sediment type	Approximate longest axis length (mm)
Boulder	>256
Cobble	64 - 256
Gravel	1 - 64
Sand	0.0625 - 1
Silt	<0.0625
Bedrock	n/a
Manmade	n/a

Additionally, a Leica dGPS (Section 6.3.3.) was used to map a 4m * 1 m area of stream bed in a stretch in site 2 (Figure 52) where fish were frequently recorded in order to create a picture of bed roughness and habitat heterogeneity not available through photography due to the deep colouring of the water. To create the map points were taken at 20 cm intervals on transects 20 cm apart at a mean accuracy of 2.99 cm.

7.3.2 Trout habitat usage surveys

In order to better understand how the fish used the available habitat the mobile PIT tag detector and dGPS were used to locate and map individual fish at sites 1, 2 and 4 (Catchment 1) and 5 and 7 (Catchment 2) where tagged fish were most easily located. The measurements described in Section 7.3.1 were then taken at each corner and in the centre of a 1 m * 1 m square centred on the best estimate of the fish's location at the time of detection. As the fish generally remained stationary until detected or disturbed, estimates of their positions could usually be made very accurately (Section 6.3.3).

Univariate analyses were used to determine whether the fishes' use of individual variables such as depth or velocity changed at the varying flows. In addition multivariate analyses were used to ascertain whether the fishes' habitat as a whole, (as described by the full suite of measured variable in 6.5.1) changed with the varying flows.

In order to compare a variety of variables simultaneously and prevent higher value variables skewing the comparison, the habitat data were normalised (using Primer-e software, v6, Plymouth 2009), giving each datum a value between -1 and 1. As the purpose of the study was to examine changes in behaviour caused by changes in flow, only the flow-related data from Table 55 (depth, velocity, habitat type) were used, as each of these variables will change with varying stream discharge, as opposed to the non-flow related epiphyte and substrate data. ANOSIM routines (Section 5.2.6) were then performed to identify differences between data sets.

7.4 Results

7.4.1 General site habitat results

The results for the habitat surveys at each of the sites appear in Table 55, below.

The streams are dominated by riffles and pools, with occasional cascades, glides and manmade sections. The streams are generally shallower and faster than the habitat preferences shown in Table 53, above, but are within the brown trout habitat ranges recorded in Table 52. In addition the substrate is typically more coarse than that recorded as preferred by trout in the literature. The substrate is often covered in algae or moss (as seen in Figure 63 and also visible in Figure 65), although few macrophytes are present and overhanging vegetation is sparse at all sites except site 5.



Figure 63: moss and algal growth, Catchment 1

Table 55: habitat data for survey streams

Site	Site 1 habitat Autumn	Site 2 habitat Autumn	Site 1 habitat Spring	Site 2 habitat Spring	Site 5 habitat Autumn	Site 7 habitat Autumn
Date	08/10/2008	08/10/2008	18/02/2009	20/02/2009	19/10/2009	19/10/2009
Flow at nearest gauge m³sec⁻¹	0.18	0.60	0.11	0.05	0.09	1.35
Mean depth cm (± SD)	13 (± 7)	21(±17)	11(±8)	11(±6)	20(±13)	19(±13)
Mean velocity m sec⁻¹	0.66(±0.21)	0.58(±0.29)	0.47(±0.20)	0.49(±0.16)	0.47(±0.30)	0.54(±0.16)
Pool %	20	26	20	26	44	12
Riffle %	53	54	53	54	22	68
Cascade %	13	14	13	14	0	10
Slack %	0	0	0	0	0	0
Glide %	13	6	13	6	17	0
Manmade %	0	0	0	0	17	10
Bedrock %	31	35	31	35	0	0
Boulder %	18	12	18	12	3	21
Cobble %	28	40	28	40	38	60
Gravel %	19	9	19	9	16	4
Sand %	4	4	4	4	14	0
Manmade %	0	0	0	0	87	15
Moss %	9	24	16	31	26	16
Macrophyte %	0	0	0	0	0	0
Algae %	1	0	21	43	0	23
Filamentous Algae %	51	28	12	5	63	0
Overhanging Vegetation %	9	2	10	0	34	9

In addition to the quantitative data above, the dGPS map of the river bed at site 1 (Figure 64.) and photographs below illustrate the complexity of the river beds.

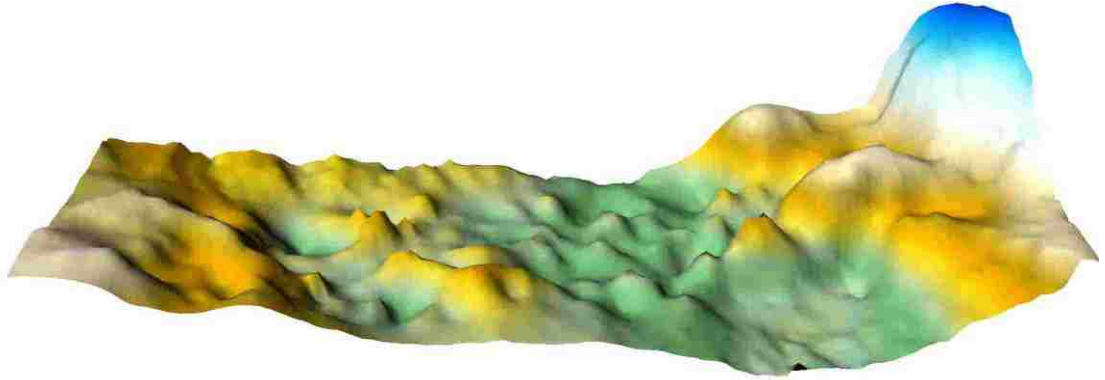

Figure 64: shaded relief image of river bed at Site 2, created using dGPS readings on a 20 cm x 20 cm grid. Image shows a 4m wide x 1m long section of bed, looking upstream.



Figure 65: photograph of section of site 2 illustrated in Figure 64, above



Figure 66: typically bouldery section of Site 5

7.4.2 Trout habitat usage results

Table 56 below summarise the habitat measurements taken around the fish in the study streams and also show the stream habitat data for comparison.

Table 56: summary of catchment habitat measurements and habitat measurements taken around individual fish. Fish data are highlighted in grey.

Site	Site 1				Site 2				Site 5		Site 7	
Date	08/10/2008		18/02/2009		08/10/2008		20/02/2009		19/10/2009		19/10/2009	
Fish or Habitat data	H	F	H	F	H	F	H	F	H	F	H	F
Flow at nearest gauge m ³ sec ⁻¹	0.18	0.18	0.11	0.11	0.60	0.60	0.05	0.05	0.09	0.09	1.35	1.35
Mean depth cm (± SD)	13 ± 7	40 ± 11	11 ± 8	20 ± 10	21 ± 17	28 ± 12	11 ± 6	27 ± 11	20 ± 13	18 ± 14	19 ± 13	21 ± 8
Mean velocity m sec ⁻¹	0.66 ± 0.21	0.57 ± 0.33	0.47 ± 0.20	0.22 ± 0.22	0.58 ± 0.29	0.53 ± 0.26	0.49 ± 0.16	0.22 ± 0.16	0.47 ± 0.30	0.16 ± 0.19	0.54 ± 0.16	0.48 ± 0.14
Pool %	20	39	31	31	26	42	26	56	44	0	12	64
Riffle %	53	39	50	50	54	40	54	32	22	50	68	18
Cascade %	13	14	4	4	14	7	14	3	0	13	10	0
Slack %	0	7	8	8	0	11	0	0	0	0	0	0
Glide %	13	0	8	8	6	0	6	9	17	0	0	0
Manmade %	0	0	0	0	0	0	0	0	17	38	10	18
Bedrock %	31	29	31	12	35	24	35	7	0	0	0	0
Boulder %	18	32	18	45	12	23	12	24	3	15	21	56
Cobble %	28	27	28	26	40	36	40	48	38	30	60	30
Gravel %	19	12	19	16	9	13	9	10	16	14	4	7
Sand %	4	0	4	0	4	1	4	9	14	27	0	7
Manmade %	0	0	0	0	0	3	0	0	87	15	15	0
Moss %	9	9	16	24	24	21	31	27	26	9	16	27
Macrophyte %	0	0	0	0	0	1	0	1	0	0	0	1
Algae %	1	0	21	35	0	3	43	27	0	30	23	15
Filamentous Algae %	51	0	12	0	28	0	5	6	63	0	0	0
Overhanging Vegetation %	9	18	10	2	2	11	0	9	34	46	9	33

Depths and velocities

Figure 67 shows a comparison of the depths and velocities recorded around individual fish and those recorded at random points in the same reaches. The statistical significances of the differences were tested using either t-tests or Mann-Whitney rank sum tests, depending on whether data were normally distributed (Tables 57 and 58). Normality of distribution was tested using Shapiro-Wilk tests. All tests were run using SigmaPlot v 11.0.

At each of the survey sites with the exception of site 5 the fish used water that was deeper than the mean habitat measurement taken at the same site (statistical significance of these relationships shown in Table 57). At site 5 the water used by the fish was slightly shallower (18 ± 14 cm) than the mean reach depth (20 ± 13 cm). In each case except site 5 the fish also used depths closer to the recorded mean parr preference of 39cm in Table 53 than the habitat mean values. The water at sites 1 and 2 was deeper (although not significantly) during the higher flows in Autumn 2008. The fish maintained similar depths at site 2 during the higher flows, but used significantly deeper water at site 1.

In each case the fish used areas with velocities closer to the mean velocity preference of 26 cm sec^{-1} than the stream habitat means. At each of the sites the fish used water slower than the site mean (statistical significance of these relationships shown in Table 58). The mean available velocities at sites 1 and 2 were slightly higher during the higher flows in Autumn 2008 than in Spring 2009, and the water occupied by the fish was significantly faster during the higher flows.

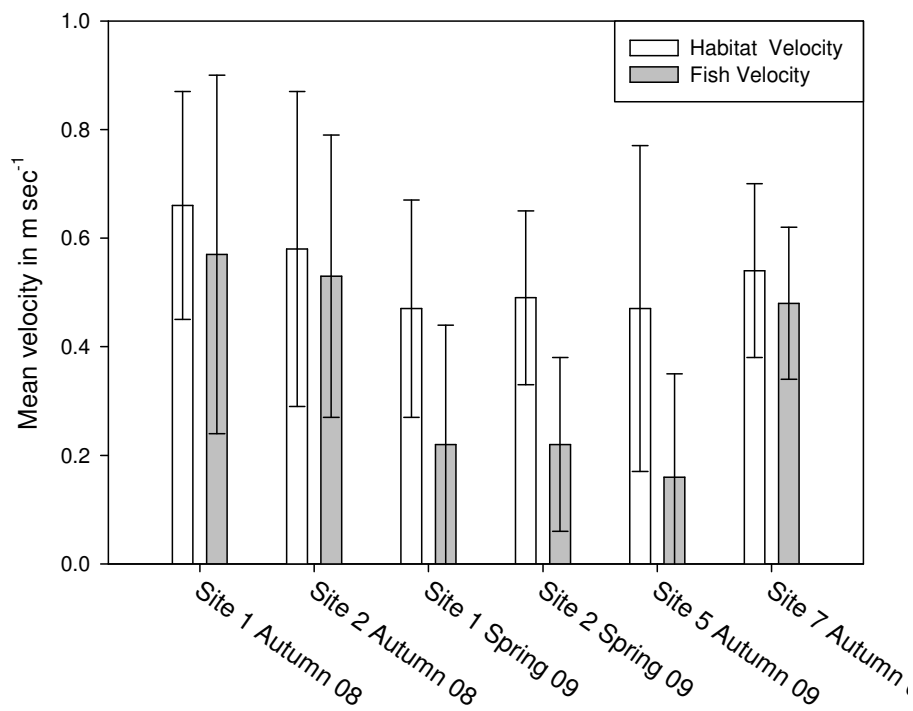
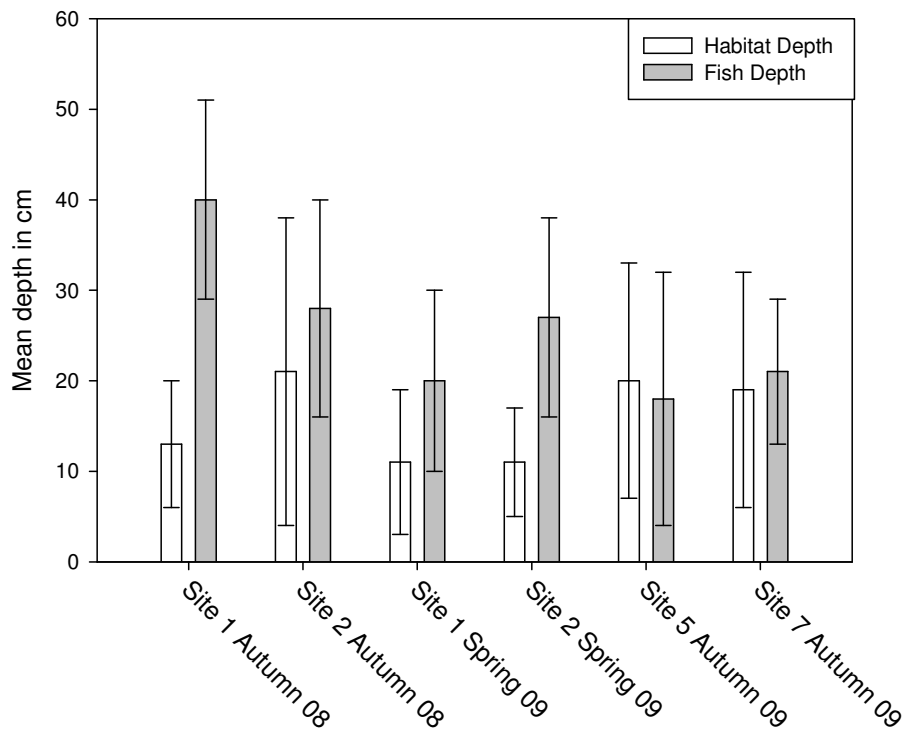

Figure 67: depth and velocity means showing habitat means and the means of the measurements taken at fish locations +/- 1SD

Table 57: statistical significance of differences between general habitat depths and fish habitat depths

Comparison	<i>t</i>	Mann-Whitney <i>U</i>	<i>P</i>	Significantly Different?
Site 1 Autumn 08 general habitat vs fish habitat	-7.699	n/a	<0.001	Yes
Site 2 Autumn 08 general habitat vs fish habitat	n/a	297.5	<0.001	Yes
Site 1 Spring 09 general habitat vs fish habitat	-3.476	n/a	0.001	Yes
Site 2 Spring 09 general habitat vs fish habitat	-2.109	n/a	0.040	Yes
Site 5 Autumn 09 general habitat vs fish habitat	n/a	80.0	0.405	No
Site 7 Autumn 09 general habitat vs fish habitat	n/a	140.5	0.714	No
Site 1 Autumn 08 fish habitat vs Spring 09 fish habitat	4.808	n/a	<0.001	Yes
Site 2 Autumn 08 fish habitat vs Spring 09 fish habitat	n/a	488.5	0.147	No
Site 1 Autumn 08 general habitat vs Spring 09 general habitat		162.5	0.488	No
Site 2 Autumn 08 general habitat vs Spring 09 general habitat		261.5	0.714	No

Table 58: statistical significance of differences between general habitat velocities and fish habitat velocities

Comparison	<i>t</i>	Mann-Whitney <i>U</i>	<i>P</i>	Significantly Different?
Site 1 Autumn 08 general habitat vs fish habitat	0.904	n/a	0.374	No
Site 2 Autumn 08 general habitat vs fish habitat	0.420	n/a	0.676	No
Site 1 Spring 09 general habitat vs fish habitat	2.516	n/a	0.016	Yes
Site 2 Spring 09 general habitat vs fish habitat	n/a	70.0	<0.001	Yes
Site 5 Autumn 09 general habitat vs fish habitat	n/a	25.0	<0.001	Yes
Site 7 Autumn 09 general habitat vs fish habitat	n/a	48.0	0.169	No
Site 1 Autumn 08 fish habitat vs Spring 09 fish habitat	2.617	n/a	0.045	Yes
Site 2 Autumn 08 fish habitat vs Spring 09 fish habitat	n/a	194.5	<0.001	Yes
Site 1 Autumn 08 general habitat vs Spring 09 general habitat	n/a	69.0	0.047	Yes
Site 2 Autumn 08 general habitat vs Spring 09 general habitat	n/a	17.0	0.009	Yes

Habitat types

The data in Table 56, Figures 68 and 69 show that at each of the sites with the exception of site 5 (Catchment 2, below Blackbird reservoir) the fish also positively selected pools. The exception at site 5 is due to the large number of fish (38%) found in manmade habitat – two large concrete-floored pools below the reservoir outlet. Similarly the fish positively selected slack water (a habitat with limited availability in both catchments). These habitats were used at the expense of riffles, which are used less than would be the case if the fish were randomly distributed. The numbers of fish using cascades and glides show no clear pattern, while in catchment 2 the manmade habitats (mostly deep pools with low water

velocities and certainly the deepest areas in these river stretches) attracted a far higher proportion of fish than would be expected. The fish at site 1 make a greater use of pools in the higher flows of Autumn 2008, while those at site 2 use pools less during the higher flows.

General Habitat Site 1 Autumn 2008

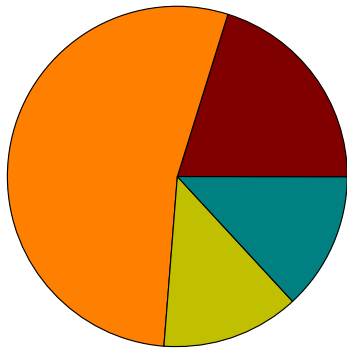

Fish Habitat Site 1 Autumn 2008

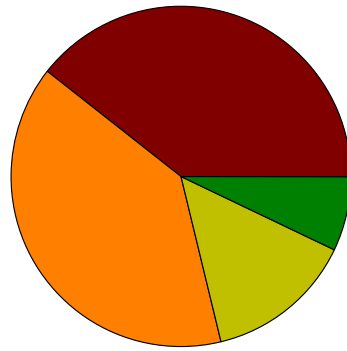

General Habitat Site 2 Autumn 2008

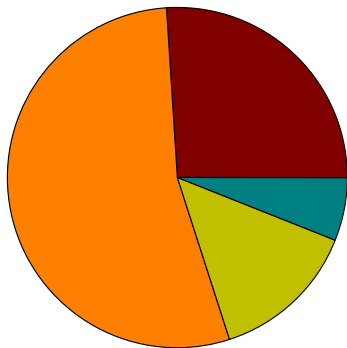

Fish Habitat Site 2 Autumn 2008

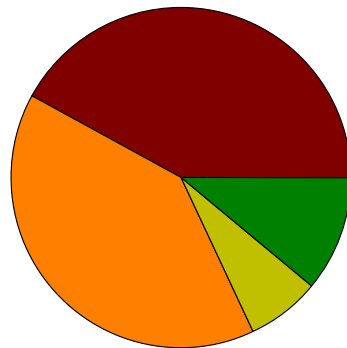

General Habitat Site 1 Spring 2009

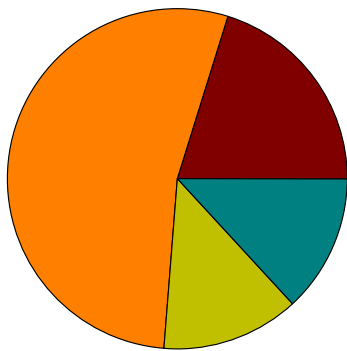

Fish Habitat Site 1 Spring 2009

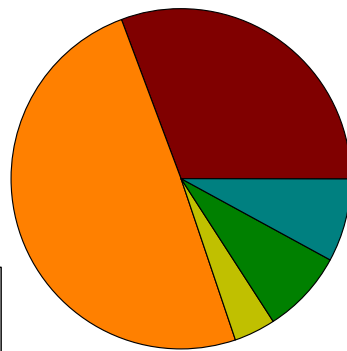
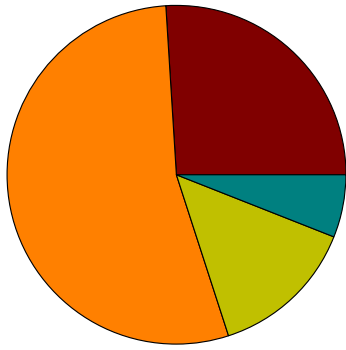
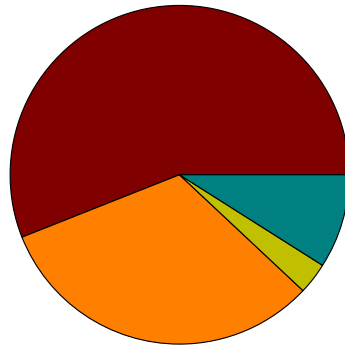

Figure 68: habitat types in each reach and habitat types selected by fish in each reach

General Habitat Site 2 Spring 2009



Fish Habitat Site 2 Spring 2009



General Habitat Site 5 Autumn 2009

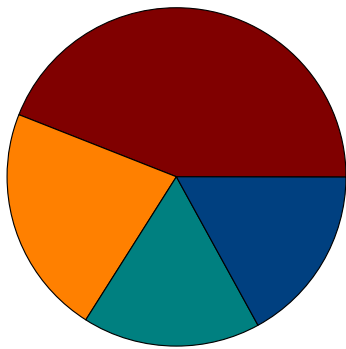

Fish Habitat Site 5 Autumn 2009

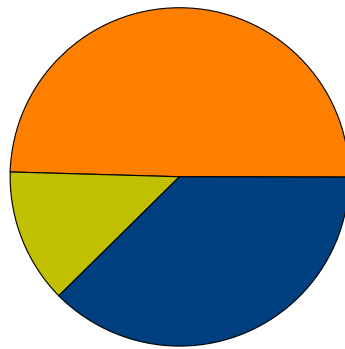

General Habitat Site 7 Autumn 2009

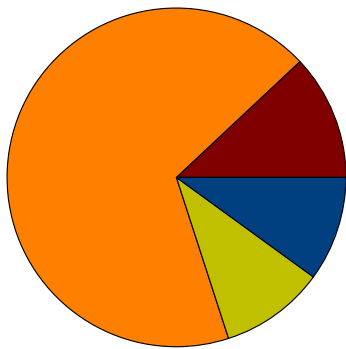

Fish Habitat Site 7 Autumn 2009

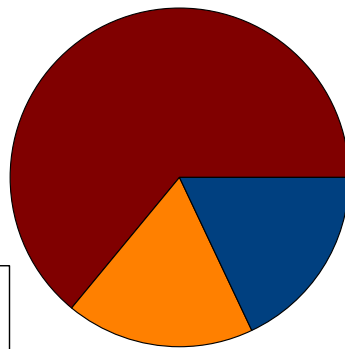

Figure 69: habitat types in each reach and habitat types selected by fish in each reach continued

Substrate and vegetation

The substrate data in Table 56, Figures 70 and 71 show that the fish also selected boulders and avoided bedrock, with no clear pattern for preferences amongst the other substrate

types. Figure 72 shows that the fish showed no preference for moss or algal cover but avoided both macrophytes and filamentous algae and favoured overhanging riparian vegetation.

General Habitat Site 1 Autumn 2008

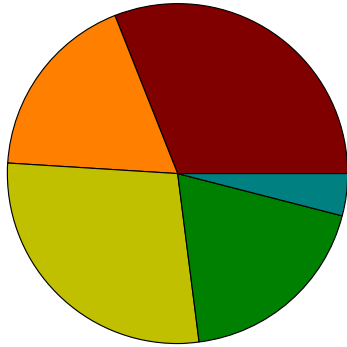

Fish Habitat Site 1 Autumn 2008

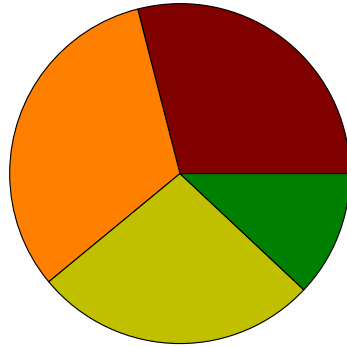

General Habitat Site 2 Autumn 2008

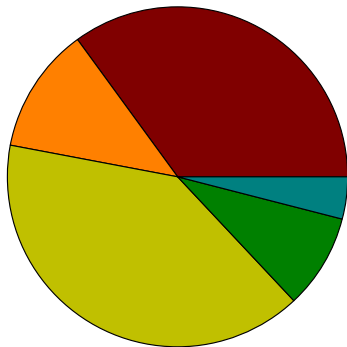

Fish Habitat Site 2 Autumn 2008

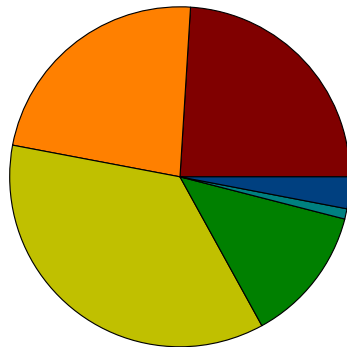

General Habitat Site 1 Spring 2009

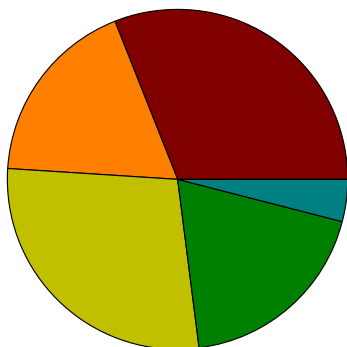

Fish Habitat Site 1 Spring 2009

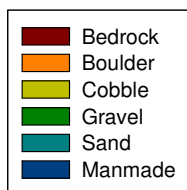
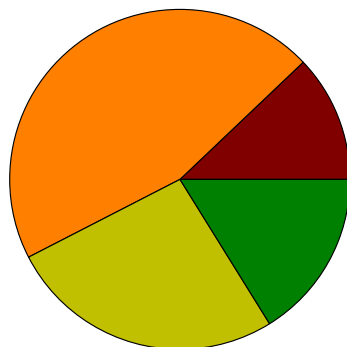
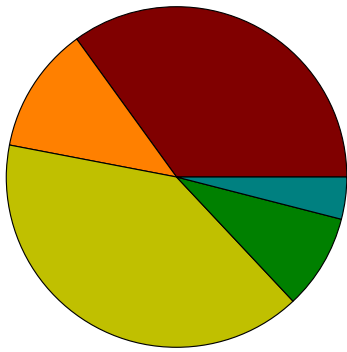
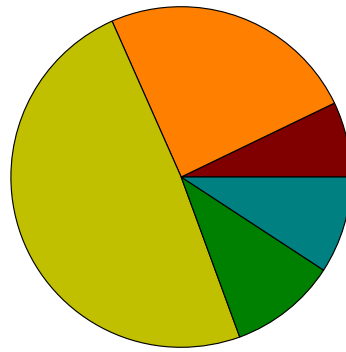

Figure 70: substrate types in each reach and substrate types selected by fish in each reach

General Habitat Site 2 Spring 2009



Fish Habitat Site 2 Spring 2009



General Habitat Site Site 5 Autumn 2009

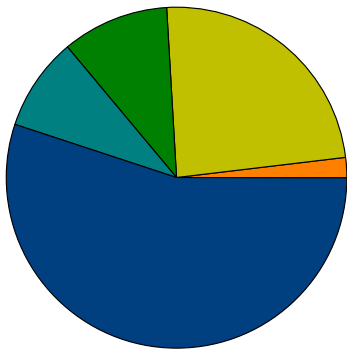

Fish Habitat Site 5 Autumn 2009

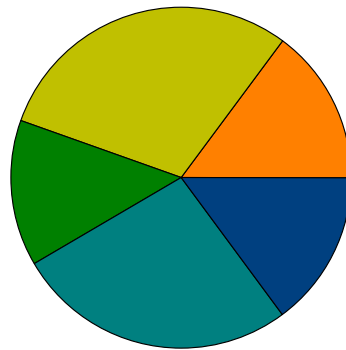

General Habitat Site 7 Autumn 2009

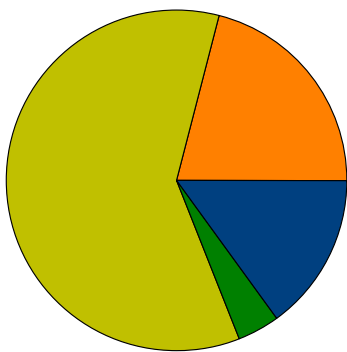

Fish Habitat Site 7 Autumn 2009

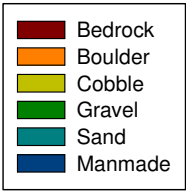
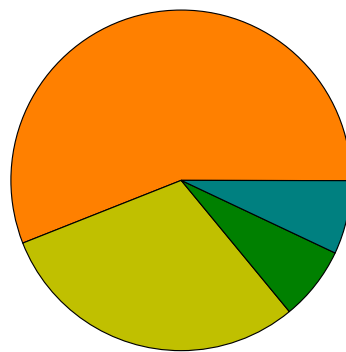

Figure 71: substrate types in each reach and substrate types selected by fish in each reach continued

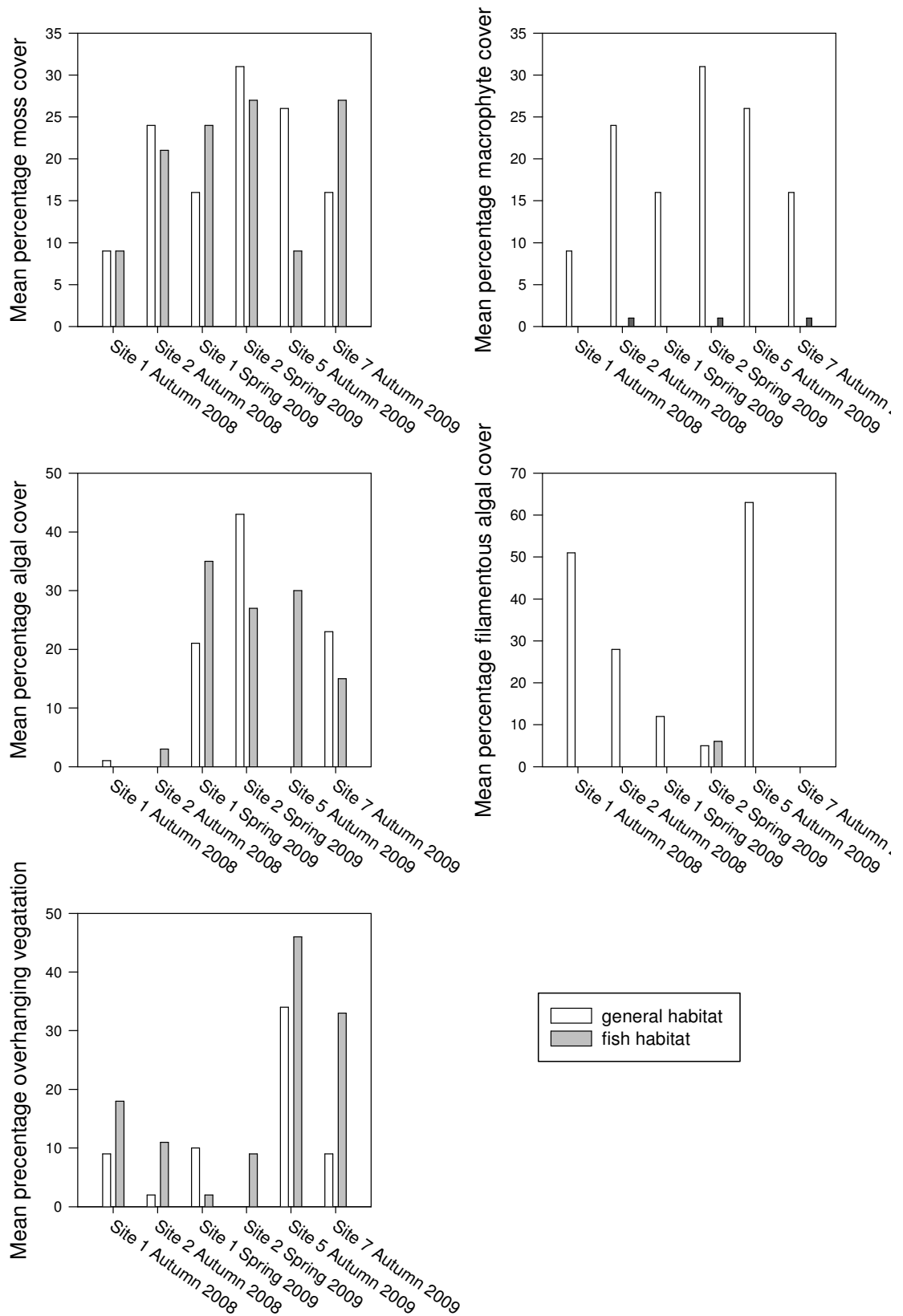

Figure 72: epiphytic and riparian vegetation in study reaches and in habitats selected by tagged fish

7.4.3 Multivariate habitat analyses

Comparisons of the habitats used by fish at high and low flows, and comparisons of the habitats used by fish in contrast to the habitat generally available in the relevant study stretches are summarised in Table 59, below.

Table 59: ANOSIM comparisons of fish habitat data against general habitat data

Site	Comparison	ANOSIM value R	<i>P</i> value	Significantly different ($P \leq 0.05$)?
1	Fish habitat high flow vs. general habitat high flow	0.247	0.1	Yes
1	Fish habitat low flow vs. general habitat low flow	0.149	0.2	Yes
1	Fish habitat low flow vs. fish habitat high flow	0.149	1.9	Yes
2	Fish habitat high flow vs. general habitat high flow	0.093	0.1	Yes
2	Fish habitat low flow vs. general habitat low flow	0.141	0.1	Yes
5	Fish habitat vs. general habitat	0.022	28.8	No
7	Fish habitat vs. general habitat	0.019	1.4	Yes

With the exception of site 5 the habitat selected by the fish is significantly different from the habitat norm at each of the sites and at both higher and lower flows. The habitat used by the fish at sites 1 and 2 also differs significantly between the higher and lower flows.

7.5 Discussion

The data show that the trout were not randomly distributed within the study streams and selected the areas of habitat most suited to their needs, verifying hypothesis 1. The data also show that fish habitat selected different habitat at varying flow levels, verifying hypothesis 2. Although the average velocities and depths increased around each fish as they do in the habitat as a whole, the fish made an increasing use of slack water and pool refugia at higher flows, moving away from the cascade areas where velocities were greatest. This ability to use different microhabitats at different times may explain the lack of response to the scour and spate releases recorded in Chapter 6. In such heterogeneous environments, different flow conditions are rarely more than a very short swim away, and other studies show that salmonids are well able to detect changes to flow (Kroese and

Schellart 1992, Kemp et al. 2008). This suggests that in the event of even very rapid increases in reservoir discharge fish should be able to find flow refugia very quickly in these streams.

The dGPS data in Figure 64, along with the photographs in Figures 65 and 66 and the habitat data in Section 7.4.1 illustrate the rugged nature of the river beds in these catchments. Hydraulic modelling and measurement of flows over similarly rough beds illustrate how the presence of boulders and cobbles (and smaller clasts) can break up flow creating areas of low velocity close to the bed and in the lee of obstacles (Lane et al. 2004, Hardy et al. 2007). As described in Section 1.9, both fish and macroinvertebrates will make use of flow refugia such as those created around larger clasts, and the nature of the river beds in the study sites suggests that refugia from high water velocities will be widely available in varying flow conditions on the river bed, in the lee of obstacles and in the interstices in the substrate.

As seen in Chapters 5 and 6, both the fish and macroinvertebrate populations were able to survive rapid changes in flow caused by the scour and spate releases. In the case of the trout, it is probable that the fish were able to find and utilise flow refugia in order to avoid downstream displacement and minimise unnecessary energy expenditure. In the case of invertebrates, creatures living in the interstices and beneath and behind stable stones may well have been completely unaffected by the changing flows, while those living on the stone surfaces and other vulnerable locations may account for the decrease in numbers seen at most sites (Lancaster and Hildrew 1993, Winterbottom et al. 1997). The potential of rugged, heterogeneous habitats to support fish and invertebrate populations is demonstrated in the use of boulder placement as a common (if unproven) river restoration technique (Kemp 2010).

7.6 Conclusions

The data presented here show that hypothesis 1, “brown trout exhibit preference for specific habitat conditions relative to the range available within the study streams” is correct: the fish were found in habitats with different depths, velocities, habitat types, substrate, and vegetation types to the reach norms. The veracity of hypothesis 2, “brown trout will alter their locations to maintain these habitat preferences as in-stream conditions change during elevated flows” is also shown using the multivariate analysis, although the

selection of individual habitat characteristics is less clear. Both the depths and velocities used by the trout show a degree of homeostasis at changing flows, and although the habitat used changed significantly, it was not necessarily in ways that may be expected.

The data in this chapter coupled with the literature relating to flow refugia provide a possible explanation for the lack of response of the brown trout to the reservoir releases and show how both fish and invertebrate populations may persist during rapid and severe flow changes in heterogeneous habitats. The data in Section 5.3.5 shows that the coverage of boulders was correlated with the resilience of invertebrate populations at the study sites, and whether or not the invertebrates actively seek out flow refugia, the presence of the boulders allows a certain proportion of the river bed to remain largely unaffected by the sudden changes in flow, allowing populations present in these sections to persist.

The knowledge that heterogeneous habitats provide a degree of protection from environmental change (Pearsons et al. 1992, Dutterer and Allen 2008) may be used to inform future reservoir management and river restoration, and will be discussed in Chapter 8.

Chapter 8: Synthesis, conclusions and recommendations

8.1 Introduction

This chapter summarises the physical and ecological impacts of short duration reservoir releases and provides guidance on managing reservoir releases with ecological sensitivity. The research questions posed and hypotheses developed in the preceding chapters are reviewed here, and this chapter also explores areas for future research in the field.

8.2 Summary of results

Following the literature review in Chapter 1, five key research questions relating to the impacts of short-duration reservoir releases were identified:

1. How do the releases affect the hydrology of the receiving water bodies?
2. Do the releases have any impact upon the water quality downstream of the reservoirs?
3. What are the impacts of the releases upon downstream fish and invertebrates?
4. What role does in-stream habitat play in determining these impacts?
5. Could it be ecologically beneficial to use the scour releases to mimic natural spate events?

These questions were explored in the subsequent chapters using specific hypotheses relating to the reservoir release impacts upon hydrology, water quality and macroinvertebrate and brown trout populations downstream of the reservoirs. In order to synthesise the findings and provide an overview it is necessary to review these hypotheses in relation to each of the key research questions above.

8.2.1. How do the releases affect the hydrology of the receiving water bodies?

Chapter 1 hypothesised that reservoir releases cause sufficiently large changes to the hydrology of the receiving streams to affect the resident biota for several kilometres downstream. The flow data recorded showed that the receiving water bodies are subject to sudden changes in flow which diminish with increasing distance from the point of release but are none-the-less detectable for several kilometres downstream. The reservoir releases in this study were not of the magnitude of the majority of those seen in the literature (Barillier et al. 1993, Paller and Saul 1996, Chung et al. 2008, Batalla and Vericat 2009,

Baldwin et al. 2010) but did achieve magnitudes of change of discharge of up to 20 times base-flow in short periods of time (Section 4.3). The nature of the changes in discharge, and the ability of the releases to move river-bed sediment (Section 4.3) suggested that the changes to hydrology may be sufficient to displace both fish and invertebrates as seen in Rader and Belish (1999), Jakob et al. (2003) and Gibbins et al. (2007) (invertebrates) and Saltveit et al. (1995), Lobón-Cerviá (1996) and Sato (2006) (fish). Equally, the rapid decrease in discharge recorded as the release valves were closed may have been sufficiently rapid to cause stranding, as recorded in Halleraker et al. (2003).

The flows recorded downstream of the study reservoirs during scour and spate releases were lower than those recorded during high-rainfall events (Section 4.3), particularly in Catchment 1, where reservoir over-spilling events were frequent during the study period. The flow data gathered suggested that any ecological impacts caused solely by a change in reservoir discharge would be longitudinally limited to the reaches immediately downstream of the reservoirs, and that the resident biota may be well equipped to deal with the changes of flow caused by the releases as they were exceeded, at least in terms of peak discharge, by relatively frequent natural flow events.

8.2.2. Do the releases have any impact upon water quality downstream of the reservoirs?

Chapter 1 also hypothesised that reservoir releases cause changes to temperature, pH, dissolved oxygen and suspended sediment levels in the receiving stream and that reservoir releases are capable of reducing the quantities of fine sediment or algae entrained in the river bed. Each of these hypotheses was shown to be correct, however, as with the changes to the hydrology of the receiving water bodies, the changes to water physio-chemistry and sediment transport were not as great as may have been predicted from the available literature, again due to the relatively small size of the study reservoirs and the origin of the water released being the same as that of the compensation release water that continually feeds the study streams.

Small changes in water temperature (both positive and negative) were recorded downstream of each of the reservoirs during the releases. None of these temperature changes exceeded 2 °C and the longitudinal extent of measurable change was 1800 m (Section 4.3). In each case the changes recorded were well within the usual daily ranges

recorded in the receiving streams and also well within the temperature ranges considered suitable for brown trout (Solbé 1997) and British Ephemeroptera (Brittain 1982).

The pH data gathered showed no clear pattern, possibly partly due to the difficulty of obtaining reliable pH readings over extended periods in turbulent water (Section 4.2). Changes were recorded in association with the reservoir releases at some of the study sites, and as the receiving millstone grit streams are naturally acidic it was felt that even a relatively minor decrease in pH may bring some of biota close to their tolerance limits. Although pH levels sometimes approached a low of 4, and decreases of up to 1 pH unit were recorded levels remained within those recommended in Solbé (1997). The lower recordings gave cause for concern and were sufficient to suggest that pH changes may be harmful at other similar reservoirs, if not those in the study catchments.

As with pH, the effects of the releases on dissolved oxygen levels downstream of the reservoirs showed no clear pattern, with both increases and decreases being recorded. The results recorded at individual reservoirs appeared to be determined by the oxygen content of the water being released and the extent to which it was re-aerated during the release process. It was noticeable that at Blackbird reservoir where the rate of discharge and the resulting turbulence were minimal dissolved oxygen levels fell away during the release, falling as far as 40 % saturation, a level sufficiently low to distress both salmonids and certain invertebrate species (Nagell 1973, Elliott 2000, Genkai-Kato et al. 2000, Connolly et al. 2004). Due to the high-gradient, bouldery nature of the receiving streams, effects on dissolved oxygen levels appeared to be longitudinally limited, with no discernable changes recorded more than a few hundred metres downstream of the release site (Section 4.3).

The clearest physio-chemical changes associated with both the scour and spate releases were the fluctuations in suspended sediment. Visual observations suggested that large quantities of fine sediment were discharged from the reservoirs during releases, however the data presented in Chapter 4 shows that large quantities of this sediment are in fact picked up from the stilling basins into which the water is discharged and from the bed and banks of the receiving streams immediately below the reservoirs. Fine sediment and algae were removed from gravels within the study catchments, as hoped for by Yorkshire Water and as intended in other experimental releases (Nelson et al. 1987, Robinson and Uehlinger 2003). The eventual fate of the transported sediment is not yet clear. Although fine

sediment was removed for several kilometres downstream it may be that the transported material is deposited in gravel beds with higher ecological value further downstream, in effect re-locating or even worsening the perceived problem. The removal of this sediment would appear to be beneficial for trout (Acornley and Sear 1999, Palm et al. 2007) and invertebrate populations (Wright et al. 2003, McManamay et al. 2010) in the reaches immediately downstream of the reservoir. The habitat data for these reaches (Section 7.4.1) show that they consist largely of boulder, cobble and bedrock substrate, larger than the clast sizes ideally suited to trout spawning (Armstrong et al. 2003), and it likely that the reservoirs prevent the passage of suitable gravels into these reaches (Barton 2004, Kay et al. 2009), denuding them of spawning and invertebrate habitat. If this is the case then regular flushing of the remaining gravels may be essential to continued trout recruitment in these reaches.

8.2.3. What are the impacts of the releases upon downstream fish and invertebrates?

The impacts of the releases upon downstream macroinvertebrate and brown trout populations were explored chapters 5 and 6 respectively. Chapter 1 hypothesised:

1. That acute flow releases from upland Yorkshire reservoirs decrease benthic macroinvertebrate abundances in streams immediately downstream.
2. That certain taxa are more vulnerable to displacement by such flows.
3. That scour releases will have a greater effect than spate releases at these sites due to the more rapid increase in discharge.
4. That any displacement effects on benthic macroinvertebrates recorded will decrease as distance from the release site increases.

The data showed decreases in abundance at the majority of macroinvertebrate sampling sites, with slight increases in abundance at the other sites. Due to the natural variation in abundance within single habitat patches the majority of these changes were not statistically significant. Significant decreases in abundance were only found following the Spring 2009 releases at sites 1 and 4. No evidence of the “catastrophic drift” described in Gibbins (2007) was seen, but the lesser washout recorded reflected that described in other studies (Boulton et al. 1992, Rader and Belish 1999, Imbert and Perry 2000).

Significant changes to community structure following the scour releases were identified at site 1 (Autumn 2008 and Spring 2009), site 3 (Autumn 2008) and site 9 (Autumn 2009) and at site 11 following the spate release in Autumn 2009. The recovery data taken in Spring and Autumn 2009 in the days following the releases showed no consistent patterns except at the heavily impacted site 1 where community structure continued to change in the days following the release to the point where the community in the final sample resembled that seen in the pre-release sample. An examination of the taxa most affected by the releases also failed to find a consistent pattern, probably partly due to differences between the fauna at each site. The Autumn / Spring timings of the releases also meant different taxa were predominant at the times of release.

The hypothesis that the scour releases would have a greater impact than the spates was unproven, as neither type of release affected the invertebrate communities greatly. Peak discharges were similar and the stepped changes to flow during the spate releases may have allowed the invertebrates more time to seek refuge (Lancaster 1999, Imbert and Perry 2000, Lancaster et al. 2006). Similarly it was not possible to test the hypothesis that proximal sites would suffer more wash-out than distal sites due to the lack of significant response seen at the majority of the proximal sites. The level of response was influenced more by in-stream habitat and magnitude of release than by proximity to the point of release.

In summary, impacts upon macroinvertebrate communities were limited, although some sites did suffer a degree of wash-out and associated community change. In each case a community remained *in situ* and populations seemed to recover within days of the release events.

Chapter 1 also posed the question: do brown trout make unusual movements in response to reservoir releases, either by migrating upstream or downstream, or being washed downstream during the enhanced flows? The movement data showed that the trout studied made limited movements throughout the study period and no unusual movements were recorded in association with the reservoir releases. No evidence of wash-out or stranding was recorded. Although no evidence of migratory movement was recorded, it is possible that releases may stimulate migratory movements in fish downstream of the study area (Archer 2008b) and may also assist fish to pass obstacles (Section 6.4.3).

8.2.4 What role does in-stream habitat play in determining these impacts?

Chapter 7 examined the results of chapters 6 in the context of the in-stream habitat in the study reaches, testing the hypotheses that:

1. Brown trout exhibit preference for specific habitat conditions relative to the range available within the study streams
2. Brown trout will alter their locations to maintain these habitat preferences as in-stream conditions change during elevated flows

The data in Section 7.4 showed that the trout did indeed exhibit preference for specific habitat conditions and that habitat use did change during elevated flows as the fish made greater use of slower waters. The nature of the stream beds in the study reaches suggested that refugia from high flows should be readily available throughout the upper reaches of the study streams. The literature shows that these refugia are likely to be used by both fish and macroinvertebrates during periods of high flows that may otherwise be threatening (Sedell et al. 1990, Winterbottom et al. 1997, Lancaster 2000, Schwartz and Herricks 2005), a theory supported by the lack of invertebrate washout and the evidence that habitat characteristics such as depth, velocity and substrate type affect invertebrate responses as seen in Chapter 4.

8.2.5 Could it be ecologically beneficial to use the scour releases to mimic natural spate events?

The impacts of the scour and spate releases are summarised in Table 62, below.

Table 60: summary of the impacts of scour and spate releases

Study Area	Main Findings
Physical effects	<ul style="list-style-type: none"> • Sudden and significant increases (and later decreases) to flows downstream of reservoirs, detectable for up to 6km • Detectable but small changes to pH, water temperature and dissolved oxygen levels during releases • All releases caused a short-lived increase in suspended sediment concentrations • Neither spate nor scour releases reach the magnitude of natural floods
Effects on macroinvertebrates	<ul style="list-style-type: none"> • Abundance of macroinvertebrates diminished at most sites • Numbers of taxa present were generally not significantly affected • Significant changes to community structures at a minority of sites
Effects on brown trout	<ul style="list-style-type: none"> • Rapid recovery at impacted sites • No downstream displacement • No upstream migration • Releases possibly allowed some fish to pass obstacles • Trout used different micro-habitats at different flows

The data gathered here show the adverse ecological effects of the scour releases to be minimal despite the sudden and substantial changes in flow and concerns about water quality, primarily because the discharge from the reservoirs matches neither the flows recorded during natural spate events in these catchments nor the peak reservoir discharges recorded in the literature (Edwards 1978, Raddum 1985, Robinson et al. 2003, Archer 2008b, Robinson and Uehlinger 2008, Rolls et al. 2011). Perhaps equally importantly the water released during the releases is the same as that used for compensation flows throughout the year, so changes to water quality are also minimal. No response was recorded in the brown trout below the reservoirs, and the wash-out seen in the invertebrate communities was limited. In the cases of both the invertebrates and the trout, habitat appeared to be a major factor in determining response.

At the time the spate release trials were introduced the aims were to increase brown trout recruitment through the cleansing of spawning beds and the provision of a stimulus to migrate, and also to take a further step towards a more natural flow regime by introducing

flow variability to these impounded catchments. Spate releases from these reservoirs are unable to exceed the maximum discharges achieved during the scour releases, but do have the theoretical advantage of a stepped increase in discharge and a longer duration. The capability also exists to discharge spate releases from several reservoirs in a single catchment simultaneously, thereby possibly increasing the impact of the releases and the distance downstream that the effects travel. The question remains as to whether even simultaneous releases would provide a stimulus for brown trout migration, as Archer (2008 b) found that Atlantic salmon did not respond as strongly to mimicked spates from Kielder reservoir as they did to natural flow events despite the much higher magnitude and duration of release achievable from the reservoir. Although enhanced flows have been shown to assist fish migration (Zabel et al. 2008, Lauritzen et al. 2010) in the long term fish passes would be a cheaper and more effective means of allowing access to currently isolated habitat than continued reservoir releases used for this purpose. The one area in which possible benefits were discernable was the cleansing of gravels for up to 2 km downstream of the point of release following both scour and spate releases, and as in unregulated systems this may be one of the key benefits of the reservoir releases.

The hydrographs from Catchment 1 show that during the study period the reservoir releases were regularly dwarfed by natural spate events (Figures 15 and 16), and the introduction of spate releases here would have no ecological benefit in these conditions. However, the hydrograph from Catchment 2 (Figure 24) shows that in 2009 the spate release was by far the biggest flow event recorded and was directly comparable in size to the larger floods recorded here in the preceding three years (Figure 25). In such conditions, when abstraction is high or reservoirs do not overflow regularly the flow variability and cleansing properties of the spate releases are likely to be far more ecologically beneficial.

Despite the lack of recorded benefits it may also be that the increase in reservoir discharge variability is good in itself, and such flow variability is a keystone in the building block methodology (King et al. 2008) and natural flow paradigm (Poff et al. 1997, Enders et al. 2009). The natural flow paradigm in particular recognises the importance of an ecosystem approach rather than a single species approach to flow restoration, and it is certainly possible that mimicked spate flows (and also even scour releases) may bring benefits not detected in the project. In answer to the key question above, it could be ecologically

beneficial to use modified scour releases to mimic natural spate events, however the intended benefits are unproven and spate releases would serve little purpose in catchments where over-spilling of the reservoirs is frequent and in catchments where heavy rainfall events are common.

8.3 Future reservoir release management

With regard to the management and planning of future releases, the data in Chapter 4 show that the release-water quality is variable from site to site, even within a single catchment, and although no harmful effects were recorded here it is possible that water quality in other reservoirs may be poor (Petts 1984, Craig and Kemper 1985, Abesser and Robinson 2010), and the potential for ecological harm much greater. Deeper reservoirs with no through-flow are likely to cause greater changes to water chemistry and sediment budget and are also more likely to contain toxins in the sediment released with the water due to the longer residence time. In terms of changes to flow alone, reservoirs capable of producing discharges greater than those seen during a regular (perhaps one to five year) flood event are more likely to cause washout of invertebrates and fish. Similarly, those discharging into lower gradient, less spate-prone water courses where the resident biota is less well adapted to cope are likely to be far more problematic. Manmade water courses with little habitat complexity will also be more prone to wash out due to the lack of flow refugia (Robinson et al. 2011).

The majority of research into the mitigation of adverse consequences of reservoir releases has focused on hydropower schemes where hydro-peaking severely disrupts natural flow patterns (Fraleay et al. 1989, Cada 1998, Renofalt et al. 2010). Scour releases present slightly different problems and opportunities. Releases are far less regular (twice yearly for UK operators) and the only requirement is that the release valve is opened and closed fully. Thus investment in mitigation may be less due to the relatively few events at each reservoir, but the scope for management may be greater. At reservoirs where scour releases cannot be avoided and problems are likely to occur mitigation measures are certainly possible. Available measures come in two forms:

1. measures to combat poor water quality; and
2. measures to protect biota from dramatic flow changes

Water quality in reservoirs is routinely managed for a variety of reasons, commonly a lack of dissolved oxygen (Bednarek and Hart 2005), water temperature (Olden and Naiman 2010b) and an excess of nutrients leading to algal blooms (Kuusemets and Mander 2001). Water quality problems are typically alleviated either by using multi-level draw-offs to ensure water is either drawn from the surface or well-mixed, or by the management of water intake through the use of residuum lodges, stilling pools (Chapter 1) or catchment management. Although several UK reservoirs are equipped with multi-level draw-off valves (Section 3.2.1), and they are utilised during scour releases, the purpose of the release is to test the ability of the bottom-most release valve, requiring some quantity of water to be drawn from deep in the reservoir.

As many of the water quality problems occurring in reservoirs are a result of stratification and long residence times, mechanical mixing is a further mitigation option (Oskam 1995, Lewis et al. 2003, Bergman 2007) and can be used to alleviate problems with water temperature, oxygen saturation and chemistry. Constant mixing is an extremely costly option, particularly in an environment like the UK, where water supply tends to come from a large number of small reservoirs, rather than a small number of large reservoirs necessitating a much greater number of mixers.

As demonstrated in Chapter 4, dissolved oxygen problems can be treated at the point of release by ensuring the water mixes sufficiently with air as it is discharged. Where this does not occur a simple adjustment of the release pipe can ensure that water discharges into air rather than directly into the receiving water course. Passage through air may also help alleviate water temperature problems by reversing the insulating effect of the reservoir, but care must be taken to avoid super-saturation of released water with atmospheric gases (Dawson and Marking 1986, Gunnarsli et al. 2008).

A further possibility for mitigation against the effects of rapidly changing flows is the artificial enhancement of habitat complexity (Kemp 2010). Boulders are often added to river beds to enhance fisheries by providing “lies” for fish, but also provide refugia in high flows for both fish and invertebrates.

As with scour releases, the impacts of the spate releases are largely dependant on individual reservoir design and catchment characteristics, and the decision to introduce

spate releases should be taken on a site by site basis for both financial and ecological reasons. Dipper reservoir is capable of one of the greatest rates of discharge in the Yorkshire Water catchment but cannot achieve the river flow seen during a large natural flood so it is unlikely that spate releases will ever have the same impacts as their natural counterparts and so they can only be of limited value in years when reservoirs are overflowing regularly leading into the salmonid spawning season. However, in drier years such as 2009 when reservoirs had not over-spilled for several months leading into the Autumn release period then spate releases may play a much more important role in improving gravel beds prior to spawning and also in attracting fish upstream. In industrialised environments such as the Yorkshire Water catchment barriers to migration are common and vary greatly in size. It is possible that a small and temporary increase in discharge in a dry year could allow migratory fish to access otherwise unreachable sections of river, greatly increasing the available spawning area.

8.4 A wider perspective

This study builds upon the work of Armitage (1976, 1977a, 1977b, 2006), Crisp (1977, 1983, 1983, 1990) and Petts (1984, 1986) examining the physical and ecological implications of reservoir construction and operation. It also adds to the expanding knowledge base regarding managing reservoir releases for environmental gain for example Mould (2006) and Acreman (2004, 2007). Crucially, the releases examined here are from relatively small reservoirs (less than 6000 tcm) and, in the case of scour releases, are regular legal and operational requirements rather than an occasional experimental or management tool or daily hydro-peaking flows.

At the outset of this study the physical and ecological consequences of short-duration reservoir releases were largely unknown, and the work described in the previous chapters advances the understanding of the impacts of the commonly-used scour releases. Although more studies have been conducted on the longer-duration spate releases, the reservoirs studied were generally much larger than those seen here and the studies were very specific, providing information solely on particular areas of interest such as salmonid migration or sediment transport. This work provides a fuller physical and ecological audit of both spate and scour releases and the findings may be used to inform reservoir operators planning to introduce spate releases or manage scours in comparable catchments.

Scour releases are performed by all UK reservoir operators, often from reservoirs of a comparable size, and are also performed in many other countries in comparable environments. Interest from other water companies and the growing literature on mimicked spate releases also indicates that the use of spate releases as an ecological tool is becoming more widespread. Although caution should be used in applying this research to other reservoirs and catchments, the work provides an insight into the likely outcomes of similar releases.

In Chapter 1 the relevance of this project to current legislation, in particular the European Water Framework Directive, was discussed. It was one of intentions of Yorkshire Water and the Environment Agency that mimicked spate releases may be used to help heavily modified water bodies to achieve “good ecological potential”. The directive lists “hydromorphological contributors... hydrological regime, river continuity and morphological conditions” as factors to be considered in the assessment of ecological potential. Each of these factors may be influenced by reservoir operation, and hydrological regime in particular may be altered by the use of spate flows. Although this study showed no direct benefits to either fish or macroinvertebrate populations, the directive recognises the potential benefits of a holistic rather than a species-based management approach. This study showed that spate releases may be important contributors to hydrological variability in periods or catchments where natural spates are scarce. Due to the high rainfall and the large numbers of reservoirs constructed during the industrial revolution the pressure on water resources in the Yorkshire Water catchment is not particularly intense, and reservoir overspilling is common, negating the need for engineered spates in many of the catchments. However, in other areas of the UK (notably the south-east) and elsewhere around the globe water resources are scarce and dams are likely to have an even greater effect upon hydrological regime, and it is in these areas that spate releases may show much clearer benefit.

8.5 Potential for further research

A number of questions have arisen following the study which would warrant further investigation for both managerial and scientific purposes:

- 1. The origin and fate of the transported sediment.** Each release resulted in a clear pulse of suspended sediment in the water column, and gravel beds close to the point of origin showed reduced levels of fine sediment and algal cover following releases. The origin and fate of this sediment remains unclear and it is possible that it contains toxins from deep in the reservoir (Chung et al. 2008) and may clog gravel beds when deposited downstream (Acornley and Sear 1999, Walling et al. 2003).
- 2. Fish behaviour during releases and floods.** Although the use of PIT tags showed that fish were neither washed out nor led to migrate upstream, the precise locations of individual fish during high flows could not be ascertained due to the risk involved when using the hand-held detector. Radio tagging a smaller number of trout would allow the study of individual fish behaviour (Lucas and Baras 2000, Lucas and Baras 2001, Enders et al. 2007) and in conjunction with further habitat mapping would allow a greater understanding of their behaviour during rapidly changing flows. The possibility also remains that the releases do attract fish from longer distances downstream. Radio tracking of sexually mature adult fish from areas in which spawning habitat is unavailable may help address this question. Similar research on Atlantic salmon shows that fish do respond to artificial releases, but to a lesser extent than they would to a natural spate (Archer 2008b).
- 3. Effects on other species.** Although brown trout were the only species found at the majority of the study sites, bullhead (*Cottus gobio*) are also found below several other reservoirs and are of considerable conservation interest (Knaepkens et al. 2004). Bullhead are generally too small to be either PIT or radio tagged, but their responses may be important to dictate future management under the European Habitats Directive (92/43/EEC) and UK Biodiversity Action Plan (JNCC 1994), as may the responses of other species found outside the Yorkshire Water catchment area. The increasing interest in restoring Atlantic salmon to their former habitats, and attempts by other reservoir operators to use spate releases to attract salmon upstream suggest that the responses of this species to releases from relatively small reservoirs such as those studied here should also be investigated.
- 4. Identification of flow refugia.** Although the theory of flow refugia is relatively well developed (Section 1.9) there has been little work conclusively

demonstrating the use of the refugia in an in-stream environment. In this situation, this would require accurate radio-tracking of fish during high flows along with the construction of high-definition maps of the associated river bed (achievable with differential GPS). Flows could then be modelled over these maps (as in Lane 2004 and Hardy 2007) at the discharges at which the fish locations had been recorded. It has been shown in flumes that macroinvertebrates are capable of persisting in refugia during high flows (Lancaster and Hildrew 1993, Lancaster 1999, 2000), and proof that fish use refugia during reservoir releases may assist the development of artificial habitat heterogeneity as a tool to mitigate against ecological harm in situations where wash-out is likely.

References

- 92/43/EEC. 1992. European Commission Habitats Directive.
- Aarestrup, K., and N. Jepsen. 1998. Spawning migration of sea trout (*Salmo trutta* (L.)) in a Danish river. *Hydrobiologia* **371-372**:275 - 281.
- Abesser, C., and R. Robinson. 2010. Mobilisation of iron and manganese from sediments of a Scottish upland reservoir. *Journal of Limnology* **69**:42 - 53.
- Abrahams, P. W., M. Tranter, T. D. Davies, and I. L. Blackwood. 1989. Geochemical studies in a remote Scottish upland catchment 2 - stream water chemistry during snow-melt. *Water Air and Soil Pollution* **43**:231 - 248.
- Acolas, M. L., J.-M. Roussel, J. M. Lebel, and J. L. Bagliniere. 2007. Laboratory experiment on survival, growth and tag retention following PIT injection into the body cavity of juvenile brown trout (*Salmo trutta*). *Fisheries Research* **86**:280 - 284.
- Acornley, R. M., and D. A. Sear. 1999. Sediment transport and siltation of brown trout (*Salmo trutta* L.) spawning gravels in chalk streams. *Hydrological Processes* **13**:447 - 458.
- Acou, A., P. Laffaille, A. Legault, and E. Feunteun. 2008. Migration pattern of silver eel (*Anguilla anguilla*) in an obstructed river system. *Ecology of Freshwater Fish* **17**:432 - 442.
- Acreman, M. 2007. Guidance on environmental flow releases from impoundments to implement the Water Framework Directive. Scotland and Northern Ireland Forum for Environmental Research, Edinburgh, UK.
- Acreman, M., J. Aldrick, C. Binnie, A. R. Black, I. Cowx, H. Dawson, M. J. Dunbar, C. Extence, J. Hannaford, A. Harby, N. Holmes, N. Jarrit, G. Old, G. Peirson, J. Webb, and P. Wood. 2009. Environmental flows from dams: the Water Framework Directive. *Proceedings of the Institution of Civil Engineers - Engineering Sustainability* **162**:13 - 22.
- Acreman, M., and M. J. Dunbar. 2004. Defining environmental river flow requirements - a review. *Hydrology and Earth System Sciences* **85**:861 - 876.
- Acreman, M. C., and A. J. D. Ferguson. 2010. Environmental flows and the European Water Framework Directive. *Freshwater Biology* **55**:32 - 48.
- Adams, N. S., D. W. Rondorf, S. D. Evans, J. E. Kelly, and R. W. Perry. 1998. Effects of surgically and gastrically implanted radio transmitters on swimming performance and predator avoidance of juvenile chinook salmon (*Oncorhynchus tshawytscha*). *Canadian Journal of Fisheries and Aquatic Science* **55**:781 - 787.
- Allen, J. D. 1995. *Stream Ecology - Structure and Function of Running Waters*. 1st edition. Chapman & Hall, London.
- Anderson, T. W. 2001. Predator responses, prey refuges, and density-dependent mortality of a marine fish. *Ecology* **82**:245 - 257.
- Archer, D. 2008a. The influence of river regulation at Kielder Water on the thermal regime of the River North Tyne. British Hydrological Society 10th National Hydrology Symposium, Exeter.
- Archer, D. 2008b. The role of regulating releases and natural spates on salmonid migration in the River Tyne, north-east England. *in* British Hydrological Society 10th National Hydrology Symposium, Exeter.
- Armitage, P. D. 1976. A quantitative study of the invertebrate fauna of the River Tees below Cow Green Reservoir. *Freshwater Biology* **6**:229 - 240.

- Armitage, P. D. 1977a. Downstream changes in the composition, numbers and biomass of bottom fauna in the Tees below Cow Green Reservoir and in an unregulated tributary Maize Beck, in the first five years after impoundment. *Hydrobiologia* **58**:145 - 156.
- Armitage, P. D. 1977b. Invertebrate drift in the regulated River Tees and an unregulated tributary Maize Beck, below Cow Green dam. *Freshwater Biology* **7**:167 - 183.
- Armitage, P. D. 1983. Chironomidae from Cow Green reservoir and its environs in the first years of its existence (1970 - 1977). *Aquatic Insects* **5**:115 - 130.
- Armitage, P. D. 2006. Long-term faunal changes in a regulated and an unregulated stream - Cow Green thirty years on. *River Research and Applications* **22**:947 - 966.
- Armitage, P. D., D. Moss, J. F. Wright, and M. T. Furse. 1983. The performance of a new biological water quality score system based on macroinvertebrates over a wide range of unpolluted running-water sites. *Water Research* **17**:333-347.
- Armstrong, J. D., P. S. Kemp, G. J. A. Kennedy, M. Ladle, and N. J. Milner. 2003. Habitat requirements of Atlantic salmon and brown trout in rivers and streams. *Fisheries Research* **62**:143 - 170.
- Arthur, J. W., J. A. Zischke, and G. L. Ericksen. 1982. Effect of elevated water temperature on macroinvertebrate communities in outdoor experimental channels. *Water Research* **16**:1465 - 1477.
- Bachman, R. A. 1984. Foraging behaviour of free-ranging wild and hatchery brown trout in a stream. *Transactions of the American Fisheries Society* **113**:1 - 32.
- Baldwin, D. S., J. Wilson, H. Gigney, and A. Boulding. 2010. Influence of extreme drawdown on water quality downstream of a large water storage reservoir. *River Research and Applications* **26**:194 - 206.
- Bardonnet, A., and M. Heland. 1994. The influence of potential predators on the habitat preference of emerging brown trout. *Journal of Fish Biology* **45**:131 - 142.
- Barillier, A., J. Garnier, and M. Coste. 1993. Experimental reservoir water release: impact on the water quality on a river 60 km downstream (Upper Seine River, France). *Water Research* **27**:635 - 643.
- Barton, G. J. 2004. Characterization of channel substrate and changes in suspended sediment transport and channel geometry in white sturgeon spawning habitat in the Kootenai River near Bonners Ferry, Idaho, following the closure of Libby Dam. US Geological Survey.
- Batalla, R. J., and D. Vericat. 2009. Hydrological and sediment transport dynamics of flushing flows: implications for management for large mediterranean rivers. *River Research and Applications* **25**:297 - 314.
- Bateman, D. S., R. E. Gresswell, and A. M. Berger. 2009. Passive integrated transponder tag retention in headwater populations of coastal cutthroat trout. *North American Journal of Fisheries Management* **29**:653 - 657.
- Bednarek, A. T., and D. D. Hart. 2005. Modifying dam operations to restore rivers: Ecological responses to Tennessee river dam mitigation. *Ecological Applications* **15**:997 - 1008.
- Belaud, A., P. Chaverroche, P. Lim, and C. Sabaton. 1989. Probability-of-use curves applied to brown trout *Salmo trutta fario* L. in rivers of Southern France. *Regulated Rivers Research and Management* **3**:321 - 336.
- Benke, A. C. 2001. Importance of flood regime to invertebrate habitat in an unregulated river-floodplain ecosystem. *Journal of the North American Benthological Society* **20**:225 - 240.
- Bergey, E. A. 1999. Crevices as refugia for stream diatoms: effect of crevice size on abraded substrates. *Limnology and Oceanography* **44**:1522 - 1529.

- Bergman, C. E. 2007. A circulation apparatus to reduce evaporation and enhance water quality of surface water reservoirs. 2nd IASTED International Conference on Water Resources Management, Honolulu.
- Bicudo, J. R., and M. F. Giorgetti. 1991. The effect of strip bed roughness on the reaeration rate coefficient. *Water Science and Technology* **23**:1929 - 1939.
- Black, A. R., J. S. Rowan, R. W. Duck, O. M. Bragg, and B. E. Clelland. 2005. DHRAM: a method for classifying river flow regime alterations for the EC Water Framework Directive. *Aquatic Conservation - Marine and Freshwater Ecosystems* **15**:427 - 446.
- Bolland, J. D. 2008. PhD Thesis: Factors affecting the dispersal of coarse fish. University of Hull, Hull.
- Bolland, J. D., I. G. Cowx, and M. C. Lucas. 2009. Evaluation of VIE and PIT tagging for juvenile cyprinid fishes. *Journal of Applied Ichthyology* **25**:381 - 386.
- Bolland, J. D., I. G. Cowx, and M. C. Lucas. 2010. Retention of Panjet-applied alcian blue by cyprinids. *Journal of Fish Biology* **76**:1015 - 1018.
- Bott, T. L. 1996. Primary productivity and community respiration. Pages 533 - 556 in F. R. Hauer and G. A. Lambretti, editors. *Methods in Stream Ecology*. Academic Press, San Diego.
- Boulton, A. J., C. G. Peterson, N. B. Grimm, and S. G. Fisher. 1992. Stability of an aquatic macroinvertebrate community in a multiyear hydrologic disturbance regime. *Ecology* **73**:2192 - 2207.
- Bovee, K., and R. T. Milhous. 1978. Hydraulic simulation in instream flow studies: theory and techniques. U.S. Fisheries and Wildlife Service, Washington D.C. USA.
- Bovee, K. D. 1978. Probability-of-use criteria for the family Salmonidae. Cooperative Instream Service Group, Fort Collins, USA.
- Bowler, K. C., and A. R. Cossins. 1987. *Temperature Biology of Animals*. 1st edition. Chapman and Hall, New York.
- Bridcut, E. E., and P. S. Giller. 1993. Movement and site fidelity in young brown trout *Salmo trutta* populations in a southern Irish stream. *Journal of Fish Biology* **43**:889 - 899.
- Brittain, J. E. 1982. Biology of mayflies. *Annual Review of Entomology* **27**:119 - 147.
- Brittain, J. E., and T. J. Eikeland. 1988. Invertebrate drift - a review. *Hydrobiologia* **166**:77 - 93.
- Brooks, A. J., T. Haeusler, I. Reinfelds, and S. Williams. 2005. Hydraulic microhabitats and the distribution of macroinvertebrate assemblages in riffles. *Freshwater Biology* **50**:331 - 344.
- Brown, B. L. 2007. Habitat heterogeneity and disturbance influence patterns of community temporal variability in a small temperate stream. *Hydrobiologia* **586**:93 - 106.
- Brown, D. J. A. 1983. Effect of calcium and aluminum concentrations on the survival of brown trout (*Salmo trutta*) at low pH. *Bulletin of Environmental Contamination and Toxicology* **30**:582 - 587.
- Bryce, S. A., G. A. Lomnický, and P. R. Kaufmann. 2010. Protecting sediment-sensitive aquatic species in mountain streams through the application of biologically based streambed sediment criteria. *Journal of the North American Benthological Society* **29**:657 - 672.
- Bubb, D. H., M. C. Lucas, T. J. Thom, and P. Rycroft. 2002. The potential use of PIT telemetry for identifying and tracking crayfish in their natural environment. *Hydrobiologia* **483**:225 - 230.

- Bubb, D. H., T. J. Thom, and M. C. Lucas. 2006. Movement patterns of the invasive signal crayfish determined by PIT telemetry. *Canadian Journal of Zoology* **84**:1202 - 1209.
- Buffam, I., H. Laudon, J. Temnerud, C. M. Morth, and K. Bishop. 2007. Landscape-scale variability of acidity and dissolved organic carbon during spring flood in a boreal stream network. *Journal of Geophysical Research - Biogeosciences* **112**.
- Buffin-Belanger, T., S. Rice, I. Reid, and J. Lancaster. 2006. Spatial heterogeneity of near-bed hydraulics above a patch of gravel. *Water Resources Research* **42**.
- Bunn, S. E., and A. H. Arthington. 2002. Basic principles and ecological consequences of altered flow regimes for aquatic biodiversity. *Environmental Management* **30**:492 - 507.
- Burt, D. W., and J. H. Mundie. 1986. Case histories of regulated stream flow and its effects on salmonid populations. *Canadian Technical Report of Fisheries and Aquatic Sciences* **1477**:1 - 98.
- Cada, G. F. 1998. Efforts to reduce the impacts of hydroelectric power production on reservoir fisheries in the United States. *International Review of Hydrobiology* **83**:43 - 50.
- Carron, J. C., and H. Rajaram. 2001. Impact of variable reservoir releases on management of downstream water temperatures. *Water Resources Research* **37**:1733 - 1743.
- Castro-Santos, T., A. Haro, and S. Walk. 1996. A passive integrated transponder (PIT) tag system for monitoring fishways. *Fisheries Research* **28**:253 - 261.
- Cereghino, R., P. Cugny, and P. Lavandier. 2002. Influence of intermittent hydropeaking on the longitudinal zonation patterns of benthic invertebrates in a mountain stream. *International Review of Hydrobiology* **87**:47 - 60.
- Chapman, D. W. 1988. Critical review of variables used to define effects on fines in redds of large salmonids. *Transactions of the American Fisheries Society* **117**:1 - 21.
- Charles, K., R. Guyomard, B. Hoyheim, D. Ombredane, and J. L. Bagliniere. 2005. Lack of genetic differentiation between anadromous and resident sympatric brown trout (*Salmo trutta*) in a Normandy population. *Aquatic Living Resources* **18**:65 - 69.
- Chung, S. E., I. H. Ko, and Y. K. Kim. 2008. Effect of reservoir flushing on downstream river water quality. *Journal of Environmental Management* **86**:139 - 147.
- Clarke, K. R., and R. N. Gormley. 2006. *Primer v6: User Manual / Tutorial*. 1st edition. Primer-E, Plymouth, UK.
- Clarke, K. R., and R. M. Warwick. 2001. *Change in marine communities: an approach to statistical analysis and interpretation*. 2nd edition. Primer-E, Plymouth, UK.
- Collier, K. J. 2002. Effects of flow regulation and sediment flushing on instream habitat and benthic invertebrates in a New Zealand river influenced by a volcanic eruption. *River Research and Applications* **18**:213 - 226.
- Connolly, N. M., M. R. Crossland, and R. G. Pearson. 2004. Effect of low dissolved oxygen on survival, emergence, and drift of tropical stream macroinvertebrates. *Journal of the North American Benthological Society* **23**:251 - 270.
- Connolly, P. J., I. A. Jezorek, K. D. Martens, and E. F. Prentice. 2008. Measuring the performance of two stationary interrogation systems for detecting downstream and upstream movement of PIT-tagged salmonids. *North American Journal of Fisheries Management* **28**:402 - 417.
- Cookingham, M. N., and C. R. Ruetz III. 2008. Evaluating passive integrated transponder tags for tracking movements of round gobies. *Ecology of Freshwater Fish* **17**:303 - 311.

- Cortes, R. M. V., M. T. Ferreira, S. V. Oliveira, and F. Godinho. 1998. Contrasting impact of two small dams on macroinvertebrates of two Iberian mountain rivers. *Hydrobiologia* **389**:51-61.
- Cotel, A. J., P. W. Webb, and H. Tritico. 2006. Do brown trout choose locations with reduced turbulence? *Transactions of the American Fisheries Society* **135**:610 - 619.
- Cox, T. J. 2000. Thermal tolerances of two stream invertebrates exposed to diurnally varying temperature. *New Zealand Journal of Marine and Freshwater Research* **34**:203 - 208.
- Craig, J. F., and J. F. Kemper. 1985. *Regulated Streams - Advances in Ecology*. 3rd edition. Plenum Press, New York.
- Crisp, D. T. 1993. The environmental requirements of salmon and trout in fresh water. *Freshwater Forum* **3**:172 - 202.
- Crisp, D. T. 1994. Reproductive investment of female brown trout, *Salmo trutta* L. in a small stream and reservoir system in northern England. *Journal of Fish Biology* **44**:343 - 349.
- Crisp, D. T., and G. Howson. 1982. Effect of air temperature upon mean water temperature in streams in the north Pennines and English Lake District. *Freshwater Biology* **12**:359 - 367.
- Crisp, D. T., and R. H. K. Mann. 1991. Effects of impoundment on populations of Bullhead *Cottus gobio* L. and Minnow, *Phoxinus phoxinus* L. in the basin of Cow Green Reservoir. *Journal of Fish Biology* **38**:109 - 120.
- Crisp, D. T., R. H. K. Mann, and P. R. Cubby. 1983. Effects of regulation of the River Tees upon fish populations below Cow Green Reservoir. *Journal of Applied Ecology* **20**:371 - 386.
- Crisp, D. T., R. H. K. Mann, and P. R. Cubby. 1990. Effects of impoundment upon trout (*Salmo trutta*) in the basin of Cow Green Reservoir. *Journal of Applied Ecology* **27**:1020 - 1041.
- Crisp, D. T., R. H. K. Mann, and J. C. McCormack. 1978. Effects of impoundment and regulation upon stomach contents of fish at Cow Green, Upper Teesdale. *Journal of Fish Biology* **12**:287 - 301.
- Croft, P. S. 1986. A Key to the Major Groups of Freshwater Invertebrates. *Field Studies* **6**:531 - 579.
- Crosa, G., E. Castelli, G. Gentili, and P. Espa. 2010. Effects of suspended sediments from reservoir flushing on fish and macroinvertebrates in an alpine stream. *Aquatic Sciences* **72**:85 - 95.
- Cucherousset, J., J.-M. Roussel, R. Keeler, R. A. Cunjak, and R. Stump. 2005. The use of two new portable 12mm PIT tag detectors to track small fish in shallow streams. *North American Journal of Fisheries Management* **25**:270 - 274.
- Cummins, K. W. 1973. Trophic Relations of Aquatic Insects. *Annual Review of Entomology* **18**:183-206.
- Cummins, K. W., and M. J. Klug. 1979. Feeding ecology of stream invertebrates. *Annual Review of Ecological Systems* **10**:147-172.
- Dahms, H. U., and P. Y. Qian. 2004. Drift-pump and drift-net - two devices for the collection of bottom-near drifting biota. *Journal of Experimental Marine Biology and Ecology* **301**:29-37.
- Dare, M. R., and W. A. Hubert. 2003. Use of similar habitat by cutthroat trout and brown trout in a regulated river during winter. *Northwest Science* **77**:34 - 45.
- Dawson, V. K., and L. L. Marking. 1986. An integrated system for treating nitrogen supersaturated water. *Progressive Fish Culturist* **48**:281 - 284.

- DeSmet, S. 2010. MSc Thesis: Impacts of reservoir spate and scour releases on sediment balance and movement in an upland river system. University of Leeds, Leeds.
- Dickerson, B. R., and G. L. Vinyard. 1999. Effects of high chronic temperatures and diel temperature cycles on the survival and growth of Lahontan cutthroat trout. *Transactions of the American Fisheries Society* **128**:516 - 521.
- Dieterman, D. J., and R. J. H. Hoxmeier. 2009. Instream evaluation of passive integrated transponder retention in brook trout and brown trout: effects of season, anatomical placement, and fish length. *North American Journal of Fisheries Management* **29**:109 - 115.
- Dionne, D., and N. Thérien. 1997. Minimizing environmental impacts of hydroelectric reservoirs through operational control: a generic approach to reservoirs in northern Quebec. *Ecological Modelling* **105**:41 - 63.
- Downes, B. J., L. A. Barmuta, P. G. Fairweather, D. P. Faith, M. J. Keough, P. S. Lake, B. D. Mapstone, and G. P. Quinn. 2003. *Monitoring Ecological Impacts: Concepts and Practice in Flowing Waters*. 2nd edition. Cambridge University Press, Cambridge, UK.
- Dudgeon, D. 1993. The effects of spate-induced disturbance, predation and environmental complexity on macroinvertebrates in a tropical stream. *Freshwater Biology* **30**:189 - 197.
- Dutterer, A. C., and M. S. Allen. 2008. Spotted sunfish habitat selection at three Florida rivers and implications for minimum flows. *Transactions of the American Fisheries Society* **137**:454 - 466.
- Dynesius, M., and C. Nilsson. 1994. Fragmentation and flow regulation of river systems in the northern third of the world. *Science* **266**:753 - 762.
- Dziewulska, K., and J. Domagala. 2006. Body size versus gonad maturation form in under-yearling precocious males of the sea trout (*Salmo trutta m. trutta*). *Reproduction Nutrition Development* **46**:689 - 698.
- Echevarria, F., and J. Rodriguez. 1994. The size structure of plankton during a deep bloom in a stratified reservoir. *Hydrobiologia* **284**:113 - 124.
- Edington, J. M., and A. G. Hildrew. 2005. *A Revised Key to the Caseless Caddis Larvae of the British Isles*. 2nd edition. Freshwater Biological Association, Ambleside, UK.
- Edwards, M. R., D. L. Combs, S. B. Cook, and M. Allen. 2003. Comparison of single-pass electrofishing to depletion sampling for surveying fish assemblages in small warmwater streams. *Journal of Freshwater Ecology* **18**:625 - 634.
- Edwards, R. J. 1978. The effect of hypolimnion reservoir releases on fish distribution and species diversity. *Transactions of the American Fisheries Society* **107**:71 - 77.
- EEC. 2000. European Water Framework Directive (2000). 2000/60/EC. in D. o. F. a. R. Affairs, editor. Official Journal of the European Communities.
- Eklov, P., and L. Persson. 1996. The response of prey to the risk of predation: proximate cues for refuging juvenile fish. *Animal Behaviour* **51**:105 - 115.
- Elliott, J. M. 1977. *Some Methods for the Statistical Analysis of Samples of Benthic Invertebrates*. 2nd edition. Freshwater Biological Association, Ambleside, UK.
- Elliott, J. M. 1994. *Quantitative Ecology and the Brown Trout*. 1st edition. Oxford University Press, Oxford, UK.
- Elliott, J. M. 2000. Pools as refugia for brown trout during two summer droughts: trout responses to thermal and oxygen stress. *Journal of Fish Biology* **56**:938 - 948.
- Elliott, J. M., U. H. Humpesch, and T. T. Macan. 1988. *Larvae of the British Ephemeroptera - A Key with Ecological Notes*. 1st edition. Freshwater Biological Association, Ambleside, UK.

- Elso, J. I., and L. A. Greenberg. 2001. Habitat use, movements and survival of individual 0+ brown trout (*Salmo trutta*) during winter. *Archiv fur Hydrobiologie* **152**:279 - 295.
- Enders, E. C., K. D. Clarke, C. J. Pennell, L. M. N. Ollerhead, and D. A. Scruton. 2007. Comparison between PIT and radio telemetry to evaluate winter habitat use and activity patterns of juvenile Atlantic salmon and brown trout. *Hydrobiologia* **582**:231-242.
- Enders, E. C., D. A. Scruton, and K. D. Clarke. 2009. The natural flow paradigm and Atlantic salmon - moving from concept to practice. *River Research and Applications* **25**:2 - 15.
- Extence, C. A., D. M. Balbi, and R. P. Chadd. 1999. River flow indexing using British benthic macroinvertebrates: a framework for setting hydroecological objectives. *Regulated Rivers: Research & Management* **15**:543 - 574.
- Faulkner, H., and G. H. Copp. 2001. A model for accurate drift estimation in streams. *Freshwater Biology* **46**:723-733.
- Feuchtmayr, H., D. McKee, I. F. Harvey, D. Atkinson, and B. Moss. 2007. Response of macroinvertebrates to warming, nutrient addition and predation in large-scale mesocosm tanks. *Hydrobiologia* **584**:425 - 432.
- Flodmark, L. E. W., T. Forseth, J. H. L'Abée-Lund, and L. A. Vollestad. 2006. Behaviour and growth of juvenile brown trout exposed to fluctuating flow. *Ecology of Freshwater Fish* **15**:57 - 65.
- Foulger, T. R., and G. E. Petts. 1984. Water quality implications of artificial flow fluctuations in regulated rivers. *The Science of the Total Environment* **37**:177 - 185.
- Fraleigh, J., B. Marotz, J. Decker-Hess, W. Beattie, and R. Zubik. 1989. Mitigation, compensation and future protection for fish populations affected by hydropower development in the Upper Columbia system Montana USA. *Regulated Rivers Research and Management* **3**:3 - 18.
- Frost, W. E., and M. E. Brown. 1967. *The Trout*. 1st edition. Collins, London, UK.
- Garcia De Jalon, D., P. Sanchez, and J. A. Camargo. 1994. Downstream effects of a new hydropower impoundment on macrophyte, macroinvertebrate and fish communities. *Regulated Rivers - Research and Management* **9**:253 - 261.
- Genkai-Kato, M., K. Nozaki, H. Mitsuhashi, Y. Kohmatsu, H. Miyasaka, and M. Nakanishi. 2000. Push-up response of stonefly larvae in low-oxygen conditions. *Ecological Research* **15**:175 - 179.
- Gerhardt, A. 1993. Review of impact of heavy metals on stream invertebrates with special emphasis on acid conditions. *Water, Air and Soil Pollution* **66**:289 - 314.
- Gerhardt, A. 1994. Short term toxicity of iron (Fe) and lead (Pb) to the mayfly *Leptophlebia marginata* (L.) (Insecta) in relation to freshwater acidification. *Hydrobiologia* **284**:157 - 168.
- Gerstner, C. L. 1998. Use of substratum ripples for flow refuging by Atlantic cod, *Gadus morhua*. *Environmental Biology of Fishes* **51**:455 - 460.
- Gheorghiu, C., J. Hanna, J. W. Smith, D. S. Smith, and M. P. Wilkie. 2010. Encapsulation and migration of PIT tags implanted in brown trout (*Salmo trutta* L.). *Aquaculture* **298**:350 - 353.
- Gibbins, C. N., C. Soulsby, M. J. Jeffries, and R. Acornley. 2001. Developing ecologically acceptable river flow regimes: a case study of Kielder reservoir and the Kielder water transfer system. *Fisheries Management and Ecology* **8**:463 - 485.

- Gibbins, C. N., D. Vericat, and R. J. Batalla. 2007. When is stream invertebrate drift catastrophic? The role of hydraulics and sediment transport in initiating drift during flood events. *Freshwater Biology* **52**:2369 - 2384.
- Gibbons, J. W., and K. M. Andrews. 2004. PIT tagging: simple technology at its best. *BioScience* **54**:447 - 454.
- Gido, K. B., C. S. Guy, T. R. Strakosh, R. J. Bernot, K. J. Hase, and M. A. Shaw. 2002. Long-term changes in the fish assemblages of the Big Blue River Basin 40 years after the construction of Tuttle Creek Reservoir. *Transactions of the Kansas Academy of Science* **105**:193 - 208.
- Gilvear, D. J. 2004. Patterns of channel adjustment to impoundment of the upper River Spey, Scotland (1942 - 2000). *River Research and Applications* **20**:151 - 165.
- Gilvear, D. J., and G. E. Petts. 1984. Turbidity and suspended solids variations downstream of a regulating reservoir. *Earth Surface Processes and Landforms* **10**:363 - 373.
- Gledhill, T., D. W. Sutcliffe, and W. D. Williams. 1976. Key to the British Freshwater Crustacea Malacostraca. 1st edition. Freshwater Biological Association, Ambleside, UK.
- Gomi, T., S. Kobayashi, J. N. Negishi, and F. Imaizumi. 2010. Short-term responses of macroinvertebrate drift following experimental sediment flushing in a Japanese headwater channel. *Landscape and Ecological Engineering* **6**:257 - 270.
- Gore, J. A., and J. M. Nestler. 1988. Instream flow studies in perspective. *Regulated Rivers - Research and Management* **2**:93 - 101.
- Greenwood, M. T., M. A. Bickerton, and G. E. Petts. 1999. Channel changes and invertebrate fauna below Nant-y-Moch dam, River Rheidol, UK: 35 years on. *Regulated Rivers - Research and Management* **15**:99 - 112.
- Guenther, C. B., and A. Spacie. 2006. Changes in fish assemblage structure upstream of impoundments within the Upper Wabash River Basin. *Transactions of the American Fisheries Society* **135**:570 - 583.
- Gunnarsli, K. S., H. Toften, and A. Mortensen. 2008. Effects of nitrogen gas supersaturation on growth and survival in juvenile Atlantic cod (*Gadus morhua* L.). *Aquaculture* **283**:175 - 179.
- Halleraker, J. H., S. J. Saltveit, A. Harby, J. V. Arnekleiv, H.-P. Fjeldstad, and B. Kohler. 2003. Factors influencing stranding of wild juvenile brown trout (*Salmo trutta*) during rapid and frequent flow decreases in an artificial stream. *River Research and Applications* **19**:589 - 603.
- Hardy, R. J., S. N. Lane, R. I. Ferguson, and D. R. Parsons. 2007. Emergence of coherent flow controls over a gravel surface: A numerical experiment. *Water Resources Research* **43**.
- Haro, A. 2002. Manual for Operation of TIRFID PIT Tag Systems. Conte Anadromous Fish Research Center, Turners Falls, USA.
- Hay, C. H., T. G. Franti, D. B. Marx, E. J. Peters, and L. W. Hesse. 2008. Macroinvertebrate drift density in relation to abiotic factors in the Missouri River. *Hydrobiologia* **598**:175-189.
- Hayes, F. R. 1953. Artificial freshets and other factors controlling the ascent and population of Atlantic salmon in the Le Havre River, Nova Scotia. *Bulletin of the Biological Board of Canada* **99**:1 - 47.
- Heggenes, J. 1988. Substrate preferences of brown trout fry (*Salmo trutta*) in artificial stream channels. *Canadian Journal of Fisheries and Aquatic Science* **45**:1801 - 1806.

- Heggenes, J. 1993. Homeostatic behavioural responses in a changing environment - brown trout (*Salmo trutta*) become nocturnal during winter. *Journal of Animal Ecology* **62**:295 - 308.
- Heggenes, J., J. L. Bagliniere, and R. A. Cunjak. 1999. Spatial niche variability for young Atlantic salmon (*Salmo salar*) and brown trout (*Salmo trutta*) in heterogeneous streams. *Ecology of Freshwater Fish* **8**:1 - 21.
- Heggenes, J., P. K. Omholt, J. R. Kristiansen, J. Sageie, F. Okland, J. G. Dokk, and M. C. Beere. 2007. Movements by wild brown trout in a boreal river: response to habitat and flow contrasts. *Fisheries Management and Ecology* **14**:333-342.
- Heggenes, J., and S. J. Saltveit. 1990. Seasonal and spatial microhabitat selection and segregation in young Atlantic salmon *Salmo salar* L. and brown trout *Salmo trutta* L. in a Norwegian river. *Journal of Fish Biology* **36**:707 - 720.
- Heggenes, J., S. J. Saltveit, D. Bird, and R. Grew. 2002. Static habitat partitioning and dynamic selection by sympatric young Atlantic salmon and brown trout in south-west England streams. *Journal of Fish Biology* **60**:72 - 86.
- Heggenes, J., S. J. Saltveit, and O. Lingaas. 1996. Predicting fish habitat use to changes in water flow: modelling critical minimum flows for Atlantic salmon, *Salmo salar*, and brown trout, *Salmo trutta*. *Regulated Rivers Research and Management* **12**:331 - 344.
- Hesthagen, T. 1990. Home range of juvenile Atlantic salmon *Salmo salar* and brown trout *Salmo trutta* in a Norwegian stream. *Freshwater Biology* **24**:63 - 67.
- Heywood, M. J. T., and D. E. Walling. 2006. The sedimentation of salmonid spawning gravels in the Hampshire Avon catchment, UK: implications for the dissolved oxygen content of intragravel water and embryo survival. *Hydrological Processes* **21**:770 - 788.
- Hill, M. S., G. B. Zydlewski, J. D. Zydlewski, and J. M. Gasvoda. 2006. Development and evaluation of portable PIT tag detection units: PIT packs. *Fisheries Research* **77**:102 - 109.
- Hindar, K., B. Jonsson, N. Ryman, and G. Stahl. 1991. Genetic relationships among landlocked, resident, and anadromous brown trout, *Salmo trutta* L. *Heredity* **66**:83 - 91.
- Hojesjo, J., F. Okland, L. F. Sundstrom, J. Petterson, and J. I. Johnsson. 2007. Movement and home range in relation to dominance; a telemetry study on brown trout *Salmo trutta*. *Journal of Fish Biology* **70**:257 - 268.
- Holomuzki, J. R., and B. J. F. Biggs. 2003. Sediment texture mediates high-flow effects on lotic macroinvertebrates. *Journal of the North American Benthological Society* **22**:542 - 553.
- Huntsman, A. G. 1948. Freshets and Fish. *Transactions of the American Fisheries Society* **75**:257 - 266.
- Hydrology, I. o. 1999. *Flood Estimation Handbook*. Institute of Hydrology (now Centre for Ecology and Hydrology), Wallingford.
- Hynes, H. B. N. 1970. *The Ecology of Running Waters*. 1st edition. Liverpool University Press, Liverpool, UK.
- Hynes, H. B. N. 1993. *Adults and Nymphs of British Stoneflies (Plecoptera)*. 3rd edition. Freshwater Biological Association, Ambleside, UK.
- Imbert, J. B., and J. A. Perry. 2000. Drift and benthic invertebrate responses to stepwise and abrupt increases in non-scouring flow. *Hydrobiologia* **436**:191 - 208.
- Irving, E. C., K. Liber, and J. M. Culp. 2004. Lethal and sublethal effects of low dissolved oxygen condition on two aquatic invertebrates, *Chironomus tentans* and *Hyaella azteca*. *Environmental Toxicology and Chemistry* **23**:1561 - 1566.

- Jackson, H. M., C. N. Gibbins, and C. Soulsby. 2007. Role of discharge and temperature variation in determining invertebrate community structure in a regulated river. *River Research and Applications* **23**:651 - 669.
- Jakob, C., C. T. Robinson, and U. Uehlinger. 2003. Longitudinal effects of experimental floods on stream benthos downstream from a large dam. *Aquatic Sciences* **65**:223 - 231.
- Jepsen, N., J. S. Mikkelsen, and A. Koed. 2008. Effects of tag and suture type on survival and growth of brown trout with surgically implanted telemetry tags in the wild. *Journal of Fish Biology* **72**:594 - 602.
- JNCC. 1994. UK Biodiversity Action Plan.
- Johansen, J. L., D. R. Bellwood, and C. J. Fulton. 2008. Coral reef fishes exploit flow refuges in high-flow habitats. *Marine Ecology Progress Series* **360**:219 - 226.
- Johnson, I. W., C. R. N. Elliott, and A. Gustrad. 1995. Using IFIM to model salmonid fish habitat in the River Allen, England. *Bulletin Francais de la Peche et de la Pisciculture* **337 - 339**:355 - 363.
- Junk, W. J., P. B. Bayley, and R. E. Sparks. 1989. The flood pulse concept in river-floodplain systems. *Canadian Special Publication of Fisheries and Aquatic Sciences* **106**:110 - 127.
- Kaller, M. D., and K. J. Hartman. 2004. Evidence of a threshold level of fine sediment accumulation for altering benthic macroinvertebrate communities. *Hydrobiologia* **518**:95 - 104.
- Kashiwagi, M. T., and L. E. Miranda. 2009. Influence of small impoundments on habitat and fish communities in headwater streams. *Southeastern Naturalist* **8**:23 - 26.
- Kay, P., A. Armstrong, A. McDonald, D. Parsons, J. Best, J. Peakall, A. Walker, M. Foulger, S. Gledhill, and M. Tillotson. 2009. A pilot study of the efficacy of residuum lodges for managing sediment delivery to impoundment reservoirs. *Water and Environment Journal* **23**:52 - 62.
- Kemp, P. 2010. In-Channel Placement of Structure to Enhance Habitat Complexity and Connectivity for Stream-Dwelling Salmonids. *in* P. Kemp, editor. *Salmonid Fisheries - Freshwater Habitat Management*. Wiley - Blackwell, Chichester.
- Kemp, P. S., M. H. Gessel, and J. G. Williams. 2008. Response of downstream migrant juvenile Pacific salmonids to accelerating flow and overhead cover. *Hydrobiologia* **609**:205 - 217.
- Kemp, P. S., D. Sear, A. Collins, P. Naden, and I. Jones. 2011. The impacts of fine sediment on riverine fish. *Hydrological Processes* **25**:1800 - 1821.
- Kennedy, G. J. A., and C. D. Strange. 1982. The distribution of salmonids in upland streams in relation to depth and gradient. *Journal of Fish Biology* **20**:579 - 591.
- King, J. M., R. E. Tharme, and M. S. de Villiers. 2008. Environmental flow assessments for rivers: manual for the building block methodology. Freshwater Research Unit, University of Cape Town, Cape Town.
- Knaepkens, G., L. Bruyndoncx, J. Coeck, and M. Eens. 2004. Spawning habitat enhancement in the European bullhead (*Cottus gobio*), an endangered freshwater fish in degraded lowland rivers. *Biodiversity and Conservation* **13**:2442 - 2452.
- Knight, C. M., R. E. Kenward, R. E. Gozlan, K. H. Hodder, S. S. Walls, and M. C. Lucas. 2009. Home-range estimation within complex restricted environments: importance of method selection in detecting seasonal change. *Wildlife Research* **36**:213 - 224.
- Kratz, K. W., S. D. Cooper, and J. M. Melack. 1994. Effects of single and repeated experimental acid pulses on invertebrates in a high-altitude Sierra-Nevada stream. *Freshwater Biology* **32**:161 - 183.

- Kroese, A. B. A., and N. A. M. Schellart. 1992. Velocity-sensitive and acceleration-sensitive units in the trunk lateral line of the trout. *Journal of Neurophysiology* **68**:2212 - 2221.
- Kucukali, S., and S. Cokgor. 2008. Boulder-flow interaction associated with self-aeration process. *Journal of Hydraulic Research* **46**:415 - 419.
- Kuusemets, V., and U. Mander. 2001. Nutrient flows and management of a small watershed. *Landscape Ecology* **17**:59 - 68.
- Lake, P. S. 2000. Disturbance, patchiness, and diversity in streams. *Journal of the North American Benthological Society* **19**:573 - 592.
- Lake, R. G., and S. G. Hinch. 1999. Acute effects of suspended sediment angularity on juvenile coho salmon (*Oncorhynchus kisutch*). *Canadian Journal of Fisheries and Aquatic Sciences* **56**:862 - 867.
- Lancaster, J. 1999. Small-scale movements of lotic macroinvertebrates with variations in flow. *Freshwater Biology* **41**:605 - 619.
- Lancaster, J. 2000. Geometric scaling of microhabitat patches and their efficacy as refugia during disturbance. *Journal of Animal Ecology* **69**:442 - 457.
- Lancaster, J., T. Buffin-Belanger, I. Reid, and S. Rice. 2006. Flow and substratum mediated movement by a stream dwelling insect. *Freshwater Biology* **51**:1053 - 1069.
- Lancaster, J., and A. G. Hildrew. 1993. Flow refugia and the microdistribution of lotic macroinvertebrates. *Journal of the North American Benthological Society* **12**:385 - 393.
- Lane, S. N., R. J. Hardy, L. Elliott, and D. B. Ingham. 2004. Numerical modelling of flow processes over gravelly surfaces using structured grids and a numerical porosity treatment. *Water Resources Research* **40**.
- Larsen, S., and S. J. Ormerod. 2010. Low-level effects of inert sediment on temperate stream invertebrates. *Freshwater Biology* **55**:476 - 486.
- Lauritzen, D. V., F. S. Hertel, L. K. Jordan, and M. S. Gordon. 2010. Salmon jumping: behaviour, kinematics and optimal conditions, with possible implications for fish passageway design. *Bioinspiration and Biomimetics* **5**:Unpaginated.
- Leeks, G. J. L., and M. D. Newson. 1989. Responses of the sediment system of a regulated river to a scour valve release: Llyn Clywedog, Mid-Wales, U.K. *Regulated Rivers: Research and Management* **3**:93 - 106.
- Lemley, A. d. 1982. Modification of benthic insect communities in polluted streams - combined effects of sedimentation and nutrient enrichment. *Hydrobiologia* **87**:229 - 245.
- Lepori, F., and B. Malmqvist. 2007. Predictable changes in trophic community structure along a spatial disturbance gradient in streams. *Freshwater Biology* **52**:2184-2195.
- Lessard, J. L., and D. B. Hayes. 2003. Effects of elevated water temperature on fish and macroinvertebrate communities below small dams. *River Research and Applications* **19**:721 - 732.
- Lewis, D. M., J. A. Elliott, J. D. Brookes, A. E. Irish, M. F. Lambert, and C. S. Reynolds. 2003. Modelling the effects of artificial mixing and copper sulphate dosing on phytoplankton in an Australian reservoir. *Lakes & Reservoirs Research and Management* **8**:31 - 40.
- Liao, J. C. 2007. A review of fish swimming mechanisms and behaviour in altered flows. *Philosophical Transactions of the Royal Society* **362**:1973 - 1993.
- Linnansaari, T., J.-M. Roussel, R. A. Cunjak, and J. H. Halleraker. 2007. Efficacy and accuracy of portable PIT-antennae when locating fish in ice-covered streams. *Hydrobiologia* **582**:281 - 287.

- Linton, E. D., D. A. Scuton, and R. S. McKinley. 2005. Physiological effects of thermomechanical newsprint mill effluent on Atlantic salmon (*Salmo salar* L.). *Ecotoxicology and Environmental Safety* **62**:317 - 330.
- Loar, J. M. 1985. Application of habitat evaluation models in southern Appalachian trout streams. Department of Environment, Oak Ridge, USA.
- Lobón-Cerviá, J. 1996. Response of a stream fish assemblage to a severe spate in northern Spain. *Transactions of the American Fisheries Society* **125**:913 - 919.
- Lowney, C. L. 2000. Stream temperature variation in regulated rivers: evidence for a spatial pattern in daily minimum and maximum magnitudes. *Water Resources Research* **36**:2947 - 2955.
- Lucas, M. C., and E. Baras. 2000. Methods for studying spatial behaviour of freshwater fishes in the natural environment. *Fish and Fisheries* **1**:283-316.
- Lucas, M. C., and E. Baras. 2001. *Migration of Freshwater Fishes*. 1st edition. Blackwell Science, Oxford, UK.
- Lucas, M. C., D. H. Bubb, M. H. Jang, K. Ha, and J. E. G. Masters. 2009. Availability of and access to critical habitats in regulated rivers: effects of low-head barriers on threatened lampreys. *Freshwater Biology* **54**:621 - 634.
- Lucas, M. C., and P. A. Frear. 1997. Effects of a flow-gauging weir on the migratory behaviour of adult barbel, a riverine cyprinid. *Journal of Fish Biology* **50**:382 - 396.
- Lucas, M. C., T. Mercer, J. D. Armstrong, S. McGinty, and P. Rycroft. 1999. Use of a flat-bed passive integrated transponder antenna array to study the migration and behaviour of lowland river fishes at a fish pass. *Fisheries Research* **44**:183-191.
- Macan, T. T., and R. Douglas Cooper. 1960. *A Key to the British Fresh and Brackish Water Gastropods*. 2nd edition. Freshwater Biological Association, Ambleside, UK.
- MacCrimmon, H. R., and T. L. Marshall. 1968. World distribution of the brown trout *Salmo trutta*. *Journal of the Fisheries Research Board of Canada* **25**:2527 - 2548.
- Macedo - Sousa, J. A., A. Gerhardt, C. M. A. Brett, A. J. A. Nogueira, and A. M. V. M. Soares. 2008. Behavioural responses of indigenous benthic invertebrates (*Echinogammarus meridionalis*, *Hydropsyche pellucidula* and *Choroterpes picteti*) to a pulse in Acid Mine Drainage: a laboratory study. *Environmental Pollution* **156**:966 - 973.
- Magoulick, D. D., and R. M. Kobza. 2003. The role of refugia for fishes during drought: a review and synthesis. *Freshwater Biology* **48**:1186 - 1198.
- Mahon, R. 1980. Accuracy of catch-effort methods for estimating fish density and biomass in streams. *Environmental Biology of Fishes* **5**:343 - 363.
- Maki-Petays, A., T. Muotka, A. Huusko, P. Tikkanen, and P. Kreivi. 1997. Seasonal changes in habitat use and preference by juvenile brown trout, *Salmo trutta*, in a northern boreal river. *Canadian Journal of Fisheries and Aquatic Sciences* **54**:520 - 530.
- Malmqvist, B., and C. Brönmark. 1985. Reversed trends in the benthic community structure in two confluent streams; one spring-fed, the other lake-fed. *Hydrobiologia* **124**:65-71.
- McCabe, D. J., and N. J. Gotelli. 2000. Effects of disturbance frequency, intensity, and area on assemblages of stream macroinvertebrates. *Oecologia* **124**:270 - 279.
- McManamay, R. A., D. J. Orth, C. A. Dolloff, and M. A. Cantrell. 2010. Gravel addition as a habitat restoration technique for tailwaters. *North American Journal of Fisheries Management* **30**:1238 - 1257.
- Meffe, G. K., and C. R. Carroll. 1994. *Principles of Conservation Biology*. 3rd edition. Sinauer Associates Inc., Sunderland, MA. USA.

- Milhous, R. T. 1998. Modelling of instream flow needs: the link between sediment and aquatic habitat. *Regulated Rivers: Research and Management* **14**:79 - 94.
- Milner, A. M., S. C. Conn, and L. E. Brown. 2006. Persistence and stability of macroinvertebrate communities in streams of Denali National Park, Alaska: implications for biological monitoring. *Freshwater Biology* **51**:373 - 387.
- Molin, J., A. Kagervall, and P. K. Rivinoja. 2010. Linking habitat characteristics with juvenile density to quantify *Salmo salar* and *Salmo trutta* smolt production in the river Savaran, Sweden. *Fisheries Management and Ecology* **17**:446 - 453.
- Moss, B. 1998. *Ecology of Fresh Waters - Man and Medium, Past to Future*. 3rd edition. Blackwell Science, Oxford.
- Mould, D. C. 2006. PhD Thesis: Field and Model Assessment of the Ecological Impacts of Redesigning Compensation Flow Releases. Durham University.
- Mould, D. C., and S. N. Lane. 2003. Holme / Ribble releases: report. University of Leeds, Leeds.
- Moulton, S. R., T. L. Beiting, K. W. Stewart, and R. J. Currie. 1993. Upper temperature tolerance of 4 species of caddisflies (*Insecta, Trcihoptera*). *Journal of Freshwater Ecology* **8**:193 - 198.
- Mulholland, P. J., J. N. Houser, and K. O. Maloney. 2005. Stream diurnal dissolved oxygen profiles as indicators of in-stream metabolism and disturbance effects: Fort Benning as a case study. *Ecological Indicators* **5**:242 - 252.
- Nagell, B. 1973. The oxygen consumption of mayfly (Ephemeroptera) and stonefly (Plecoptera) larvae at different oxygen concentration. *Hydrobiologia* **42**:461 - 489.
- Negishi, J. N., M. Inoue, and M. Nunokawa. 2002. Effects of channelisation on stream habitat in relation to a spate and flow refugia for macroinvertebrates in northern Japan. *Freshwater Biology* **47**:1515 - 1529.
- Negishi, J. N., and J. S. Richardson. 2006. An experimental test of the effects of food resources and hydraulic refuge on patch colonization by stream macroinvertebrates during spates. *Journal of Animal Ecology* **75**:118 - 129.
- Nelson, R. W., J. R. Dwyer, and W. E. Greenberg. 1987. Regulated flushing in a gravel-bed river for channel habitat maintenance - a Trinity River fisheries case-study. *Environmental Management* **11**:479 - 493.
- Nilsson, G. E., and S. Ostlund-Nilsson. 2008. Does size matter for hypoxia tolerance in fish? *Biological Reviews* **83**:173 - 189.
- Old, G., and M. Acreman. 2006. Guidance on compensation flows and freshets. Scotland and Northern Ireland Forum for Environmental Research, Edinburgh.
- Olden, J. D., and R. J. Naiman. 2010a. Incorporating thermal regimes into environmental flows assessments: modifying dam operations to restore freshwater ecosystem integrity. *Freshwater Biology* **55**:85 - 107.
- Olden, J. D., and R. J. Naiman. 2010b. Incorporating thermal regimes into environmental flows assessments: modifying dam operations to restore freshwater ecosystem integrity. *Freshwater Biology* **55**:86 - 107.
- Oldmeadow, D. F., J. Lancaster, and S. Rice. 2010. Drift and settlement of stream insects in a complex hydraulic environment. *Freshwater Biology* **55**:1020 - 1035.
- Ombredane, D., J. L. Bagliniere, and F. Marchand. 1998. The effects of Passive Integrated Transponder tags on survival and growth of juvenile brown trout (*Salmo trutta* L.) and their use for studying movement in a small river. *Hydrobiologia* **372**:99-106.
- Ormerod, S. J., P. Boole, C. P. McCahon, N. S. Weatherley, D. Pascoe, and R. W. Edwards. 1987. Short-term experimental acidification of a Welsh stream - comparing the biological effects of hydrogen-ions and aluminium. *Freshwater Biology* **17**:341 - 356.

- Orth, D. J., and O. E. Maughan. 1982. Evaluation of the incremental methodology for recommending instream flows for fishes. *Transactions of the American Fisheries Society* **111**:413 - 445.
- Ortlepp, J., and U. Mürle. 2003. Effects of experimental flooding on brown trout (*Salmo trutta fario* L.): The River Spöl, Swiss National Park. *Aquatic Sciences* **65**:232 - 238.
- Oskam, G. 1995. Main principles of water-quality improvement in reservoirs. *Aqua* **44**:23 - 29.
- Ottaway, E. M., and A. Clarke. 1981. A preliminary investigation into the vulnerability of young trout (*Salmo trutta* L.) and Atlantic salmon (*Salmo salar* L.) to downstream displacement by high water. *Journal of Fish Biology* **19**:135 - 145.
- Ovidio, M. 1999. Annual activity cycle of brown trout *Salmo trutta*: a radio telemetry study in a small stream of the Belgian Ardenne. *Bulletin Francais de la Peche et de la Pisciculture* **352**:1 - 18.
- Ovidio, M., J.-C. Philippart, and E. Baras. 2000. Methodological bias in home range and mobility estimates when locating radio-tagged trout, *Salmo trutta*, at different time intervals. *Aquatic Living Resources* **13**:449 - 454.
- Owens, P. N., R. J. Batalla, A. J. Collins, B. Gomez, D. M. Hicks, A. J. Horowitz, G. M. Kondolf, M. Marden, M. J. Page, E. L. Peacock, E. L. Petticrew, W. Salomons, and N. A. Trustum. 2005. Fine-grained sediment in river systems: environmental significance and management issues. Pages 693 - 717 *River Research and Applications*.
- Paller, M. H., and B. M. Saul. 1996. Effects of temperature gradients resulting from reservoir discharge on *Dorosoma cepedianum* spawning in the Savannah River. *Environmental Biology of Fishes* **45**:151 - 160.
- Palm, D., E. Brannas, F. Lepori, K. Nilsson, and S. Stridsman. 2007. The influence of spawning habitat restoration on juvenile brown trout (*Salmo trutta*) density. *Canadian Journal of Fisheries and Aquatic Sciences* **64**:509 - 515.
- Palmer, M. A., P. Arensburger, P. S. Botts, C. C. Hakenkamp, and J. W. Reid. 1995. Disturbance and the community structure of stream invertebrates: patch effects and the role of refugia. *Freshwater Biology* **34**:343 - 356.
- Pearce, F. 2006. *When The Rivers Run Dry - What Happens When Our Water Runs Out?* 1st edition. Transworld Publishers, Reading, UK.
- Pearsons, T. N., H. W. Li, and G. A. Lamberti. 1992. Influence of habitat complexity on resistance to flooding and resilience of stream fish assemblages. *Transactions of the American Fisheries Society* **121**:427 - 436.
- Petticrew, E. L., A. Krein, and D. E. Walling. 2007. Evaluating fine sediment mobilization and storage in a gravel-bed river using controlled reservoir releases. *Hydrological Processes* **21**:198 - 201.
- Petts, G. E. 1980. Implications of the fluvial process - channel morphology interaction below British reservoirs for stream habitats. *The Science of the Total Environment* **16**:149 - 163.
- Petts, G. E. 1984. *Impounded Rivers - Perspectives for Ecological Management*. 1st edition. John Wiley & Sons, Chichester.
- Petts, G. E. 1986. Water-quality characteristics of regulated rivers. *Progress in Physical Geography* **10**:492 - 516.
- Petts, G. E. 2009. Instream flow science for sustainable river management. *Journal of the American Water Resources Association* **45**:1071 - 1086.

- Petts, G. E., T. R. Foulger, D. J. Gilvear, J. D. Pratts, and M. C. Thoms. 1985. Wave-movement and water-quality variations during a controlled release from Kielder Reservoir, North Tyne River, U.K. *Journal of Hydrology* **80**:371 - 389.
- Petts, G. E., and A. M. Gurnell. 2005. Dams and geomorphology: research progress and future directions. *Geomorphology* **71**:22 - 47.
- Poff, N. L., J. D. Allan, M. B. Bain, J. R. Karr, K. L. Prestegard, B. D. Richter, R. E. Sparks, and J. C. Stromberg. 1997. The Natural Flow Regime: a paradigm for river conservation and restoration. *Bioscience* **47**:769 - 784.
- Pryce, D., C. Macadam, and S. Brooks. 2007. Guide to the British Stonefly (Plecoptera) Families: Adults and Larvae. 1st edition. Field Studies Council, Liverpool, UK.
- Przybilla, A., S. Kunze, A. Rudert, H. Bleckmann, and C. Brucker. 2010. Entraining in trout: a behavioural and hydrodynamic analysis. *Journal of Experimental Biology* **213**:2976 - 2986.
- Quinn, J. M., G. L. Steele, C. W. Hickey, and M. L. Vickers. 1994. Upper thermal tolerances of 12 New Zealand stream invertebrate species. *New Zealand Journal of Marine and Freshwater Research* **28**:391 - 397.
- Quinn, J. W., and T. J. Kwak. 2003. Fish assemblage changes in an Ozark river after impoundment: a long-term perspective. *Transactions of the American Fisheries Society* **37**:110 - 119.
- Rabeni, C. F., K. E. Doisy, and L. D. Zweig. 2005. Stream invertebrate community functional responses to deposited sediment. *Aquatic Sciences* **67**:395 - 402.
- Raddum, G. G. 1985. Effects of winter warm reservoir release on benthic stream invertebrates. *Hydrobiologia* **122**:105 - 111.
- Rader, R. B., and T. A. Belish. 1999. Influence of mild to severe flow alterations on invertebrates in three mountain streams. *Regulated Rivers: Research & Management* **15**:353 - 363.
- Rader, R. B., N. J. Voelz, and J. V. Ward. 2008. Post-flood recovery of a macroinvertebrate community in a regulated river: resilience of an anthropogenically altered ecosystem. *Restoration Ecology* **16**:24 - 33.
- Raymond, H. L. 1979. Effects of dams and impoundments on migrations of juvenile chinook salmon and steelhead from the Snake River, 1966 to 1975. *Transactions of the American Fisheries Society* **108**:505 - 529.
- Rayner, T. S., K. M. Jenkins, and R. T. Kingsford. 2009. Small environmental flows, drought and the role of refugia for freshwater fish in the Macquarie Marshes, arid Australia. *Ecohydrology* **2**:440 - 453.
- Reiser, D. W., C. M. Huang, S. Beck, M. Gagner, and E. Jeanes. 2006. Defining flow windows for upstream passage of adult anadromous salmonids at cascades and falls. *Transactions of the American Fisheries Society* **135**:668 - 679.
- Reiser, D. W., M. P. Ramey, and T. R. Lambert. 1987. Considerations in assessing flushing flow needs in regulated stream systems. Pages 45 - 59 in J. F. Craig and J. B. Kemper, editors. *Regulated Streams - Advances in Ecology*. Plenum Press, New York, USA.
- Rempel, L. L., J. S. Richardson, and M. C. Healey. 2000. Macroinvertebrate community structure along gradients of hydraulic and sedimentary conditions in a large gravel-bed river. *Freshwater Biology* **45**:57-73.
- Renofalt, B. M., R. Jansson, and C. Nilsson. 2010. Effects of hydropower generation and opportunities for environmental flow management in Swedish riverine ecosystems. *Freshwater Biology* **55**:49 - 67.
- Resh, V. H., A. V. Brown, A. P. Covich, M. E. Gurtz, H. W. Li, G. W. Minshall, S. R. Reice, A. L. Sheldon, J. B. Wallace, and R. Wissmar. 1988. The role of disturbance

- in stream ecology. *Journal of the North American Benthological Society* **7**:433 - 455.
- Richardson, S. M., J. M. Hanson, and A. Locke. 2002. Effects of impoundment and water-level fluctuations on macrophyte and macroinvertebrate communities of a dammed tidal river. *Aquatic Ecology* **36**:493 - 510.
- Riley, W. D., A. T. Ibbotson, W. R. C. Beaumont, P. Rycroft, and A. C. Cook. 2010. A portable, cost-effective, pass-through system to detect downstream migrating salmonids marked with 12mm passive integrated transponder tags. *Fisheries Research* **101**:203 - 206.
- Roberts, J. H., and P. L. Angermeier. 2007. Spatiotemporal variability of stream habitat and movement of three species of fish. *Oecologia* **151**:417 - 430.
- Robertson, M. J., D. A. Scruton, and K. D. Clarke. 2007. Seasonal effects of suspended sediment on the behaviour of juvenile Atlantic salmon. *Transactions of the American Fisheries Society* **136**:822 - 828.
- Robinson, C. T., S. Blaser, C. Jolidon, and L. N. S. Shama. 2011. Scales of patchiness in the response of lotic macroinvertebrates to disturbance in a regulated river. *Journal of the North American Benthological Society* **30**:374 - 385.
- Robinson, C. T., and U. Uehlinger. 2003. Using artificial floods for restoring river integrity. *Aquatic Sciences* **65**:181 - 182.
- Robinson, C. T., and U. Uehlinger. 2008. Experimental floods cause ecosystem regime shift in a regulated river. *Ecological Applications* **18**:511 - 526.
- Robinson, C. T., U. Uehlinger, and M. T. Monaghan. 2003. Effects of a multi-year experimental flood regime on macro-invertebrates downstream of a reservoir. *Aquatic Sciences* **65**:210 - 222.
- Roghair, C. N., C. F. Dollorr, and M. K. Underwood. 2002. Response of a brook trout population and instream habitat to a catastrophic flood and debris flow. *Transactions of the American Fisheries Society* **131**:718 - 730.
- Rolls, R. J., A. J. Boulton, I. O. Growns, and S. E. Maxwell. 2011. Response by fish assemblages to an environmental flow release in a temperate coastal Australian river: a paired catchment analysis. *River Research and Applications* **27**:867 - 880.
- Roussel, J.-M., R. A. Cunjak, R. Newbury, D. Caissie, and A. Haro. 2004. Movements and habitat use by PIT-tagged Atlantic salmon parr in early winter: the influence of anchor ice. *Freshwater Biology* **49**:1026 - 1035.
- Roussel, J.-M., A. Haro, and R. A. Cunjak. 2000. Field test of a new method for tracking small fishes in shallow rivers using passive integrated transponder (PIT) technology. *Canadian Journal of Fisheries and Aquatic Science* **57**:1326 - 1329.
- Rustadbakken, A., J. H. L'Abée-Lund, J. V. Arnekleiv, and M. Kraabol. 2004. Reproductive migration of brown trout in a small Norwegian river studied by telemetry. *Journal of Fish Biology* **64**:2 - 15.
- Saltveit, S. J., T. Bremnes, and O. R. Lindås. 1995. Effect of sudden increase in discharge in a large river on newly emerged Atlantic salmon (*Salmo salar*) and brown trout (*Salmo trutta*) fry. *Ecology of Freshwater Fish* **4**:168 - 174.
- Saltveit, S. J., J. E. Brittain, and A. Lillehammer. 1987. Stoneflies and river regulation. Pages 117 - 130 in J. F. Craig and J. B. Kemper, editors. *Regulated Streams - Advances in Ecology*. Plenum Press, New York, USA.
- Sambrook, H., and P. Gilkes. 1994. Roadford Reservoir - enhanced flows, fisheries and hydroelectric power. Pages 119 - 133 in *Reservoir Safety and the Environment*. Thomas Telford Services Ltd., Exeter, UK.

- Sato, T. 2006. Dramatic decline in population abundance of *Salvelinus leucomaenis* after a severe flood and debris flow in a high gradient stream. *Journal of Fish Biology* **69**:1849 - 1854.
- Savage, A. A. 1989. Adults of the British Aquatic Hemiptera Heteroptera: A Key with Ecological Notes. 1st edition. Freshwater Biological Association, Ambleside, UK.
- Scheurer, T., and P. Molinari. 2003. Experimental floods in the River Spöl, Swiss National Park: framework, objectives and design. *Aquatic Sciences* **65**:183 - 190.
- Schwartz, J. S., and E. E. Herricks. 2005. Fish use of stage-specific fluvial habitats as refuge patches during a flood in a low-gradient Illinois stream. *Canadian Journal of Fisheries and Aquatic Sciences* **62**:1540 - 1552.
- Scrimgeour, G. J., R. J. Davidson, and J. M. Davidson. 1988. Recovery of benthic macroinvertebrate and epilithic communities following a large flood, in an unstable, braided, New Zealand river. *New Zealand Journal of Marine and Freshwater Research* **22**:337 - 344.
- Scullion, J., and A. Sinton. 1983. Effects of artificial freshets on substratum composition, benthic invertebrate fauna and invertebrate drift in two impounded rivers in mid-Wales. *Hydrobiologia* **107**:261 - 269.
- Sedell, J. R., G. H. Reeves, F. R. Hauer, J. A. Stanford, and C. P. Hawkins. 1990. Role of refugia in recovery from disturbances: modern fragmented and disconnected river systems. *Environmental Management* **14**:711 - 724.
- Shannon, J. P., D. W. Blinn, T. McKinney, E. P. Benenati, K. P. Wilson, and C. O'Brien. 2001. Aquatic food base response to the 1996 test flood below Glen Canyon Dam, Colorado River, Arizona. *Ecological Applications* **11**:672 - 685.
- Shelton, R. 2009. *To Sea and Back: The Heroic Life of the Atlantic Salmon*. 1st edition. Atlantic Books, London, UK.
- Shirvell, C. S. 1983. Microhabitats chosen by brown trout for feeding and spawning in rivers. *Transactions of the American Fisheries Society* **112**:355 - 367.
- Shirvell, C. S., and R. G. Dungey. 1983. Microhabitats chosen by brown trout for feeding and spawning in rivers. *Transactions of the American Fisheries Society* **112**:355 - 367.
- Shuler, S. W., R. B. Nehring, and K. D. Fausch. 1994. Diel habitat selection by brown trout in the Rio Grande River, Colorado, after placement of boulder structures. *North American Journal of Fisheries Management* **14**:99 - 111.
- Smale, M. A., and C. F. Rabeni. 1995. Hypoxia and hyperthermia tolerances of headwater stream fishes. *Transactions of the American Fisheries Society* **124**:698 - 710.
- Solbé, J. 1997. *Water Quality for Salmon and Trout*. 3rd edition. The Atlantic Salmon Trust, Pitlochry, UK.
- Sophocleous, M. 2007. The Science and Practice of Environmental Flows and the Role of Hydrogeologists. *Ground Water* **45**:393 - 401.
- Spence, J. A., and H. B. N. Hynes. 1971. Differences in benthos upstream and downstream of an impoundment. *Journal of the Fisheries Research Board of Canada* **28**:35 - 43.
- Spence, R., and P. Hickley. 2000. The use of PHABSIM in the management of water resources and fisheries in England and Wales. *Ecological Engineering* **16**:153 - 158.
- Stalnaker, C., B. L. Lamb, J. Henrikson, K. Bovee, and J. Bartholow. 1995. *The Instream Flow Incremental Methodology - A Primer for IFIM*. National Biological Service - U.S. Department of the Interior, Washington D.C. U.S.A.
- Stanford, J. A., and J. V. Ward. 2001. Revisiting the serial discontinuity concept. *Regulated Rivers - Research & Management* **17**:303 - 310.

- Stickler, M., E. C. Enders, C. J. Pennell, D. Cote, K. Alfredsen, and D. A. Scruton. 2008. Stream gradient-related movement and growth of Atlantic salmon parr during winter. *Transactions of the American Fisheries Society* **137**:371 - 385.
- Storey, A. W., D. H. D. Edward, and P. Gazey. 1991. Surber and kick sampling: a comparison for the assessment of macroinvertebrate community structure in streams of south-western Australia. *Hydrobiologia* **211**:111 - 121.
- Stubbington, R., A. M. Greenwood, P. J. Wood, P. D. Armitage, J. Gunn, and R. A.L. 2009. The response of perennial and temporary headwater stream invertebrate communities to hydrological extremes. *Hydrobiologia* **630**:299 - 312.
- Sutherland, A. B., and J. L. Meyer. 2007. Effects of increased suspended sediment on growth rate and gill condition of two southern Appalachian minnows. *Environmental Biology of Fishes* **80**:389-403.
- Sutherland, W. J., and D. A. Hill. 1996. *Managing Habitats for Conservation*. 2nd edition. Cambridge University Press, Cambridge, UK.
- Tharme, R. E. 2003. A global perspective on environmental flow assessment: emerging trends in the development and application of environmental flow methodologies for rivers. *River Research and Applications* **19**:397 - 411.
- Thomson, J. R. 2002. The effects of hydrological disturbance on the densities of macroinvertebrate predators and their prey in a coastal stream. *Freshwater Biology* **47**:1333-1351.
- Thorstad, E. B., and T. G. Heggberget. 1998. Migration of adult Atlantic salmon (*Salmo salar*); the effects of artificial freshets. *Hydrobiologia* **371-372**:339-346.
- Thorstad, E. B., F. Okland, K. Aarestrup, and T. G. Heggberget. 2008. Factors affecting the within-river spawning migration of Atlantic salmon, with emphasis on human impacts. *Reviews in Fish Biology and Fisheries* **18**:345 - 371.
- Tiessen, K. H. D., J. A. Elliott, M. Stainton, J. Yarotski, D. N. Flaten, and D. A. Lobb. 2011. The effectiveness of small-scale headwater storage dams and reservoirs on stream water quality and quantity in the Canadian Prairies. *Journal of Soil and Water Conservation* **66**:158 - 171.
- Tockner, K., F. Malard, and J. V. Ward. 2000. An extension of the flood pulse concept. *Hydrological Processes* **14**:2861 - 2883.
- Tudorache, C., P. Viaene, R. Blust, H. Vereecken, and G. De Boeck. 2008. A comparison of swimming capacity and energy use in seven European freshwater fish species. *Ecology of Freshwater Fish* **17**:284 - 291.
- UKBAP. 2008. *United Kingdom Biodiversity Action Plan*.
- Utzinger, J., C. Roth, and A. Peter. 1998. Effects of environmental parameters on the distribution of bullhead *Cottus gobio* with particular consideration of the effects of obstructions. *Journal of Applied Ecology* **35**:882 - 892.
- Valentin, S., F. Lauters, C. Sabaton, P. Breil, and Y. Souchon. 1996. Modelling temporal variations of physical habitat for brown trout (*Salmo trutta*) in hydropeaking conditions. *Regulated Rivers - Research & Management* **12**:317 - 330.
- Vannote, R. L., G. W. Minshall, K. W. Cummins, J. R. Sedell, and C. E. Cushing. 1980. The River Continuum Concept. *Canadian Journal of Fisheries and Aquatic Science* **37**:130-137.
- Varley, M. E. 1967. *British Freshwater Fishes*. 1st edition. Fishing News (Books) Ltd., London, UK.
- Videler, J. J. 1993. *Fish Swimming*. 1st edition. Chapman, London, UK.
- Wallace, I. D. 2006. *Simple Key to Caddis Larvae*. 1st edition. Field Studies Council, Liverpool, UK.

- Wallace, I. D., B. Wallace, and G. N. Philipson. 2003. Keys to the Case-Bearing Caddis Larvae of Britain and Ireland. 1st edition. Freshwater Biological Association, Ambleside, UK.
- Walling, D. E., A. L. Collins, and G. K. McMellin. 2003. A reconnaissance survey of the source of interstitial fine sediment recovered from salmonid spawning gravels in England and Wales. *Hydrobiologia* **497**:91 - 108.
- Ward, J. V., and J. A. Stanford. 1983. The serial discontinuity concept of lotic ecosystems. *in* T. D. Fontaine and S. M. Bartell, editors. *The Dynamics of Lotic Ecosystems*. Ann Arbor Press, Ann Arbor, USA.
- Webb, B. W., and D. T. Crisp. 2006. Afforestation and stream temperature in a temperate maritime environment. *Hydrological Processes* **20**:51 - 66.
- Webb, B. W., and D. E. Walling. 1993. Temporal variability in the impact of river regulation on thermal regime and some biological implications. *Freshwater Biology* **29**:167 - 182.
- Webb, B. W., and D. E. Walling. 1996. Long-term variability in the thermal impact of river impoundment and regulation. *Applied Geography* **16**:211 - 213.
- Wehrly, K. E., L. Z. Wang, and M. Mitro. 2007. Field-based estimates of thermal tolerance for trout: incorporating exposure times and temperature fluctuation. *Transactions of the American Fisheries Society* **136**:365 - 374.
- Wei, Q., C. Feng, D. Wang, B. Shi, L. Zhang, Q. Wei, and H. Tang. 2008. Seasonal variations of chemical and physical characteristics of dissolved organic matter and trihalomethane precursors in a reservoir: a case study. *Journal of Hazardous Materials* **150**:257 - 254.
- Wentworth, C. K. 1922. A scale of grade and class terms for clastic sediments. *Journal of Geology* **30**:377 - 392.
- White, P., J. C. Labadz, and D. P. Butcher. 1996. The management of sediment in reservoir catchments. *Journal of the Chartered Institution of Water and Environmental Management* **10**:183 - 189.
- Whitehurst, I. A. 1991. The effects of sampling techniques on the *Gammarus* : *Asellus* ratio. *Water Research* **25**:745 - 748.
- Whitton, B. A. 1975. *River Ecology*. 1st edition. Blackwell, Oxford, UK.
- Winterbottom, J. H., S. E. Orton, A. G. Hildrew, and J. Lancaster. 1997. Field experiments on flow refugia in streams. *Freshwater Biology* **37**:569 - 580.
- Witzel, L. D., and H. R. MacCrimmon. 1983. Redd-site selection by brook trout and brown trout in southwestern Ontario. *Transactions of the American Fisheries Society* **112**:760 - 771.
- Wood, P. J., and P. D. Armitage. 1997. Biological effects of fine sediment in the lotic environment. *Environmental Management* **21**:203 - 217.
- Wright, J. F. 2000. An introduction to RIVPACS. Pages 1-25 *in* J. F. Wright, D. W. Sutcliffe, and M. T. Furse, editors. *Assessing the biological quality of fresh waters: RIVPACS and other techniques*. Freshwater Biological Association, Kendal, UK.
- Wright, J. F., J. M. Winder, R. J. M. Gunn, J. H. Blackburn, K. L. Symes, and R. T. Clarke. 2000. Minor local effects of a River Thames power station on the macroinvertebrate fauna. *Regulated Rivers: Research and Management* **16**:159 - 174.
- Wright, J. M., R. T. Clarke, R. J. M. Gunn, J. M. Winder, N. T. Kneebone, and J. Davy-Bowker. 2003. Response of the flora and macroinvertebrate fauna of a chalk stream to changes in management. *Freshwater Biology* **48**:894 - 911.

- Yeloff, D. E., J. C. Labadz, C. O. Hunt, D. L. Higgitt, and I. D. L. Foster. 2005. Blanket peat erosion and sediment yield in an upland reservoir catchment in the southern Pennines, UK. *Earth Surface Processes and Landforms* **20**:717 - 733.
- YSI-Environmental. 2002. YSI 556 Multi Probe System Operations Manual, Yellow Springs, U.S.A.
- YWS. 1992. Stratification at Silsden Reservoir. Yorkshire Water Services, Bradford.
- Zabel, R. W., B. J. Burke, M. L. Moser, and C. A. Peery. 2008. Relating dam passage time of adult salmon to varying river conditions using time-to-event analysis. *American Fisheries Society Symposium* **61**:153 - 163.
- Zydlewski, G. B., A. Haro, K. G. Whalen, and S. D. McCormick. 2001. Performance of stationary and portable passive transponder detection systems for monitoring of fish movements. *Journal of Fish Biology* **58**:1471-1475.
- Zydlewski, G. B., G. Horton, T. Dubreuil, B. Letcher, S. Casey, and J. Zydlewski. 2006. Remote monitoring of fish in small streams: a unified approach using PIT tags. *Fisheries* **31**:492 - 502.