

EBOSS
Evolutionary Building Operations Systems Solver

John Dylan Davis

A thesis
submitted in partial fulfillment of the
requirements for the degree of

Master of Science in Architecture

University of Washington
2017

Committee:
Christopher Meek
Robert Peña
Michael Gilbride

Program Authorized to Offer Degree:
Architecture

©Copyright 2017
John Dylan Davis

University of Washington

Abstract

EBOSS- Evolutionary Building Operations Systems Solver

John Dylan Davis

Chair of the Supervisory Committee:
Associate Professor Christopher Meek
Department of Architecture

An individual wakes up every morning and prepares themselves for the day by checking the daily forecast either through their phone or by the news. In response to either the hot or cold temperature, amount of precipitation, or wind speed, he or she will apply the correct number of layers in accordance with the day's weather conditions. This is done to achieve a maximum amount of comfort during the whole day and gives the person a sense of flexibility to the changes within a day. If a building could respond like a person, by checking the daily forecast and countering with passive and active systems as needed, then it would reduce the building's reliance on active systems that would require more energy use.

How can Building Automation Systems utilize these predictive climate technologies to circumvent current oversights and environmental control errors?

EBOSS, or Evolutionary Building Operations Systems Solver, is a grasshopper definition developed specifically to help an existing building foster more appropriate responses to changing weather conditions that create oversights and environmental control errors. EBOSS provides simple, interactive systems selection for the building that utilizes an Artificial Neural Network for a more intelligent Building Automation System. This methodology was devised after observing that there is a lack in the amount of depth and understanding of how and why systems are being used which limits each system within a building to stationary setpoints that are unable to adjust to changing weather. EBOSS will instead think of each system not as a single stationary element, but will control and maintain the building's systems based off past, present, and future data.

ACKNOWLEDGEMENTS

I would like to thank my advisory committee for their guidance and the Integrated Design Lab for their cooperation during this exploration.

TABLE OF CONTENTS

Introduction	7
Why Focus on Energy Use	9
Bullitt Center	10
Night Flushing	11
Rule Based Systems	12
EBOSS Overview	13
EBOSS	15
Input Genomes	18
Indexing	21
Genetic Comparison of Temperatures	23
Genetic Comparison of Energy Consumption	25
Genetic Comparison of Occupant Comfort	27
Fuzzy Logic Control System	28
Outputs	30
Solutions	31
Machine Learning	34
Conclusions and Opportunities	35

INTRODUCTION

As technology continues to evolve in parallel to the architecture discipline, there is a need for reevaluation of the possibilities the computer offers at improving building performance. As designers, we must ask ourselves the hard questions of: what do these ubiquitous software being developed mean to the discipline and what opportunities do they offer at making buildings better? An alternative approach to this frontier challenge could be defined by the potentials computers have for the improvement of building maintenance. Evolutionary Building Operations System Solver, or EBOSS, is a tool that allows the computer to better maintain a building by using data collected on the building and the weather forecast to improve building automated systems and reduce energy consumption.

Climate-responsive architecture is design under a variety of specific environmental conditions that can accommodate for long term changes. The integration of the computer in the design process allows for and encourages experimentation of these conditions through testing of solutions and refining of design approaches to reduce the overall energy use and increase thermal comfort. (Zdepski, 1986) Another approach to climate-responsive architectural design would be to improve building operations by allowing for its systems to also accommodate for changes. The strength of the computer lies in its ability to understand and process quantifiable information. Data that is "determined by hard (unalterable) needs, requirements and intentions," (Dorst, 2004) and produced through the monitoring of the building and its environment. This data can inform a building of what systems to use under changing weather conditions by utilizing the weather forecast to respond preemptively, a method of localized Weather-Responsive Architecture used by the tool EBOSS. EBOSS was designed to be systematic and cautious when approaching the systems at play when breaking down the elements of the environment and searching within past data through the use of an Artificial Neural Network. This tool will produce a structure of checks and balances that could resolve any dramatic changes within weather while maintaining an optimal energy use.

Ecological systems have at least five features that make them interesting. First, they are comprised of many parts; most contain hundreds of billions of individual organisms and tens of millions of species. Second, ecological systems are open systems that maintain themselves far from thermodynamic equilibrium by the uptake and transformation of energy and by the exchange of organisms and matter across their arbitrary boundaries. Third, ecological systems are adaptive, responding to changing environments both by behavioral adjustments of individuals and by Darwinian genetic changes in the attributes of populations. Fourth, ecological systems have irreversible histories, in part because all organisms are related to each other genetically in a hierarchic pattern of descent from a common ancestor. Fifth, ecological systems exhibit a rich variety of complex, non-linear dynamics. (Brown, 1994)

EBOSS can maintain a building as an ecological system through the use of an Artificial Neural Network, a system that begins to push towards the goal of sustaining itself and developing over time. The concept proposed by Michael Hensel and Achim Menges of Morpho-Ecology gives architects insight on how to treat systems as an inherent unity through multiple scales. Ecology is the study of the relationship between an organism and its environment. Morphogenesis is the biological process that causes an organism to derive its form. The combination of these terms, or Morpho-Ecology, produces a framework for architectural thinking that is firmly rooted within a biological paradigm. (Hensel, 2008) This comparison of a building to an ecological system claims that buildings have life and can adapt to their changing environment. EBOSS developed a dynamic and adaptive system's replication of processes within an ecological system and could become precedent for future approaches toward more weather responsive architecture.

WHY FOCUS ON ENERGY USE?

As we increasingly face economic and environmental strain related to energy crises worldwide, the push to make our buildings more efficient becomes central to the building construction and operations conversation. This problem of energy use is as much of an operational issue as a design issue when pertaining to the building sector. The building sector accounts for 39.87% of the United States' total consumption, according to the Energy Information Administration (EIA). The electrical energy consumption of buildings has doubled in the past 18 years, and the projected growth through 2030 is another 25%. Buildings also consume 70% of the total energy use and 40% of greenhouse gas emissions. (Maasoumy, 2016)

Optimizing our buildings is needed now more than ever and at the same time more achievable with comprehensive building and systems data being largely more available with the improvements of technology. Technology allowed us to develop "Building Energy Management Systems", or BEMS, which integrated multiple architectural and mechanical systems into one network, and aimed to enable constant improvement as technology advances. (Maasoumy, 2016) New advances in software being produced could equip our Building Energy Management Systems to learn from the past, and even predict the future and possibly ease the economic and environmental strain of buildings.

BULLITT CENTER

This approach will be evaluated in the context of the improved control of the Bullitt Center's operable windows for night flushing of a high thermal mass construction. The Bullitt Center is a six story, 51,000 sf commercial office building located in Seattle, Washington. (Bhatt, 2015) It was designed by Miller Hull to prove that an urban office building can be net positive and achieve the Living Building Challenge. The building was designed and constructed for the easy availability of data collection, every power outlet in the building is metered and recorded, the Building management system collects data on the operation of all its systems, including window operations, and a personal weather station on the building records the weather conditions.



Fig. 1 The Bullitt Center performing the process of night flushing

The Bullitt Center was developed with a well-integrated set of systems that include motorized windows. This system is used for natural ventilation and night flushing, which are the building's primary method of cooling. To improve the efficiency of these systems, the Bullitt Center has a high-performance building envelope with large windows, internal mass construction for high thermal storage, and a floor plate geometry to improve cross-ventilation.

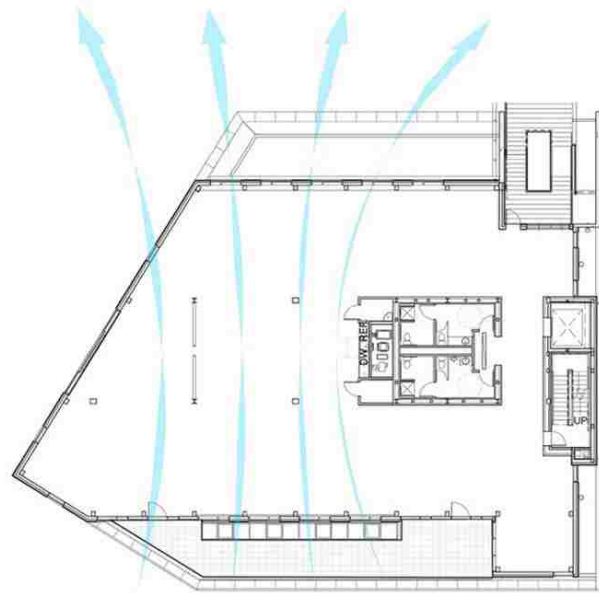

Fig. 2 Floor plan of the Bullitt Center showing cross-ventilation efficiency

PROCESS OF NIGHT FLUSHING

Night flushing is a passive ventilation cooling process where the building opens the windows at night to flush warm air out and cool its thermal mass for the next day. The Bullitt Center can use night flushing because opening the windows at night and collecting mild 60 degree to 70 degree air allows for its high mass to collect and store this coolth for the next day.

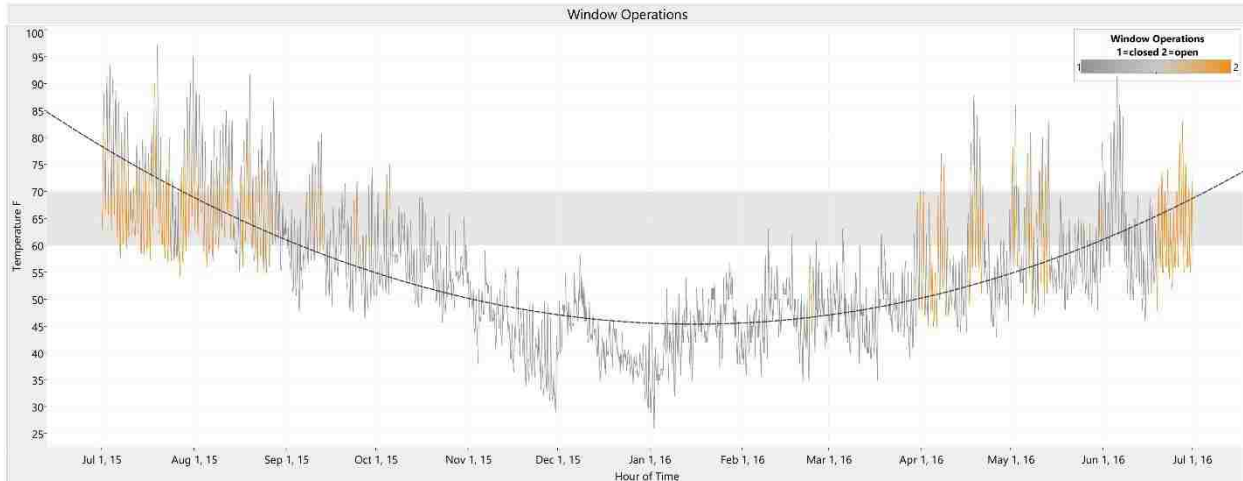

Fig. 3 Window Operations of the Bullitt Center. The color change shows windows open for temperatures between 60 and 70.

This process is particularly suited to the climate in the US Pacific Northwest where annual temperatures stay relatively mild in nature. The climate allows night time temperatures to drop below 70 degrees even during the hottest days. Night flushing could be used as a strategy for precooling for almost a total of 2,500 hours, or 29% of a year.

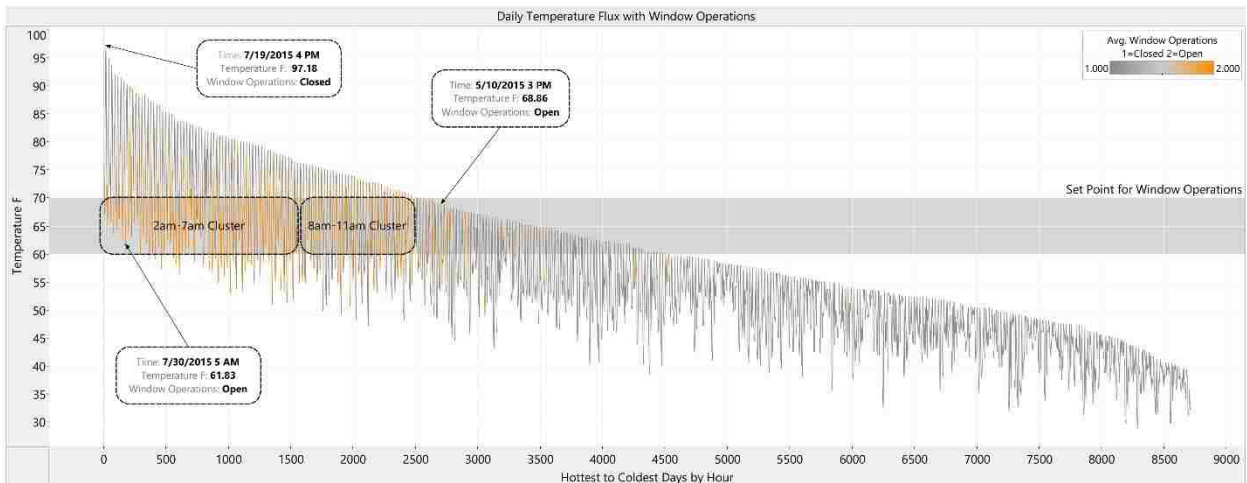

Fig. 4 Daily temperature changes with window operations. Hours are sorted by hottest days to coldest.

RULE BASED SYSTEMS

Currently Building Automated Systems use a Rule based logic that performs in real-time through stationary setpoints. (Oldewurtel, 2012) This system has major shortcomings when the building is only limited to looking at past and current weather and limits itself to a single setpoint of action.

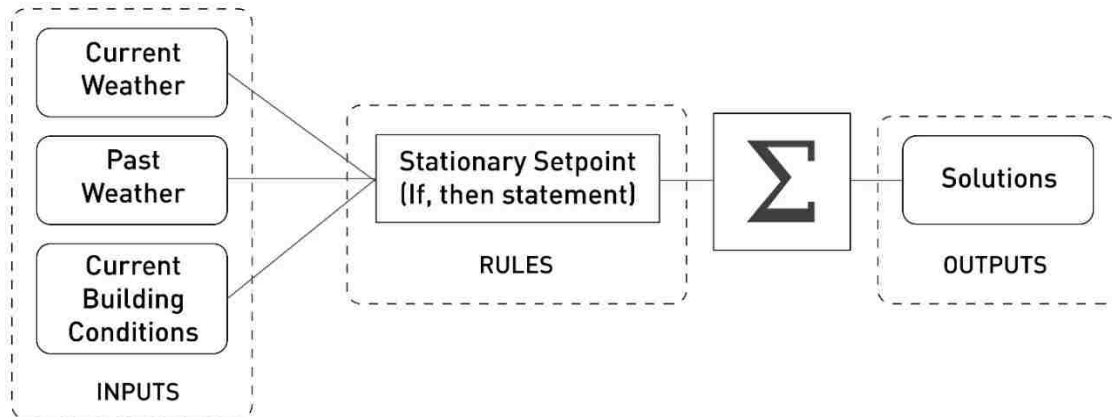

Fig. 5 Diagram of Rule Based Systems

An example is the Bullitt Center's natural ventilation system sequence of operation for night flushing that utilizes the previous day's temperature to determine if it is appropriate to precool for the next day. This assumption that the Rule Based System is making, if the previous day is under or over 70 degrees, then the proceeding day would be similar in temperature, is open for errors and will allow oversights and environmental control errors due to weather being unpredictable and varying.

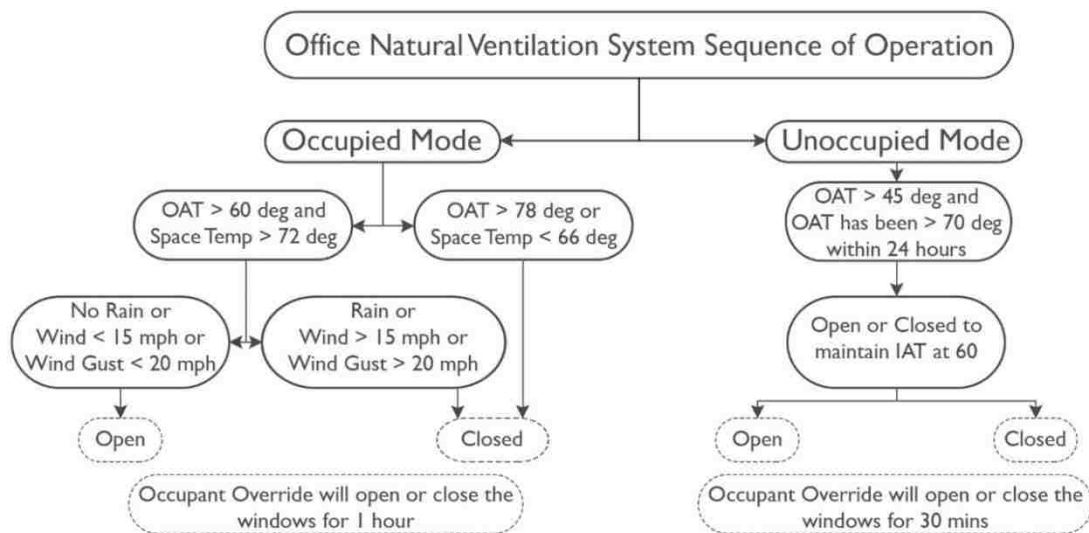

Fig. 6 Bullitt Center's Office Natural Ventilation System Sequence of Operation

EBOSS OVERVIEW

EBOSS uses an Artificial Neural Network (ANN) to develop optimal system choices within the program of Grasshopper. Grasshopper is a programming language and environment developed by David Rutten at Robert McNeel & Associates, that is used to build generative algorithms through components. The components used in EBOSS are also developed by Robert McNeel & Associates. An ANN is an energy prediction scheme that uses an energy data collection system and the weather forecast to help the building determine the best control strategies based off past choices. In a sense, an Artificial Neural Network is a type of artificial intelligence (AI) that mimics the behavior of the human brain. (Yang, 2005) It can approximate a nonlinear relationship between multiple input variables and produce an optimal output for a multi-objective problem. Artificial Neural Networks also have an ability for self-learning, so when data is continuously augmented, newly collected measurements become available as possible solutions.

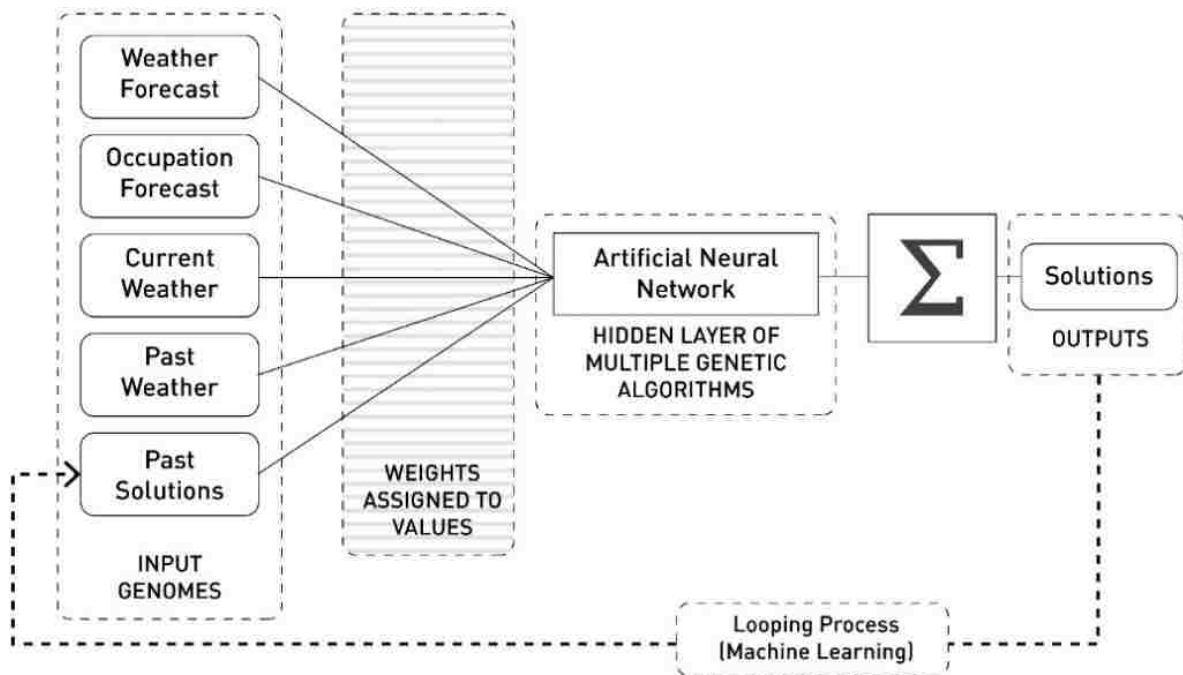

Fig. 7 Diagram of an Artificial Neural Network

Artificial Neural Networks can be broken down into input genomes, a fuzzy logic system with weights, a layer of multiple genetic algorithms, outputs, and a process of machine learning. In computer science, a genetic algorithm is the process of natural selection through the comparison of bio-inspired operators to generate high quality solutions. Thinking of the possible candidates of solutions as bio-inspired genomes, these inputs become a string of numbers like an organism's DNA. Fitness values are a figure of merit to indicate how close the solutions came to meeting the design objective. The figure of merit is a quantifiable number, which allows the Fuzzy Logic System to provide a means of comparison between these genetic candidates and produce optimized solutions through a process like natural selection.

EBOSS

Forecasted Dates	EBOSS Artificial Neural Network	Forecasted Dates
Forecasted Hours		Optimal Indexed Genetic Code
Forecasted Weekdays		Resulting Optimal Past Dates
Forecasted Temperatures		Resulting Optimal Window Operations
Past Data Dates		Optimal Indexed 48 Hours Temperature
Past Data Hours		Optimal Indexed 48 Hours Energy Cons
Past Data Weekday		List of Indexed Genetic Codes
Past Data Temperature		List of Indexed Genetic Codes' Dates
Past Data Energy Consumption		Genetically Similar 48 Hours Temperatures
Past Data Window Operations		Genetic Strength of Temperature for Indexed 48 Hours
Fuzzy Logic Temperature		Min Genetic Strength Temperature
Fuzzy Logic Energy Consumption		Max Genetic Strength Temperature
Number of Values		Genetically Similar 48 Hours Energy Consumption
		Mass Addition of Energy Consumption for Indexed 48 Hours
		Min Genetically Similar Energy Cons
	Max Genetically Similar Energy Cons	
	Evaluation of Temperature Similarity	
	Evaluation of Energy Consumption	
	Calculated Results Based off Fuzy Logic	
	Culling List for Removal of Errors	

Fig. 8 The grasshopper component for EBOSS

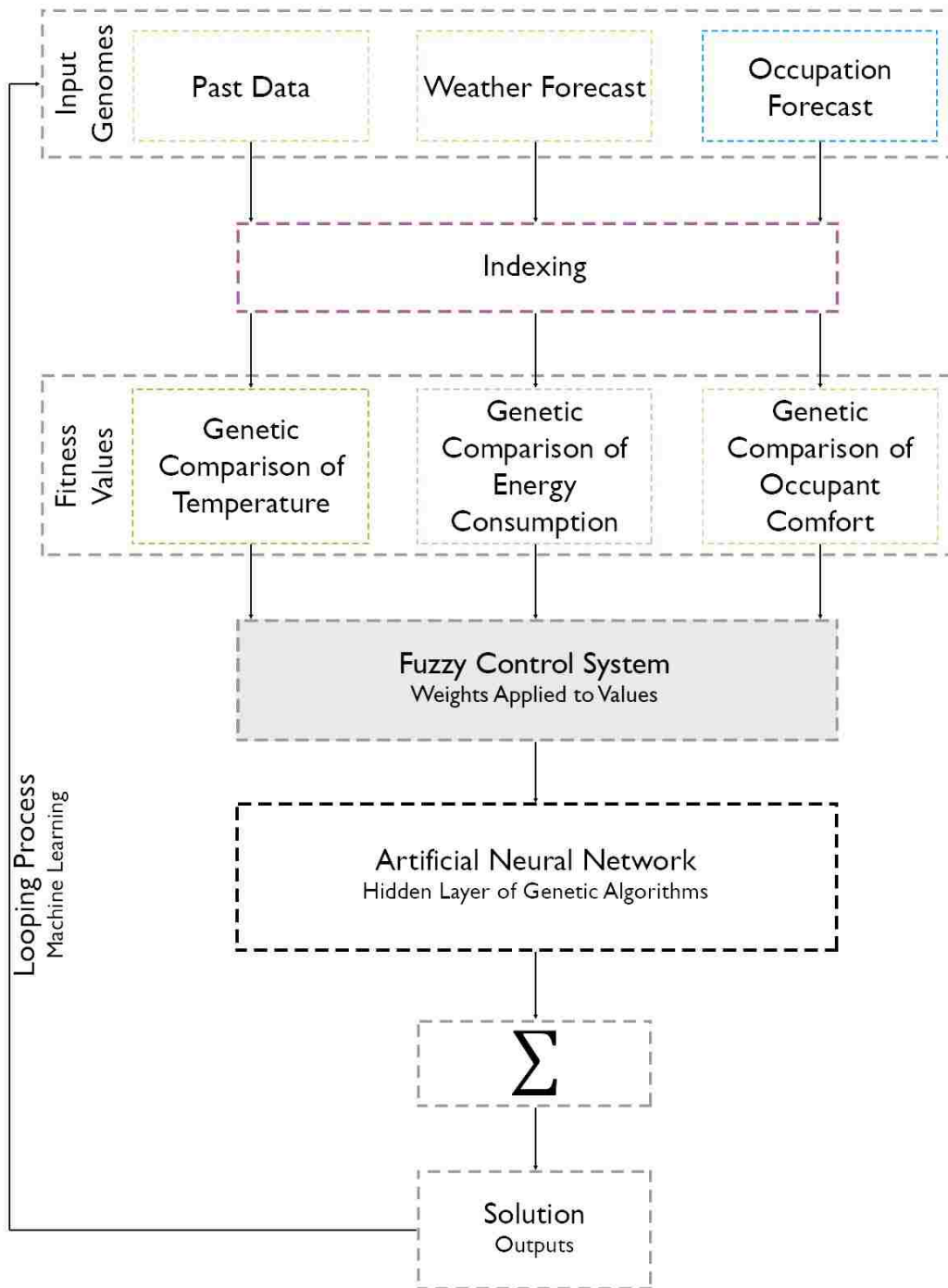

Fig. 9 The methodology of EBOSS utilizing an Artificial Neural Network as its means of achieving optimized solutions

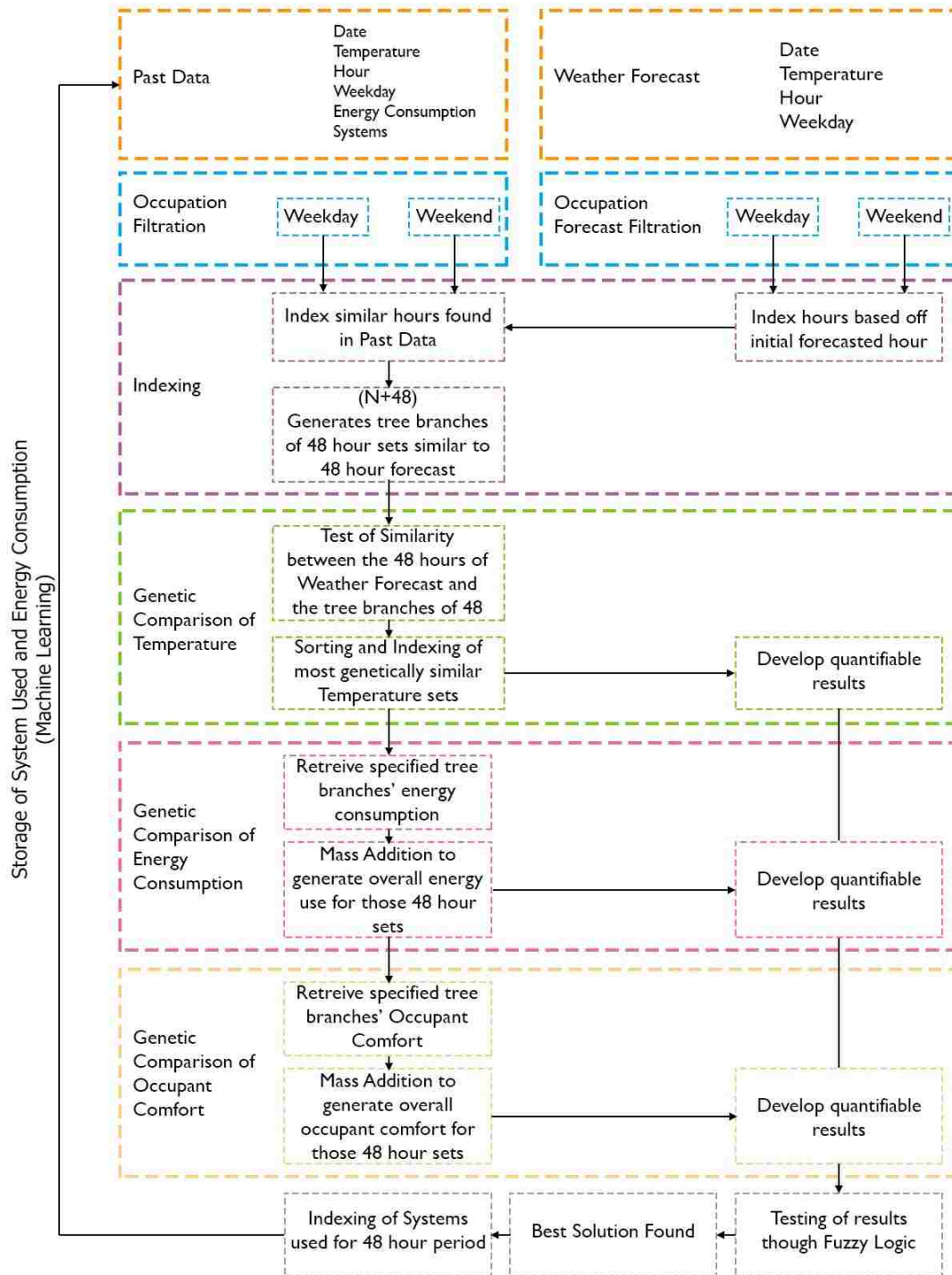

Fig. 10 The structure of EBOSS showing the flow of data through the entire process.

INPUT GENOMES

METHODOLOGY OF APPROACH

Germans use the term 'sachzwang' to describe a tool to "derive ought from fact.". (Rittel, 1987)

Sachzwang can be described as the logical or determined data that will inform the design process through logic. The data used for EBOSS is comprised through the compilation of past data into a database that holds by hour, the energy consumption and environmental conditions for the building. Utilizing the building system configuration or settings on a day with similar conditions should yield the same energy consumption. Sachzwang reduces the chance for error and increases the reliability of each solution. The tool, EBOSS, best uses this logic in the management of a building by synthesizing the quantitative data and using deductive logic to provide solutions. Design tools are "instruments with no intelligence or violation of their own, that can augment the abilities of an experienced designer, making the execution of some specific task more efficient, more precise, or more effortless." (Kalay, 2004)

EBOSS is a tool that can make logical choices based off 'sachzwang', quantifiable data and allow for buildings to make better decisions that are already within a solutions space of past data.

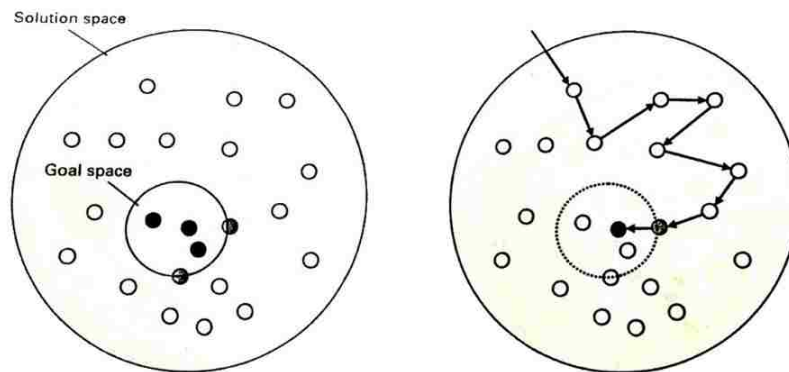

Fig. 11 Diagram of how designers navigate through the solution space to a goal space through goals and constraints

"The sought-after solution, exists within a universe of potential, or candidate solutions, a so-called solution space." (Kalay, 2004) Thinking of the solution space as an available set of 365 days' worth of solutions, EBOSS examines the existing candidate solutions for compliance with the goals and constraints and navigates within this space until a single resulting day with optimized systems is found.

The compiled database of the Bullitt Center's past data is the solution space for EBOSS to navigate within. The data consists of an entire year with a total of 8,760 rows and 526,832 cells. The categories of the contents includes time, weather conditions, energy consumption, and systems used. The data collected from the personal weather station on the Bullitt Center gives an hourly 10- day weather forecast. The categories of the contents include the time and local weather conditions.

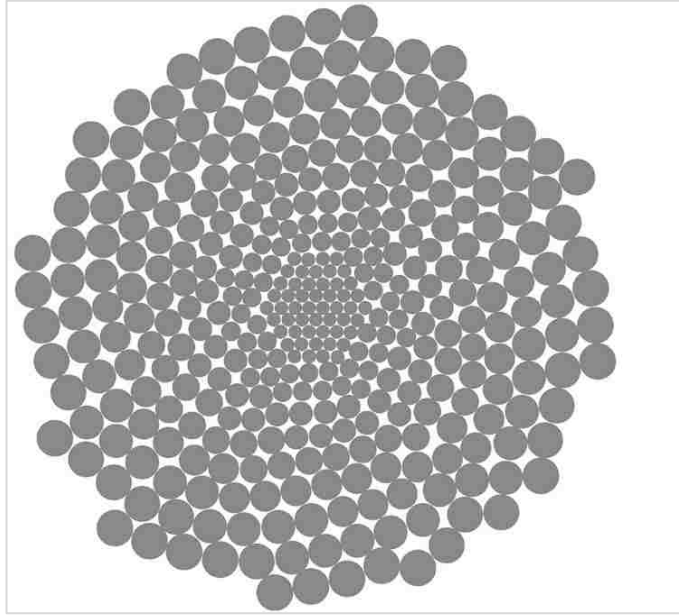

Fig. 12 Diagram of solution space made from 365 days' worth of data

Time	Weekday 1=Monday 7=Sunday	Hour	Temperature F	Daily Max Temp	Previous Max Temp	Dewpoint F	Hourly Precip In	Humidity	Visibility	Wind Direction Degrees	Wind Speed MPH	Energy Consumption (kW)	Energy Consumption w/o Plug and Lighting (kW)	Window Operations 1=closed 2=open
1/3/2016 0:00	7	0	37	40	41	12	0	36	10	90	17	28	23.56289452	1
1/3/2016 1:00	7	1	37	40	41	12	0	36	10	90	15	22.25	17.04451437	1
1/3/2016 2:00	7	2	36	40	41	13	0	39	10	90	16	22.5	17.95595294	1
1/3/2016 3:00	7	3	35	40	41	14	0	42	10	120	15	21.75	17.17416483	1
1/3/2016 4:00	7	4	36	40	41	14	0	40	10	120	17	25.75	21.2988023	1
1/3/2016 5:00	7	5	36	40	41	14	0	40	10	110	15	30	25.59810724	1
1/3/2016 6:00	7	6	36	40	41	14	0	40	10	100	16	30.25	25.70939374	1
1/3/2016 7:00	7	7	36	40	41	15	0	42	10	110	16	30	25.55720434	1
1/3/2016 8:00	7	8	36	40	41	15	0	42	10	110	17	30.25	25.7682366	1
1/3/2016 9:00	7	9	35	40	41	15	0	44	10	50	6	22	17.51931672	1
1/3/2016 10:00	7	10	37	40	41	17	0	44	10	60	8	22	17.40461282	1
1/3/2016 11:00	7	11	38	40	41	19	0	46	10	0	0	17.25	12.75384518	1
1/3/2016 12:00	7	12	40	40	41	20	0	45	10	120	8	13.75	9.222517358	1
1/3/2016 13:00	7	13	36	40	41	28	0	73	6	120	9	13.5	8.9560964	1
1/3/2016 14:00	7	14	34	40	41	30	0.01	85	2	0	0	13	8.672422547	1
1/3/2016 15:00	7	15	35	40	41	31	0.01	85	3	30	6	17	12.56123973	1
1/3/2016 16:00	7	16	35	40	41	32	0	89	10	350	7	24.8	19.13574983	1
1/3/2016 17:00	7	17	35	40	41	32	0	89	10	330	8	30.5	25.97599514	1
1/3/2016 18:00	7	18	35	40	41	32	0	89	10	350	7	29.5	24.17911367	1
1/3/2016 19:00	7	19	35	40	41	32	0	89	10	360	7	23.5	17.78960279	1
1/3/2016 20:00	7	20	36	40	41	32	0	85	10	20	6	23	17.24191719	1
1/3/2016 21:00	7	21	35	40	41	31	0	85	10	0	0	22.75	17.31976411	1
1/3/2016 22:00	7	22	36	40	41	30	0	79	10	130	5	22	17.33625254	1
1/3/2016 23:00	7	23	36	40	41	30	0	79	10	110	8	22.25	17.43481376	1

Fig. 13. Excerpt from the data collected on the Bullitt Center, provided by the Integrated Design Lab at UW

Time	Weekday	Temperature F	Dewpoint F	Conditions	PCT Code	Day Conditions	Wind Speed MPH	Wind Direction Degrees	WV	UVI	Humidity	Wind Gust	Heat Index	Heat Lib
35 3:00 PM PST on February 09, 2017	Thursday	54	50	Chance of Rain	12	75	14	204	Showers	0	85	-9999	-9999	54
36 4:00 PM PST on February 09, 2017	Thursday	53	49	Chance of Rain	12	66	15	204	Showers	0	86	-9999	-9999	53
37 5:00 PM PST on February 09, 2017	Thursday	52	47	Chance of Rain	12	54	16	204	Few Showers	0	85	-9999	-9999	52
38 6:00 PM PST on February 09, 2017	Thursday	50	45	Chance of Rain	12	69	18	207	Few Showers	0	84	-9999	-9999	50
39 7:00 PM PST on February 09, 2017	Thursday	49	44	Partly Cloudy	2	56	19	207	Partly Cloudy	0	81	-9999	-9999	49
40 8:00 PM PST on February 09, 2017	Thursday	48	42	Mostly Cloudy	3	40	17	202	Mostly Cloudy	0	78	-9999	-9999	48
41 9:00 PM PST on February 09, 2017	Thursday	48	42	Chance of Rain	12	69	15	197	Few Showers	0	80	-9999	-9999	48
42 10:00 PM PST on February 09, 2017	Thursday	47	43	Chance of Rain	12	72	13	192	Showers	0	83	41	-9999	41
43 12:00 AM PST on February 10, 2017	Friday	46	42	Chance of Rain	12	68	12	186	Showers	0	84	41	-9999	41
44 1:00 AM PST on February 10, 2017	Friday	46	42	Chance of Rain	12	87	11	183	Showers	0	85	41	-9999	41
45 2:00 AM PST on February 10, 2017	Friday	46	41	Chance of Rain	12	77	11	184	Showers	0	85	41	-9999	41
46 3:00 AM PST on February 10, 2017	Friday	45	41	Chance of Rain	12	83	10	182	Showers	0	85	39	-9999	39
47 4:00 AM PST on February 10, 2017	Friday	45	41	Overcast	4	81	11	176	Cloudy	0	86	39	-9999	39
48 5:00 AM PST on February 10, 2017	Friday	45	40	Chance of Rain	12	82	12	173	Showers	0	83	39	-9999	39
49 6:00 AM PST on February 10, 2017	Friday	45	40	Chance of Rain	12	86	12	176	Showers	0	84	39	-9999	39
50 7:00 AM PST on February 10, 2017	Friday	45	40	Chance of Rain	12	82	14	177	Showers	0	84	38	-9999	38
51 8:00 AM PST on February 10, 2017	Friday	45	40	Chance of Rain	12	82	16	180	Showers	0	84	37	-9999	37
52 9:00 AM PST on February 10, 2017	Friday	45	39	Chance of Rain	12	90	19	185	Light Rain	0	82	37	-9999	37
53 10:00 AM PST on February 10, 2017	Friday	44	40	Chance of Rain	12	94	21	185	Light Rain/Wind	0	85	36	-9999	36
54 11:00 AM PST on February 10, 2017	Friday	44	39	Chance of Rain	12	95	22	190	Light Rain/Wind	1	83	36	-9999	36
55 12:00 PM PST on February 10, 2017	Friday	45	40	Chance of Rain	12	94	22	203	Showers/Wind	1	83	36	-9999	36
56 1:00 PM PST on February 10, 2017	Friday	44	39	Partly Cloudy	2	95	22	208	Cloudy/Wind	1	81	36	-9999	36
57 2:00 PM PST on February 10, 2017	Friday	44	38	Partly Cloudy	2	87	22	211	Cloudy/Wind	1	80	36	-9999	36
58 3:00 PM PST on February 10, 2017	Friday	44	36	Partly Cloudy	2	78	20	211	Mostly Cloudy/Wind	0	76	37	-9999	37

Fig. 14 Excerpt from the data collected from the weather forecast

INPUT GENOMES STRUCTURE OF SCRIPTING

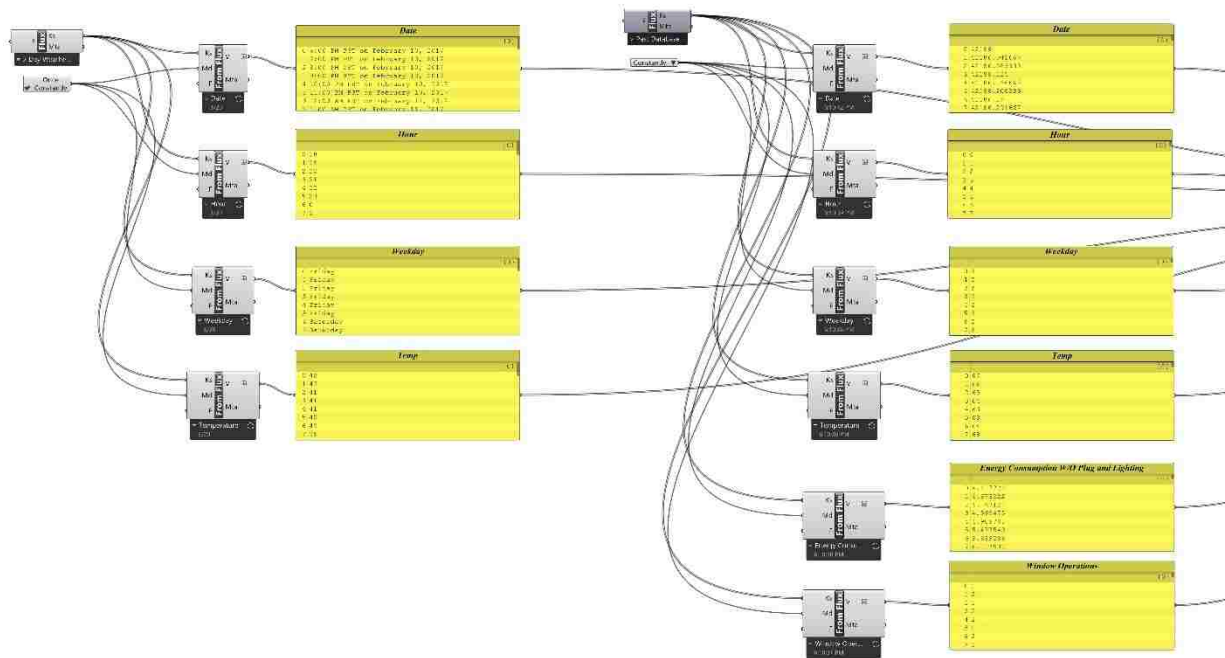

Fig. 15 Grasshopper Script of the input genomes. The left side is the weather forecast, the right is past data on the building

EBOSS's grasshopper script for the input genomes focuses on the transfer of information between the databases created for the past data on the Bullitt Center and the weather forecast to the grasshopper program. A tool called FLUX, designed by Flux.io, was used due to its seamless feature of connecting all these streams of data by having plug-ins for both excel and grasshopper. FLUX's ability to continuously exchange data allows EBOSS to make constant adjustments to the systems as weather changes within the day. The data that is being transferred from the weather forecast are the dates, hours, weekdays, and temperature. The data that is being transferred from the database on the Bullitt Center are the dates, hours, weekdays, temperature, energy consumption, and window operations.

The weights for the Fuzzy Logic System and the size of the goal space become input values to allow for the user to have a higher degree of control over the results produced by EBOSS.

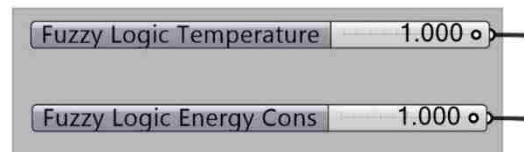

Fig. 16 Inputs for Fuzzy Logic System and Goal Space size

INDEXING METHODOLOGY OF APPROACH

Indexing is the process that collects, parses, and stores data to facilitate fast and accurate information retrieval. Due to the office occupation patterns of the Bullitt Center, occupation is a consistent Monday through Friday. Data was parsed into two categories of occupied and unoccupied before testing to reduce computation costs and system usage between an occupied day and an unoccupied day. If the building is unoccupied, window operations will be restricted and maintained at a closed position to preserve internal temperatures and reduce the use of heating and cooling.

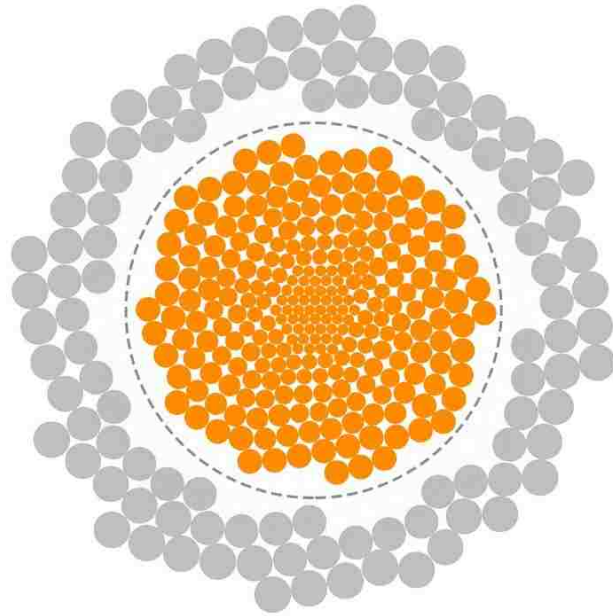

Fig. 17 Diagram of indexing the solution space based off occupation

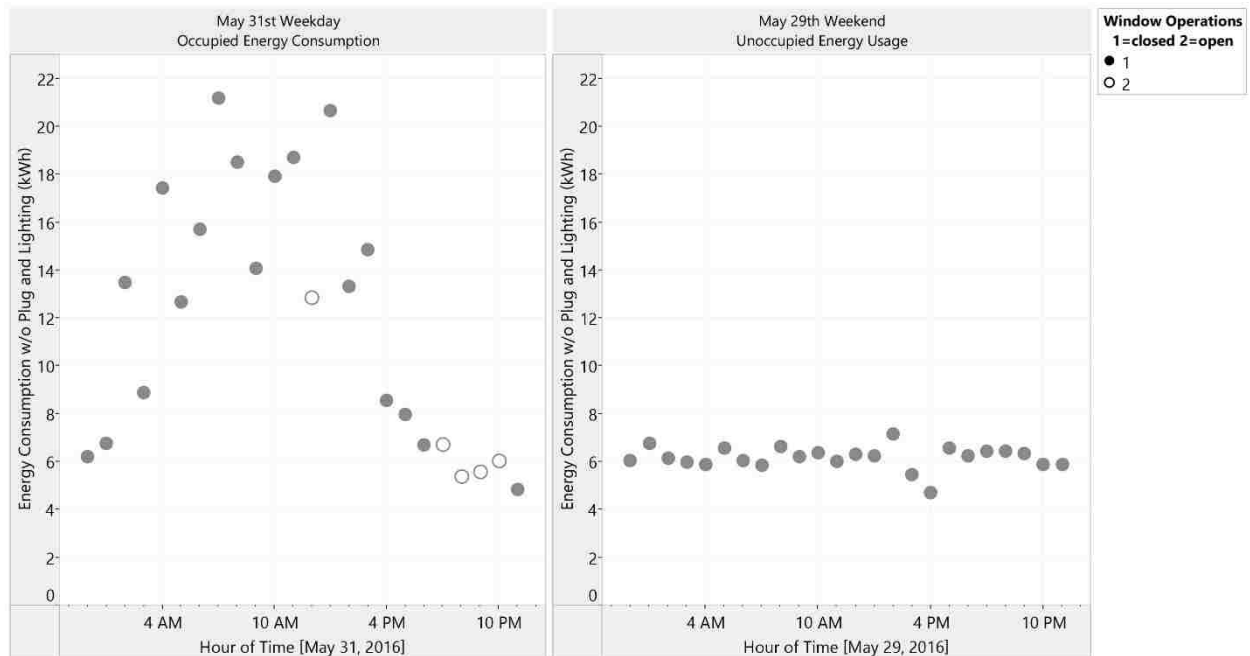

Fig. 18 Graphs showing the effect of occupation on systems usage

INDEXING

PROCESS OF SCRIPTING

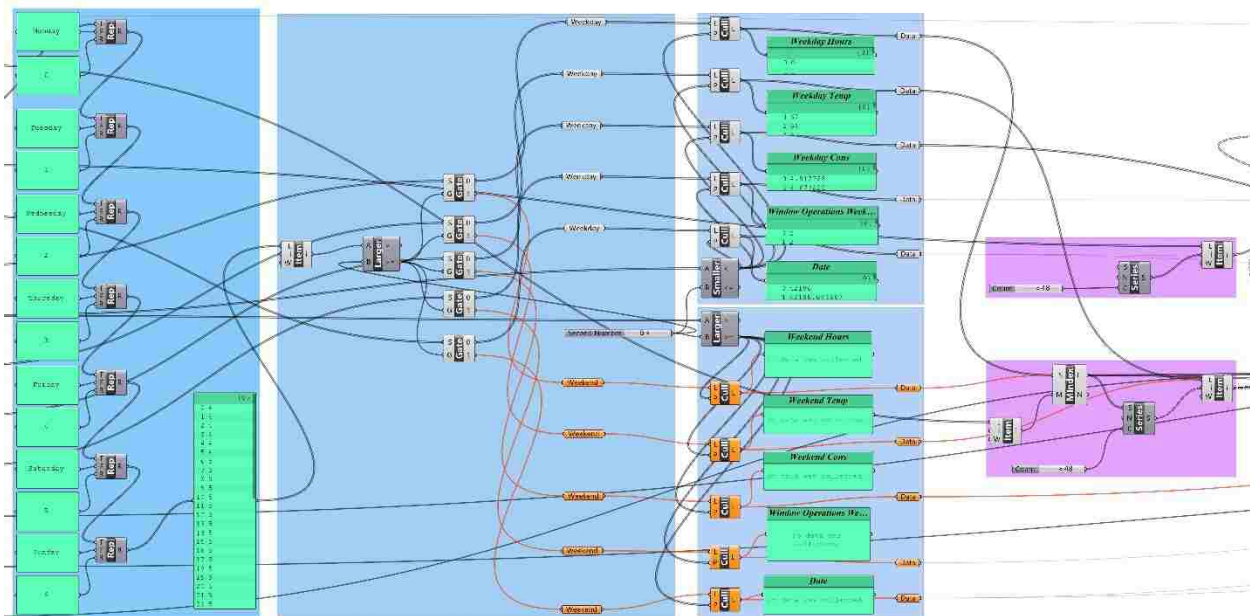

Fig. 19 Grasshopper script for the separation of past data into occupied and unoccupied days

EBOSS's grasshopper script for the process of indexing utilizes the weather forecast's stream of weekdays to determine the building's occupation for the tested day. Due to the weekdays being received in textual form, the data is replaced with 0 to 6 values using the "replace text" component found within the grasshopper program. This replaces all occurrences of a specific text fragment with another. (Gupta, 2016) Once the data is in a numerical format, EBOSS uses the "larger than" component to test if the next day is between 0 to 4, or Monday to Friday, for weekdays and 5 to 6, or Saturday and Sunday, for weekends. (Gupta, 2016) To keep the occupied and unoccupied sets of data separated, each input is sent into the "stream gate" component. This component redirects the data into two different outputs, which will allow EBOSS to better define the solution space by only using relevant data. (Gupta, 2016)

EBOSS can then index the data into 48 hour sets once the occupation has been determined for the tested day. 48 hour sets can be created with the "list item" component by taking the initial hour within the weather forecast and using the "member index" component to find every occurrence of this hour within the past data. (Gupta, 2016) When the occurrence of this hour is found within the past data, the "series" component adds an additional 47 values to that occurrence to develop 48 hour sets that correlates to the initial hour of the weather forecast. (Gupta, 2016)

GENETIC COMPARISON OF TEMPERATURE METHODOLOGY OF APPROACH

EBOSS performs a process of genetic comparison of temperature once the data has been separated between the categories of occupied and unoccupied. This process is looking at the genome values between the two sets of data and develops a quantifiable number of merit of their similarity, allowing for the selection of days that have the most similar weather conditions when compared by hour to the weather forecast.

The genetic comparison of temperatures between past data and the weather forecast produces a result of an average temperature similarity per hour. The results with the smallest temperature similarity can then become the goal space of a few values for decreased computing costs. A quantifiable result is produced from this value by ranking their average temperature similarity.

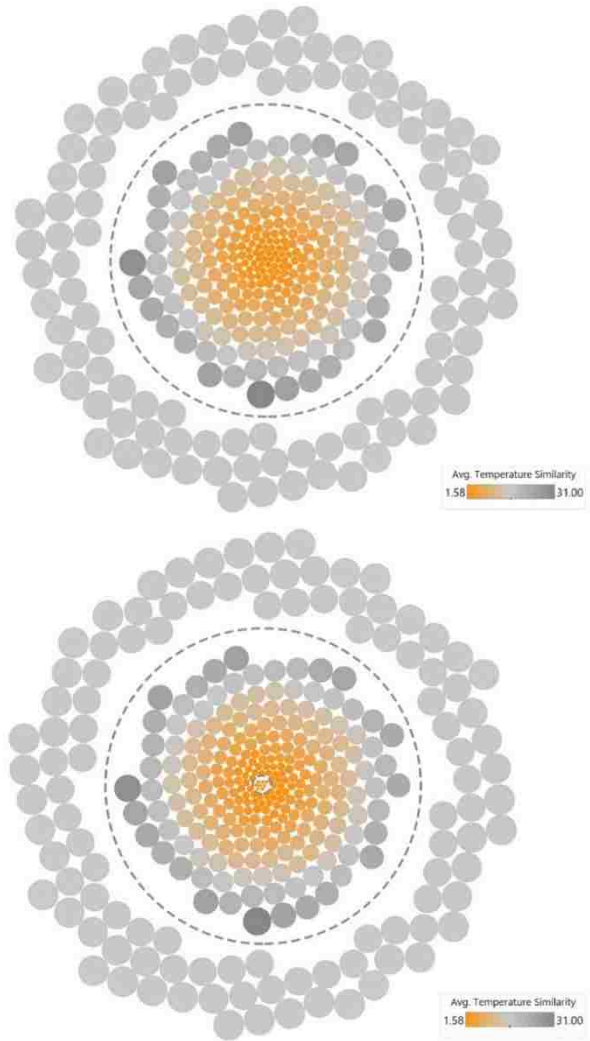

Fig. 20 Diagrams of sorting by temperature similarity to define a goal space

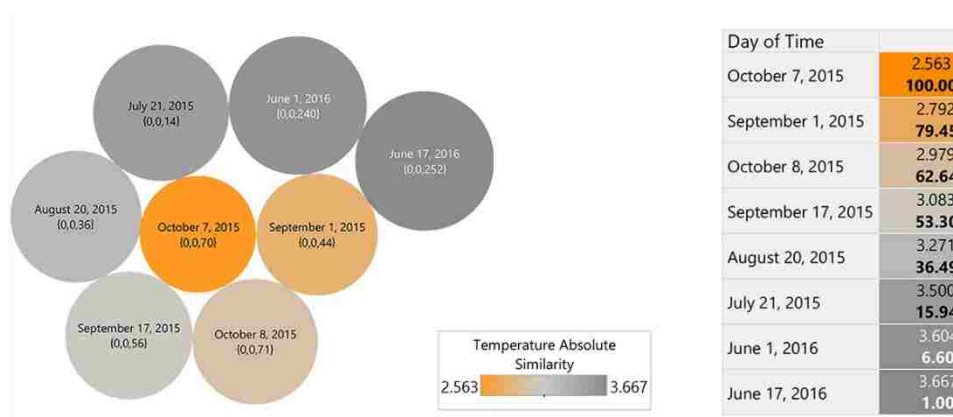

Fig. 21 Diagram and chart representing the values within the goal space and their ranking based off temperature

GENETIC COMPARISON OF TEMPERATURE PROCESS OF SCRIPTING

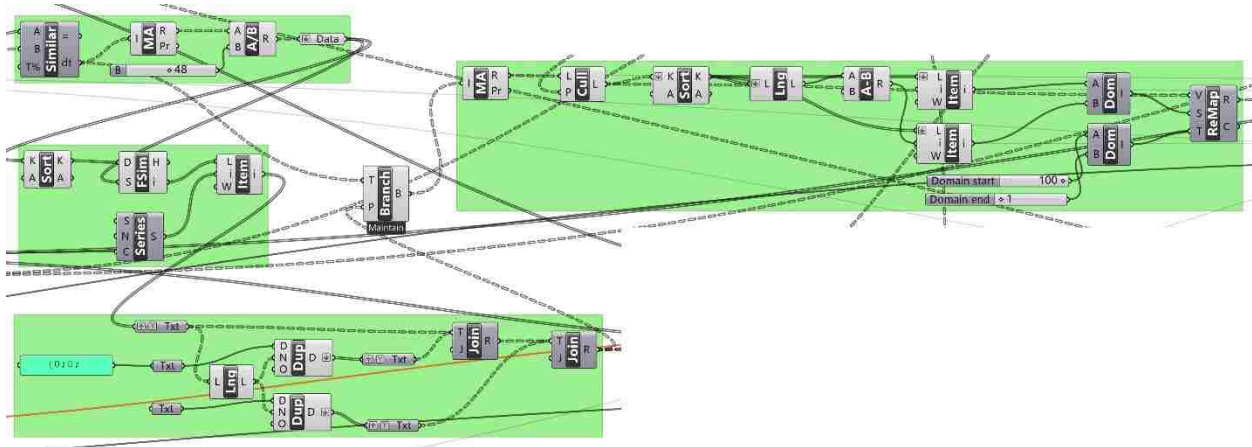

Fig. 22 Grasshopper script for comparing the temperatures of the past data sets and the weather forecast

EBOSS's grasshopper script for the process of genetic comparison of temperature takes the sets of 48 hours of past data and 48 hours of weather forecast and computes the absolute difference between each of these sets through the "similarity" component. (Gupta, 2016) These values are added together with the "mass addition" component and divided by 48 with the division component to generate the average temperature similarity of each 48-hour set in the past data. (Gupta, 2016) These values are then sorted and the most similar in temperature days are indexed out based off the number of days selected which was determined by the initial input for the size of the goal space.

To develop a language for naming these potential solutions, a code is created for each solution by the indexing value, or the presence of the 48-hour set within past data.

Ex. {0:0:40} for the 40th 48-hour set within the past data

This allows for easy retrieval of each 48-hour set's data, like energy consumption or window operations.

After EBOSS has generated the average temperature similarity for each 48-hour set and indexed only the most similar in temperature sets, it can produce a quantifiable value to be used by the Fuzzy Logic System. This value is produced by taking the upper and lower bounds of these sets and reconfigure the bounds to 1 to 100 through the "remap numbers" component. (Gupta, 2016) This becomes the figure of merit of each potential solution in satisfying the similarity in temperature objective.

GENETIC COMPARISON OF ENERGY CONSUMPTION METHODOLOGY OF APPROACH

EBOSS performs a process of genetic comparison of energy consumption once the data has been reduced to the goal space of the most similar in temperature potential solutions. Energy consumption becomes a new fitness value for each potential solution after retrieving the value through the indexing of their genetic codes.

After EBOSS has generated the energy consumption of each 48-hour set, it can produce a quantifiable value to be used by the Fuzzy Logic System. This value is produced by taking the upper and lower bounds of these sets and reconfigure the bounds to 1 to 100 with the “remap numbers” component. (Gupta, 2016) This value becomes the figure of merit of each potential solution in satisfying the comparison of energy consumption.

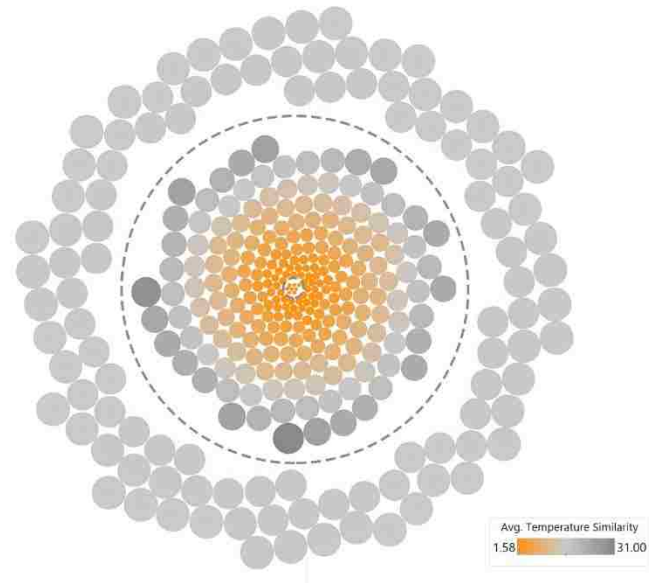

Fig. 23 Diagram of the values within the goal space that will be used for comparison of energy consumption

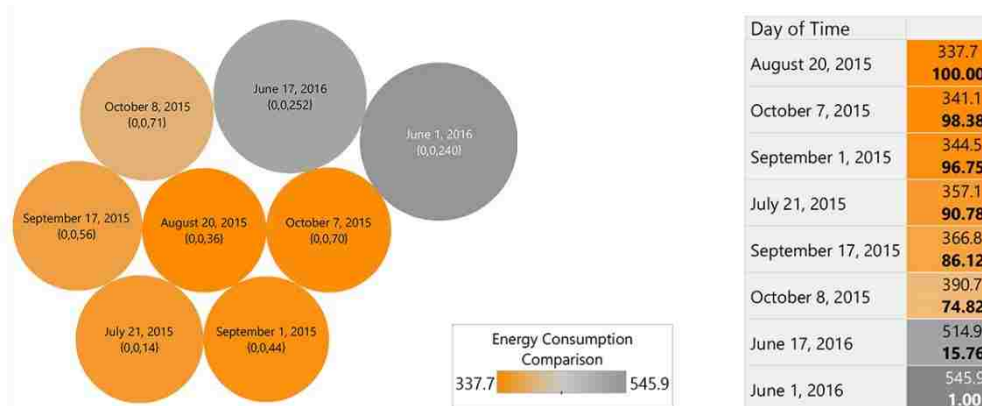

Fig. 24 Diagram and chart representing the values within the goal space and their ranking based off energy consumption

GENETIC COMPARISON OF ENERGY CONSUMPTION PROCESS OF SCRIPTING

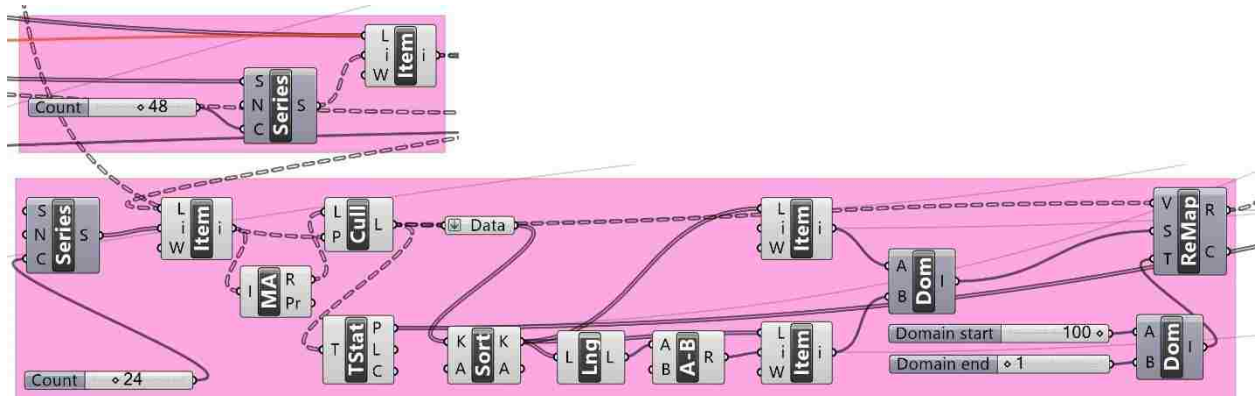

Fig. 25 Grasshopper script of indexing and comparing energy consumption values

EBOSS's grasshopper script for the process of genetic comparison of energy consumption takes the potential solutions found within the previous process and retrieves their energy consumption through the "list item" component and their index coding developed previously. (Gupta, 2016)

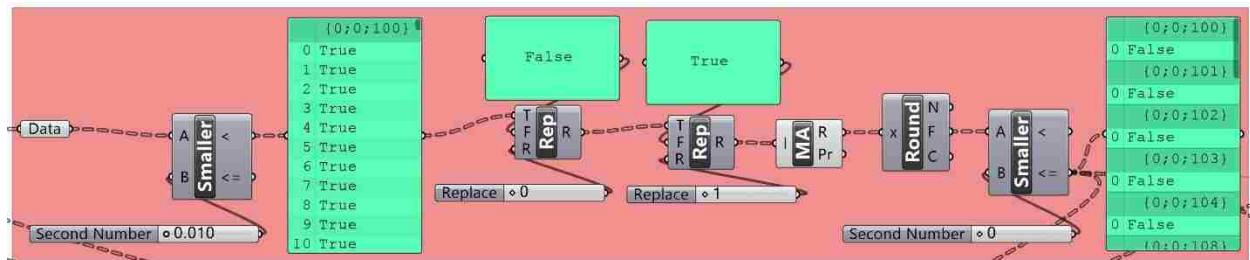

Fig. 26 Grasshopper script of culling errors

To reduce the chance of errors, the script first takes the energy consumption of each 48-hour set of past data and culls out any value that could potentially be incorrect. Energy consumption of the Bullitt Center has a potential to be negative if there was maintenance being done to the building. To remove these solutions with errors, the "smaller than" component tests each hour's value in the 48-hour sets for negatives and creates a cull list that will remove these solutions with errors from the developed goal space. (Gupta, 2016) After EBOSS has culled out any possible solutions with errors, it can perform an addition of the 48-hour set's energy consumption with the "mass addition" component to get their overall energy use for that set. (Gupta, 2016) These numbers are sorted to retrieve their upper and lower bounds of energy consumption, and these bounds are reconfigured to be 1 to 100 with the "remap numbers" component. (Gupta, 2016) The result is a quantifiable value for the Fuzzy Logic System that ranks each solution on its figure of merit for energy consumption.

GENETIC COMPARISON OF OCCUPANT COMFORT

EBOSS currently does not utilize a genetic comparison of occupant comfort, but has the capability to include it in its calculations.

Occupant comfort has been a difficult metric to record within architecture until recently. New applications developed can allow for users to record their comfort level at any time on their phone, which can then be stored within the past data alongside the weather conditions, energy usage, and systems used.

The Edge in Amsterdam, designed by Deloitte, is an example of a building that utilizes its own phone application to record occupant comfort levels. (Lebowitz, 2015) This building will become the precedent of data informed decisions for the maintenance of buildings as technology progresses to evolve in parallel to architecture. Genetic comparison of occupant comfort will allow EBOSS to not only find an optimal day in similarity of temperature and the reduction of energy usage, but also highest level of comfort for its occupants.



Fig. 27 Examples of applications that could be used to measure occupant comfort



Fig. 28 Image of the Edge

FUZZY LOGIC CONTROL SYSTEM METHODOLOGY OF APPROACH

EBOSS uses a Fuzzy Logic Control System to maintain and regulate the degree a design goal effects the output values. In contrast to Boolean logic, the truth values of a variable may be any real number between 0 and 1. (Dounis, 2009) This produces a form of many-valued logic that allows for a larger range of results. The weights added to each rule can regulate the amount to which a rule affects the output values. Rule weightings can be based on priority or reliability. This system also allows for weightings to be either static or changed dynamically. An example would be if the building wished to focus on reducing energy use for the day, it can lower the weight for temperature similarity to produce results that focuses on developing a set of systems that would use the least amount of energy.

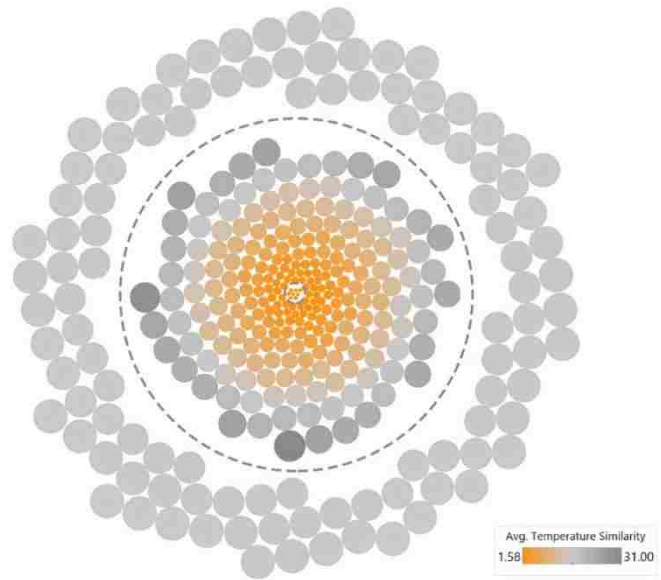

Fig. 29 Diagram of the values in the goal space that will be used for the Fuzzy Logic System

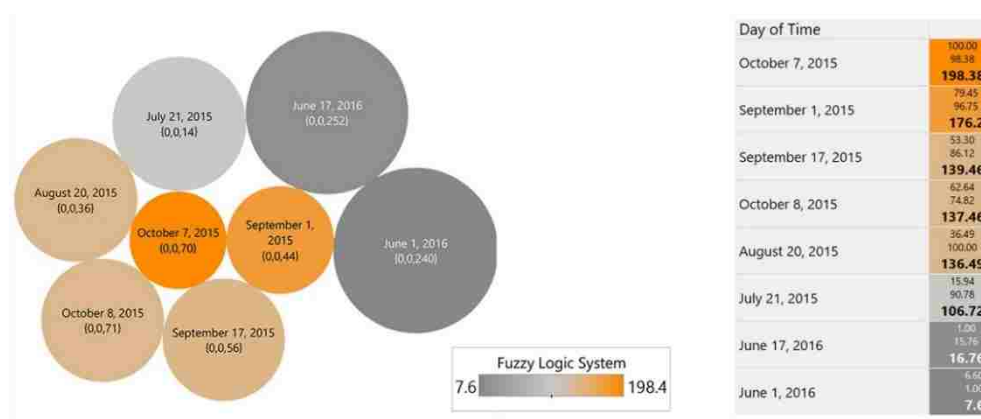

Fig. 30 Diagram and chart representing the values in the goal space and their ranking based off the Fuzzy Logic System

FUZZY LOGIC CONTROL SYSTEM
PROCESS OF SCRIPTING

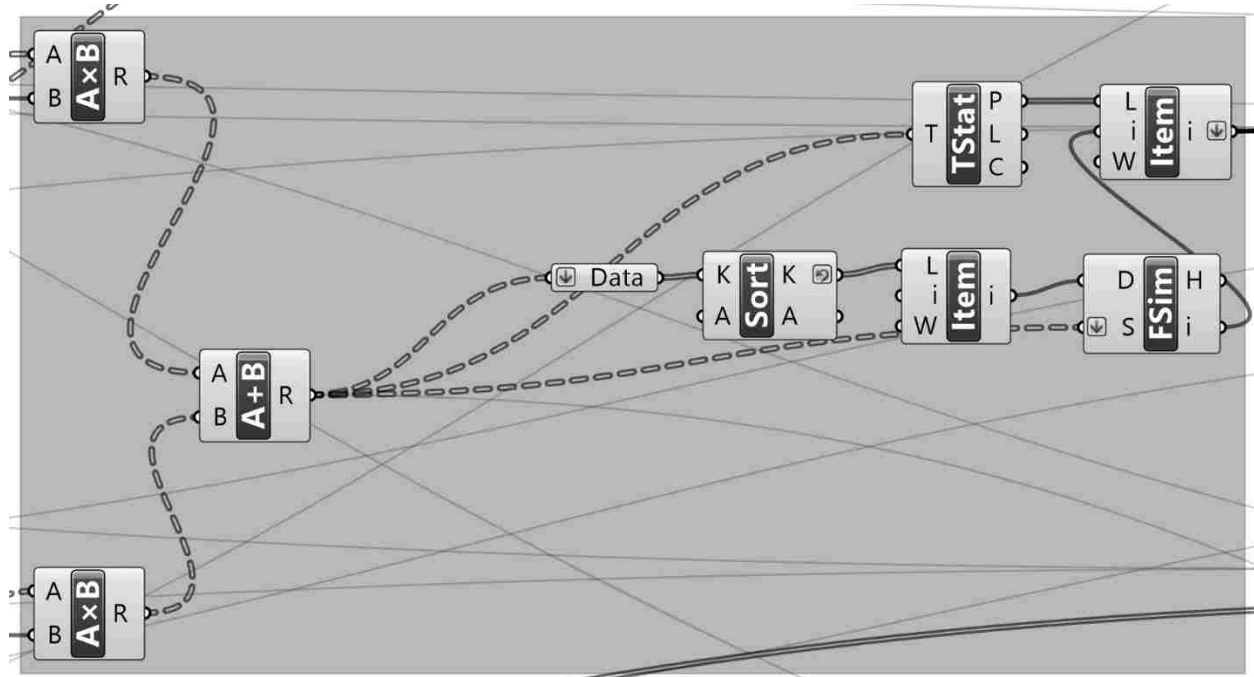

Fig. 31 Grasshopper script of the weights being applied in the Fuzzy Logic System

EBOSS's grasshopper script for the Fuzzy Logic Control System takes the quantifiable, remapped values produced through the genetic comparison of temperature and energy consumption and multiplies them by the previously determined input values of weights. (Dounis, 2009)

Ex. Fuzzy Logic System (Date) = (Temperature rank * 0-1 Weight) + (Energy rank * 0-1 Weight)

$$\text{Fuzzy Logic System (October 7th 2015)} = (100 * 1) + (98.38 * 1) = 198.38$$

Temperature Similarity Weight = 100% and Energy Consumption Comparison Weight = 100%

or

$$\text{Fuzzy Logic System (October 7th 2015)} = (100 * .5) + (98.38 * 1) = 148.38$$

Temperature Similarity Weight = 50% and Energy Consumption Comparison Weight = 100%

This process of many-valued logic allows for the user of EBOSS to easily change the outcomes dynamically without additional costs to computing. After EBOSS calculates the results from the Fuzzy Logic Control System, they are then sorted through the "sort list" component to retrieve the potential solution with the highest figure of merit, or the most optimized solution. (Gupta, 2016)

OUTPUTS

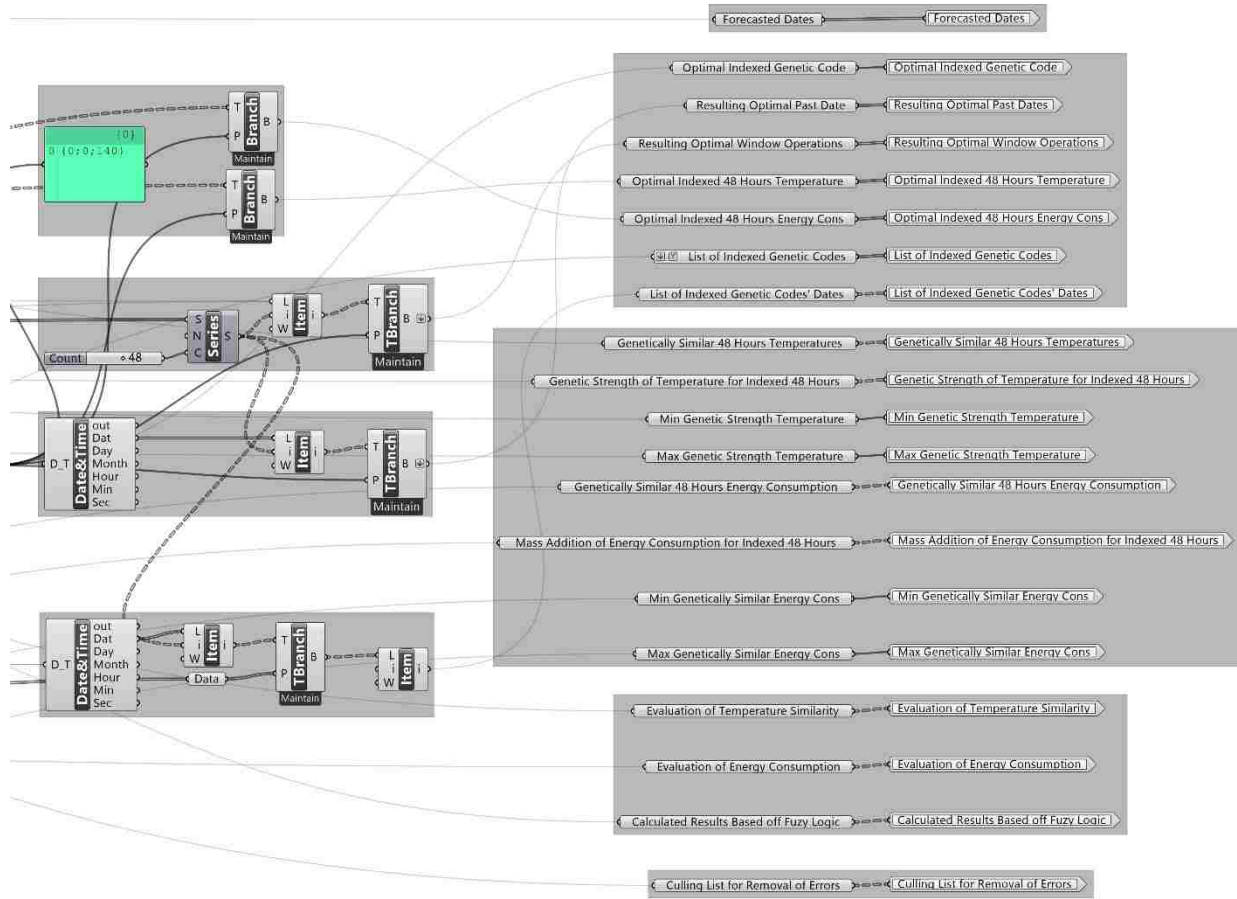

Fig. 32 Grasshopper script showing the available outputs provided by EBOSS

The outputs of EBOSS are generated through the optimal genetic code found through the Fuzzy Logic System. This code allows for the easy retrieval of the ideal past date's temperature, energy consumption, and window operations. This information will better inform the user on which systems to use for the next day in response to the weather forecast.

EBOSS also takes advantage of its plethora of data by giving its users access to every value that influenced design decisions. These values include lists of the potential solutions': genetic codes, dates, temperature, genetic strength of temperature, genetic comparison of energy consumption, the minimum and maximum temperatures within the goal space, the minimum and maximum energy consumption within the goal space, the calculations from the Fuzzy Logic System, and the culling list for removal of errors.

SOLUTIONS

EBOSS produced two categories of solutions when looking at the process of night flushing. The first being days where night flushing was not preformed and should have. The second being days where night flushing was preformed and should not have.

June 3rd was a case of a suboptimal day where night flushing was needed. Due to the previous day's temperature only reaching 68 degrees, the Bullitt Center's rule based system for window operations deemed that the process was unneeded. June 3rd would have instead been a perfect candidate for night flushing with a maximum temperature of 83 degrees.

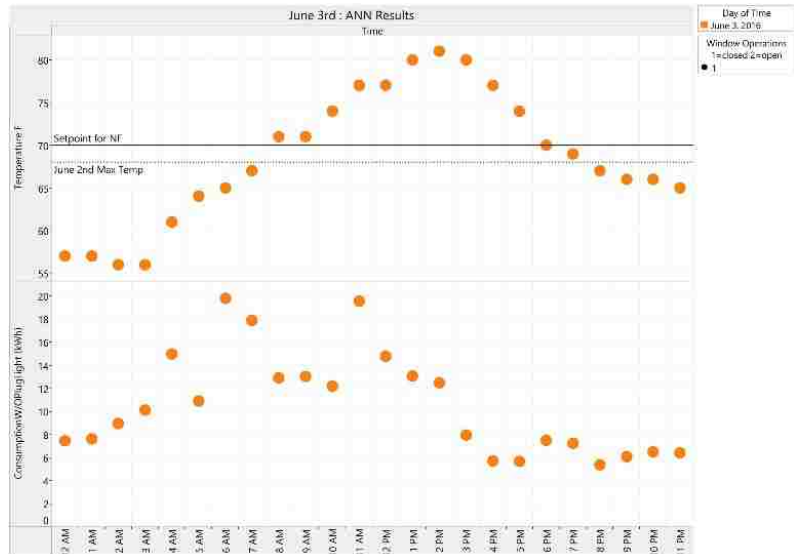

Fig. 33 Graph of June 3rd's temperature and energy consumption

April 2nd was a case of a suboptimal day where night flushing was not needed. Due to the previous day's temperature reaching 70 degrees, the Bullitt Center's rule based system for window operations deemed that the process was needed. Instead, April 2nd should not have performed night flushing with a maximum temperature of only 62 degrees.

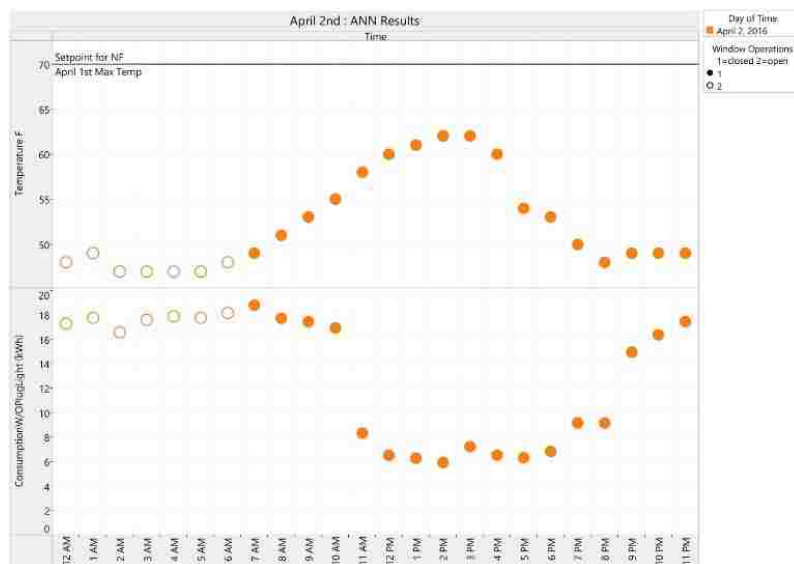

Fig. 34 Graph of April 2nd's temperature and energy consumption

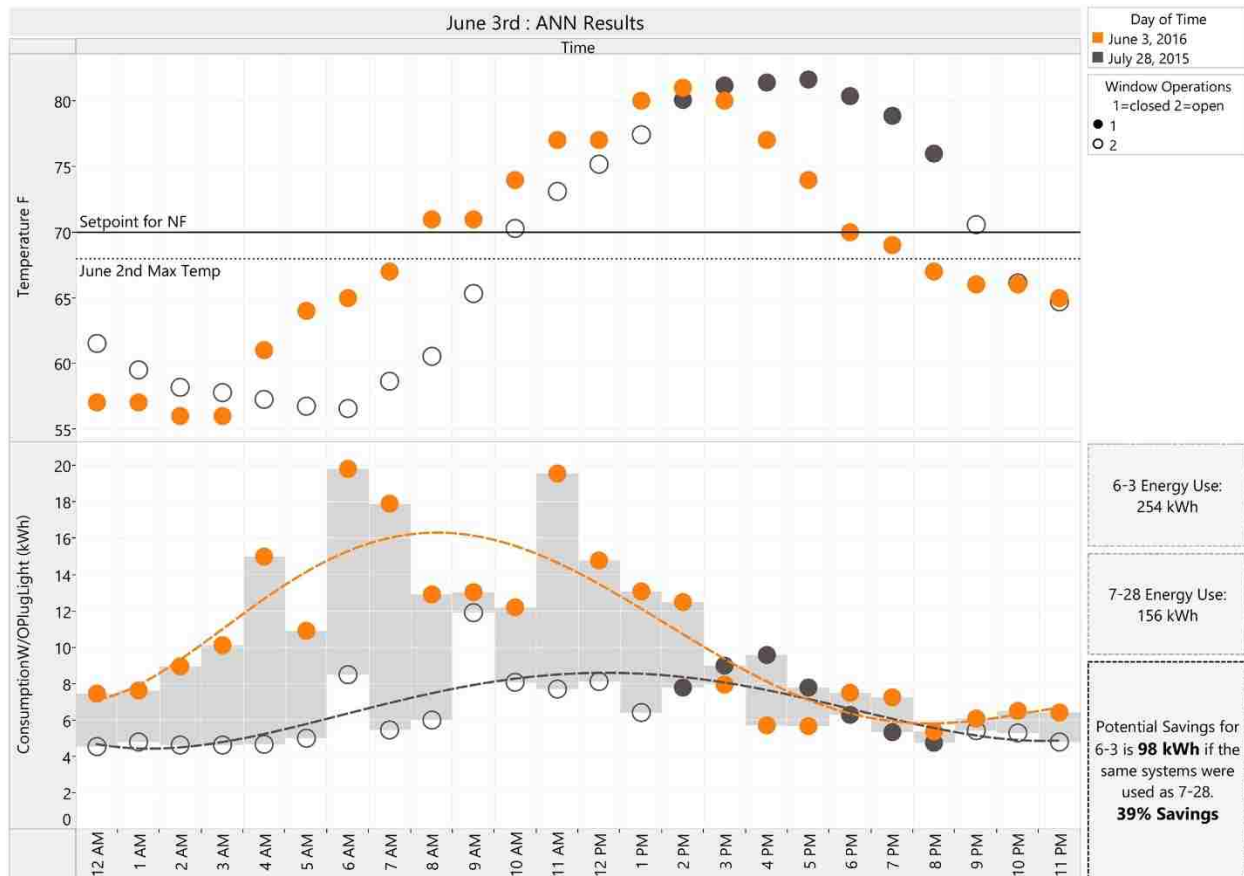

Fig. 35 Graph of June 3rd's results when compared to an optimized day of July 28th

The resulting day of July 28th was produced as the best solution after placing the suboptimal day of June 3rd into the EBOSS program. Through the calculations of temperature similarity and energy consumption, July 28th was deemed as a more appropriate set of building systems for the day's weather conditions.

These two days have a similar temperature profile, but differ greatly in the systems being used. The suboptimal day of June 3rd did not perform night flushing due to the previous day's max temperature only being 68 degrees. This oversight due to changing weather resulted in June 3rd having an energy use of 254 kWh, a surplus being used to actively cool the building. When compared to the optimal day of July 28th, where night flushing was preformed, energy consumption is much lower at 156 kWh. These results show that there is a potential savings of 98 kWh on June 3rd, or 39%, if the same systems were used as July 28th.

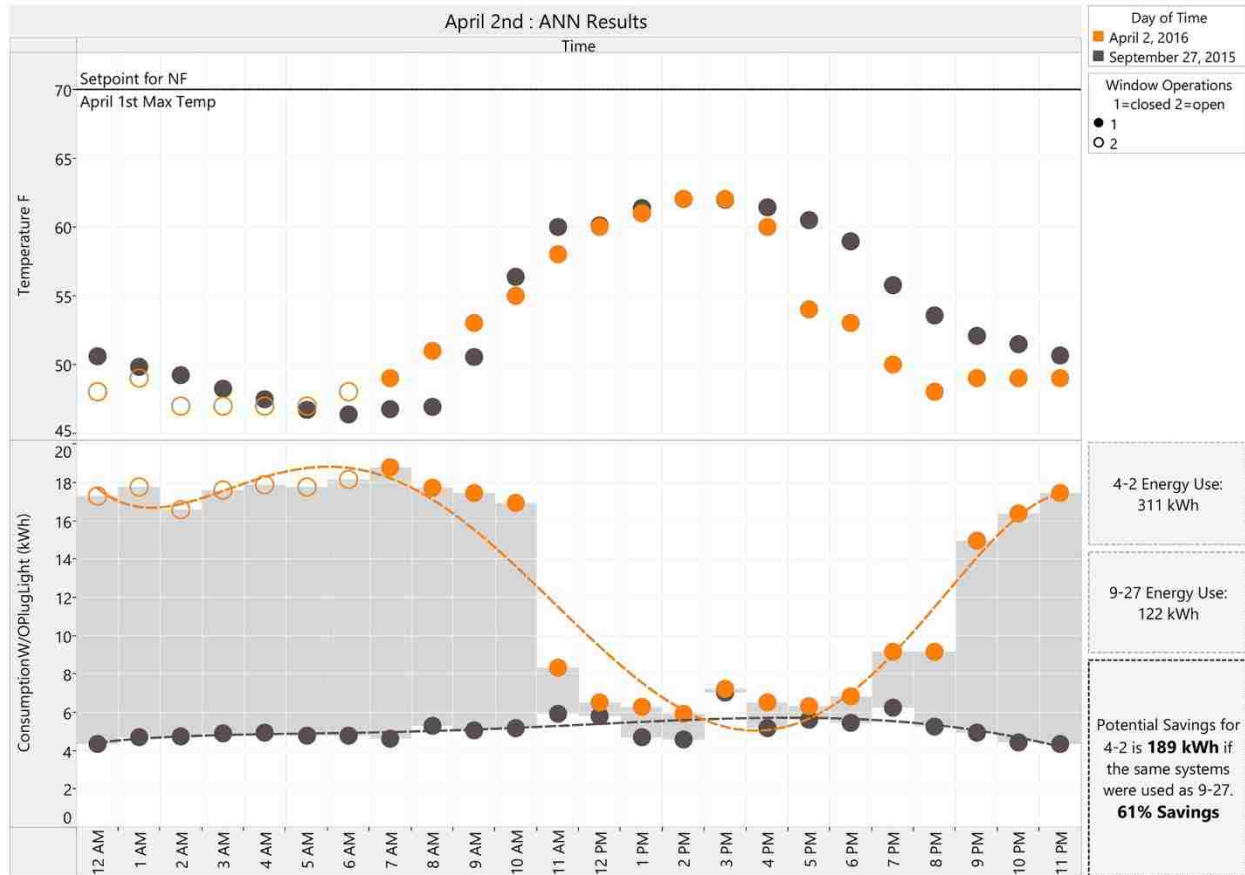

Fig. 36 Graph of April 2nd results when compared to and optimized day of September 27th

The resulting day of September 27th was produced as the best solution after placing the suboptimal day of April 2nd into the EBOSS program. Through the calculations of temperature similarity and energy consumption, September 27th was deemed as a more appropriate set of building systems to be used for the day's weather conditions.

These two days have a similar temperature profile, but differ greatly in the systems being used. The suboptimal day of April 2nd performed night flushing due to the previous day's max temperature being 70 degrees. This oversight due to changing weather resulted in April 2nd having an energy use of 311 kWh, a surplus being used to actively heat the building after it had just preformed precooling. When compared to the optimal day of July 28th, where night flushing was not preformed, energy consumption is much lower at 122 kWh. These results show that there is a potential savings of 189 kWh on April 2nd, or 61%, if the same systems were used as September 27th.

MACHINE LEARNING

EBOSS can maintain a building as an intelligent system through the process of machine learning. The use of an Artificial Neural Network allows for the system to develop over time as data is continuously augmented and the optimized results become available as later possible solutions.

The database of past solutions has the potential to grow in size. If data is continuously being processed and recorded, EBOSS will evolve over time as it searches and tests different sets of systems for different scenarios of environmental conditions.

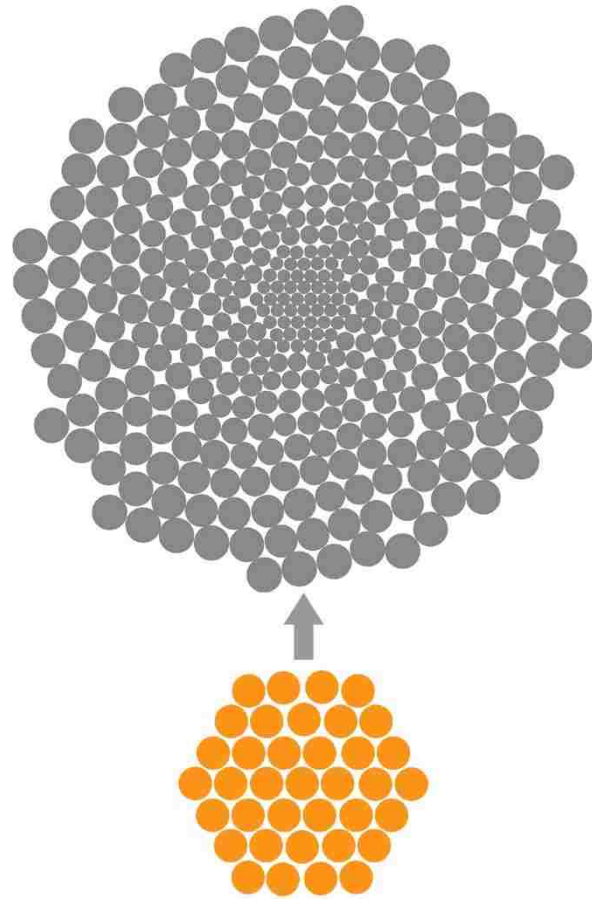

Fig. 37 Diagram of the process of machine learning

EBOSS CONCLUSION AND POSSIBILITIES

EBOSS performed calculations for 16 days of suboptimal systems usage (appendix). Within these 16 days, there was a total of 5 days where the process of night flushing should have been used and 11 days where the process of night flushing should not have been used. If EBOSS had operated the Bullitt Center's window operations for the 5 days that needed night flushing, there could be a potential reduction of energy use by 575 kWh over those 5 days, or an average of 41%. This means there will be a consequence of 41% additional energy use each time the Rule Based System fails and does not use night flushing. Likewise, if EBOSS was used for the 11 days that did not need night flushing, there could be a potential reduction of energy use of 1742 kWh over those 11 days, or an average of 47%. This produces a consequence of 47% additional energy use each time the Rule Based System fails and uses night flushing when it is not needed. EBOSS demonstrates that it can reduce energy consumption by avoiding oversights and environmental control errors found within the Rule Based System.

EBOSS has only been tested on the Bullitt Center, a high-performance office building located in a temperate marine climate, with cool, rainy winters and mild, dry summers. This tool could also be utilized for many different typologies of architecture and different climates as long as data is being recorded and occupation can be predicted. Programs types like schools, hospitals, and hotels that have regular occupation schedules could use EBOSS to better maintain systems.

BIBLIOGRAPHY

Álvarez, J.d., J.I. Redondo, E. Camponogara, J. Normey-Rico, M. Berenguel, and P.m. Ortigosa.

"Optimizing building comfort temperature regulation via model predictive control." *Energy and Buildings* 57 (2013): 361-72. Web.

Bhatt, Sanjay. "Bullitt Center tops its green goals, is making energy to spare." *The Seattle Times*. The Seattle Times Company, 28 Mar. 2015. Web. 31 Mar. 2017. <<http://www.seattletimes.com/business/real-estate/bullitt-center-tops-its-green-goals/>>.

Dounis, A.i., and C. Caraiscos. "Advanced control systems engineering for energy and comfort management in a building environment—A review." *Renewable and Sustainable Energy Reviews* 13.6-7 (2009): 1246-261. Web.

Dorst, Kees. "On the Problem of Design Problems - problem solving and design expertise." *J. of Design Research* 4.2 (2004): 0. Web.

Eto, Joseph, "Characterizing The Effects of Weather on Commercial Building Energy Use", (1985) Berkeley, CA

"Flux - Share data. Not files." *Flux.io*. N.p., n.d. Web. 30 Mar. 2017. <<https://flux.io/howitworks/>>.

"Grasshopper." *Grasshopper - algorithmic modeling for Rhino*. N.p., n.d. Web. 30 Mar. 2017. <<http://www.grasshopper3d.com/>>.

Gupta, Harsh, and Andrew Heumann. "Grasshopper Components." *Grasshopper Component Reference*. N.p., n.d. 2016. Web. 30 Mar. 2017. <<http://rhino.github.io/components/.html>>.

Hensel, Michael, and Achim Menges. "Designing Morpho-Ecologies: Versatility and Vicissitude of Heterogeneous Space." *Architectural Design* 78.2 (2008): 102-11. Web.

Henze, Gregor P., Clemens Felsmann, and Gottfried Knabe. "Evaluation of optimal control for active and passive building thermal storage." *International Journal of Thermal Sciences* 43.2 (2004): 173-83. Web.

Kalay, Yehuda. "Architecture's New Media: Principles, Theories, and Methods of Computer-Aided Design". Cambridge, Mass: MIT Press, (2004) Web.

Lebowitz, Shana. "Deloitte has an office building designed to engineer the perfect workday for every employee." *Business Insider*. Business Insider, 24 Sept. 2015. Web. 31 Mar. 2017.
<<http://www.businessinsider.com/the-edge-office-building-in-amsterdam-2015-9>>.

Maasoumy, Mehdi, and Alberto Sangiovanni-Vincentelli. "Smart Connected Buildings Design Automation: Foundations and Trends." *Foundations and Trends® in Electronic Design Automation* 10.1-2 (2016): 1-143. Web.

Oldewurtel, Frauke, David Sturzenegger, and Manfred Morari. "Importance of occupancy information for building climate control." *Applied Energy* 101 (2013): 521-32. Web.

Oldewurtel, Frauke, Alessandra Parisio, Colin N. Jones, Dimitrios Gyalistras, Markus Gwerder, Vanessa Stauch, Beat Lehmann, and Manfred Morari. "Use of model predictive control and weather forecasts for energy efficient building climate control." *Energy and Buildings* 45 (2012): 15-27. Web.

Petersen, Steffen, and Katrine Wieck Bundgaard. "The effect of weather forecast uncertainty on a predictive control concept for building systems operation." *Applied Energy* 116 (2014): 311-21. Web.

Rittel, Horst, "The Reasoning of Designers", *Arbeitspapier zum International Congress on Planning and Design Theory* in Boston, August 1987. Schriftenreihe des Instituts fuer Grundlagen der Planung, Universitaet Stuttgart 1988

Yang, Jin, Hugues Rivard, and Radu Zmeureanu. "On-line building energy prediction using adaptive artificial neural networks." *Energy and Buildings* 37.12 (2005): 1250-259. Web.

Zdepski, S, "Architectural Diversity Though Climate Responsive Design", 1986, Newark, New Jersey

FIGURE SOURCES

Fig. 1 http://2uec1mzw3qc42yelv1w8xtj13zp.wpengine.netdna-cdn.com/wp-content/uploads/2015/01/medium_15010086999.jpg

Fig. 2 – 10 From Author

Fig. 11 "Architecture's New Media" by Yehuda Kalay pg. 17 and 18

Fig. 12 – 26 From Author

Fig. 27 <http://www.amyleighstrickland.com/wp-content/uploads/2014/03/SurveyMonkey.png>

http://media.bizj.us/view/img/10242551/honeywell-vector-occupant-app-12-hr*750xx2700-1519-0-231.jpg

<https://www.pubnub.com/wp-content/uploads/2015/09/CrowdComfort-weblogo.jpg>

<http://cdnassets.hw.net/dims4/GG/dc77b45/2147483647/resize/876x%3E/quality/90?url=http%3A%2F%2Fcdnassets.hw.net%2F5b%2F92%2F2270be514acebed847ed73c83f96%2Ftech2017-comfyapp.jpg>

Fig. 28 <https://companies.mybroadband.co.za/schneider-electric/files/2015/09/The-Edge-in-Amsterdam.jpg>

Fig. 29 – 37 From Author

APPENDIX

