

Under The Big Naust
A Return to The Polyvalent Structure:
Migrant Housing in Marginal Norway

Jared A. Luther

A thesis
submitted in partial fulfillment of the
requirements for the degree of

Master of Architecture

University of Washington
2016

Committee:

Jim Nicholls

Jennifer Dee

Program Authorized to Offer Degree:
Architecture

© Copyright 2016
Jared A. Luther

University of Washington

Abstract

Under The Big Naust
A Return to The Polyvalent Structure:
Migrant Housing in Marginal Norway

Jared A. Luther

Chair of Supervisory Committee:
Senior Lecturer, Jim Nicholls
Architecture

The twentieth century may be defined by many things, however it is the frenzied rate of exchange that will certainly come to define the twenty-first century. As the movement of large groups of people becomes more fluid due to the rapid development of technology, the weakening of national borders, and the pull of Western capital, more and more people are experiencing states and times that can be characterized as transnational. Interestingly, in the developed West, new flows of transnational labor are drawn into rural and marginal landscapes. In these at-times reactionary places, the global and the local are increasingly compounded. This thesis examines these trends occurring in the marginal areas of Arctic Norway and searches for an architectural language that allows new arrivals to truly dwell in an alien world.

PREFACE



Figure 1: Nordland Harbor



Figure 2: Naust

These sketches are from a University of Washington Valle scholarship study trip taken in the summer of 2014 into Northern Norway. The study Trip was centered on searching for examples critical regionalism, including the naust, or Norwegian word for boathouse, as seen in *Figure 2*. After two months of travel, I attended the Oslo School of Architecture and Design, taking a timber design studio with Håkon Vignæs of Jarmund Vignæs Architecture. In many ways, these sketches can be seen both as a point of origin and a as point of divergence for the course of this thesis.

During the study trip, while camping in a farmer's field after searching for the purity of hyper-local, I was awoken by migrant farm laborers blasting Techno music. Though these types of vernacular buildings do serve as examples of the particular in an increasingly generalized world, clearly the rural idyll and the realities of modernization have created a

landscape rife with contradiction and evolving narrative. Curiously, the sustaining energy in northern Norway, a region lauded for a brand of insular self-sufficiency, is the arrival of the transnational laborer. This thesis calls for a rural architecture that reflects a changing cultural landscape, using a current carpentry to create a grounding, for any time.



Figure 3: Naust Detail

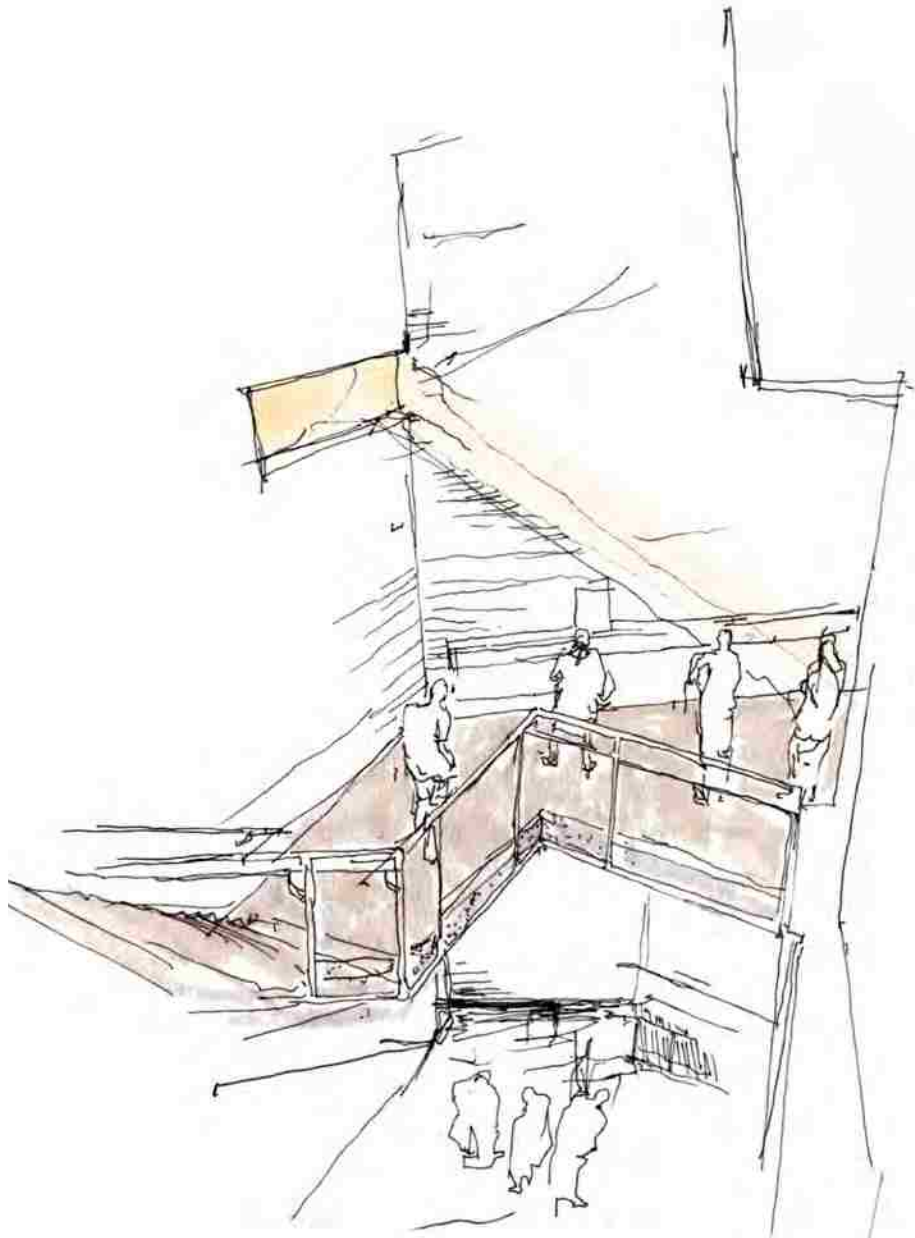

Figure 4: Sketch, Interior of Hamsun Center, Nordland



Figure 5: Sketch, Pulpit Rock Visitors Center

TABLE OF CONTENTS

I. MOVEMENT AND PLACE

i. Contrast and Continuity in Marginal Norway....1

ii. Flows at The Regional to Site Level.....7

II. MOVEMENT THROUGH TIME

i. Past Flows.....16

III. PROCESS OF STUDY

i. *Tun and Ryding*.....22

ii. The Tectonic Language of the Naust.....27

IV. DESIGN

i. Fushion of Studies In-Site.....34

ii. Architectural Design at Ballstadlandet.....41

V. APPENDICES

i. Portrait of a Marginal Landscape: The Policy,
Economy and Identity of The Norwegian
Countryside.....53

ii. The Polyvalent Structures of The North
Atlantic; aFoundation for Building on
Vestvågøy Island.....58

iii. An Inquiry into Values: Impressions of Nordic
Architecture from the Road.....63

I. MOVEMENT AND PLACE

i. Contrast and Continuity in Marginal Norway

The nineteenth century painter Christian Krohg called the mountains in Lofoten "altars for the gods of loneliness." Despite the commodification of the landscape and flatness of the current world, these scraggy cliffs still manage to cast a long shadow. However, rather than in the traditional upland settler, Krohg's trope of existential isolation now sees its continuation in the new marginality of the Eastern European laborer.

On Norway's Lofoten Islands, North of the Arctic Circle, 24,000 people live without any sunlight from December to January. A peculiar duality has begun to exist in these far-flung places as the labor that sustains these scattered settlements is from transnational migrants.

While the Lofoten Islands are the product of self-reliance, now in the town of Reine, just south of the municipality of Vestvågøy, one in five residents is a Polish migrant.¹ Working through the winter darkness, the Polish laborer Bogumil Lewandowski says of his position and location, "It's as if the earth ends with these islands."² As expressed by Lewandowski, the sudden transfer of people and norms to new contexts, often results in alienation and the loss of meaning. Yet, within this sudden juxtaposition of worlds, there also comes a chance for new beginnings to be found in the layering of new character onto rural spaces.

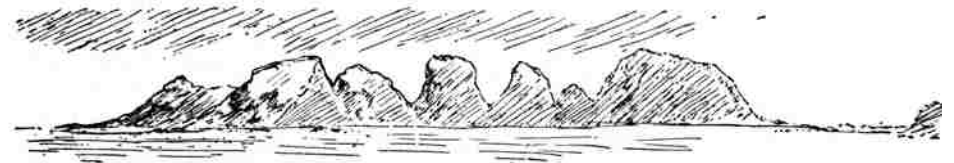

Figure 6: Theodor Kittelsen's *Fra Lofoten* 1891

The nature of northern settlement as well

1. Wojciech Moskwa, "Polish Builders In Norway's Artic Darkness". Reuters: November 2006, Available: <http://uk.reuters.com/article/2006/11/24/lifestyle-norway-lofoten-dc-idUKL2277324520061124>

2. Ibid

as the rural gestalt have been made infinitely more complex by the region's inclusion within the global market. Professor Johan Frederick Rye of Norway's Center for Rural Research notes that within rural Norway, the migrant laborers' seasonal, yet often recurrent employment, represents a form of:

Circular rural migration, where the actors are flowing in and out in adherence to biological rhythms of agricultural production. At a collective level, the migrant farm workers represent a phenomenon of permanent circulation. Further, the presence of farm migrants contributes to further erasure of traditional rural borders, as it demonstrates the translocal character of rural communities.³

With the movement of people becoming more fluid and market forces drawing people into increasingly distant landscapes, there is not only a need for housing in marginal Norway; there is a need for an architecture that existentially grounds new arrivals.

3. Joanna Andrejewska and Johan Fredrik Rye (2012): "Lost in Transnational Space? Migrant Farm Workers to Rural Districts. *Mobilities, Center for Rural Research Norway, Department of Sociology and Political Science.* 7:2,247-268.

The aim of this thesis is not to solve a problem categorically per-se, but to examine these trends at various scales. First, this study moves from a broad scope to the level of the particular island municipality of Vestvågøy and then finally to the resolution of an architectural scale at a specific site located at the town of Ballstad.

Rural settlements like Ballstad already possess hybrid identities. The introduction of new peoples offer to strengthen this alternative to global trends of centralization and de-population. Mark Shucksmith and Katrina Ronningen, in the *Journal for Rural Studies*, write on the quality of these marginal areas which have proved highly resilient that:

Despite severe structural pressures they continue to make important contributions to society's objectives. This combination of extreme pressures, high societal value and small farms' resilience suggests upland areas may be a promising site for alternative visions of the future to emerge.⁴

4 Mark Shucksmith and Katrina Ronningen, *The Uplands After Neoliberalism? - The Role of the Small Farm in Rural Sustainability*, *Journal of Rural Studies* 27 2011 275-287 *Journal of Rural Studies* 27 2011 275-287

North pole, latitude: 90°N

Svalbard latitude: 78°N

Nordkapp latitude: 71°N

Vestvågøy,
nordland: 68°N
polar night:
dec. 09-jan. 04
midnight sun:
may 25-jul. 17

Arctic
circle
66°N

Warsaw,
poland
53°N

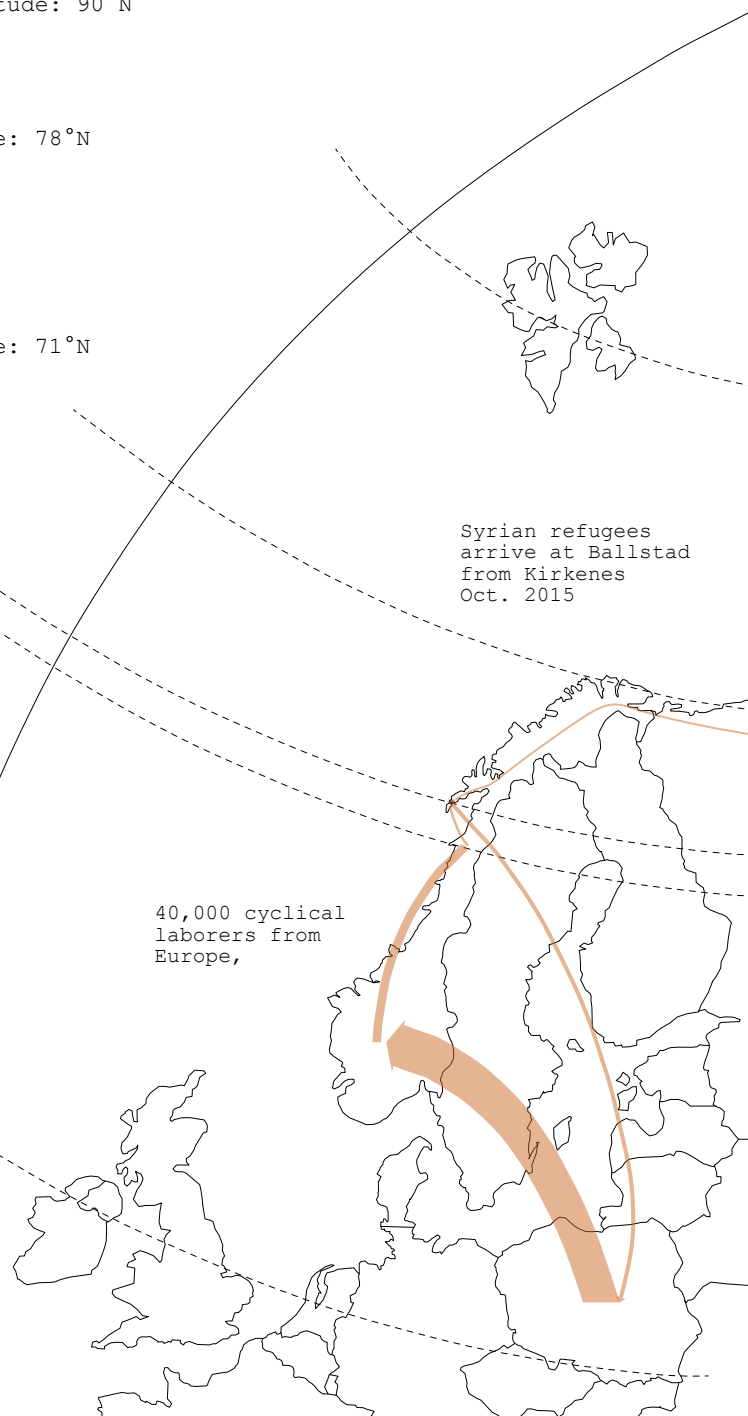

The inclusion and architectural accommodation of these new flows of people in marginal areas is part of a promising alternative vision, one full with the potential of a weak Modernism.

Figure 7 depicts the seasonal flow of 40,000 workers first to Norway itself, then to the region of Nordland, and finally to the town of Ballstad located on Vestvågøy island. Despite the economic and social restructuring that reduced the amount farms in Norway from 400,000 in the 1960's to the 45,000 extant today, the traditional fishing village and small farm continue to be the basis of cultural heritage.⁵

This is true even in Arctic regions like Vestvågøy, where government policy has encouraged agricultural development despite the northern latitude as a matter of national policy (for a further study of the

5. Johan Fredrik Rye. *The Western European Countryside from An Eastern European Perspective: Case of the Migrant Workers In Norwegian Agriculture.* *European Country Side, MENDELU: July 2014 vol. 4.* Page 328.

Figure 7: Movement and Place, International Movement to Vestvågøy

intricacies of Norwegian agricultural policy, please see Appendix 1).

These new forms of movement have powerful implications for the future of the built environment, as architecture often presupposes the stability of place. In the case of laborers moving North, accompanying this movement across space is also a qualitative transition into a new environment that is immediate and de-contextualized. As the elemental bleakness of the sketch "Midnight Sun" by the Nordic Modernist Sverre Fehn depicts, in the north, the



Figure 8: Movement Across Latitude

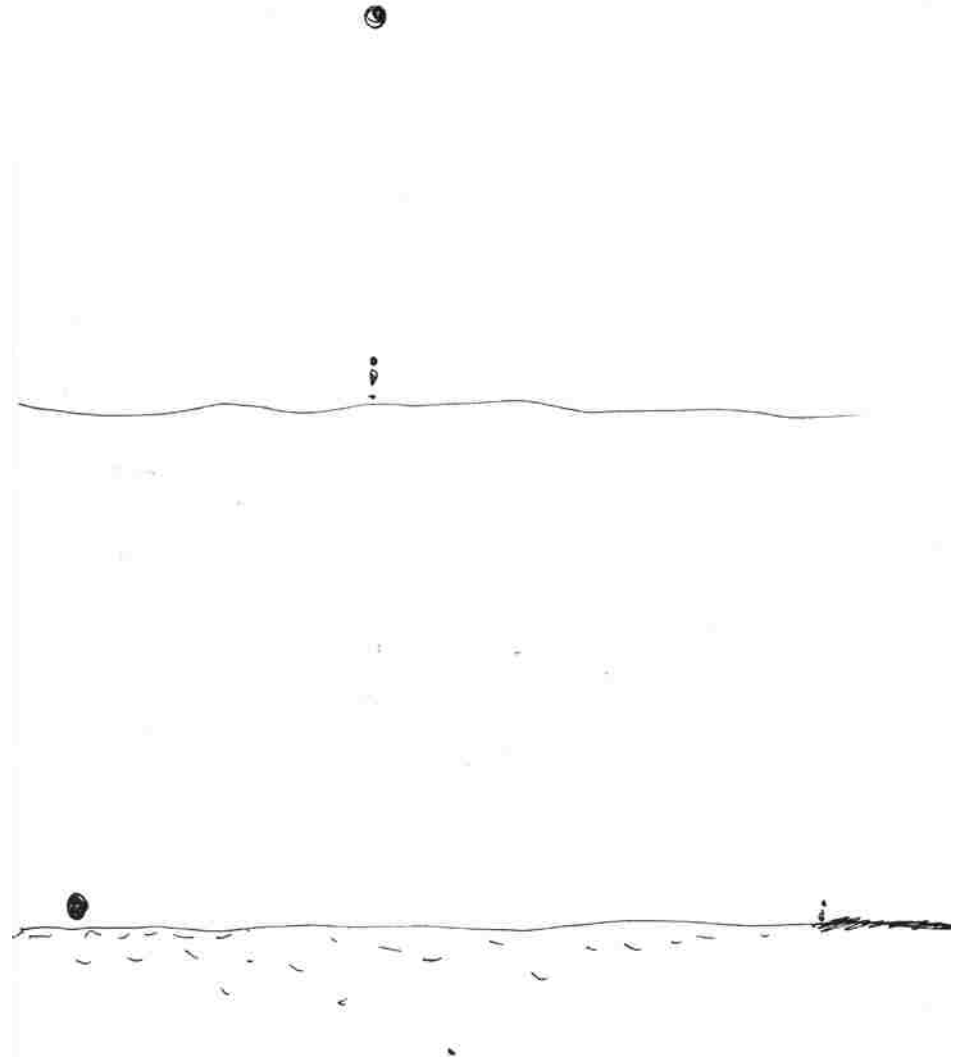

Figure 9: Sverre Fehn's "Midnight Sun"

low angle of the sun lends objects a variable and fleeting quality. Just as there is a change in temperature between continental Europe and Arctic Norway, there is so too a shift in the phenomenological order where space becomes less and less classical.

In order to alleviate this rift experienced in time and space, the challenge of the project is to link the new flows of transnational movement to the timeless rhythms of Vestvågøy Island. The exponential increase in transnational exchange and connectivity in the present era does not lessen the importance of the local, but



Figure 10: New Labor on Vestvågøy

rather demands that architecture respond as a bulwark of place in proportion to the rate of change around it. Only this can truly create the possibility of a hybridized future. As *Figure 8* illustrates, it is not just Eastern Europeans, but workers from all over filling voids in far-flung labor markets.

On a human level, these movements have created opportunity and disruption. The Norwegian Labor Ministry and Department of Social Welfare report widespread dissociation and alienation among workers in isolated rural labor. This thesis proposes a new organization of



Figure 11: Old Labor in Nordland

housing units to house and better integrate new arrivals in this strange and distant North. It is also an opportunity to re-imagine the possibilities of place with the innocent eye of a new arrival. As seen in the character of these late 19th century Nordland farmers in *Figure 11* and an example of current migrant workers on Vestvågøy in *Figure 10*, the goal of this thesis has been to produce a scheme that possesses a type of divergent continuity.

ii. Flows at the Regional to Site Level

To address the needs of these new trends at a regional scale, this study first calls for a satellite of housing units centered at the hub of Leknes (*Figure 12*). The appropriatenesses of such a scheme located at Vestvågøy has been verified by Professor Johan Frederick Rye, who has written in response to this thesis' charge that it could prove "extremely relevant for the societal challenges local communities experience, both in the Nordland region and elsewhere in rural Norway (and beyond)...Vestvågøy should provide an excellent location." The overall distribution of the units in this network mirrors local labor needs, while also providing greater linkage between migrant groups. Due to the concentration of maritime industry along the coast and the pull of the less dense agricultural

valleys, of the estimated 300 migrants coming to Vestvågøy, the proposed network will provide housing for: 100 hundred persons at Leknes, 50 at both Ure and Stamsund, 30 at Tangstad and at the periphery, 20 at the towns of Bostad and Ballstad, the site of this thesis' design intervention.

Part of the issue with migrants moving into rural is areas is that their lodging is often provided by the employer, which can be scattered, isolated, and is an environment that lacks neutrality. Thus, this satellite of housing units is envisioned to be administered by a third party and also include living space for a local Norwegian steward. The goal of this program is to promote integration and an opportunity for cultural interface. Functionally, the steward acts as the facility's caretaker, social worker, cook, and a contact point between new arrivals and the local community.

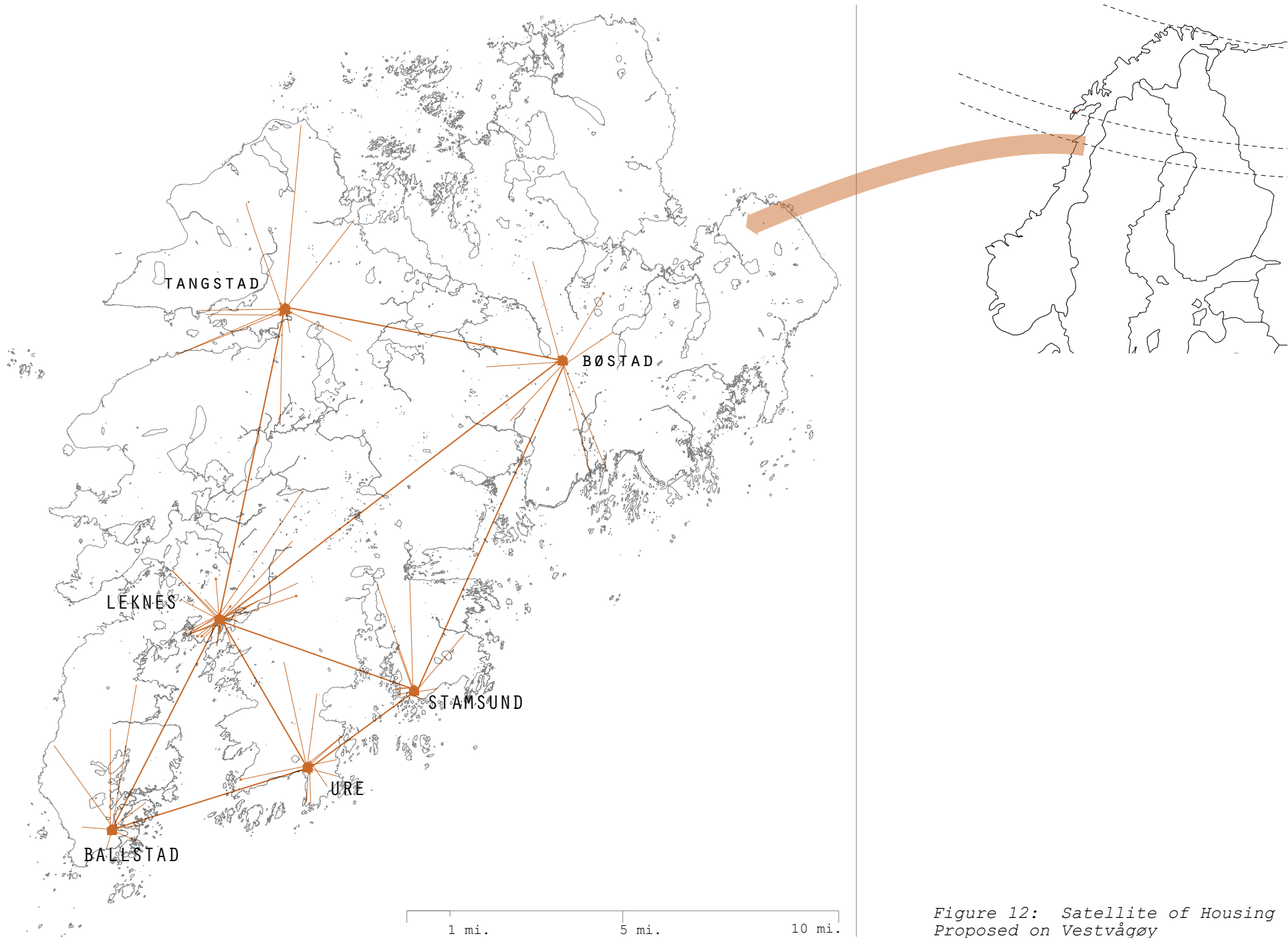
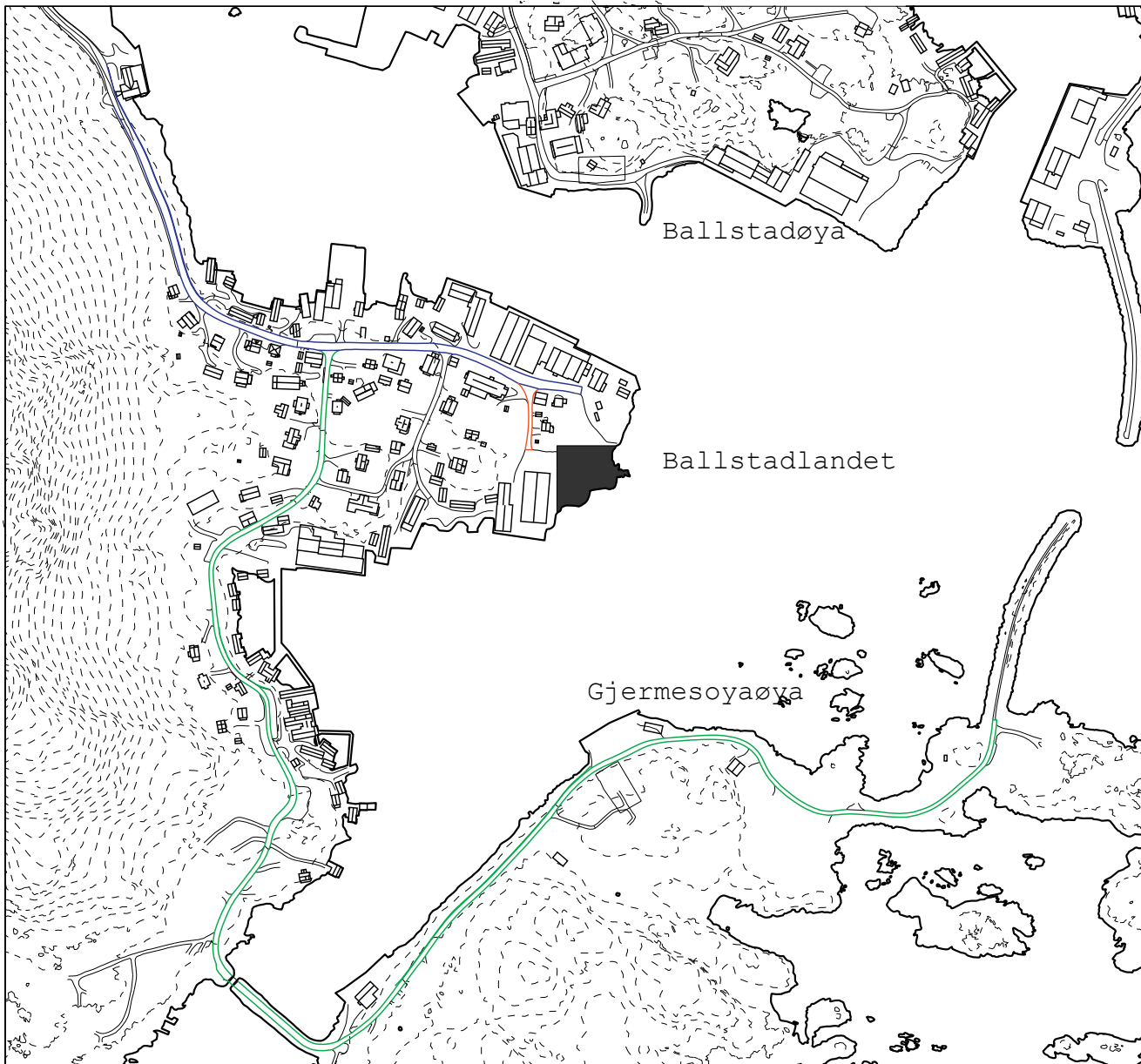

Figure 12: Satellite of Housing Proposed on Vestvågøy



Moving from the regional scale of Vestvågøy to the town of Ballstad, similar trends in development are seen. To the north, a patchwork of farms open to an agricultural interior, while maritime industry is clustered around areas of denser development.

Figure 13: Ballstad and its surroundings, site location marked in black, built up areas in light gray



Across the town, the island of Ballstadøya is linked to the peninsula of Ballstadlandet via the Ballstadlandet road (marked blue in *Figure 14*), while the islands further south of Gjermesoyaøya are connected by the winding Kraemmervikein way (marked green in *Figure 14*). The site itself is linked to road network by the Ballstadodden way (marked orange in *Figure 14*).

Figure 14: Ballstad and its surroundings, site location marked in gray



The site of this thesis' architectural intervention is the eastern end of Ballstadlandet. Currently the open space is used for the storage of *hjeller*, or fish drying racks, used in the winter cod season.

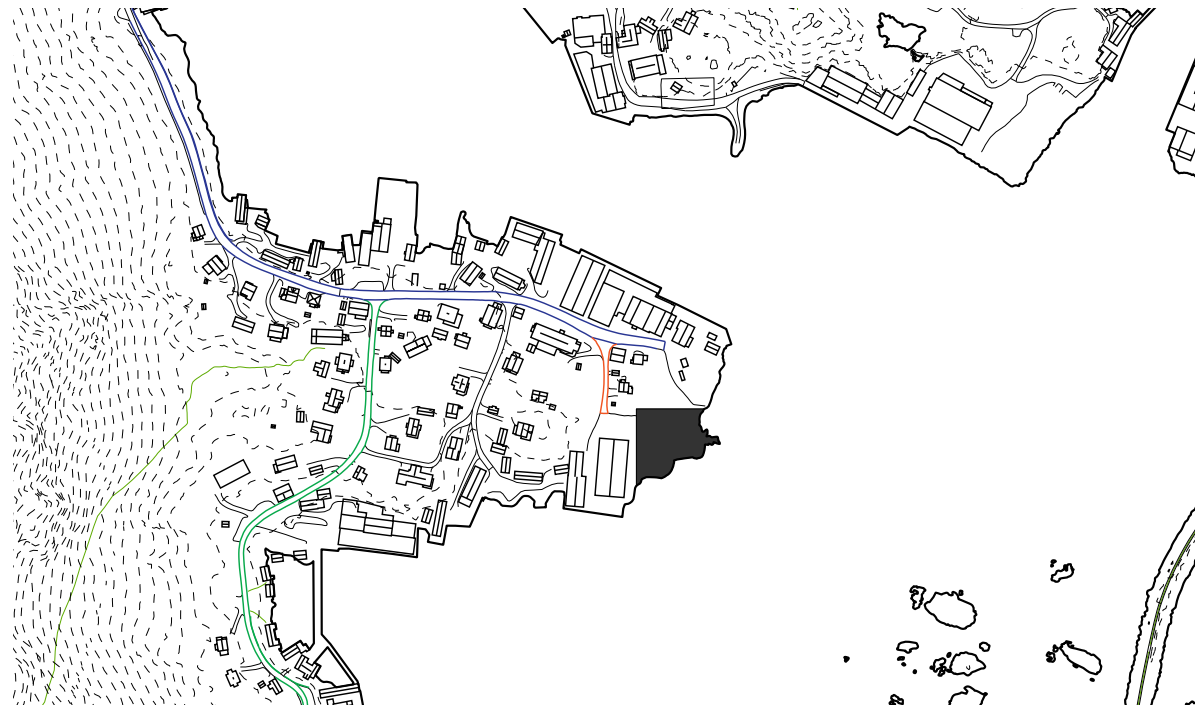

The specific location of the site can be seen in the following pages from across the harbor from Gjermesoyaøya in *Figure 16* and Ballstaddoden road in *Figure 17*. The character of the site at eye-level is shown in *Figures 18* and *Figures 21* as the concluding images of this chapter.

Figure 15: Aerial photograph of Ballstad and accompanying map with 5m contour

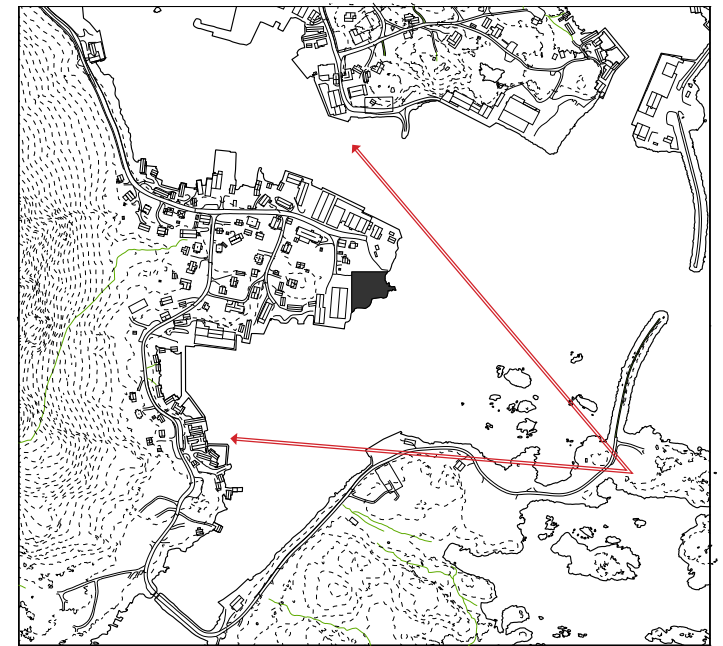

Figure 16: View from froand key

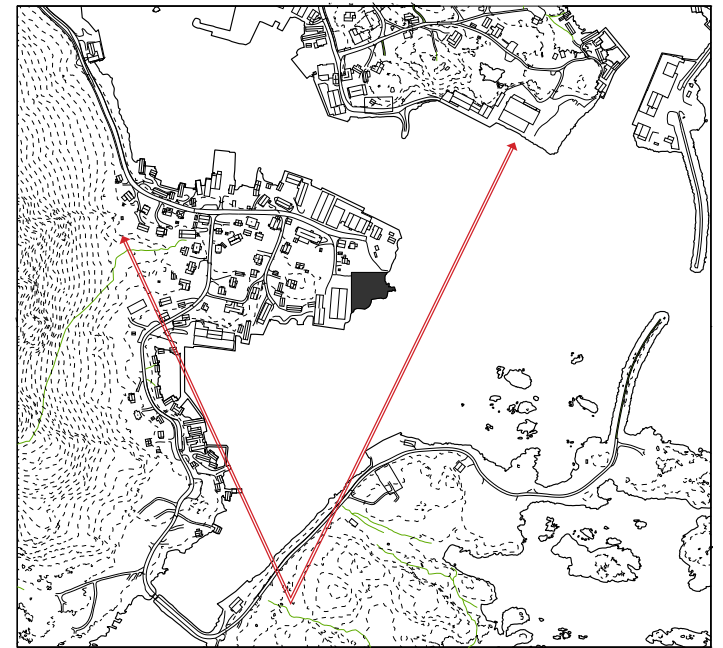

Figure 17: View north from Gjermesoyaøya

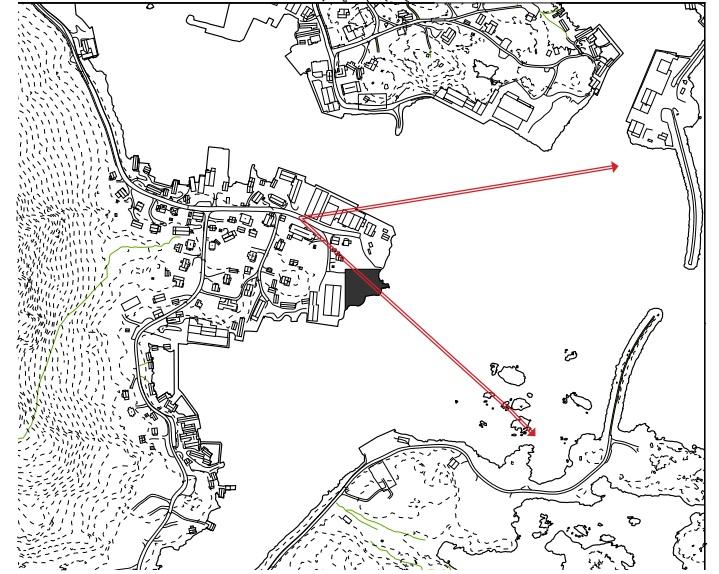

Figure 18: View east from Ballstadlandet road and key



Figure 19: View south of Ballstadlandet



Figure 20: View southeast from hillside

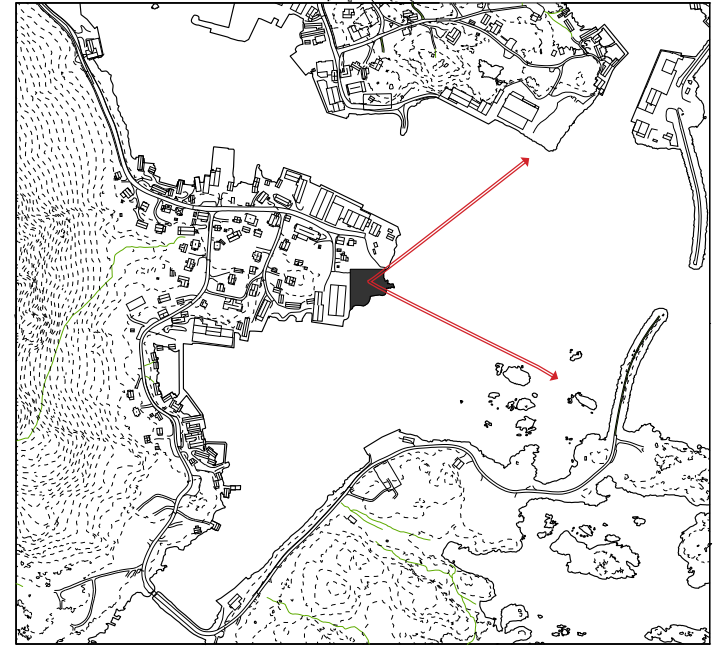

Figure 21: View east through hjeller (fish-drying racks) on site and key

II. MOVEMENT THROUGH TIME

i. Past Flows

Having narrowed in on a specific area, this thesis now reaches back in time in an attempt to establish continuity between these new trends and the history of the place. Though the present migrant labor trend is a radical departure from the norm, a historical lens reveals the island is not a place of stasis, but similarly a land in seasonal flux and shifting orientation.



Figure 22 : "Cattle Being Moved" by Anders Askevold

The two nineteenth century Norwegian paintings, *Cattle Being Moved* by Anders Askevold and the *The Dreamer. Portrait of the Painter Torleiv Stadskleiv*, by Halfdan Egedius, continue to reflect the dual nature of life on Vestvågøy. Likewise, the modern migrant experience is characterized by a buoyant harvest season which is soon foiled by the winter and the dreary mood of Egedius' *Dreamer*.

In light of these similarities in experience across time, the site at Ballstad can be considered a crossroads; it is a spot where



Figure 23: *The Dreamer. Portrait of the Painter Torleiv Stadskleiv* by Halfdan Egedius,

different people who have arrived at different times have shared in the same timeless collective response. This being the case, this thesis now looks to the pattern of settlement that first arose on Vestvågøy as framework with which to potentially mitigate modern alienation.

Curiously enough, early man and new migrants face a similar type of existential uncertainty. Whether it be the gods of old or the market forces of late capitalism, both are at the whim of unseen forces and also lack the assurances of national identity and linear time. Thus, effectively ellipsing the modern-era, this thesis looks to borrow from prehistory's patterns of architectural response to (re)order the world and concretize space anew.

The forms and patterns of settlement that grew out of the chaos of the pre-modern migration-period allowed early man to emerge from a world of darkness and turmoil. An archaeological survey of Bronze Age Vestvågøy by Professors Stephen Wickler and Gørill Nilsen of the University of Tromsø, reveal that

large boathouses, or *nausts*, were often the predominately organizing factor in the evolution of first settlements.¹ The location of these Bronze Age *nausts*, along with topography, are depicted at an island scale level in *Figure 23* on the following page.

Nausts became focal points of communities, tying regions together economically, while also existing as a type of mediating volume, functioning well beyond any type of primary utility. The *naust*, in a worldview where the landscape was alive with gods, was a conduit through which to link the uncertainty and death of the sea to a benevolent *terra firma*. Unlike the clan-based homesteads, *nausts* were only built through communal endeavor and thusly were spaces imparted with a type of democratic nature (a further history of the *naust* in the North Atlantic can be read in Appendix 2).

1. Stephen Wickler and Gørill Nilsen, *The International Journal of Nautical Archaeology. Pre-modern Boathouses: a maritime perspective from northern Norway. 41.1 pg 106-119*. Published by Blackwell Publishing Ltd. Oxford 2012.

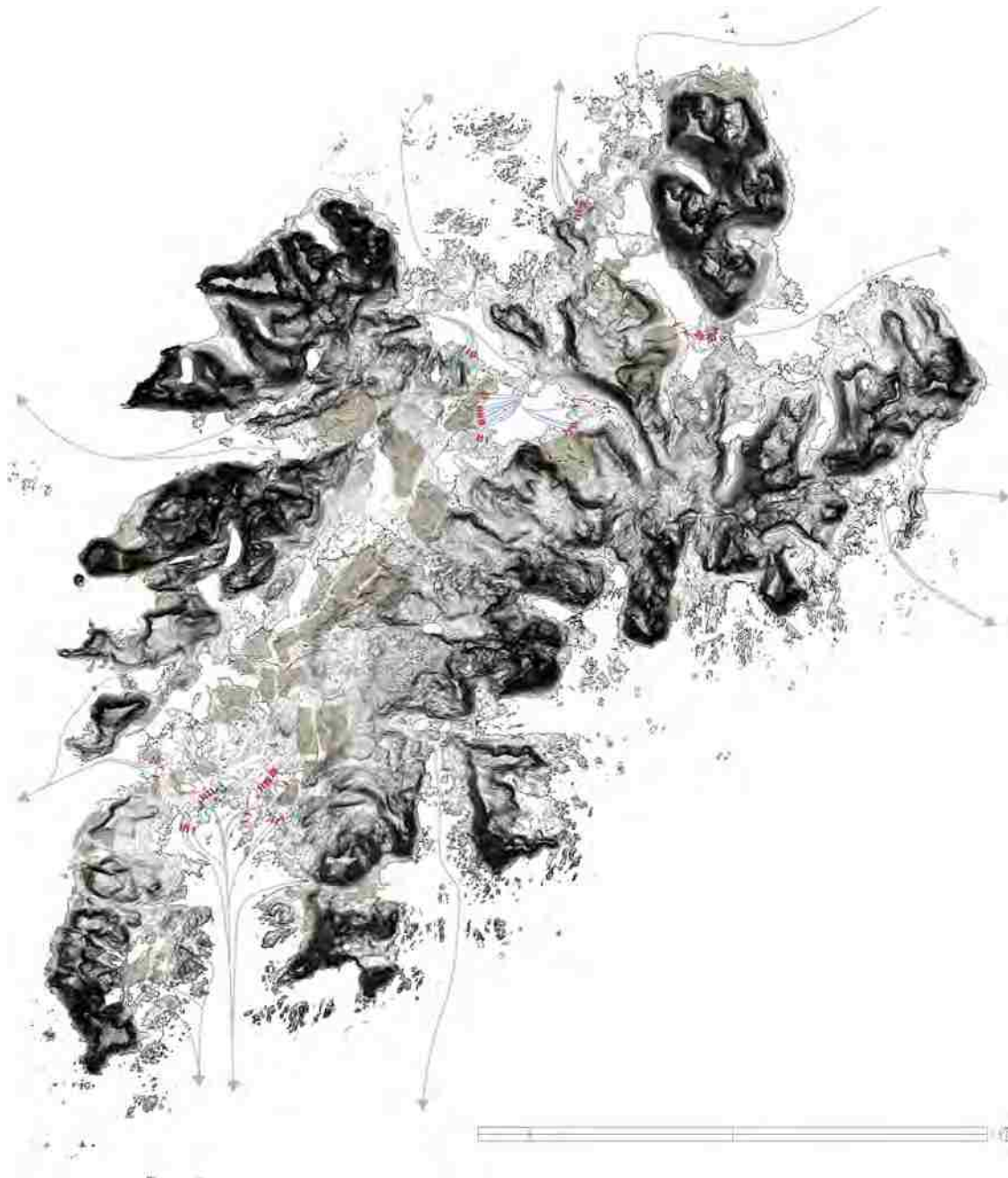

Figure 24: Naust St and agricultural valleys (green), 500 BC.

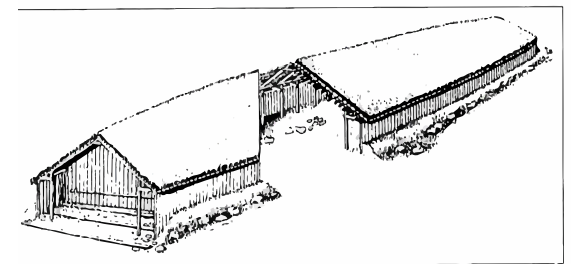
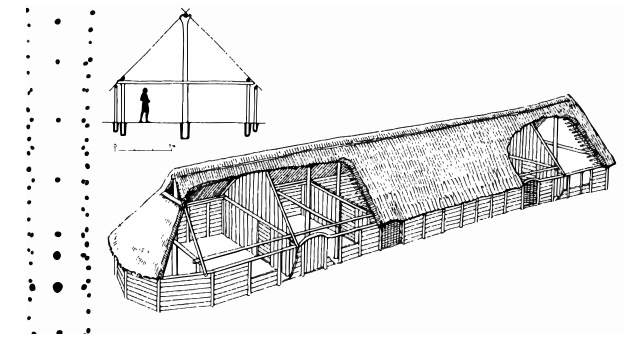
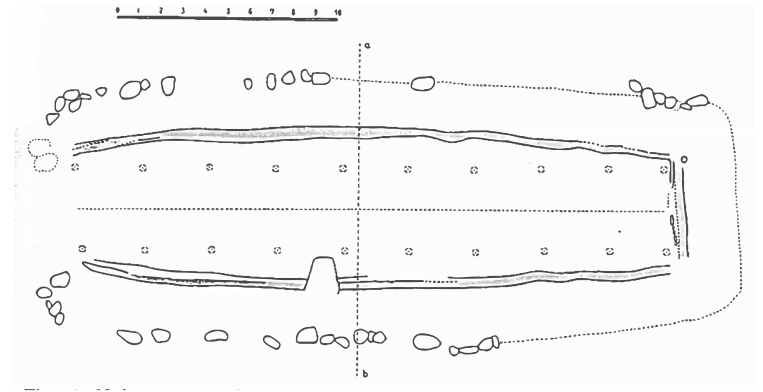

Figure 25: Typical post and lintel structure of early nausts

While modern-day development is a result of this *naust*-centric pattern of settlement, the opportunities for orientation and identification once offered by these structures are all but absent along the now industrialized coast. This thesis is an architectural return to the original sense of the coastal structure. As with the original *naust* of the area, this thesis calls for the return of the polyvalent structure for living, working, and re-contextualizing of place.

The pattern of settlement on Vestvågøy can further be understood in terms of cyclical seasonal-based activity. The archaeological record shows that arable land in the valleys has been farmed in perpetuity since the Bronze Age.² Thus, current farms and the upland division of land, as seen in *Figure 25*, are a product of the land-naust-sea pattern of settlement (*Figure 23*).

Notably, during the summer and autumn, the uplands become activated by agricultural activity. Conversely, in the winter, activity

on the island becomes concentrated along the coast and offshore fisheries (*Figure 28*). Seasonal shifts in weather, light and time thus confer contrasting orientations upon the island. The harvest season is defined by an intra-island focus and the winter months are typified by an extra-island push to the coast. Providing an architectural armature with which to synchronize the macro-shifts of international movement to the more subtle cadences of Vestvågøy is the ultimate aim of this thesis.

² Gørill Nilsen, *Jernaldernaust Pa Vestvagoy I Lofoten. Hovedfagsavhandlingi Arkeologi, Institutt For SamfunnsvitenskapUniversitetet I Tromsø 1997.*

Harvest Season: Activated Uplands and Intra-Island Pattern

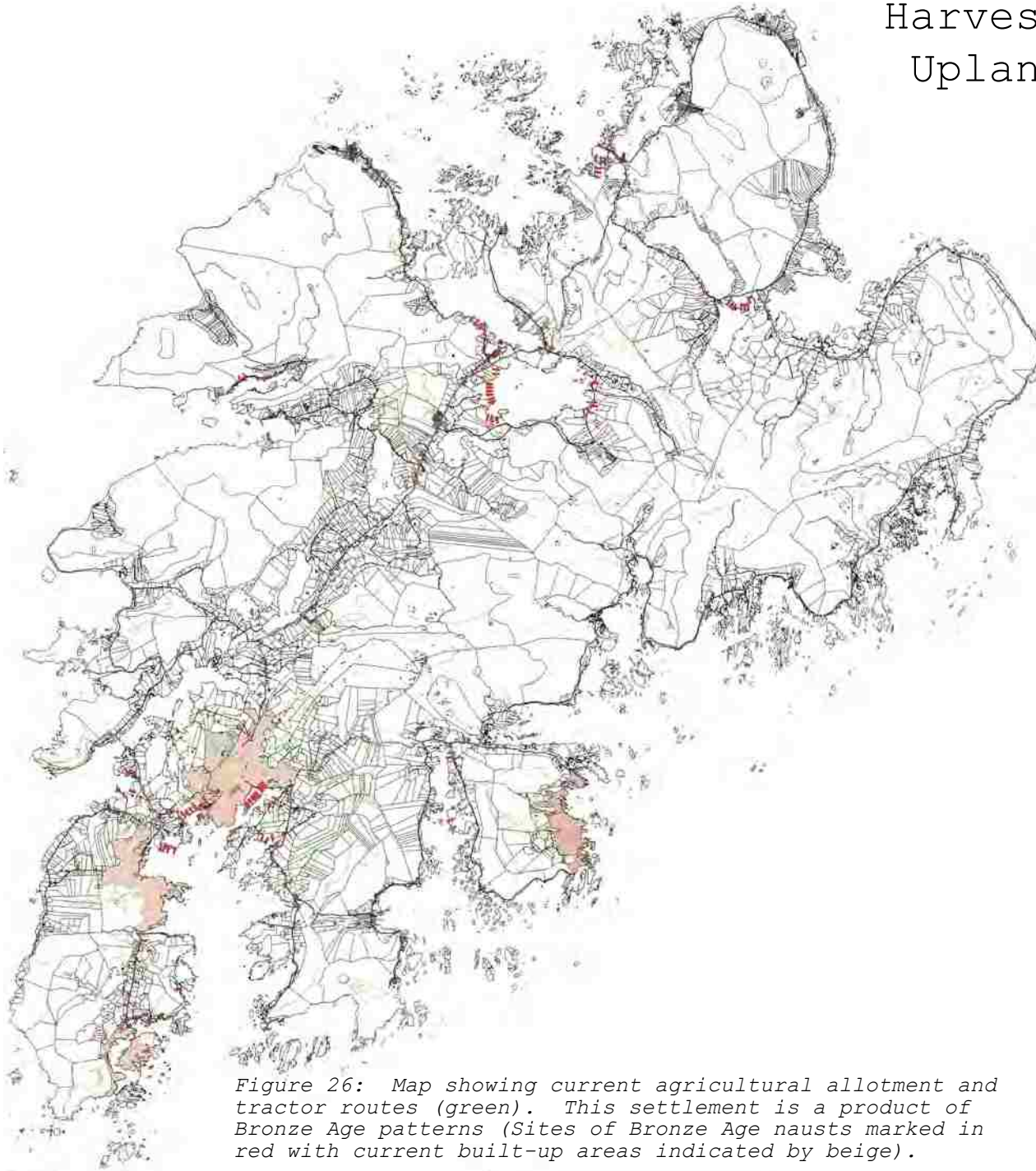

Figure 26: Map showing current agricultural allotment and tractor routes (green). This settlement is a product of Bronze Age patterns (Sites of Bronze Age nausts marked in red with current built-up areas indicated by beige).

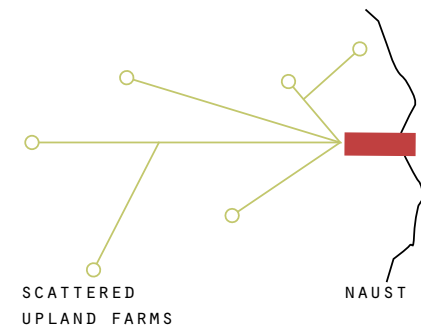
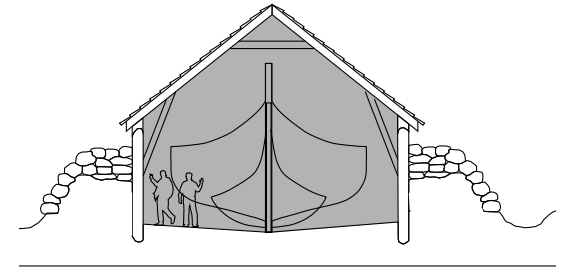

Figure 27M: Diagrams illustrating farm-coast relationship in summer and harvest season. Historically, nausts during this time period housed ships and were sites of repair and preparation for the winter season.

Winter Season: Activated Coastline and Extra-Island Pattern

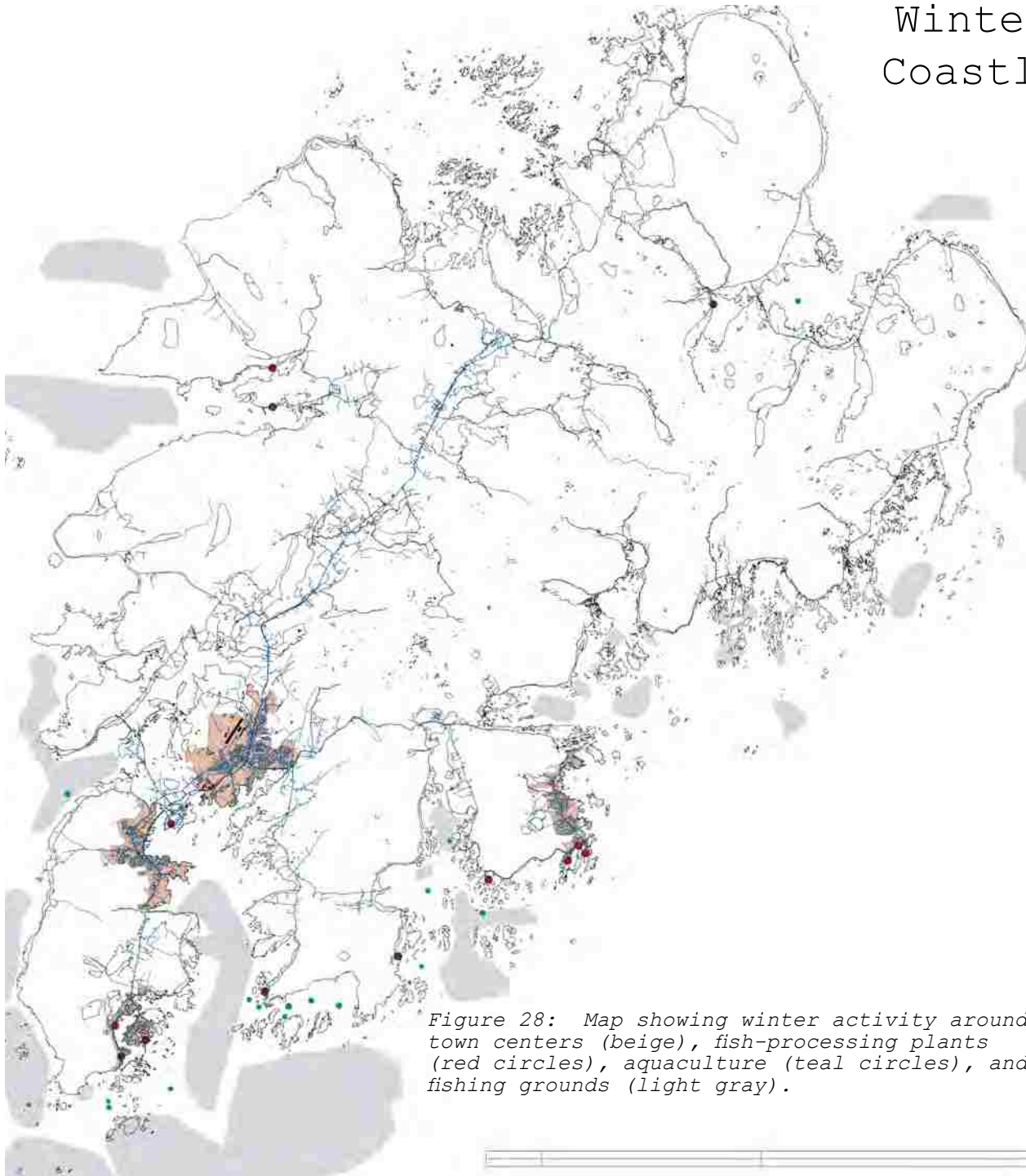

Figure 28: Map showing winter activity around town centers (beige), fish-processing plants (red circles), aquaculture (teal circles), and fishing grounds (light gray).

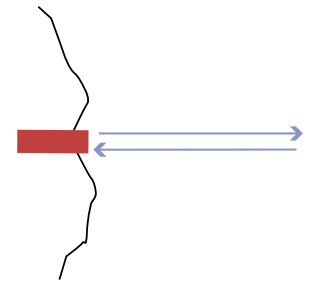
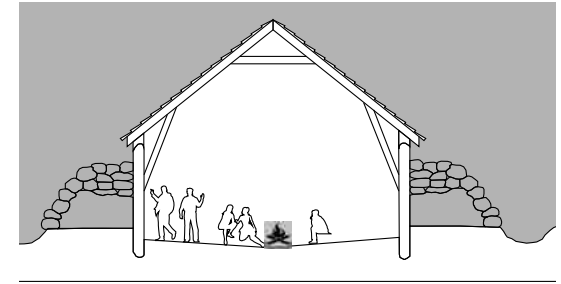

Figure 29.: Diagrams illustrating coastal focus in winter seasons. Historically, nausts during this time period were empty as boats were out on fishing grounds. The open volumes soon became places of social gathering with architectural potential.

III. PROCESS OF STUDY

i. Tun and Ryding

Out of these general patterns of settlement and seasonal flux, this thesis now seeks a vocabulary of design rooted in this place's built response to the vast and changing landscape.

In *Figure 29*, a survey from Gunner Bugge and Christian Norberg-Schulz's, *Stav of Loft*, shows a typical arrangement of farm houses surrounding an informal courtyard, or *tun*. This Norwegian word shares the same root word for the English word for town. In the isolated and scattered North, the public space of the *tun* is greatly reduced as compared to the complexities and breadth of settlement connoted by the word *town*. Nevertheless, despite its lack of sophistication, the figure-ground of the *tun* is all the more critical as a public space because it is a fundamental aperture with which to view the greater and unsettled world. This space acts as an intermediary volume that lessens the severity of the shift in scale between the built environment and the insurmountable landscape.

Even more elementary than structures themselves, the Norwegian word for space is rooted in the word for clearing, *ryding*, rather than being based on the Cartesian whole.

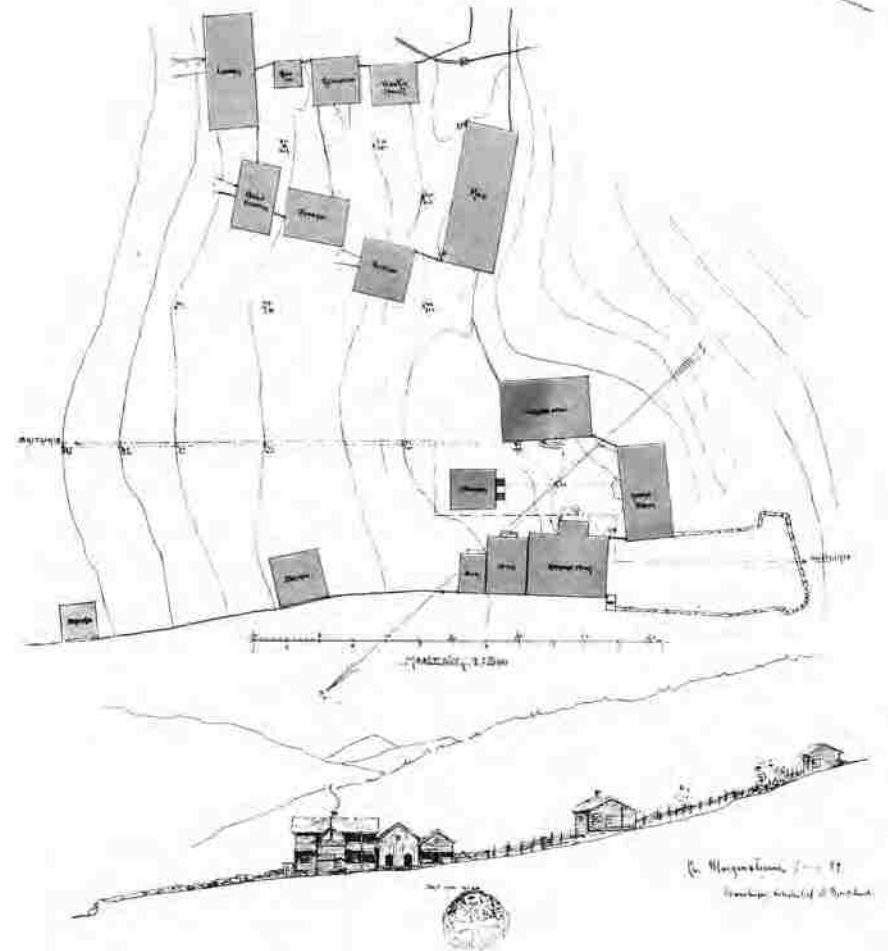

Figure 30: Survey of Farm Settlement reprinted in "Stav og Loft". The *tun*, or interstitial volume between structures, is shown in plan drawing's figure ground nature.



As Christian Norberg-Schulz notes in his book, *Nightlands*, prior to the spread of present norms, in the North, space was “not continuous and comprehensive, but rather an aperture that is carved out of the wild.”¹ In the graphic seen in *Figure 30*, in Ballstad, even present buildings reveal an organization reflecting the spatial concept of *ryding* and *tun*.

¹ Christian Norberg-Schulz. *Nightlands* (Boston: MIT Press, 1997) 5-6.

Figure 31: Ballstad Spaces

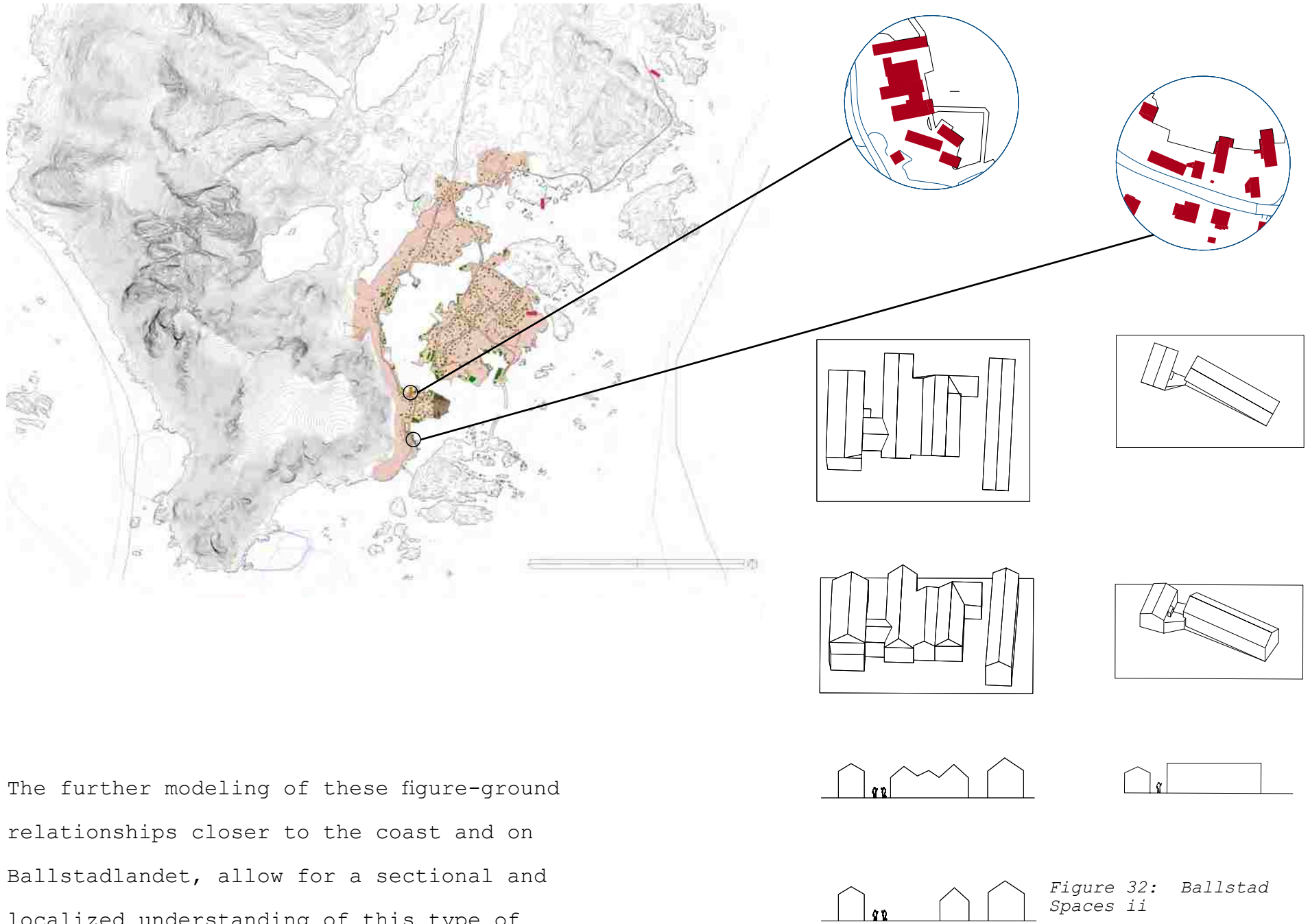

The further modeling of these figure-ground relationships closer to the coast and on Ballstadlandet, allow for a sectional and localized understanding of this type of interstitial space.

Figure 32: Ballstad Spaces ii

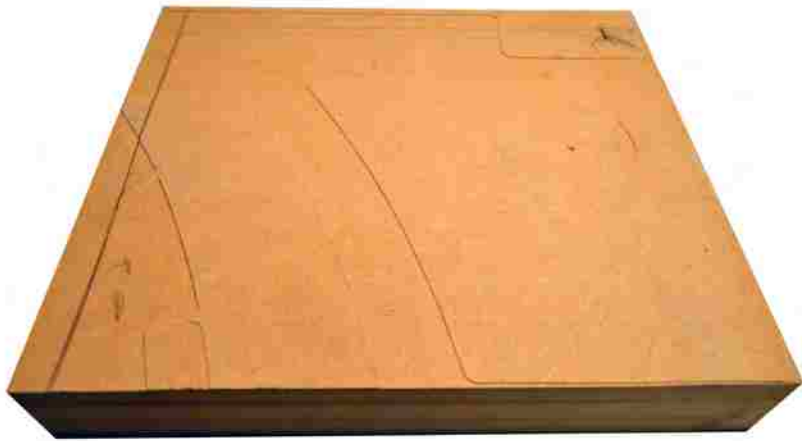

The process of study for this thesis then quite literally engaged in the process of *ryding*, by so too carving out extant figure-ground models using the subtractive process of CNC-routing. In *Figures 30* and *31*, the spatial qualities of these studies begin to suggest a rhythm of solid

and void, along with a complex interior-exterior relationship that is characteristic of Northern building.

Figure 33: Tun model Studies

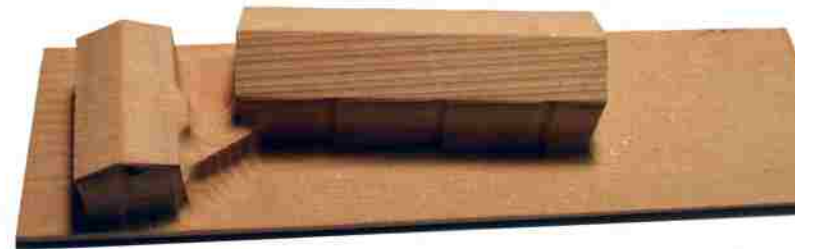
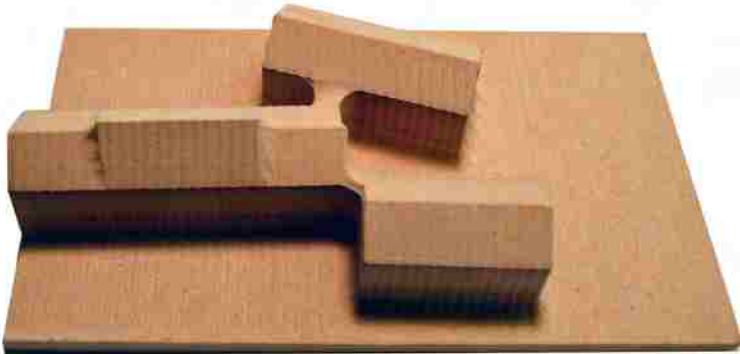

Figure 34: Tun model Studies ii

ii. The Tectonic Language of The Naust

In conceptualizing a dwelling for 20 people on the site at Ballstadlandet that connects the pre-modern to the post-post-modern condition, the design stage of this thesis utilizes a language of structural skin to contain a volumetric rhythm derived from the study of the *tun*. Due to the site's coastal location and the legacy of the *naust* as a place of communal agency, it is fitting that the wrapping structural nature of the boathouse become the architectural language with which to realize the scheme.

The evolution of the *naust* from a post and lintel one-way structural system to a hybrid system comprised of both a frame and two-way structural skin can be seen in the detail drawing of *Figure 32*. This development can be attributed the construction of the *naust* beginning to adopt the techniques used in the fabrication of the very vessels it was hosting. In order to

span the greater volumes needed to house the increasingly large ships, the exterior of these buildings became not just weather proofing, but a shell-like structural system that worked in concert with vertical staves (*Figure 33*).

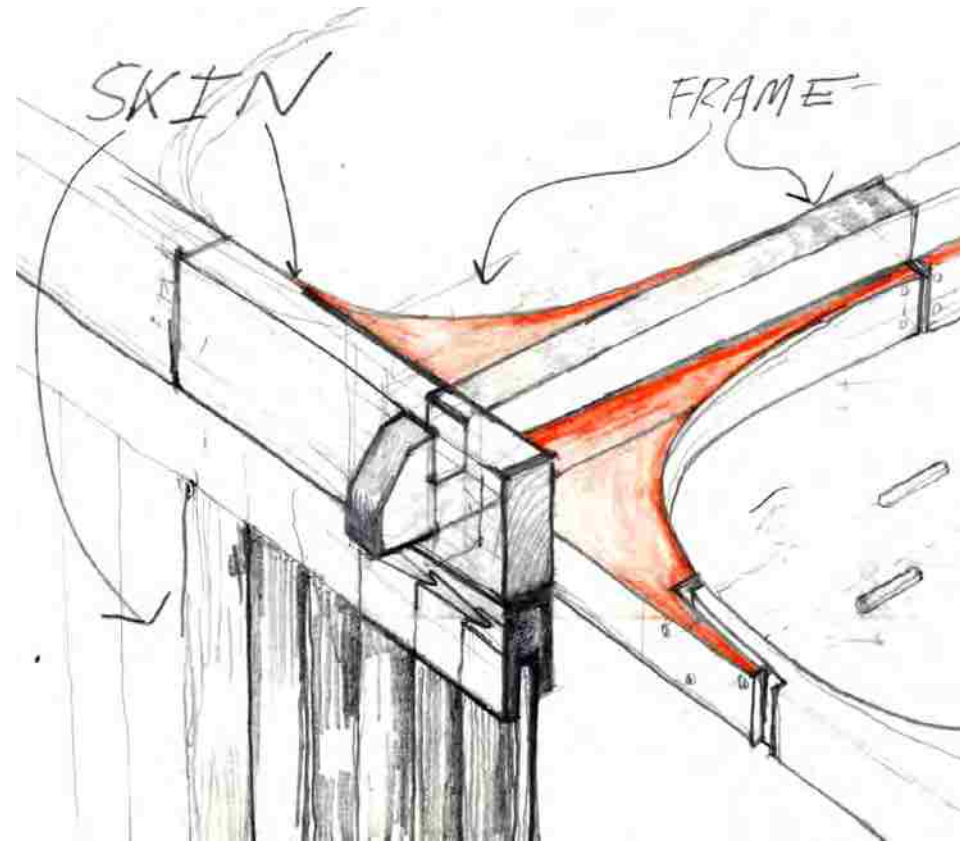
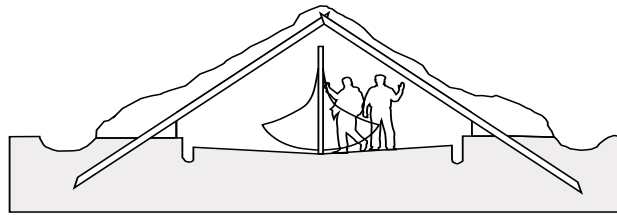
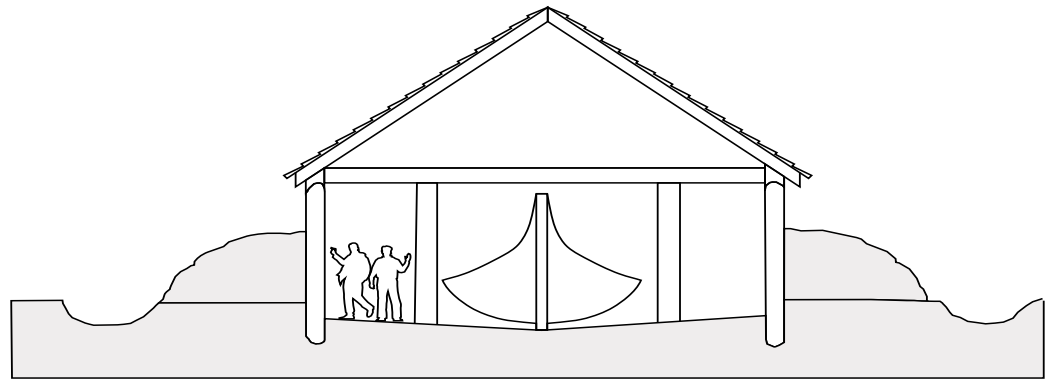

Figure 35 : Frame and two-way structural skin hybrid detail



I.



II.

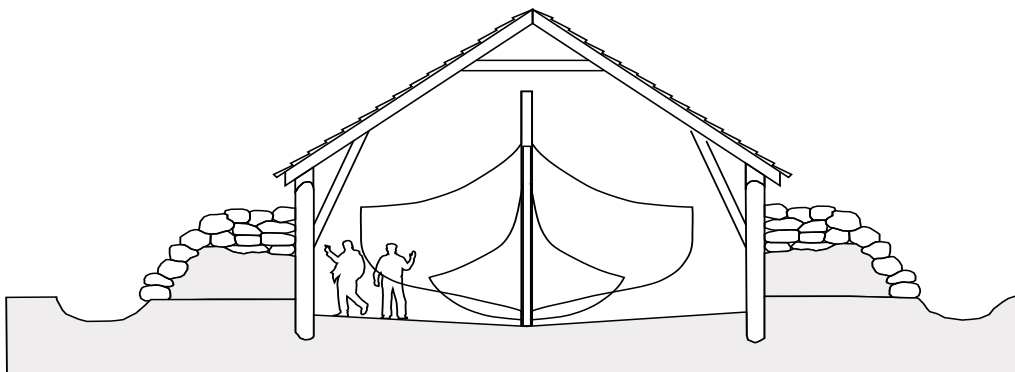

III.

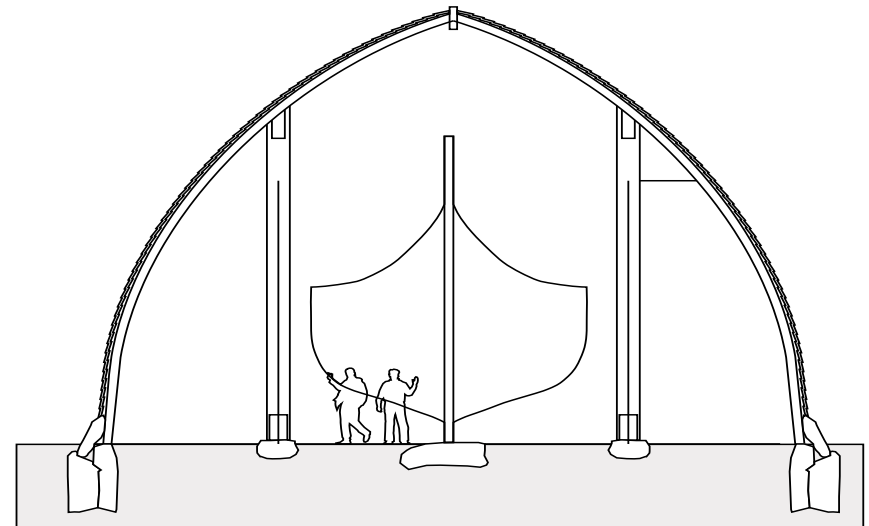

IV.

Figure 36: The sectional and structural evolution of the naust

The ultimate realization of the progression shown in *Figure 36* is an architecture where all of the structure is pushed outward to a containing skin. In that spirit, the next stage of this thesis was the process of wrapping with a structural skin. Figures 0 0 and 0 show a model-making process of wrapping and cutting away of the skin to create openings in the volume. Conceptually, thick paper stands in for cross-laminated timber components which act together in pre-stressed tension with a concrete foundation.

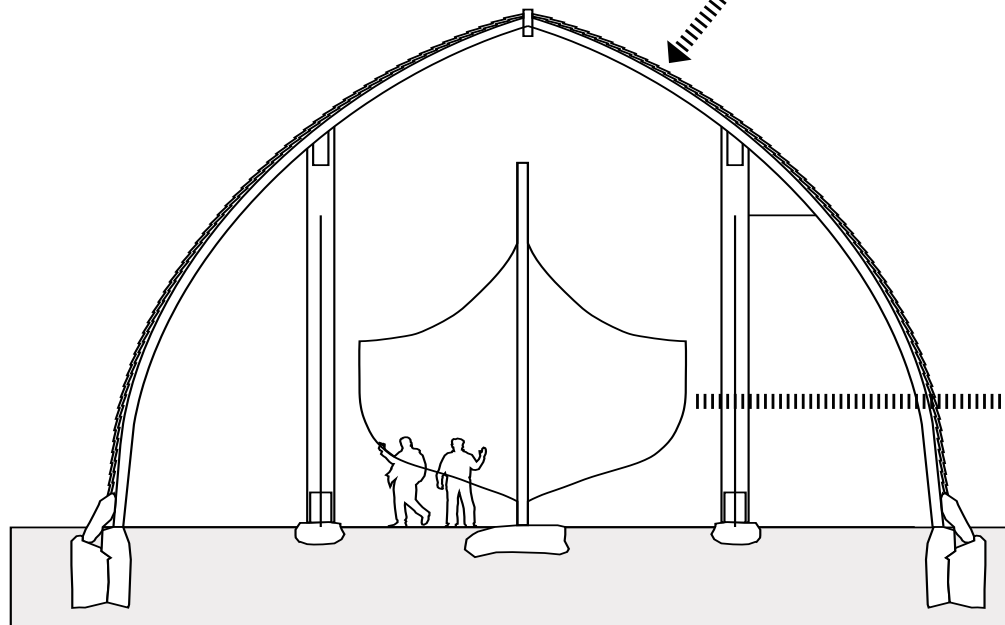

Navne

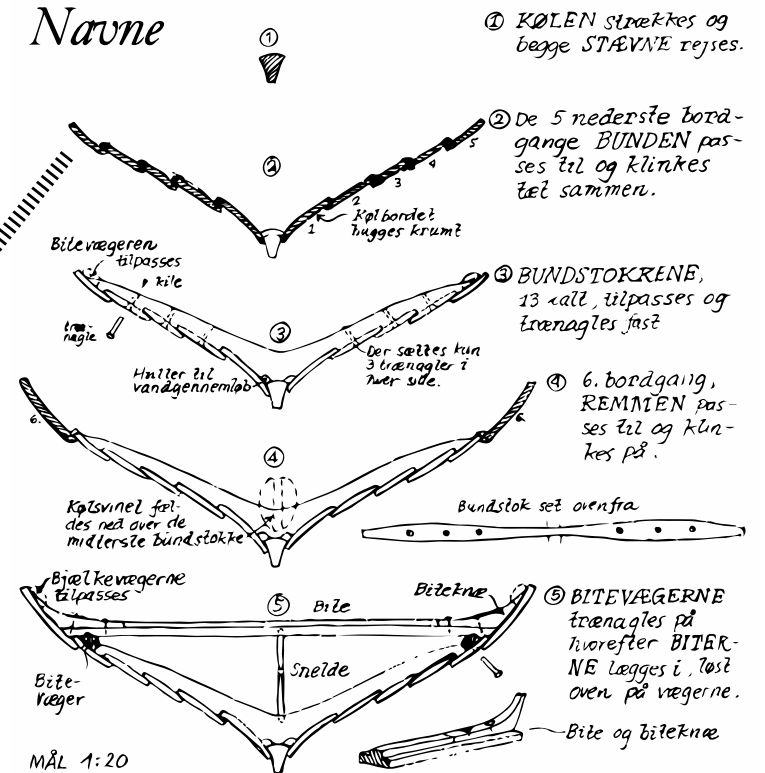

De vigtigste navne på vikingeskibskroget, her vist på Skuldelev 2 skibet.

Figure 37: Adopting ship-building techniques, the evolved naust pushes structure to the exterior and opens large yet unseen interior volumes that enjoy a second life as social spaces.

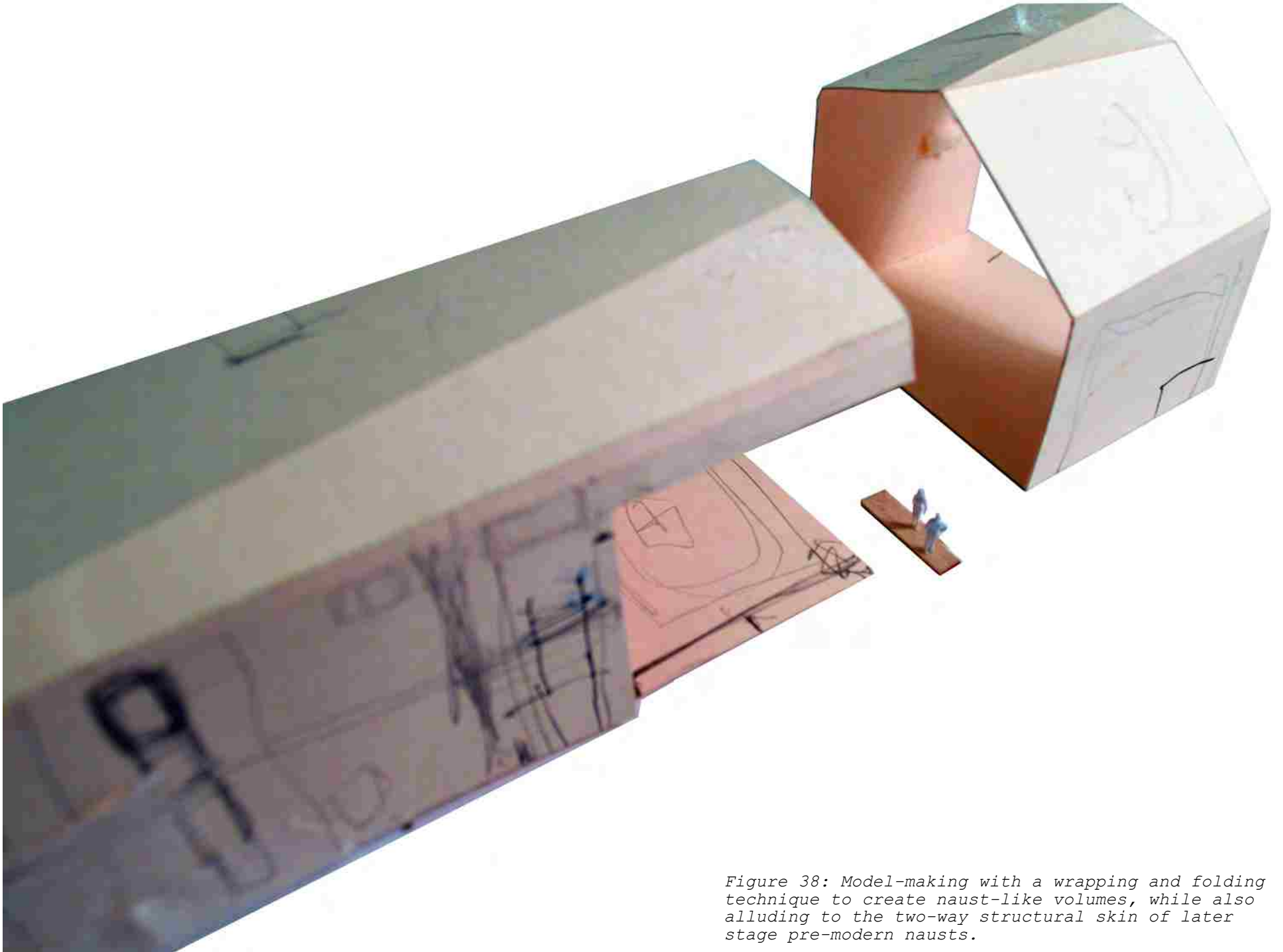

Figure 38: Model-making with a wrapping and folding technique to create naust-like volumes, while also alluding to the two-way structural skin of later stage pre-modern nausts.

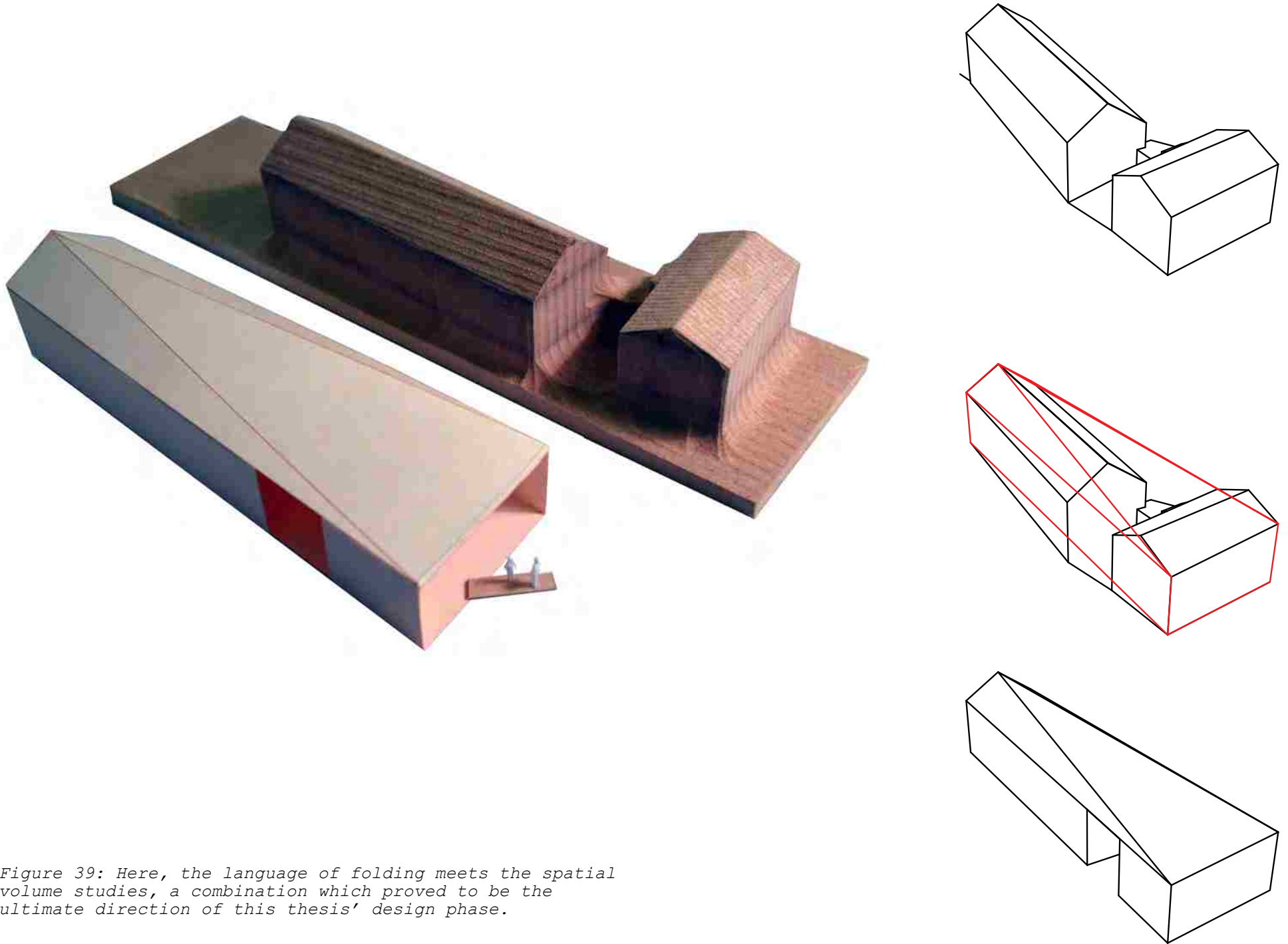

Figure 39: Here, the language of folding meets the spatial volume studies, a combination which proved to be the ultimate direction of this thesis' design phase.

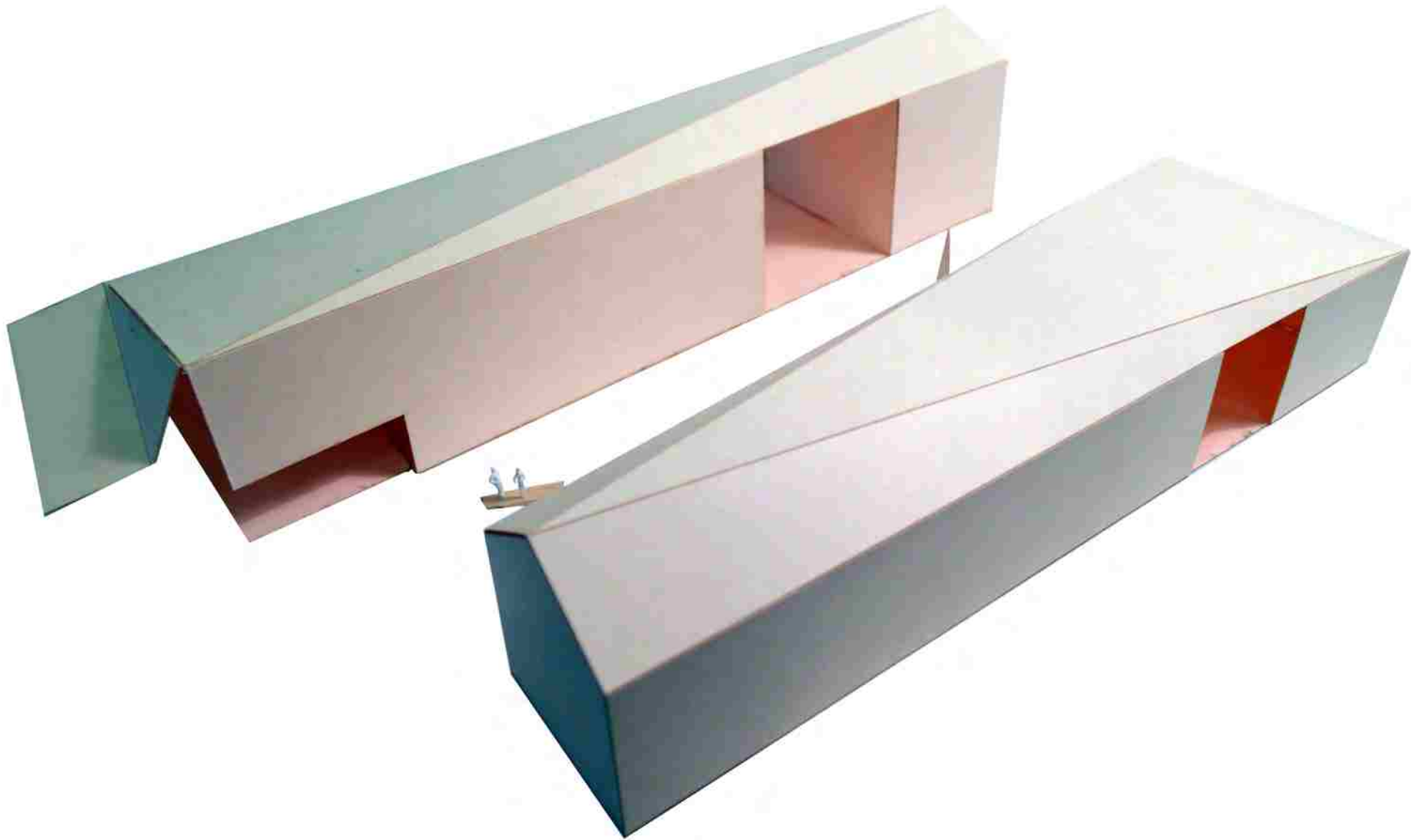

Figure 40 : Scaled-up folding studies.

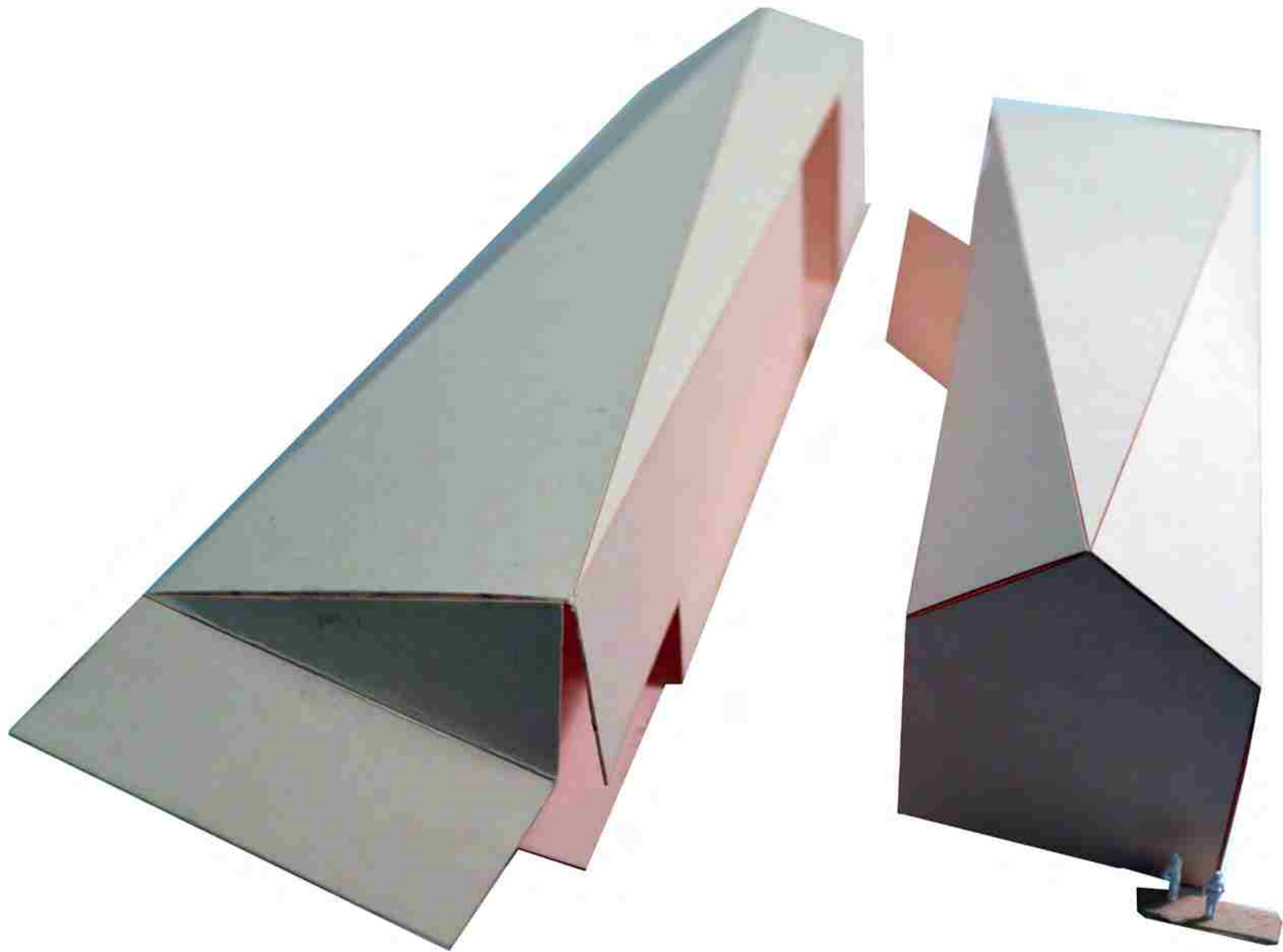

Figure : Scaled-up folding studies contintued.

IV. DESIGN

i. Fusion of Studies In-Site

The design for the housing program at Ballstadlandet originates from the combination of the previous two studies. It is primarily a fusion of the spatial qualities of the *tun* and the tectonic language of the *naust*. That being said, the architecture only begins as these initial impulses are shaped by the immediate site conditions.

In *Figure 42*, the folding language of the *naust* is extruded lengthwise along the northern edge of the site. This initial move follows in the finger-like projection of maritime buildings to the sea on Ballstadlandet, while also maximizing exposure to the southern sun.

In keeping a long and narrow footprint, the form echoes the volume of the pre-modern *naust* and allows for the working nature of the site to be preserved. In effect, a threshold is created between the building's footprint and the adjacent

building to the southeast. In the next series of operations shown at stage ii., the southern side of the massing is lowered, hunkering the sectional nature of the building down against the sea. By variably changing the slope of the roof at this stage, the form is lent a traditional peak at the western façade that then transitions into a lower eastern face. From west to east, the overall massing rises up to meet the scale of the mountain beyond the landing and then, through the energy of line, the building slopes down to meet the sea at its eastern extreme.

By cutting away at the skin at stage iii. of *Figure 42*, the shell becomes opened to the north and south. From this operation of cutting came a programmatic queue to separate the steward's living space from that of the workers with a large social volume as shown in stage iv. Here, the cut-away pieces function like sliding doors that can condition this mixing-volume. In effect when the doors are open, the interior volume becomes part of the exterior, and when the doors are closed, a large hall is created, secure from

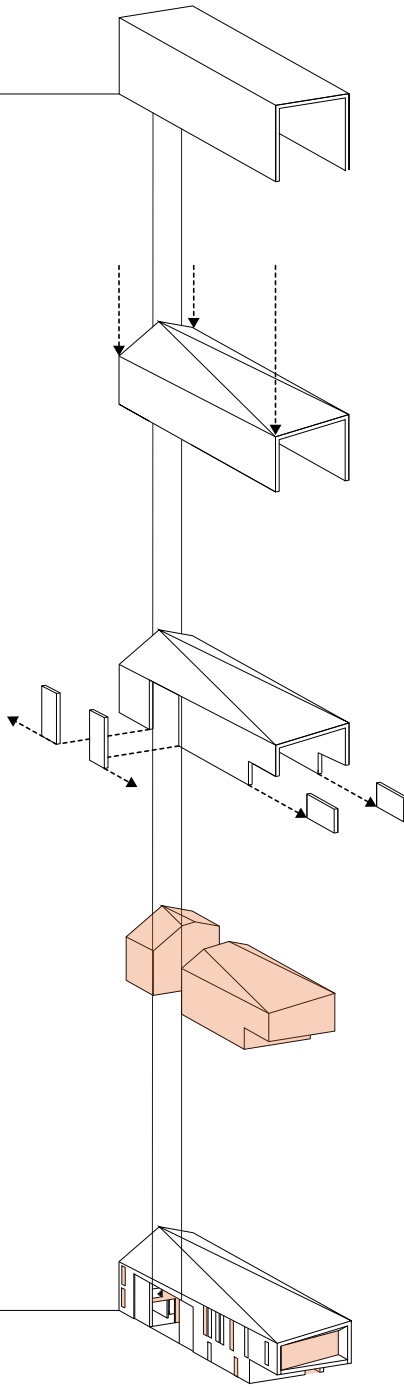
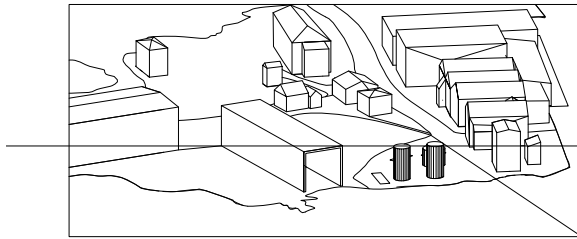

i.

ii.

iii.

iv.

v.

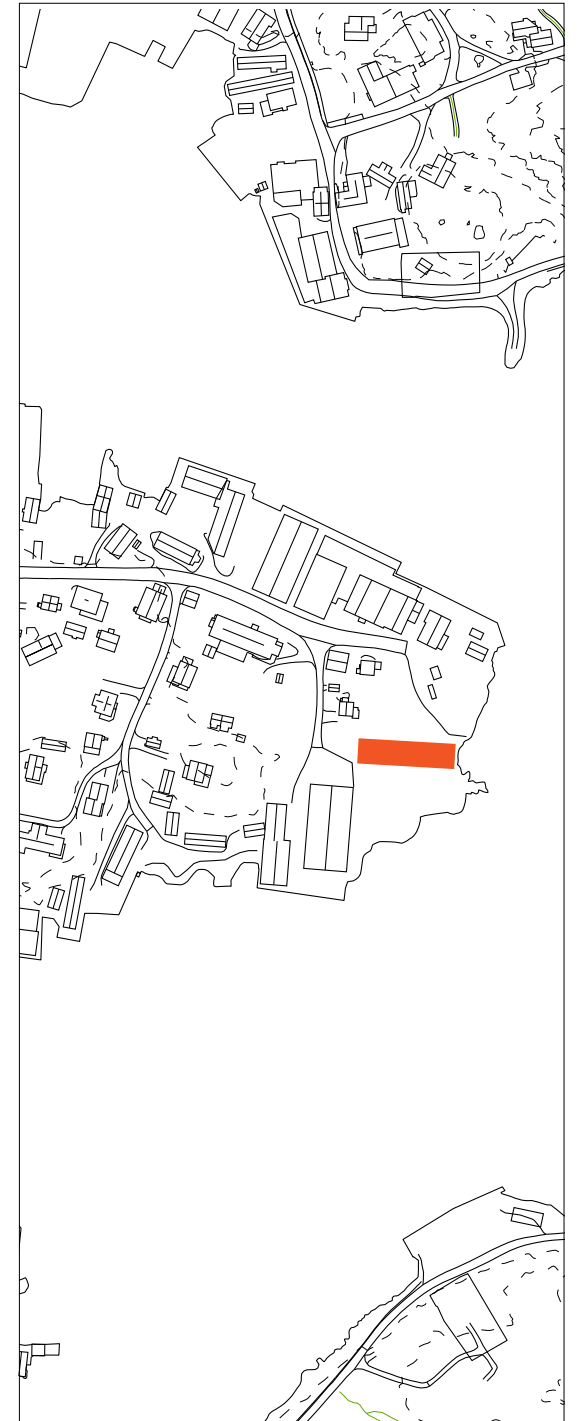
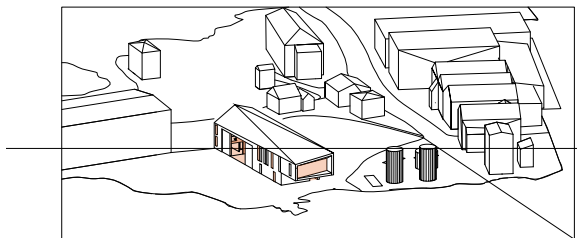

Figure 42: Massing tailored to site



the outside world.

The cutting away from the massing towards the coast also allows for an opening to the north, at stage v. of *Figure 42*. The cantilevered overhang creates a semi-conditioned work space below, further blurring the division between exterior and interior. In tension with the solid nature of the form's western face, the suspended condition at the harbor's edge alludes to the precarious balance of the original coastal building. In a subversive manner that is also the full realization of the typically stilted coastal-structure, mass floats above void.

At a site level, the energies of the island that characterize activity during the winter season are illustrated in *Figure 44*. The scheme reacts to this west to east alignment in its axial layout and further emphasizes the orientation by the closing of the large conditioning doors. The seasonal use of the *hjeller* on-site clouds north and south views, furthering the site's east to west focus.

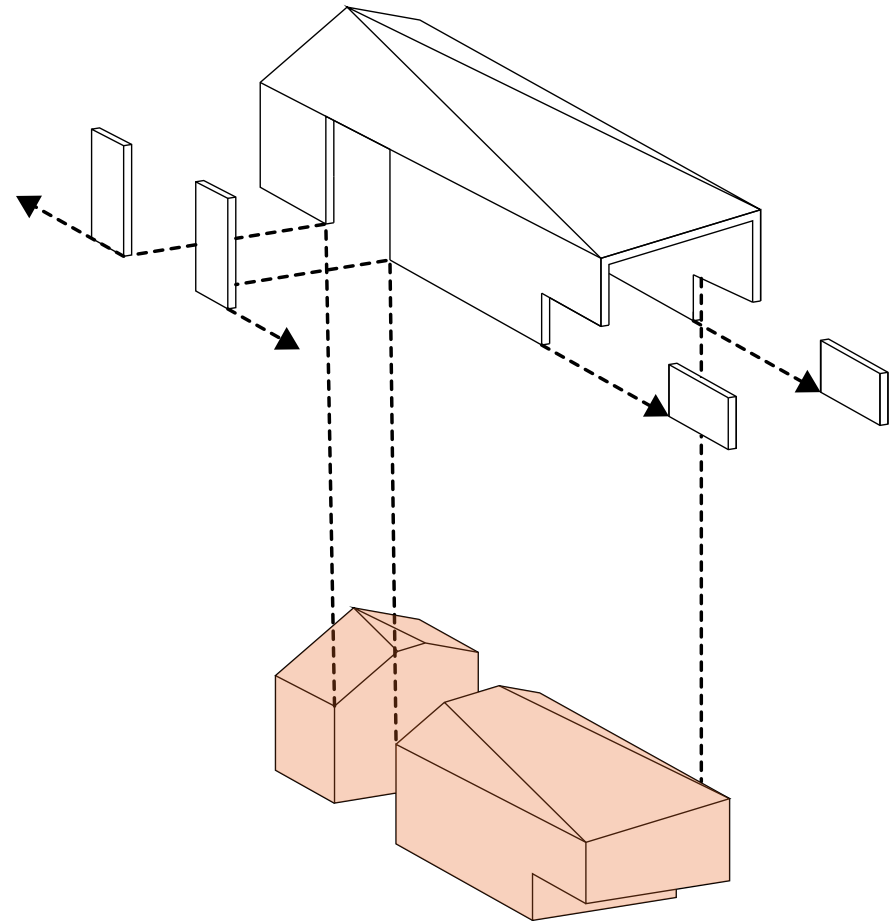

Figure 43: Program division within structural shell. The steward's living space is the more cubic volume on the left, after the gap the worker's space continues to the cantilevered end.



Figure 44: East-west winter orientation at site and island scale. Diagrammatic representation of scheme with large conditioning doors closed.

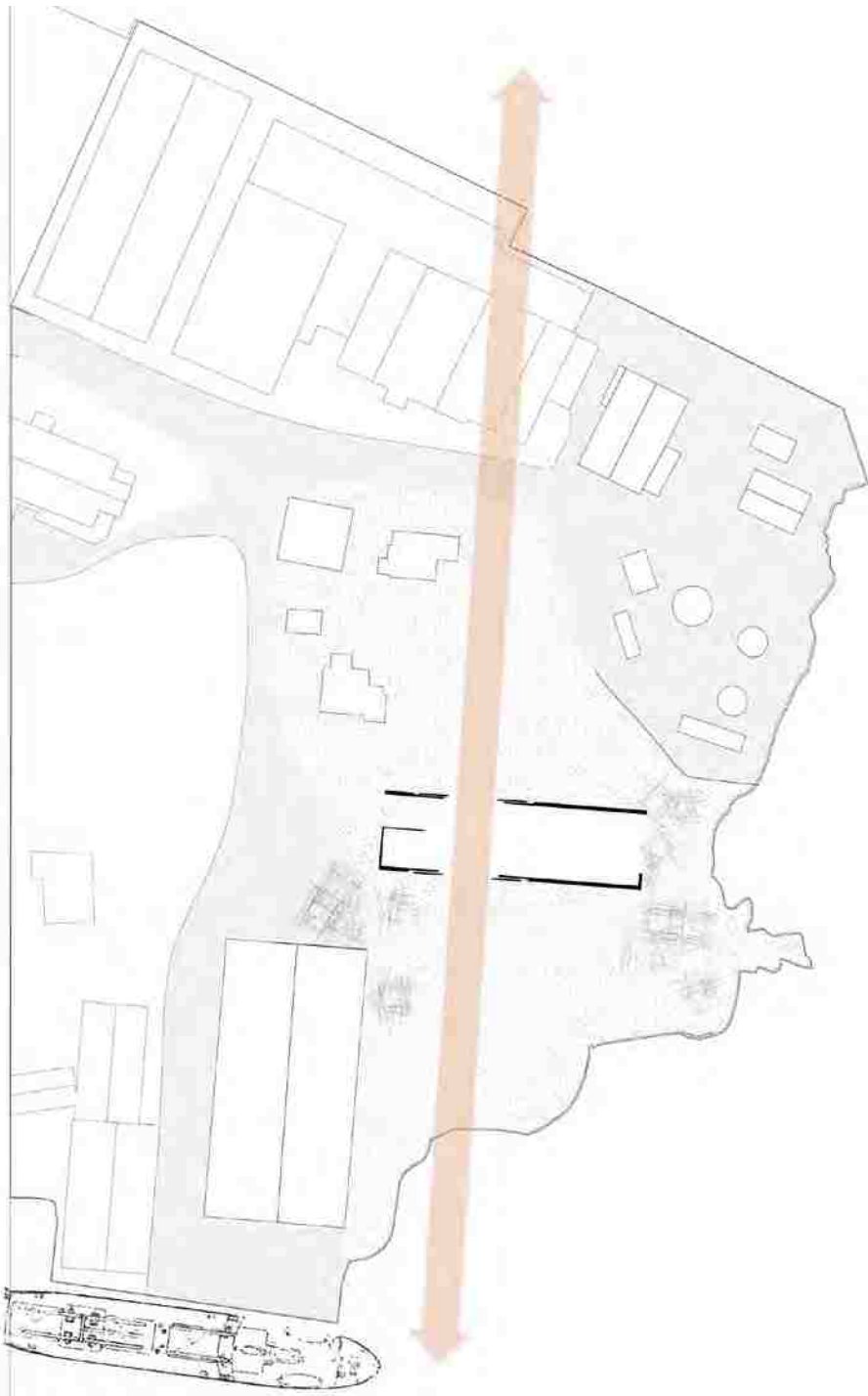

Figure 45: North-south harvest season orientation at site and island scale. Diagrammatic representation of scheme with large conditioning doors open.

When the doors are opened, they draw the exterior into building, and conversely when closed, create a large hall, secure from the outside world.

The cutting away from the massing towards the coast also allows for an opening to the north, at stage v. of *Figure 42*. The cantilevered overhang creates a semi-conditioned work space below, further blurring the division between exterior and interior. In tension with the solid nature of the form's western face, the suspended condition at the harbor's edge alludes to the precarious balance of coastal buildings. In a subversive manner that is also the full realization of the typically stilted coastal-structure, mass floats above void.

At a site level, the energies of the island that characterize activity during the winter season, are illustrated in *Figure 44*. The scheme reacts to this west to east alignment align in its axial layout and is further emphasized by the closing of the large conditioning doors. The seasonal use of the hjeller, or fish drying racks on-site.

This predominant alignment is interrupted in the summer and harvest season through the opening of the large social volume, or Grand Rom, to pleasant weather and the north-to-south pull of the season (*Figure 45*).

As shown in *Figure 47*, the plan's west-to-east ordering of the steward's volume, the Grand Rom, the loft units and then the concluding Small Rom, follow a spatial rhythm of compression, release, compression, release. The entrance under the steward's quarter, which then opens to the large volume of the Grand Rom, invites the user to take pause and recalibrate his surroundings. Notably, the Grand Rom is accented by a hearth and overlook that in concert act to penetrate an otherwise uninterrupted volume (*Figure 47*). The prospect and exposure of the overlook is countered by a small nook under the stairs which provides a moment of partial retreat from both the scale of the Grand Rom and the evermore lofty mountains beyond.

Throughout the building, the control of

operable shutters bring the agency of the large doors to the scale of the individual lodger. The manipulation of the shutters allow for the opening or tightening of the building as an aperture to the outside world.

Light from these tall and narrow windows, appearing as almost slits cut into the CLT shell, wash the walls of the lodging units providing reflected and diffuse light when the sun is at a low angle. When the shutters on the south side of the building are closed and the north set of windows from the loft are opened, soft north light is allowed to play across the faceted CLT ceiling. Here, time and season can be read across the interior of the building's shell as an exchange between shadow and light.

This effect is further achieved in the clear hierarchy of the CLT shell structure over the building's interior walls. The secondary walls in their playful orange treatment are like curtains, as compared to the solid and untreated carpentry of the CLT shell. To emphasize this and to allow light to wash interior walls, the

course of the interior walls have been offset against the superstructure's window openings, creating a crisp edge which simply stands under the all encompassing shell of the building.

As a whole the design is a balance of a reaction to the immediate conditions of the site and a product of this place's past. Foremost it is a flexible architecture that through the use of tailored volumes, prospect, and refuge, aims to be a vehicle with which to synchronize the frenzied immediate with the Island immemorial. In this sense this design is both in and out of time. Though its structural nature and stance are an allusion to the past, the nuance of its design and present nature could only be both realized and tempered by the accumulation of new narratives and the wear of future flows.

ii. Architectural Design

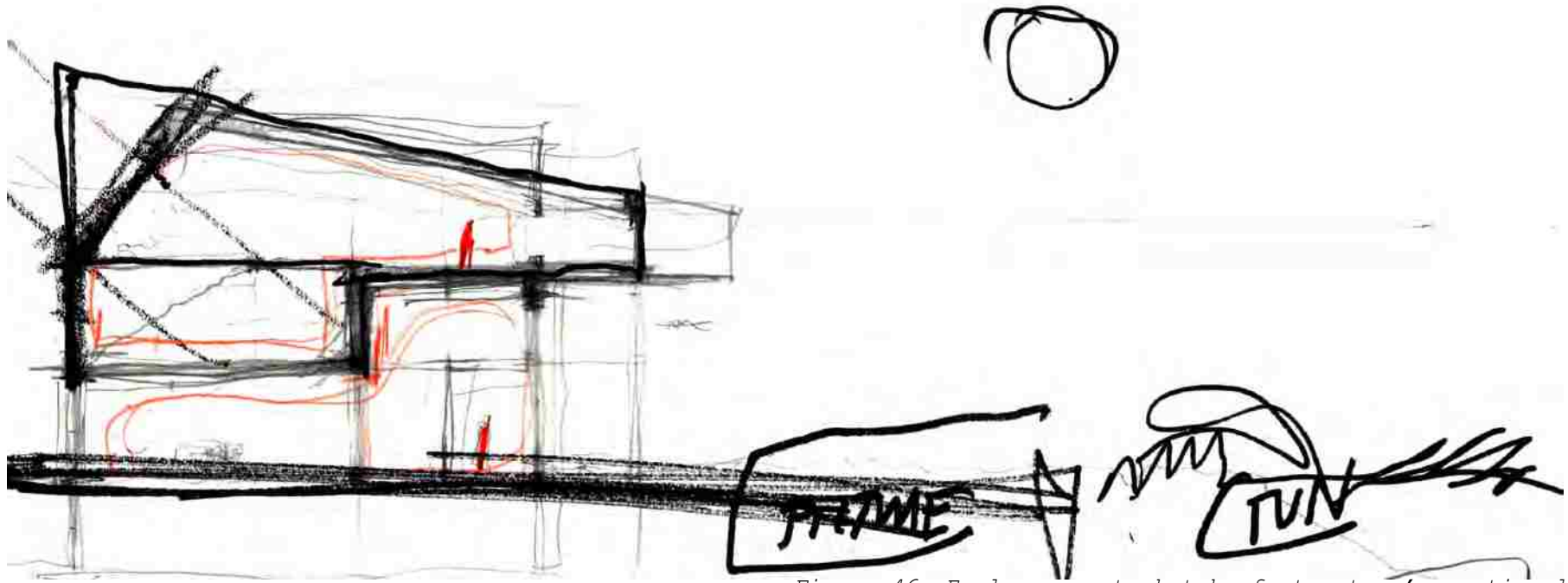

Figure 46: Early concept sketch of structure's sectional nature

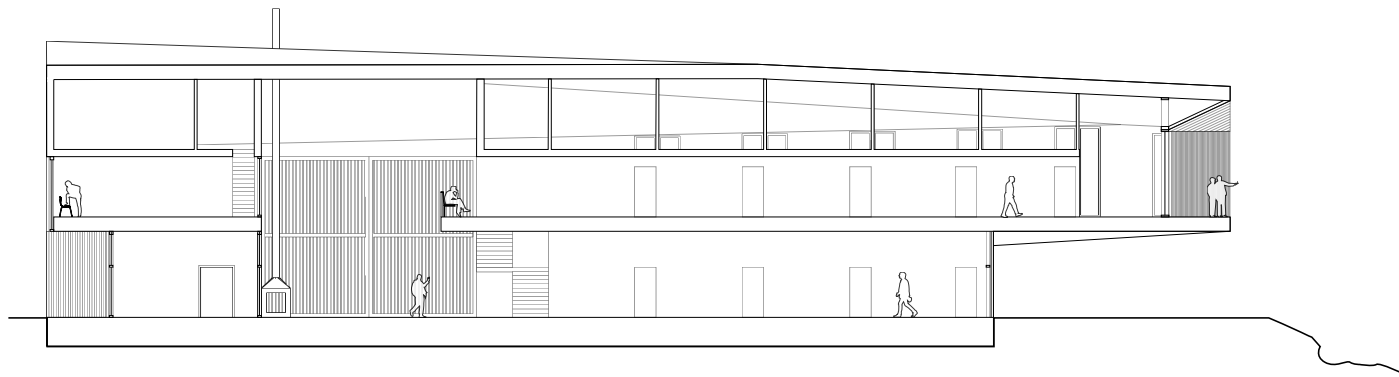
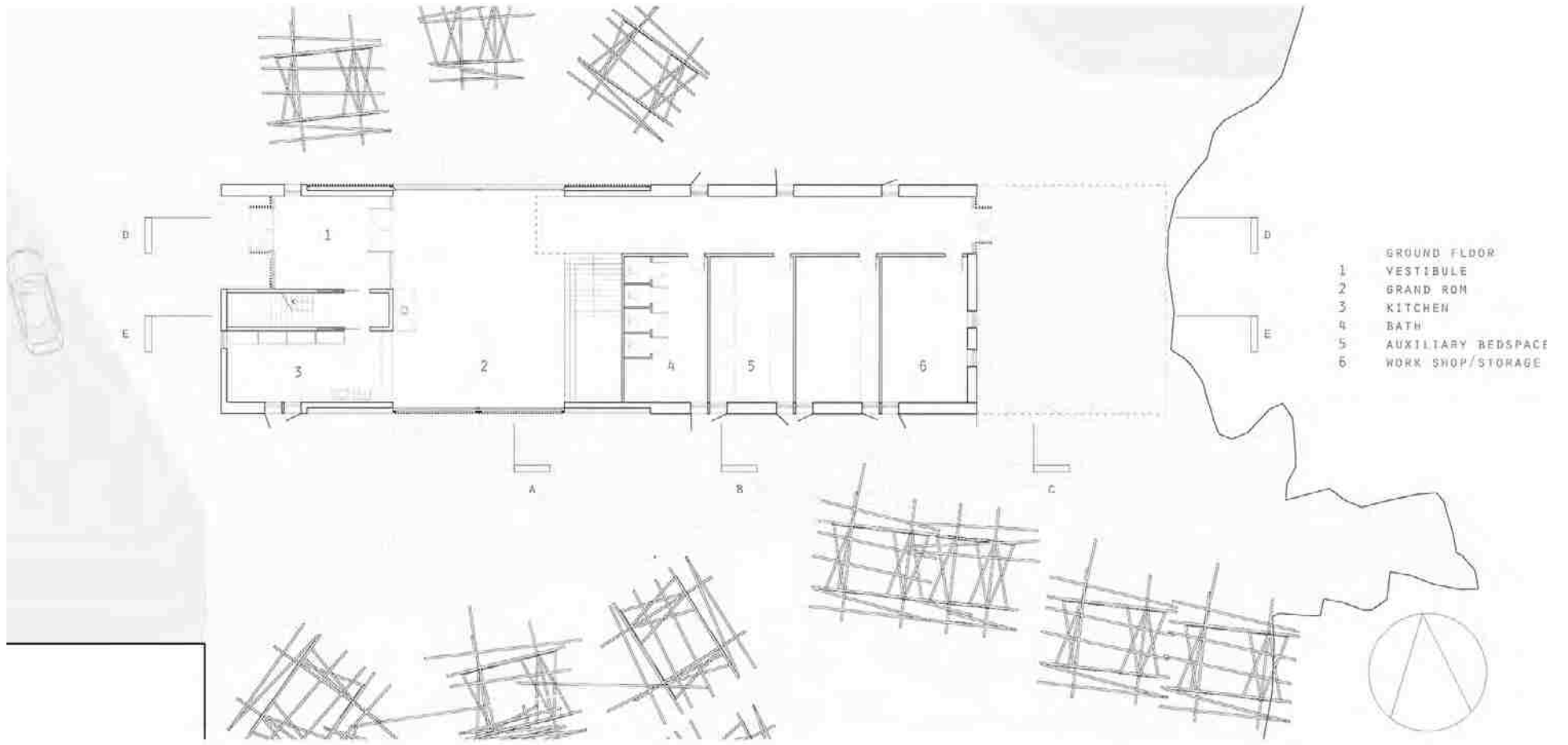

Figure 47: Ground floor in site with accompanying Section D

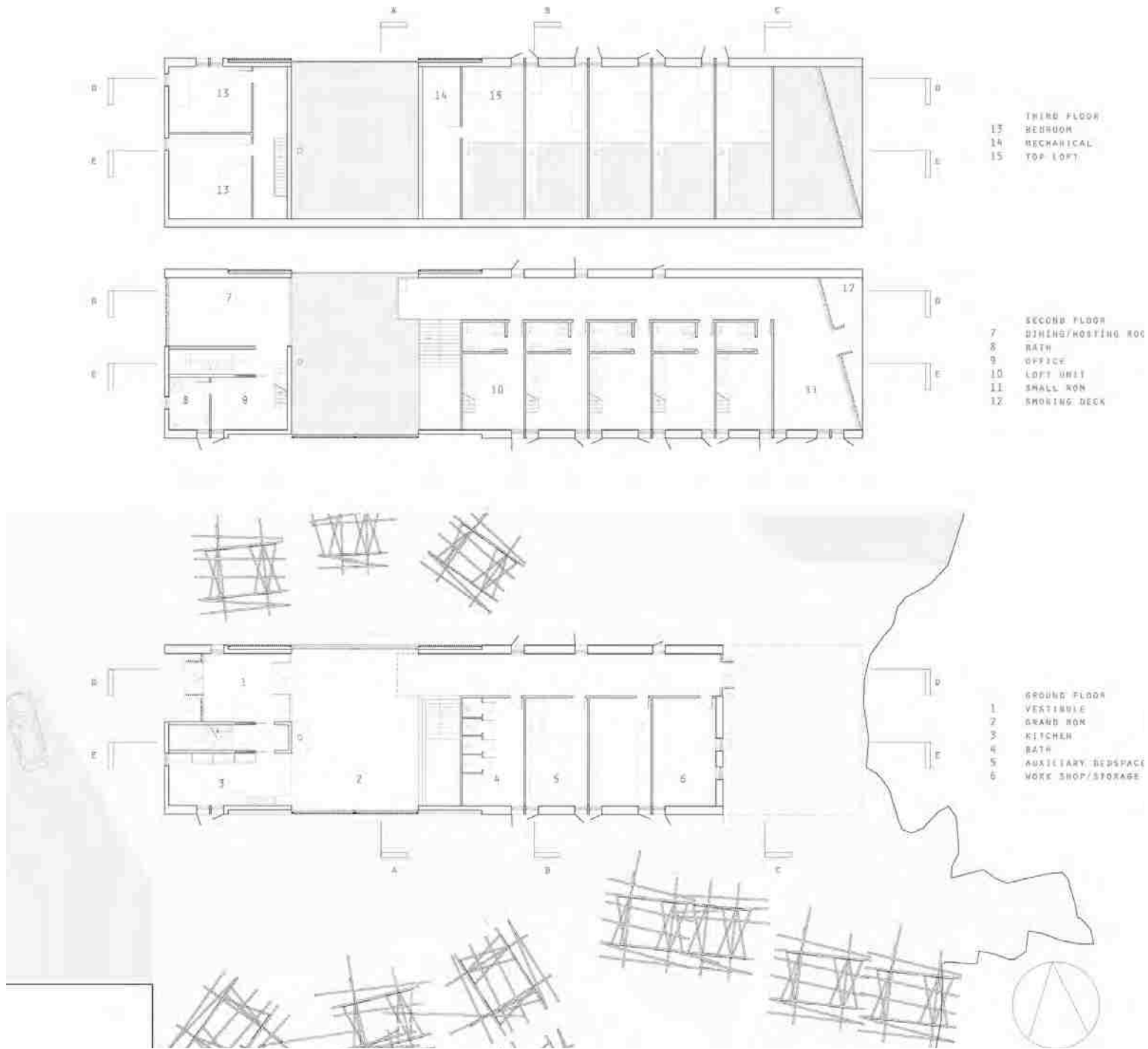

Figure 48: Complete floor plans

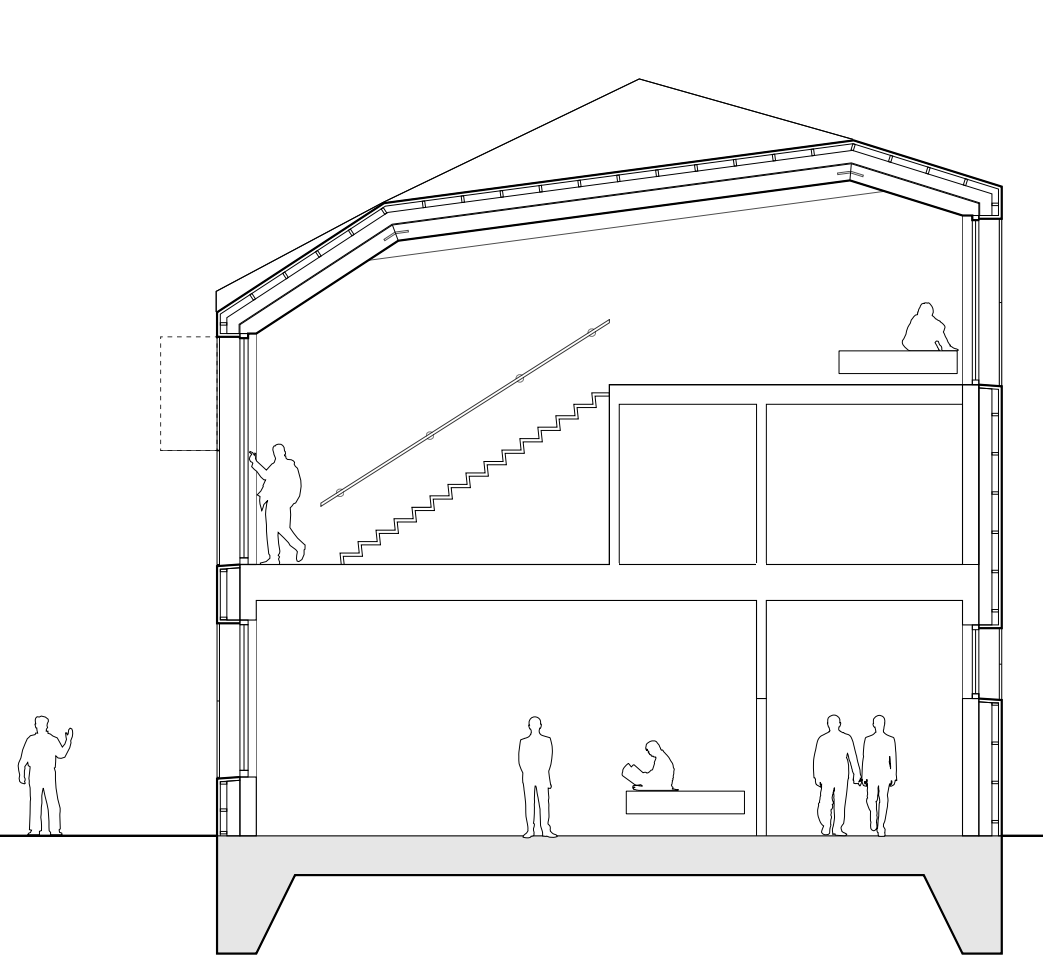

Figure 49: Section B

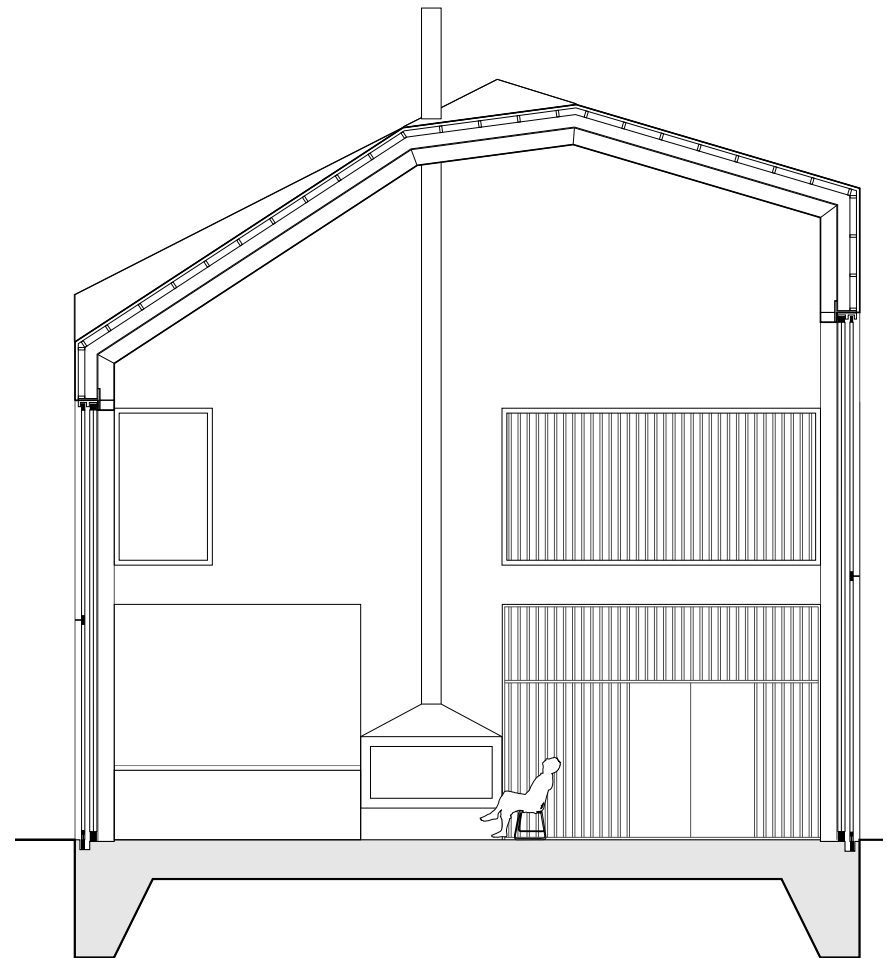

Figure 50: Section A

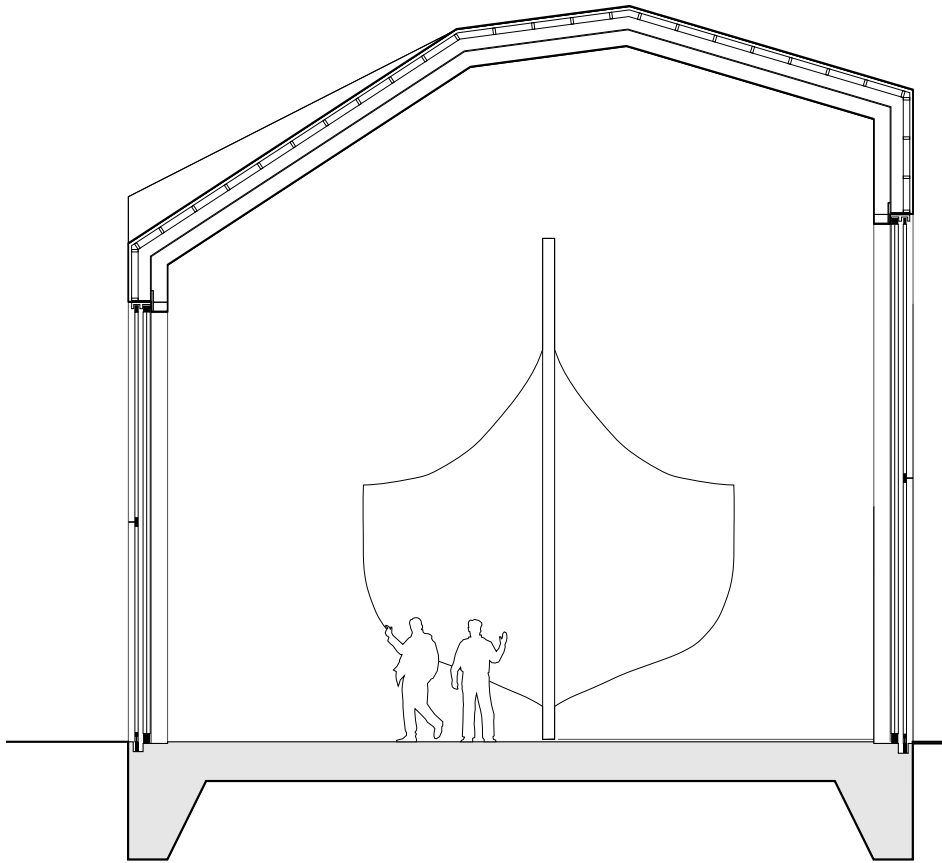

Figure 51: Section A with ghosted volume of Bronze Age ship for size comparison to pre-modern nausts

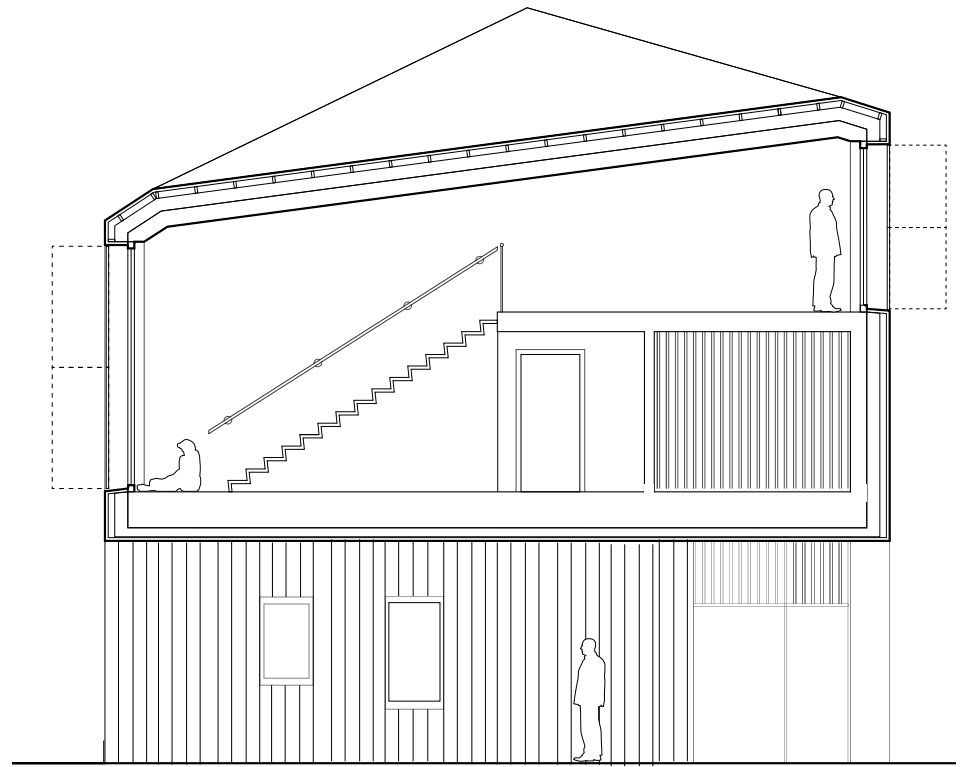

Figure 52: Section C, cantilevered condition showing dwelling unit and passage.



Figure 53: View north from southern extreme of site



Figure 54: View southeast from Ballstadlandet road



Figure 55: Wide angle view north



Figure 56: Wide angle view southeast from Ballstadlandet road



Figure 57: View through Grand Rom with Conditioning doors open, looking south



Figure 58: View through first floor of loft unit, looking south



Figure 59: View from second floor of loft unit



Figure 60 View from first floor of loft unit looking up



Figure 61: View from eastern-most Small Rom, looking southeast



Figure62: Exterior view of overhang, looking northwest

i. Portrait of a Marginal Landscape: The Policy, Economy and Identity of The Norwegian Countryside

Broadly speaking and in comparison to North American norms, Norwegian consensus regarding population density and agricultural production offer an alternative to the neo-liberal order.

A complex and somewhat contradictory model has emerged which embraces structural change in agriculture internally, yet resists the forces of urbanization and competitive advantage internationally.

Though State policy has ensured the existence of upland towns, the draw of urban areas has created rural-out migration and left large gaps in the traditional labor market. With rural life at the crux of national identity and a matter of national food security, the Norwegian Government sought to ebb the flow of urbanization via the Soria Moria declaration of 2005, fulfilling their promise

to keep the lights on in the homes along the rural coastline.¹ Though not part of the European Union, Norway is a part of the European Economic Area and allows for the free movement of people across its borders.

While still essentially protectionist, the 1994 EEA inclusion was policy decision deemed necessary to grow its service economy through the import of skilled labor and increasingly, sustain its rural areas. Especially with the 2004 inclusion of the former soviet-bloc into the E.U. and the common labor market, Norway has become a haven of wealth admits the growing pains of the Euro. The financial incentive to work seasonally in Norway can be pegged to an average manufacturing labor cost, which according to Saleha Mohsin of Bloomberg Business was "about \$64.15 an hour, the highest among 33 countries examined by the U.S. Labor Department.

That's 35 percent more than in Germany and 80

1. Rachel Gjelsvik Tiller et al. "Work segmentation in the Norwegian salmon industry" *Marine Policy* 51 (2015) 563-565

percent more than the U.S.”.² Characteristic of the trends in new migration, in 2004 74 percent of all 33,000 work permits were granted to Eastern European nationals. These numbers must be seen in a context where immigration historically was almost exclusively from other Nordic countries and where the total migration from 1966 to 1970 was only 853 people. This new flow of people is also contrary to historic norms across Europe, whereas now a larger number of these migrants are headed to rural areas.

In the matter of a decade, the agricultural sector has evolved from a bastion of an identity based in immediate community, to a brave new world where migrant workers are now responsible for 13 percent of gross output.³ Similar trends may be observed within Norwegian fisheries and aquaculture, also located within these marginal regions.

Aquaculture has begun to supplant the economies

2. Saleha Moshin, “Europe’s Workers Flock to Norway for Better Paying Jobs” September 2013: Bloomberg Business. Accessed: <http://www.bloomberg.com/news/articles/2013-09-02/europe-s-workers-flock-to-norway-for-better-paying-jobs>

3. Johan Fredrik Rye. *The Western European Countryside from An Eastern European Perspective: Case of the Migrant Workers In Norwegian Agriculture.* European Country Side, MENDELU: July 2014 vol. 4. Page 328.

of isolated areas once reliant on dwindling fish stocks. Aquaculture now represents 60 percent of Norway’s 5.4 billion dollar seafood exports. The rise of the industry and the necessary processing plants (twenty of which are on the Island of Vestvågøy) has created many new jobs along the rural areas of the Norwegian coast and the Lofoten Islands. Policy analysts Rachel Gjelsvik Tiller et al describe that much like trends in agriculture:

Filling the new positions in these communities, however, has mainly come in the form of work migration. This is because the aquaculture sector has a high demand for manual labor in its production facilities and these facilities are often located in areas that have experienced decades of depopulation... Within the aquaculture industry, and in local communities dominated by the aquaculture industry, growing numbers of foreign workers are being recruited from Eastern European networks and temp agencies.⁴

Further, the expected growth of the sector is projected to demand 56,000 new jobs by 2025 which will most likely be filled by Eastern European Workers. Tiller et al. continue to note

4. Rachel Gjelsvik Tiller et al. “Work segmentation in the Norwegian salmon industry” *Marine Policy* 51 (2015) 563-572.

the example of the island communities of Frøya and Hitra, which saw a net population loss of 38 percent from 1964 to 1995. At current, the population is rising and is now made up of 20 percent migrant labor due to the expansion of aquaculture.⁵ With such sudden change, these traditional and isolated areas are having integration issues.

The dislocation of migrant farm and fisheries workers has created a degree of labor market segmentation. In this unfamiliar landscape, culture and economy, workers are unable to move upward in their jobs and likewise unable to integrate within the society at large. Many migrants interviewed expressed a desire to return to their home countries, but the lure of wages (at close to eight times the Eastern European rate) keeps them both in these marginal areas and a sort of transnational limbo. With regards to the cyclical and segmented nature of migrant work, Tiller et al. contend that these conditions are strategies that are:

5. Rachel Gjelsvik Tiller et al. "Work segmentation in the Norwegian salmon industry" *Marine Policy* 51 (2015) 563-572.

Beneficial to the salmon industry in Norway, and other industries in need of workers, and in general the municipality where these industries are located. Furthermore, as SalMar (a processing firm) is a so called "flexible firm" with a lot of staff hired on a temporary basis and because of the unpredictability of this type of trade, it would not be beneficial for the company to spend too many resources on courses for their workers.⁶

This new influx of migration is part of a greater and more fluid movement between nations, while also characteristically part of a renewed push into the circumpolar north in search of resources. Economies of resource extraction, settlement and the mitigating effects of climate change are drawing migrants out beyond the social gravity of cities and into marginal landscapes. In the example of Norway, Joanna Andrzejewska and Johan Fredrik Rye of the Centre for Rural Research, Norwegian University of Science and Technology, write in their article *Lost in Transnational Space? Migrant Farm Workers in Rural Districts*, that:

The emergence of transnational migration is associated with the shifting global economic and geopolitical context, and historical, economic and political connections between the sending and receiving countries. New ways of communication have transformed time and space, not only in terms of geography, but also economically,

6. *Ibid*

socially and culturally.⁷

The coastal village, subject to the profound multidimensional economic transformation is also being evolved by the new streams of migration. Not only is this phenomenon new, the migrant experience within these marginal areas are also unique in that they lack the cultural networks of urban diasporas. Furthermore, the alienating cycles of agriculture and fisheries work that involve movement to and from the host nation are starkly contrasted to the social cohesion and stability of Norway's welfare society.

New hybridized space is needed to reflect the cultural, economic and political practices of groups emerging over time and space as a result of massive circular international migration flows. In reference to these flows and experience of people through the marginal north, Professor Johan Rye observes, "migration is no longer a single act of moving from one place to another, but an

7. Joanna Andrejewska and Johan Fredrik Rye (2012): "Lost in Transnational Space? Migrant Farm Workers to Rural Districts. *Mobilities, Center for Rural Research Norway, Department of Sociology and Political Science.* 7:2,247-268.

ongoing process, which has multiple consequences both for migrants themselves and for the nation states of their residence and origin".⁸

Not only does Norway's diffuse policies help to achieve food security, but by insulating production and small land holders from the global market, the Government has been able to preserve the cultural landscape. While a more liberalized market might not make Norway similar to the United States, it would certainly be closer to Sweden, where the depopulated countryside has begun to be reclaimed by the forest. Part of this societal choice is rooted in the principle of *Allemannsrett*, which is an understanding views the land as accessible to all. Even private land, governed by a social contract rooted in small-holding reciprocity, is a public resource for recreation and self-identification. Architecture in these latitudes and changing times must make an effort to extend this concept of *Allemannsrett* to all its inhabitants in the effort to achieve sustainability through integration.

8. *Ilbid*

Rural settlements like Ballstad, already possess hybrid identities the introduction of new peoples offer an alternative path to the current economic paradigm; full with the potential of a weak modernism. .

These new flows of people to Vestvågøy, further add to the fundamental condition of rural areas to continually 'become'; fostering multiple emergent possibilities."⁹ New labor in the Lofoten Archipelago, however the product of displacement and sudden introduction, are part of the history of a place that as with Krohg, "can be understood as a series of interpretations of something that has 'always been', rather than a collection of circumstantial traditions."¹⁰

9. Mark Shucksmith and Katrina Ronningen, *The Uplands After Neoliberalism?—The Role of the Small Farm in Rural Sustainability*, *Journal of Rural Studies* 27 2011 275-287

10. Christian Norberg-Schulz. *New World Architecture*. Princeton Architectural Press, New York:1988. Page 9.

ii. The Polyvalent Structures of The North Atlantic; A Foundation for Building on Vestvågøy Island

King Eystein built a large ship at Nidaros, which, in size and shape, was like the Long Serpent which King Olaf Trygvason had built. At the stem there was a dragon's head, and at the stern a crooked tail, and both were gilded over. The ship was high-sided; but the fore and aft parts appeared less than they should be. He also made in Nidaros many and large nausts of the best materials, and well timbered.

Saga of Sigurd the crusader and his brothers Eystein and Olaf, ch. 27)

Despite the technological, cultural, and political leaps that have occurred since the time of Sigurd the Crusader, the boat house, or the naust, continues to be a quintessential part of coastal life on the North Atlantic. Boathouses now mainly exist as a cultural object, fulfilling a nostalgic role as opposed to their former places as centers of power. Despite shifts in use and connotation through time, these structures still persist to articulate the

void between land and sea. While a strictly historical analysis of the pre-modern naust is a useful tool in understanding the socio-economic context of the region, an architectural study reveals a more expansive definition of the naust. This later perspective reveals these built works as part of an adaptable typology, which even in the absence of its primary function, host a rich secondary social utility.

Historic boathouses located throughout the North Atlantic were an integral piece of coastal farms dating back to the Early Iron Age. Archaeological excavations on the Island of Vestvågøy, within the Lofoten Islands, reveal that these structures were most dynamic in the absence of the boats they were built to hold. The historical record of the naust, Old Norse for "massive house", sets a precedent for structures along coastal Norway with open and multifaceted nature.

When these buildings were emptied for Viking raids or fishing expeditions, the record suggests they became activated spaces of social gathering,

habitation, and work all taking place under a polyvalent roof.

Unlike the largest and often militarized boathouses of the more centralized southern Norway, the nausts in the northern regions were primarily used by fishermen and farmers. This same demographic, as matter of national policy, still inhabits northern Norway and has preserved the tradition and place of the naust within the cultural landscape. Historically, boathouses located throughout the North Atlantic were primarily built to protect wooden ships from the elements.

As implied in the Saga of Sigaurd the Crusader, ships were central to the projection of political power and represented a significant investment of resources. On this topic, the historians Frans-Arne Stylegar and Oliver Grimm observe, the large boat houses of the coastal city of Bergen "were used for protecting precious ships against negative effects on their maneuverability caused by exposure to water or

sun for long periods when they were not in use".¹ Protecting vessels from exposure was necessary beyond Norway and building traditions related to the sheltering of boats can be seen throughout all of Europe. That being said, the naust, and the network of waterways it represented were of unique importance in the North Atlantic as there were no overland routes. Set against the mountainous terrain and the impenetrable forests of western Scandinavia, the naust, like the church, existed as a metonymic entity, where structure provided linkage to a network reaching beyond the horizon. Likewise, since the nausts were often large and rose above adjoining buildings, their profiles came to be identifiable symbols of community for early settlement.

Even within the primary examination as the naust as a place for wooden ships, there is a history of architectural evolution and adaptation. These structures, up to forty by thirty meters, varied in use based on

1. Frans-Arne Stylegar and Oliver Grimm, *The International Journal of Nautical Archaeology. Boathouses in Northern Europe and the North Atlantic. 20055 253-268*

social context. In the sea-faring age of Viking and Medieval times, Nordic construction techniques spread to the British Isles and beyond, eventually reaching North America. The archaeological presence of naust construction on the island of Orkney, Scotland serves to illustrate that even on the periphery, the typology of the naust was evolving to facilitate expanded uses.

J.R Hunter, in a piece written in *The International Journal of Nautical Archaeology*, writes that within a site on Orkney, there is evidence of an evolving practice and an architectural response. Hunter notes that within the structure "the later phases of use almost certainly turned the naust into a working area within which two, boats could be repaired (or even built) as well as simply stored over the winter. This working aspect is to some extent supported by the finds, the majority of which consisted of fragments of iron nails and roves."²

J.R. Hunter, The International Journal of Nautical Archaeology. The survey and excavation of boat nausts at Hurnip's Point, Deerness, Orkney 1992 21.2 125-133

In this case, the archaeological record illustrates that these buildings of larger spans were able to accommodate activities of increasing levels of sophistication. Whereas the naust had formerly served the function of slipway (batopptrekk) and landing places (basto):

It seems that subsequently the function and character of the naust may have changed; a secondary series of flags (differentiated on the plan) were laid over this earlier turf and the flat keel line became largely obscured. At least one large keel-support stone was positioned along the keel axis. This new flagging arrangement was no doubt intended to act as a plinth on which timbers could be stood to support a boat in an upright position. The keel stone(s) would have had the effect of a brake as well as allowing working access to the underside of the boat.³

Hunter's observation is indicative of a tradition of accommodation, where form is constantly adapting to meet the demand of new processes. The archaeological record further marks a transition of the naust from a structure of static storage to a place animated by human activity.

The evolution of the boathouse as a multi-

3. Ibid, 125-133

functional structure soon moved beyond a platform for exclusively maritime-related activity. The dimensions of the volumes used to house the largest ships of the time, as matter of mere consequence, also appeared to foster extensive social use. Proving the dictum that nature abhors a vacuum, the historians Stephen Wickler and Gorill Nilsen write of the almost open plan quality of the naust that:

Evidence of dwelling within Iron Age boat houses from Vestvågøy is particularly compelling. The results of Gorill Nilsen's excavations (1998: 106-11) provide a convincing argument for residential use of boathouses which may be associated with seasonal fishing activity. Multiple cultural layers with dense charcoal concentrations, fire-cracked rock and burnt bone suggest fairly intensive use linked to activities such as food preparation. Pieces of slag point to metalworking, while whetstone fragments and assorted iron objects are indicative of various everyday tasks...The abundance of iron boat-nails and clenched-bolts is typical in boathouse excavations, but the presence of features such as multiple hearths and a pit containing artefacts, charcoal, and fire-cracked rock also confirms activities unrelated to boat storage.⁴

The presence of multiple hearths and gathering

4. Stephen Wickler and Gorill Nilsen, *The International Journal of Nautical Archaeology. Pre-modern Boathouses: a maritime perspective from northern Norway*. 41.1 pg 106-119 . Published by Blackwell Publishing Ltd.Oxford 2012

points within boathouses, together with cultural layers of significant thickness, reveals a history of activity far richer than the narrative of its primary use. The historical record points to another example of exceptional secondary use. According to the primary source of the Saga of Hakon Hakonsson, in the historic Bergen, a forty-five by thirty meter naust served as a royal banquet hall during Hakonsson's coronation of 1247 AD. Though this building was chosen because it was the only large-volume space at the time, the suggestion that a ceremony of the highest cultural echelon could take place in a building of utility is suggestive of much more fluid conceptions of formal definitions. A similar blurring of functionality can be seen across typology along coastal Norway. In the Middle Age town of Kinsarvik, the opening in the Romanesque church's roof indicates, "that the church was once used for the storage of ships' sails, as reported in medieval laws."⁵

5. Christe, H., 1986, *Leidangsmaterial i kirkeloftet*, *Hikun* 12, 67-72.

Umberto Eco, "Function and Sign: The Semiotics of Architecture", provides an indispensable framework with which to understand both utility and the naust within this cultural context. As all building types must communicate a use, they are influenced by semiotics. In this sense, the communicative and symbolic properties of a built work may present a reading other than that of its intended use. Just as the boat house denotes a primary use in its form, a phenomenological consideration and codification connotes other alternatives of equal use. Eco writes on the value of secondary and culturally rooted utility, noting, "it should be clear that we are not being metaphorical in calling the symbolic connotations functional, because although they may not be immediately identified with the functions narrowly defined, they do represent (and indeed communicate) in each case a real social utility of the object."⁶

Considering the threatening scale of the

6. Umberto Eco, *Function and Sign: The Semiotics of Architecture*. Bloomington: Indiana University Press, 1976.

natural environment in this region, the naust most certainly fulfilled a symbolic function by lending imaginability to the networks that linked coastal towns together. These structures perched on the shore against the backdrop of jagged mountains, effectively marked man's endeavor in opposition to a vast impenetrable interior. Just as barns in the region are lightly framed and open in volume to accommodate movement and storage, the stilted and open nature of the naust is the product of function. The articulated expression of these structures, while informed by utility have also evolved to connote an expression of community. Wickler and Nilsen also point out that the naust was a place of multi-ethnic interaction :

Our results demonstrate that boathouses reflect the importance of multi-ethnic meeting places and spaces where complex interactions between Norse, Sami and other ethnic groups took place within a maritime context. These results challenge the assumption that boathouses are an exclusively Norse archaeological entity in northern Norway during the Iron Age and Medieval period. We conclude that complexity increases within ethnic boundary zones where boathouses and a constellation of associated archaeological elements represented hybridized products

shaped by a specific set of circumstances.⁷

The legacy of the naust and its vital importance to coastal life can be further seen in a toponymical examination of the northern Norwegian landscape. Compound town and place names often consist of terms like *skiparsto* (landing place for ships), *snekke* and skip and ending in *-naust*, *-hus*, and *-toft*, alluding to sites and histories, often supported by archaeological excavation of the built environment's connection to the sea via harbor. Lasting well beyond their physical presence, pre-historic nausts remain as part of a lingual network. Many of their sites still host industry, trade, and safe harbor amidst a challenging landscape.

Though the scale of the modern ship has made the timber boathouse all but a relic, the incidental architectural space within these historic structures is remarkably current.

7. Stephen Wickler and Gorill Nilsen, *The International Journal of Nautical Archaeology. Pre-modern Boathouses: a maritime perspective from northern Norway*. 41.1 pg 106-119 . Published by Blackwell Publishing Ltd.Oxford 2012

Compared to the upheaval caused by technological revolution, the volumes of social gathering have remained comparably constant as seen in the church, the hall, the assembly room. The persistence of the naust speaks to the need for an Architecture of human scale with a communicative social function.

iii. An Inquiry into Values: Impressions of Nordic Architecture from the Road

Out from the Cold: A Reflection on
Norwegian Architectural Tradition and
Trends in Current Practice

Then I began, as though I had never seen my shoes before, to study their expression, their mime-like movements when I moved my toes, their shape, and the worn-out leather they had; and I discovered that their wrinkles and their white seams gave them an expression, provided them with a face. Something of my own being had gone over into these shoes they struck me as being, a ghost of my "I," A breathing part of myself.

- *Knut Hamsun, Hunger, pg. 39.*

In the turn-of-the-nineteenth century novel, *Hunger*, the protagonist's fevered reflection on the resonance between the self and the material world is evocative of the forces that continue to give meaning within contemporary Architecture. As Norway has emerged from a period of modernist consensus, built works have begun to reengage with the processes of material usage and place-

based technique. Between the economy of the expedient and the continuity of the traditional, meaning within Architecture has returned to the material. This return to the object is a trend that has paralleled and perhaps attempted to ameliorate, greater society's loss of its lived-in tactility, its crisis of authenticity.

While the Norwegian architectural tradition and its archetypal forms, such as the *naust*, are often branded as a folksy retreat from rationalism, they are rather essentially examples of functionalism. In the wake of Modernism's attempt at a clean break with history and Post-Modernism's abuse of symbol, meaning in architecture has returned to a status similar to Hamsun's shoe: the extension of pathos to the material world. That being said, the enduring qualities of the Norwegian architectural tradition, as present in the *naust*, are not a product of romantic principle, but rather the consequence of a tectonic practice rooted in a functional concern for utility, material effect, and opposition to the natural.

If contemporary architecture within Norway has inherited the romantic tendencies responsible for wobbly historicism of the Dragon-Style¹, then the currently praised pragmatism of Nordic design must be viewed as historical aberration. However, to the contrary, it is the romanticized narrative that began Norway's search for its architectural and national identity in the form of the *Dragon-Style*, that has strayed from a historical continuity of pragmatic built works.

As compared to the more formal works of Snøhetta or Jarmund Vigsnaes Architects, Jensen Skodvin Architects represent the fullest and most nuanced return to the historical continuum. The architectural approach of JSA is restrained, yet playful in its associative use of materials. The dispositions of these respective firms provides an appropriate comparison with which to explore the qualities of a continually-evolving material tradition and modern form. Though the architecture of JSA is not gestural, it is not

1. *Dragestil* ("Dragon Style") is a style of design and architecture embracing National Romantic style and an expression of Romantic nationalism. Named for the dragon motif adorning Swiss chalet style buildings.

afraid to reference and derive meaning from a world outside of itself, or to challenge the material narratives with unlikely juxtapositions and ahistorical deviation. In this light, works such as JSA's Cistercian monastery on the island of Tautra are not driven by the regeneration of romantic form, but rather are the result of a continued reinterpretation of vernacular technique.

As Karl Otto Ellefsen states within his essay, *A Model Practice*, the firm's work moves beyond the expectations and branding of Norwegian architecture that has come to be typified by a natural subtlety of "oriental elegance and Calvinistic restraint".² This sentiment is an example of the complex relationship within the Norwegian building tradition surrounding the mythos of its relationship with the environment. In an attempt to correct the impression that Norwegian architecture is the product of an unbroken romantic approach,

Sverre Fehn scathingly responds to this idea of

2. Karl Otto Ellefsen. "A Model Practice". *Jensen & Skodvin Architects: Processed Geometries 1995-2007* (2007): 18-19 .

a preindustrial ethicality when prompted from Ingerid Helsing Almass, noting:

The truth is, our (Norwegian) relationship to nature is very crude- It is no longer directed by the practical necessity, material tradition and knowledge which gives vernacular architecture its subtly. The vast majority of structures erected in the countryside are dictated by expediency.³

Considering Fehn's words, and the relationship between himself and Jensen, the structure of the Tautra Maria is both conventionally expedient in the terms of its economy and at the same time a radical departure from the expected. Among the interlocked timber of the chapel's roof is a lively dialogue between practical utility and contextual allusion. Within the framing pattern, the order of the stav kirke is digested in an asymmetrical balancing act of attenuated light and mass. The irregularly placed diagonal members, which provide lateral stability to the structure, up-end the clear projection of Christian Norberg-Schulz's Axis Mundi, and dismantle the tired comfort of the stav og loft.

3. Ingerid Helsing Almass. *Norway A Guide to Recent Architecture* (London: Bratsford, 2002), 3.20.

The architecture of the chapel is also linked to a meaning beyond the commonalities of buildings found within traditional formal typologies. Thus, it can be said that in the broadly reaching details of the chapel, which are not necessarily related to the qualities associated with the "chapel", is a non-specificity that makes the work quintessential Norwegian. While it engages with a history of the church in Norway and indeed with the ruins of the medieval monastery near the site, it also makes allusion to examples of structural utility that surround the cultural landscape.

The elemental joining of members against the backdrop of the sky, which is so powerful in the ceremonial context of the church, is a formal language held first by the utility of the hjeller. The hjeller, or the fish drying rack, possess an archetypal quality that, much like the historic stav kirke and traditional naust, is an attenuated structure with a strong singularity between part and whole. At any given time, these forms separated by type and function form a

network of common-construction that dot and link the folds of Trøndelag's fjords.

In his introduction to the stav kirke, Christian Norberg-Schulz quotes Mies Van Der Rohe who writes on the tectonic qualities of early Norwegian architecture:

Where can we find Greater
Structural clarity than
In the wooden buildings of old?

Where else can we find such unity
Of Material, Construction and form?

What warmth and beauty they have!
They seem to be echoes of old songs.

What better examples could there
Be for young architects?⁴

In consideration of Norwegian architecture as more of a pattern of practice, unbounded by the strict boundaries of typology, Mies's description could easily have been in reference to the naust, or the even Hjeller, which only incidentally and externally to its purpose creates a type of architectural space. This type of structural allusion and material usage is a

4. Christian Norberg-Schulz. *Stav Og Loft* (New York: Rizzoli 1990), 2.

force that applies beyond the example of JSA. The dialogue between these forms of construction also suggests that if Architecture is truly the Fabric of Gottfried Semper's Grass Hut, then primary function of these forms can be replaced by a rich secondary function, seamlessly under the same enduring Carpentry. Ellefsen notes that with the break of the moral-codex and chaste modernism that drove Norwegian architecture through the 1950's, there has emerged a new, "wealth of opportunities to be found in the shipyards, oil industry, fishing, farming in the crafts and trades always searching for new material products and techniques that can be used to infuse new architecture with content and meaning."⁵ The referential and extensional characteristic of material usage at Tautra creates a multilayered perceptual quality that reaches through both place and time. Norberg-Schulz comes to a similar albeit differently worded conclusion in an attempt to describe the Norwegian and Nordic building tradition as a

5. Karl Otto Ellefsen. "A Model Practice". *Jensen & Skodvin Architects: Processed Geometries 1995-2007* (2007): pg.-22.

material treatment linked to place:

That remains through the vicissitudes of temporal change, not as cumulative prototypes, but as a more deeply founded attitude about space, form and gestalt. Therefore, the word appearance should not be interpreted too literally but rather as a character that finds expression in manifold nodes. Building tradition thus connotes an open yet bounded manifold of interpretive possibilities. When these are employed in resonance with the demands of time life may take place, and tradition may, in the best case, be realized as architecture.⁶

JSA's monastery and projects such as TYIN tegnesture Architects' Naust på Aure and Koleman Boye Architects' Vega cottage are further linked by a human-scaled legibility in their construction. Similar to Mies's description of the communicative power of the stav kirke, these three projects possess a quality synonymous with Peter Zumthor's discussion on construction within his piece, *A Way of Looking*. These works along with the assemblage of the prototypical hjellar, are as Zumthor writes, emblematic of "the art of making a meaningful whole out of many parts... are witness to the human ability to construct

6. Christian Norberg Schulz. *Genius Loci* (New York:Rizzoli, 1991), 70.

concrete things."⁷ In these projects, there is a simplicity and a tension that runs through the respective structural members. This clarity and utility creates an impression that they have just been raised, however old. A structure like this possesses potential- it is continually becoming. Because the distance between the structure's ideation and its subsequent concretization through construction is seemingly immediate, the comparatively reserved buildings pulse, "imbued with recent vitality -so close to their act of conception".⁸

This quality of vitality and reverberation within a structural system is commented on within Christian Norberg-Schulz's *Genius Loci*. In a strongly environmental-determinist framing, Norberg-Schulz writes that in Nordic and in the anti-classical world:

Simple intelligible structures are avoided and transformed into transparent skeletal structures where line becomes a symbol

7. Peter Zumthor. "A Way of Looking at Things," *A+U Architecture and Urbanism*, February extra edition (1998), 6.

8. Peter Zumthor. "A Way of Looking at Things," *A+U Architecture and Urbanism*, February extra edition (1998), 8.

of force and dynamism. The inside-outside relationship is usually complex and the romantic building and settlement are characterized by a serrate and wild silhouette. Light is used to emphasize variety and atmosphere rather than comprehending elements.⁹

Though Norberg-Schulz's contributions to a phenomenology of architecture cannot be understated, a view of architecture that causally links the formal qualities of a given structure directly to the qualities of the environment, overlooks the aspirational qualities and artifice of the cultural artifact. Likewise, it cannot be assumed that man's conception of the world predates the history of the built environment. In fact, meaning in the act of fabrication is essentially derived from an opposition to or differentiation from the callous forces that govern the natural world. These limits or marks of human agency call the facts by their name and their reign collapses. Rather than the incomprehensible jumble that is the result of a direct reflection landscape, the stav kirke, hjeller and the naust can

9. Christian Norberg Schulz. *Genius Loci* (New York:Rizzoli, 1991), 187.

conversely be seen as ordered and tectonically light systems that escape, not become, their dense and fractured landscape. This oppositional quality that architecture contains is expressive of the fundamental quality of the artifact; it must foster the ideation of space so that man can begin to inhabit the world, to truly dwell. Sverre Fehn, in an interview with Ingerid Helsing Almæss further dismisses the myth that Norwegian architecture is somehow based on the collusion between man and nature, rather than affirming that the act of habitation is inextricably linked to a resistance of the natural:

IHA: People abroad have the impression that Norwegian architecture is about using timber and having a sensitive relationship to nature.

SH: Yes.

IHA: But this isn't the case in your buildings.

SH: Yes, you might say it is in the dialogue with nature. Norwegian topography and nature is all uncultivated, has never been touched. That is really the sensational thing. And on that point I don't think Norway has been particularly inventive—firstly they chop down all the trees, to plant a lawn, with plum trees and tulips all around the house...there is something touching about that, something beautiful. But you can't say it's an inspired culture. Japan for example has a

landscape which is all cultivated, to give nature an even stronger impression...they torture the natural.

IHA: Are Norwegians more kindly?

SF: No, that is naïveté. Or maybe that nature is so fierce that you do everything you can to make it sweet and romantic.¹⁰

The summer house of Knut Knutsen at Portør is fundamentally different in disposition to the traditional naust or current reinterpretations that exist in concert with Fehn's positioning of architecture. Knutsen's formal language appears to disappear among the rocks upon which it sits, rather than maintaining the historic dichotomy between the fabricated and the environment. In this manner, and in a Norwegian context, even works linked by type may be diametrically opposed when it comes to the implications of their construction. Whether naust or church, tectonic language is paramount to meaning as Kenneth Frampton writes that the:

Ontological consequences of these frameworks tends towards the aerial and dematerialization of mass, whereas the mass form is telluric, embedding itself deeper into the earth. One tends towards the light and the other towards the dark. These gravitational opposites ... may be said to symbolize the two cosmological opposites to which they aspire, the sky and the earth.¹¹

Along the steep coasts of the Lofoten Islands, a similar meaning rooted in construction has emerged from processes grounded in utility. Here, fishing communities had been carved out of inlets where existence, much like their brightly colored nausts, tenuously grip. Currently, the archipelago draws as many artists and tourists as it does fishermen. The gentle quality of its northern light and its hardscrabble past create an atmosphere of an almost contradictory air. The narrow chain of Islands and the traces of a way of life here are emblematically Norwegian in their utilitarian disposition. In contrast to the purposeful effect of material usage in projects like the monastery at Tautra, these boathouses possess an honest ad-hoc quality that

10. Ingerid Helsing Almss. *Norway A Guide to Recent Architecture* (London: Bratsford, 2002), 3.22-3.23

11. Kenneth Frampton. "The Case For The Tectonic". *Architecturally Speaking: Practices of Art, Architecture, and the Everyday*. Ed. Alan Read. (Abington: Routledge, 2002), 180.

is almost modern in their material practicality. Some of the buildings have gradually expanded, lumbering along aggregating and shedding material, never really becoming complete. In these working buildings, the unfinished surfaces and additions project a sense of continued possibility, even though the fishing fleets have long since modernized. In this manner, built works of a certain organization and tactile approach can be inherently vibrant, holding traces of past activity.

The character of these raised boat houses certainly are a product of their time and place. In a particular example of the naust at Henningsvær, the wooden piers come down to meet the rocky ground each at their own imperfect height. Had dynamite been available on the islands, it might have been cheaper to blast away and make all the members uniform, the geometries forever taught and without the pathos of their maker's struggle. It is important in this respect to not morally interpret historical and technological limitations as a form of restraint,

but rather as a reflection of the means and modes of the era.

The lateral reinforcement of this naust at Henningsvær is a system of angled members which is haphazardly irregular, if slightly unstable. Certainly they are inefficient, but in their continued existence they speak to the stewardship of their inhabitants. Where their form sags, they have been shored-up by diagonal struts in an as-needed approach. The forces of these foundations work their way up through the enclosure of the structures, creating an order similar to that of Zumthor's reflection on the house, which, according to him, should be "organized in such a way that they endow the body of the building with a quality of inner tension and vibration. This is how violins are made. They remind us of the living bodies of nature".¹² As Christian Norberg-Schulz writes in *Nightlands*, the Nordic conception of space and indeed the world was far less governed by a priori constructions and the stabilizing advent

12. Peter Zumthor. "A Way of Looking at Things," *A+U Architecture and Urbanism*, February extra edition (1998), 10.

of Eidos (from which Continental Europe grew). This sentiment rings true to observation as the adaptive and ad-hoc nature of construction on the coast seems anything but absolute.

Norberg-Schulz notes that the Nordic conception of space "is primarily a clearing rather than a Euclidean whole. The Nordic Gestalt lacks the South's wholeness. It is like a biblical land of creation, always incomplete in a state of becoming..."¹³ The norms of European modernism foster a reaction of a very different disposition in the rugged North. Take the canonical example of the Brick Country House of Mies Van der Rhoe as compared to the recent Vega Cottage by Boyman Kole Architects. The differences in the two structures is not limited their construction, but also are rooted in two vastly different interpretations of space itself. Tectonically, the stereometric construction of Mies's bricks embodies the unwavering permanence of the classical/Cartesian grid reaching out into the landscape, while the weathered wood that

demarks the edge condition of the Vega Cottage is in a state of flux, its patina and disintegration a material witness to the sea.

Discussions on the richness of the vernacular often misattribute a given building tradition as simply a reflection of a given environment. The causal relationship in actuality begins foremost with a given environment's stimuli and its subsequent role in the creation of perception. The same forces that govern the development of form and the quality of place within the material world are also more importantly responsible for the localized shaping of human consciousness. In this manner, the strength of a vernacular tradition is indicative of a given landscape. But most importantly, it is the material embodiment of the capacity for thought that grew from that particular place. While expressions of the environment do range from the classical Mediterranean to the fractured romantic Nordic landscape meaning is inextricably linked to being in the world. Juhani Pallasmaa writes on the human need of this return to things

¹³ Christian Norberg-Schulz. *Nightlands* (Boston: MIT Press, 1997) 5-6.

that:

We are bound to live in a world of gravity and light, meter and seasonal cycles, and countless other physical and mental casualties. The horizon line and the force of gravity continue to be constitutive for human perception and our psyche. These are conditions that have formed our senses, our body and mental reactions and continue to give us meaning and pleasure.¹⁴

Because of the extreme topography located within the interior of the country and along its coasts, there has long been an artistic tradition of psychic projection onto the landscape as well as an impulse to build vertically. As mentioned, this condition is not an attempt to establish a communion with the mountains, but rather a result of the effort to lessen their effect. The piercing church and even less structurally grand forms like the stilted naust, in their experiential layering of foreground, material work, and background, tie the unsurveyable scope of the natural world to the order of human existence below via material union with the horizon. In the case of the monastery at Tautra, which may

14. Juhani Pallasmaa, Stephen Holl and Alberto Pererz-Gomez. *Questions of Perception: Phenomenology In Architecture* (San Francisco: William Stout Publishing, 2006) 54.

appear to be at first an organization preoccupied with view, there is a similar effort to hem in the natural world through the framing of the landscape and the horizon.

Instead of the vertical rhythm of the Romanesque arch, JSA's building opens with a spectacular horizontality. Left structurally open, the interior of the chapel opens to a sparse altar. In a move that connects the activity of insular reflection to the outside world, the enclosure beyond the altar is simply glazing with a view to the shore, sea, and sky. The spatial organization in the interior is divided into two realms by this projecting view. The clean and open ceremonial space is compressed by the structural virtuosity of the enclosure's wooden beams. In its literal framing of the outside world under the compressive flutter of the beams' overlapping patterns, this modern chapel so too brings the horizon line into the interior space. Here, the built work possesses a quality conceptually similar to Sverre Fehn's metaphoric use of a boat to explain the forces at

play along the water's edge. When elevated above the foreground, a structure meets the horizon in buoyant dynamism, or as Per Olaf Fjeld writes in *The Construction of Thought*, a material element can serve as, "a kinetic link between the sea and sky".¹⁵

Materially, the unadorned framing system of the roof elevates wood making it a precious material. The sharp angles of the beams' differing orientation catch light in its varied strength and moods. With a clear weather barrier for the roof, the wood sets a warm tone along the pews, in contrast to the chill of the grey sky above. This nuanced vernacular style serves the function of both structure and the communicative charge of stained glass, thus acting in the manner of the *hjeller* construction it alludes to: a truly sustaining structure.

This type of psychic projection onto space also takes place in the historical *naust*'s overlapping of foreground, material, and background which creates an impression of total

15. Per Olaf Fjeld. *Sverre Fehn The Pattern of Thoughts* (New York: Monacelli 2009) 9-11.

architecture. Pallasmaa writes of this effect, "the architectural synthesis of foreground, middle ground and distant view, together with all the subjective qualities of material and light form the basis of complete perception. The expression of the originating idea is a fusion of the subjective and the objective".¹⁶ The *nausts*, such as the one depicted in the town of Henningsvaer in the Lofoten Islands, were primarily structures of utility whose stilted construction was a necessity of high tides and an inability to level the bedrock on which they perched.

The uneven rocks, rising tides and ice warp the vertical piers to create horizontal stress and an uneven platform. These forces are then resolved by placing an opposing diagonal beam within the framework in a process that is the product of a call and response. While we would not build in that manner today, much can be taken from the variegated material and the responsive, asymmetrical balance of these structures. In

16. Juhani Pallasmaa. *Encounters 1*, ed. Peter MacKeith. (Helsinki: Rakennustieto Publishing, 2006) 150.

their imperfect angles and clustered densities, the piers appear to truly hunker up against the earth to shed the sea and wind.

In conclusion and in an effort to reconnect these seemingly different qualities that have come to define Norwegian Building Tradition, the example of Eder Biesel Arkitekter's Bergen Fish Market will serve as an appropriate closing. Much like the teetering and naust and the vertical kirke, the market's structure has simple and tight sectional qualities that are perfect for this site's edge conditions. While the building stoutly holds its volume, it also allows people to pass through and underneath it, moving from street to harbor, transit to stasis. Programatically, the messy business of fish and produce is located below on street-level while an information center sits fully enclosed atop this bustle. This concern for practicality and utility is typical of pre-modern Norwegian structure, yet is also markedly contemporary. In a manner not limited to use, the market is perched over the eastern-most extent of the

harbor, lending the top-tier a commanding view of Old Bergen. In a playful juxtaposition, the area directly northeast of the building is a nexus of activity where pedestrians and the modern movement of highway route 585 pinches the water-bound trade routes of the Hanseatic League.

Literally and in an extensional sense, this energy moves through the fish market's spaces. In a cadenced move, Eder Biesel Arkitekter colored the building's louvers mustard yellow, rich burgundy, and crisp white in an allusion to Bergen's Historic Bryggen. While this modern building openly engages with the Bryggen buildings across the harbor's inlet, it also confronts the use of the Miesian motif in Bergen's centrally located Grieg Hall. Along the glass facade of Grieg Hall, taught steel members are drawn down in that familiar functional-ornamental fashion. The fish market possesses quite a similar rhythm and proportion in its facade, however the tempered use of color makes the cold universalism of the modern detail both present and warm. Though the louvers are

functional, they are also a loaded symbol. By painting them in their historic colors, these member are reposed; becoming a symbol upon a symbol in a rich interplay of histories.

References

List of Figures:

1. Sketch, "Nordland Harbor"
2. Sketch, "Naust"
3. Sketch, "Naust Detail"
4. Sketch, "Interior of Hamsun Center, Nordland"
5. Sketch, "Pulpit Rock Visitors Center"
6. Sketch, Theodor Kittelsen's Fra Lofoten 1891
7. International Map Graphic
8. Travel Graphic
9. Midnight Sun, Sverre Fhen. Per Olaf FJeld. *Sverre Fehn The Pattern of Thoughts* (New York: Monacelli 2009) 9-11.
10. New Labor on Vestvagoy. Philimon Tekeste fra Eritrea. <http://www.lofotpostennolokale-nyheter/haper-a-fa-fiskearbeid/s/1-71-5208214>
11. Old Labor in Nordland. <http://www.plahte.no/engelsk/aktiviteter/fiske/sjoorret/ureidet/oversikt.htm#.VuzCzpwJaQ>
12. Satellite of Housing Map
13. Ballstad and its Surroundings Map
14. Ballstad and its Surroundings Map ii15
15. Map Hybrid
16. Photograph from Gjermesoyaøya by Jakob Eitrheim
17. Photograph from Gjermesoyaøya by Jakob Eitrheim
19. Photo, View South of Ballstadlandet by Trond Pedersen
18. Photograph, view east from Ballstadlandet
20. Photograph, view from hillside of Ballstadlandet
21. Photograph, View East on-site by Trond pedersen
22. *Cattle Being Moved* by Anders Askevold. <http://www.the-athenaeum.org/art/detail.php?ID=169184>
23. *The Dreamer. Portrait of the Painter Torleiv Stadskleiv by Halfdan Egedius.* <http://samling.nasjonalmuseet.no/no/object/NG.M.00505>
24. Bronze Age Nausts on Vestvågøy Map
25. Typical Naust Structure. <http://journal.exarc.net/issue-2013-2/ea/aspects-realizing-house-reconstructions-scandinavian-perspective>
26. Upland map
27. Supporting diagram
28. Winter map
29. Supporting diagram
30. Survey of Farm Settlement reprinted in "Stav og Loft". Christian Norberg-Schulz. *Stav Og Loft* (New York: Rizzoli 1990),
31. Ballstad mapping
32. Ballstad mapping ii
33. Tun model photographs
34. Tun model photographs ii

35. Sketch Detail
36. Naust diagrams
37. Naust diagram ii
38. Model Photograph
39. Model Photograph
40. *Model Photograph*
41. *Model Photograph*
42. *Formation Diagram*
43. *Concept Diagram*
44. *Site winter diagram*
45. *Site harvest diagram*
46. *Concept Sketch*
47. *Ground Floor and Section D drawing*
48. *Floor Plans*
49. *Section B*
50. *Section A*
51. *Section A ii*
52. *Section C*
53. Render, view north
54. Render, view southeast
55. Render, Wide angle view north
56. Render, Wide angle view south east
57. Render, Grand Rom
58. Render, View into unit
59. Render, View into unit
60. Render, View into unit
61. *Render, View into Small Rom*

WORKS CITED

- Almass, Ingerid Helsing. Norway A Guide to Recent Architecture. London: Bratsford, 2002.
- Andrejewska, Joanna and Rye, Johan Fredrik (2012): "Lost in Transnational Space? Migrant Farm Workers to Rural Districts". Mobilities, Center for Rural Research Norway, Department of Sociology and Political Science.
- Christe, H. Leidangsmaterial i kirkeloftet, 1986, Hikun 12.
- Eco, Umberto. Function and Sign: The Semiotics of Architecture. Bloomington: Indiana University Press, 1976.
- Ellefsen, Karl Otto. "A Model Practice". Jensen & Skodvin Architects: Processed Geometries 1995-2007. 2007.
- Fjeld, Per Olaf. Sverre Fehn The Pattern of Thoughts. New York: Monacelli 2009.
- Frampton, Kenneth. "The Case For The Tectonic". Architecturally Speaking: Practices of Art, Architecture, and the Everyday. Ed. Alan Read. Abington: Routledge, 2002.
- Gjelsvik, Tiller et al. "Work segmentation in the Norwegian salmon industry" Marine Policy 51 (2015) 563-572.
- Hunter, J.R. The International Journal of Nautical Archaeology. The survey and excavation of boat nausts at Hurnip's Point, Deerness, Orkney 1992 21.2
- Nilsen, Gørill. Jernaldernaust Pa Vestvagoy I Lofoten. Hovedfagsavhandlingi Arkeologi, Institutt For SamfunnsviternskapUniversitetet I Tromsø 1997.
- Norberg-Schulz, Christian. Genius Loci. New York:Rizzoli, 1991.
- Norberg-Schulz, Christian. New World Architecture. New York: Princeton Architectural Press:1988.
- Norberg-Schulz, Christian. Nightlands. Boston: MIT Press, 1997.
- Norberg-Schulz, Christian. Stav Og Loft. New York: Rizzoli, 1990.

- Moshin, Saleha. "Europe's Workers Flock to Norway for Better Paying Jobs" September 2013: Bloomberg Business. Accessed: <http://www.bloomberg.com/news/articles/2013-09-02/europe-s-workers-flock-to-norway-for-better-paying-jobs>
- Moskwa, Wojciech "Polish Builders In Norway's Artic Darkness". Reuters: November 2006, Available: <http://uk.reuters.com/article/2006/11/24/lifestyle-norway-lofoten-dc-idUKL2277324520061124>
- Pallasmaa, Juhani. Encounters 1, ed. Peter MacKeith. Helsinki: Rakennustieto Publishing, 2006 .
- Pallasmaa, Juhani, Stephen Holl and Alberto Pererz-Gomez. Questions of Perception: Phenomenology In Architecture. San Francisco: William Stout Publishing, 2006.
- Rye, Johan Fredrik. The Western European Countryside from An Eastern European Perspective: Case of the Migrant Workers In Norwegian Agriculture. European Country Side, MENDELU: July 2014 vol. 4.
- Shucksmith, Mark and Katrina Ronningen, The Uplands After Neoliberalism?-The Role of the Small Farm in Rural Sustainability, Journal of Rural Studies 27, 2011, 275-287.
- Stylegar, Frans-Arne and Oliver Grimm, The International Journal of Nautical Archaeology. Boathouses in Northern Europe and the North Atlantic. 2005
- Wickler, Steven and Gorill Nilsen, The International Journal of Nautical Archaeology. Pre-modern Boathouses: a maritime perspective from northern Norway. 41.1 pg 106-119 . Published by Blackwell Publishing Ltd. Oxford 2012.
- Zumthor, Peter. "A Way of Looking at Things," A+U Architecture and Urbanism, February extra edition, 1998.