

---

Masters Theses

Student Theses and Dissertations

---

Fall 2010

## A real-time visualization of AN/PSS-14 audio alert signals for land mine detection validation

Nitin Kolekar

Follow this and additional works at: [https://scholarsmine.mst.edu/masters\\_theses](https://scholarsmine.mst.edu/masters_theses)



Part of the [Mechanical Engineering Commons](#)

Department:

---

### Recommended Citation

Kolekar, Nitin, "A real-time visualization of AN/PSS-14 audio alert signals for land mine detection validation" (2010). *Masters Theses*. 4819.

[https://scholarsmine.mst.edu/masters\\_theses/4819](https://scholarsmine.mst.edu/masters_theses/4819)

This thesis is brought to you by Scholars' Mine, a service of the Missouri S&T Library and Learning Resources. This work is protected by U. S. Copyright Law. Unauthorized use including reproduction for redistribution requires the permission of the copyright holder. For more information, please contact [scholarsmine@mst.edu](mailto:scholarsmine@mst.edu).

A REAL-TIME VISUALIZATION OF AN/PSS-14 AUDIO ALERT SIGNALS  
FOR LAND MINE DETECTION VALIDATION

by

NITIN S. KOLEKAR

A THESIS

Presented to the Faculty of the Graduate School of the  
MISSOURI UNIVERSITY OF SCIENCE AND TECHNOLOGY  
In Partial Fulfillment of the Requirements for the Degree  
MASTER OF SCIENCE IN MECHANICAL ENGINEERING

2010

Approved by

Dr. Virgil Flanigan

Dr. Richard Rechten

Dr. K. Chandrashekhara

Dr. S. Kapila



## ABSTRACT

The central idea of the current research is visualization of audio alerts from AN/PSS-14. A visualization device connected to the arm of PSS-14 will show real-time display of MD and GPR Audio Alert signals from PSS-14. This visualization device displays both amplitude-time and spectral frequency-time formats of the signals. The latter format achieves visual separation of combined, simultaneous, MD and GPR alerts. The joint occurrence of MD and GPR signals in a specific time window confirms the presence of landmine. This window is defined by the time of occurrence of MD peak and time of occurrence GPR diffraction from onset edge of buried landmine. The visual recognition of this window on a visualization device validates the presence of landmine and helps in clutter rejection.

## ACKNOWLEDGMENTS

I am heartily thankful to my advisor Dr. Virgil Flanigan and Co-advisor Dr. Richard Rechten for their continuous support, encouragement and guidance which made this research possible.

I express my sincere gratitude to Dr. K. Chandrashekhara, Dr. L. Dharani and Dr. S. Kapila for their valuable guidance and inspiration.

I would like to show my gratitude to Mr. Rusty Carlile, Mr. Mitchell Cottrell and Mr. Ken Schmid for the lab support they provided.

And, finally, I take this opportunity to thank my parents for the unconditional love, encouragement and support they gave me when I needed it the most. Thanks for being always there with me.

## TABLE OF CONTENTS

	Page
ABSTRACT.....	iii
ACKNOWLEDGMENTS .....	iv
LIST OF ILLUSTRATIONS.....	vii
<b>SECTION</b>	
1. INTRODUCTION.....	1
1.1. HISTORY OF LANDMINES.....	1
1.2. AN/PSS-14.....	3
1.2.1. An Overview .....	3
1.2.2. Problems Associated with PSS-14 .....	3
1.3. MD-GPR AND LANDMINE CORRELATION.....	4
2. PROPOSED SOLUTION.....	8
2.1. RESEARCH OBJECTIVE .....	8
2.2. SPECTRAL FREQUENCY DISPLAY.....	10
2.3. SCOPE OF THE RESEARCH .....	11
3. INSTRUMENTATION.....	13
4. SPECTRAL FREQUENCY PROGRAMMING.....	15
4.1. PROGRAM ALGORITHM.....	15
4.2. LabVIEW PROGRAM.....	15
5. SPECTRAL FREQUENCY RESULTS.....	18
6. CONCLUSION .....	20
7. FUTURE SCOPE: POTENTIAL APPLICATION EXTENSIONS.....	21
<b>APPENDICES</b>	
A. SPECTRAL FREQUENCY DISPLAY RESULTS FOR SAMPLE MD+GPR ALERTS.....	23
B. LINEAR SWEEP FACILITY .....	29
C. AN/PSS-14 .....	32
D. LabVIEW VIRTUAL INSTRUMENTATION.....	36
E. LabVIEW SPECTRUM FREQUENCY DISPLAY OUTPUT FOR MD ALONE, GPR ALONE AND MD+GPR COMPOSITE SIGNAL.....	40

BIBLIOGRAPHY .....	44
VITA .....	45

## LIST OF ILLUSTRATIONS

Figure	Page
1.1. Landmine Problems in the World .....	4
1.2. Location of Occurrence of MD & GPR Signals w.r.t. Landmine/PSS-14 Position and Field Strength of MD Emission Field .....	5
1.3. Ideal MD Signal from PSS-14 .....	6
1.4. Ideal GPR Signal (Fundamental Form) from PSS-14.....	7
2.1. Spectral Frequency Graph and Time-Amplitude Record for MD+GPR Composite .	8
2.2. Example of Multiple GPR Response Forms .....	9
3.1. LabVIEW PDA Hardware Module .....	13
4.1. Algorithm for Spectral Frequency Program.....	15
4.2. LabVIEW Program to Obtain Spectral Frequency Plot .....	16
5.1. Comparison of Amplitude-Time Spectral Frequency-Time Plots Obtained Using Adobe Audition and LabVIEW Vis for Same Input Data .....	18
6.0. Spectral Frequency Display Results for Sample MD+GPR Alerts.....	24
7.0. Linear Sweep Facility .....	30
8.1. PSS-14 Instrument .....	33
8.2. Antenna Geometry for AN/PSS-14.....	34
9.1. Spectral Frequency Plot for MD Only Signal Obtained Using LabVIEW .....	41
9.2. Spectral Frequency Plot for GPR Only Signal Obtained Using LabVIEW .....	42
9.3. Spectral Frequency Plot for Valid MD+GPR Signal Obtained Using LabVIEW ...	43



## 1. INTRODUCTION

AN/PSS-14 is one of the most popular and advanced landmine detection systems in use today. AN/PSS-14 also called HSTAMIDS (Handheld Standoff Mine Detection System) uses combination of Metal Detection (MD) and Ground Penetrating Radar (GPR) techniques for Landmine detection. While MD senses the presence of metal below the ground surface, GPR detects if there is change in lateral dielectric constants of the ground under detection. The joint occurrence of these two events confirms presence of a landmine. AN/PSS-14 issues an audio alert when GPR event occurs within MD envelope. This audio signal is momentary and sometimes it becomes hard to differentiate between good and bad signal and hence needs special training.

The current thesis focuses on validation of GPR audio alert for cylindrical, horizontal, flat top landmines with vertical firing pin in the center. This research is a part of two-man team efforts to develop visual data adaptor for Military AN/PSS-14 Landmine Detector that will allow real-time analysis of MD and GPR audio alert signals. The purpose of visual adaptor is to convert momentary audio signal from AN/PSS-14 into a captured visual trace display on an on-board PDA based computer screen for visual scrutiny and interpretation by analytical on-board data processing procedure. The visual trace will display Frequency Spectrum of combined signal from AN/PSS-14 effectively separating MD and GPR signals. In other words, a time domain data from PSS-14 will be converted to a frequency domain display which essentially separates MD and GPR events, making possible to eliminate False alarm rate (FAR).

In signal detection theory, a false alarm occurs where a non-target event exceeds the detection criterion and is identified as a target. In context of AN/PSS-14, FAR occurs when non-landmine object is declared as a landmine by AN/PSS-14 operator due to ambiguity of audio signal from AN/PSS-14.

### 1.1. HISTORY OF LANDMINES

Landmines are in use since 3<sup>rd</sup> century (Jiao Yu, *Huolongjing Quanzhi*, 1412 AD). During World WarII, landmines proved to be one of the most effective lethal techniques

to keep the enemy from entering strategic territory. (Fig. 1.1 shows the existing active landmine fields throughout the world). So the development of handheld landmine detection systems became a military priority. Initially, landmines were essentially explosive compounds enclosed within metal casings with a step pad, or trip wire, actuated trigger device. So, initially, landmine detection systems were simply metal detectors. But with the advent of landmines with plastic casings and minimum metal contents, landmine detection technology faced new challenges. One of the responses to such challenges was the addition of GPR systems to detect the presence of non-metallic casings. One result was the AN/PSS-14, produced by CyTerra Corp. which was adopted as the Landmine Detection System of choice by the U.S. Military in 1992. The device was first fielded in 2001 during *Operation Enduring Freedom* (OEF)

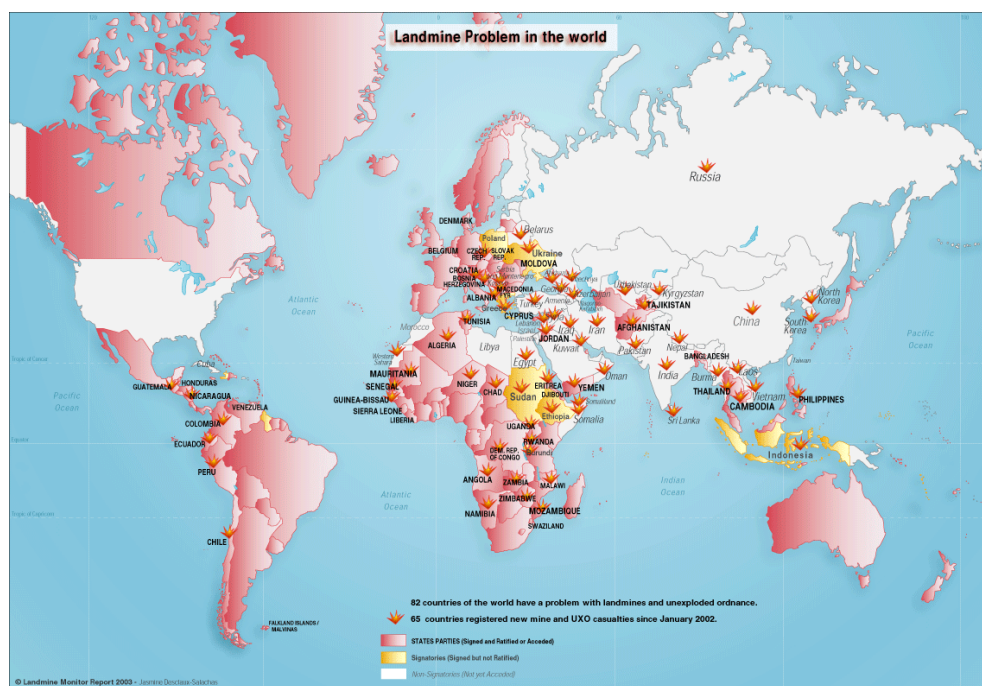

Fig. 1.1. Landmine Problems in the World

## 1.2. AN/PSS-14

**1.2.1. An Overview.** PSS-14 is a 9.6 lb device which uses a combination of MD and GPR which enables detection of anything below ground surface that has mine like characteristics, thereby essentially detecting metallic and low-metallic mines. Pulsed electromagnetic metal detection system (Minelab F1A4 MD provided by MineLab, Australia ) in PSS-14 is probably one of the best metal detection system in world today. Presence of GPR enables detecting the explosive part of a landmine.

HSTAMIDS on an average can detect 275m<sup>2</sup> area per day compared to 25m<sup>2</sup>/day/conventional detector. It has capability of finding mines at greater depth, at angles and in degraded states as well. More discussion about PSS-14 can be found in Appendix C.

Identifying metal clutters is one of the outstanding features of PSS14. When the MD signal is activated, GPR checks if there is any other landmine like material in suspected metal part. Joint occurrence of these two events confirms the presence of landmine.

The alert from PSS-14 is in the form of an audio signal- first sound indicating metal detection followed by second sound of different pitch and tone characterizing GPR event and indicating presence of landmine.

**1.2.2. Problems Associated with PSS-14.** Here follows few of the operational difficulties faced while using AN/PSS-14:

1. Training: As mentioned earlier, certified operator has to undergo a training wherein he learns to differentiate between good and bad audio alert. It is observed that the skills developed during this training wears out over the time.
2. Calibration: The device has to undergo training each time we deal with new kind of soil. This should be done to make ground compensation effective. Once this is done, a threshold is set for metal content of that soil and relative measurements are made with respect to this initial value.
3. Consistency: When PSS-14 is swept over same area again and again the audio tones heard are not the same. This has something to do with the MD+GPR inbuilt algorithm set in the instrument.

4. Motion sensitive: A smooth sweep is required for PSS-14 to get accurate results. Any jerk during motion of PSS-14 over suspected object gives spurious results.

During this research we address issues 1 & 3 and seek solution by providing a visual trace display of the signal generated by MD and GPR. By visualizing the spectral frequency graph, it is very easy to make out the valid alert from invalid alert.

### **1.3. MD GPR AND LANDMINE CORRELATION**

A typical MD envelope for a landmine is shown in Figure 1.2. For a landmine with central vertical firing pin, the center of this MD envelope in time occurs as PSS-14 sensor head passes over the vertical firing pin. PSS-14 algorithm is configured such that GPR event should occur only in the presence of MD alert. Along the sweep direction, GPR events should occur at the edges of mine, one at leading edge and another at trailing edge. Ideally first GPR event should occur at the instant when slope of the MD curve starts increasing. And second GPR event should end when slope of MD curve stops decreasing. But while experimenting with this instrument, it is observed that there is time lag between the occurrence of event and the time when it is reported by the algorithm to the PSS-14 system. This time lag is pretty consistent for MD alert, but when it comes to GPR event, it fluctuates in time. Sometimes GPR will be ahead of its expected time occurrence position and sometimes it will be trailing. Substantial theory behind this discrepancy couldn't be found. This may be a built-in defect in PSS-14 system. Because of this, GPR event may not occur at the time frame references mentioned earlier, but may lead or lag a little-bit.

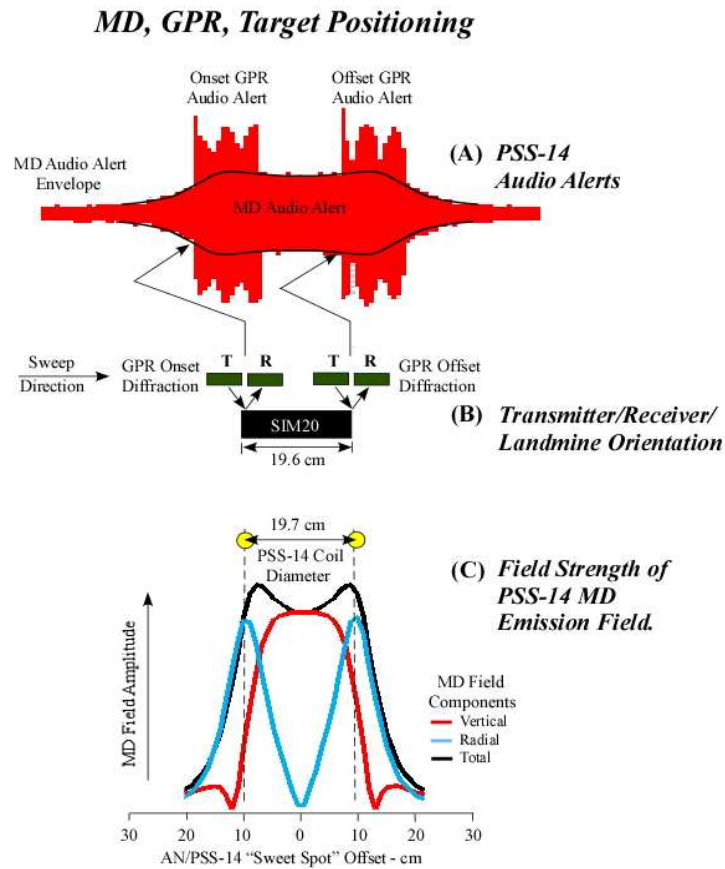

*Notes:*

1. MD Audio Alert as a function of distance along the sweep mirrors' the Total Field of the PSS-14 MD emission field.
2. As sweep speed increases the two positions of maximum MD Audio Alert merge towards a single peak.
3. Onset and Offset GPR edge diffraction initiations, relative to the MD Audio Alert Envelope, both approach the center of the MD envelope as the diameter of the mine becomes smaller.

Fig. 1.2. Location of Occurrence of MD & GPR Signals w.r.t. Landmine/PSS-14 Position and Field Strength of MD Emission Field.

So, a valid landmine alert is the one (see Fig. 1.2) which has MD envelope with one GPR event in the vicinity of increasing slope and the other following it in the MD envelope region. This is further illustrated in successive Sections.

PSS-14 has a pair of receiving antennas and a transmitter antenna. These antennas are separated from each other by 4 cm. Receiver antennas are doubled so that one receive valid alert and false alert will be sensed by the other antenna.

Both the MD and GPR signals from PSS-14 are engineered/synthetic signals. At low sweep speed for circular SIM20 landmine horizontally placed in soil with a vertical firing pin, the shape of MD signal is as shown in Fig. 1.3. The diameter of MD transmission coil on PSS-14 is about 19cm. The slope of MD curve starts increasing when the onset edge of MD transmission coil passes over the firing pin and again start decreasing after the center of MD transmission coil passes over the firing pin. But as the sweep speed increases, these two distinct points of increase and decrease in slope (Fig. 1.2) start coming together compressing the curve producing a single peak as can be seen in Fig. 1.3.

The frequency at maximum amplitude of MD curve reveals information relative to the electrical conductivity of the firing pin. Consequently, the MD signal contains material information relative to metal type of the firing pin.

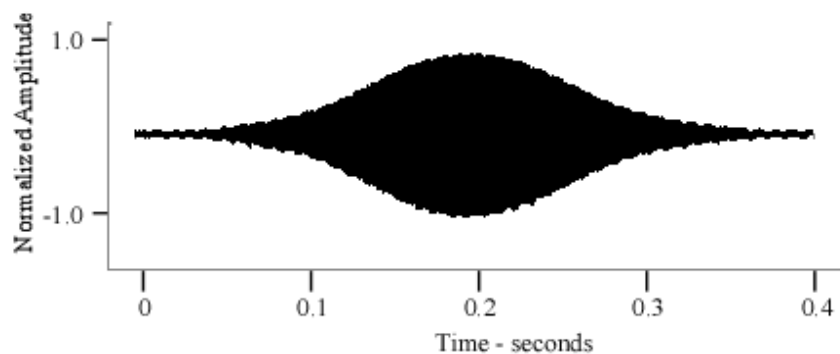

Fig. 1.3. Ideal MD Signal from PSS-14.

The shape of MD curve depends on the metal content of a land mine, type of metal and distance of PSS-14 probe from ground (or landmine) and sweep speed.

A typical shape of GPR signal (Fundamental form) can be seen in Fig. 1.4. This is also an engineered signal of time duration 93 msec. When PSS-14 is moving over an object, GPR alert will be issued only when there is change in lateral dielectric constant.

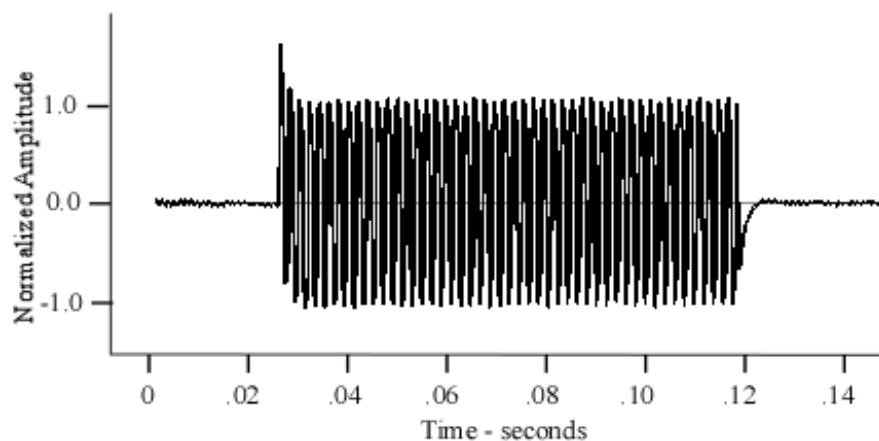

Fig. 1.4. Ideal GPR Signal (Fundamental Form) from PSS-14.

So ideally, at the instant when center of PSS-14 sensor head passes over the rim edges, a GPR alert will be issued. Hence for a flat top, horizontally placed, circular landmine, there will be two and only two GPR events. An important point to be kept in mind is that, the algorithm of PSS-14 is built such that GPR events will be issued only in the presence of MD alert. So when PSS-14 passes over a landmine, at first, a MD alert will be issued as the onset edge of MD coil sees the firing pin. Then GPR alert will be issued when PSS-14 sensor head passes over the onset edge of rim and second GPR alert occurs when the sensor head moves over the offset edge of the rim. By this time, the slope of MD signal starts decreasing as the offset edge of the MD transmission coil in PSS-14 moves over the firing pin. As discussed earlier, with increasing sweep speed, the onset and offset MD peak start merging together giving single peak moving to left or earlier times so that onset diffraction appears higher on MD envelope. For a landmine of small size, onset and offset GPR signals from either edges of landmine may merge together to give single event appearance which is essentially greater than 93 milliseconds event. Tests on SIM9 (9cm diameter landmine) and SIM12 landmines don't show distinct occurrence of onset and offset GPR events. This may also depend on sweep speed.

## 2. PROPOSED SOLUTION

### 2.1. RESEARCH OBJECTIVE

The main objective of current research is to provide a Spectral Frequency display on a handheld device that can be attached to the arm of AN/PSS-14 for a real-time visualization of Audio alerts. The ‘Textbook’ MD+GPR composite audio alert is shown in Fig. 2.1. Figure 2.1A is a time-amplitude record while Fig. 2.1B is a Spectral frequency graph. This Spectral Frequency image is obtained from Audio editing software-Adobe Audition. The current research is focused on getting similar display on handheld device.

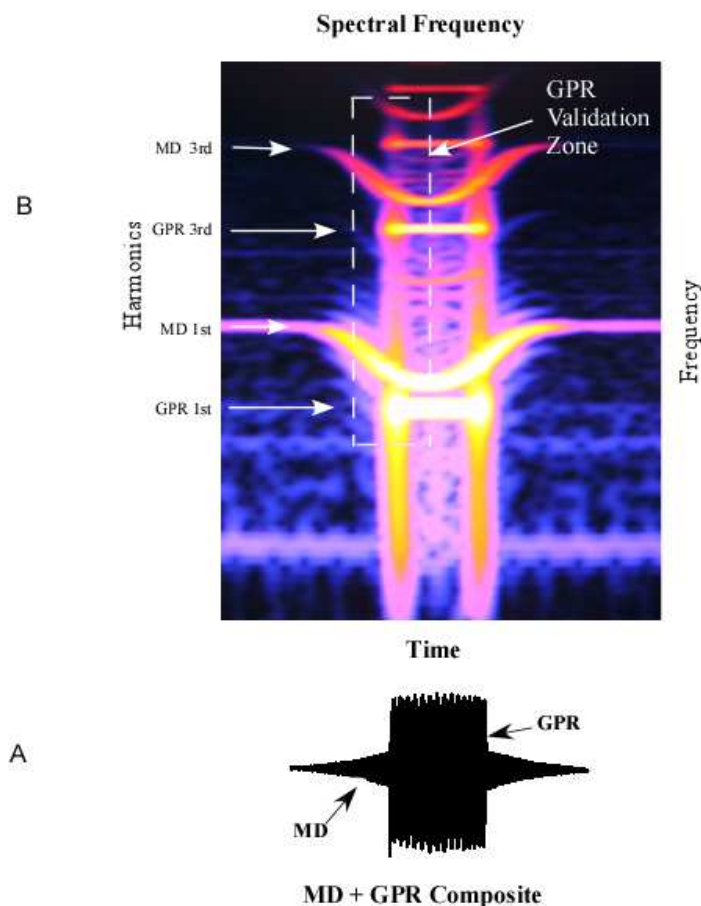
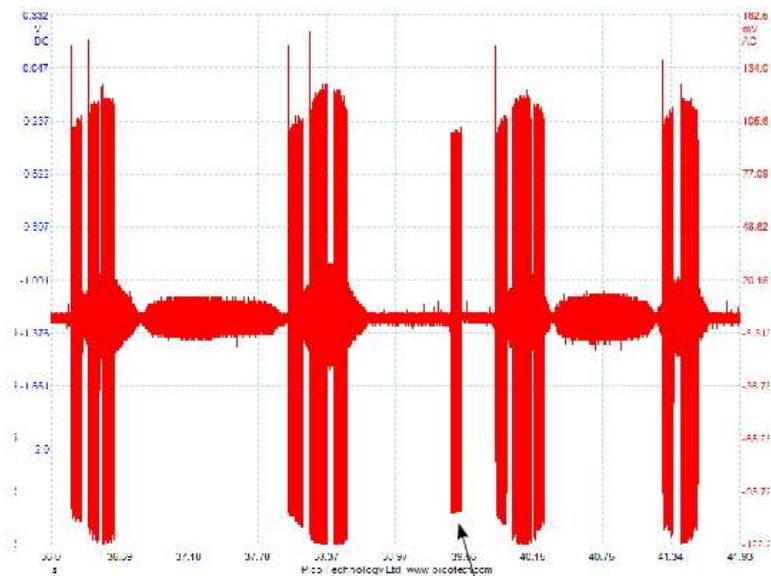

Fig. 2.1. Spectral Frequency Graph and Time-Amplitude Record for MD+GPR Composite.



The alert shown in Fig. 2.1 contains one MD and one GPR event (consisting of multiple GPR alerts merged together) superimposed over each other to give a composite alert. As described earlier, for a flat top landmine planted with top surface parallel to the ground surface, two, and only two, GPR alerts should be issued for a lateral sweep over a landmine: one from the onset rim edge of landmine and the other from the offset edge. Whenever GPR radiation field passes over these edges, an alert is issued.

But experimenting with AN/PSS-14 at Linear Sweep Facility at MS&T (Appendix B), it has been observed that 4 to 5 GPR events occur in the near sweep zone bracketing the landmine (Fig. 2.2).



GPR in the absence of MD

Fig. 2.2 Example of Multiple GPR Response Forms.

Also, though the equipment is designed to deliver GPR alert only in the presence of MD alert, it is commonly experienced that GPR alerts occur in the absence of metal parts in the vicinity of the sweep path (Fig. 2.2). In spite of multiplicity of GPR events

and occurrence of GPR in the absence of metal parts, one important thing about AN/PSS-14 is that, there are always two events that consistently occur: one from onset rim edge of landmine and the other from offset rim edge and these are repeatable events. Generally, offset rim edge GPR alert merges with onset alert to give a single alert having time duration more than 93 milliseconds (which is nominal time duration of the synthetic GPR alert) and this GPR alert is bracketed by inflection points of MD curve as illustrated in Fig. 2.1.). So, though there are multiple GPR alerts for lateral sweep of AN/PSS-14 over a buried landmine, only one GPR alert: from onset edge of landmine can be confidently tagged as valid GPR event.

## **2.2. SPECTRAL FREQUENCY DISPLAY**

Now let's talk about Fig. 2.1 again which illustrates 'Textbook' composite MD+GPR composite signal time record and its spectral frequency display. Further, spectral frequency plot shows "validation zone", which brackets expectation time window within which 'valid' onset GPR diffraction events will occur. The Spectral Frequency display shows frequency vs time plot where change in color intensity reflects amplitude variation. The plot shows a number of harmonics for each audio tone viz. MD and GPR. The MD spectral distribution appears in the form of 'smile' while GPR response takes the form of 'H' shape on spectrogram display. The abrupt initiation and termination of GPR event leads to sudden rise and fall of GPR amplitude forming legs of 'H' and the constant GPR amplitude between these two points forms bar of 'H' shape.

The plot shown in Fig. 2.1 is for sweep over SIM-20 landmine having an aluminum firing pin and is obtained using Adobe Audition Suite on Laptop computer. The expected MD frequency for this landmine is around 800 Hz and GPR (engineered signal) frequency varies from 0.2 GHz to 2 GHz. Fig. 2.1 illustrates the occurrence of GPR event within MD time zone. More importantly, validation zone shows the occurrence of onset GPR event on the rising slope MD curve. This is a valid GPR alert and can be used to differentiate valid alert from false alert. The presence of landmine can be detected easily, quickly and accurately by a quick glance over "GPR validation zone", which enables an operator confidently declare the suspected object as true/false landmine.

The “GPR Validation Zone” or the “anticipated temporal window” is a complex term. It cannot be chosen arbitrarily but is a function of landmine diameter, sweep speed and process geometry. The slope, shape and peak of MD curve is dictated by the shape, orientation and type of the metal for the firing pin. The slope of MD curve starts increasing when the onset edge of the MD coil in PSS-14 passes over the firing pin and reaches peak when center of the MD coil is over the firing pin. The slope then diminishes till MD coil offset edge passes over the firing pin. As the sweep speed increases the MD envelope has to contract in order to fit itself in available time window. On the other hand, a GPR signal remains constant in time window and doesn't depend on sweep speed or landmine geometry unlike MD signal.

The GPR signal is initiated when MD gets activated and first GPR alert will be issued when PSS-14 head passes over the leading edge of the landmine. This first GPR alert from the onset edge of the landmine is repeatable and a valid GPR alert and forms the essential part of “validation zone”. The occurrence of this GPR alert in the presence of MD signal forms the valid alert. So the landmine size, geometry and sweep speed dictates the validation zone.

Composite MD+GPR Audio alerts for 5 different records contaminated by multiple spurious, GPR events are presented in Appendix A. In spite of presence of these spurious, non-repeatable GPR events, a valid, joint occupancy, Spectral Frequency occurrence is clearly identifiable.

### **2.3. SCOPE OF THE RESEARCH**

The scope of this research is limited to the cylindrical landmines with sharp diffraction rim edges and centrally located firing pins. The spectral frequency validation process being described here is based on the fact that GPR responds to the presence of any lateral variation of dielectric contrast along the sweep path provided that MD detects the presence of metal. So for a ‘typical’ landmine described above, there will be two and only two GPR events- one from onset edge and the other from offset edge of the landmine. But sweep of PSS14 over vaulted landmines issues multiple GPR alerts due to small changes in the elevation of the top of the landmine along the sweep axis. This is

because any protrusion on the top of landmine will produce change in lateral dielectric contrast and issues a GPR alert. A flat topped landmine buried with top not parallel to ground produces continuous GPR alert as PSS-14 head moves over a landmine.

Though the scope of current research is limited to cylindrical landmines planted parallel to ground and having vertical firing pin, what we are looking for is the first GPR alert from onset edge of the landmine which will be always issued irrespective of positioning and irregularities in the top surface of the landmine. In case of non-vertical firing pin, the shape of MD curve will not be symmetric and smooth as described above but still the initiation point of rising slope will be the same. So still for non-vertical firing pin, vaulted, nonparallel landmines, looking at the “validation zone” described in Section 2.2 will suffice to validate the presence of landmine.

A handheld PDA device will be attached to the arm of PSS-14. The audio signal from PSS-14 will be input to this PDA device and it will display both amplitude time and spectral frequency-time formats of the signal from PSS-14. The visual recognition of these real time signals makes it possible to validate the presence of landmine.

### 3. INSTRUMENTATION

Figure 3.1 shows NI LabVIEW PDA hardware module for acquiring data from PSS-14 and displaying it in amplitude-time and spectral frequency-time format. The PDA shown is an easily available standard, industrial and phone capable PDA. The data acquisition is done with NI USB, Compact Flash, and PCMCIA data acquisition device. The device runs on Windows based operating system like Windows XP/2000 or Windows mobile for pocket PC 2003. The PDA module communicates with a host computer or other external devices through Wi-Fi (802.11), Bluetooth, IrDA (Infrared Data Association), and serial protocols.

The DAQ device used (NI CF-6004) is capable of providing connections to four analog input (AI) channels and four digital input/output (DIO) channels, with a type II Compact flash interface.

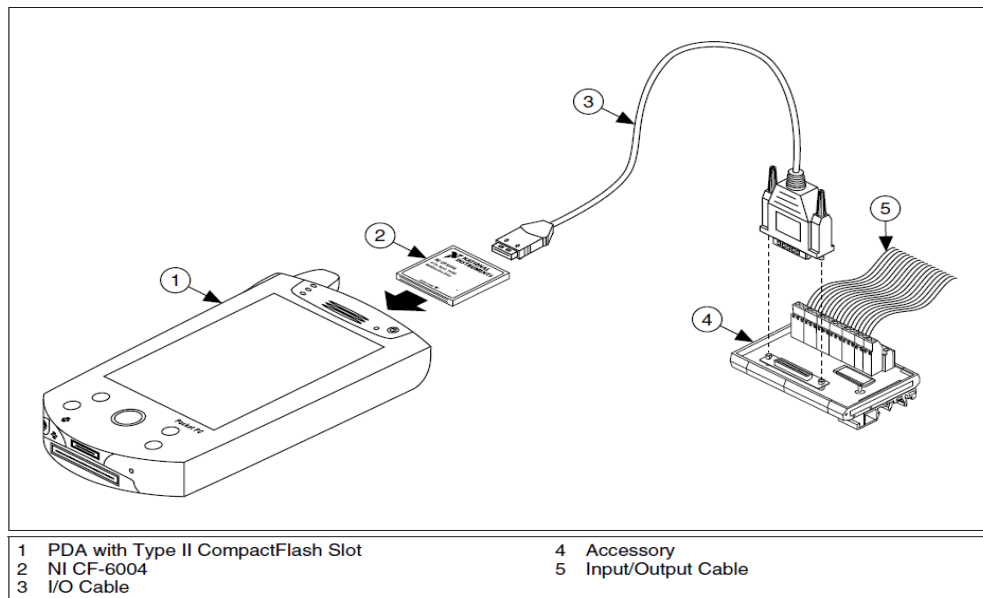

Fig. 3.1 LabVIEW PDA Hardware Module.

## **LIST OF INSTRUMENTATION REQUIRED**

### *Hardware Required:*

PDA with 4cm by 4cm Compact Flash slot

NI CF-6004 Data Acquisition Card for Compact Flash, with associated cables and I/O wire block

### *Operating Systems:*

Windows XP/2000 for development

Windows Mobile for Pocket PC 2003 or later for deployment

### *Required Software:*

LabVIEW Base, Full, or Professional Development

LabVIEW PDA Module

### *Other Requirement:*

Bluetooth Communication if PDA with mainframe

## 4. SPECTRAL FREQUENCY PROGRAMMING

### 4.1. PROGRAM ALGORITHM

Fig. 4.1 shows algorithm developed which will be used to acquire on-field data and display it as Spectral frequency plot. This algorithm can be implemented directly on a PDA to give a visual trace of MD+GPR events. This PDA can be easily configured with PSS-14 to give real-time display of sweep over suspected landmine area.

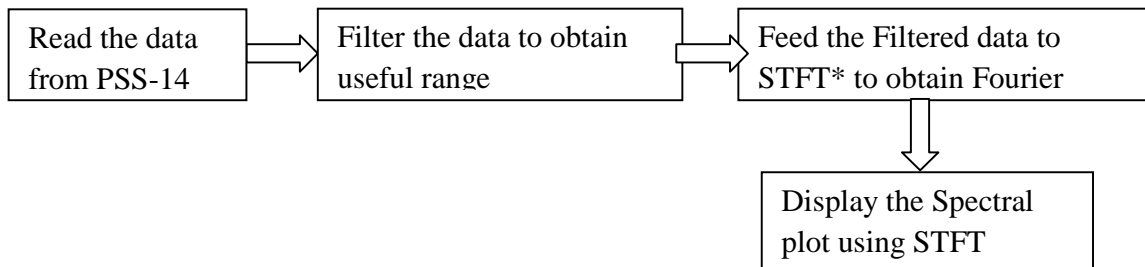

Fig. 4.1 Algorithm for Spectral Frequency Program.

*\*The short-time Fourier transform (STFT) is a Fourier-related transform used to determine the sinusoidal frequency and phase content of local Sections of a signal as it changes over time.*

### 4.2. LabVIEW PROGRAM

Fig. 4.2 shows a LabVIEW program used to obtain spectral frequency plot of the signal obtained from PSS14.

For the current research, the input to the program is data stored in the hard drive of a laptop computer which can be read through *Read from Measurement file VI*. This input data will be displayed in amplitude-time format using *Waveform Graphs VI*. This data is then fed into a *for loop* which is repeated after every 100 milliseconds with the help of *wait until next ms multiple VI*. The *for loop* consists of *Butterworth Filter VI*,

*STFT Spectrogram VI, STFT Spectrogram display VI and wait until next ms multiple VI.* The *Band-pass Butterworth Filter* is set to high cutoff and low cutoff frequency of 3000 and 0.01 Hz, respectively. This is done to get rid of the noise in input signal and obtain a smooth signal as can be seen in Figures 6 in Appendix A. After filtering, the data is fed to *STFT VI*, wherein signal energy distribution is computed in the joint time-frequency domain and then sent to *STFT Spectrogram display VI* for displaying purpose.

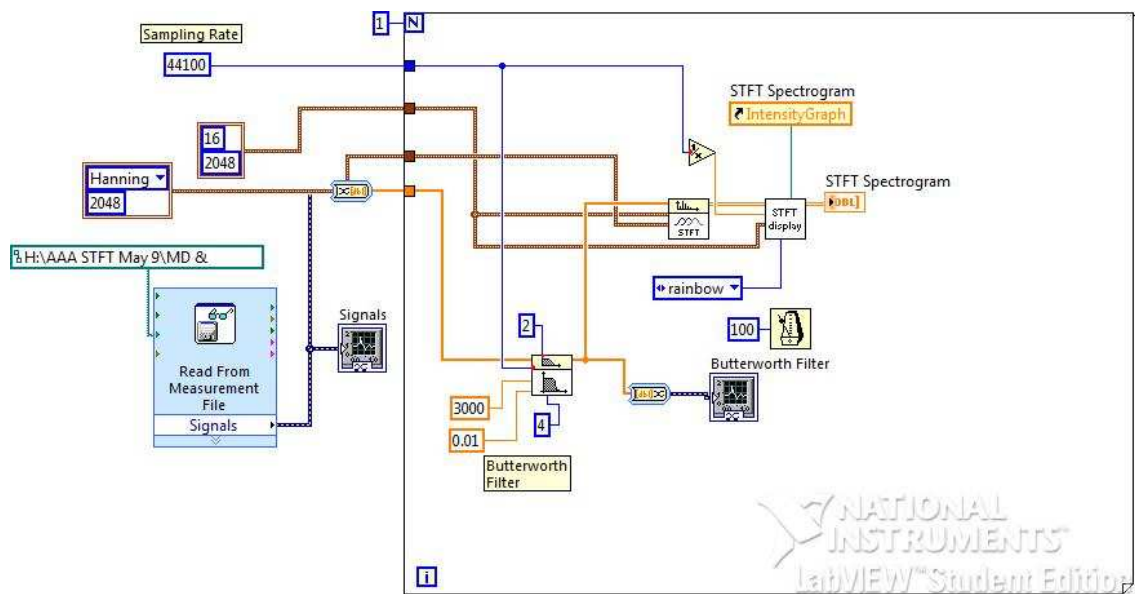

Fig. 4.2 LabVIEW Program to Obtain Spectral Frequency Plot.

The sampling rate for this entire loop is set to 44100. For *STFT Spectrogram VI*, number of time steps is set to 16 and number of frequency bins is set to 2048. The time step specifies the number of samples to shift the sliding window and frequency bins define FFT size of the STFT. The STFT spectrogram display chosen is rainbow; there are other display options available like grey, fire etc. All of these VI's are explained in details in Appendix D.



Scope of the current research is limited to obtain Spectral plots for data stored on computer hard-drive. This data was obtained from PSS-14 during experimenting at Linear Sweep Facility, MS&T. A PDA configured with the above program will be used on-field for landmine detection/investigation to display Spectral frequency plot as in Fig. 2.1 on real-time basis.

## 5. SPECTRAL FREQUENCY RESULTS

Figure 5.1 compares amplitude-time and spectral frequency-time plots obtained using Adobe Audition and LabVIEW VI's. While plots on the left are obtained using Adobe Audition, plots on the right are with LabVIEW program specially developed for the purpose of analysis.

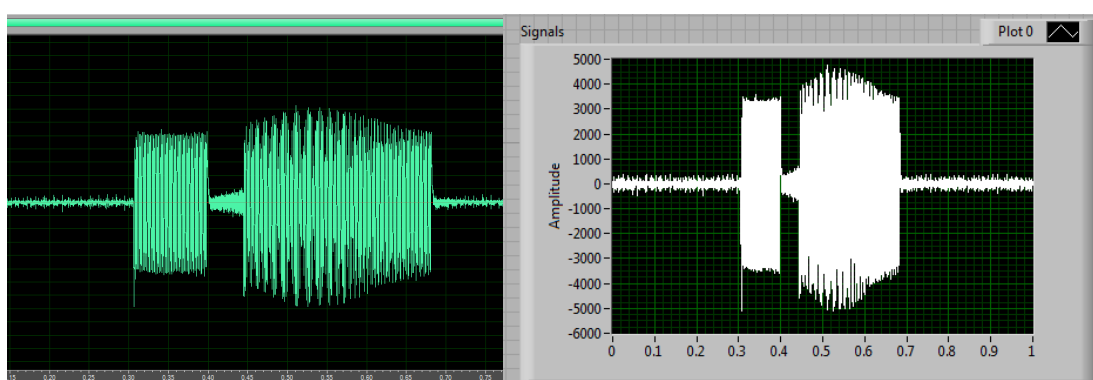

Fig. 5.1a

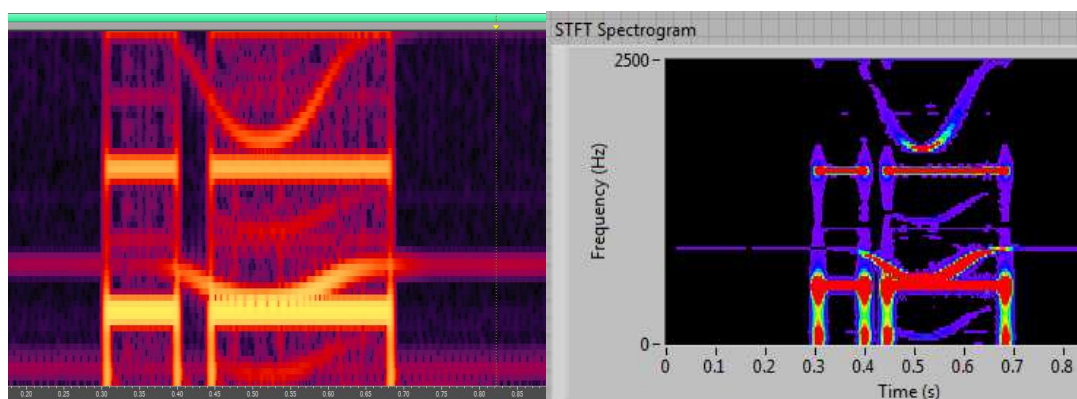

Fig. 5.1b

Fig. 5.1. Comparison of Amplitude-Time Spectral Frequency-Time Plots Obtained Using Adobe Audition and LabVIEW Vis for Same Input Data.

As can be seen in Fig. 5.1, spectral frequency plots from both Adobe Audition and LabVIEW clearly identify the presence of 'H' and 'smile' shape. The visible distinction between appearances of these two schemes may be due to different color schemes. The Adobe Audition probably uses 16 bit color scheme as opposed to 8 bit color scheme for LabVIEW program. Apart from color distinction, both Adobe Audition and LabVIEW show multiple harmonics of the base frequency of MD and GPR signal in identical manner. It is to be noted that Spectral frequency display on the left is for unfiltered signal while Spectral frequency display on the right is for filtered signal.

## 6. CONCLUSION

The central issue of this research is to reproduce the Spectral Frequency Display results on hand held Device that can be carried on-field. Such plots can be easily obtained on laptop computers by using Audio editing software like Adobe Audition. Also Spectrum Analyzer can be easily employed to obtain spectral frequency display. These methods though easy, fast and accurate; can't be used on-field because of obvious reason of size and weight of these devices. Instead a LabVIEW program executed on handheld PDA provides a feasible still a reliable solution. As discussed in earlier chapter, with exception of color, the LabVIEW spectral display is essentially same as Adobe Audition spectral display. Additional complex examples illustrated in Appendix A also enforce the same fact. This research concentrates on the issue of circular, flat top, sharp rim edge landmines with vertically located firing pin at the center of landmines, but with a little modification of "validation zone window" and sweeping geometry can be extended to other types of landmines which are vaulted, noncircular and non-sharp edged landmines. To conclude, the LabVIEW program developed during this research project provides a very useful tool for landmine detection by Audio Alert validation and can be used for most of the landmines currently operational in world.

## 7. FUTURE SCOPE : POTENTIAL APPLICATION EXTENSIONS

The scope of the current research is limited to circular, flat top, sharp rim-edged landmines with vertical firing pins. The size of the MD alert and positioning of GPR alert w.r.t. MD alert in time is governed by the sweep speed, landmine geometry and size. Higher the sweep speed, smaller the MD curve. As discussed earlier, both MD and GPR alerts are engineered signals. Higher sweep speed makes the MD signal to compress in time, but the GPR alert doesn't get affected by landmine geometry or sweep speed. When PSS-14 head passes over a buried landmine, ideally first GPR alert is issued from onset diffraction and other GPR alert is issued from offset landmine edge diffraction. In addition to this, number of GPR alerts may be issued whenever there is lateral variation in the dielectric contrast. This depends on the geometry of landmines its positioning and top surface characteristics. Out of these GPR alerts, the first one issued when PSS-14 head passes over onset edge of landmine is consistent and repeatable. The validation zone is centered around position of this GPR alert w.r.t. MD envelope. The Audio alert from a buried object is valid only when this GPR alert from the onset landmine edge is on rising slope of MD envelope. A quick look at the validation zone will confirm the validity/invalidity of the Audio alert.

Whether the landmine is circular or non-circular (viz. square landmines), the GPR alert will be issued when PSS-14 head passes across the onset edge of landmine. So the "Validation zone" can still be used to validate the Audio Alert form PSS-14. Probably more sweeps might be required in orthogonal directions to confirm the presence of landmine.

For the landmines which don't have sharp vertical edges, there will be continuous GPR alert as PSS-14 head passes over the landmine. But still, the presence of GPR event on rising MD slope which can be viewed in the "Validation zone" can be taken as valid GPR alert. One of the examples (Example#3) in Appendix A explains this fact.

If the firing pin in the landmine is off-centric or non-vertical, the shape of the MD curve will not be symmetric. But still the presence of GPR diffraction from the onset landmine edge on the rising slope of MD curve can be seen on the "Validation zone"

display which confirms the presence of the landmine. This may call for recalibrating the size of “Validation zone” in time frame.

To sum-up, the results of present research can be equally applied to non-circular, vaulted landmines with non vertical firing pins and landmines without vertical sharp edges with little medication of sweep path geometry and recalibration of “Validation zone” size in time.

With the advent of the Landmine Technology, new landmines are being manufactured with low or almost no metal content. Obviously for detection of these landmines, devices like AN/PSS-14 based on MD principle can't be used. But for thousands of landmines laid during World War-II and later, AN/PSS-14 provides a viable and effective solution. So AN/PSS-14 enabled with current research outcome definitely proves to be an effective tool for such Humanitarian Demining purpose.

APPENDIX A  
SPECTRAL FREQUENCY DISPLAY RESULTS  
FOR SAMPLE MD+GPR ALERTS

Example#1: Fig. 6A shows a valid MD+GPR Audio signal composite with a spurious, non-repeatable GPR event even before initiation of MD signal. Though the algorithm of AN/PSS-14 is set to activate GPR only after initiation of MD alert, the event as shown in Fig. A is a common experience with this device. The Spectral Frequency plot clearly reveals the invalidity of the first GPR event, as the 'H' shape falls outside the 'smile'. The next GPR event is valid one as it occurs within MD activation zone and can be easily seen on Spectral Frequency display.

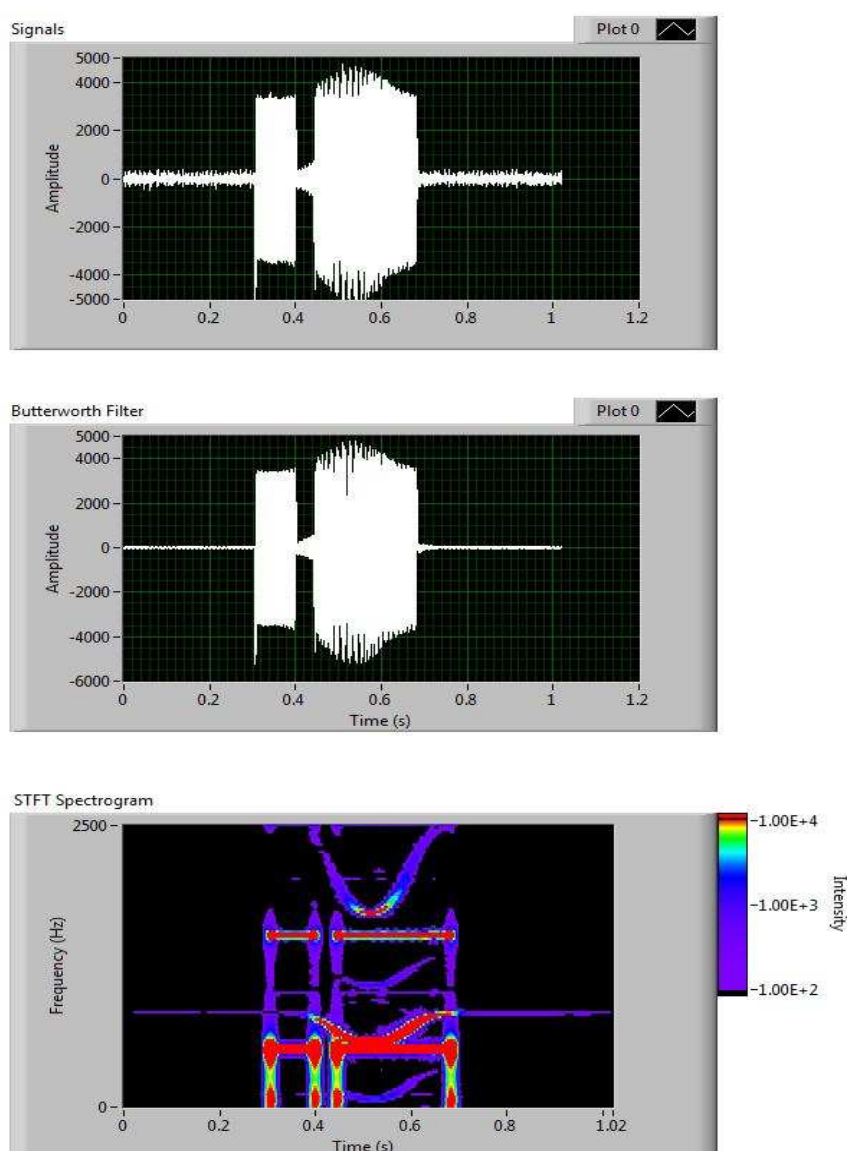



Example#2: Fig. 6B shows a valid MD+GPR composite with one GPR before the MD alert initiation and one GPR after MD alert termination. A valid MD+GPR audio alert signal is bracketed by these two spurious GPR events. Both amplitude-time and spectral frequency-time displays easily identifies the presence of these spurious GPR events.

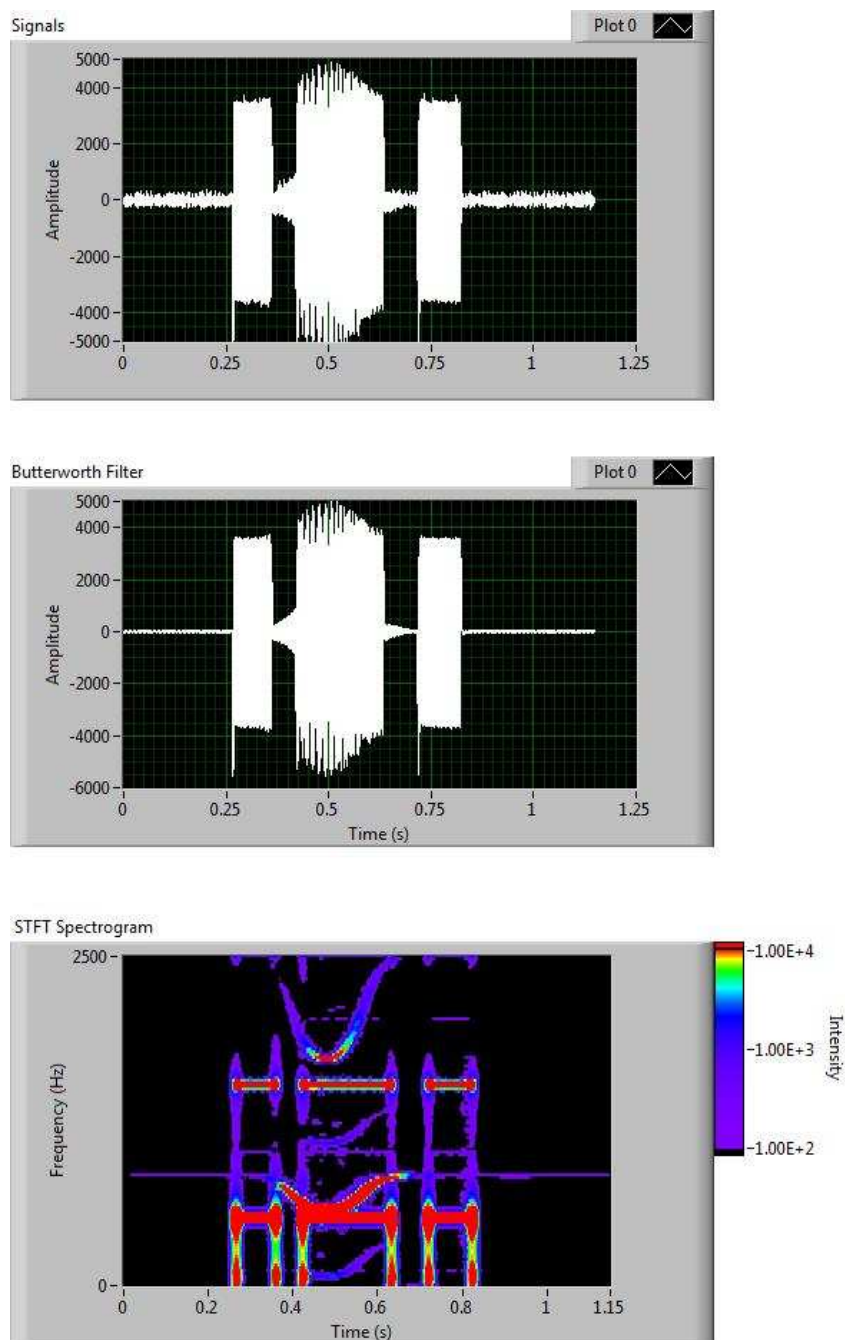

Example#3: In Fig. 6C, the GPR events are seen in the form of two distinct loops, each of the loops consisting of multiple GPR alert. The first GPR event initiates even before MD signal activation, followed by successive GPR alert which merge with the first to give it a ‘single event look’ and forms the first GPR loop. Looking at the “validation zone” reveals the presence of GPR alert in the rising MD slope zone. So though the first GPR alert in first GPR loop starts before MD activation making it an invalid GPR alert, second GPR alert in the same loop is a valid GPR alert which forms the part of the validation zone. This makes the MD+GPR composite a valid landmine alert.

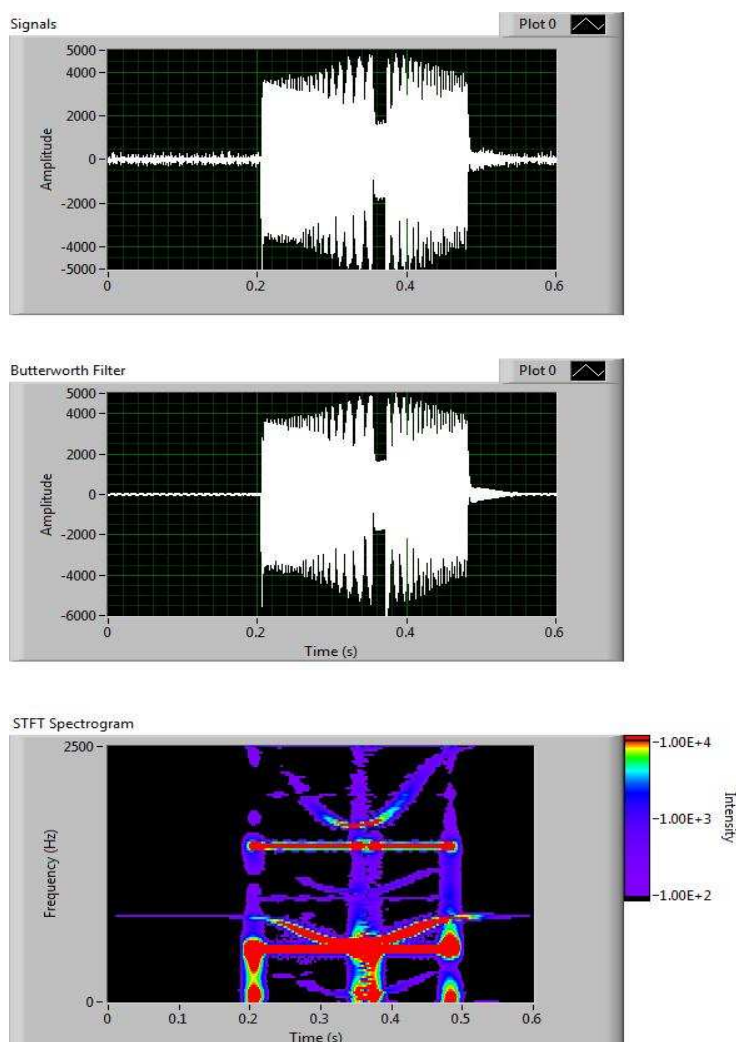

Example#4: Fig. 6D shows a valid MD+GPR audio alerts followed by two spurious GPR events and these events are easily identifiable in Spectral Frequency display plots.

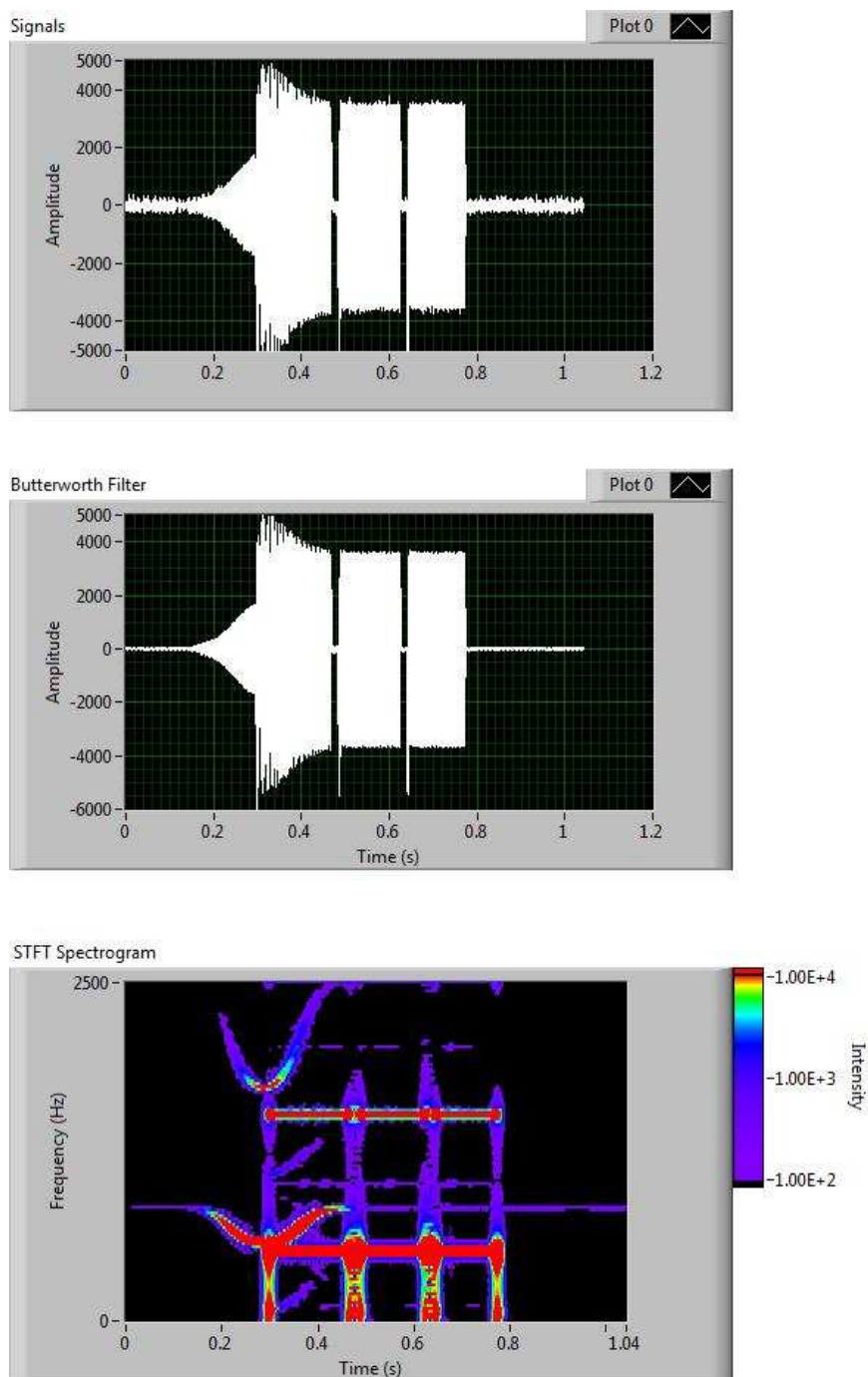

Example#5: Fig. 6E show MD+GPR composite wherein, first GPR signal initiation is even before activation of MD signal making it invalid, but the successive GPR events which seems to merge with the first falls within MD envelope. The validation zone shows presence of both MD and GPR events making it a valid signal.

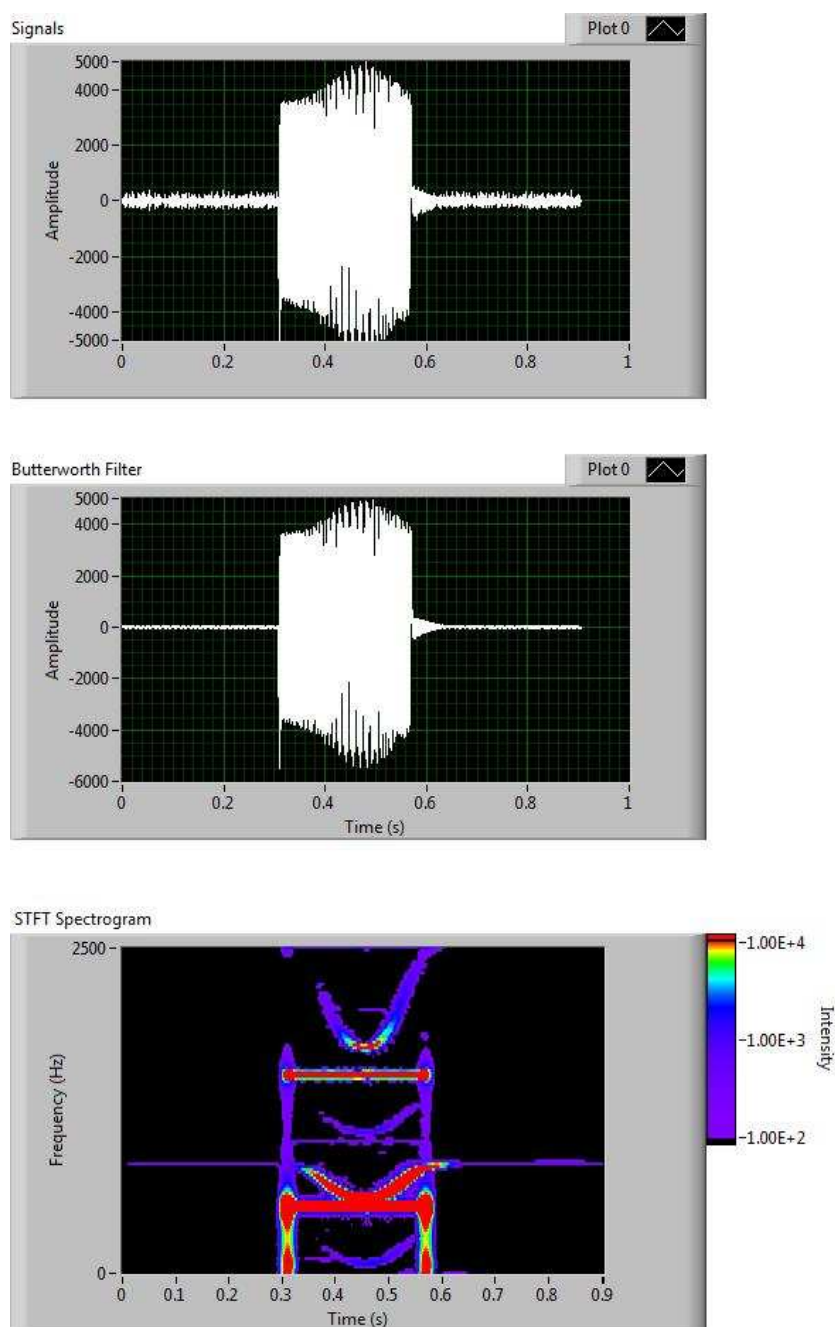

APPENDIX B  
LINEAR SWEEP FACILITY

Figure 7 shows a Linear Sweep Facility (LSF), set up in November 2008. The Linear Sweep Translation System was configured for automated, repeatable dynamic motion of the AN/PSS-14 over the target. This restrained, reproducible movement of PSS-14 will help understand the behavior of PSS-14 in the absence of other uncertainties. Further, through experimentation, many of the unexplained response characteristics which are observed during actual operation can be addressed easily.

The Linear Sweep Translation System consists of a carriage cradle to which AN/PSS-14 is attached as can be seen in figure. The carriage is mounted on parallel 3 meter long overhead transport rails. A belt-driven actuator propels the carriage along the rails up to 3 ft per second. The actuator is powered by a user programmable drive that allows for controlled acceleration, constant velocity over the target, and deceleration to a stop position.



Fig. 7 Linear Sweep Facility

An on-board encoder with drive allows for display of realized acceleration, velocity, and deceleration. Programmable positions are accurate to within 0.0625 cm. The velocity transducer in place on the carriage can be calibrated to all positions along the sweep traverse to within 0.625 cm. By this means the position of the “sweet spot” of the PSS-14, at the time of reception of any reflected or diffracted GPR event, is measurable to within 0.625 cm. Moreover, the velocity of the moving GPR head at any sweep position is also measurable.

The test bed is constructed from Styrofoam blocks and panels which has dielectric constant of 1.03, as compared to 1.00 for a vacuum. Thus the test platform will not generate any GPR alert except when PSS-14 head moves from Styrofoam to earth medium. . The surface contains a 4 x 24 x 48 inch well for the placement of a land mine in soil, and a 4 x 16 x 16 inch well for the placement of an electromagnetic receiver beneath a soil cover. This receiver is used for in-situ measurements of the dielectric constant of the material above it. The process of measurement yields depth-dependent dielectricity, moisture content, and electrical resistivity.

The real-time measurement of combined MD and GPR is made, along with wire-line position of the “sweet spot”, on a dual channel, 16-bit, 12 GHz PicoScope 9201 PC Oscilloscope. The data is transferred to a PC for visualization by means of a WAVE analyzer. A 24 bit, 96 KHz Edirol WAVE recorder is also used to measure MD and GPR data.

APPENDIX C

AN/PSS-14



PSS-14 (HSTAMIDS) uses combination of Ground Penetrating Radar (GPR) and Metal Detection (MD) to detect Anti-Personal (AP) and Anti-Tank (AT) landmines. PSS-14 transmits MD & GPR signals into the ground and analyzes the returned signal for presence of landmine. GPR senses any lateral change in dielectric contrast, so any anomaly in the ground will be reported as suspected object. To avoid this, the software of HSTAMIDS is so configured that, GPR gets active only when MD senses metal like object. Combination of these two technologies reduces the False Alarm rate (FAR).



Fig. 8.1 Dr. Rechten demonstrating the use of PSS-14

Most of the landmines are built using metal for firing pin, casing, and shrapnel. Presence of these metallic contents makes it possible for MD system to detect landmine. PSS-14 contains cylindrically shaped MD coil covering the entire diameter of sensor head. A pulse generating and processing electronics is housed in the electronic unit (EU). Before using PSS-14 on a particular soil, MD system is calibrated for that soil. This process of calibration of MD system for the particular type of soil on which actual sweep

has to be done helps eliminate the effect of minerals (such as iron oxide). This is called ground compensation and is one of the most intelligent features of MD system in HSTAMIDS.

When MD is operating, magnetic pulses are sent by a coil in the sensor head to the ground, which creates an eddy current in any metal objects close to the sensor head and in turn produce secondary magnetic field. The strength of this secondary magnetic field depends on type/composition and quantity of metal. An audio signal is provided to operator through earpiece when the metal is detected in buried object.

The GPR in PSS-14 uses stepped frequency, continuous wave radar. The sensor head contains three antennas, mounted in triangular fashion, one transmitting and two receiving. Fig. 8.2 illustrates antenna scheme and geometry.

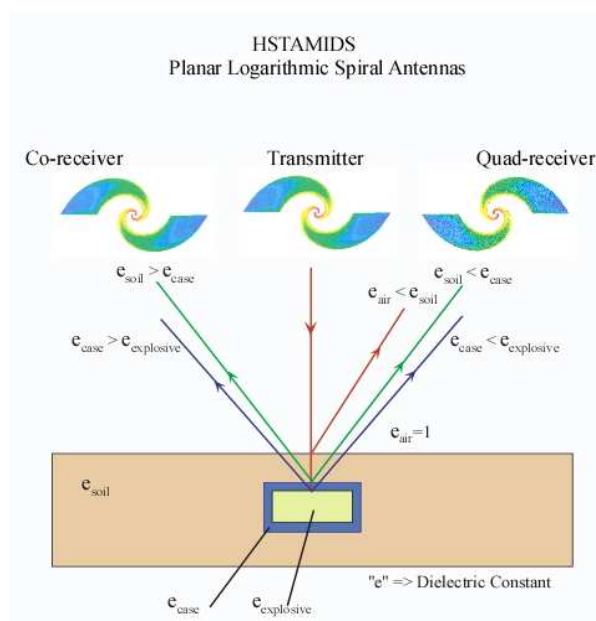

Fig. 8.2 Antenna geometry for AN/PSS-14

Receiver antennas are doubled so that one receive valid alert and false alert will be sensed by the other antenna. The EU houses both the radar generating and processing electronics. HSTAMIDS continuously sends radar signals down into the ground and then receive & analyzes the reflected signals. When the radar wave transmitted by the

transmitting antenna strikes irregularity such as landmine, rock, pipes, cables etc. a part of it gets reflected back to the receiving antennas.

A soil scatter study has to be done before operating HSTAMIDS in field. Here operator performs an initial training sequence over a cleared ground similar to the area to be searched. The radar signals (called soil scatter for that soil) measured are used as a ground model for that soil, which is used to filter out the soil scatter when the HSTAMIDS analyzes the reflected signals from soil to determine if an object is present.

APPENDIX D  
LabVIEW VIRTUAL INSTRUMENTATION

This Section illustrates the Virtual Instruments (VI's) used for the purpose of this research. The Virtual Instrument is a program that implements functions of an instrument by computer, sensors and actuators. This can be a program written in the LabVIEW or in other programming languages.

Here follows a brief description of VI's used for Spectral Frequency display program:

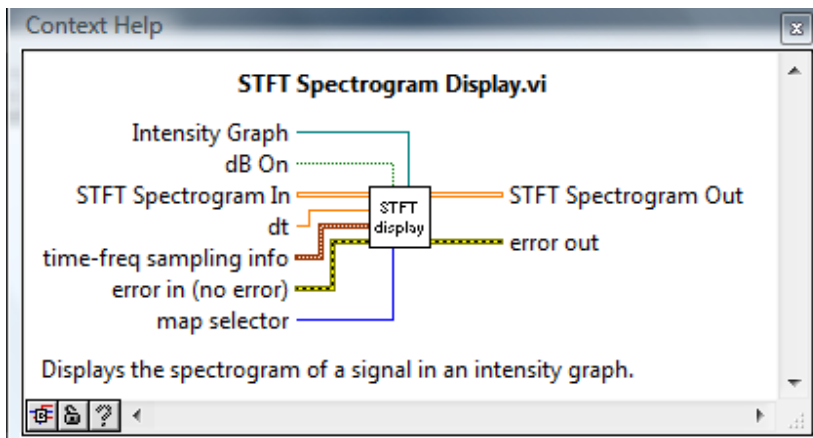
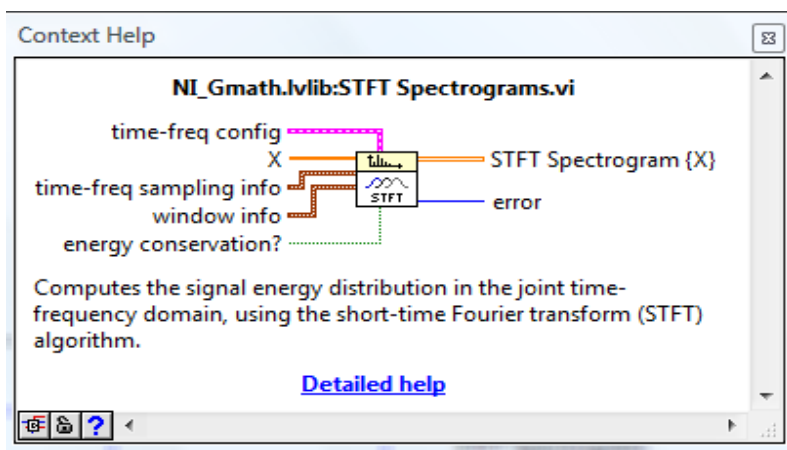

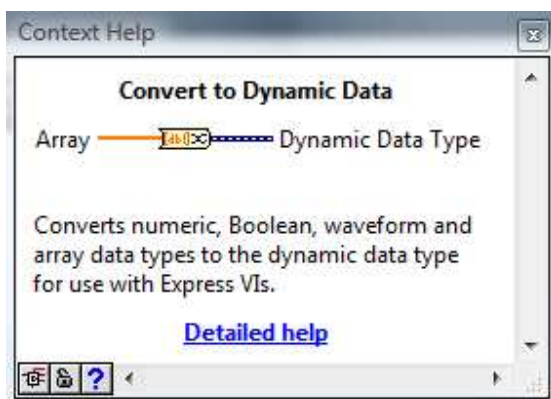
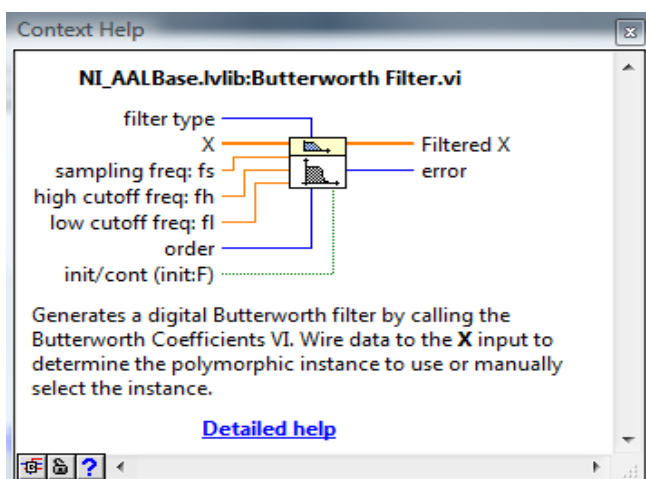
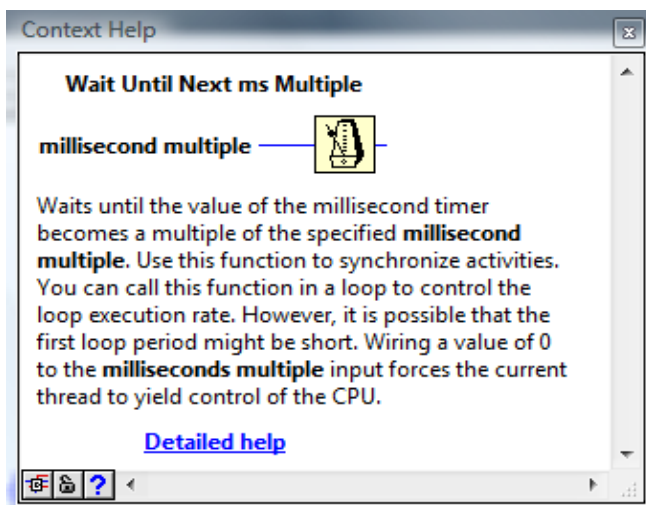

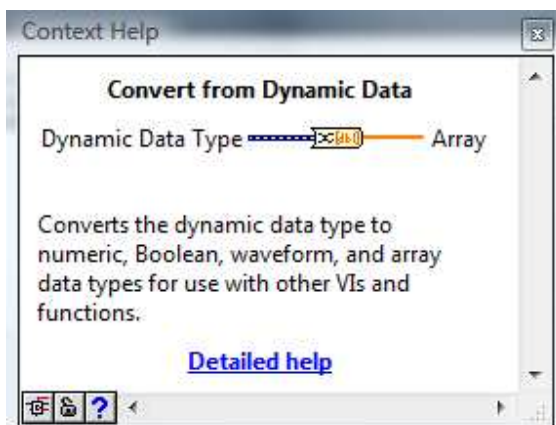
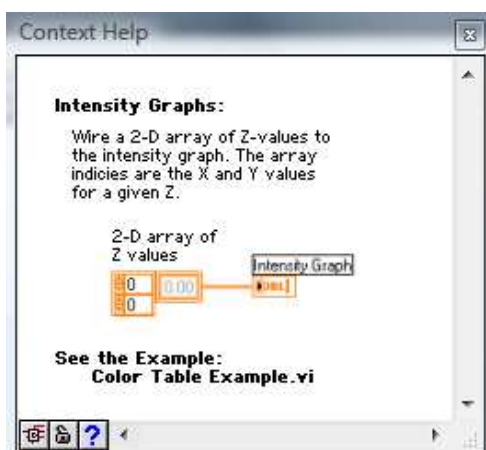
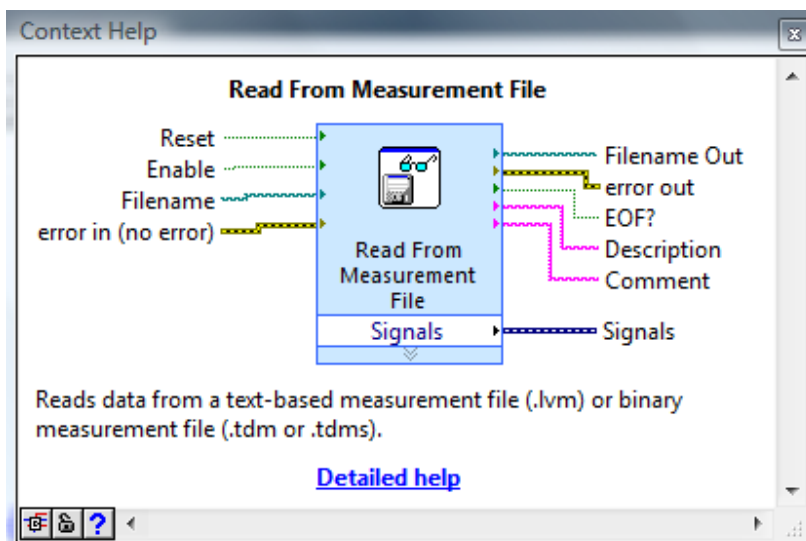

APPENDIX E

LabVIEW SPECTRUM FREQUENCY DISPLAY OUTPUT FOR MD ALONE, GPR  
ALONE AND MD+GPR COMPOSITE SIGNAL



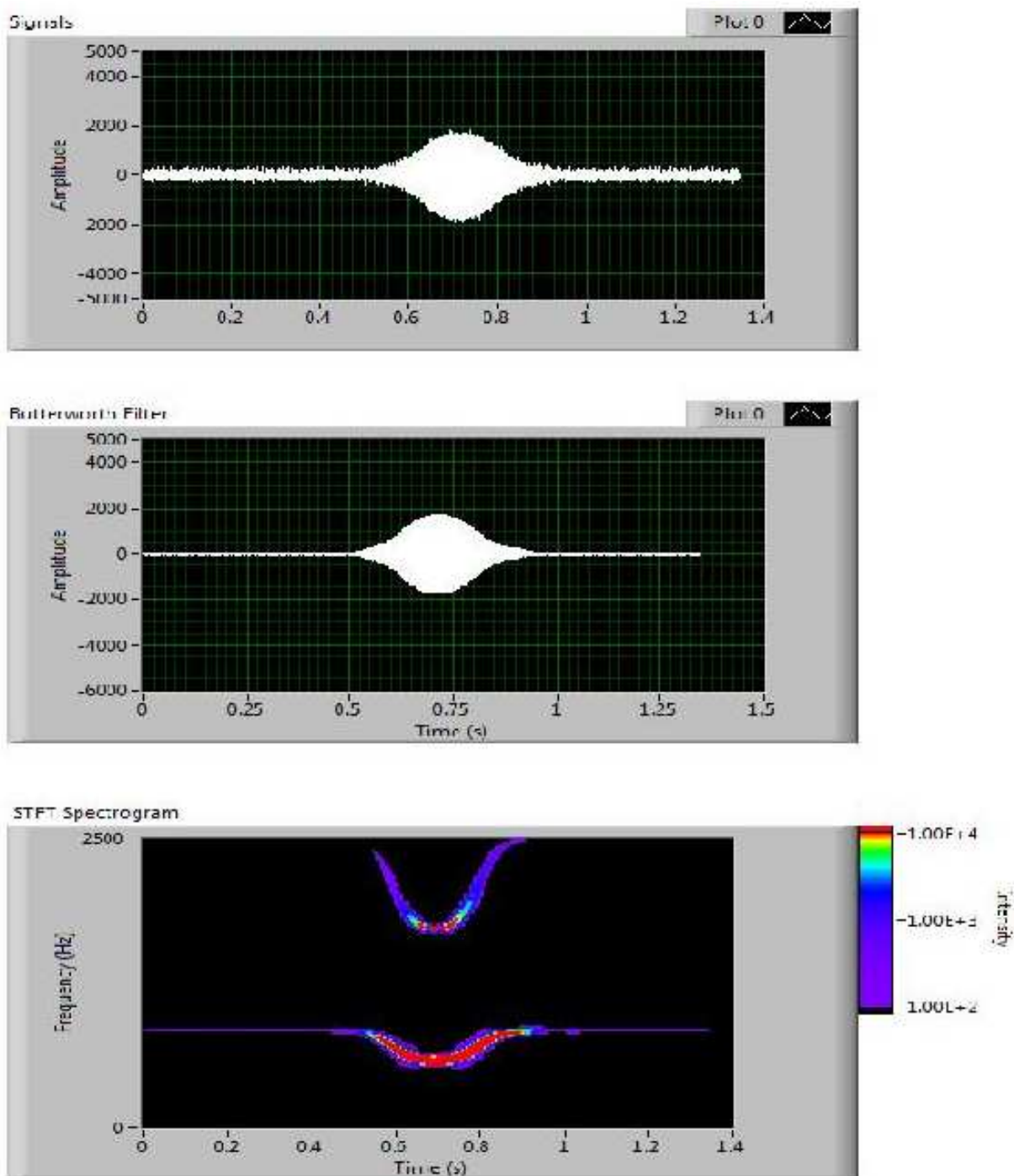

Fig. 9.1 Spectral Frequency Plot for MD Only Signal Obtained Using LabVIEW

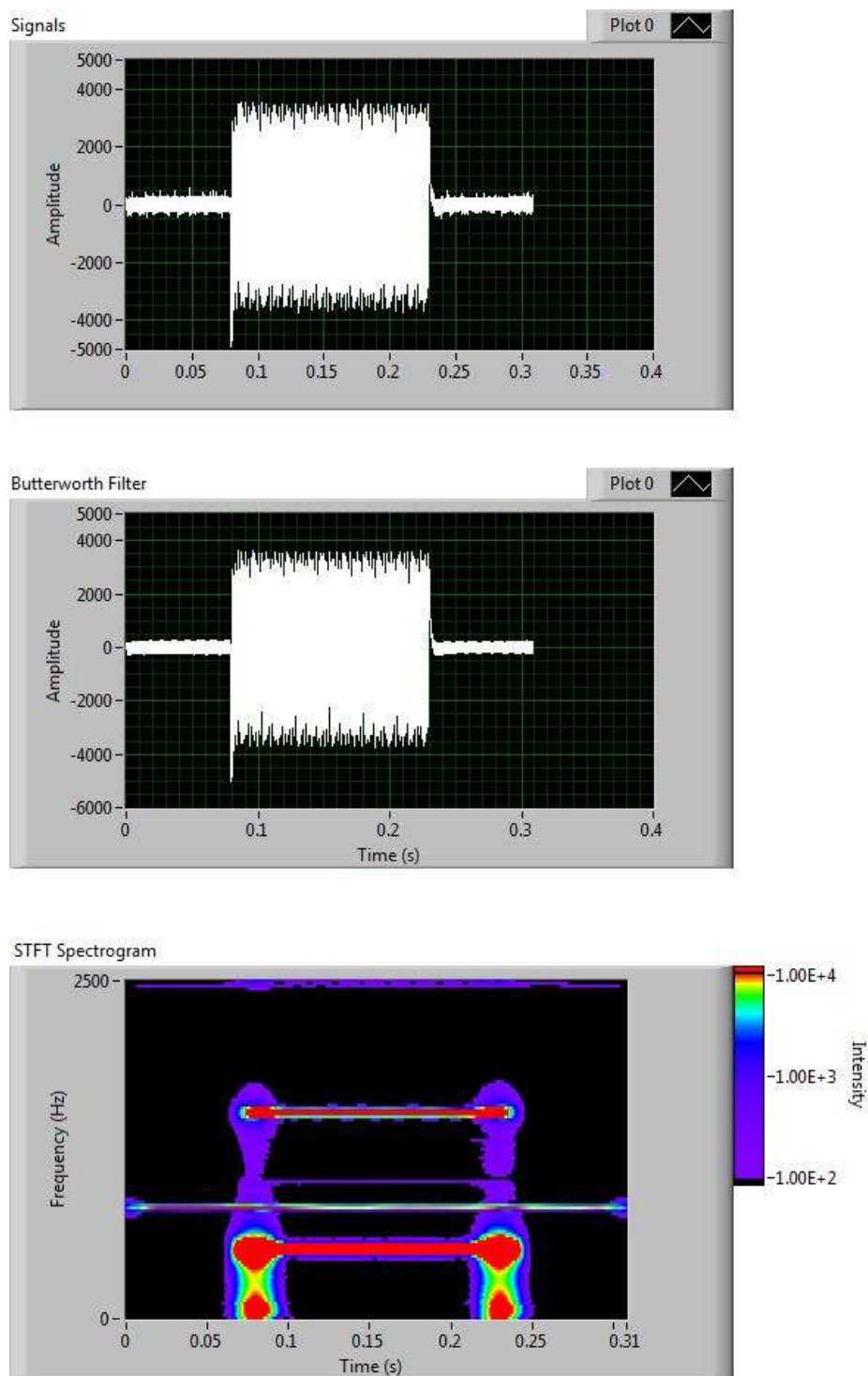
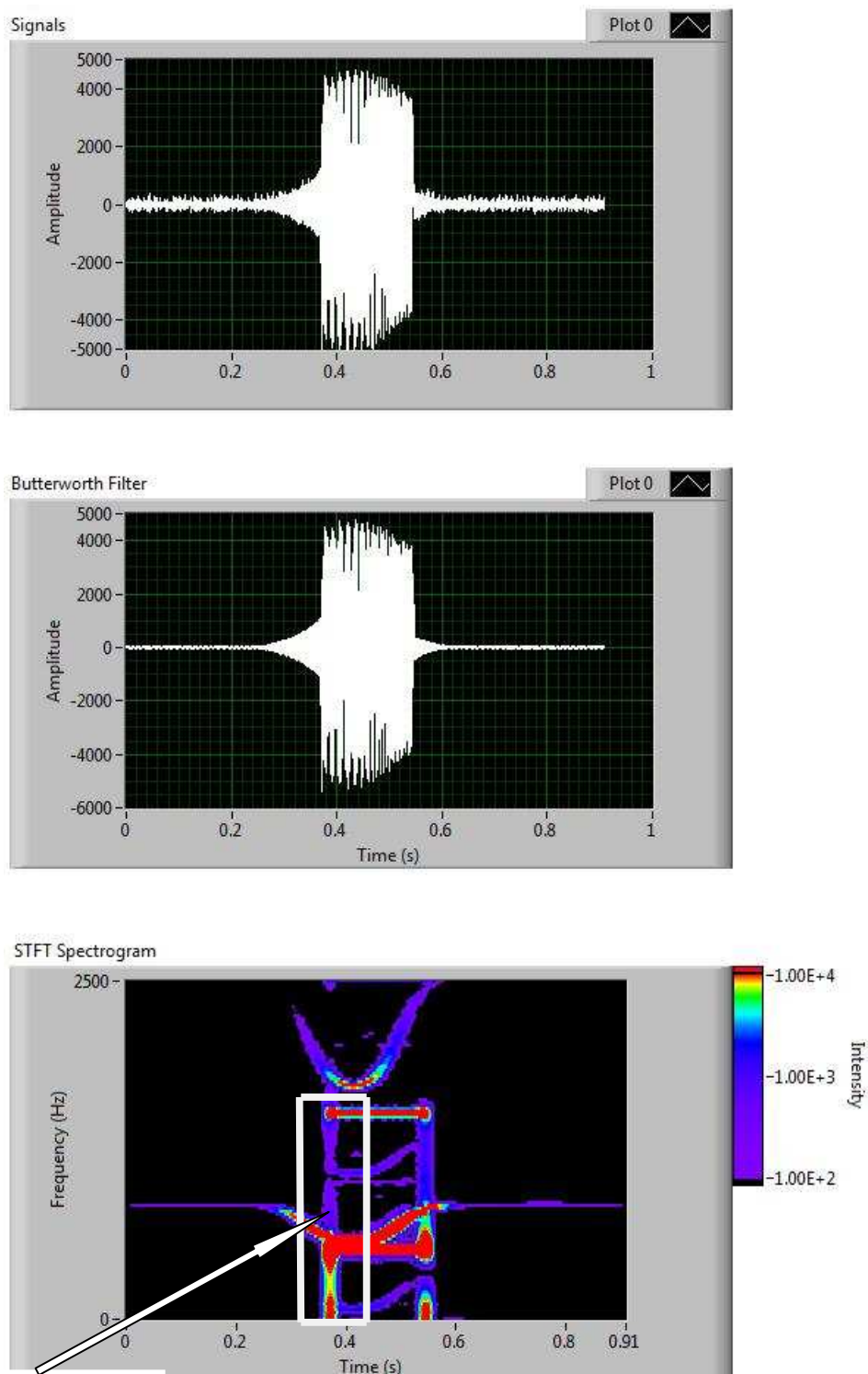

Fig. 9.2 Spectral Frequency Plot for GPR Only Signal Obtained Using LabVIEW



Validation  
zone

Fig. 9.3 Spectral Frequency Plot for Valid MD+GPR Signal Obtained Using LabVIEW

**BIBLIOGRAPHY**

- [1] Rob Siegel, "Land Mine Detection," IEEE Instrumentation & Measurement Magazine, Vol. 5, No. 4, Dec. 2002.
- [2] Todd R. Higgins, James Staszewski, Herman Herman, Virgil Flanigan, Olga Falmier, and Robert A. Hancock, "Warfighter Research in Mine Detection: Improved Clutter Rejection with the AN/PSS-14," Land Mine Detection Research Center Report, Lincoln University, Oct-2008.
- [3] Dr. Virgil Flanigan, Dr. Richard Rechten "A Report on Investigation of AN/PSS-14(HSTAMIDS) GPR Wave field Interactions with Buried Dielectric Targets," March 2009.
- [4] Esam M.A. Hussein, Edward J. Waller, "Landmine Detection: The Problem and the Challenge," Applied Radiation and Isotopes, Volume 53, pp. 557-563, 2000.
- [5] Arthur E Barnes, "When The Concepts of Spectral Frequency and Instantaneous Frequency Converge" The Leading Edge; v. 12; no. 10; p. 1020-1023, October 1993.
- [6] PSS-14 Instruction Manual.
- [7] "Frequency Spectrum,"-[http://en.wikipedia.org/wiki/Frequency\\_spectrum](http://en.wikipedia.org/wiki/Frequency_spectrum), January 10, 2010.
- [8] <http://www.cytterra.com/products/handheld-cm.html>, February 8, 2010.
- [9] <http://www.the-monitor.org/index.php/publications/display?url=lm/2005/maps/problem.html>, March 6, 2010.

## VITA

Kolekar Nitin Sonapa born January 1982, earned his BE (Mechanical Engineering) from Shivaji University, India in 2003. The current research is towards M.S. (Mechanical Engineering) at Missouri S&T which will be earned in December 2010.

Nitin taught Mechanical Instrumentation and Mechanical Systems Labs as a GTA at Missouri S & T. After earning Bachelor's Degree he worked for Indian Space Research Organization for three and half years as a Design Engineer.