

© Copyright 2012
Heather Ruszczyk

Curating the Interstice: Exploiting the urban gap phenomenon in Kobe, Japan

Heather Ruszczyk

A thesis
submitted in partial fulfillment of the
requirements for the degree of:

Master of Architecture

University of Washington
2012

Committee:
Ken Tadashi Oshima
Robert Hutchison

Program Authorized to Offer Degree:
Architecture

Contents

List of Figures	ii
Acknowledgements	iv
Introduction	1
1. Change	3
1.1 <i>Changeable v. Unchangeable</i>	
1.2 <i>Understanding changeable Japan</i>	
1.3 <i>The past</i>	
1.4 <i>The present</i>	
1.5 <i>The products of change</i>	
2. Gaps	13
2.1 <i>Defining gaps</i>	
2.2 <i>Ma and the 'Pregnant Void'</i>	
2.3 <i>Gaps in contemporary urban space</i>	
2.4 <i>Gaps as fluid space</i>	
3. Kobe	21
3.1 <i>Kobe overview</i>	
3.2 <i>Motomachi</i>	
3.3 <i>Sakaemachi</i>	
3.3 <i>Kobe's gaps</i>	
4. Gap Analysis	33
4.1 <i>Forty-eight Gaps</i>	
4.2 <i>Sectional Rhythm</i>	
4.3 <i>Gap Evolution</i>	
5. Curating the Interstice	43
5.1 <i>Defining Art Site Sakaemachi</i>	
5.2 <i>Precedent Study: Naoshima</i>	
5.2 <i>Process and Program</i>	
5.3 <i>Construction System</i>	
6. Art Site Sakaemachi	53
6.1 <i>Identifying the Gap</i>	
6.2 <i>Preparing the Gap</i>	
6.3 <i>Occupying the Gap</i>	
6.4 <i>Experiencing the Gap</i>	
6.5 <i>Maintaining the Gap</i>	
7. Conclusion	71
Bibliography	72

Figures*

1.1	Changeable city (Tokyo)	4
1.2	Drawing of Kamo no Chomei's 10 square foot hut (Source: ukiahcommunityblog.wordpress.com)	5
1.3	Japanese joinery detail (source: Seike)	6
1.4	Floating foundation at Katsura Rikyu	6
1.5	Building cut off by elevated Yamanote Line, Yoyogi, Tokyo	7
1.6	The Unfinished City: A section of an unfinished elevated roadway, Kyoto	7
1.7	Elevated networks in Shibuya, Tokyo	7
1.8	1945 Carpet bombing over Kobe (Source: http://ww2db.com/image)	8
1.9	Parcel map demonstrating the lack of pretermind division (Source: Tokyo Metabolizing)	8
1.10	'Scrap and build' (Source: Tokyo Metabolizing)	9
1.11	Metabolist visions: Isozaki's 'Cities in the Air' (Source: Isozaki)	9
1.12	Typical street facade of gaps, Ueno, Tokyo	10
2.1	Diagram of a gap as the implied space between two defined things	14
2.2	Kiwari proportions in the plan of Yoshimizu Shrine (Source: Inoue)	15
2.3	Engawa at Katsura Rikyu	15
2.4	Concentric kairo in the plan of Ise Shrine (Source: Isozaki)	15
2.5	Movement space and the 'flying geese' plan of Nijo Castle (Source: Inoue)	15
2.6	Modern ambivalence: elevation highway built over an existing warehouse in Nagoya	16
2.7	Urban patterns in Kobe, Seattle, and Rome	17
2.8	Historical axes in aerial view of Piazza del Popolo, Rome	18
2.9	Typical urban grid in Seattle	18
2.10	Lack of historicism in aerial view of Shibuya, Tokyo	18
3.1	Map of Japan	22
3.2	Map of Kobe	22
3.3	Map of Motomachi	22
3.4	Kobe in ruins after 1945 air raid (Source: http://ww2db.com/image)	23
3.5	Kobe in ruins after 1995 earthquake (Source: http://www.auick.org)	23
3.6	Detailed map of Motomachi	24
3.7	Typical building form	26
3.8	Examples of odd building form in Kobe	26
3.9	Gap typologies	29
3.10	Typological appendix	30-31
4.1	Forty-eight gaps	34
4.2	Map of Motomachi	35
4.3	Site sections	36
4.4	The average gap	37
4.5	Typical use depending on width	37

* All figures are original works by the author, unless otherwise noted.

4.6	Detail of two gaps in Sakaemachi	38
4.7	Sakaemachi's gap evolution	39
4.8	Sakaemachi dori (1931) (Source: Kobe City Museum)	40
4.9	Sakaemachi dori (1991) (Source: Kobe City Museum)	40
4.10	Sakaemachi dori (2001) (Source: Kobe City Museum)	40
5.1	Otsunaka dori, Sakaemachi	44
5.2	Map of Naoshima (Source: www.benesse-artsite.jp/en/)	45
5.3	Site specific installation: Go'o Shrine on Naoshima, Hiroshi Sugimoto (Source: Insular Insight)	45
5.4	Teshima Art Museum, Ryue Nishizawa (architect) and Rei Naito (artist) (Source: Insular Insight)	45
5.5	Sakaemachi	46
5.6	Art Site Sakaemachi	46
5.7	Art Site process	47
5.8	Three installation spaces in Art Site Sakaemachi	48
5.9	Central facility in Art Site Sakaemachi	48
5.10	Art Site Sakaemachi (6 months later)	49
5.11	Art Site Sakaemachi (5 years later)	49
5.12	Art Site components and construction system	50
5.13	Scaffolding as neither solid nor void (Source: archdaily.com)	50
5.14	Scaffolding conforming to unique form (Source: archdaily.com)	50
6.1	Gap #46 Elevation and sky	54
6.2	Gap #24 Elevation and sky	54
6.3	Gap #12 Elevation and sky	54
6.4	Gap #46 Existing conditions	55
6.5	Gap #24 Existing conditions	56
6.6	Gap #12 Existing conditions	57
6.7	Gap #46 Plan and section	58
6.8	Gap #46 Prior to installation	59
6.9	Gap #24 Plan and section	60
6.10	Gap #24 with artist's perch	61
6.11	Gap #12 Plan and section	62
6.12	Visitors experience in Gap #12 with curator's intervention and artist's installation	63
6.13	Gap #16 Plans	64
6.14	Otsunaka dori and storehouse rendered in Gap #16	65
6.15	Gap #16 Sections	66
6.16	Section perspective of storehouse in Gap #16	67
6.17	Use of scaffold to create artist's perch in Gap #24	68
6.18	Use of scaffold for a ramp in Gap #12	68
6.19	Tectonic axonometric of storehouse in Gap #16	69

Acknowledgements

To all those who grew my curiosity in Japan and helped me to find my way back to that wonderful place.

To my advisors, Ken Oshima and Rob Hutchison, for their continued support throughout this process and for their enthusiasm and confidence in this project.

Lastly, to my loving family and friends for always supporting the next adventure.

Introduction

Many great cities in the world respond to the demand for change through careful growth, preserving the past through selectively choosing what stays and goes. In other places, regulatory standards and zoning maintain a consistency in the urban fabric, preserving a character or identity for a city over time. Cities in Japan respond to change differently. Lacking any predetermined urban form, independent buildings and infrastructures simultaneously mingle in a consistently evolving reaction to one another.¹ Further, the average lifespan of a building in Japan is 26 years, suggesting a high turnover in the architecture which comprises the grain of Japanese cities.²

One of the most significant effects of this rapid rate of change in Japan is the presence of gaps in the urban fabric. Left-over fragments, holes within infrastructure and narrow voids between buildings are some of the most common features of the Japanese urban landscape. Often overlooked as insignificant voids, gaps are essential to understanding Japanese urban space beyond its a-historical form and apparent chaos. Recalling the concept of void as an essential value in Japanese spatial theory, these interstices reestablish a spatial and temporal order in urban placemaking in Japan. They are therefore worthy of documentation and elevation as valued urban forms.

This project delves into the gaps of Kobe, Japan to understand the value of this spatial phenomenon and its implied relationship with the rapidly changing landscape over time. This thesis engages with the gaps in the Sakaemachi neighborhood of central Kobe as representative spaces of change, addressing the issues of temporality, questioning the void as a negative space, and offering a proposal to exploit the gap. This project envisions Sakaemachi's gaps as a collection to be curated, creating an infrastructure that supports this network of gaps as an 'art site', filling them with temporary site-specific installations and inviting the public to transgress the void.

1 Kitayama, 35

2 Japanese Ministry of Internal Affairs and Communications

1. Change

“The flowing river never stops and yet the water never stays the same. Foam floats upon the pools, scattering, re-forming, never lingering long. So it is with man and all his dwelling places here on earth.”

-excerpt from Kamo-no-Chomei's 'Hojoki'

1.1 Changeable v. Unchangeable Cities

There are many ways to classify cities. One is to measure their rate of change, meaning a city's ability to adapt to new demands resulting from changing values, growing population, political division, and economic pressure. A rate also suggests a relationship with time. While some cities depend on planning to unfold their future at a slow and predictable pace, others organically develop themselves at a rapid rate. The difference is therefore drawn between cities that resist change and those that embrace it; changeable versus unchangeable.

Changeable cities exhibit a rapid rate of change. In Japan, a historically cyclical pattern of destruction and rebirth constantly regenerates cities like Tokyo, Osaka, and Kobe. Megalopolises in China like Shanghai and Guangzhou, develop and redevelop, fueled by a rising GDP. In South East Asia and the Subcontinent, Bangkok and Mumbai are reshaping themselves due to improved infrastructure and changing industries. South and Central American cities like Rio de Janeiro and Mexico City grow rapidly both formally and informally as gentrification and urban migration increase. Although change in these cities is marked by similar physical characteristics, the origin of change is unique in each place, and in most cases, it is a modern phenomena.

Unchangeable cities exhibit a slow rate of change. In Europe, Paris and London are established under an identifiable and historically generated form. Cities in the United States, like Seattle, exhibit more predictable patterns of adapting to change through planning and policy, which generally follow a slow and drawn out bureaucratic process. Perhaps the epitome of the unchangeable city is Rome, which stifles change through embracing the past in favor of the future. The unchangeable city has a higher degree of permanence and a varying set of values, lacking the spontaneity and improvisation of those places deemed changeable. It is often understood through its clear relationship between urban form and historical context.

1.2 Understanding Changeable Japan

From an ideological point of view, the changeable conditions that exist in Japanese cities are unique from other changeable cities. Change is a value rather than a modern phenomenon. Its widespread influence and continued cycle is sustained by a deeply ingrained attitude towards accepting change as inevitable based on the specific socio-historical context of pre-modern Japan.¹ Modern Japan inherited this outlook after 1868 with the Meiji Restoration. Change became an even more persistent force as western politics and society superimposed new values and technologies on traditional

¹ This refers to Japan prior to 1868 or the Meiji Restoration, which was Japan's starting point of modernity and western influence.



Figure 1.1 Changeable city (Tokyo)

ways of life. The landscape of Japan evolved from feudal agrarianism into growing urban and industrial centers. But even in its modern state, Japan could not escape its own fate as a country prone to disaster. In 1923, The Great Kanto Earthquake devastated the entirety of Tokyo. After recovering, only twenty years later, Tokyo and other cities throughout Japan were severely damaged by carpet bombing during World War II, creating a tabula rasa for a new city. Perhaps the forces that shape the city today are less dangerous, but they are no less destructive in terms of perpetuating the 26 year life cycle of a building in Japan. Under this rapid cycle of change, not only the individual architecture of the city regenerates, but urban form itself is constantly morphing. This suggests a moveable foundation for the city that while shifting and readjusting itself, creates odd-spatial by products and numerous gaps in the urban fabric. A brief analysis of the pre-modern causes and modern conditions are requisite in understanding changeable Japan and perceiving the city beyond its cover of chaos.

1.3 The Past

Many of the values and ideals of present day Japan find their origin in the Japan of the past. Tired of the tribulations of 12th century life in the capital, Kamo-no-Chomei, a Buddhist monk and poet, committed his life to hermitage where he wrote of the 'precariousness of man and his property'² from his minimal ten square-foot mountain hut. His account, *Hojoki*, offers valuable insight to the changing conditions of early Japan due to the cycles of destruction and rebirth that fatefully governed the lives of Japanese people. In its pre-modern state, Japan was consistently in flux due to shifting political boundaries, civil war, and natural disaster. Kamo-no-Chomei describes the relentless torment of destruction as

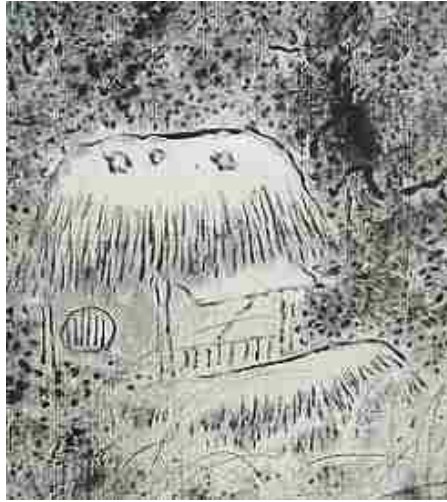

Figure 1.2 Drawing of Chomei's 10 square foot hut

'freakish' suggesting that Japan was cursed by misfortune.³ This historical conditioning of a country prone to cycles of stability and instability, disaster and recovery; would inevitably impact modern Japanese urban form and the Japanese way of building.⁴

Buddhist philosophy generally teaches that existence in the material world consistently fluctuates between cycles of destruction and rebirth. This way of thinking suggests a cyclical rather than linear view of time and also guarantees a sense of impermanence or *mujo*, one of Buddhism's primary values regarding existence. As a doctrine, it encourages an acceptance of the inconsistency and transience of the material condition through emphasizing the values of emptiness, perishability, and incompleteness. *Mujo* describes a simultaneous 'gentle sadness' at the passing of things while recognizing their loss as inevitable. Like the sakura tree during hanami, the Buddhist notion of destruction, rebirth and cyclical time not only guarantees change but promises renewal, explaining a seeming ambivalence in the Japanese character towards rapid change resulting from loss.⁵ The material objects of the built environment today are perhaps less symbolic than *hanami*, but they too, are swept away by cycles of destruction and rebirth in a regular fashion without regret due to the transience of materiality and the modern fascination with novelty.

Physical displacement was a common occurrence in Imperial Japan. Between the Nara and Heian period, the Imperial court ordered the moving of the capital three times over the short span of one hundred years. A detachment between physical structure and physical place is presented in the image of floating the entire capital down the river, a practice found in multiple accounts of Middle Japan. Tanizaki quotes from an old folk saying: "...the brushwood we gather--stack it together, it makes a hut; pull it apart, a field once more."⁶ This adage describes deconstruction and reconstruction as coolly as 'stacking it together' and 'pulling it apart'. The sense of impermanence (*mujo*) and disposability is undeniable, predicated by Buddhist ideals emphasizing a disconcert with the things of the past replaced by an awareness of the present.

Dislocation was also common in feudal Japan, a 700 year period that fluxuated between periods of stability and intense civil war. Feudalism guaranteed a perpetual cycle of peasant upheaval and revolt, rise and fall of various militant clans, division among classes, and fractured geo-political boundaries. These particular historical conditions necessitated an architecture that was light and could be deconstructed easily, or at least have the appearance of it. Writing on *The Art of*

3 Hojoki, 40

4 Stewart, 181

5 Suzuki, 343

6 Folk saying, quoted by Tanizaki

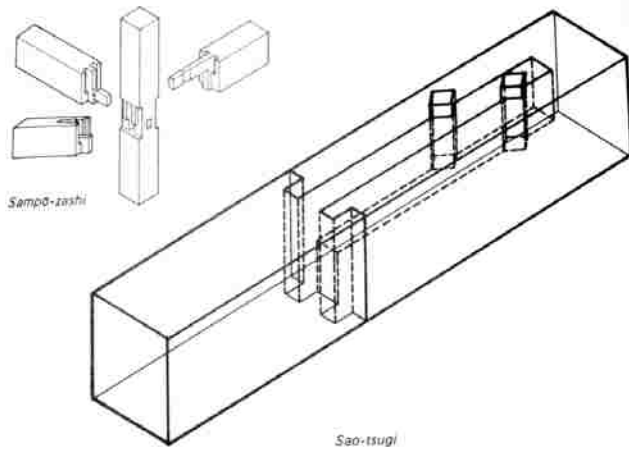

Figure 1.3 Japanese joinery detail



Figure 1.4 Floating foundation at Katsura Rikyu

Japanese Joinery, Kiyoshi Seike describes this transition in architectural ideology: “The increasingly far-reaching effects of the incessant civil war of that period included both the destruction of a great many imposing older buildings and a shift from the earlier massive structures to equally pleasing styles that were easier and less expensive to construct, or reconstruct, as occasion demanded.”⁷ This led to the development of the *Shoin-zukuri* style of architecture in the 16th century which reflected a reduction in the size, proportion, and frame of palatial and villa architecture, the architecture of the ruling classes. Even foundations were floating, reduced to a column carefully balanced on a rough hewn stone, as if it had been found that way in nature.⁸

While war and politics caused instability in early Japan, perhaps the greatest foe of permanence was natural disaster. Earthquake, tsunami, and typhoon are frequent occurrences in Japan due to its location on active fault lines and its position as an ocean-exposed island nation. There has always been an imminent sense of disaster in Japan with a total of 1,500 earthquakes occurring every year. Tsunami also posed an unpredictable threat to coastal Japan and the recent disaster in Tohoku serves as a reminder of the devastating effects of these powerful forces. These natural forces imposed nonnegotiable demands for change as entire cities were susceptible to instant and unpredictable destruction. While building methods improved over the years through advanced wood construction techniques, the only guaranteed response to disaster in early Japan was to rebuild, contributing even more to the value of a ‘pick up take away’ culture.^{9 10}

Change resulting from natural disaster is perhaps the most long-standing cycle of destruction and renewal that continues to demand physical changes in Japan today. Still, perhaps the greatest destructive force in early Japan was fire. While modern Japan is largely built from concrete, the materiality of pre-modern Japan was wood. As Japan’s most abundant natural resource, wood was a logical choice for building. Traditional construction methods based on the inherent material properties of wood developed synchronically with a spiritual notion of the material and its deep connection to nature. In effect, the materiality of pre-modern Japan enabled a direct relationship between a way of building and a way of thinking. It also influenced an attitude towards preservation that was based on the natural cycle of destruction and rebirth, rather than an idea of permanence. Wood is an impermanent building material prone to deterioration, rotting, infestation, and as already noted, fire. Many great civilizations built of stone and brick are preserved through their materiality like Rome, whose ancient structures made of stone still stand today as monuments of the past. Inevitably,

7 Seike, 15

8 Contrary to Seike’s description, however, these new buildings were far from simple or inexpensive to construct and only have the appearance of simplicity and austerity, those revered aesthetic ideals of Zen Buddhism.

9 Stewart, 190

10 This is an idea that would later be adopted by the Metabolists, an influential architectural movement in Japan, in the 20th century.



Figure 1.5 Building cut off by elevated Yamanote Line, Yoyogi, Tokyo



Figure 1.6 The unfinished city: A fragment of a new elevated roadway cutting through Kyoto

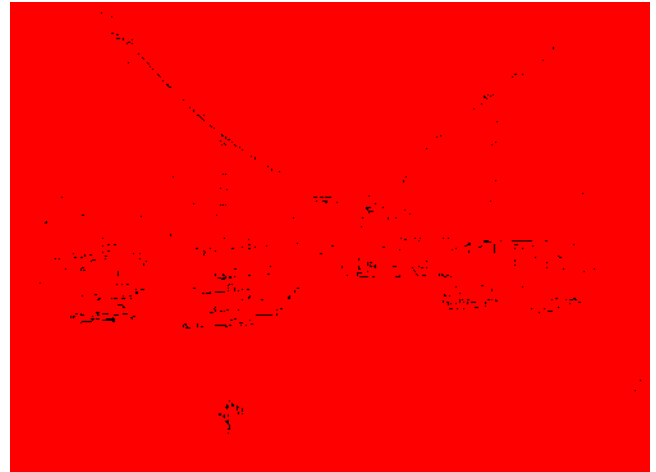

Figure 1.7 Elevated networks in Shibuya, Tokyo

traditional buildings in Japan have a shorter lifespan than those of other civilizations, although perishability as a value in Japanese architecture is not always literal, as Keene points out that the oldest wooden building in the world is Horyu-ji in Nara which is an impressive 1,200 years old.¹¹ While the material of modern Japan has shifted based on technology, availability and preference, concrete buildings whose material properties contrast with wood, are treated with an ingrained perception that they too are disposable, perishable, and impermanent.

Traditional religious values, feudal political systems, and materiality developed a pre-modern way of building and thinking that linked spiritual ideals towards dwelling and their physical ability to accommodate situational change. These themes developed an early idea that the physical objects of the built environment are impermanent, perishable, and inevitably bound to a cycle of destruction and rebirth. Understanding past values give a historical frame of reference to the acceptance of rapid change reflected in the built environment of modern Japan, setting the stage for modern Japan's changeable condition and 'scrap and build' mentality, a force that largely influences urban form today. It also explains an attitude towards preservation based on a cycle of destruction and renewal rather than museumification.

1.4 The Present

It is common knowledge that in Japan, space is limited. The entire country of Japan, a relatively small land mass, has a population of 127 million people. Roughly fifty percent of the population is concentrated on two percent of the land area in large sprawling megalopolises on the fringes of the islands due to the geographic restrictions of a mountainous

11 Keene, 297. Reference to the Byoid-in in Nara

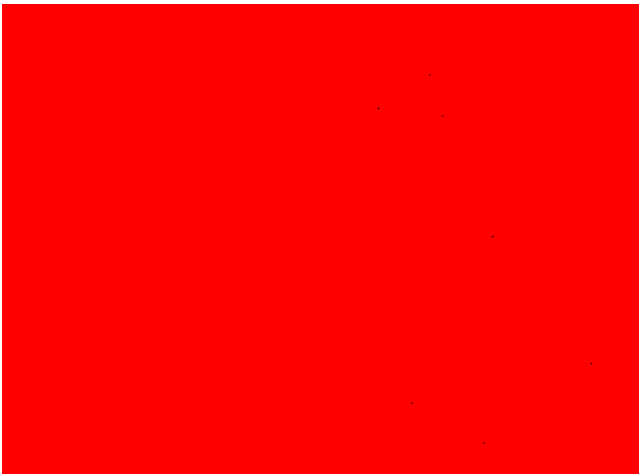

Figure 1.8 1945 Carpet bombing over Kobe, resulting in a tabula rasa for the city



Figure 1.9 Parcel map demonstrating the lack of predetermined land division

topography.¹² Because of these spatial restrictions and consequently high land prices in Tokyo and other cities like Kyoto, Osaka, and Kobe, value is placed on land itself rather than on what is built upon it. This fact alone creates a situation where the built environment is simply expendable. But there is another slough of reasons for this attitude based on lack of land use policy, loose building regulations, and infrastructure. The effects of these 20th century inventions have shaped the changeable urban form that exists in Japanese cities today.

Increasing population and urban migration in the early 1920's called for the new City Planning Law and Urban Buildings Law, which proposed land use, zoning, and a reasonable model for urban growth. However, the central government emphasized infrastructure expansion over urban planning and the reality of this neglected early civil code was vague zoning regulations and land subdivision into individual parcels as a means of controlling sprawl.¹³ Under this system, which still exists today, parcels are governed by a number of loose laws and strict taxes, including an inheritance tax on property acquired through family will.¹⁴ As property value appreciated approaching the bubble economy, those acquiring land could not afford the high inheritance tax, initiating a trend of sub-dividing individual lots. The size of a typical lot in a Japanese city, particularly Tokyo, decreased while the number of individual property owners increased. Today, Tokyo's 1.8 million homeowners have created a 'democratic' city in the sense that individual propriety outweighs municipal ownership of the majority of urban space.¹⁵

Subdivision of land and individual ownership of the one-plot one-structure system has created a pixilation of 'self-generating grains', as described by Yoshiharu Tsukamoto in *Tokyo Metabolizing*, a research project documenting Tokyo's urban change.¹⁶ Each structure, as a standalone object, is easily detached and replaced by something new without disruption to the function of the city, an idea reminiscent of pre-modern Japan's deconstructability and law of impermanence. It also resonates with Metabolist ideals from the 1960's which envisioned architecture as self-contained replaceable capsules.¹⁷ The ease of interchangeability between old and new in addition to appreciated land value (not building value) is the foundation for the 'scrap and build' culture in Japanese cities. Under this pretense, buildings are thrown away rather than preserved and the outcome is a landscape that is constantly being reconstructed, capitalizing on the Japanese preference for newness.¹⁸ With an average life span of 26 years, the structure itself may die, but something is always

12 CIA World Factbook

13 Sorenson, 116

14 Kitayama, 50

15 Kitayama, 52

16 Tsukamoto, *Made in Tokyo*, 31

17 This reference to metabolism is minus the grand planning schemes envisioned by these capsules attached to a mega-structure, a core which functioned as a comprehensive infrastructural and organizational element for the city.

18 Newness is a modern phenomena, an idea from and reflected the consumptive attitude of the 'bubble' years.



Figure 1.10 'Scrap and build'

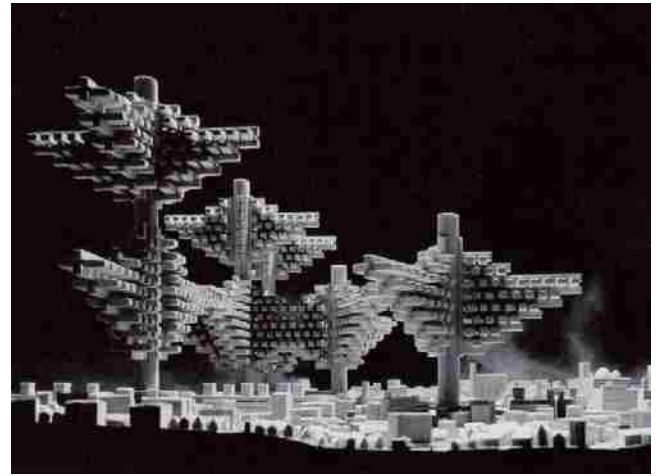

Figure 1.11 Metabolist visions: A city of replaceable parts-Isozaki's 'Cities in the Air'

built in its place: the city is instantaneously regenerated. Renewal is natural in this cycle of land acquisition, destruction, division, and construction. As the urban fabric regenerates and changes, the individual grains conform to new changes and conditions. Further, because of the sub-division, the regenerated form of the city always differs from its pre-existing condition due to shifting property lines.

While loose planning policy generates an awkward fragmentation of urban land, an equally loose set of building regulations and land use govern individual sites. Kitayama explains, "Each plot is subject to a variety of building regulations, but as long as these rules are obeyed, the owners have the right to build any type of structure they desire."¹⁹ Sorenson suggests that loopholes in essentially non-existent policies have created an unrestricted combination of uses within one site or in adjacency. Residential, industrial, and commercial activities are undifferentiated.²⁰ Therefore, despite the bird's eye view of homogeneity, Tokyo, Kobe, and other Japanese cities, are highly individualized. General discontinuity in the urban fabric is further interrupted by a civil code which regulates a minimum fifty centimeter setback between adjacent buildings resulting in a significant number of 'gaps' and in-between spaces in Japanese cities.²¹ These awkward fragments of leftover spaces amount to a significant number of voids in the urban fabric. Essentially, they exist between every structure. In actuality, they vary in size from the required minimum to as much as ten feet. What might be seen as unusable space is instead often an opportunity for extreme forms of infill in terms of size, resulting in a number of 'gap buildings', characterized by a narrow width or small awkward shape. Gaps between buildings exist everywhere, in addition to a variety of gap architecture. Arguably, these gaps are the single most ubiquitous phenomenon in the urban form of Japanese cities.

Besides micro-architecture and haphazard housing, infrastructure is Tokyo's other defining feature. Early urban expansion was largely dictated by rail, subway, and highway development in the 1950 and 1960's. Today this network continues to grow according to the changing needs of the city. Due to lack of land and organic expansion of infrastructure, many roadways and train lines are elevated above the city or buried underground. Above ground, nearly twenty train lines and one hundred miles of elevated highways snake through Tokyo creating a large number of gaps between architecture and infrastructure.²² These gaps are reconciled by a new type of infill that engages the structure of infrastructure to create useable space. Nango says, "The expressway yields formal deviations and residual spaces unthinkable in

19 Kitayama, 39

20 Sorenson, 112

21 The presence of these awkward voids coupled with the demand for space has led to a micro-grained 'pet architecture', a term coined by Atelier Bow Wow to describe the ingenuity in the use of leftover spaces. This informal architecture, driven by site restrictions and accommodating a variety of uses, begins to suggest a new vernacular for Japanese cities.

22 Tokyo Metropolitan Government

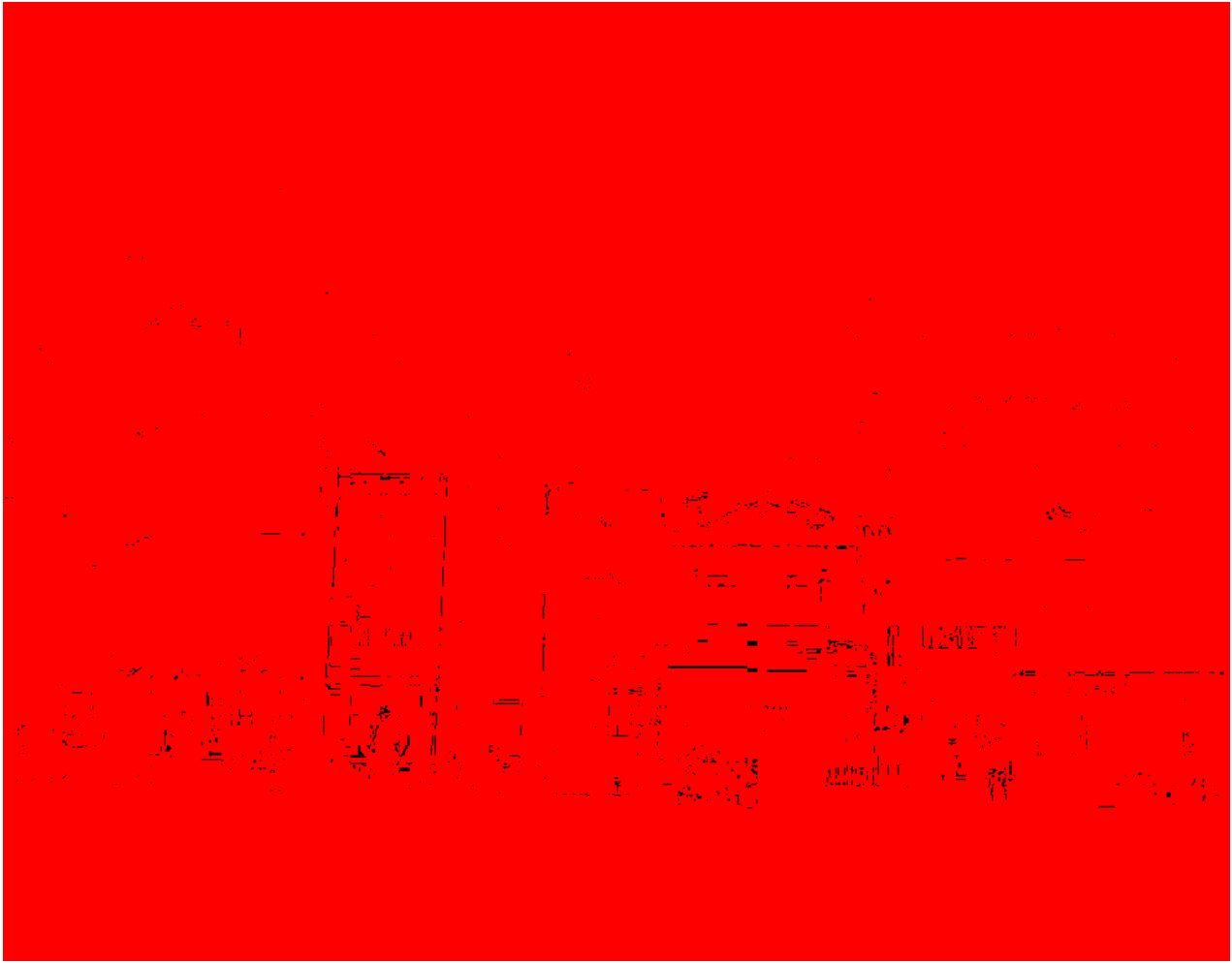

Figure 1.12 Typical street facade of gaps, Ueno, Tokyo

conventional architecture.”²³ This is the subject of *Made in Tokyo*, a comprehensive ‘guide book’ to Tokyo’s phenomenological buildings observed by Atelier Bow Wow in the mid 1990’s. Among these, the ‘shooting graveyard’ and ‘highway department store’ begin to suggest that the overlap between architecture and infrastructure engenders an unexpected relationship between a variety of users and uses. It also points to the absurdity of some of these spatial partnerships and shifts the emphasis from an issue of land (value, smallness, subdivision) to one of three-dimensional space. Based on the regenerative and experimental qualities of these architectures, and considering the set of relationships between spaces, users, and uses that has developed out of necessity, new potentials for creating spaces has emerged.

As a result of modern Japanese policy and infrastructure, a simultaneous morphology of the city is based on two factors: infinite fragmentation of land according to individual proprietors and the subdivision of space according to public ventures of infrastructure. These two conditions describe the city as an accumulation of spaces and gaps; awkward fragments which are constantly being filled, moved, shifted, connected—changed. Further, the 26-year life cycle of a building and the ‘scrap and build’ mentality result in a constant regeneration of both individual structures and the overall urban fabric.

1.5 The Effects of Change: Gaps in contemporary urban space

The origin of this rapid cycle of change finds its place in pre-modern Japanese values and historical patterns while today, this cycle is proliferated through planning, policy, and the accumulative nature of modern Japanese cities. Changeable

Japan is understood through these two contexts and when viewed as a cyclical phenomenon, concludes that urban space in Japan is never finished.

It is precisely this unfinished nature that creates an urban landscape that is constantly being regenerated. In this process of regeneration—construction and deconstruction; scrap and build—a significant number of gaps and in-between spaces appear in the urban fabric. Their physical form is often defined by small, dark, narrow, and vertical chasms between buildings demarcating a necessary separation between property at a mandated 18 inch minimum distance. Gaps are also holes between the structure of elevated roadways and rail lines that cut through the urban fabric. But they also exist as significant voids, marking a pause in the progression from the death of one building to the birth of the next and reflecting the effect of the average 26-year life cycle of a building in Japan. Over time, voids are filled, gaps shifted in a continuous morphology of the ever changing, unfinished city.

In many cities around the world, holes in urban fabric are a sign of change. In shrinking cities like Detroit and Baltimore, gaps are a sign of changing industry and represent vast amounts of underutilized land. In Seattle, vacant parcels are a sign of economic decline and land devaluation. Instead, gaps in Japanese urban space are characterized by a different scale, a different cause and a higher frequency. Further, when compared to the fabric of more ‘unchangeable cities’, like Seattle, party wall conditions characterize dense urban fabric which creates a continuous urban facade, free of the interstitial space that exists between every building in Japan. A party wall is generally defined as ‘a wall built on the boundary line of adjoining properties and shared by both owners.’ This is an urban property law diametrically opposed to the Japanese kenperitsu. This ambiguous threshold exists as a planar wall adjoining two properties, while the building gaps in Japan are ambiguous three-dimensional spaces that separate two properties.

Part mandate, part phenomenon, part cause and part effect; these gaps are arguably the single most defining feature of the Japanese urbanscape. The remainder of this study focuses specifically on gaps as a product of change and as a spatial value, questioning the significance and potential adaptive re-use of these ordinary urban spaces unique to Japan.

2. Gaps

Primitive peoples in general regarded space simply as an interstice and found it both wanting and disturbing; the term horror vacui accurately describes this phenomenon. Dark caves and deep chasms, the limitless ocean and the immeasurable heavens were objects of fear or of repugnance--or were at the least ignored.

Mitsue Inoue in 'Space in Japanese Architecture'

2.1 Defining Gaps

Up to this point, this study has identified gaps as the most significant product of change in Japanese cities. But what exactly is a gap besides a space that exists as a void in the urban fabric? Do these common spaces carry a greater meaning? Can they be seen as not only a by-product of rapid change, but as a value? This chapter focuses on the concept of a void in space making and its potential value.

There are many ways to understand the meaning of 'gap'. So far, this study has defined a gap as a leftover, fragment, void, negative, in-between, interstice. But a gap can also mean an absence, pause, lack, separation, disruption or limbo. In non-spatial terms, a gap might describe the unresolved reparation between two ideas such as the commonly referenced design/theory gap in architecture. As a temporal idea, it might represent a missing period of time due to war or disaster.

As a conceptual idea, we can identify a gap as a pause or interval between two things. Separate from a threshold, or a line that marks a physical separation; inside/outside, light/dark, human/nature, public/private, a gap is something with dimensionality. Therefore, it represents a potentially occupiable volume or space in time. (Figure 2.1) Gaps are often perceived as voids, which suggest an absence or lack, however this space is not necessarily empty. It is filled with the ambiguity of being neither this nor that: the transitional spatial or temporal distance between two or more clearly defined events, objects, spaces, people, etc. It simultaneously merges and separates two opposing ideas, thereby establishing a relationship between them. In this view, perhaps a better explanation of a gap is a 'pregnant void,' a term Isozaki uses to describe the Japanese spatial concept of *ma*. This understanding emphasizes the meaning behind the void as the essential emptiness that exists between two things, both separating and uniting them in space and time, and this concept assigns equal importance to positive space and negative space.

2.2 The Pregnant Void

Expounding on his summary of this complex concept, Isozaki explains: "[Ma] originally means the space in between things that exist next to each other; then comes to mean an interstice between things--chasm; later, a room as a space physically defined by columns and screens; in a temporal context, the time of rest or pause in phenomena occurring one after another....It seems to me that ma ought best be thought of as 'gap'."¹ Ma therefore literally translates to gap or interval. It is a necessary spatial value in traditional Japanese architecture, originating from the ancient Japanese con-

1 Isozaki, 95

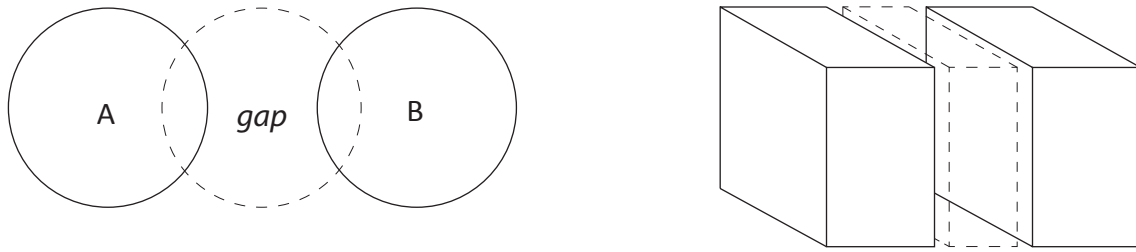

Figure 2.1 Diagram of a gap as the implied space between two defined things

struction system, *kiwari*, measuring the physical distance between two structural elements.² (Figure 2.2) However, this concept is not necessarily literal as Kurokawa suggests in his definition of *ma*: “the temporal interval between two different phenomena or between two contradictory elements or between dimensions of varying natures.”³

Ma also refers to the Japanese way of speaking, which values the silence between words. Junichiro Tanazaki, author of *In Praise of Shadows*, says of this, “Most important of all, are the pauses.”⁴ In a sense, the pause (the negative) becomes just as important as the positive spoken words. To use Isozaki’s adage, this pause is pregnant with meaning. It is the essential space of silence that emotionally charges the words that frame it. Traditional Japanese theatre, *Noh*, depends on these reverberial voids to complete the emotional impact of the content. These gaps are therefore a device to observe the unseen (or unspoken) effects of finishing one idea and beginning the next and preserving an intangible meaning that exists in the limbo of space and time.

Ma, in an architectural sense, is most simply demonstrated through aspects of Japanese vernacular architecture. In a *machiya*, or traditional merchant home, a *doma* or *niwa* is a space of intensity and darkness that absorbs the functional change from outside to inside and public to private. A similar space, *engawa*, serves as a transition between nature and human in a *naka* (rural farmhouse) or *shoin* (17th century palace). (Figure 2.3) Literally a covered porch partitioned from the inside and outside by two sets of *fusama*, or sliding doors, this ambiguous zone not only filters temperature and sunlight, but once occupied, it is filled with a pensive awareness of existing between two things. This spatial awareness is most fully developed in the 18th century *sukiya-zukuri* followed by *cha-shitsu*, or teahouse architecture. The tea room exists as a vacuum of time and space altogether becoming an ambiguous zone of meditative retreat.

Even in ancient religious architecture, a *kairo* is an essential device created to separate sacred space from common space, or space reserved for gods from the human world. Essentially, this is a corridor which provides a marginal zone to protect the sacridity of the inner object, often seen in the layout of shrines and temples.⁵ At Ise Shrine, a concentric series of fences and corridors buffers the sacred *naiku*, or inner shrine. The shrine is literally unseen; visual access across these chasms of white rock is denied which increases the emotional charge of the worshipper. (Figure 2.4) This floating world, or gap represented as heaven, is also depicted in many traditional arts.

2 Seike, 12

3 Kurukawa, 55

4 Tanazaki, 34

5 Inoue, 24

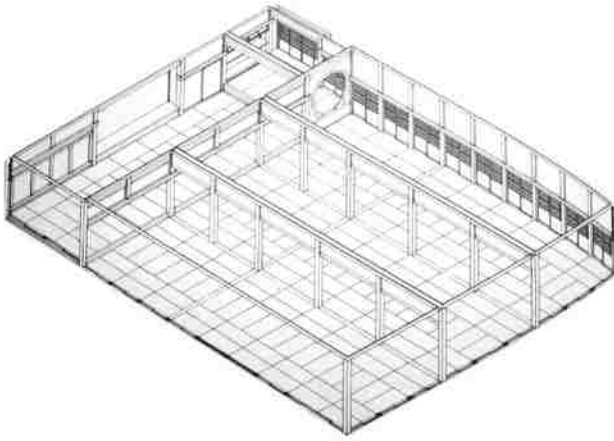

Figure 2.2 Kiwari proportions; Plan of shoin at Yoshimizu Shrine



Figure 2.3 Engawa at Katsura Rikyu

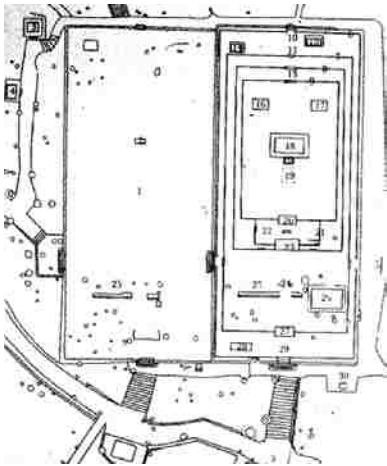

Figure 2.4 Concentric kairo in the plan of Ise Shrine

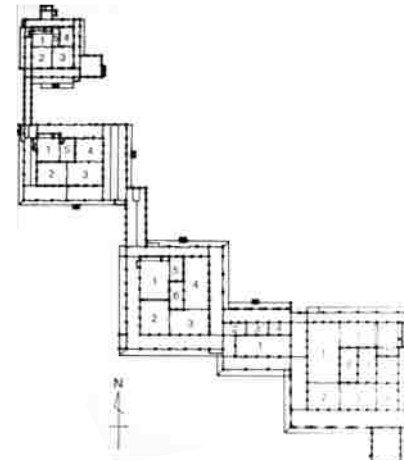

Figure 2.5 Movement space and the 'Flying Geese' plan of Nijo Castle

These vernacular examples demonstrate the concept of *ma* through their ability to occupy or contemplate the transitional zone of ambiguity where one thing changes into another in physical, temporal, and even emotional space. They also highlight the essential value of the transitional space, or gap, to not only physically bridge between two separate events, but also provide a space for becoming aware of that moment of change. In a traditional sense, and especially in the case of the *cha-shitsu*, that moment is a space for contemplation and so is again translated to a metaphysical state.

2.3 The value of a gap in contemporary urban space

These examples of gaps in traditional Japanese space contrast strikingly with voids in contemporary urban space. In reference to medieval Japanese ink painting, Inoue says, "It is precisely those blank areas on the paper that are the most difficult to produce."⁶ On the contrary, gaps in Japan today are so easily produced that they are reduced to forgotten left-overs divorced from meaning. They are not intentional spaces of beauty, but are instead naturally occurring by-products of unplanned growth and rapid cycles of changing urban form. They have disappeared as a contemplative interval and reappeared as an emergent form of modern ambivalence. (Figure 2.6) However, gaps remain an essential urban space. What is the value of today's gaps and is there a relationship between the essential meaning of a void and its present spatial significance?

If a gap, in general, is seen as something that absorbs the transition from one thing to another, can it also be likened to that spatial element that absorbs change within the city? In this sense, the physical gaps are likened to a buffer which

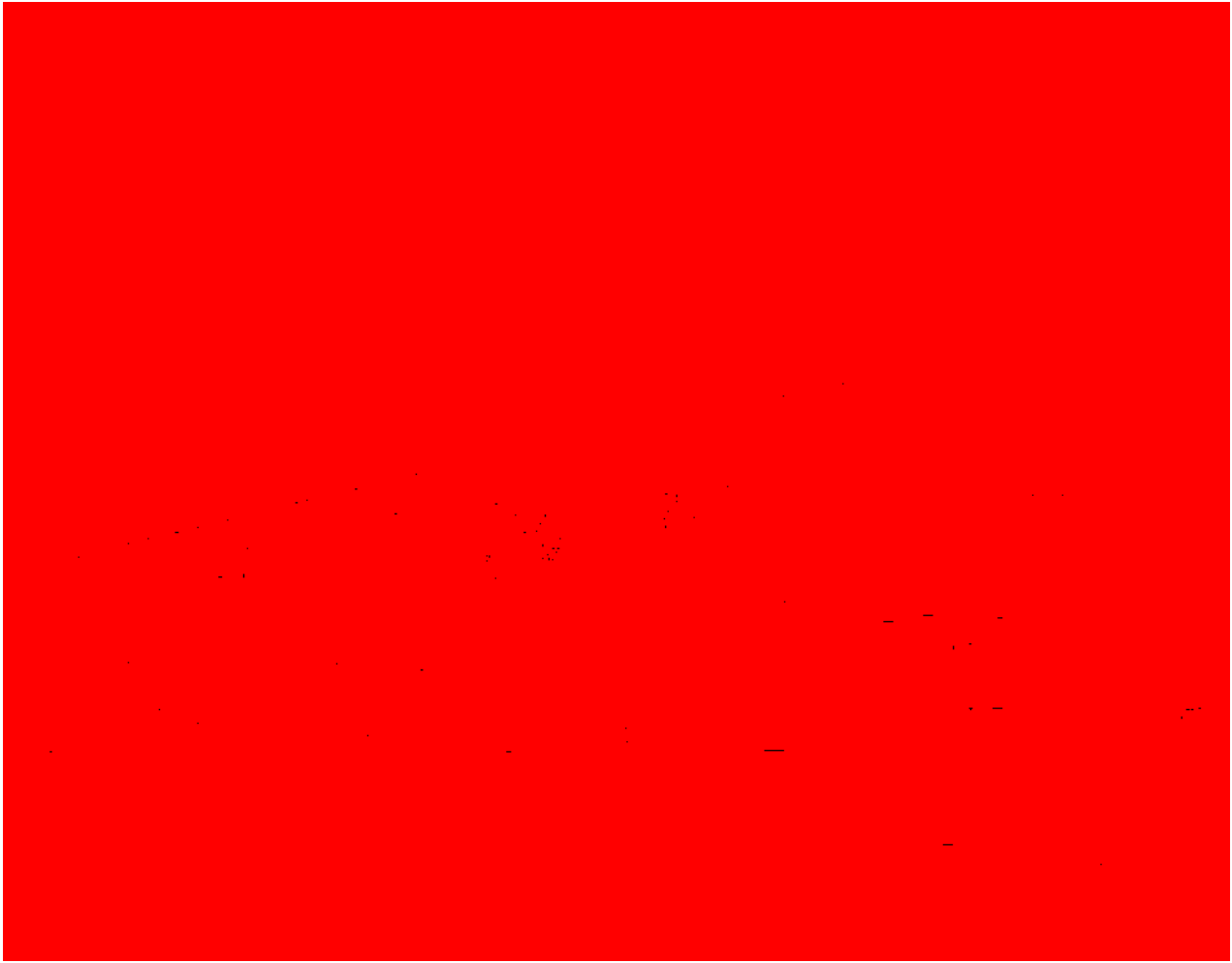

Figure 2.6 Modern ambivalence: Elevated highway built over an existing warehouse in Nagoya

expand and contract according to the pressure of the surrounding circumstance as the city changes into one thing from another in its endless cycle of destruction and rebirth. As individual structures regenerate according to the law of impermanence, or scrap and build, the blank space of the city accommodates this situational change. Because every structure is essentially stand-alone (according to the mandated 50 centimeter separation between buildings), gaps enable an ease in the destruction and reconstruction of buildings in Japan, perpetuating the rapid cycle of change. These flexible buffers are an essential piece to the functional way of building the unfinished city. In this sense, gaps retain their value as a marginal space.

Modern gaps also simultaneously merge and separate two different spaces, similar to the *engawa* or *doma*. In this duality, they acquire the revered ambiguity of traditional Japanese spatial principle and the essential meaning of a void as an in-between nothingness, devoid of ownership or definitive purpose besides that to act as a transition. As a separator of space, gaps perform functionally as a division of property. In acting as a connective space, gaps “string together like beads”⁷ the positive space of the city, building a continuous network of voids. Inoue refers to this concept of gaps as ‘movement space’ which holds the city together as it morphs, maintaining a continuity of space over time. Like the sequencing of space seen in the plan of Nijo Castle or Katsura Rikyu, so the voids of the city provide an explorative and revealed process of understanding a comprehensive idea about the city. This connection is not always physical since most gaps are too small to occupy, but instead, gaps often enable visual connections. Likening the contemporary urban landscape to those of the past where space was implied through a sequence of revealed visions, Inoue says,

7 Inoue, 145

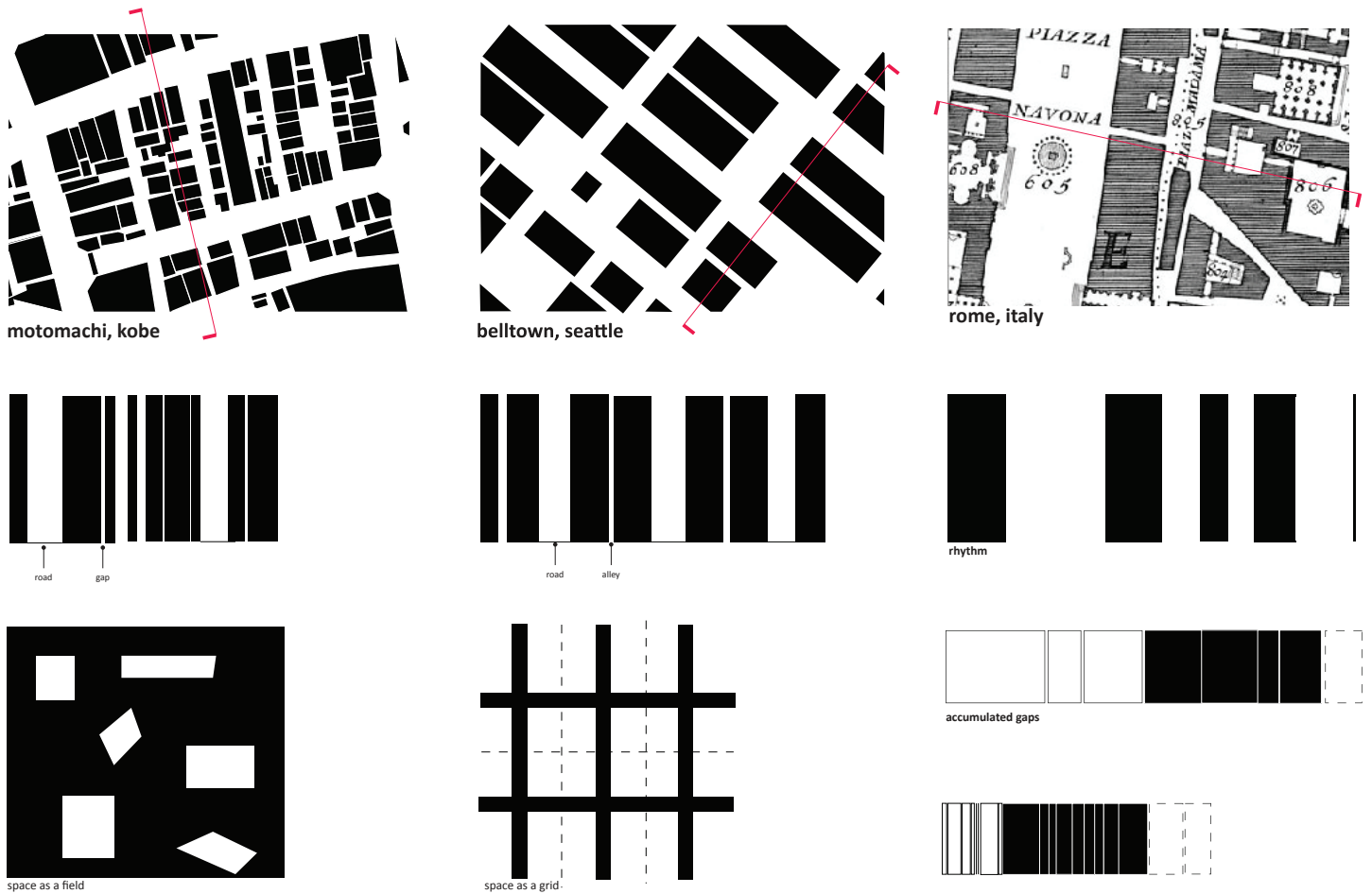

Figure 2.7 Urban patterns in Kobe, Seattle, and Rome

The vision of the landscape has much in common with the sensations experienced in encountering scattered buildings along a winding approach to a shrine, or suddenly glimpsing the straw roof of a tea house or a stone lantern that had been hidden among the trees in a tea garden. A sense of mutability or flux attended by diverse deflections characterizes these visions; they describe an unknown world where, except for that small part before our eyes, nothing can be foreseen. There is a consciousness that the present that we inhabit is nothing more than an instant wedged in eternal nothingness. From this comes the idea that human life and human dwellings are temporary shelters.⁸

2.4 Gaps as fluid space

As urban fabric regenerates, old gaps disappear, new ones appear and this network of physical and visual connections is in constant flux. The temporal nature of gaps is felt in this way. Therefore, not only do gaps enable the physical and visual transition between two objects; they offer a transition of space as it changes over time. Gaps are in fact fluid space, dynamic entities whose form is determined by an ever changing exterior force. If we make this relationship to time, we must also consider the traditional Japanese view of time as cyclical rather than linear. Therefore, gaps mark an iteration of form rather than progression. Ultimately, this concept establishes a relationship between physical and temporal events which absorbs the ambiguity that occurs when these events meet in both space and time. Simply, the gap is the in-between.

Although their present form at any given time is fixed, gaps are built through an accumulation of voids existing between positive space and its iterations. Observing the urban landscape, how do we differentiate between iterations? Only



Figure 2.8 Historical axes in aerial view of Piazza del Popolo, Rome



Figure 2.9 Typical grid in Seattle



Figure 2.10 Lack of historicism in aerial view of Shibuya, Tokyo

when one cycle finishes and the next begins, resulting in significant voids which are often temporarily programmed with parking lots. But in general, a relationship with previous iterations is indistinguishable, since every physical object is on its own cycle and the cumulative urban form leaves little physical evidence of the past.

In the unchangeable city, we rely on landmarks and preservation to aid in understanding the city and its change over time. There is a decipherable relationship between history and urban form. A simple mapping of Rome traces the triumphs and defeats of its great leaders through landmarks and grand corridors such as Piazza del Popolo with its trident form stretching from the monumental obelisk of Ramesses II. In Seattle, the shifting grids tell the story of topography, power struggles and the increasing proliferation of the auto industry, providing a logical underlay and navigational device. Preservation in both cities provides a reference to period architecture, establishing a spatial reading of place in terms of its development over time. (Figures 2.8-2.10)

According to the Japanese way of building cities, lack of preservation and the unavoidable *tabula rasa*; there is a general erasure of historical context or visible continuity with little readability beyond chaos. Therefore, the accumulative space of the city must be dissected to understand a relationship with what existed before. Perhaps gaps, as fragments or leftover space, are an implied link to the previous iteration, and begin to trace a relationship with what existed before. Gaps are the device by which we can understand the iterative rather than progressive process of developing urban space.

Although the form, frequency, and spiritual meaning behind today's urban gaps contrast greatly with the emotional space and awareness of surroundings in traditional spatial theory, gaps are an asset to producing urban space in Japan and understanding the regenerative process of urban form and lack of unique context. If *yohaku no bi* means the beauty of empty space; the value of a void, we have found this value in today's interpretation of a gap. In the contemplation of these gaps beyond their common existence as phenomena or by-products to one of spatial and temporal order emerging in a fluid form, these interstitial spaces provide a continuity over time, enabling a greater understanding of the city beyond its present state of chaos.

3. Kobe

3.1 Kobe Overview

The remainder of this study documents a number of gaps in Kobe, Japan. Kobe, a city of 1.5 million, is situated on a narrow strip of land in Osaka bay and is the fifth largest city in Japan. In close proximity to megalopolis Osaka and historical Kyoto, these three cities together represent the Kansai region. Kobe is a key port for this area, historically known for the industry and export of manufactured goods and was one of the first ports to open to the West during the Meiji period. Kobe's early urban form was influenced by the foreign settlements established in the late 1800s and has since been known as an 'international' city.

Like most Japanese cities, Kobe is restricted by topography and water, only 4 kilometers wide at some points. Residential and commercial zoning runs parallel to the mountains, and a narrow strip of harbor and industrial runs adjacent to the port. (Figure 3.2) While these zones generally describe the division of land use, there remains an undifferentiated classification within these two areas. These zones are separated by an elevated highway, the essential link between Kobe and Osaka. Three train lines cut through the city running parallel to each other in the east-west direction, while below ground, a limited subway system links the north-south direction in the central area of the city.

In many ways, Kobe is a typical post-war Japanese city with its aging population and 'post-bubble' economic decline. In terms of architecture, the typical pixelated field of mid-rise concrete blocks dominates the skyline. All of the effects of modern planning apply, such as a general lack of land use division, accumulated infrastructure, a high changeover in building stock, lack of public space, and the ubiquitous presence of gaps and general discontinuity in the urban fabric. However, several events have shaped the urban fabric of Kobe into its present form and gap development.

In addition to the consistent cycle of change that regenerates Japanese cities, Kobe has been significantly reinvented twice in the last 70 years. Air raids during World War II destroyed over 50% of Kobe's building stock.¹ Damaged areas were somewhat neglected as post-war development focused on growing the industry and port sector and by 1996, Kobe had grown to become the sixth most important port in the world. However, in 1995, Kobe was struck directly by the Great Hanshin Awaji Earthquake. Kobe was again in ruins; that blank slate that so often characterizes the Japanese post-disaster state.

The earthquake damaged or destroyed over 400,000 buildings, mostly those deteriorating low lying wooden structures built before 1965 and occupied by elderly. Additionally, nearly 30 kilometers of elevated rail lines and highways col-

1 Edgington, 18

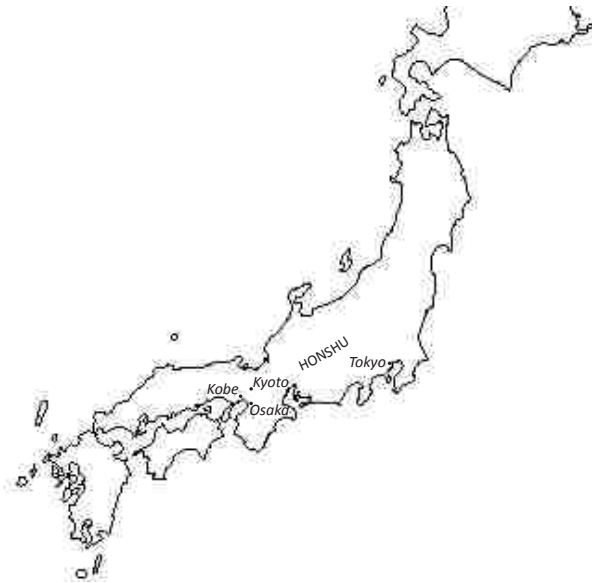

Figure 3.1 Map of Japan



Figure 3.2 Kobe



Figure 3.2 Motomachi



Figure 3.4 Kobe in ruins after air raids in 1945



Figure 3.5 Kobe in ruins after 1995 earthquake

lapsed. The earthquake drove over 100,000 people from the city and left Kobe devastated, economically and emotionally. It also resulted in a significant number of gaps in the urban fabric. Entire sections of the city were destroyed by fire in addition to the scattered collapsed houses and abandoned lots.²

3.2 Motomachi

Kobe's gaps are a mixture of post-earthquake re-development and pre-earthquake accumulated urban form and infrastructure. Nowhere is a variety of gaps more represented than in Motomachi, a district of Chuo Ward, the central most of Kobe's nine wards. Sannomiya, the central government and commercial district, borders Motomachi to the east. Several covered arcades, including an underground passage and a corridor beneath the train platform, link Sannomiya to Motomachi, and further to Kobe Station, a less prosperous center, which borders Motomachi on the west. The northern edge is defined by the elevated JR tracks and to the south, Motomachi is cut off from the waterfront by the elevated Hanshin Expressway, an important arterial linking Kobe to Osaka.

Motomachi is a diverse area with a variety of districts, each with their own distinct character. Most definitive is the one-mile long shopping arcade, or *shotengai*, once known for high-end shops selling traditional goods and jewelry. Most shop owners within the arcade are longtime residents of the area attracting a mostly middle aged and elderly. However, the presence of Daimaru department store and surrounding area, Kyu-kyoryuchi, brings a younger and moneyed crowd. The old-time refinement within the arcade contrasts strikingly with the streets just north. This area adjacent to the rail tracks, is full of izakaya, pachinko parlors and cheap gyoza shops, cater to business men exiting the station. Additionally, Nankinmachi, one of Japan's three Chinatowns and a primary tourist destination for Kobe, is located south of the arcade. Finally, to the south of Nankinmachi, is Sakaemachi, a quieter area with a variety of residential towers and apartment

² However, this was also an opportunity to start over by improving the already deteriorating city. The main objective of immediate recovery centered around restoring infrastructure, which is often the case in Japan, driven by funding from the central government and reflecting the still prevalent planning theory which favors infrastructure over other improvements. Other major recovery plans focused on rebuilding 24 designated areas through 'land readjustment', specifically six 'black zones' which were hardest hit by the earthquake. In these areas, the local government was responsible for acquiring land to redevelop which meant buying plots from individual owners, land readjustment, widening streets, and developing more open spaces and green belts. The result of these projects were an increase in large scale profitable commercial development over the traditional *shotengai*, or one-story shopping arcade commercial areas. Additionally, high rise residential and market-rate condominium complexes increased the land density from the typical 2-story wooden home to an average 7-story concrete framed building. Other post-earthquake planning efforts imagined revitalization through massive public projects, including HAT Kobe (Happy Active Town Kobe) along the eastern waterfront and focused on large scale projects such as museums and an airport using reclaimed land in Osaka Harbor, which was eventually completed despite citizen protest. The remainder of the city, the 'white zone', was delegated no public funds for restoration and the 'self-reconstruction' of these areas was left almost entirely to local community groups. Therefore, recovery was characterized by a mixture of government led large scale development and organic. However, other effects of the \$100 billion recovery included a shrinking population, a displaced aging community, and a shift in industry.

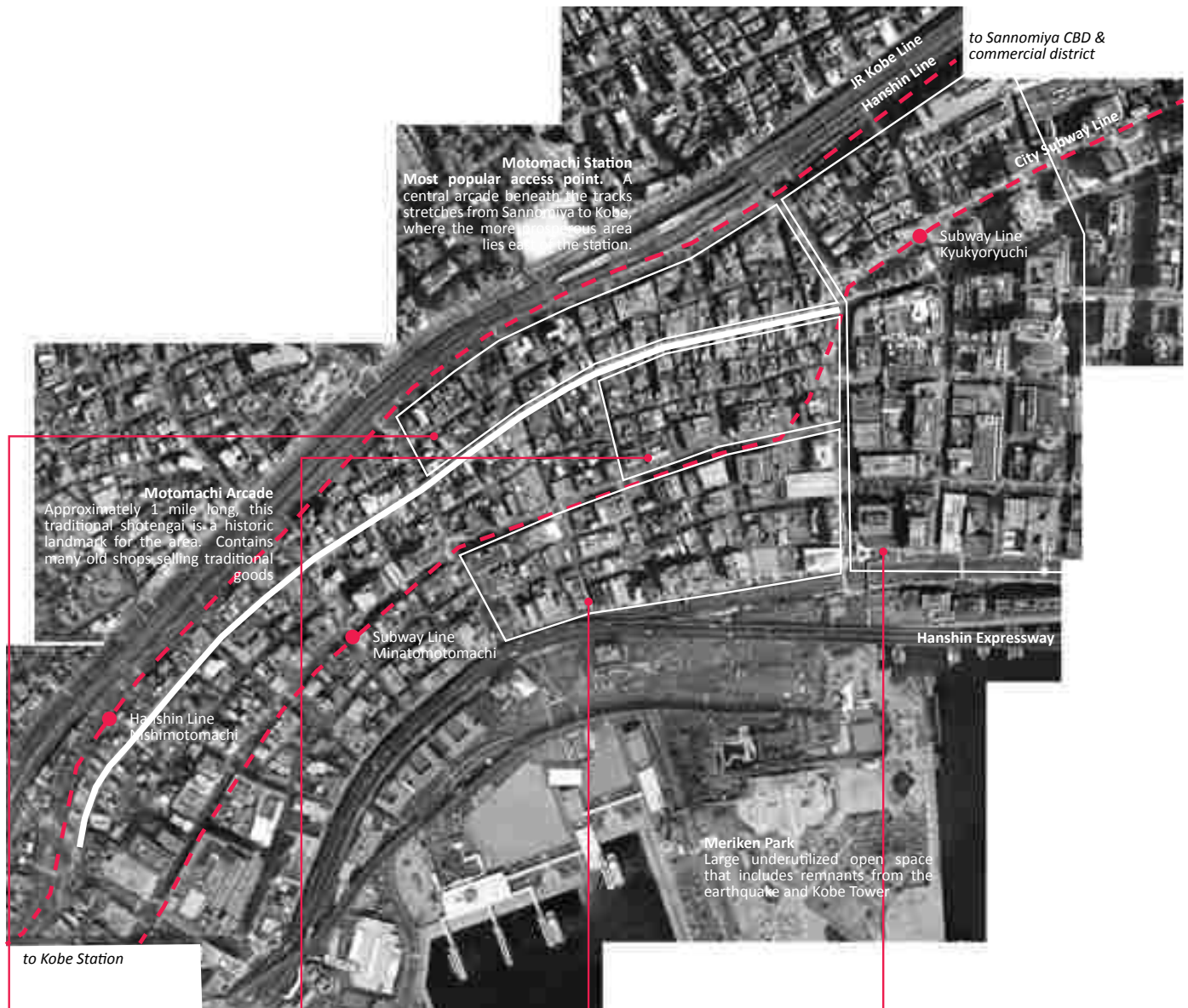

Station and around

Busy area between the JR tracks and shopping arcade characterized by izakaya, gyoza restaurants, Pachinko parlors, and cheap shops. This area has many small N-S corridors, connecting the station with the arcade and Nankinmachi.

use: commercial, some business above, ground floor retail, many people moving through

user: young-middle aged, business men; elderly

Nankinmachi

One of Japan's three designated Chinatowns. A busy central street with Chinese restaurants, street vendors, and crowded with both international and Japanese tourists. Represents the strong presence of Chinese nationals living in Kobe.

use: commercial, primarily small restaurants

user: all ages, tourists, Chinese population, some residential above shops

Sakaemachi

Traditionally a light industrial marine neighborhood on the eastern edge of the original 'native settlement.' Today this quiet neighborhood is reinventing itself as an artisan district, although there remain many empty lots. Along Sakaemachidori, large scale development for residential and business related to marine industry creates a mixture of scales and uses in this area.

use: commercial, residential, light industrial

user: mixture of older residents occupying low lying houses remaining after the earthquake and newer residents in the towers along Sakaemachidori; mid 20's-60's attracted to shopping

Kyu-kyoryuchi

Originally the west edge of Kobe's 'foreign settlement', this area retains a European atmosphere with wide boulevards, sidewalk cafes, and high fashion retailers. Block development with high rise office towers.

use: mixture of commercial, residential, and light industrial

user: typically young and middle aged adult with money; not elderly

Figure 3.6 Neighborhoods in Motomachi

blocks mixed with light industrial marine activity and a thriving artisan district. Motomachi is therefore a central point where a variety of uses and users meet.

After 1995, Motomachi was designated a 'white zone' according to reconstruction plans, meaning that little to no public funds were granted for restoring the area. This process was left almost entirely to the citizens, through machizukuri or community group planning. Although not severely damaged by fire like other districts in Kobe, there was significant damage to buildings and in Chuo Ward, over 7,000 buildings were damaged, needing repair or replacement. The area was physically restored quickly, however, many business owners moved away and the area saw a general economic decline with empty lots abandoned after the earthquake. Many of these lots, particularly those along Sakaemachidori, were bought by private developers for the construction of high-rise condominiums. Therefore, the area has a diversity of building types, new and old, and has witnessed a more organic response to post-earthquake redevelopment.

3.3 Sakaemachi

Sakaemachi sits just below Nankinmachi, Kobe's Chinatown and is bordered by Kyu-kyoryuchi to the east. Traditionally a merchant street for the marine industry, Sakaemachi was historically a strip of light industrial and marine management companies. Also visible are several leftover buildings from the banking days of nearby Kyu-kyoryuchi, part of the 'foreign settlement' just east of the site.

As the marine industry began to decline in the mid-1990's, many banks were abandoned and the marine industry suffered, leaving significant gaps in the form of vacant lots. Roughly 25% of Sakaemachi is empty lots. Recently, developers have bought the empty lots, specifically on the streets bordering Sakaemachi to the north and south, creating a valley in the central neighborhood which still contains many old low-lying buildings or small scale iterations. Larger development has increased the typical 2-3 story scale to 10-15 stories, readjusting the scale and density of the area.

Today, Sakaemachi has revived its craftsmen roots, but in a new form. A variety of artisan workshops and storefronts have moved into the area, slowly transforming this abandoned marine center into an artisan neighborhood. The few old merchant buildings and storehouses remaining in the area have been reclaimed as workshops, stores, and cafes catering to a younger, intellectual crowd. Still, the atmosphere in Sakaemachi is quiet and although it is a thriving piece of the well known Motomachi district, this place remains unfound to many Kobe locals. Its form contains both old and new, reclaimed and reshaped, block development and a fine grain, resulting in a number of interesting gaps.

3.4 Kobe's Gaps

A number of typologies characterize Kobe's gaps. (Figure 3.1, 3.2) This study identifies six general types of gaps that commonly exist throughout Kobe today and are typical to most Japanese cities.

The first type is gaps existing between architecture and infrastructure. Due to the amount of elevated infrastructure in Japanese cities as a result of accumulated urban growth, a vast amount of marginal space is found between buildings and infrastructure. The need for available space has engendered the unexpected use of these voids adjacent to infrastructure and these gaps often become lively alley-like spaces and busy thoroughfares. In Kobe, the elevated JR train line cuts through the major part of the city. This void runs for roughly two miles, from Sannomiya through Motomachi to Kobe station. Backs of buildings open up at ground level to reveal micro-sized ramen stalls and cheap izakaya, catering to the commuter crowds spilling into the gap. Another type of infrastructural gap is the void that exists between the structural elements of elevated railway and highways. These spaces are typically infill ranging from housing to commer-

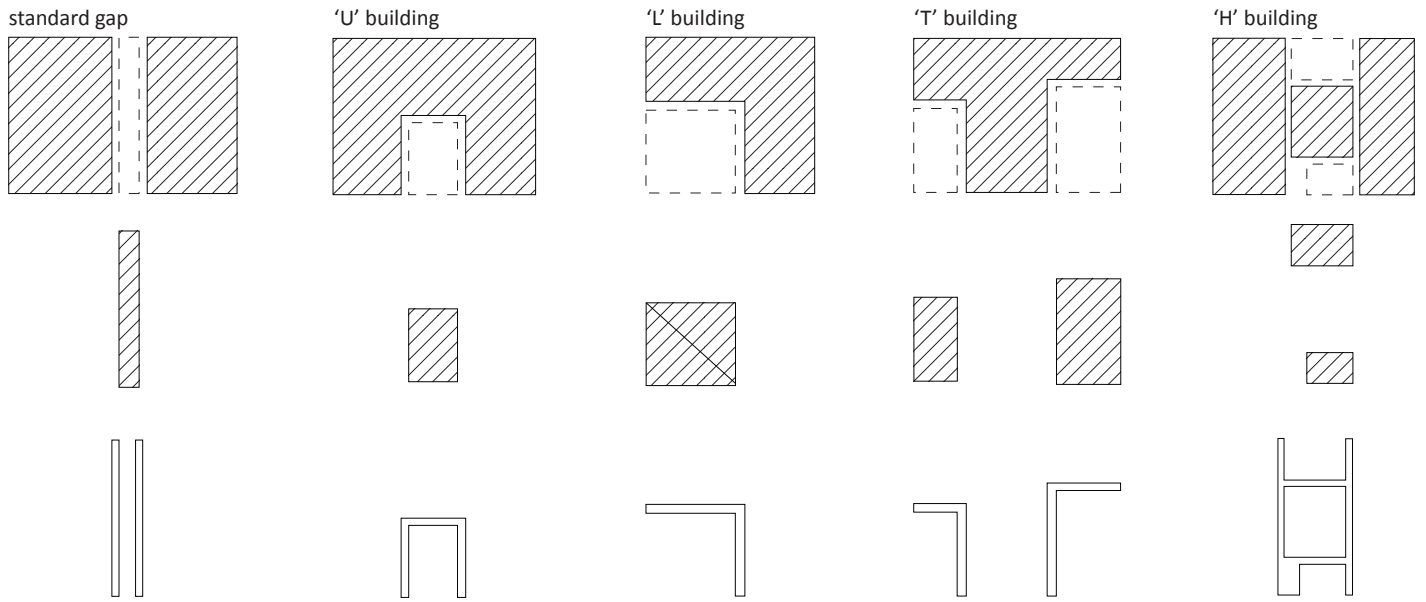

Figure 3.7 Typical building form

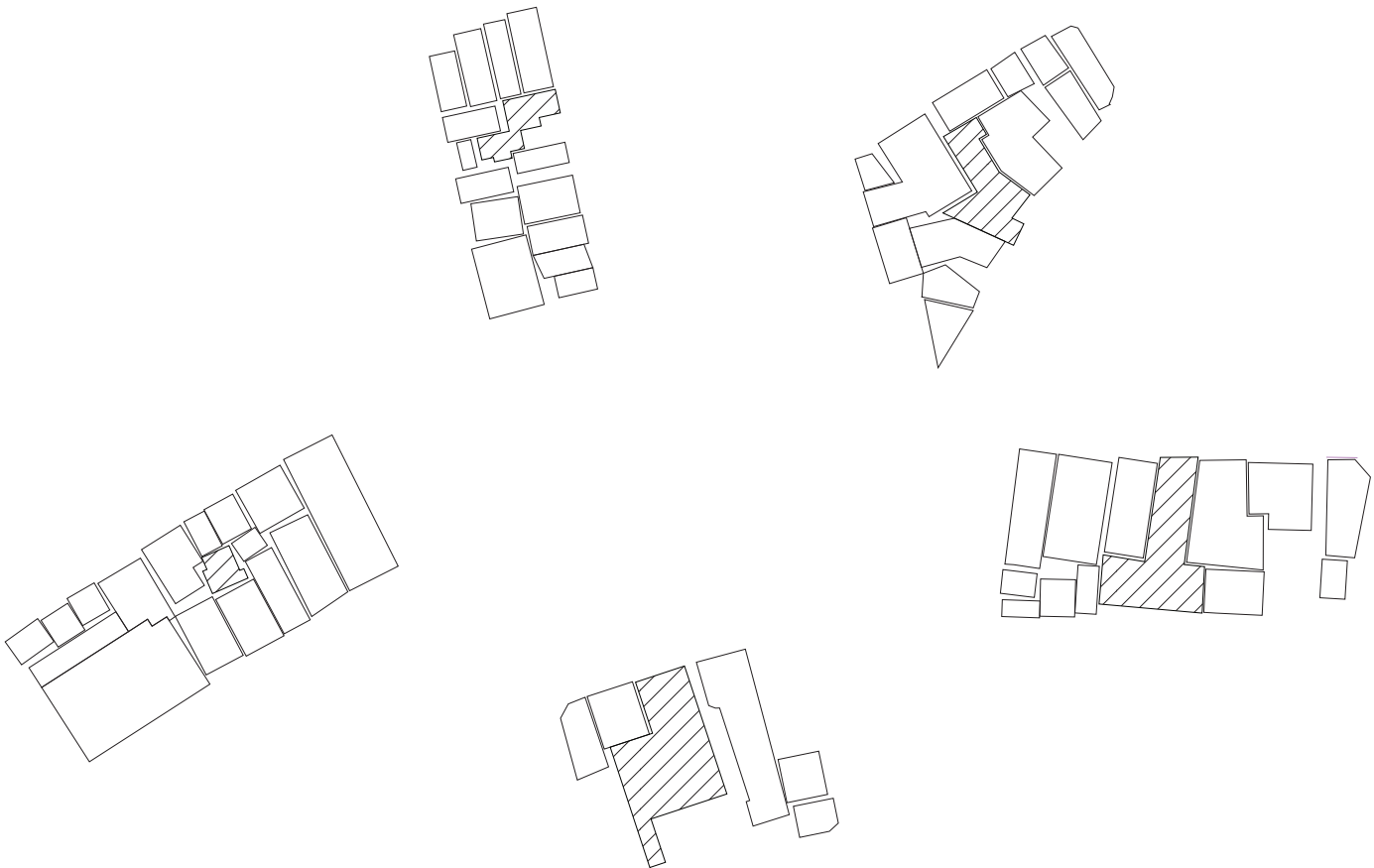

Figure 3.8 Examples of odd building form in Kobe

cial and light industrial. Leftover space as a result of infrastructure is so common in Japan that its bizarre overlap of use is unnoticed, however it also creates an essential efficiency of urban space.

The next major type of gap is that which exists between architecture. Gaps between architecture can be further divided into three sub-types. The first is gaps between buildings. The required minimum 18" setback from property lines results in a general 3' gap between adjacent properties. Characterized by dark, narrow chasms, these gaps are unoccupiable but are often used for storage, utilities, or accumulation of trash. Therefore, these gaps provide some functional efficiency in addition to performing their task as a separation between property. However, when it comes to identifying these spaces in three dimensions, it becomes ambiguous as to who owns what. Larger gaps ranging from 3' to 6' are identified as corridors. Perhaps narrow gaps are widened over time accumulating to become more useable space. Once occupiable, these gaps become throughways, providing essential connections and increasing efficiency in moving through the city. They are often programmed as bicycle parking or vending machine areas. Larger gaps also become opportunities for architectural infill of impossible proportions. Referred to as gap architecture, these narrow building plots, often only 6'-10' wide, are seen as developable space.

The last type of gap is empty lots. Holes in the urban fabric are filled with temporary parking lots, but represent available space for the next iteration of the 'scrap and build'. These sites represent a building that has been scrapped and not yet replaced. Some of Kobe's empty lots are a relic of the earthquake, which not only destroyed many buildings, but drove people to leave the city, abandoning their property. However, voids in the urban fabric are seen in cities all over the world, reflecting a changing economy. So too, Kobe's empty lots are a product of a weak economy; a gap in space and time hopefully awaiting a more prosperous future.

Figure 3.7 demonstrates several typical building forms. These oddly shaped properties both create gaps and are a result of accumulated gaps. This relationship between form and available space is obvious in Figure 3.8. Since positive space is constantly changing, development at any given time is a result of available negative space. Gaps are therefore accumulated to form atypical plots for development. Common building forms include the 'H' building, where eventually, the small building in the center will be inaccessible as a result of inevitable development of the available land surrounding it.

The remainder of this study focuses specifically on gaps between buildings, the most common type of gap.

Gap Typologies

(a) *architecture/infrastructure gaps*



Gaps between buildings and infrastructure, such as elevated railways and highways create alley-like spaces filled with cheap eateries. They are also an essential through space.

(b) *(infra)structural gaps*



Gaps between infrastructural structure and lack of available space results in an infill ranging from housing to commercial and light industrial.

(c) *gaps between buildings*



Ranging from the required minimum 18" setback from property lines, resulting in a general 3' gap between adjacent properties, which is often unusable space.

(d) *corridors*



More substantial gaps between buildings, ranging from 3'-6' become corridors, useable connections or programmed spaces such as bicycle parking or vending machines areas.

(e) *gap architecture*



Leftover spaces or widened gaps between buildings ranging in width from 6'-10' are seen as useable space, resulting in extremely narrow infill.

(f) *empty lots*



Holes in the urban fabric are filled with temporary parking lots, but represent available space for the next iteration of the 'scrap and build'. These sites represent a building that has been scrapped and not yet replaced.

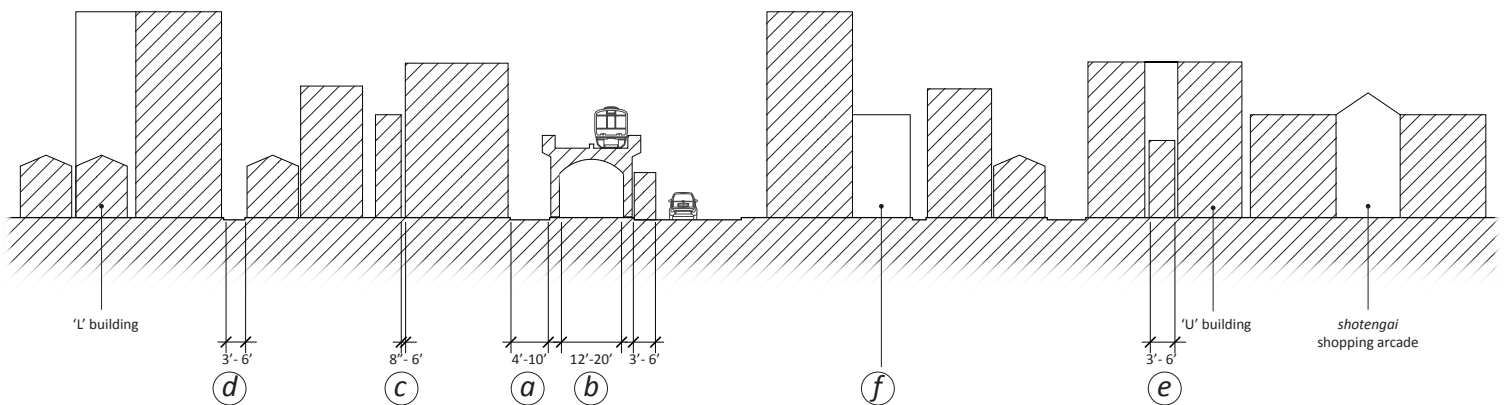

Figure 3.9 Gap Typologies

Typological Appendix

(a) architecture/
infrastructure gaps



(b) gaps between buildings



(c) (infra)structural gaps



(d) corridors



Figure 3.10 Typological Appendix

e) gap architecture



f) empty lots



Part 4: Gap Analysis

4.1 *Forty-eight Gaps*

Forty-eight gaps were identified in Motomachi and compared in terms of scale, use, spatial qualities, and effect on the urban fabric and its accumulative formation. This investigation began as an analysis of positive and negative; figure and ground; solid and void; challenging the assumed relationship between positive space as meaningful and negative space as meaningless and equalizing the value of both in forming urban space in Japan. The simple devices of sectional and plan analysis were employed in this graphic analysis of Kobe's gaps.

The numbers beneath each of these gaps, shown in plan in Figure 4.1, relate to the width and area of each space. Although the gaps studied range from 6" to 17', the average gap was found to be 5' wide. (Figure 4.4) Investigating the average gap helps to understand the typical conditions these interstitial spaces. Figure 4.5 demonstrates the use of a space depending on its width. While gaps smaller than 3 feet are generally unoccupiable, larger gaps accommodate a variety of uses. Although their ownership is ambiguous, gaps between buildings most commonly become a floating zone used as a place to accumulate forgotten or neglected things, perhaps due to the lack of storage in Japanese homes. It was found that gaps greater than 8' were viable building sites.

4.2 *Sectional Rhythm*

These simplified sections demonstrate the abundance of gaps and variety of scales. They are an essential piece in forming space but also experiencing the Japanese city as one moves through it. The sectional quality of urban space in Japan is fragmented and discontinuous. However, because gaps are so common, they are often unnoticed.

This sectional analysis also highlights a quantitative summary of the accumulation of gaps to a significant amount of underutilized space. In Section A, a quarter mile stretch of Sakaemachi, approximately 40% of this sectional space is reserved for gaps. In a crowded city lacking essential open or public space, these sections highlight the amount of underutilized urban land that is locked away in its fragmented gaps. (Figure 4.3)

4.3 *Gap Evolution*

Over a series of 26 year iterations of urban form (the average length of one 'scrap and build' cycle), the maps in Figure 4.6 demonstrate the dramatic change in physical form. They begin to tell a story about Kobe's a-historical urban context and how urban form evolves. These figure ground maps demonstrate the relationship between the increasing fragmen-

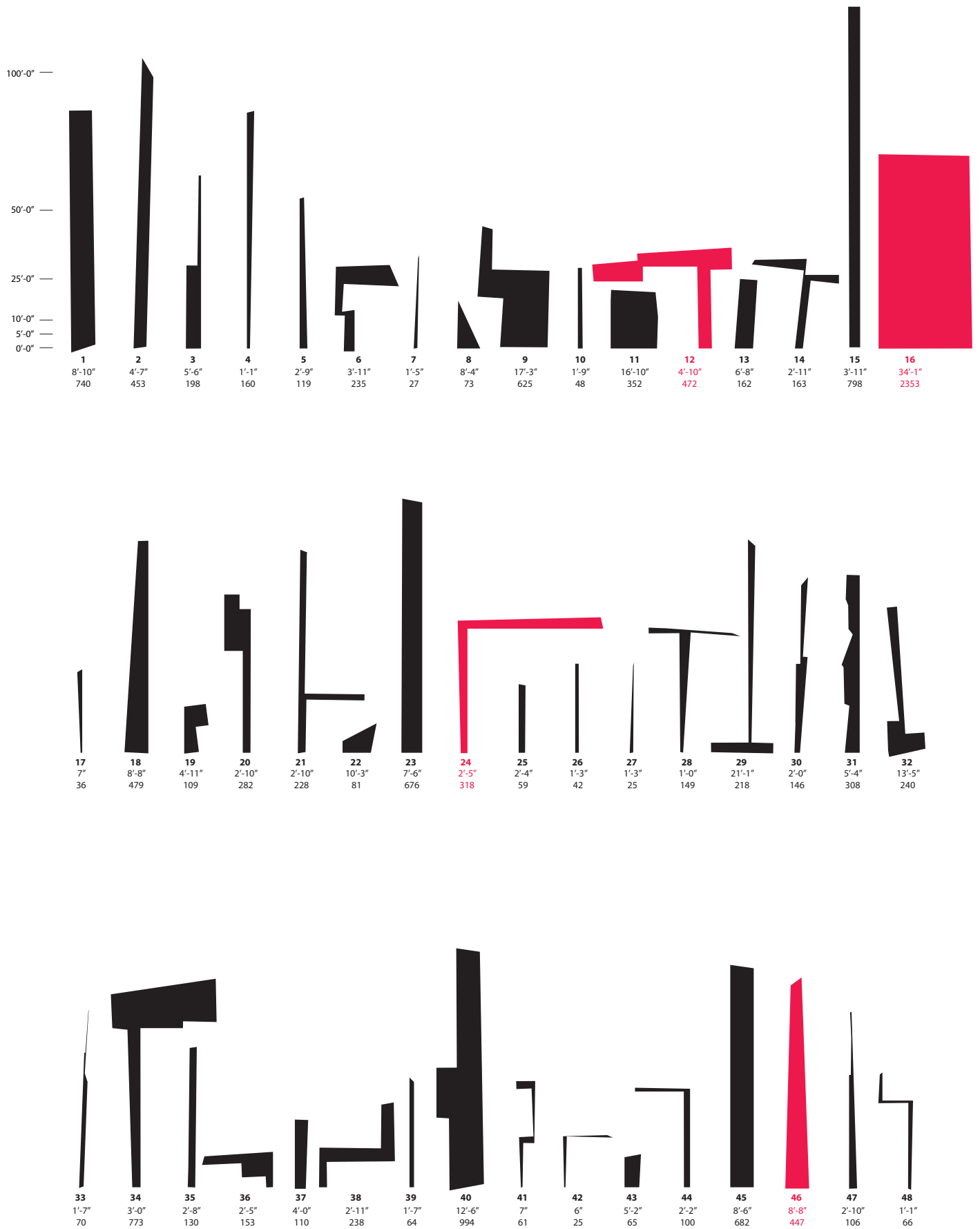
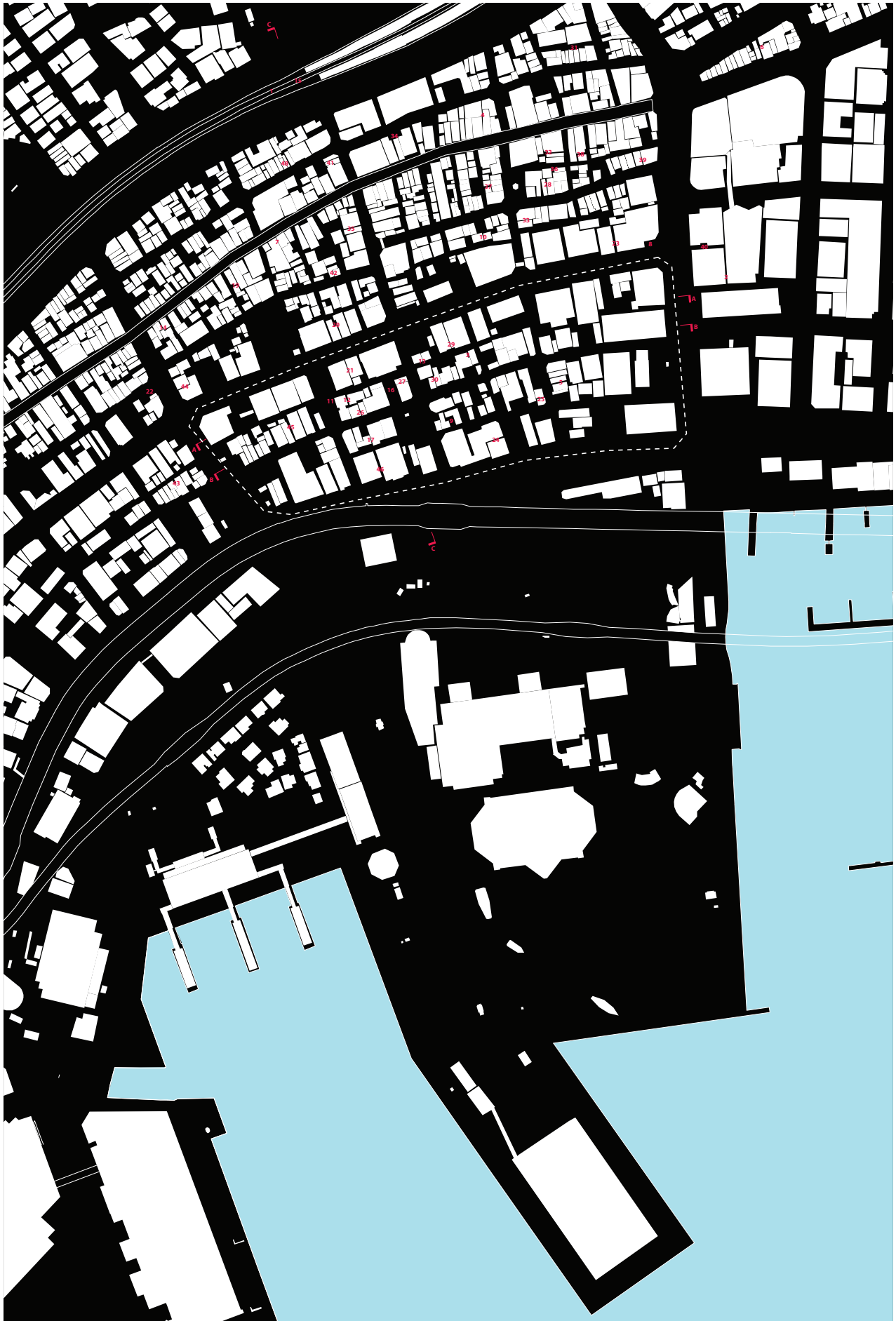

Figure 4.1 Forty-eight gaps



4.2 Map of Motomachi

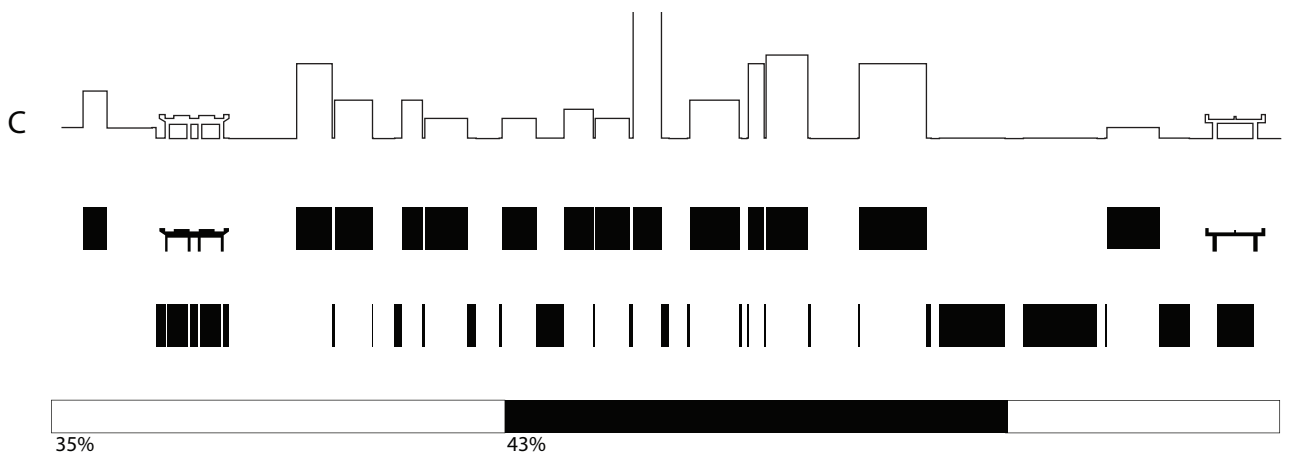
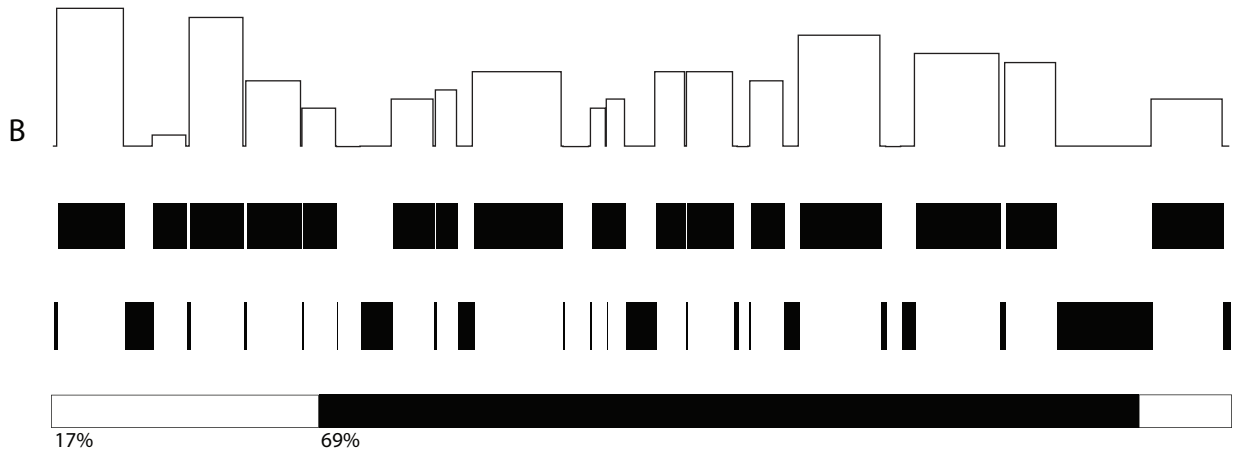
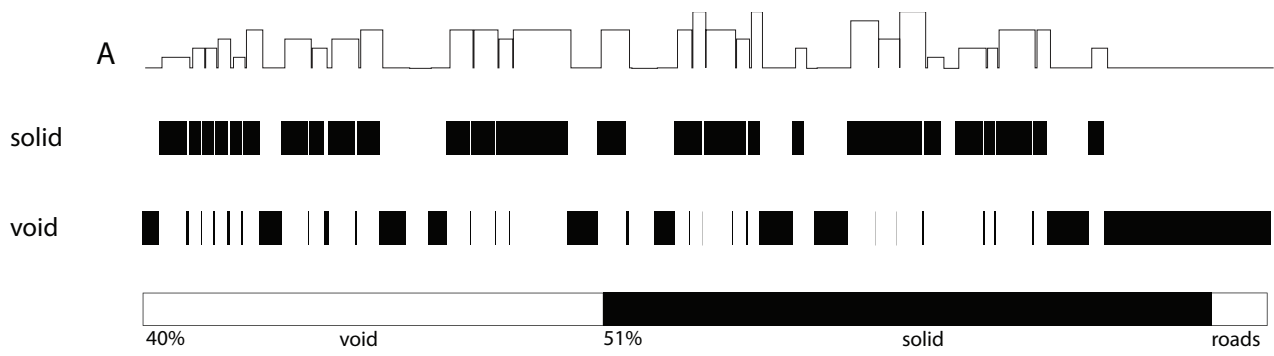
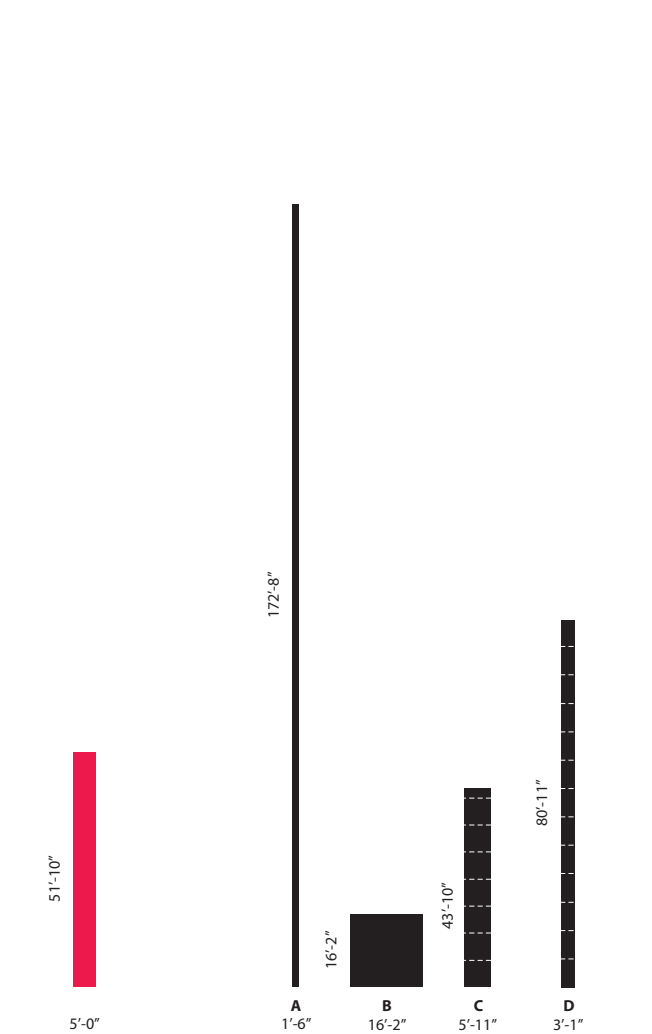
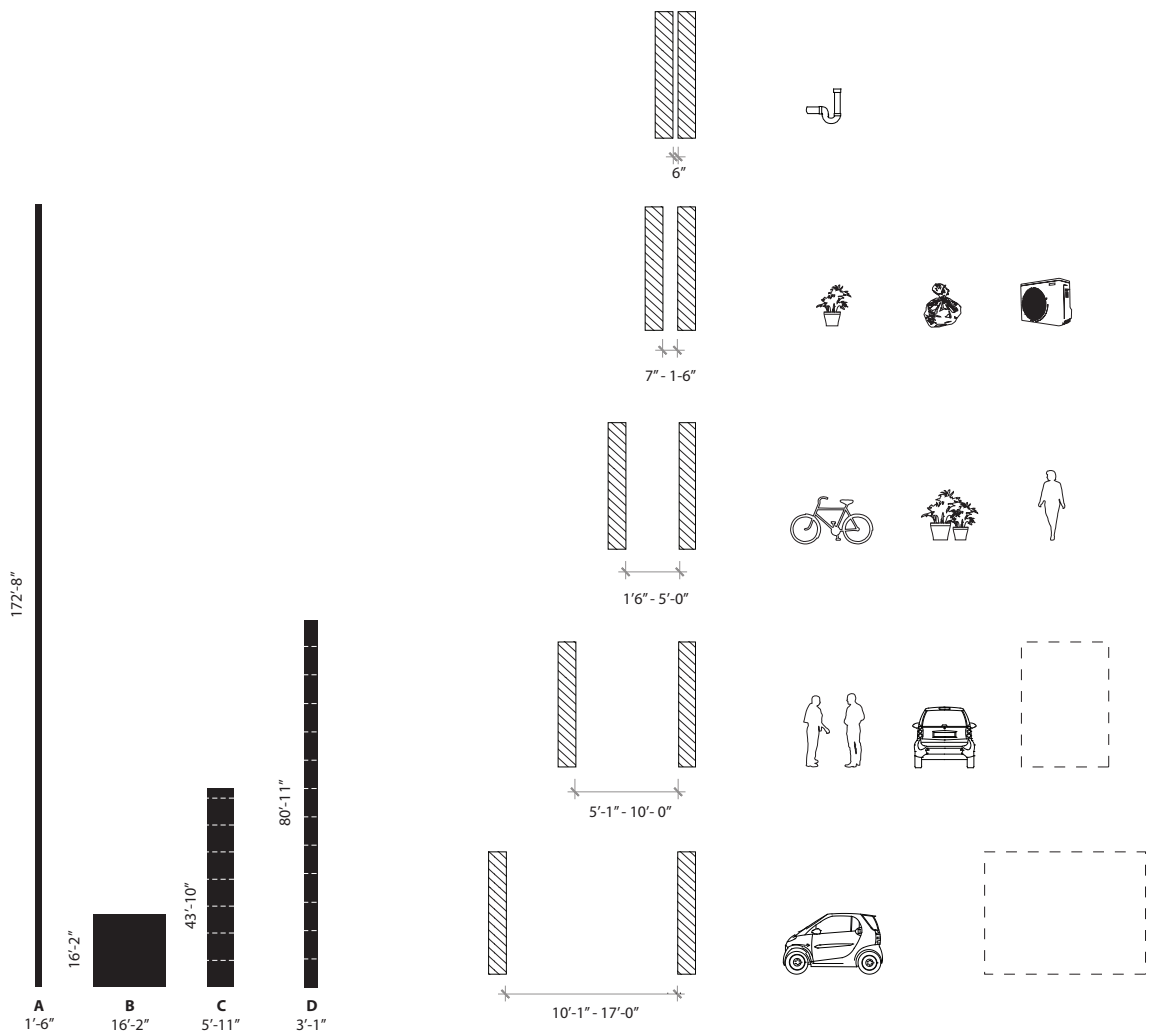

Figure 4.3 Site sections



the average gap

average width: 5'-0"
 average length: 51'-10"
 average area: 259 sq ft



morphology of the average gap

- A** at the required 50 cm or 1'-6" *kenperitsu* or setback from property line
- B** arranged in even measurement
- C** 1 *ken* (2 *tatami*) wide according to *kiwari*, the original construction proportion and ideal spatial proportion; total area is equal to 7.5 *ken*
- D** 1 *tatami* mat wide; the required area for two people to sit or one person to sleep; total area is equal to 13 mats

Figure 4.4 The Average Gap

Figure 4.5 Typical use depending on width

1956
1st Iteration

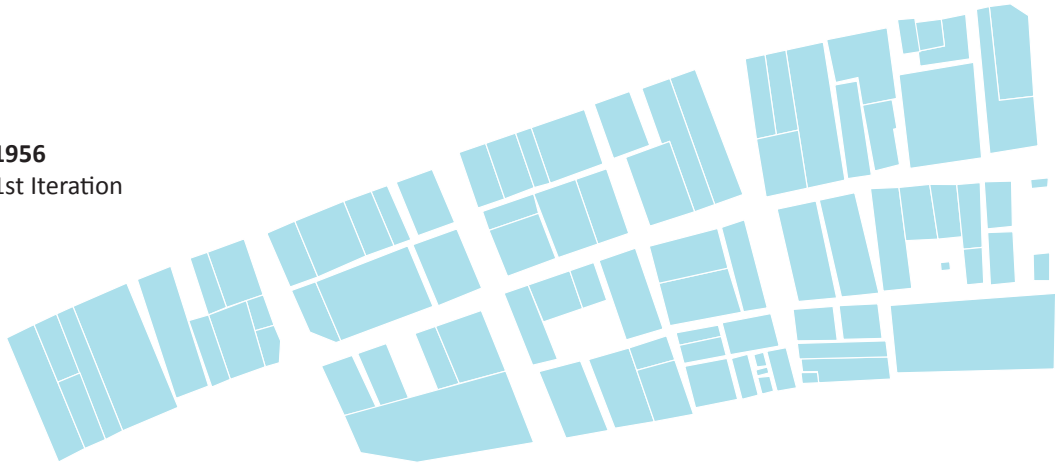

1984
2nd Iteration



2012
3rd Iteration



Figure 4.6 Sakaemachi's gap evolution

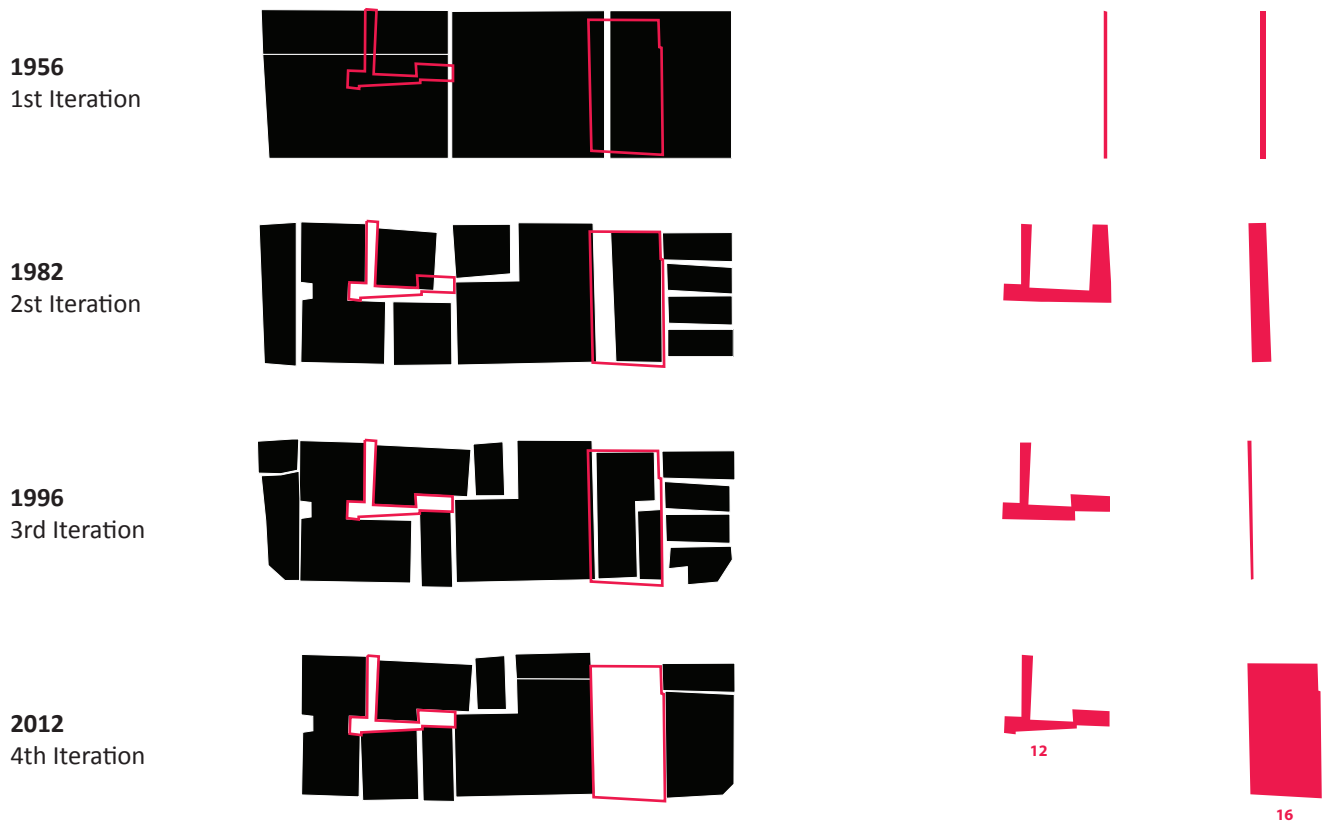

Figure 4.7 Detail of two gaps in Sakaemachi

tation of urban land, due to the lack of parcel restriction and the subdivision of property due to increasing land value, and the growing complexity of accumulated positive and negative form.

The first iteration reflects the original urban development of Sakaemachi in the late 19th century. Sakaemachi sits on the fringe of the foreign settlement which was established east of the site. The form is characterized by larger block development and the beginning of a thriving marine industry. By 1984, most of these large gridded blocks had dissolved into a more 'Japanese' configuration, with small meandering alleys, small scale and detached homes and businesses. At the height of the 'bubble' years, this figure ground reflects the inflated value of land and the division of property, likely due to younger generations inheriting and subdividing property. By 2012, the general decline of the economy and the post 1996 recovery, and a growing number of larger gaps due to accumulated empty lots. The urban form displayed in this most recent mapping is best described as a field of floating buildings.

The accompanying photographs on page 40 demonstrate the visible physical change in Sakaemachi over a relatively short period of time, enforcing the temporal nature of the city. All three photographs were taken from roughly the same vantage point, looking west on Sakaemachi dori. The first image is from 1931 (Figure 4.8), roughly 30 years after Kobe opened to the west. This image reflects the western influence on this neighborhood on the edge of the foreign settlement. Sixty years later (Figure 4.9), at the height of the 'bubble' economy, one monolithic building survived the construction boom and the area is captured as busy and prosperous. By 2001, after the earthquake and the crash of the economy, the building stock is completely different again, with the exception of a standard mid-rise concrete office building, likely built in the 1980's. The monolithic building in the foreground has been replaced by two standard office buildings. (Figure 4.10)



Figure 4.8 Sakaemachi dori (1931)



Figure 4.9 Sakaemachi dori (1991)



Figure 4.10 Sakaemachi dori (2001)

4.4 Conclusions

After having understood the site context in terms of its gaps, this study concluded that although rarely transgressed or even noticed, these interstitial voids are critically important to perpetuating the unique character and formation of urban space in Japan. They also inadvertently capture the extremities of Japanese spatial values including smallness, darkness, irregularity, and emptiness. Each gap has a unique spatial experience. Through transgressing the public/private boundary between street and gap, entering a gap space removes one from the typical experience of the city. Light is filtered, sound is dampened, and the loneliness of occupying an empty vessel removes one physically and emotionally from the busyness of the surrounding city. This analysis demonstrates the complexity of this network of negative space and its connection to the city across both space and time.

Artist Gordon Matta Clark saw the potential of these spaces, although in a different context. His project, *Odd Lots*, was the first work of this kind to document and observe the interesting qualities of fragmented and forgotten urban space in New York City. He said, "It's the gaps, the left-over spaces, that serve as opportunities".

5. Curating the Interstice

“The simplest way to create complexity was one of the formal concerns here, without having to make or build anything”.

Gordon Matta Clark

5.1 Project Defined: Art Site Sakaemachi

This thesis engages with the gaps in the Sakaemachi neighborhood of central Kobe, offering a proposal to exploit the gap. This project envisions Sakaemachi’s gaps as a collection to be curated, creating an infrastructure that supports this network of gaps as an ‘art site’, using art as an agent to fill them with temporary site specific installations and inviting the public to transgress the void. The purpose of this project is to understand these gaps as representative spaces of change, exploring temporality but also questioning the value of a negative space through overlaying the notion of impregnating the void.

5.2 Precedent Study: Naoshima

Since Sakaemachi is currently undergoing revitalization as an artisan district, the project was inspired by the contribution of arts projects to revitalization and sought to create a project in-line with the residents and workers of Sakaemachi. Following the precedent of Naoshima, Echigo Tsumari and other projects in Japan that work to revitalize rural areas through creating site-specific art and architecture exhibition where visitors arrive at a site, receive a map, and then go out again to experience the landscape in a new context, this project envisions a similar model in an urban setting.

What began in Naoshima in the 1980s saw the island as a once beautiful utopia, marred by a greedy past and now faced with exacerbated symptoms of the issues plaguing Japan—aging population, environmental destruction, and economic recession. The Benesse Corporation moved onto the island with the intent to revitalize the community using contemporary art, a medium for commenting on the modern condition of Japan. Here, architecture is an intervention of site, mediating between what exists and what can become.

The built interventions on Naoshima, Teshima, and Inujima are characterized by the museum typology. These museums are in the form of site specific art works on permanent exhibit and ‘art houses’ where dilapidated homes (a product of a dying community) are repurposed for new contemplation. The museum is not a set of white walls where art, people, and time come and go to escape the reality of the world outside. The museum is active, integrated, and purposeful. It is in critical dialogue with contemporary conditions and changes relative to it. These projects redefine site specificity through the integrated process of creating and maintaining relationships with the surrounding context. The approach to site is not a top-down consideration working from context (nature) to content (art) where we are given a site, we build something on it, fill it with something, and then leave it to function as intended. Instead, site is seen as a multi-directional conversation between the creation of architecture in collaboration with art (content) and nature (context); a conversation that continues long after the architect and artist has finished his or her work.



Figure 5.1 Otsunaka Dori, Sakaemachi

The best example of site specificity is the recently completed Teshima Art Museum (Figure 5.4), a collaboration between architect Ryue Nishizawa and artist Rei Naito. The amorphous concrete drop on a terraced rice field contains an ever changing display of water as it seeks its own path, regenerating new forms and landscapes. The Teshima Art Museum embodies a new definition of site for both artists and architects. The exhibit is entirely dependent upon the specificity of the architecture. Alternatively, the concrete shell would be a dumb form without the artistic content. The complex relationship between context and content are not limited through their specificity but instead create an experience that simply must be what it is--an infinitely new understanding of a place. From the slight undulations in the floor that allow for the water drops to follow gravity to the two gaping holes in the top of the shell which shed light, weather, and an ever-changing shadow onto the experience, the art and architecture cannot be separated from one another. Further, the surrounding natural landscape is integral to the creation of this specific architecture. The contained space is neither indoor nor outdoor and the path that leads to the exhibit is an armature for the architecture. Just outside these walls, the abandoned rice fields begin a process of revitalization, a change instigated by the architecture; the architecture compelled by the context in which it finds itself.

Art Site Sakaemachi envisions a similar collaborative process between architect and artist and consideration of the site-specificity of the project.

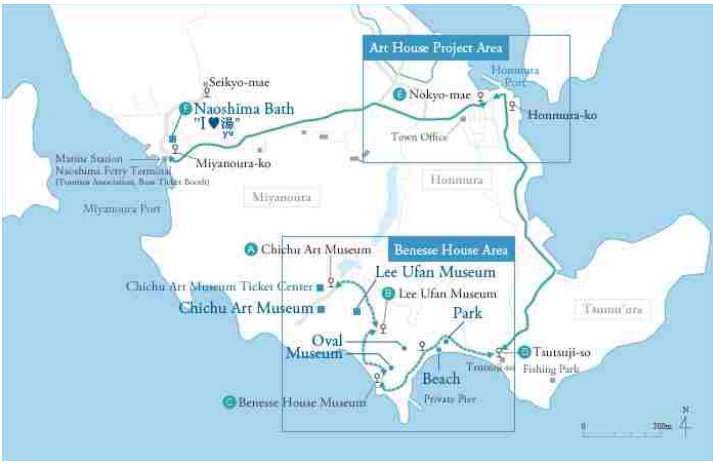

Figure 5.2 Map of Naoshima



Figure 5.3 Go'o Shrine on Naoshima, Hiroshi Sugimoto



Figure 5.4 Teshima Art Museum, Ryue Nishizawa (architect) and Rei Naito (artist)

5.3 Process and Program

This project creates an infrastructure that supports this network of voids, providing a collaborative platform for curator and artist. The curator's essential purpose is to orchestrate a vision between site and art. In this case, the curator also plays the role of the architect. The curator selects the voids and prepares the space according to its inherent spatial qualities through minimal architectural intervention. A resident artist is invited to respond through impregnating the void with a temporary site-specific work. Prior to installation, the artist is invited to occupy their gap, developing an intimate relationship with the space in order to respond accordingly and specifically. Finally, the public is invited to transgress into these gaps. Each individual site becomes a found public space, however, the project as a whole envisions the cumulative void space of Sakaemachi into new and accessible urban space. While this process is happening in a number of gaps, a central facility, located in a larger gap, is a vital element in this process, working to maintain and perpetuate the art site.

Of the forty-eight gaps studied in the previous chapter, four were selected to represent Art Site Sakaemachi in its present configuration. (Figure 5.6) Three of these will be filled as installation spaces or 'gap galleries'. (Figure 5.8) These spaces will be prepared by the curator through minimal architectural intervention to later receive a site specific installation by an artist in residence who has been invited by the curator to create a site-specific work. Therefore, these installation spaces host multiple iterations of intervention or 'fill'.

Number 16, a more typical infill gap, measuring 34' x 70', was chosen to install the auxiliary building, a slightly more permanent structure with a lifespan of 3-5 years that houses the basic infrastructure to support the art site. (Figure 5.9)



Figure 5.5 Sakaemachi



Figure 5.6 Art Site Sakaemachi

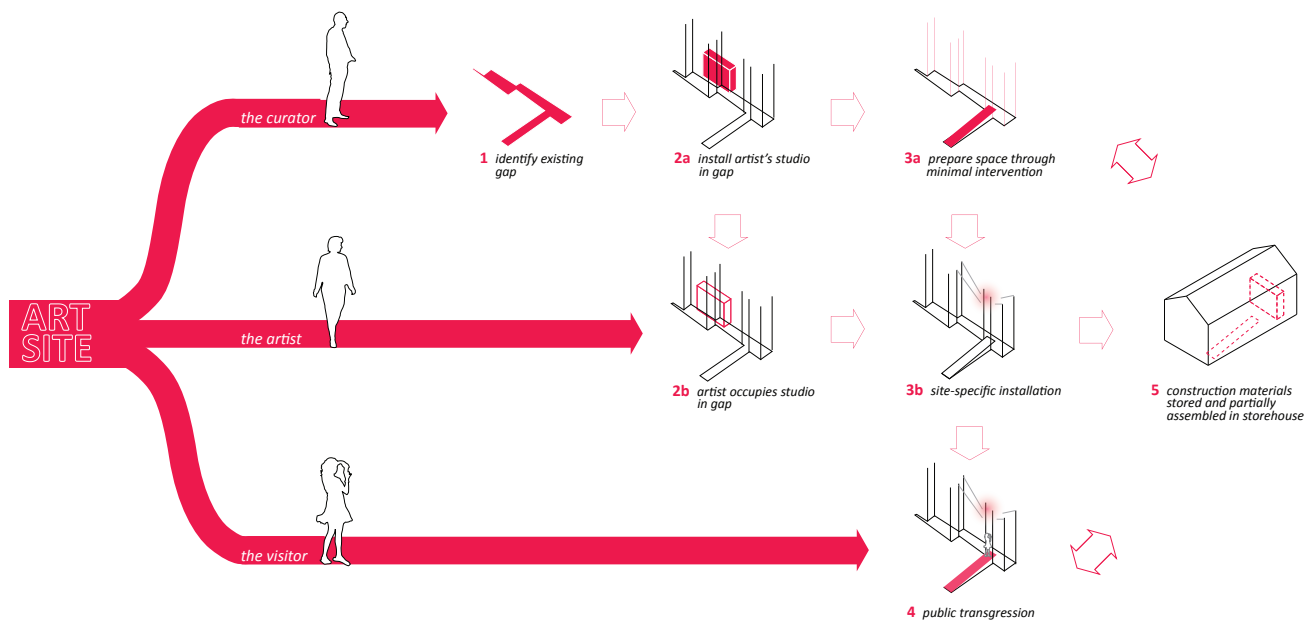

Figure 5.7 Art Site Process

The central storehouse contains the bulk of the program for the project. Here, all of the building material is stored and staged as the interventions and artist space are moved in and out of various surrounding gaps. The curator’s studio is also located here. It is the center for the art site, although its location and form also changes over time.

One of the main purposes of the Art Site is to explore space as it changes over time. This temporality of the site is felt in two ways. Not only are the installations themselves temporary, but the location and experience of the site in its entirety is always changing. This is a response to both the changing urban form that creates the gap spaces and to the general changeable nature of space in Japan. Each experience of the site is unique. Figure 5.10 imagines the Art Site 6 months from now. The gap galleries have changed but the central storehouse, a semi-permanent fixture, is still in the same gap. Envisioning the site in 5 years (Figure 5.11), the installation gaps have continued to change and now the central facility has relocated and taken a new form elsewhere on the site.

The visitor’s experience to the site is either intentional or unintentional. A visitor may be drawn to Sakaemachi, learning previously of the Art Site Project. In this case, the visitor intentionally visits the gap galleries and central facility in no particular order. The Art Site can also be a found experience, and this is the case for the majority of its visitors. A visitor wandering through Sakaemachi begins to notice that something is happening. Markers on the street draw attention towards the selected gaps. An unknowing visitor transgresses the space, unsure of whether or not they are trespassing. As they experience a gap installation, they begin to wander, looking into the gaps, wondering if there are others containing similar projects. Free newspaper vending machines distribute maps of the Art Site, drawing a suggested path for the visitor. Perhaps the visitor has found the map, or perhaps they have experienced their own path. The concept for the

Gap Galleries

Program #1: Occupying the Gap

Artist in residence studio
Lifespan: 1-3 months

Program #2: Experiencing the Gap

Curator's Intervention + Artist's Installation
Lifespan: 3-6 months



Figure 5.8 Three installation spaces in Art Site Sakaemachi

Storehouse (kura)

Program: Maintaining the Gap

Material storage and workshop
Curator's studio
Public restrooms
Welcome center / archive
Lifespan: 3-5 years



Figure 5.9 Central storehouse facility in Art Site Sakaemachi



Figure 5.10 Art Site Sakaemachi (6 months later)



Figure 5.11 Art Site Sakaemachi (5 years later)

Art Site is that it is entirely decentralized, therefore, both intentional or unintentional viewership and experience is encouraged. Additionally, since the form of the Art Site is always changing, this project imagines that each time someone revisits the site, they draw a new path and new experience of the place.

5.4 Construction System

An identifiable material palette and construction system was developed to be used in constructing the art site. Figure 5.12 summarizes the five stages of use of the site and their relationship to a singular construction system. Scaffolding was employed as a flexible, reusable, and temporal frame that easily adapts to a variety of forms. Scaffolding is also representative of space undergoing change; of cities under construction, a constant process and staple image of Japan. This is the ideal system to construct each phase of Art Site because it can be reconfigured according to the form of the gap and the scale of the project, whether it is the curator's minimal intervention, the artist in residence perch, or the central facility. This system represents temporality.

These are several examples of scaffolding, including typical steel scaffolding. Figures 5.13 demonstrates how scaffolding can conform to a variety of spaces as a flexible system and Figure 5.14 shows how one can move through this frame simply with plywood platforms and ladders. The light frame of the scaffold simply dissolves into the surrounding city or landscape. It is neither a solid or voids space, nor is it experienced as one or the other. Other varieties of scaffolding include bamboo, a popular scaffolding structure in Asia because of its lightweight and flexible qualities and its availability. In Japan, round wood logs called maruta are used as scaffolding. Similar to bamboo, this system is assembled using tied connections.

This project uses a ring-lock steel scaffold system, selected for its longevity and structural stability.

art site components

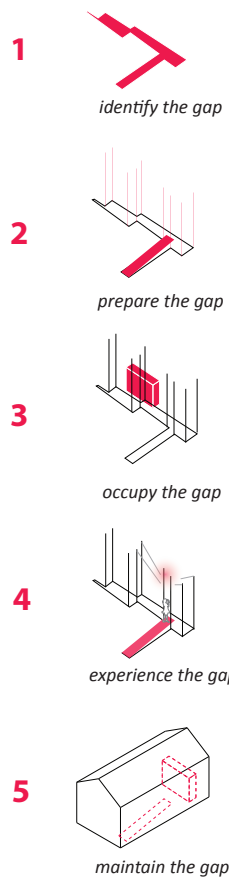

construction system

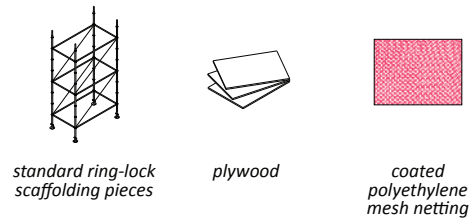

Figure 5.12 Art Site components and construction system

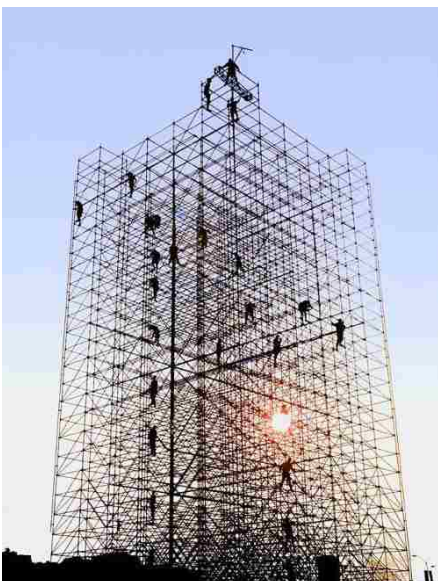

Figure 5.13 Scaffolding as neither solid nor void



Figure 5.14 Scaffolding conforming to unique form

Part 6: Art Site Sakaemachi

This sections outlines the design proposal for Art Site Sakaemachi. Each step of creating the Art Site is outlined and rendered, including an explanation of the curator's role and intention for each space.

6.1 Identifying the Gap

The curator is responsible for identifying a number of gaps that will be used as installation space. This process has already been outlined in Chapter 5. In the current configuration of the Art Site, three gaps have been selected for installation space and one larger site was selected for the central facility. These gaps are documented below. For the sake of representation, each of the three gaps is rendered once to demonstrate one stage in the art site process.

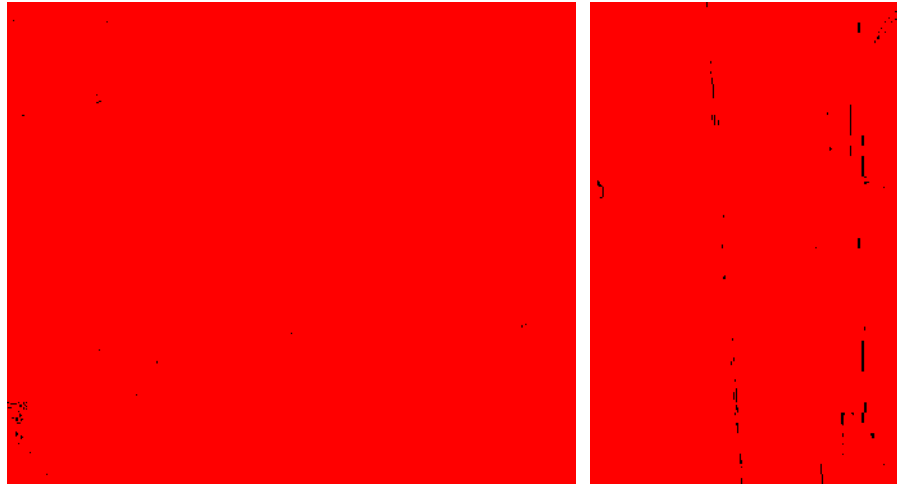
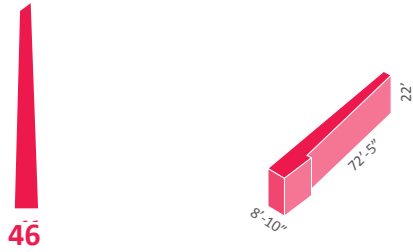

Figure 6.1 Gap #46 Elevation and sky

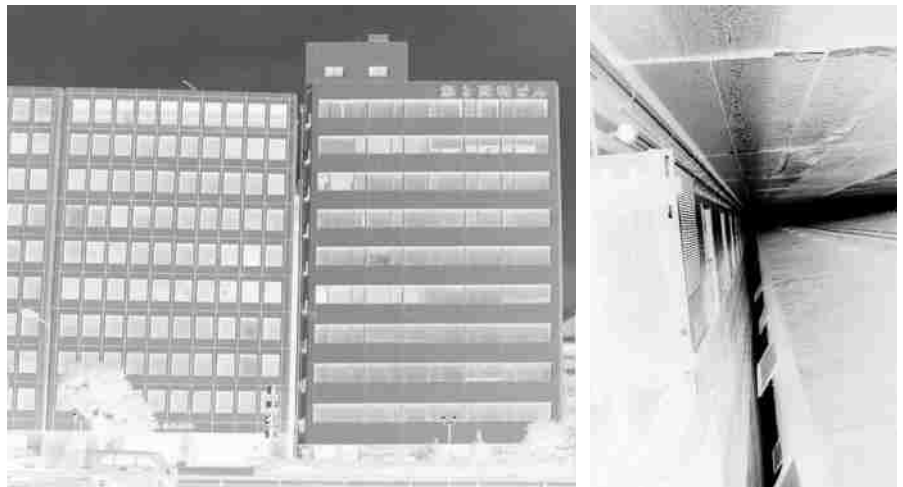
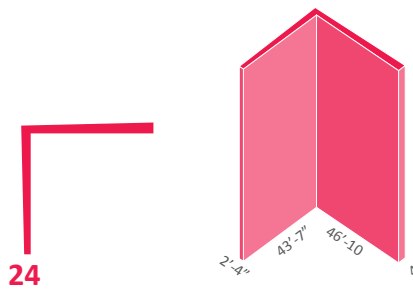

Figure 6.2 Gap #24 Elevation and sky

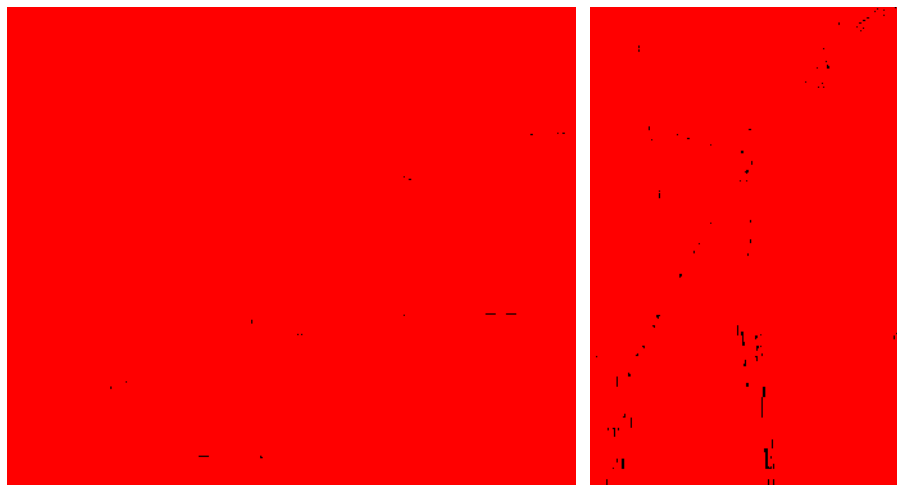
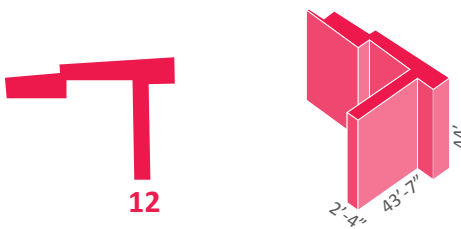

Figure 6.3 Gap #12 Elevation and sky

46

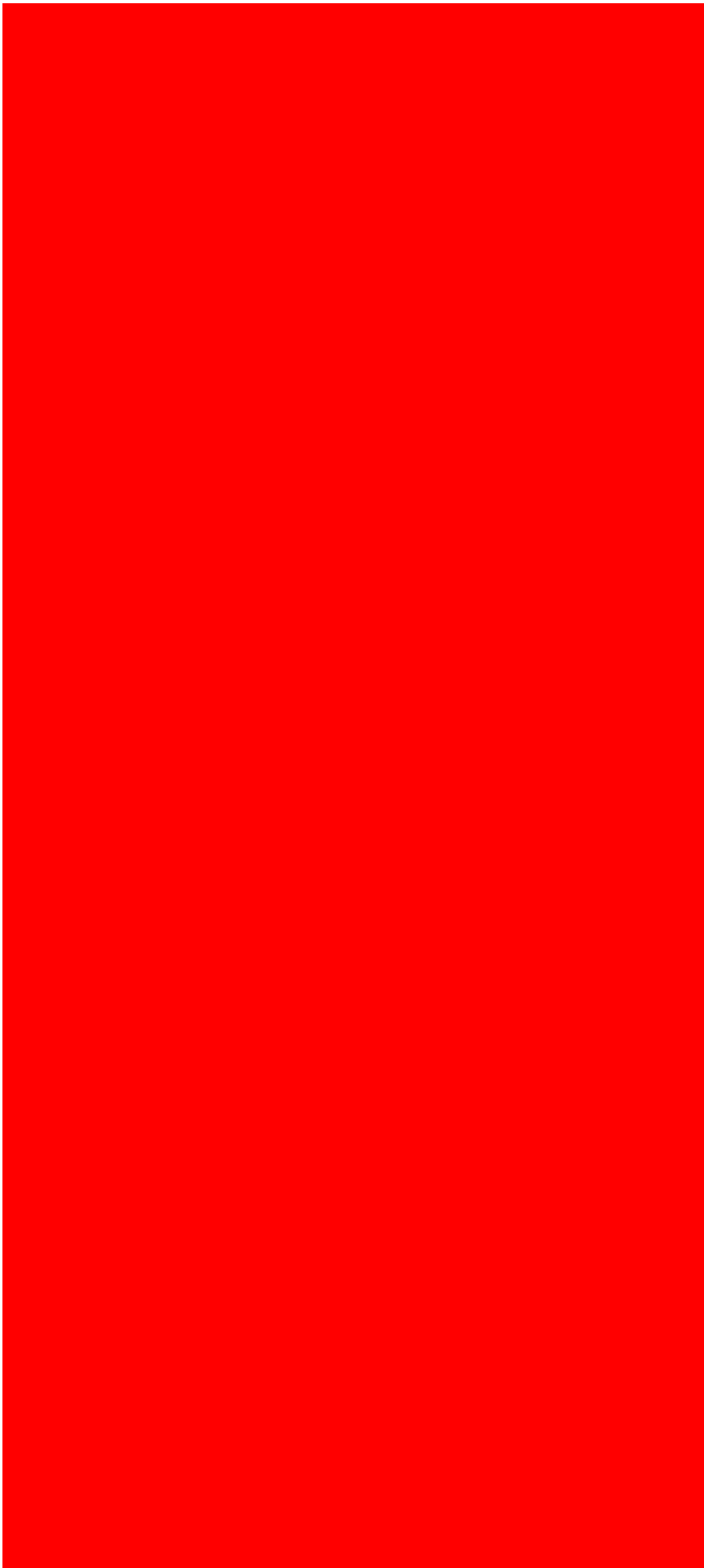

Figure 6.4 Gap #46 Existing conditions

24



Figure 6.5 Gap #24 Existing conditions

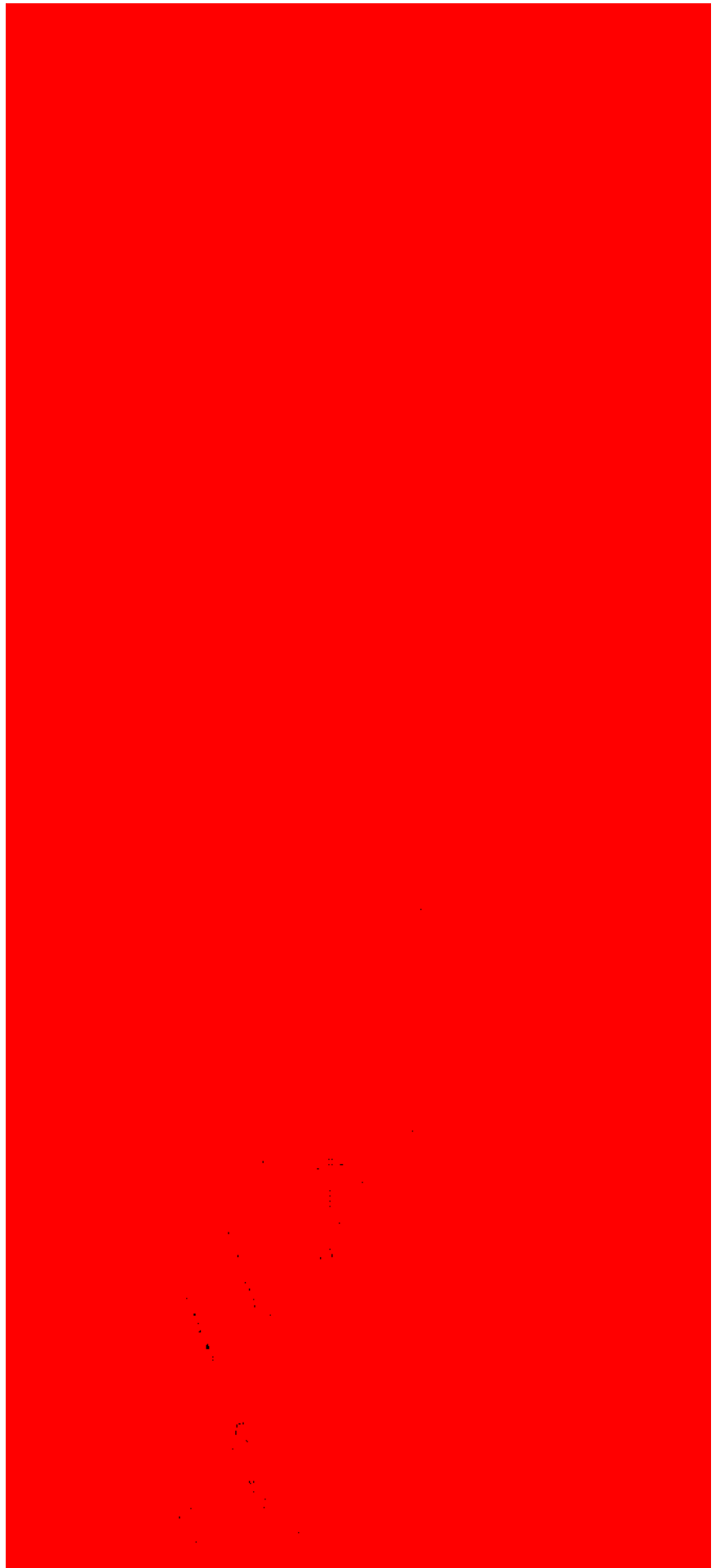
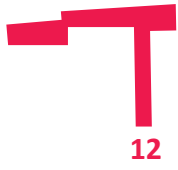

Figure 6.6 Gap #12 Existing conditions

6.2 Preparing the Gap

Prior to the artist coming to the site to prepare an installation, the curator has conceptualized a vision for the gap gallery. The intention for each intervention is to respond to the inherent qualities of the void. The existing conditions of the found space are all similar: walls, ground and ceiling planes (sky), however a number of variables including width, height, edge conditions, accessibility, renders the transgression into each gap a unique spatial experience. The interventions focus on particular spatial qualities of voids and use these as the language for the intervention. The process for developing these individual interventions is through defining that exploitative quality. The curator then invites a particular artists to complete the space.

Each intervention is prepared by the curator and is minimal. Materiality is restricted to reusable structural components of the scaffolding and plywood with an overlay of additional ephemeral things perhaps such as color (paint), water, or light.

In the case of gap #46, the space is open between both ends, offering a physical and visual connection through. The building that forms the gap on the west side is slightly skewed, creating a natural forced perspective in the space. The curator conceptualized this space around the idea of perspective. The curator has invited a sculpture artist to prepare something site-specific for this space.

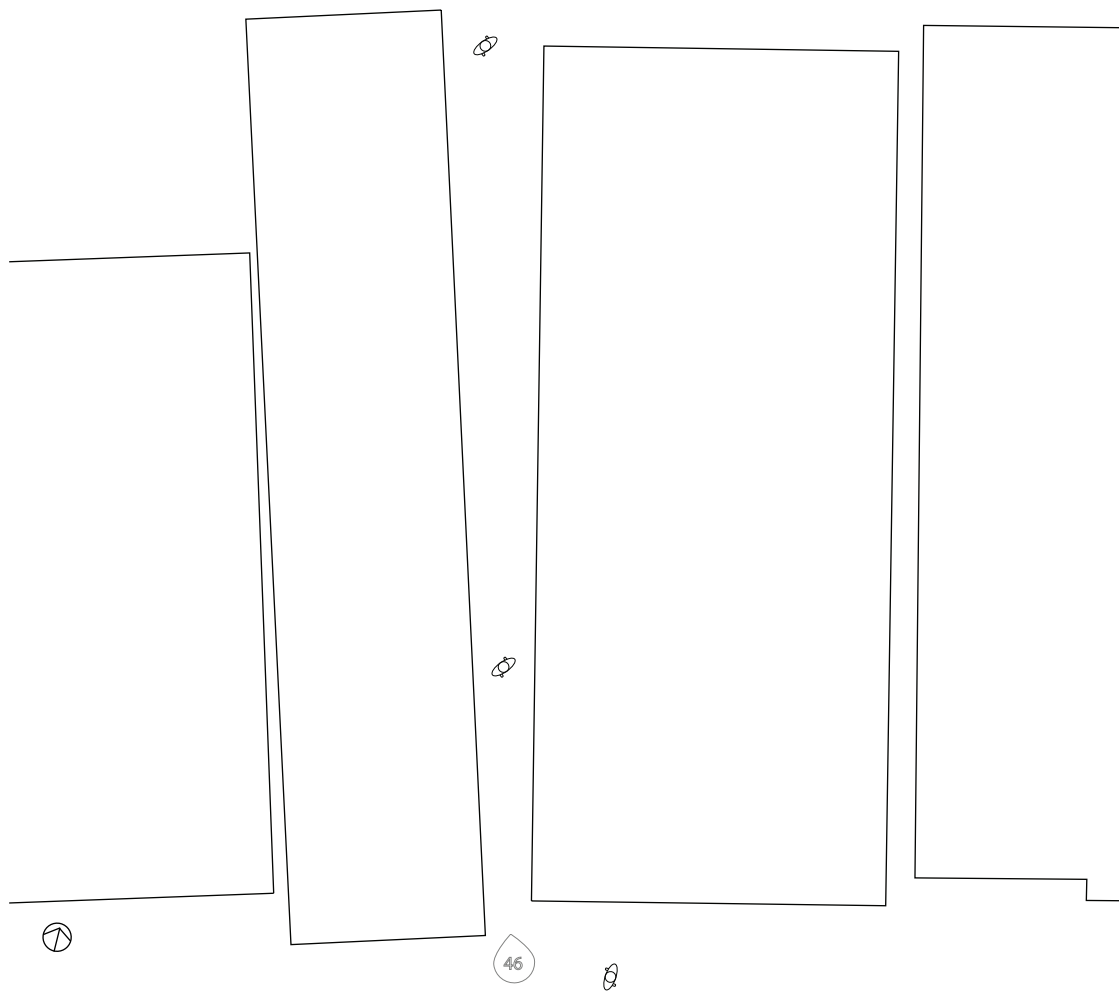

Figure 6.7 Gap #46 Plan
scale 1/16"=1'

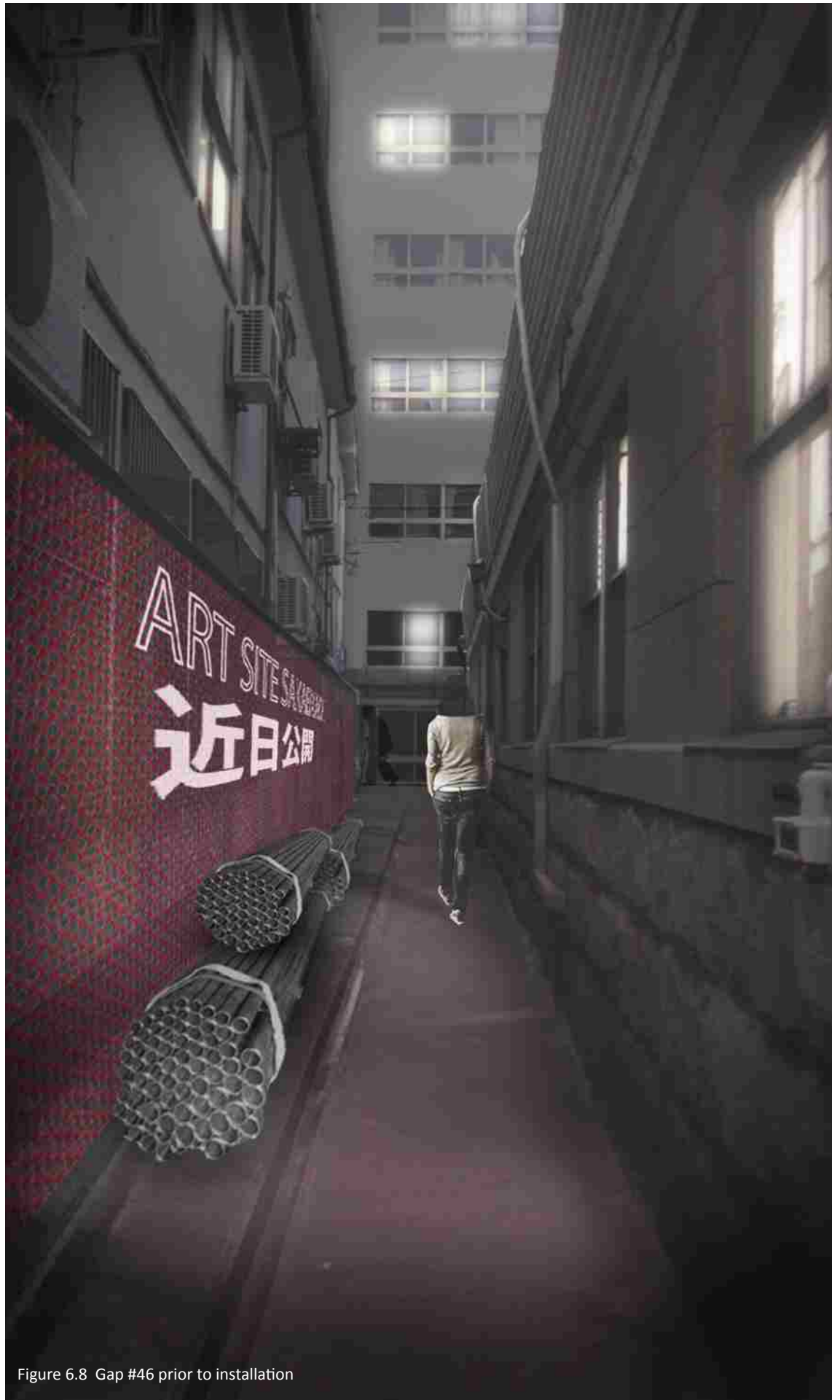

Figure 6.8 Gap #46 prior to installation

6.3 Occupying the Gap

Occupying the gap is an intermediate step between the curator's vision of the space and the full realization of the artists installation in situ. In this exploration, the curator uses the scaffolding materials to prepare a minimal space for the artist. The artist is invited to use this space as a studio or simply as a perch which offers a different vantage point and understanding of the particularities of the specific gap. It also explores another temporal scale and use of the scaffolding to fulfill this purpose.

In the case of gap #24, the space is 110' tall and 3'10" at the widest point. This gap is truly a canyon in the middle of the city. The light is dim and the sound is dampened. The curator's preparation is to respond to this extreme scale and the quality of light as moves from the top to the bottom of the gap. The scaffolding is configured as a tower in which the artist can ascend up into the space, experiencing the quality of light as it is filtered through to the ground. A simple series of platforms and ladders allows the artist to move through the scaffolding. At the top, the artist has a perch in which to look out into the space or perhaps up at the sky. This structure exists in the gap for the period of the artists residency, typically 1-3 months. When it is dismantled, the materials are returned to the central storehouse.

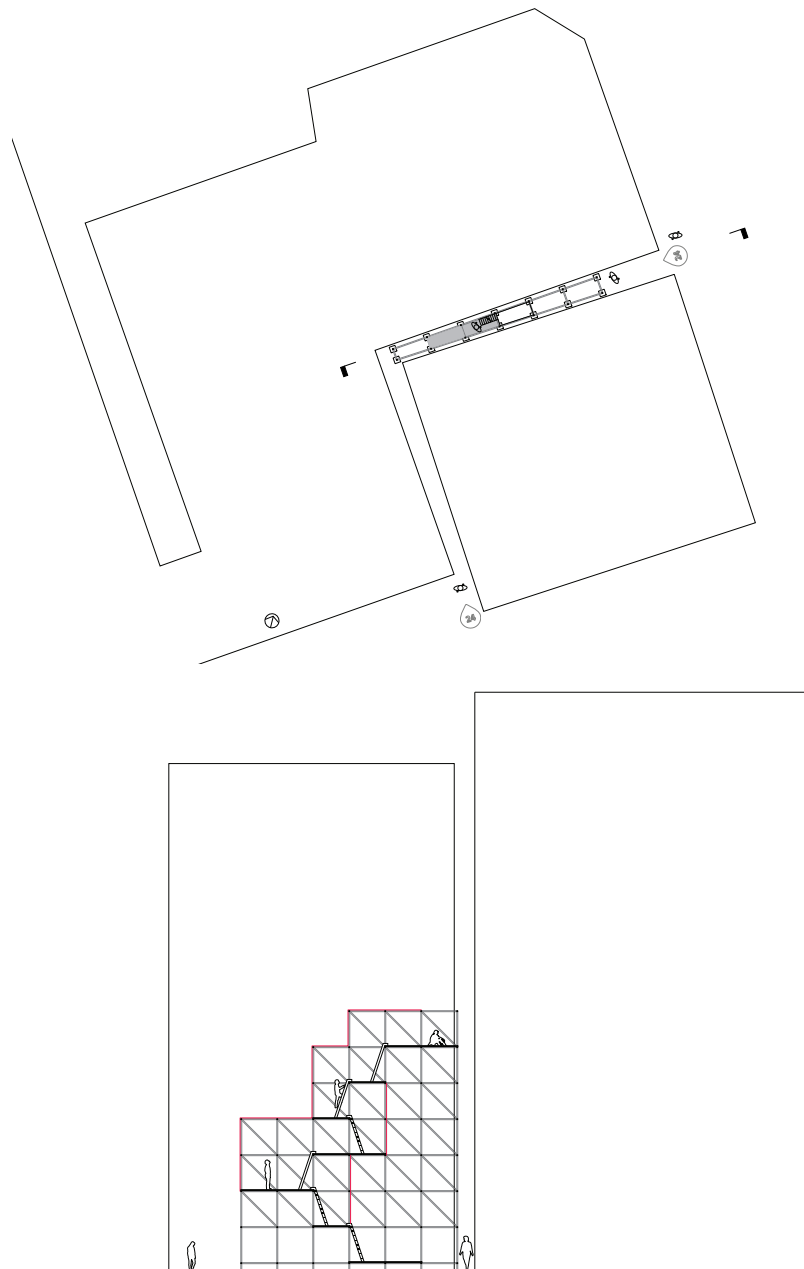

Figure 6.9 Gap #24 Plan and Section
scale 1/32"=1'

24



Figure 6.10 Gap #24 with artist's perch

6.4 Experiencing the Gap

Finally, the scaffolding of the artist in residence space is moved out and the final stage of the gap gallery is installed. Once the curator has planned the space and the artist has created a site-specific installation, the gap is opened to the public. In this rendering, gap #12, shows the merging of the curator's preparation, a simple ramp that leads up into the space, and the artist's installation, which is unknown but rendered here as a pink orb.

In this space, the curator has identified the ground and sky plane as the exploitative qualities, therefore the intervention is a device that suspends the visitor between these two planes, a simple ramp constructed from scaffolding. A secondary element is a mirrored surface on the ground which reflects the sky and the artist's installation. In this case, the curator has required a hanging installation by the artist.

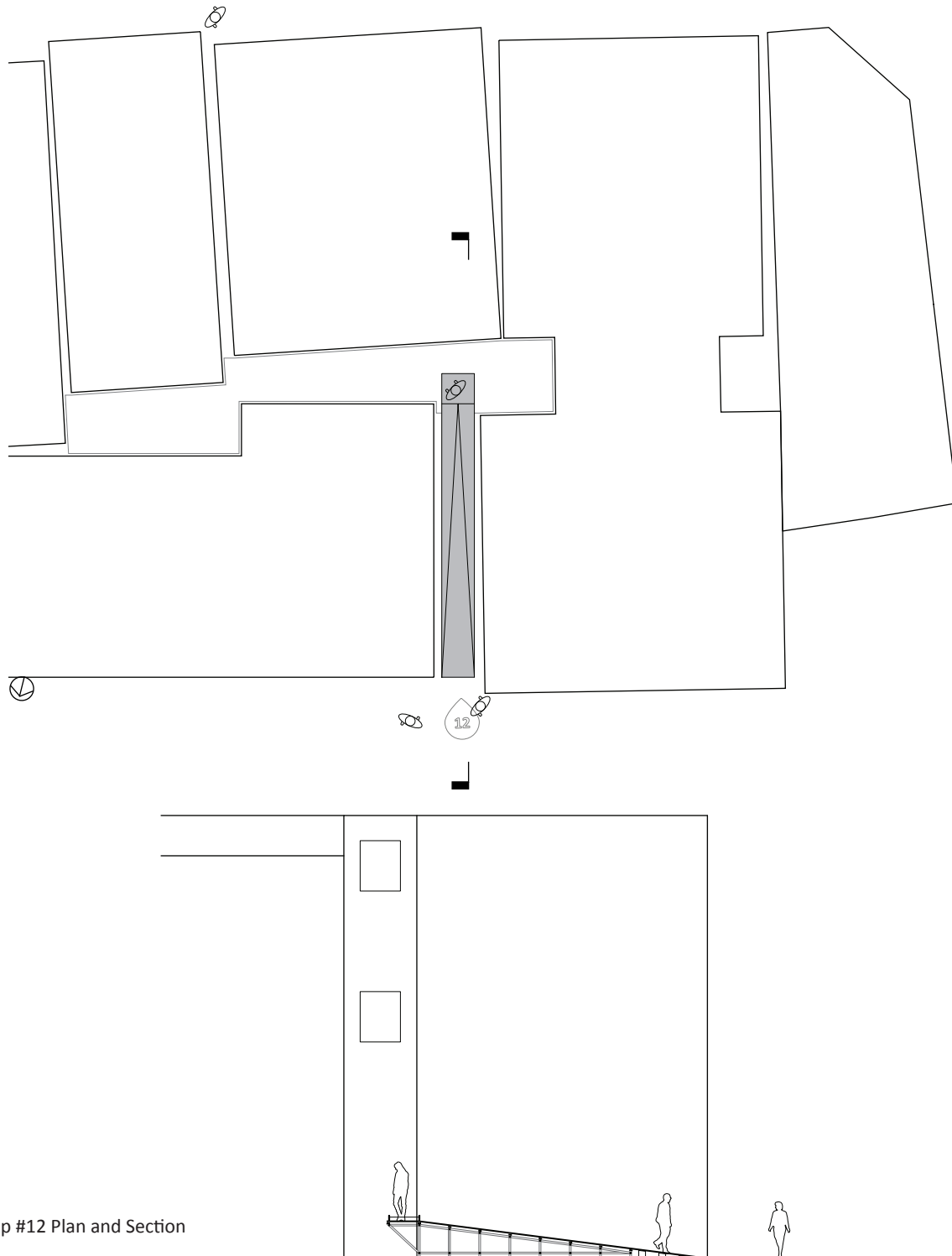

Figure 6.11 Gap #12 Plan and Section
scale 1/16"=1'

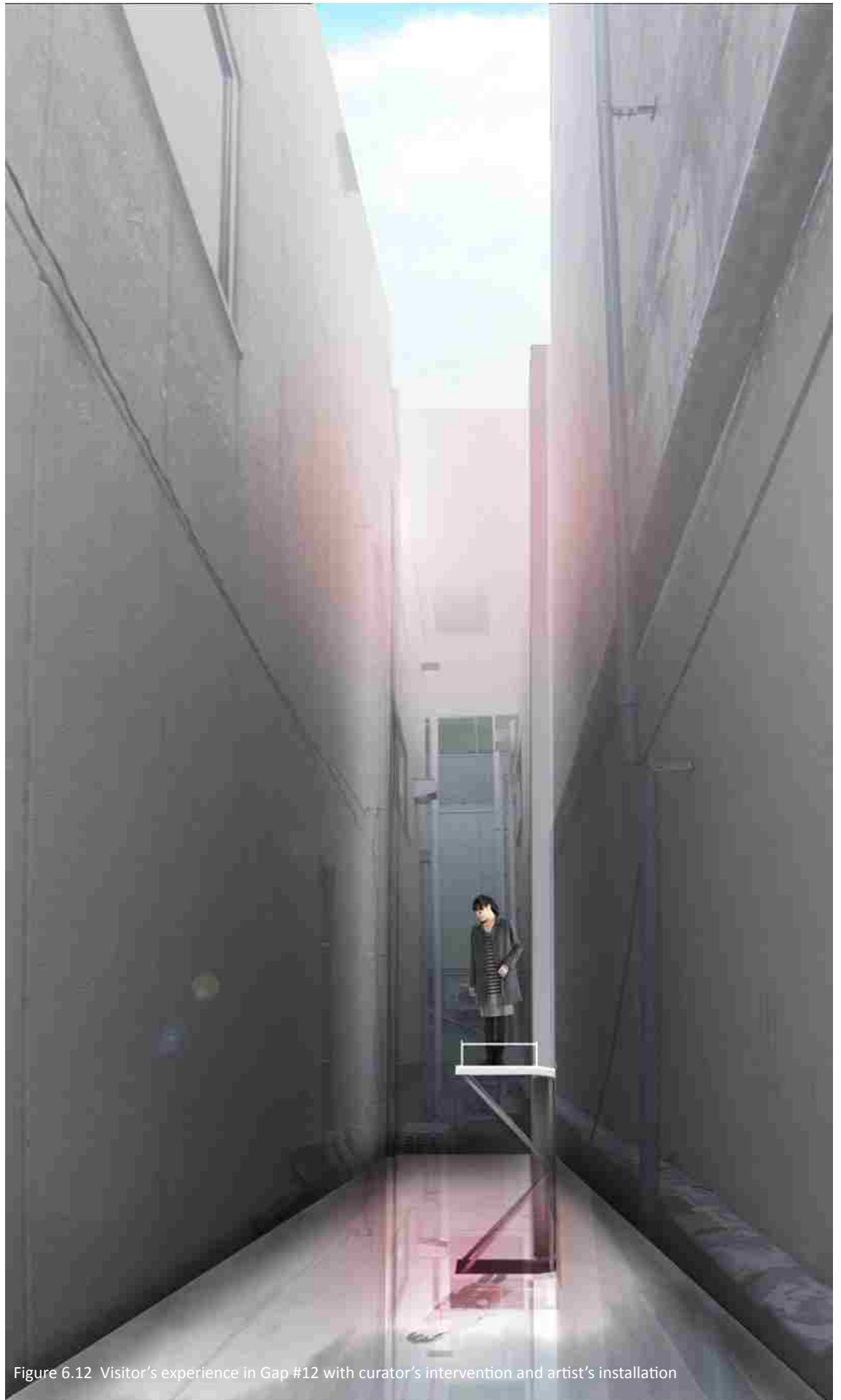
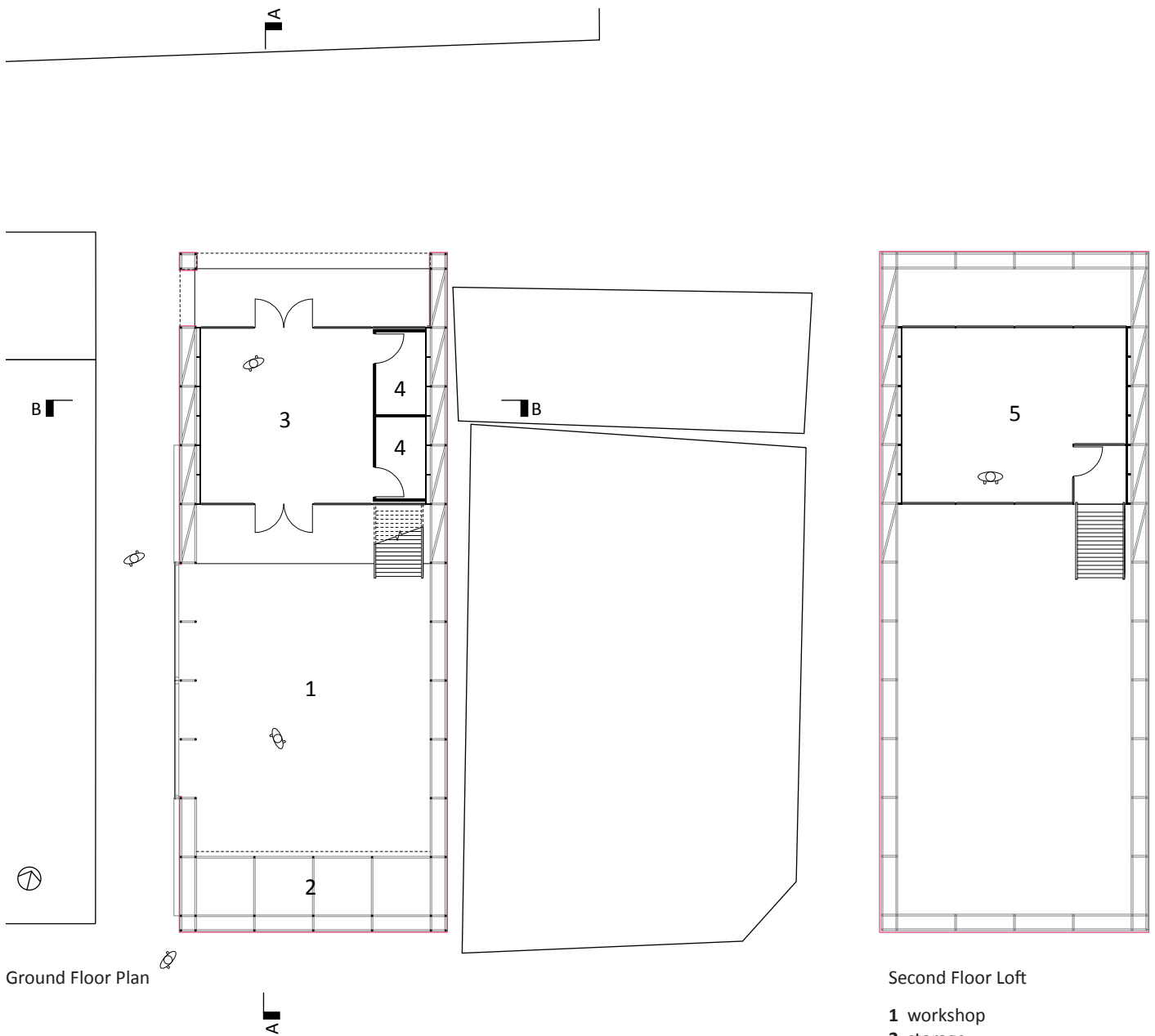

Figure 6.12 Visitor's experience in Gap #12 with curator's intervention and artist's installation

6.3 Maintaining the Gap

This central facility houses the basic infrastructure to maintain Art Site Sakaemachi. This building is necessary for the functioning and proliferation of the project. The curator works out of the storehouse and this facility is the central point that links the scattered temporary installation sites around Sakaemachi. The main purpose of the facility is to act as a storehouse for the scaffolding and other materials that are used in the preparation and interventions in situ. It provides a large unconditioned area for this storage and staging of the installations. This large area, which opens into a gap created between the storehouse and the adjacent building, can also be converted into an event space. Members of the community and local artists A small conditioned space at the rear of the building provides a welcome center and public restrooms at ground level. Included in this space is a small archive that preserves the record of Sakaemachi's gaps and previous projects. A lofted space above provides the curator with a studio and meeting room.



Ground Floor Plan

Second Floor Loft

- 1 workshop
- 2 storage
- 3 welcome center / archive
- 4 public restrooms
- 5 curator's studio

Figure 6.13 Gap #16 Plans
scale 1/16"=1'

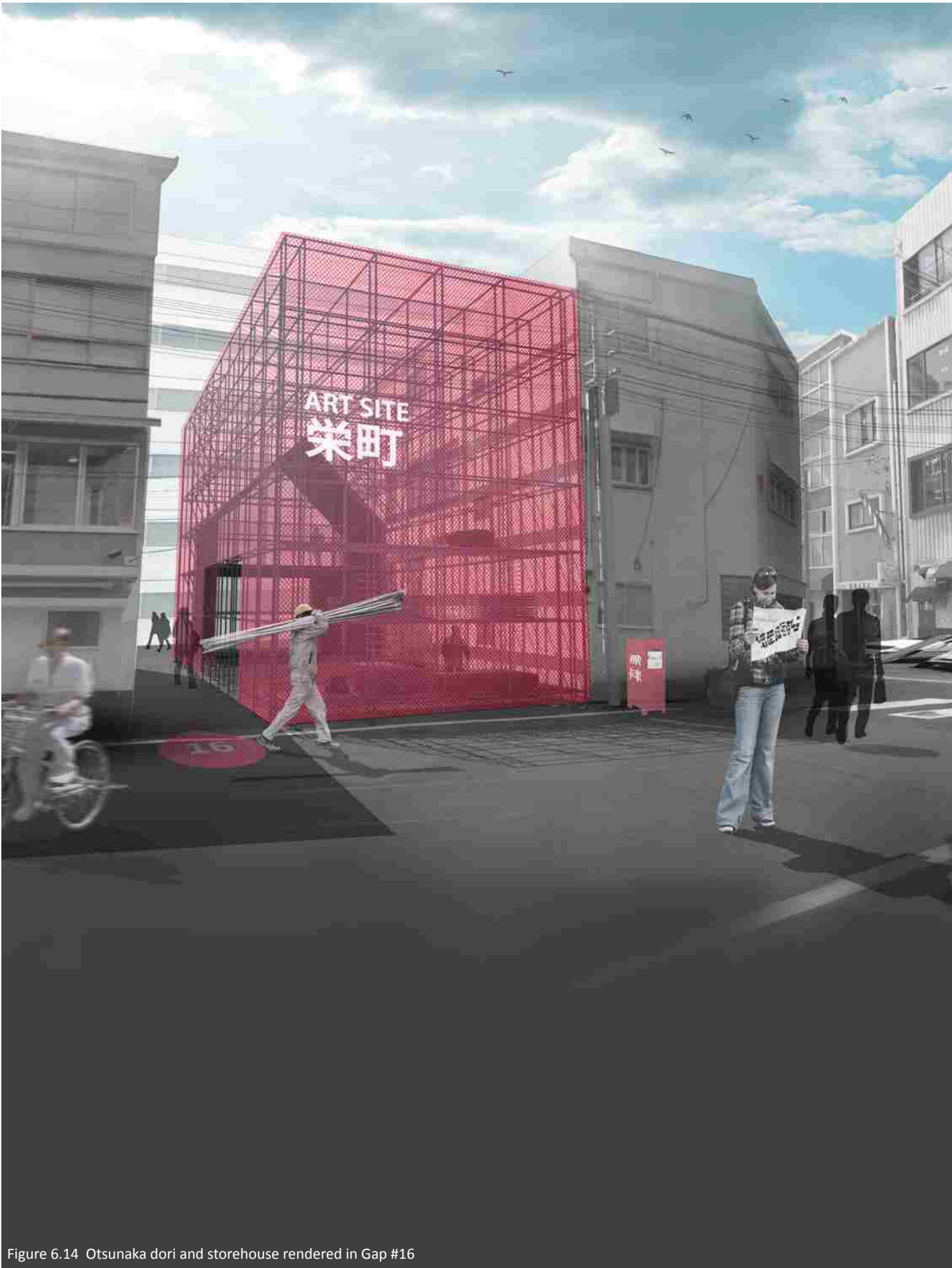

Figure 6.14 Otsunaka dori and storehouse rendered in Gap #16

This structure is supported entirely from scaffolding. The frame of the scaffolding creates a gabled shape, reflecting the traditional form of a Japanese storehouse, or *kura*. A plywood box is inserted into the frame at the north end of the structure and hung from the scaffolding. 2x4's are connected to the joints of the scaffold, connected by an attachment to the ring-lock system. Plywood panels are attached to the outer edge of the 2x4, creating a box. (Figure 6.16) Shelving and material storage is built into the frame at the south end of the structure.

Although this facility demonstrates the development of this construction system to the highest level of detail and semi-permanency, still, the facility is minimal in its materiality, maintaining the simple language of scaffold, plywood, and netting. The emphasis of the entire project is the use of these simple, reusable materials. Because this facility is temporary, this construction system touches the ground lightly, needing minimal excavation. The structure is imagined to last for 3-5 years and then disassembled and reassembled in a new infill site in Sakaemachi.

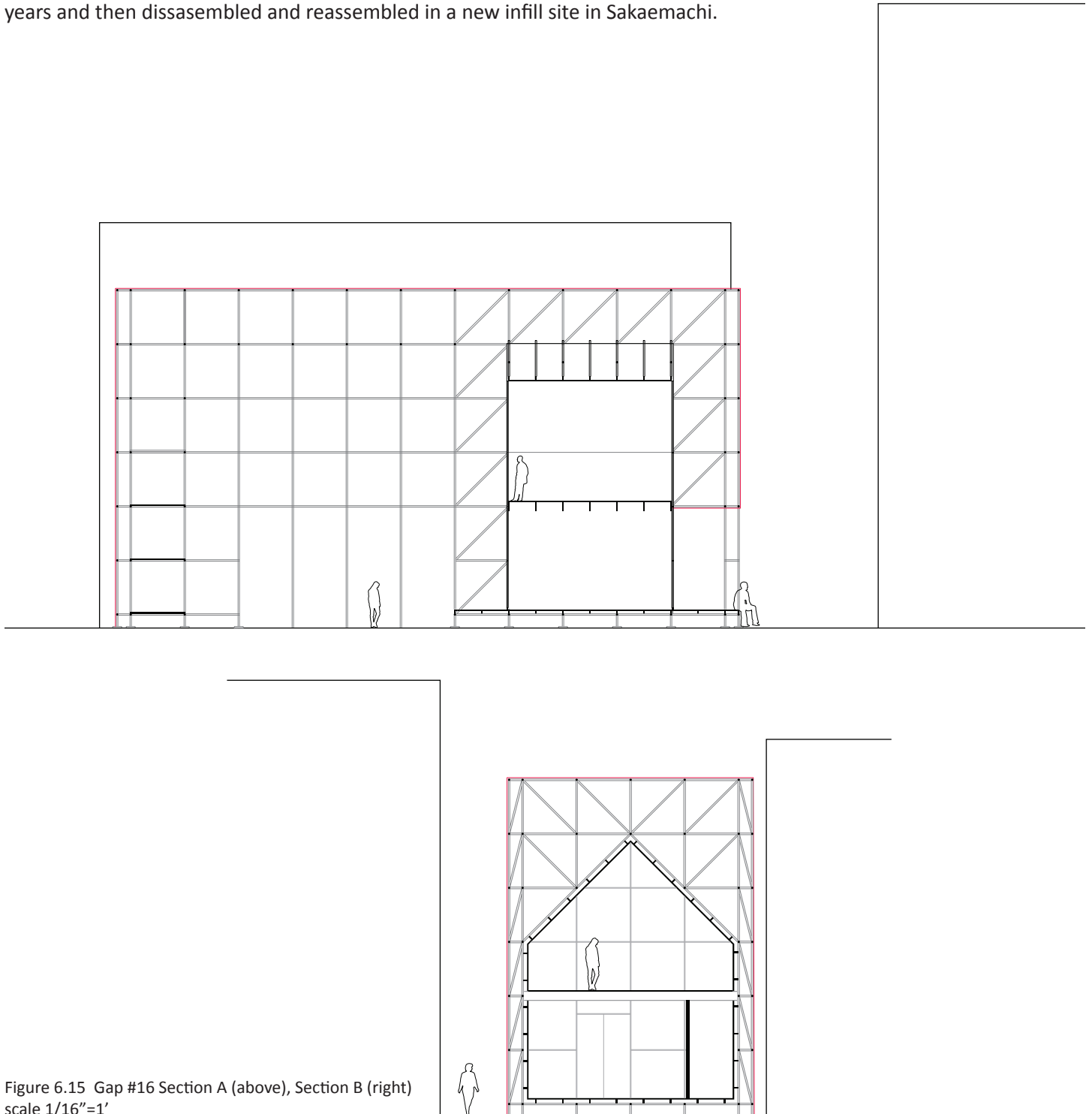

Figure 6.15 Gap #16 Section A (above), Section B (right)
scale 1/16"=1'

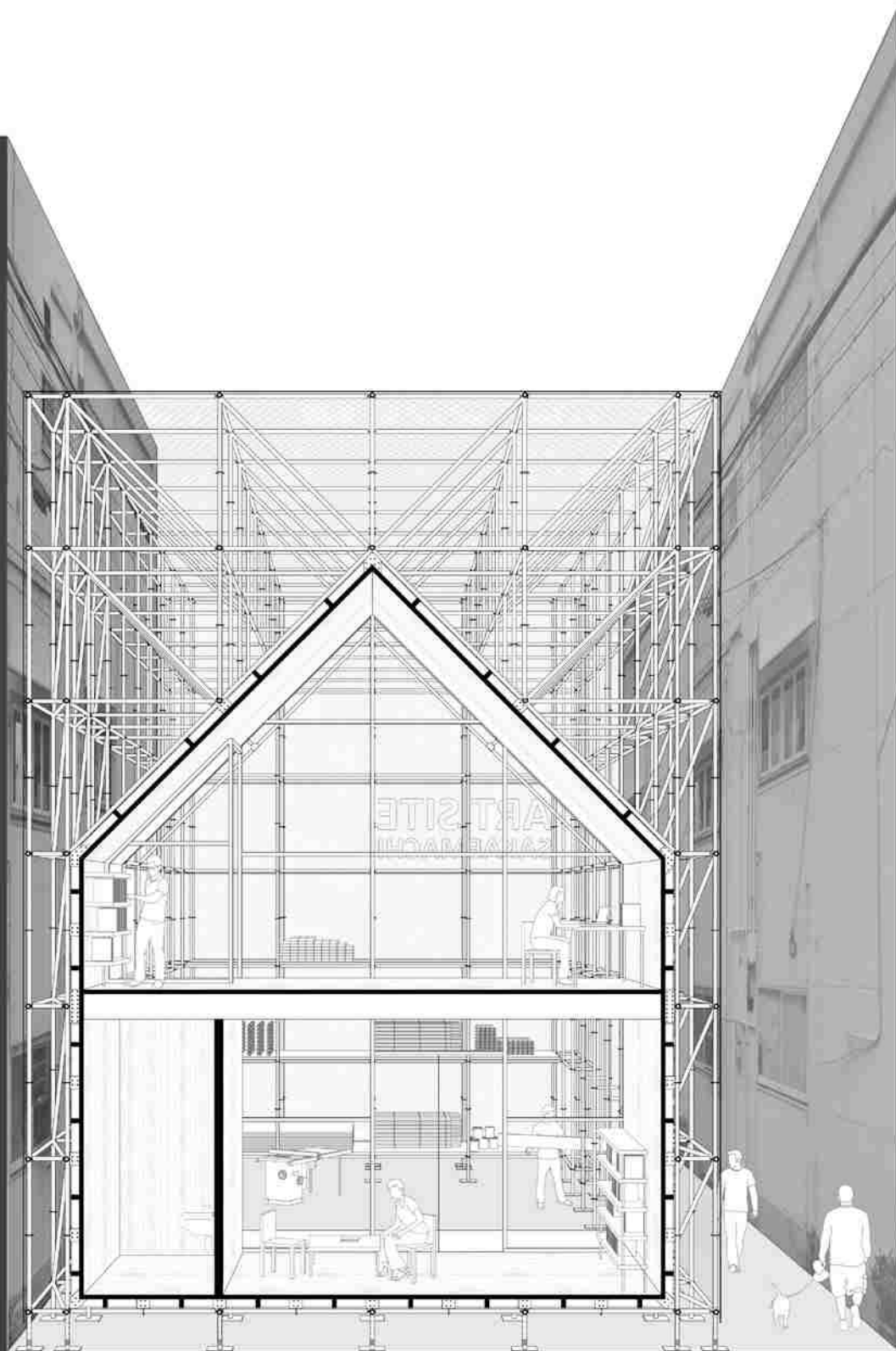

Figure 6.16 Section perspective of storehouse in Gap #16

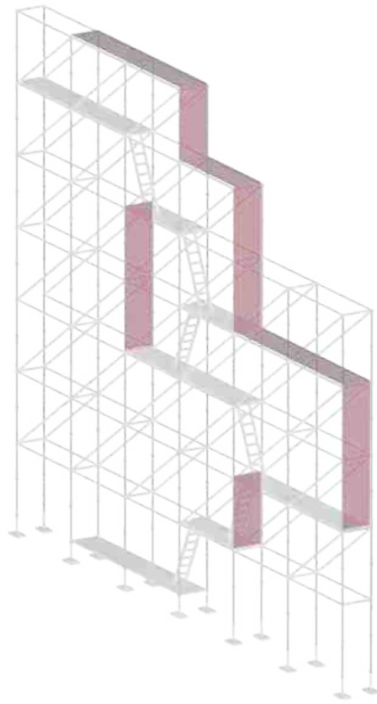

Figure 6.17 Use of scaffold to create artist's perch in Gap #24

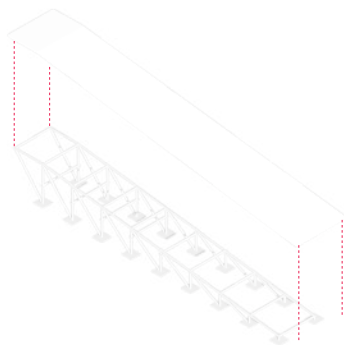

Figure 6.18 Use of scaffold for a ramp in Gap #12

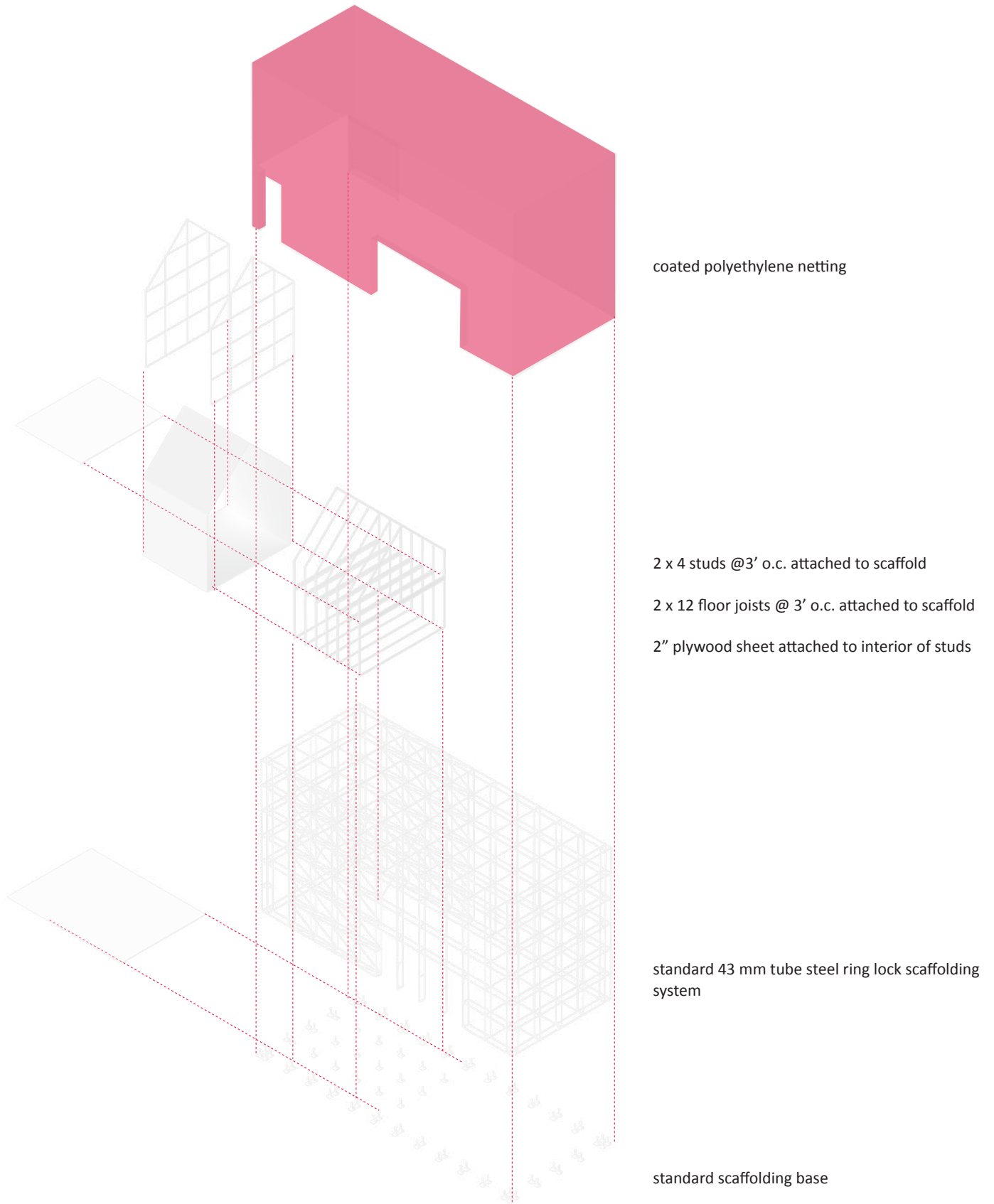

Figure 6.19 Tectonic axonometric of storehouse in Gap #16

Conclusion

Revisiting Kamo no Chomei's words, "The flowing river never stops and yet the water never stays the same. Foam floats upon the pools, scattering, re-forming, never lingering long. So it is with man and all his dwelling places here on earth," his opinion of the built environment, written over one thousand years ago, still resonates today. Building in Japan is a temporal act, reflecting the essential transience of the physical world. The Japanese city is the quintessential product of this longstanding attitude towards change.

Of this change reflected in the built environment, contemporary architect Mitsue Inoue says, "There is a consciousness that the present that we inhabit is nothing more than an instant wedged in eternal nothingness. From this comes the idea that human life and human dwellings are temporary shelters." Beyond temporality, Inoue suggests that 'eternal nothingness' or void is the essence of space. *Ma*, the spatial and temporal interval conceptualized in Japanese spatial theory and traditional cultural value, builds a fundamental connection between space, temporality, and the void.

Gaps, as both a physical void and a product of change suggest much more than a forgotten leftover in urban form. This thesis engages with the gaps in the Sakaemachi neighborhood of central Kobe as representative spaces of change, addressing the issues of temporality, questioning the void as a negative space, and offering a proposal to exploit the gap.

This thesis proposed a network of potential site-specific interventions using existing spatial and temporal qualities found in situ. The project, as a collaboration between artist and architect suggests a new role for the architect, that of the curator. Through curating Kobe's gaps, rather than developing or merely documenting them, this project uses art as an agent to engage and temporarily fill these spaces; the void remains intact. Art Site Sakaemachi represents one potential use of these forgotten, leftover, albeit critically important spaces.

Bibliography

Japan Specific Sources

- Chomei, Kamo , and Michael Hofmann. *Hojoki: Visions of a Torn World*. New York: Stone Bridge Press, 2009.
- Edgington, David W. *Reconstructing Kobe: The Geography of Crisis and Opportunity*. Vancouver: UBC Press, 2010.
- Hashimoto, Fumio. "Architecture in the Shoin Style" Kodansha, Tokyo. 1981.
- Hodge, David, and Hi-Jin K. Hodge. *Impermanence: Embracing Change*. Ithaca, N.Y: Snow Lion Publications, 2008.
- Inoue, Mitsuo. *Space in Japanese Architecture*. New York: Weatherhill, 1985.
- Isozaki, Arata. *Ma, Space-Time in Japan*. New York: Cooper-Hewitt Museum, 1979.
- Isozaki, Arata, and David B. Stewart. *Japan-ness in Architecture*. Cambridge, Mass: MIT Press, 2006.
- Kaijima, Momoyo, Junzō Kuroda, and Yoshiharu Tsukamoto. *Made in Tōkyō*. Tōkyō: Kajima Shuppankai, 2001.
- Keene, Donald. "Japanese Aesthetics." *Philosophy East and West: a Quarterly of Asian and Comparative Thought*. 19.3 (1969): 293-306.
- Kenkō, , Donald Keene, and Nishikawa Sukenobu. *Essays in Idleness: The Tsurezuregusa of Kenkō*. New York: Columbia University Press, 1967.
- Kitayama, Kō, Yoshiharu Tsukamoto, and Ryūe Nishizawa. *Tokyo Metabolizing*. Tōkyō: TOTO Shuppan, 2010.
- Koolhaas, Rem, Hans-Ulrich Obrist, Kayoko Ota, and James Westcott. *Project Japan: Metabolism Talks*. Köln: TASCHEN GmbH, 2011.
- Kurokawa, Kishō. *Rediscovering Japanese Space*. New York: Weatherhill, 1988.
- Müller, Lars, Akiko Miki, and Iwan Baan. *Insular Insight: Where Art and Architecture Conspire with Nature : Naoshima, Teshima, Inujima*. Baden: Lars Müller Publishers, 2011.
- Tsukamoto, Yoshiharu, and Momoyo Kaijima. *Behaviorology*. New York: Rizzoli, 2010.
- Okakura, Kakuzō. *The Book of Tea*. Rutland, Vt: C.E. Tuttle Co, 1956.
- Sorensen, André, and J Okata. *Megacities: Urban Form, Governance, and Sustainability*. Tokyo: Springer, 2011.
- Seike, Kiyoshi. *The Art of Japanese Joinery*. New York: J. Weatherhill, 1977.

Sorensen, André. *The Making of Urban Japan: Cities and Planning from Edo to the Twenty-First Century*. London: Routledge, 2002.

Stewart, David B. *The Making of a Modern Japanese Architecture: 1868 to the Present*. Tokyo: Kodansha International, 1987.

Suzuki, Daisetsu. *Zen and Japanese Culture*: Daisetz T. Suzuki. London: Routledge and Kegan Paul, 1959.

Tanizaki, Junichirō. *In Praise of Shadows*. New Haven, Conn: Leete's Island Books, 1977.

Tsukamoto, Yoshiharu, and Momoyo Kaijima. *Bow-wow from Post Bubble City =: Ato rie Wan Furomu Posuto Baburu Shitei*. Tōkyō: INAX Shuppan, 2006.

Site-Specific Artists Studied

Christo, Jeanne-Claude, Wolfgang Volz, and Jonathan Henery. *The Gates: Project for Central Park, New York City : a Work in Progress*. New York: Hugh Lauter Levin Associates, 2003.

Olafur, Eliasson, Madeleine Grynsztejn, and Mieke Bal. *Take Your Time: Olafur Eliasson*. San Francisco: San Francisco Museum of Modern Art, 2007.

Matta-Clark, Gordon, Corinne Diserens, Thomas E. Crow, Judith R. Kirshner, and Christian Kravagna. *Gordon Matta-Clark*. London: Phaidon, 2003.

Rei Naitō: Kono Koto. *Rei Naito : Being Given*. Okayama-shi: Naoshima Kontenporarī Āto Myūjiamu, 2002.

Other

Bosoni, Giampiero. "Architetture Parassite / Parasitic Architecture." *Lotus International*. 133.133 (2008): 118-29.

Haydn, Florian, and Robert Temel. *Temporary Urban Spaces: Concepts for the Use of City Spaces*. Basel: Birkhäuser, 2006.

Jodidio, Philip. *Architecture: Art*. Munich: Prestel, 2005.

Klanten, Robert, Lukas Feireiss, and Sophie Lovell. *Space Craft: Fleeting Architecture and Hideouts*. Berlin: Gestalten Verlag, 2007.

Kwon, Miwon. *One Place After Another: Site-specific Art and Locational Identity*. Cambridge, Mass: MIT Press, 2002.