

Lightbox: Dynamic Daylighting in a Portable Gallery System

Louis Caldwell

A thesis
submitted in partial fulfillment of the
Requirements for the degree of

Master of Architecture

University of Washington
2011

David Miller, Chair
Chris Meek

Program Authorized to Offer Degree:
Department of Architecture

Acknowledgements

I would like to thank my committee members, David Miller and Chris Meek, for their support and guidance. They continuously pushed me to explore the potentials of daylight, vastly improving this thesis from its nascent beginnings.

I would also like to acknowledge and thank the resources made available to me through the University of Washington's Integrated Design Lab. The Lab has opened new doors in daylighting design for me and my work.

Finally I would like to thank my family and friends. I could not have completed this thesis without the support of my loved ones at home.

University of Washington

Abstract

Lightbox: Dynamic Daylighting in a Portable Gallery System

Louis Caldwell

This thesis explores the qualities of daylight in a portable gallery environment by suggesting alternatives for how light interacts with art. Daylight is manipulated through a dynamic shading system to generate multiple interpretations of a single piece or collection of art. These scenes are then analyzed through digital simulations and designed to reflect a set of lighting guidelines. The daylighting system works in conjunction with a modular building system that is designed to provide maximum portability with minimal on-site construction. The result is the development of a highly adaptable universal gallery with the ability to be located on a variety of sites and tailored to meet the specific needs of the exhibits on display.

Chair of Supervisory Committee- David Miller

Committee Member- Chris Meek

Table of Contents

List of Figures	ii	Chapter 5 Programming	31
Chapter 1 Introduction.....	1	5.1 Gallery Program	31
1.1 Current Practices in Museum Lighting	2	5.2 Gallery Configurations	31
1.2 Daylighting in Existing Portable Galleries	2	5.3 Locations	32
1.3 The Challenges of Portable Daylighting	2	5.4 Self-sufficiency.....	33
1.4 Proposed Solution	3	5.5 Solar Clock- Hours of Operation	34
1.5 Methods of Inquiry	3	5.6 Conclusions	34
1.6 Conclusions	5	Chapter 6 Design Criteria.....	35
Chapter 2 Trends in Visitor-Museum Relationships.....	7	6.1 Illuminance	35
2.1 Art/Gallery Relationships	7	6.2 Luminance.....	36
2.2 Art/Visitor Relationships	8	6.3 Art and Surfaces Tested	36
2.3 Visitor/Gallery Relationships	9	6.4 Design Tools for Testing Daylight	37
2.4 Conclusions	9	6.5 Gallery Testing	37
Chapter 3 Museum Daylighting	11	6.6 Determining the Gallery’s Operating Hours.....	38
3.1 The Importance of Daylight When Viewing Art	11	6.7 Conclusions	39
3.2 Harmful Effects of Light	13	Chapter 7 Development	41
3.3 Lighting Standards in a Museum	13	7.1 Building Module.....	41
3.4 Effects of Sky Conditions	14	7.2 Daylighting Control	45
3.5 Methods of Daylighting.....	14	7.3 Daylighting Scenes.....	48
3.6 Conclusions	15	Chapter 8 Onsite: Gallery Deployment	55
<i>Case Study- Fondation Beyeler</i>	16	8.1 Mexico City, Mexico	56
Chapter 4 Portable Architecture- Container Based Modules	19	8.2 New York City, New York	60
4.1 Container Types	19	8.3 Nome, Alaska	64
4.2 Container Architecture as an Exhibition Space	22	Chapter 9 Conclusions	69
4.3 Conclusions	22	9.1 Additional Applications	70
<i>Case Study- GAD Gallery</i>	24	9.2 Feasibility	70
<i>Case Study- Container Art</i>	26		
<i>Case Study- Papertainer Museum</i>	28		

List of Figures

Figure Number

1.1	The Kimbell Art Museum, by Louis Kahn	2
1.2	GAD Gallery	2
2.1	1,200 Bags of Coal, by Marcel Duchamp- 1938	8
2.2	Interactive museum exhibit featuring an digital touch screen	9
3.1	Electromagnetic Range	12
3.2	Spectral Curve of Various Light Sources	12
3.3	Correlated Color Temperature Scale	13
3.4	Color Temperature of an gallery under various daylight conditions	13
3.5	Brittling due to solar exposure (before and after restoration)	14
3.6	Lighting guidelines for the museum environment	14
3.7	Skylight Apertures	15
3.8	Sawtooth Apertures	15
3.9	Monitor Apertures	15
3.10	Fondation Beyeler	17
3.11	Fondation Beyeler	17
3.12	Fondation Beyeler	17
3.13	Fondation Beyeler	17
3.14	Fondation Beyeler	17
3.15	Fondation Beyeler	17
3.16	Fondation Beyeler	17
4.1	Freight Containers	19
4.2	Freight container used as a barn	19
4.3	Freight Container Dimensions	20
4.4	Application of Freight Container System	21
4.5	Building Container Dimensions	21
4.6	Application of Building Container System	21
4.7	Modular Frame Dimensions	22
4.8	Application of Modular Frame System	22
4.9	GAD	24
4.10	GAD	24
4.11	GAD	25
4.12	GAD	25
4.13	GAD	25

List of Figures (continued)

Figure Number

4.14	GAD	25
4.15	GAD	25
4.16	GAD	25
4.17	Container Art	26
4.18	Container Art	26
4.19	Container Art	26
4.20	Container Art	27
4.21	Container Art	27
4.22	Container Art	27
4.23	Container Art	27
4.24	Papertainer	28
4.25	Papertainer	28
4.26	Papertainer	28
4.27	Papertainer	29
4.28	Papertainer	29
4.29	Papertainer	29
4.30	Papertainer	29
5.1	Urban Massing Configurations	32
5.2	Rural Massing Configurations	32
6.1	Illuminance Chart for Typical Museum	36
6.2	Illuminance Chart for Portable Gallery.....	36
6.3	Luminance Study of a Gallery Space Using Falsecolor Imaging	37
6.4	Illuminance Study	37
6.5	Annual Sun Path Diagrams for Selected Gallery Sites	38
7.1	Gallery Module Dimensions	42
7.2	Gallery Modules in Transit	42
7.3	Frame Connection Points	43
7.4	Frame Connections based on connection Points	43
7.5	Bolted Frame Connection	43
7.6	Typical Footing Detail	44
7.7	Mechanical Module	44
7.8	Environmental Controls	45
7.9	Three Methods of Daylight control	46

List of Figures (continued)

Figure Number

7.10	Material Analysis.....	47
7.11	Eggcrate diffuser Study- varying spacing (Images taken in overcast sky box.)	47
7.12	Louver Operation and Actuator	48
7.13	Section of Louver Frame	49
7.14	Conceptual studies of lighting scenes	49
7.15	Diffuse Lighting (Image of physical model taken in the overcast sky box.)	50
7.16	Diffuse Sidelighting- One Side (Image of physical model taken in the overcast sky box.)	50
7.17	Progression- Focal shift from the center to the backwall of the gallery (digital simulation)	51
7.18	Progression- Focal Shift around the gallery (digital Simulation)	52
7.19	Daily Transition (digital simulation)	53
8.1	Mexico City- Location of Mexico City	56
8.2	Mexico City- Plaza Deployment	57
8.3	Mexico City- Louver Schedule	58
8.4	Mexico City- Hours of Operation	58
8.5	Mexico City- Daylight Procession	59
8.6	Mexico City- Gallery Constructed on Site	59
8.7	Mexico City- Daylight Procession- stair	59
8.8	Mexico City- Potential Gallery Scene	59
8.9	New York City- Location of New York City	60
8.10	New York City- NYC Park Deployment	61
8.11	New York City- Louver Schedule	62
8.12	New York City- Hours of Operation	62
8.13	New York City- Street Deployment	63
8.14	Nome- Location of Nome	64
8.15	Nome- Tundra Deployment	65
8.16	Nome- Louver Schedule	66
8.17	Nome- Hours of Operation	66
8.18	Nome- Daylight Procession	67
8.19	Nome- Gallery Constructed on Site	67
8.20	Nome- Daylight Procession- View Window	67
8.21	Nome- Potential Gallery Scene	67
9.1	Acropolis Air Lift	71

-And artificial light is static light...where natural light is a light of mood. And sometimes the room gets dark- why not?- and sometimes you must get a close look at [the art], and come another day, you see, to see it in another mood- a different time... to see the mood natural light gives, or seasons of the year, which have other moods.

-Louis Kahn ¹

¹ Kahn, Louis I., and Nell E. Johnson. Light Is the Theme: Louis I. Kahn and the Kimbell Art Museum : Comments on Architecture. Fort Worth, TX: Kimbell Art Foundation, 1975. Print

1 Introduction

Too often works of art are rendered as static objects displayed in neutral environments. These spaces are typically devoid of a sense of time or place. The dynamic qualities of daylight have the ability to activate these spaces and redirect focus to the art. The incorporation of daylight in the gallery environment plays a vital role in a viewer's ability to fully comprehend the depth, shadow, tone and color in a work of art. It also reveals a dimension of time, as each passing cloud and the movement of the sun alters how art is viewed. The use of daylight as a primary light source and design tool should not be ignored in museum and gallery design.

The environment in which a work of art is displayed will ultimately dictate how it is perceived by a visitor. Research in the US and UK has indicated "that it is not the quality of the collection which is the main factor for potential visitors when deciding to visit a museum or gallery; it is much more the environment as a whole and the interaction with the collection that proves to be the key factor."¹ Lighting is just as integral to the museum environment as any physical boundary. Its ability to alter how art is perceived is critical to the viewing experience. This thesis explores the development of a dynamic daylighting system designed to enhance and improve a visitor's interaction with works of art.

¹ Walth, Christian. "Museums for Visitors: Audience Development- A Crucial Role for Successful Museum Management Strategies." Lecture. Intercom 2006 Conference. Taipei, Taiwan. 1-4 Nov. 2006. INTERCOM: International Committee on Management. National Museums Liverpool, 25 Feb. 2011. Web. 5 May 2011. <<http://www.intercom.museum/documents/1-4Walth.pdf>>.

1.1 Current Practices in Museum Lighting

Standard museum and gallery design relies on electric lighting as the primary light source. This stems from issues of both cost and daylight control. Toplight systems tend to cost more than a traditional roof structure and lead to issues of thermal control and weather proofing. Additionally, unregulated daylight can be extremely harmful to works of art. A set of lighting guidelines has been developed for the museum industry to ensure the protection of valuable works of art. Electric lighting is the most convenient method for meeting these requirements. Electric light provides constant and predictable lighting by delivering predetermined levels of illumination. When daylight is incorporated into gallery design it is often used to provide diffuse and even lighting throughout the gallery. Areas of focus can then be augmented with electric lighting if necessary.

1.2 Daylighting in Existing Portable Galleries

As theories in museum design change, daylight must respond in kind. One such example is the development of the portable gallery. Designed to intensify community involvement, these galleries can reach new and specialized audiences by bringing a collection directly to its visitors. To date, these spaces are predominately lit through electric lights, creating static environments in what are otherwise active spaces.

1.3 The Challenges of Portable Daylighting

Successful daylighting of a space must take into consideration many variables including site, climate, geography, sky conditions, solar gain, aperture location, and shading techniques. Dominant to all other factors is the location of the project site. The site's latitude, or location relative to the equator, determines the sun's path in the sky throughout the year. Understanding the sun's movement across a site will begin to define the strategies and techniques best suited to controlling daylight at that location. However, a portable structure has no permanent site, and must be designed to account for any number of solar and climatic conditions. An operable louvered system is the best solution for meeting the needs of daylight in such an environment.



Fig: 1.1 The Kimbell Art Museum, by Louis Kahn



Fig: 1.2 GAD Gallery

1.4 Proposed Solution

This Thesis explores the development of a portable gallery system designed to enhance the viewing experience through the use of daylight. It looks at the implications of viewing works of art under a variety of daylight conditions at multiple locations.

The thesis focuses on the development of a daylight control system integrated into a larger modular building system developed to be both re-configurable and portable. The shading system is required to deliver a broad range of lighting conditions within the gallery at a multitude of sites. The success of the system depends achieving a combination of both technical and experiential design goals. Daylighting conditions within the gallery will be analyzed through a combination of digital and physical simulations to ensure the intended success of the system.

In addition to meeting a set of daylighting goals, the gallery is intended to function without the assistance of a utilities infrastructure. This off-grid approach allows for the gallery to be located virtually anywhere; bringing art to anyone, regardless of their access to major art institutions.

1.5 Methods of Inquiry

The process of development can be broken into three main paths of discovery; the development of a portable gallery, the implementation of a daylight control system, and the creation of lighting scenes generated by the system. By no means, does this imply these processes will be performed in isolation. A successfully integrated gallery must take advantage of the benefits each concept offers the others. An effective shading system is not possible without first understanding the space it is intended to control. Likewise, the gallery experience is highly dependent on the atmosphere and spatial qualities generated by the daylighting system.

Detailed below is the path of exploration to undertaken for this thesis:

1. Understanding the needs of a Portable Gallery

- Understand the relationship between art and the gallery environment.
- Identify current trends in museum design.
- Identify current trends in visitor-museum relationships.

2. Museum Daylighting

- Explore the importance of daylight in a museum.
- Understand the role light plays in art degradation.
- Identify a set of lighting standards for the museum environment.
- Explore various methods of museum daylighting to determine the most appropriate solution.
- Analyze successful strategies for museum daylighting.

3. Container-Based Architecture

- Identify the basic dimensional qualities of container modules.
- Define the methods of construction for various types of container architecture.
- Identify the benefits of container architecture as a modular system.
Analyze the strengths and weaknesses of existing container galleries.

4. Programing

- Generate basic deployment configurations based on the urban fabric of a site.
- Identify locations for testing the gallery:
 - Mexico City, Mexico (19° N)
 - New York City, USA (40° N)
 - Nome, Alaska, USA (60° N)
- Establish the gallery's ability to operate off-grid
- Develop an operation schedule based on available daylight

5. Develop Design Criteria

- Identify technical daylighting criteria.
- Identify a method for daylight testing in the gallery.
- Outline the testing parameters for the gallery.

6. Development

- Discuss design development of the building module
- Discuss design development for the daylighting control system
- Discuss the creation and development of daylighting scenes
- Implement the gallery at the selected project sites.

1.6 Conclusions

This thesis explores the relationship between daylight and artwork in a controlled gallery environment. This is achieved through the development of a dynamic daylight control system that can provide multiple lighting configurations under similar conditions. A modular gallery unit based on portability frees the system to be deployed in various locations without the need for an existing utility infrastructure. The collective gallery system is designed to deliver a unique and widely accessible viewing experience.

2 New Trends in Visitor-Museum Relationships

This chapter explores current methodologies in museum design. It focuses on the relationship between art and its environment, defines various museum approaches to artifact-visitor relationships, and examines current trends in attracting museum audiences.

2.1 Art / Gallery Relationships

In his collection of essays titled *Inside the White Cube*, originally published in 1976, artist and critic Brian O'Doherty examines the Modernist interpretations of a gallery. While the pure white galleries were intended to be devoid of time and politics, O'Doherty argues that in reality those concepts are inescapable. Rather, he argues "the gallery space is not a neutral container, but a historical construct. Furthermore, it is an aesthetic object in and of itself."¹ The white gallery with its clean, pure lines and hard edges has the potential to overpower the work it is intended to display, thus becoming its own artistic expression.²

O'Doherty's essays have been seen as a revelation in the artist-gallery relationship, turning the focus from two dimensions to three and from isolated works to contextual elements. His notions on art as it relates to context, time, politics and the environment have led the movement in contemporary theories on installation art.

1 Sheikh, Simon. "Positively White Cube Revisited." E-flux. E-flux, Feb. 2009. Web. 14 Sept. 2011. <<http://www.e-flux.com/journal/positively-white-cube-revisited/>>.

2 O'Doherty, Brian. *Inside the White Cube: The Ideology of the Gallery Space*. Berkeley: University of California Press, 1986. Print.

The introduction of dynamic daylighting into the viewing experience builds on these notions of viewing art in the moment and removing the forced constraints of an object in isolation. While O’Doherty refers to ‘time’ in the sense of a cultural period or artistic movement, his theories have relevance in the physical passage of time as well. The physical quality of time provides context to both art and its environment. This thesis explores time as a contextual element that alters the perception of both the art and the gallery. It embraces the physical presence of time (as experienced through daylight) and uses it to modify and define how art is perceived.

2.2 Art / Visitor Relationships

In her essay “The Museum Effect” Valerie Casey identifies three models of visitor-object relationships in respect to changing theories in museum practice: legislating, interpretive, and performing. These relationship models follow a chronological progression beginning with the legislating model of the late 19th century.

The legislative typology treats museums as a container for the display of art. The value of the art is not up for debate as it was pre-determined to be exemplar representations of a subject. In this model the art is meant to speak for itself and the visitor is expected to view and appreciate the art without an explanation as to why. The Legislative model fell out of favor in a post- World War II environment where the visitor-object relationship shifted to an informative one based on a museum’s interpretation of the art. The Interpretive model makes use of a mediator to spark conversation and debate about a work of art. This model promotes conversation, but the visitor is still removed from the artifact, separated by the interpreter.

The Performance model developed as museums shifted away from displaying art in isolation, in preference of a holistic viewing experience. The performance museum is experience-oriented and designed to attract audience attention. Rather than viewing art in isolation, the Performance model promotes an interactive environment that breaks down the perceived barriers between a visitor and an art. It places equal importance on both the object being viewed and the experience as a whole. This is typically achieved through hands-on exhibitions that promote

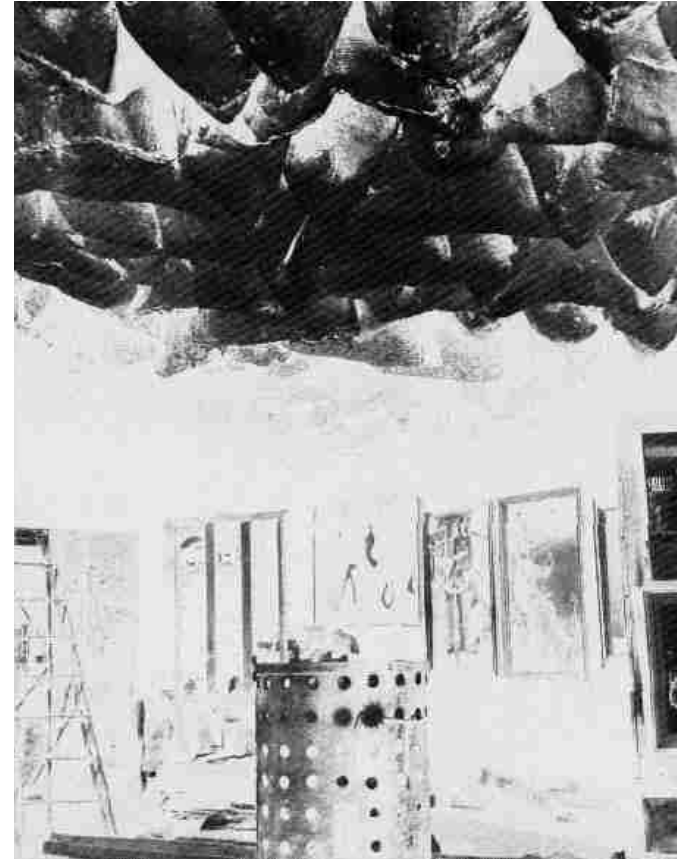

Fig: 2.1 *1,200 Bags of Coal*, by Marcel Duchamp- 1938. This early work in installation art took advantage of the ceiling place, a space ignored by conventional artists.



Fig: 2.2 Interactive museum exhibit featuring an digital touch screen

physical interactions with either a piece of art or display screens.³

Similar to the performance model, the use of daylight encourages visual interaction. A strong art / visitor relationship is paramount to the success of the gallery. Even the most technically superb space fails if it cannot attract, excite and inspire its intended viewers.

2.3 Visitor / Gallery Relationships

Current theories in museum programming have seen a shift in focus from product led to audience centric design. The Heritage fund refers to audience development as “the actions we take to involve people, to understand their needs and interests, and to create an environment and experience that appeals to them.”⁴ This approach involves identifying visitor groups and marketing to new audiences in engaging ways. Key to this process is researching an audience type and determining the needs of the community being served.

The portable gallery defined in this thesis has a special role to play in audience development. It is a highly tractable space, capable of many modular configurations based on the size and needs of the audience. This flexibility allows the gallery to be curated based on a specific audience type at each location. When one exhibit comes to a close, the gallery can simply be moved to a new location and reconfigured to meet the needs of a new audience.

2.4 Conclusions

The traditional view of the gallery as a vessel to contain art is being replaced with a contextual approach that unifies both art and the gallery into one singular viewing experience. These current trends in museum design include the transition from artifact-driven to visitor-driven spaces. Museums are looking for ways to dissolve

3 Casey, Valerie. “The Museum Effect: Gazing from object to Performance in the Contemporary Cultural-History Museum.” Lecture. ICHIM 2003 Conference. Paris, France. 8-12 Sep. 2003.

Archives & Museums Informatics Europe, 2003. Web. 25 May 2011.

4 Walth, Christian. “Museums for Visitors: Audience Development- A Crucial Role for Successful Museum Management Strategies.” Lecture. Intercom 2006 Conference. Taipei, Taiwan. 1-4 Nov. 2006. INTERCOM: International Committee on Management. National Museums Liverpool, 25 Feb. 2011. Web. 5 May 2011. <<http://www.intercom.museum/documents/1-4Walth.pdf>>.

the traditional separation between visitors and art in order to create a more interactive viewing experience.

This thesis explores contextual relationships through the visual interaction between the viewer and art. Daylight and the passage of time guide these interactions and encourage the viewer to continually examine the art in a changing light.

3 Museum Daylighting

This chapter focuses on both the quality of light and its importance in a museum setting. By understanding how daylight interacts with art, one can define the technical design criteria necessary to properly light a museum. This section will also explore successful and unsuccessful design approaches to daylight in a museum setting.

3.1 The Importance of Daylight When Viewing Art

*“Light, being both sensual and emotional, is central to the perception of a work of art. The quality of the light in a gallery is determined not only by its source, but also by the character and configuration of the space, the way the light strikes the objects and the architecture (being variously absorbed and reflected), and the way it is received by the mind and eye of the viewer.”*¹

Daylight improves the quality of the viewing experience by providing a full color spectrum and representing the passage of time through the movement of the sun in the sky. These factors inform the ways in which time materializes and expresses itself in art. Representing them in a thoughtful and well-articulated manner is key to a successfully daylit gallery.

¹ Broudy, Liz. “Appendix D. Lighting.” Museum Design: Planning and Building for Art. By Joan Darragh and James S. Snyder. New York: Oxford UP in Association with the American Federation of Arts and the National Endowment for the Arts, 1993. 263-71. Print.

Color

Color should not affect the “original appearance” of art. In other words, light should not be used to enhance or mute colors outside of an artist’s intent. Daylight provides a continuous spectral curve, meaning it reveals all colors in a material. In contrast several forms of electric light rely on the combination of only a few hues to mimic a complete spectral range. This leads to spikes in color levels and the potential for color desaturation. [Fig: 3.2]

Another major factor in determining the color appearance of art is the correlated color temperature (CCT) of the light source. CCT is used to describe the perceived warmth or coolness of light. A light source’s CCT is based on the temperature at which a black body is heated in order to achieve the same hue. Color temperature is measured in degrees Kelvin. The low end of the spectrum is comprised of warm red light. Cool blue light completes the upper end. [Fig: 3.3] Unlike electric light sources that have a constant CCT, daylight varies across the color temperature scale based on atmospheric conditions and time of day. A warm sunset is around 3000k, while afternoon sunlight reaches 6500k and blue sky reaches upward of 10,000k. In overcast conditions, daylight can reach 7500k. This is important to the overall quality of light when viewing art. Most conventional forms of electric light do not reach the higher color temperatures of daylight and tend to provide a warmer light that can distort color. In addition, shifts in the CCT of daylight allow for a more dynamic viewing experience. [Fig: 3.4]

A link to the exterior

An enclosed gallery space without access to natural daylight tends to become a static environment. Daylight by contrast, reveals the passing of the day and the changing of the seasons in the artifacts it illuminates. It provides a dynamic light source and fights off fatigue by forcing the muscles of the eye to contract and relax in response to minimal changes in illumination.² Daylight incorporates the element of time into the display of art and allows a visitor to view the object under a continuously changing environment. This requires an extra level of engagement

² “Museums.” Daylight Performance of Buildings. Ed. Marc Fontoynt. London: James & James (Science) for the European Commission, Directorate General XII for Science, Research and Development, 1999. 71-110. Print

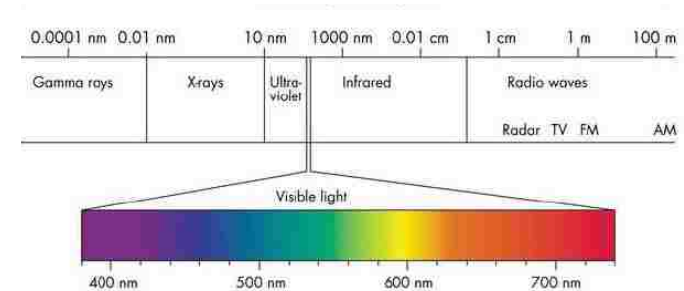

Fig: 3.1 Electromagnetic Range

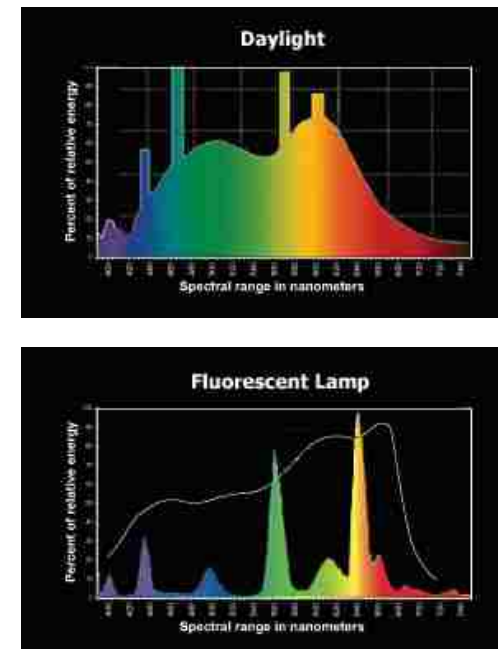

Fig: 3.2 Spectral Curve of Various Light Sources

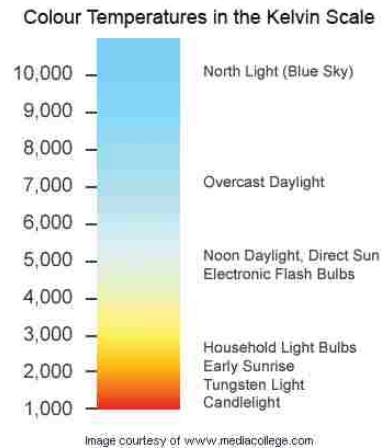

Fig: 3.3 Correlated Color Temperature Scale



Fig: 3.4 Color Temperature of an gallery under various daylight conditions

from the visitor and encourages active participation when examining the color and material of a work of art.

3.2 Harmful Effects of Light

While it is important to illuminate art with enough light to achieve visual comfort, over exposure to light can cause irreversible damage. Visible light perceived by the human eye is only one from of light in the electromagnetic spectrum. Ultraviolet light (UV), infrared radiation (IR) and visible light must all be accounted for when daylighting a surface. Because light is a form of electromagnetic radiation, it has a deleterious effect when directly striking the surface of most materials (in prolonged situations).

Two forms of radiant degradation are radiant heating and photochemical action. Radiant heating causes a temperature rise in the surface of a material exposed to an energy source. This can be the result of direct exposure to sunlight. As a material is heated, the moisture is driven out of it resulting in cracking, flaking, and loss of color. [Fig: 3.5] Degradation due to photochemical action may appear similar but is the result of a more harmful process. In this case, a chemical change takes place at the molecular level, permanently altering the material's chemical structure. Photochemical action can result in darkening of colors, yellowing, brittling and an overall loss of strength in the material. Both processes of degradation affect paints, leathers, fabrics and other organic materials. Care should be taken to eliminate UV exposure (wavelengths below 450nm). UV radiation can be minimized through the use of filters or lenses on apertures and luminaires.

3.3 Lighting standards in a Museum

In an attempt to balance exposure to radiant energy with the need for proper illumination, a set of lighting standards has been developed based on the type of art displayed. These standards are derived from the maximum amount of instantaneous illumination (lux) and annual illumination (lux-hours per year) reaching the surfaces of a material. While exact levels of illumination are based on the specific qualities of an individual piece and should be determined by a curator, general assumptions can be made based on the art's characteristics. [Fig: 3.6] Due to the extreme light sensitivities of certain materials, a designer must seriously

consider whether daylight will be the most appropriate source of illumination. Art that can receive illumination levels of 200 lux and higher are better suited to handle mild fluctuations in daylight due to passing clouds.

3.4 Effects of sky conditions

There are three basic categories of sky conditions based on the percentage of clouds in the atmosphere. They are clear, partly cloudy, and overcast. Each condition plays a role in defining exterior illuminance levels. Clear conditions are defined by the bright disk of the sun set against a dark blue sky, resulting in high levels of contrast. Overcast sky conditions provide a more even light distribution due to the scattering of the sun's rays through clouds. In overcast conditions the azimuth is the brightest point in the sky. Light is less directional in overcast conditions and therefore easier to diffuse within an interior space.

3.5 Methods of Museum Daylighting

Like all buildings, a museum can be daylit either from the top or the side. Each method has its advantages and disadvantages. As direct solar radiation is harmful to most types of artifacts, it is important that all artwork is shielded from direct sun throughout the year. This can be achieved through the use of translucent glazing, shading louvers or a combination of both.

Sidelighting (in the vertical plane) emits directional light into a space. It can be used to create sharp shadows (when oriented to the south, east or west) or indirect ambient light (when oriented north). Sidelighting also provides a direct visual connection to the exterior which can be beneficial in a museum. Views out can be used to break up the static feel of an enclosed space and allow for a dialogue between art and nature. If not properly controlled, sidelighting will emit harsh, directional light into a space and can cause intense contrast and glare—neither of which is desirable in exhibition spaces.

Toplighting is used to provide an even and continuous distribution of light through an aperture in the ceiling. The directional qualities of toplighting can be more easily controlled than with sidelighting, providing a more comfortable space with continuous light levels. At the same time, toplighting provides a link to the exterior



Fig: 3.5 Brittling due to solar exposure (before and after restoration).

Types of Material	Maximum Illumination	Lux-Hours per Year
Highly Susceptible Materials works on paper, watercolor, photography, textiles, furs, feathers, upholstery	50 lux	50,000
Moderately Susceptible Materials oil and Temera Paintings, wood finishes, leather, textiles with stable dyes	200 lux	480,000
Least Susceptible Materials metals, stone, ceramic, glass, hard minerals	200+ lux	based on situation

Fig: 3.6 Lighting guidelines for the museum environment

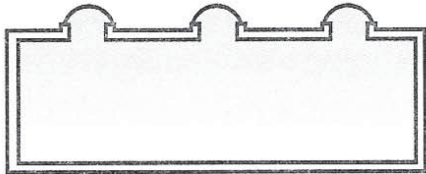
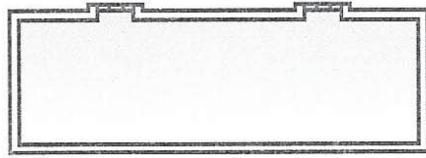

Fig: 3.7 Skylight Apertures

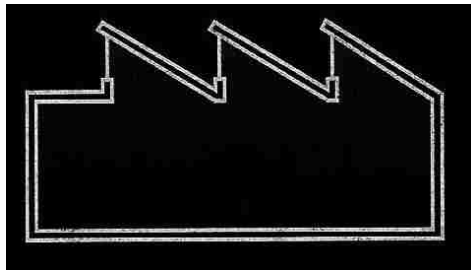

Fig: 3.8 Sawtooth Apertures

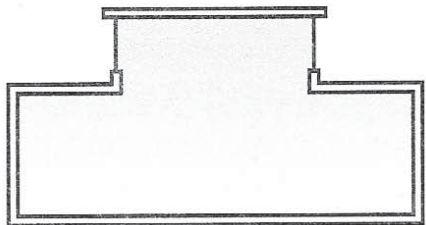

Fig: 3.9 Monitor Aperture

through the changing sky above. However, skylights can be costly and introduce a myriad of building envelop concerns in the form of thermal control and moisture leaks. Apertures can take various forms. Below are several common examples used in museum lighting.

Skylights are typically defined as horizontal or domed apertures in the roof of a space. A skylight will deliver the most continuous amount of light because it is exposed to the sun's path for the majority of the day. It also performs well in overcast conditions because it is exposed to the sky's zenith (the brightest point in overcast conditions). However, horizontal skylights lead to weather-proofing issues.

Sawtooth monitors and clerestories provide directional light as they are only able to capture daylight from specific orientations. This leads to a non-uniform distribution of light on vertical surfaces and can create high levels of contrast

Vertical Monitors are glazed on two surfaces and allow for bi-directional lighting which can reduce the amount of contrast in a space. Monitors tend to perform poorly in overcast conditions because all glazing is located in the vertical plane.

Diffuses are typically found inbound of a glazing system and provide an additional means for diffusing light. A diffuser captures and spreads light along its surface. The absorptive qualities of light colored fabric diffusers allow for increased luminance and minimize contrast between an aperture and the space it is lighting.

3.6 Conclusions

Daylighting, both maintains the original color appearance of a work of art, and provides a link to the exterior environment. With few exceptions, special considerations need to be taken to protect art from the harmful effects of light. Prolonged exposure to light will lead to degradation in the materials and pigments of an object.

As is the case in most interior spaces, museums can be daylit from the side or above. However directional light has the potential to cast shadows on an artifact. In most conditions non-directional diffuse light is preferred.

Case Study- Fondation Beyeler

Renzo Piano's Beyeler Foundation, built in 1997, is located in Basel, Switzerland. From the onset of the project natural daylight was a top priority. Both Piano and the client desired a light roof that would float over the gallery spaces and the art housed within. As Piano would later note, the construction of the roof "focuses on using natural light to illuminate the art objects below and is hardly perceived as such by the visitor".³

At its most basic level, the museum is designed as a steel and glass roof floating over earthbound masonry walls. Four long walls running north to south create the foundation of the gallery spaces. The museum's permanent collection is housed at ground level in the toplit galleries. To the west, a glass winter garden connects the main galleries with a special collections gallery buried into the hill below. The winter garden provides visual relief to the consistent light levels within the white galleries. It also affords exterior views to the valley and vineyards beyond the museum grounds. Additionally, several key galleries include view windows and side lighting to interact with the art. Several sculptures benefit from the shadows cast by directional southern daylight while other works of art form a dialogue with the landscape beyond the gallery walls. The main gallery walls are spaced 7.5 meters (24'-6") apart and are 5 meters (16'-6") tall.

Piano consulted with Arups when designing the gallery spaces. One of his goals was to achieve even lighting throughout the entire gallery. Based on the location and climate of Basel, it was advised to create an entirely glazed roof that would diffuse daylight through a combination of glazing and shading mechanisms. Such a glazing system would allow the environment within the gallery to change with the fluctuations in external sky conditions.

The ceiling aperture assembly consists of five component parts. Visible from the building's exterior are the fritted glass sunshades. These angled

louvers, which give the roof its distinctive look, block 50 percent of direct sunlight. Double-glazed, UV coated glass bellow the louvers forms the top of the building envelop. The clear glazing gently slopes to assist in drainage and extends beyond the building's façade to prevent direct sun from entering the galleries. A second layer of clear glazing sits below the top glazing. The loft space between the glazings works in tandem to create a thermal buffer in the roof of the museum. Operable horizontal louvers located in the loft space, can fine-tune the amount of sunlight entering the galleries without exposing any moving parts to the weather. These louvers are set perpendicular to the fixed louvers above. Finally a metal grate defines the visible ceiling of the gallery space. This final diffuser is designed to evenly distribute light throughout the galleries, hide the mechanics of the operable louvers, and obstruct dirt and buildup collected on the roof.⁴

Collectively the aperture system emits only four percent of exterior daylight into the galleries. The entire system is automated to precisely control interior light levels. The automated system also activates electric lighting when daylight levels become too low. The museum is designed to achieve an average interior illumination of 280 lux. Electric lighting, which is discretely hidden above the metal grating, provides uplight, downlight and ambient light to the galleries in the evening and when daylight is not satisfactory. The absence of visible luminaires adds to the pure form of the galleries and reinforces the dominance of daylight as the main source of illumination.

3 The Fondation Beyeler, ed. Renzo Piano: Fondation Beyeler : a Home for Art. Basel: Birkhäuser--Publishers for Architecture, 1998. Print.

4 The Fondation Beyeler



Fig: 3.10



Fig: 3.11



Fig: 3.12

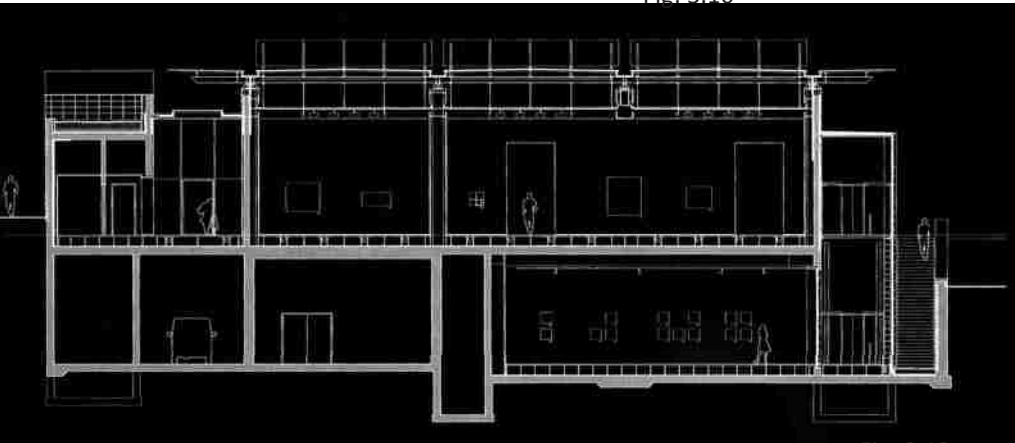

Fig: 3.13



Fig: 3.14



Fig: 3.15



Fig: 3.16



Fig: 4.1 Freight Containers

4 Portable Architecture- Container Based Modules

Container architecture has evolved out of the basic need for a temporary shelter that can be quickly and easily erected. The first buildings adapted from freight containers were tool sheds and storage units. Little adaptation was necessary in the development of these structures since the units served similar functions to the freight containers from which they were made. Today, containers have moved beyond their original functions as temporary or mobile forms of architecture and are developed as modular elements to provide permanent office, living and civic structures. Additionally container architecture has become a desired aesthetic among designers and clients. The temporal imagery associated with container architecture also makes it well suited for event architecture.

4.1 Container Types

There are several types of container systems used in current container architecture, all stemming from the most basic fundamentals of the original freight container. These types include the freight container, building container and modular frame. Each system is designed to meet certain criteria universal to container architecture. All systems are designed as structurally independent modular elements. They have the ability to be stacked (although the exact number depends on the system) and the ability to be connected to similar units. While exact dimensions will vary, each container type is designed to work with a transport system, thus limiting their overall size to a dimension that can be transported either by ship, rail or truck. While the overall appearance of the different systems may seem similar, they differ in their structural make-up, adaptability and components.

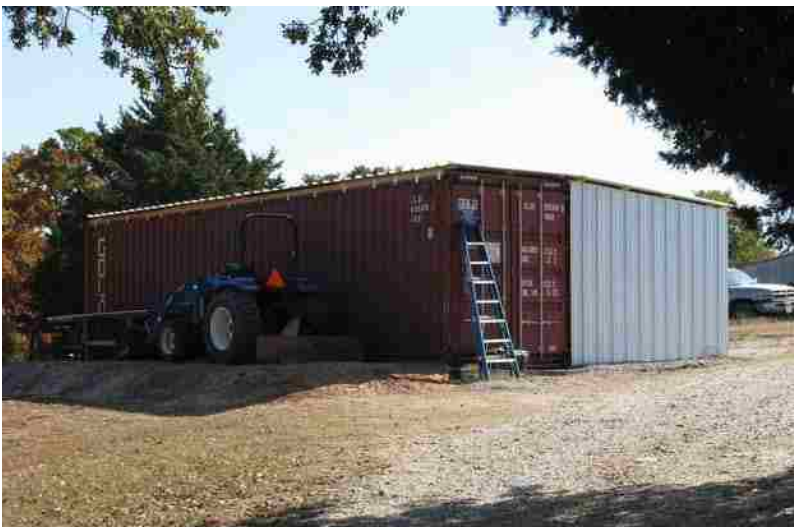

Fig: 4.2 Freight container used as a barn

Freight Containers

The main advantages to designing with a freight container are its universal dimensions and sheer abundance across the world. A standard shipping container is constructed of load-bearing COR-TEN steel walls that combine with the floor and ceiling to create a rigid moment frame. As a result, all loads are transferred at the four corners of the container. Only minimal modifications can be made without the need for additional structural reinforcement. In accordance with the need for a global standard, freight containers are based on set dimensions regulated by the International Standards Organization (ISO). Typical containers are either 20 feet or 40 feet in length and eight feet wide. They range in height between eight feet and nine feet, six inches. A 45 foot container is the largest allowable length to be transported by road on a standard chassis. [Fig: 4.3] In their unadulterated state, freight containers offer little in the way of thermal and daylight control. In order to become habitable for extended periods of time, modifications must be made to the container. There are several deviations on the standard container including the hard top with a removable roof and reinforced frame and the open side with a door running the length of its longitudinal wall. These special containers have several architectural implications due to their reinforced frames. They allow for potential openings and provide possible modifications in façade and glazing treatments in certain planes.

Cast steel corner fittings are located at the eight corners of each unit. They have openings on their vertical and horizontal surfaces for vertical stacking and to attach lifting equipment. Bridge fittings can be used to secure horizontally stacked containers as well as transfer lateral building loads.¹

Building Containers

Building containers developed as an architectural answer to the freight container. While building containers maintain aesthetic, modular, and fabrication properties similar to a freight container, they are designed with a lighter structure, more suitable to architectural design. Building containers are also better suited to handle the envelop requirements demanded of a building. They take advantage of

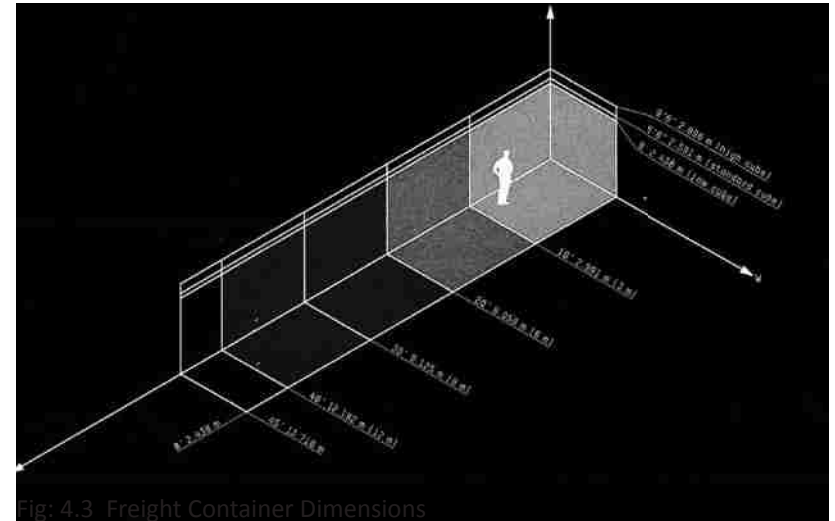

Fig: 4.3 Freight Container Dimensions



Fig: 4.4 Application of Freight Container System

¹ Slawik, Han, Julia Bergman, Maththais Buchmeier, and Sonja Tinney, eds. Container Atlas: a Practical Guide to Container Architecture. Berlin: Gestalten, 2010. Print. 23.

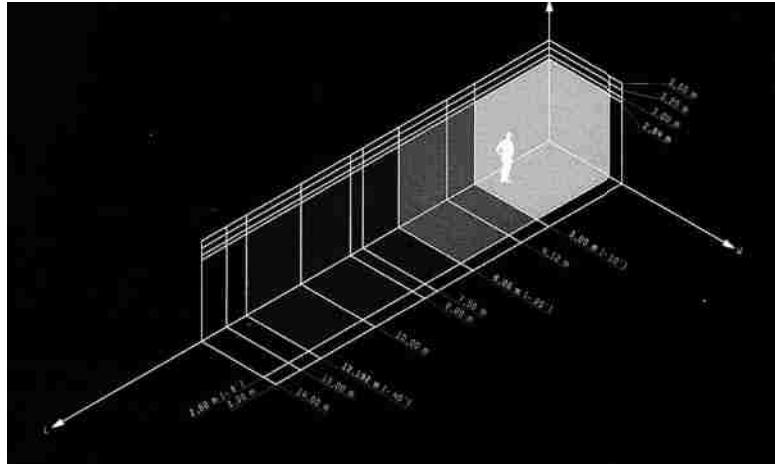

Fig: 4.5 Building Container Dimensions

the prefabrication process, allowing for minimal work on site. The system is based around a primary steel frame with secondary members to support the container's surfaces. Because of this construction method, openings within a surface are allowable to a certain extent (large openings will require structural modifications). Individual units are often deployed as single rooms with the ability to connect in a series or stack four units high. While they can be used as permanent structures, their primary function is that of a temporary structure. The units can be adapted to incorporate heating and cooling equipment, sanitary facilities, and sewage tanks that are located outside or beneath the unit, or in an adjacent container. Because they do not need to adhere to ISO standards, building containers come in a wider variety of dimensions, based on a manufacturer's capabilities. [Fig: 4.5] Units are manufactured in a two-step process beginning with the structural frame that is then infilled with surface panels.

Due to the methods of construction, building containers have drawbacks as permanent buildings. The steel structure leads to issues of thermal bridging and moisture infiltration. Roof leaks are also common after extended periods of exposure.²

Modular Frame

Modular frames are based on the same structural system as building containers. However, after the structural frame is prefabricated, the modular frame's building envelop is installed on site, joining multiple units into one visually homogeneous form. This reduces the building's ability to be disassembled or relocated. Modular frames are designed and built specifically to the needs of an individual project. Since each unit is designed to be project specific, there are not standard dimensions beyond the frame's ability to be transported.

Modular frames are most compatible for buildings with repetitive spaces. Because the system's façade is applied as a single unit on the exterior of the framework, thermal bridging is minimized in comparison with a building container. Modular frames also allow for flexibility in roof forms (verses the flat roof necessary for the shipment of a building container) that will improve the structure's impermeability. Due to the attachment methods of the final assembly; the individual units of a



Fig: 4.6 Application of Building Container System

² Slawik, 33.

finished building have reduced mobility and no longer act as a true “container system”.³

4.2 Container Architecture as an Exhibition Space.

Containers are cheap structures that can be assembled and located on site in a relatively quick time frame. This makes them popular as pavilions for expositions and fairs. The transportability and implication of mobility associated with a freight container also make it an ideal building type for a mobile exhibition. The modular qualities of the container allow for a gallery to vary in size depending on the collection being displayed. In addition to housing art within them, multiple containers can be stacked to create the foundation of a larger structure. Because of their industrial aesthetics, container buildings often become a form of artistic expression in and of themselves and hint to the type of art displayed within.

4.3 Conclusions

Container buildings have advanced from improvised adaptations of freight containers into a fully defined typology of temporary and portable architecture. As the requirements demanded of container architecture have progressed, so too have the methods of constructing container structures.

Each container type has its own advantages and disadvantages. The key is discovering the goals and intentions of the design as a means to understand its most appropriate method for construction. These factors are based on aperture sizes, spatial requirements, methods of transport and means for environmental control, among other factors.

The following are examples of several exhibition and gallery spaces which utilize container systems in their designs.

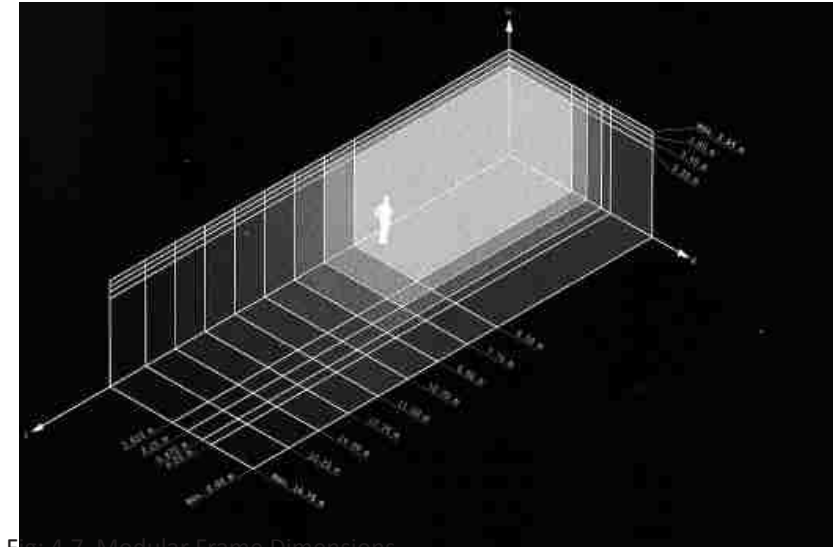

Fig. 4.7 Modular Frame Dimensions



Fig: 4.8 Application of Modular Frame System

3 Slawik, 39.

GAD

Designer: MMV Architects of Norway

Location: Oslo, Norway

Container Type: freight container

GAD is a semi-temporary gallery located near the shipyards of Oslo, Norway. The use of shipping containers for the gallery responds to the history of the local shipping community while at the same time providing a means for easy transportation. It is designed to be deconstructed and relocated within several days if necessary.

The gallery's artwork is lit in part by circular transparent skylights and large view windows. This provides intense directional light and strong shadows within the gallery space, posing a potential problem for visitors. Contrast and glare can quickly disrupt visual comfort when the long narrow gallery opens to a bright sky beyond.



Fig: 4.9



Fig: 4.10

source: Siegal, Jennifer. 114.



Fig: 4.11



Fig: 4.12



Fig: 4.13

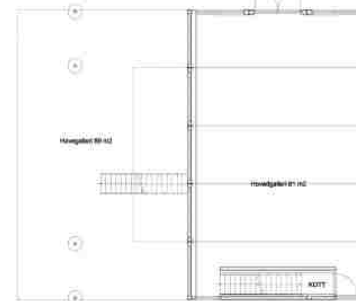
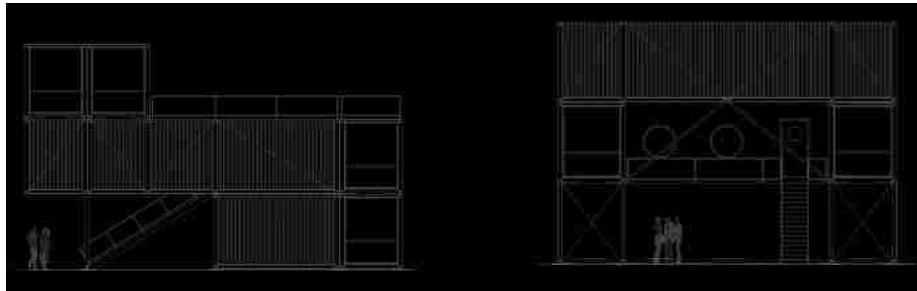

Fig: 4.14



Fig: 4.15

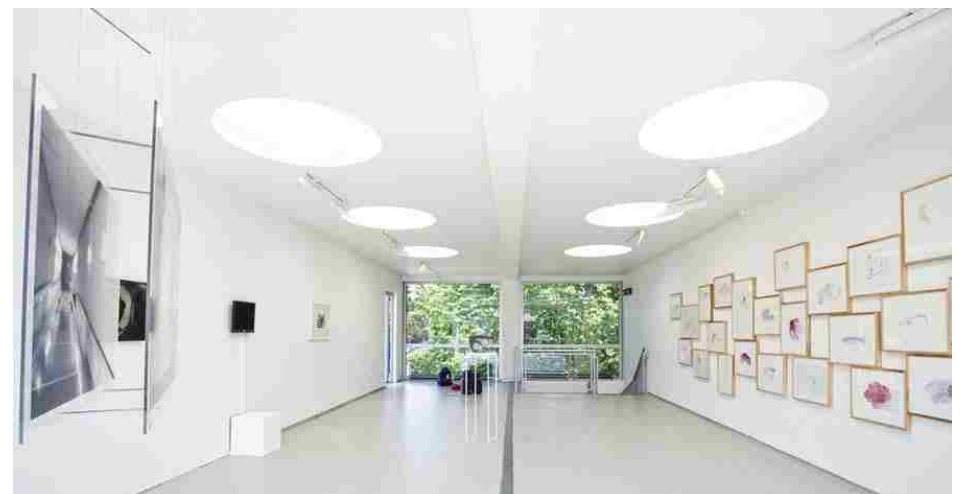

Fig: 4.16

Container Art

Designer: various

Location: various

Container Type: freight container

Container Art is a travelling urban installation that takes on various forms depending on the city. Typically, the containers are stacked two high, forming an arcade. In other cases, containers are scattered throughout a city. The temporary containers exhibit various forms of visual art.

The exhibit makes use of unassuming freight containers, doing little to modify them. Each container houses an individual installation. The program also partners with sponsors by utilizing the container exteriors for signage.



Fig : 4.17



Fig: 4.18



Fig: 4.19



Fig: 4.20



Fig 4.21



Fig 4.22

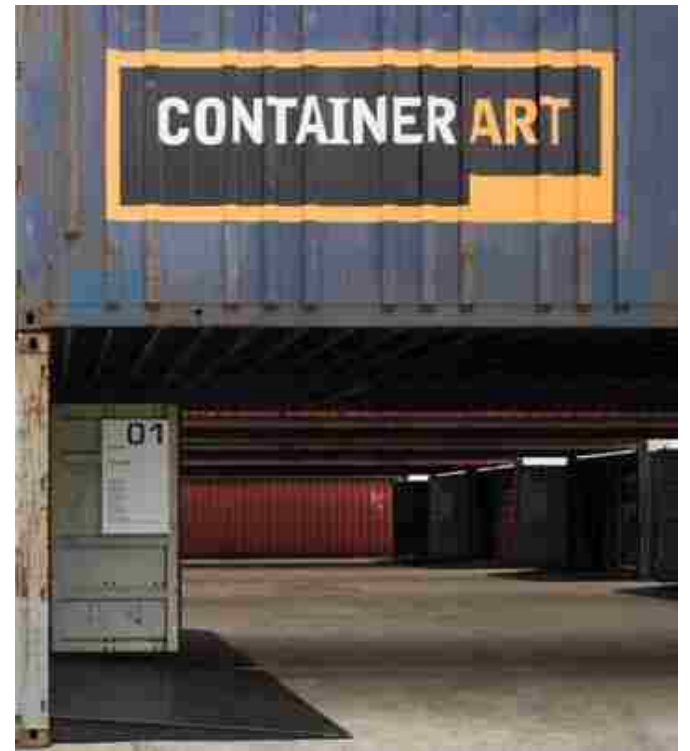

Fig: 4.23

Papertainer

Designer: Shigeru Ban

Location: Seoul, South Korea

Container Type: freight containers

Papertainer is a semi-temporary exhibit pavilion created by Shigeru Ban and developed for the Seoul Olympic Park in Seoul, South Korea. The exhibition hall houses a large multipurpose space and a container gallery. The container gallery is a long display hall flanked on either side by stacked containers. Several ground level containers open off of the hall into smaller exhibit spaces.

The museum is constructed of 166 containers and 373 paper tubes (reminiscent of other Bahn works). Despite its size, the Papertainer Museum does have the potential to be deconstructed and rebuilt in other locations.



Fig: 4.24



Fig: 4.25



Fig: 4.26



Fig: 4.27

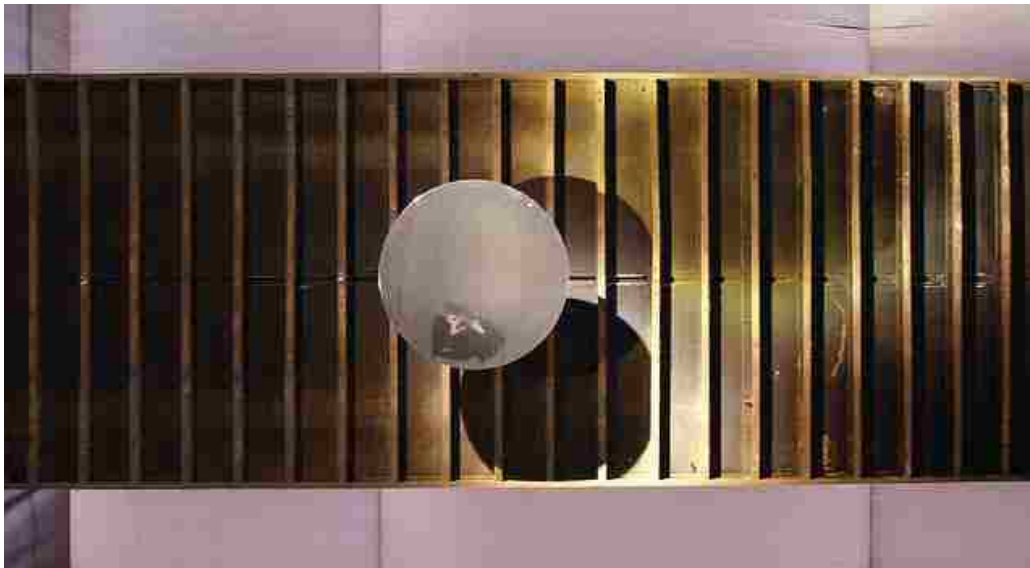

Fig: 4.29



Fig: 4.28



Fig: 4.30

5 Programing

This chapter focuses on the basic programmatic requirements set forth for the design process. Unlike a traditional museum, the gallery does not adhere to a set of rigorously programmed spaces and site relationships. Rather, basic guidelines have been developed to direct how the gallery will function when deployed. This flexibility in design allows the gallery to adapt to each individual project site.

5.1 Gallery Program

The galleries are based on the idea of temporary pavilion architecture. Because the exhibition space is the driving element of the program, and due to the desire to minimize the total number of modules required for each site, the majority of a typical museum's pre-function has been eliminated from the program. Instead a simple gathering space and front desk welcome visitors to the gallery. Additional spaces such as restrooms and staff offices can be integrated into the program on an as-needed basis.

5.2 Gallery Configurations

The gallery is designed to accommodate any variety of user types. The user-gallery relationship is not based on the physical walls of the space, but rather on the artwork exhibited and the manner in which it is displayed. With that in mind, it did not seem appropriate to devise gallery configurations based on the people who visit. Instead each gallery is developed based on the density of the site and its relationship to the built environment. The types are classified as urban and rural.

Urban

Urban configurations have small or narrow footprints that allow them to fit on tight plazas or act as urban infill. This requires the project to grow vertically, mimicking the surrounding built landscape. [Fig: 5.1]

Extreme examples of urban configurations may include only two or three modules that can be quickly assembled overnight in high profile locations, such as public sidewalks or on top of buildings.

Rural

Rural configurations are one story galleries that can afford to sprawl across the landscape. Larger footprints also create the potential for exterior gallery space. In addition to natural landscapes, rural configurations are well suited to large city parks suburban neighborhoods. [Fig: 5.2]

In the end, the number of modules required for each gallery site depends on the collection being displayed and the number of intended visitors the collection will draw. For the purposes of the thesis each gallery was limited to roughly 11 full-size modules, with the assumption that many more will become cumbersome for purposes of transportation.

5.3 Locations

A portable gallery must be able perform at several sites. Because a site's latitude is a key factor in daylighting, it is important to test the gallery for a range of latitudes. The climate of these locations is also important in determining how the gallery will operate. While this thesis does not focus on environmental factors such as temperature and humidity, the daylighting of a space is affected by cloud coverage and direct solar radiation. Thus, it is important to choose sites with a range of annual climatic conditions.

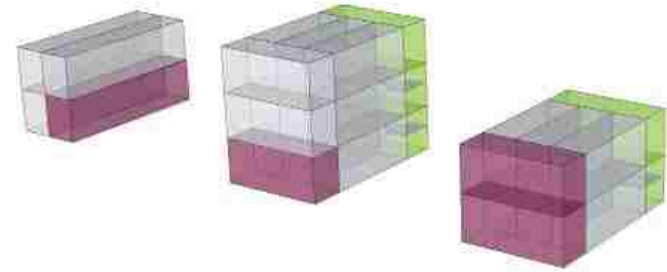

Fig: 5.1 Urban Massing Configurations

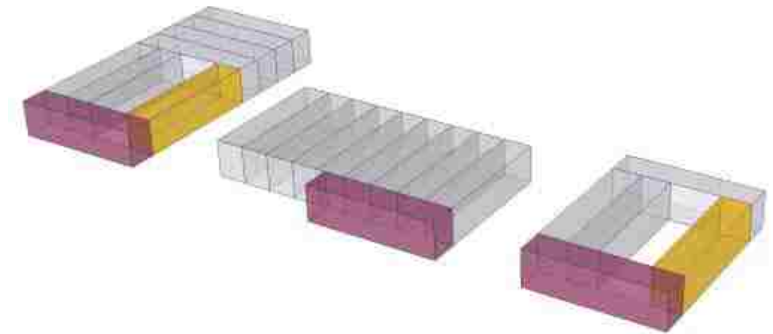

Fig: 5.2 Rural Massing Configurations

Three project locations have been chosen based on latitude and climate. They are as follows:

Mexico City, Mexico

- Latitude: 19.4°n Longitude 99.1°w
- Sky Conditions: Predominately overcast year-round
- Gallery Configuration: Urban

New York City, New York USA

- Latitude: 40.7°n Longitude 73.5°w
- Sky Conditions: Predominately overcast year-round
- Gallery Configuration: Urban

Nome, Alaska USA

- Latitude: 64.5°n Longitude 165.4°w
- Sky Conditions: Predominately overcast in the fall and winter months
- Gallery Configuration: rural

While each of these sites is located in the northern hemisphere, the daylighting conclusions drawn from them are applicable to similar latitudes in the southern hemisphere with one notable exception. In the southern hemisphere, June receives the fewest number of daylight hours and December receives the most. It is because of this potential confusion that all project sites are located in the same hemisphere.

5.4 Self-sufficiency

Often, people outside of major metropolitan areas do not have easy access to collections of art. As a result museums and art galleries can be perceived as stuffy, un-relatable institutions. Portable art galleries have the ability to make art more accessible by bringing it to potential viewers. The thesis intends to take advantage of portability by creating a gallery that can function without the need for additional infrastructure. This off-grid approach will allow the gallery to be sited almost anywhere without the need for external power or water. To achieve this properly the project must take advantage of natural resources like the sun's energy.

5.5 Solar Clock- Hours of Operation

To reinforce the association between daylight and time, daylight is also the only lighting source for the project. This means the building's operability relies completely on the sun's path over the course of a day. When it becomes too dark to see the art, the gallery closes until the next morning when the sun is again bright enough to open. The lack of electric lighting emphasizes the importance of daylighting for art and the built environment. Additionally it helps reduce the overall power consumption in off-grid locations.

5.6 Conclusions

The gallery is programmed to function in much the same way as pavilion architecture. It is developed around a simple program in order to remain compact and focused on the art being displayed. Two basic configurations organize the gallery in response to the local built environment. They are developed to create a degree of design standardization when locating the gallery on site. The thesis will focus on three project locations in order to demonstrate the gallery's ability to perform in different configurations at multiple latitudes. The gallery is also designed to function off grid, relying on the sun for both energy and light.

6 Design Criteria

In order to maintain a level of comfortable viewing within the gallery a set of technical design criteria needs to be established. Illuminance and luminance are analyzed to ensure consistency and quality of light within the gallery. While the amount of daylight reaching the surface of the earth varies based on time of year, time of day, and cloud conditions; the gallery's interior spaces are designed to maintain a specified range of light based on performance criteria. This necessitates the use of an operable aperture system and the need for adjustable elements that regulate the amount of daylight entering the gallery. The following section outlines the methods for daylight testing and analysis in the gallery.

6.1 Illuminance

Illuminance is a quantitative measurement of the intensity of a light source striking a surface, and is measured in lux.¹ As stated in chapter 3, the intensity of light on an artifact is calculated in both instantaneous illumination and annual illumination. Like it sounds, the maximum annual illumination is the total number of lux/hours an object can receive over the course of a year before long-term degradation will begin to occur. This number is specific to an individual work of art and is determined by multiple factors including the type of media and any applied pigmentation. However general rules of thumb have been created for different categories of art.

¹ The US standard unit of measurement for illuminance is the footcandle; however this document will only refer to the lux unit. One footcandle is approximately 10 lux. Lux is determined by the number of lumens per square meter.

Instantaneous illumination is derived from the annual illumination divided by the number of annual hours an object is exposed to light.

$$\text{instantaneous illumination} = \text{annual illumination (lux/hr)} \div \text{operation hours (hr)}$$

It is assumed a standard museum will operate 2400 hours a year.² This is the equivalent to a museum operating for 8 hours a day, six days a week. As a point of comparison New York City’s MOMA operates roughly 2500 hours a year and the Seattle Art Museum operates roughly 2400 hours a year.³

Because the proposed gallery will be in transit for a portion of the year, it is assumed the museum will only operate for two-thirds the time of a normal gallery, or 1600 hours. Based on the rule of reciprocity, a reduction in operational hours will increase the amount of instantaneous illumination an artifact can receive, and allow for more generous lighting limits. Figures 6.1 and 6.2 identify illumination levels for various types of artifacts and the target illumination levels for the portable gallery. These levels are the basis for illuminance testing in the gallery.

6.2 Luminance

Luminance is described as the perception of brightness on a surface. It is measured by the intensity of light emitted or reflected off a surface divided by the surface’s area (candela/m²). While, illuminance is quantitative, luminance can be thought of more in qualitative terms. High levels of luminance on adjacent surfaces will not harm art but can lead to zones of contrast making it difficult to view the art. In order to avoid issues of glare, the gallery should be designed to achieve an even distribution of luminance between adjacent surfaces.

6.3 Artwork and Surfaces Tested

Rather than designing a gallery to display all types of art, the gallery is intended to display only moderately susceptible and non-susceptible art. The space will be designed for both hung works of art, free standing sculptures and installation

Types of Material	Maximum Illumination	Lux-Hours per Year
Highly Susceptible Materials works on paper, watercolor, photography, textiles, furs, feathers, upholstery	50 lux	50,000
Moderately Susceptible Materials oil and Temera Paintings, wood finishes, leather, textiles with stable dyes	200 lux	480,000
Least Susceptible Materials metals, stone, ceramic, glass, hard minerals	200+ lux	varies

Fig 6.1 Illuminance Chart for Typical Museum

Types of Material	Average Illumination	Lux-Hours per Year
Moderately Susceptible Materials oil and Temera Paintings, wood finishes, leather, textiles with stable dyes	200-400 lux	480,000
Least Susceptible Materials metals, stone, ceramic, glass, hard minerals	400+ lux	varies

Fig 6.2 Illuminance Chart for Portable Gallery

² Rea, Mark S., ed. The IESNA Lighting Handbook: Reference & Application. Ninth ed. New York, NY: Illuminating Engineering Society of North America, 2000. Print.

³ These hours of operation were determined in June 2011.

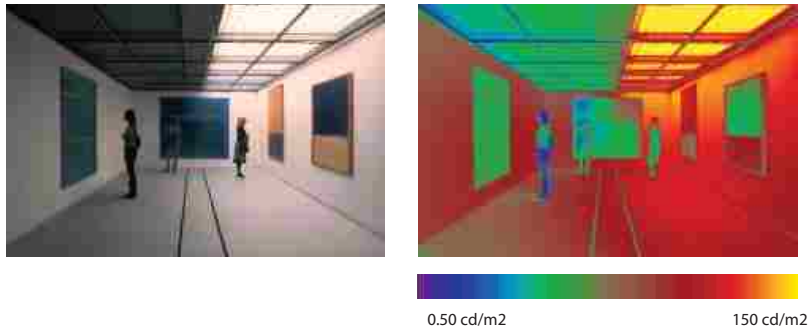

Fig 6.3 Luminance Study of a Gallery Space Using Falsecolor Imaging

pieces that may be a combination of the two. This will require testing illumination levels in both the horizontal and vertical planes.

6.4 Design Tools for Testing Daylight

Digital testing for daylight uses Autodesk Ecotect Analysis and Desktop Radiance. Three dimensional models developed in Ecotect are analyzed using the Radiance plug-in to generate two-dimensional illuminance analysis grids in both the vertical and horizontal planes.

Physical models of the gallery are analyzed in the ‘overcast sky box’ a testing facility associated with the University of Washington’s Integrated Design Lab. The overcast sky box simulates daylight conditions on a cloudy day and can be used to photograph the perception of ambient light within a space under such conditions. Multiple photographs of the same scene at multiple exposures are then merged into a single HDR (High Dynamic Range) image that is more similar to how the human eye truly perceives a space. Falsecolor images are generated from the HDR images using the imaging program Photosphere. Falsecolor images are used to depict a range of luminance levels within a real space.

6.5 Gallery Testing

Illuminance is the main method of daylight testing in this project. While luminance is studied, it is used to gain a firmer understanding of overall lighting quality rather than as a quantitative analysis tool. In order to develop a series of daylighting scenes, a baseline condition needs to be established. All illuminance testing is performed digitally.

Testing parameters for the baseline condition are as follows:

Testing is designed to meet the daylighting criteria for hung paintings- the most susceptible types of art displayed in the gallery. Illumination levels are measured on a vertical test plane offset one inch from the gallery wall. (After initial daylighting tests proved similar results on all interior surfaces of the gallery, the western wall was chosen for baseline testing.) The test zone is located between 24 inches and 96 inches above the floor. Because the display galleries are designed to be at least two modules wide, a double module oriented north/south is used in the baseline testing. [Fig: 6.4]

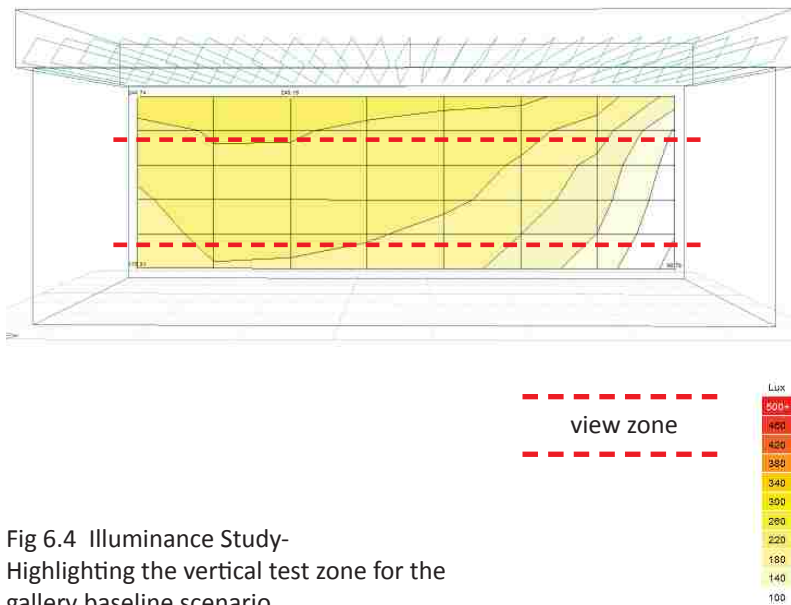

Fig 6.4 Illuminance Study- Highlighting the vertical test zone for the gallery baseline scenario.

Material properties for the digital model are as follows:

Wall reflectance: 80%

Floor Reflectance: 60%

Successful baseline lighting is characterized by an average illumination ranging from 200 lux-400 lux, never exceeding 500 lux at any one point. After the baseline testing is established and the gallery’s low end performance is set, any number of daylight scenarios involving higher levels of illumination can be expected to be achieved.

Each site is tested under the assumption that it receives uninterrupted exposure to the sun throughout the year. In other words, no adjacent objects cast shadows onto the roof of the gallery. In reality this will not pose as big of a problem as it may seem. Because the designed lighting levels in the gallery are low, adjacent obstructions may not pose much of a problem, especially in summer months when the sun is at its highest altitude and intensity.

Note: it is assumed that the daylighting system has the ability to be calibrated for even lower illumination levels, but uniform distributions below 200 lux were not analyzed for the purposes of this thesis.

6.6 Determining the Gallery’s Operating Hours

A major feature of the gallery is its ability to operate without the need for electric light. As a result, the gallery’s operating hours respond directly to the path of the sun over a given day. For the gallery to operate without electric light, the sun must be high enough in the sky to provide adequate light within the gallery. The baseline illuminance average of 200 lux is set as the lighting threshold to open the gallery. In this case, the 200 lux threshold is measured horizontally at a plane located at 36 inches above the floor.

Rather than testing when the illuminance threshold would occur at each site on each day, it was determined that the sun’s position from the horizon would provide an effective and simpler tool to determine the gallery’s operating hours. Testing across various latitudes showed that a cut-off angle ten degrees from the horizon consistently met the 200 lux threshold. After establishing the gallery’s

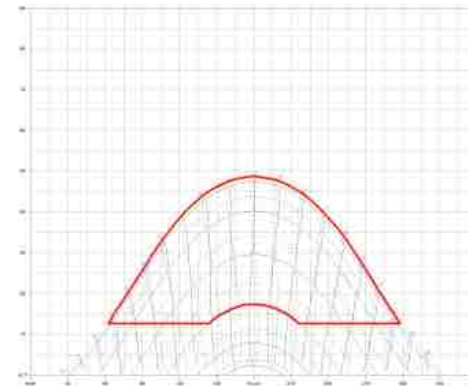

Nome

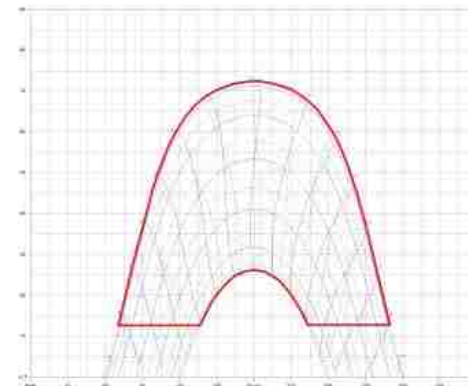

New York City

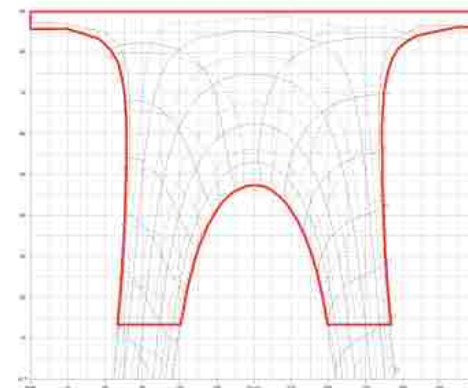

Mexico City

Fig 6.5 Annual Sun Path Diagrams for Selected Gallery Sites

operating parameters, operating hours can easily be gathered for any location on any day by using a sun path diagram to determine at what time the sun's angle is above 10° from the horizon. Gallery operating hours are rounded to fifteen minute increments.

6.7 Conclusions

The success of the gallery lies in its ability to illuminate art work under a set of strict lighting conditions. These illuminance levels are based on a modified version of industry accepted lighting requirements. Illuminance levels are tested using a series of digital models. A baseline target for the gallery is defined as an average of 200 lux - 400 lux on a vertical test plane. The gallery's baseline condition is tested at a multiple latitudes under a variety of sky conditions. This results in a daylight control schedule for each latitude.

Because it relies solely on the sun as a light source, the gallery cannot open until the sun is sufficiently high in the sky. Operational hours are based the point at which the sun reaches an angle of ten degrees above the horizon.

7 Development

Due to the technical lighting design restrictions required of a daylit gallery and the need for an organized modular system, no single element of the thesis was studied purely in isolation. Every design decision directly impacted multiple aspects of the gallery in appearance and performance. When possible, a single design solution was developed to solve multiple issues. This was necessary to increase efficiency and eliminate waste in a compact building.

However, for ease of explanation, the development of the thesis is broken down into three concepts: the modular gallery in which art is viewed, the technical system required to deliver daylight to the gallery, and the daylighting conditions generated from that system. This chapter details how each concept is developed and integrated into the gallery.

7.1 Building Module

Because the gallery is intended to be easily erected, dismantled and transported via conventional means, a modular frame based on container dimensions and prefabricated building systems proved the most effective method for constructing the gallery. Modular frame construction allows for the majority of the gallery to be constructed off-site and requires only foundation preparations, frame connections and weather proofing at the building site. This allows for a small team of professionals to erect or dismantle the gallery in a minimal amount of time.

The gallery module is developed on an 8'-6" grid (the maximum allowed width for U.S. highway transportation) to increase configurability between modules. The module's length is either 17 feet (two modules wide) or 34 feet (four modules wide), and the overall module height is 11'-6". This dimension is also based on U.S. federal regulations for highway transportation.

The building module is comprised of a rigid frame and infill partition panels. This system provides increased design flexibility in comparison to the use of converted shipping containers. It also eliminates the high energy and material cost needed to structurally retrofit containers.

The module frame is built of 8"x 8" tube steel in order to minimize deflection and allow for connection points to puncture the frame while maintaining structural integrity. A thicker frame also allows for thicker infill panels, resulting in better insulated floors and walls.

Transportability

Due to their base dimensions, the gallery modules are able to be transported to virtually any location. While the most common method for transport is truck, rail and container ships allow for large numbers of modules to be transported greater distances at a much lower cost. After they have arrived at a larger transportation hub, trucks can then deliver the galleries to a specific location. Once on site, a crane places the individual modules into place. When cranes are not an option or a site is too remote, helicopters can also be used to transport and place the modules.

Frame connections

The modules are connected in a similar manner as freight containers during transport. The module frames are bolted together at reinforced connection locations located 8'-6" on center. [Fig: 7.3] The same bolted connection allows for both parallel and perpendicular modular configurations. [Fig: 7.4] A rubber gasket located between the two frames acts as a moisture barrier.

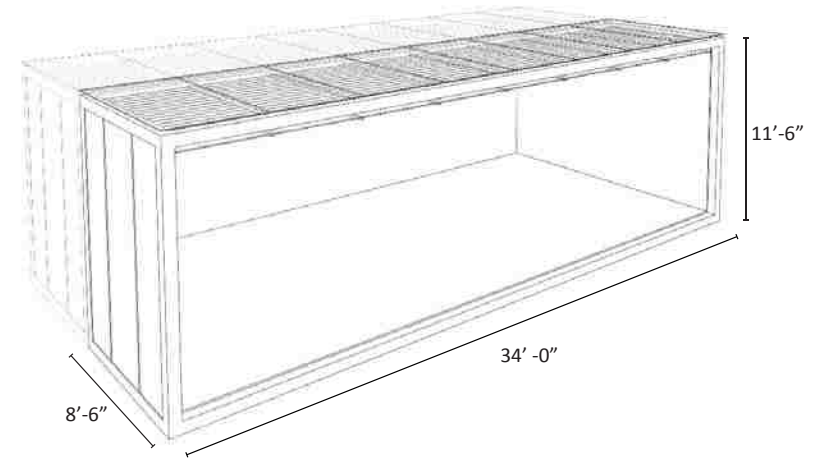

Fig: 7.1 Gallery Module Dimensions



Fig: 7.2 Gallery Modules in Transit

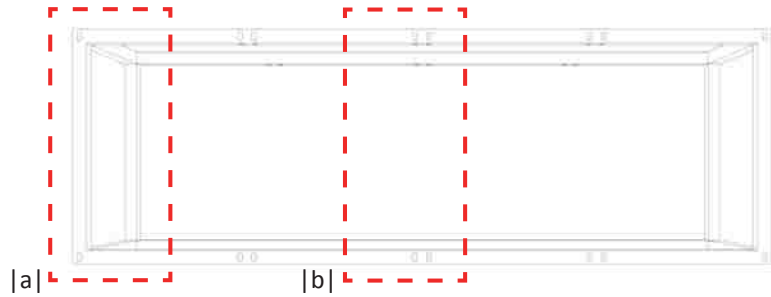

Fig: 7.3 Frame Connection Points. |a| corner, |b| mid-span

Building Foundations

The structural load of each gallery module is transferred through its corners. Many foundation options are possible depending on the project site and permanence of the gallery. The most basic foundation designed for relatively flat, paved sites consists of concrete pads and an anchor plate at each corner of the module frame. The module is then attached to the plate using the same techniques used to attach the modules to one another. [Fig: 7.6]

When sited on uneven terrain, piers are joined by a horizontal steel deck. Again the gallery modules are attached to the deck through a bolted connection.

Wall and Floor Panels

Prefabricated panelized walls and floors are connected directly to the frame. This is done off-site, but there is the potential for walls to be removed and relocated on-site if new configurations are required. Variations in wall panels offer vertical glazing and alternative interior surface materials.

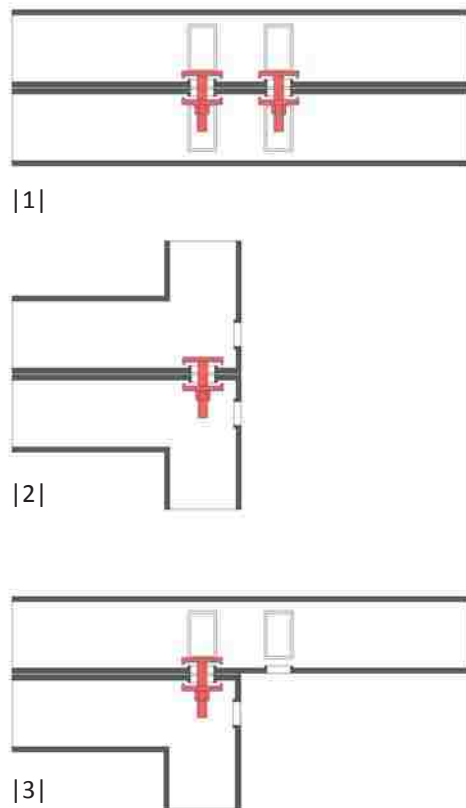

Fig: 7.4 Frame Connections based on connection Points
 |1| Mid-span connection, |2|corner-to-corner connection
 |3| corner-to-mid-span connection

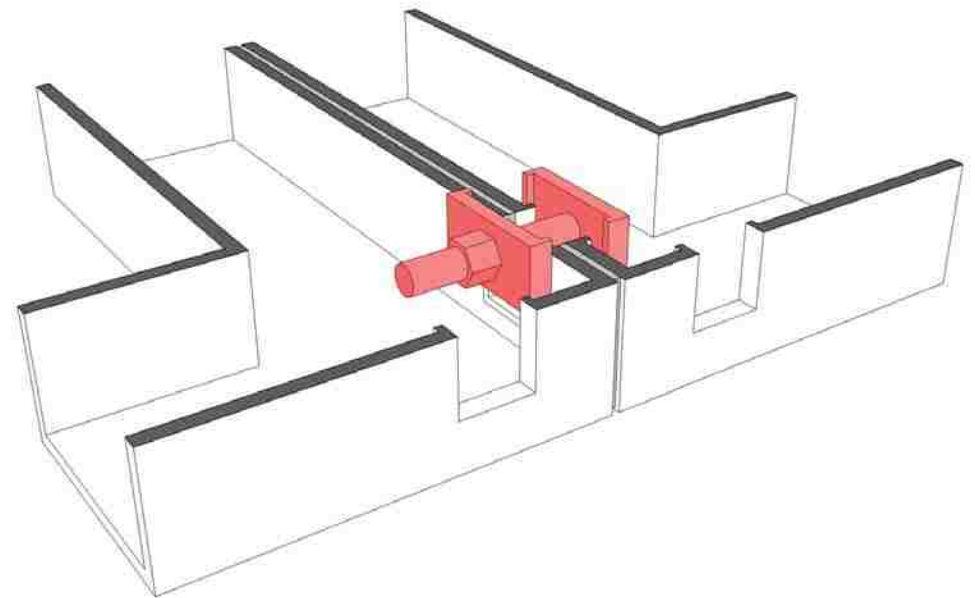

Fig: 7.5 Bolted Frame Connection

Specialized Modules

In addition to the typical gallery module, several specialized modules are necessary in order to increase overall building functionality under a variety of physical conditions. These modules include both internal and external stairs, an elevator, restrooms, and a mechanical unit. Empty frames also provide structural support for multi-story galleries. The 34-foot restroom module contains two restrooms as well as a septic space housing both fresh and waste water. The 17-foot mechanical module houses equipment necessary for heating and electricity in off-grid locations.

Environmental Controls

In order to operate off-grid, the gallery's environmental controls are designed to minimize energy consumption while taking advantage of natural resources. The gallery is heated by an in-floor hydronic radiant system. Evacuated solar tubes located on the roof of the mechanical module work in conjunction with a closed-loop pressurized glycol boiler to generate solar hot water. The mechanical module also houses the control valves for radiant flooring. A ballcock valve in each floor unit controls the radiant connections and isolates the floors during transportation. When located on site, the valves are reopened and the radiant system is restored. The system is also zoned by modules to increase efficiency and allow for individual control based on solar gains within the galleries.

A ventilation system is developed at the conceptual level, however further explorations would be necessary to create a truly viable system. The following is a proposed study of how a ventilation system may work.

Passive intake vents are located at the base of each floor unit. A desiccant dehumidifier removes excess humidity before air enters the gallery. The air is tempered by the radiant flooring in an under-floor plenum before entering the gallery. Passive diffusers are located where the floor meets the gallery walls and at breaks between modules. Air is exhausted through a small mechanical fan located at the top of the wall system. [Fig: 7.8]

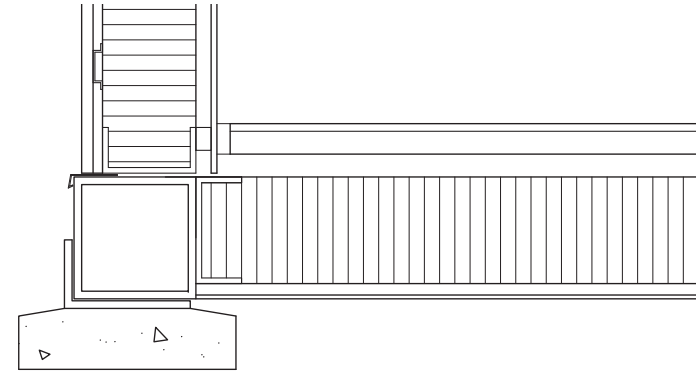

Fig: 7.6 Typical Footing Detail

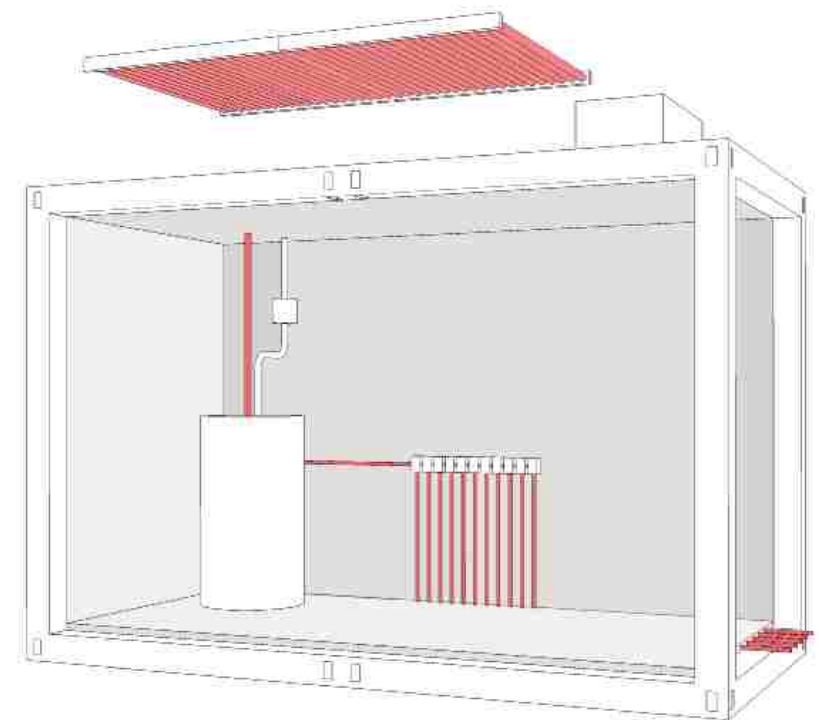

Fig: 7.7 Mechanical Module- highlighting the solar hot water collection system.

Through the course of design, several studies looked at the potential sources of electric power for the gallery. While solar power is an obvious choice, the number of panels required at various site locations can vary dramatically and potentially require large amounts of space. However conceptual studies of the issue looked at the development of integrated photovoltaic awnings with a control center and storage battery in the mechanical module. The awnings would be mounted on modular frames. Backup generators would supplement any additional required energy not provided by the photovoltaic panels.

7.2 Daylight Control

In developing the toplit shading device, it was quickly determined that operable louvers would be the most successful method for achieving the lighting quality desired. Louvers offer the most flexibility within a system and can be programmed to provide similar results in a variety of latitudes.

Fig 7.8 Environmental Controls
The gallery takes advantage of efficient heating and ventilation systems.

[1] Fresh air is passively drawn in from underneath the gallery and over a linear desiccant dehumidifier. [2] The air is tempered as it moves through a plenum under the radiant flooring and enters the gallery. [3] Active exhaust fans expel air at the top of the wall system.

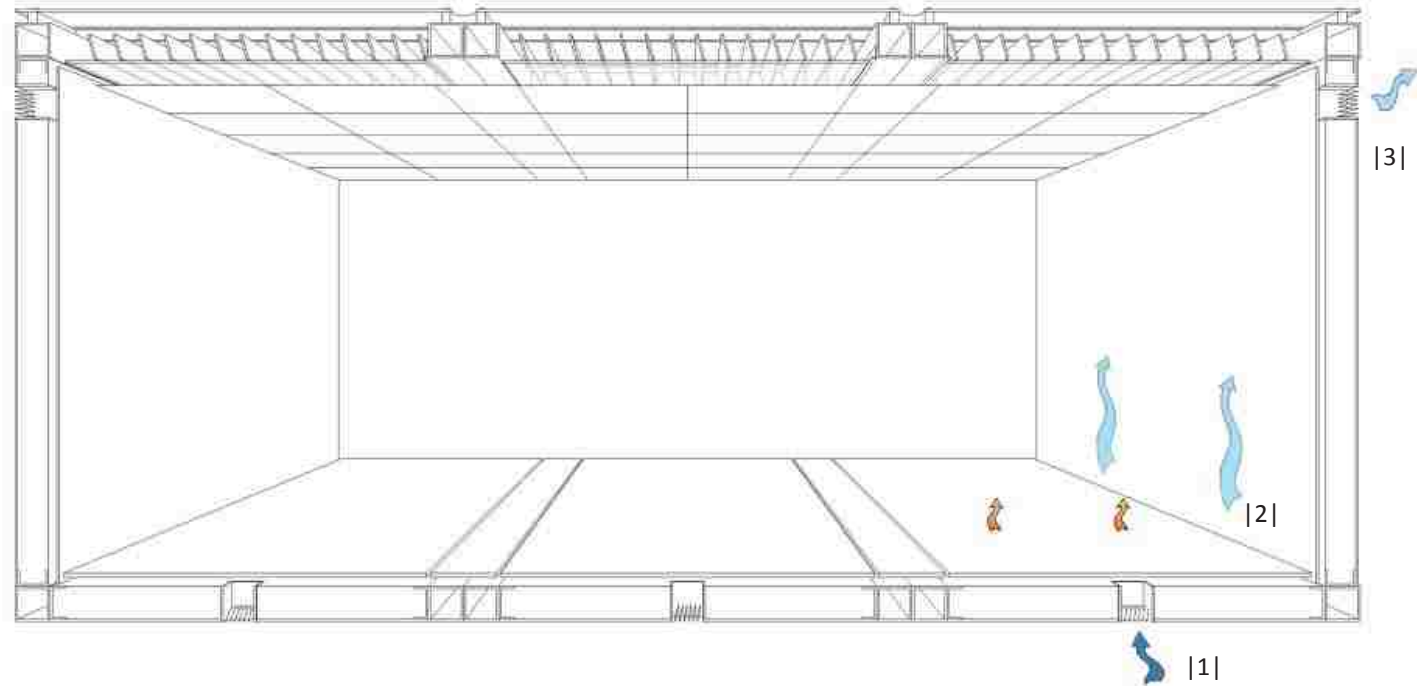

Approach

The daylighting system was developed based on three methods of control; diffusion, intensity, and distribution. Diffusion, in the form of translucent glazing, redirects and scatters light. This results in an even, indirect distribution of light. Translucent glazing blocks direct sunlight and eliminates shadows. The intensity, or amount of light entering the gallery, is controlled by operable louvers. The louvers have the ability to block up to one-hundred percent of available light when fully closed (0° to the horizontal), or allow for complete transmission when fully open (90° to the horizontal). The final distribution of light is determined by the surface materials of the gallery itself. A second layer of translucent glazing scatters any directional light resulting from the louvers and reduces the visibility of the louvers themselves.

Each of these levels was individually tested in order to determine how it affected daylight distributions and intensities in the gallery. This was done in order to verify the assumptions of the system's performance.

Louvers and Orientation

An early study looked at the distribution of light on the vertical test plane based on the size and shape of the louvers. The study showed one-foot deep louvers to be the most effective. However, due to a desire to minimize the system depth and maximize the interior gallery height, the six-inch louver was determined to be more beneficial for the gallery as a whole.

A series of studies in orientation determined that louvers running north-south and opening to the west proved the most effective at evenly distributing light within the gallery. This decision informed the orientation of the gallery modules as well. Although they can perform in multiple orientations, the most effective module orientation is north-south along its longitudinal axis. The appropriate transmittance levels for each glazing component were determined by testing the operational extremes required of the louver system (low latitudes under clear June conditions and high latitudes under overcast November conditions.)

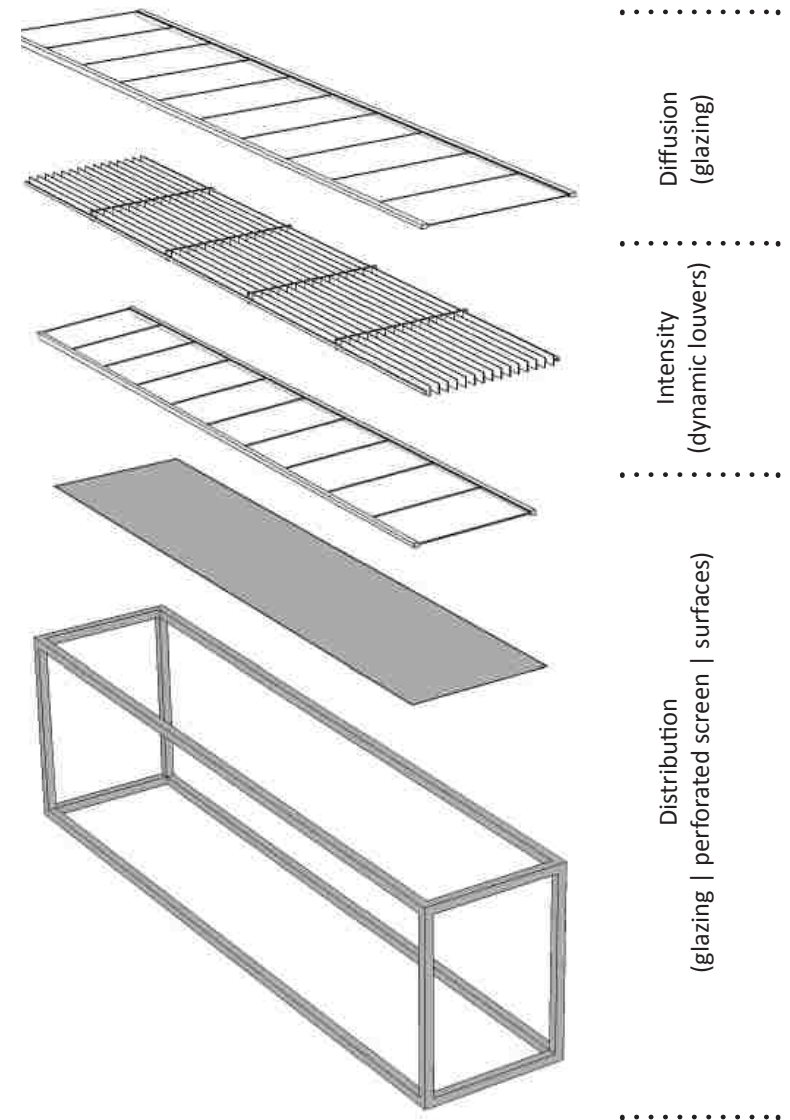

Fig: 7.9 Three Methods of Daylight control

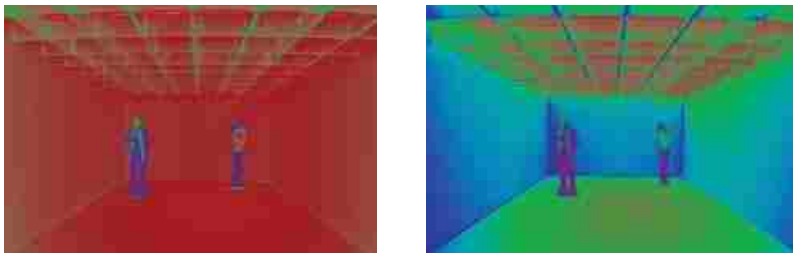

Fig: 7.10 Material Analysis using falsecolor imaging to compare two wall surfaces. The gray wall on the left appears to be darker even under the exact same lighting conditions. (Images taken in overcast sky box.)



Fig: 7.11 Eggcrate diffuser Study- varying spacing (Images taken in overcast sky box.)

Material studies

Because the habitable portions of the gallery also play a large role in how light is distributed, material finishes and methods of interior distribution were also studied. While the color of a surface will not affect the intensity of direct light striking its surface, it plays a large role in the percentage of light redirected throughout the space and the perceived brightness within the gallery. [Fig: 7.10] An early luminance study explored the effects of surface colors within the gallery. The results suggested that several wall-finish options may be advantageous depending on the desired mood of the gallery. Paint color could be used to enhance or de-emphasize certain aspects of the gallery or a work of art.

Several types of ceiling diffusers were studied to understand the effects of masking the daylight control system, and to break up the continuous ceiling plane. Eggcrate diffusers have the positive benefit of evenly distributing light in the horizontal plane, but quickly reduce the overall height within the gallery. It was determined any positive benefits of the eggcrates were offset by this reduction of height. Additionally these diffusers would increase visual contrast when looking directly up at the ceiling. A perforated screen was found to provide similar results while greatly reducing the overall depth of the daylighting system.

Site Performance and a Louver Scheduling

After establishing the basic design of the louver system, the galleries were digitally tested under the most demanding conditions required of the system. The baseline scenario is designed to deliver an average illumination between 200 and 400 lux without exceeding 500 lux at any point on the vertical test plane.

The gallery was tested for June 21 (summer solstice), December 21 (winter solstice) and September 21 (fall equinox) under clear conditions and for September 21 under overcast conditions. Each site was tested under these four conditions in two hour intervals Between 6:00am and 10:00pm. The resulting louver schedule acts as the foundation of an automated time schedule for the system's operation. (The louver schedules are discussed again in Chapter 8.)

The successful development of a daylighting control schedule at the low end of the system, verified the gallery's ability to perform in the most restrictive of conditions. These results served as a baseline for the generation of subsequent daylighting scenes.

System Construction

The daylighting control system is designed to be compact, allowing for increased head-height within the gallery. The entire system is attached to the modular frame as one unit.

The louvers are segmented into eight independently controlled sections. Each louver group is located between two-inch thick extruded aluminum frames that house control actuators. A single actuator operates each louver section and regulates the louver's rotation up to 90° from a closed horizontal position. [Fig:7.12] The lower glazing panel and anchor points for the hung diffusing screen are also integrated into the aluminum frame. The louver actuators are accessible for maintenance by removing the glazing panels. [Fig: 7.13]

7.3 Daylighting Scenes

Museum lighting is intended to continuously light an object at low levels of illumination. This prevents a piece of art from becoming over-exposed throughout its lifetime. However, by shortening the duration of time a work of art is illuminated, its instantaneous illumination can be increased. The potential to increase light levels in short durations provides more flexibility in how artwork can be lit. The Gallery takes advantage of this by using light and contrast to increase the drama of the viewing experience. It examines the relationship between art and daylight in both instantaneous configurations and over a period time.

The key to the gallery's success lies in its ability to deliver a broad range of daylighting experiences. Using the same control system, lighting scenes have the potential to quietly illuminate a work of art or dramatically enhance a provocative installation. In addition to examining the instantaneous relationship between art and daylight, the dimension of time provides dynamic lighting qualities that enhance the overall visual experience. This notion of time is what separates this

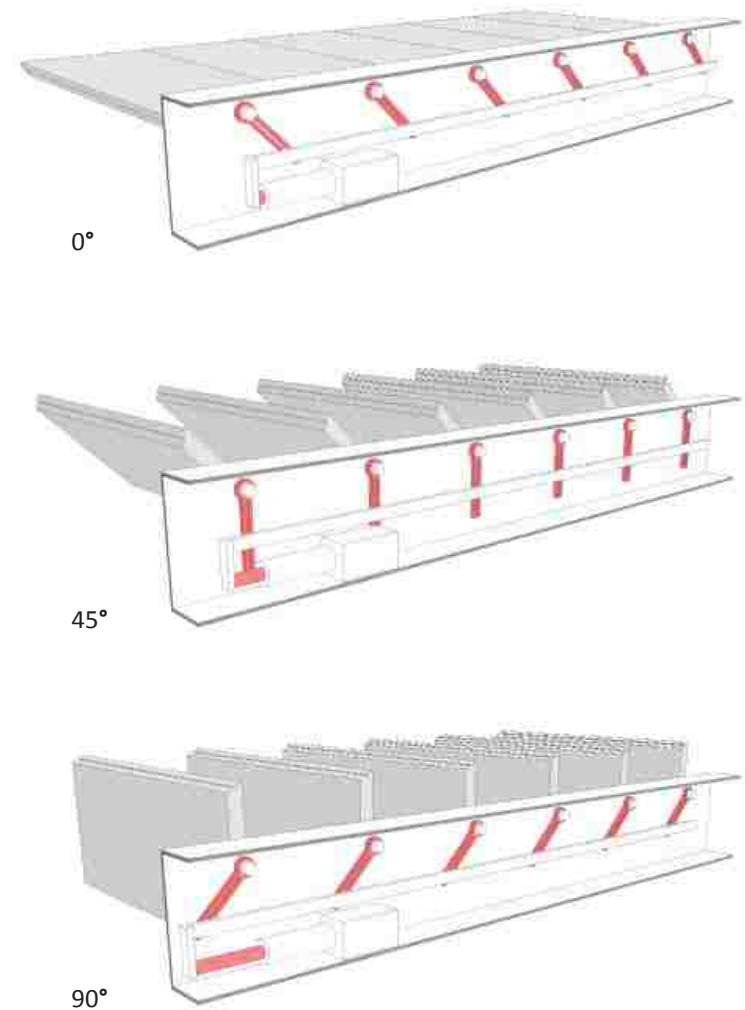

Fig: 7.12 Louver Operation and Actuator

- |1| Skylight Glazing
- |2| Structural Frame
- |3| Louver
- |4| Louver Mullion
- |5| Actuator
- |6| Glazing

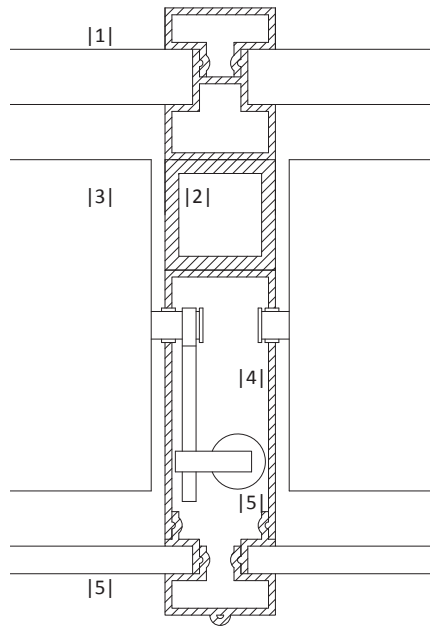

Fig: 7.13 Section of Louver Frame

gallery from other daylit galleries.

The daylighting scenes are intended to create an interactive environment that tells the story of the art on display. This is accomplished by using light to transition between several works of art or allowing the light to change in intensity as a result of natural or artificial factors. Programmable daylighting controls allow artists to create unique lighting conditions for their installations.

Several lighting scenes have been developed for the purposes of this thesis, but the potentials of the system are in no way limited to these configurations.

Continuous Lighting

The most basic visual scene is also the most technically complex. This baseline condition provides even light throughout the entire gallery. The louvers act in unison to distribute light with minimal contrast and no lighting hierarchy. As the sun's light intensifies, the louvers automatically dampen, maintaining a continuous level of illuminance. [Fig: 7.15]

Progression- Contrasting Elements

The scene is designed to place several works of art in stark contrast to one another by developing a temporary hierarchy of the art being displayed. Light is redirected throughout the gallery, illuminating several objects on display in sequence, but never fully illuminating two at once. As the lighting intensity on one object begins to fade, a second object slowly becomes illuminated, redirecting the focus of the gallery and forcing a physical response from the viewer. The viewer has the option of moving to the next piece or remaining to see how the first work of art responds to a new light source. [Fig: 7.17 - 7.18]

Daily Transition- Seeing Things in a New Light

This scene focuses on a single work art over the course of a day (or for a set period of time). In this case, the control louvers are fixed in a single position over an extended period of time allowing for exterior conditions to control how the art is viewed. As the sun rises in the sky, the brightness in the gallery intensifies. Shadows

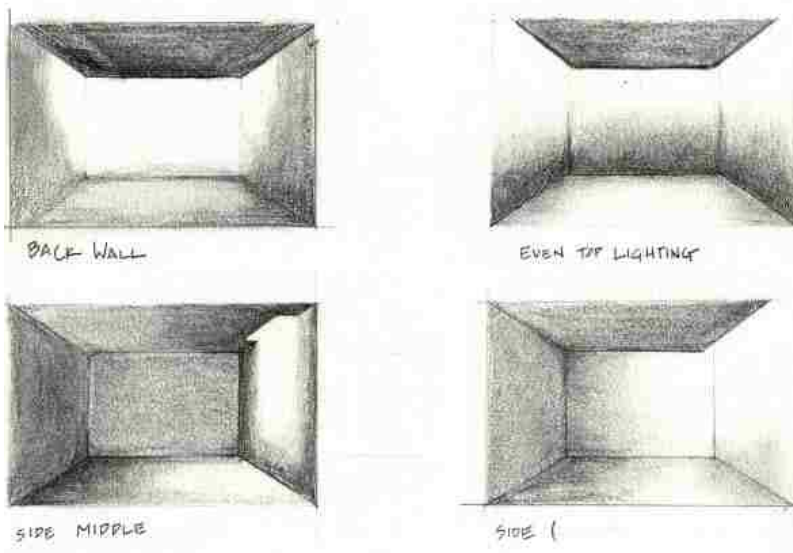

Fig: 7.14 Conceptual studies of lighting scenes

from passing clouds provide instantaneous fluxes in lighting, forcing the eye to momentarily refocus on the art under new conditions. As evening approaches a warm fog appears to materialize in the gallery and the art work slowly fades away into the darkness. The daily transition is similar to how art would be viewed outside on an overcast day. Although, this process can be sped up by operating the control system to mimic the sun's path over a shorter time frame. [Fig: 7.19]



Fig: 7.15 Diffuse Lighting (Image of physical model taken in the overcast sky box.)



Fig: 7.16 Diffuse Sidelighting- One Side (Image of physical model taken in the overcast sky box.)

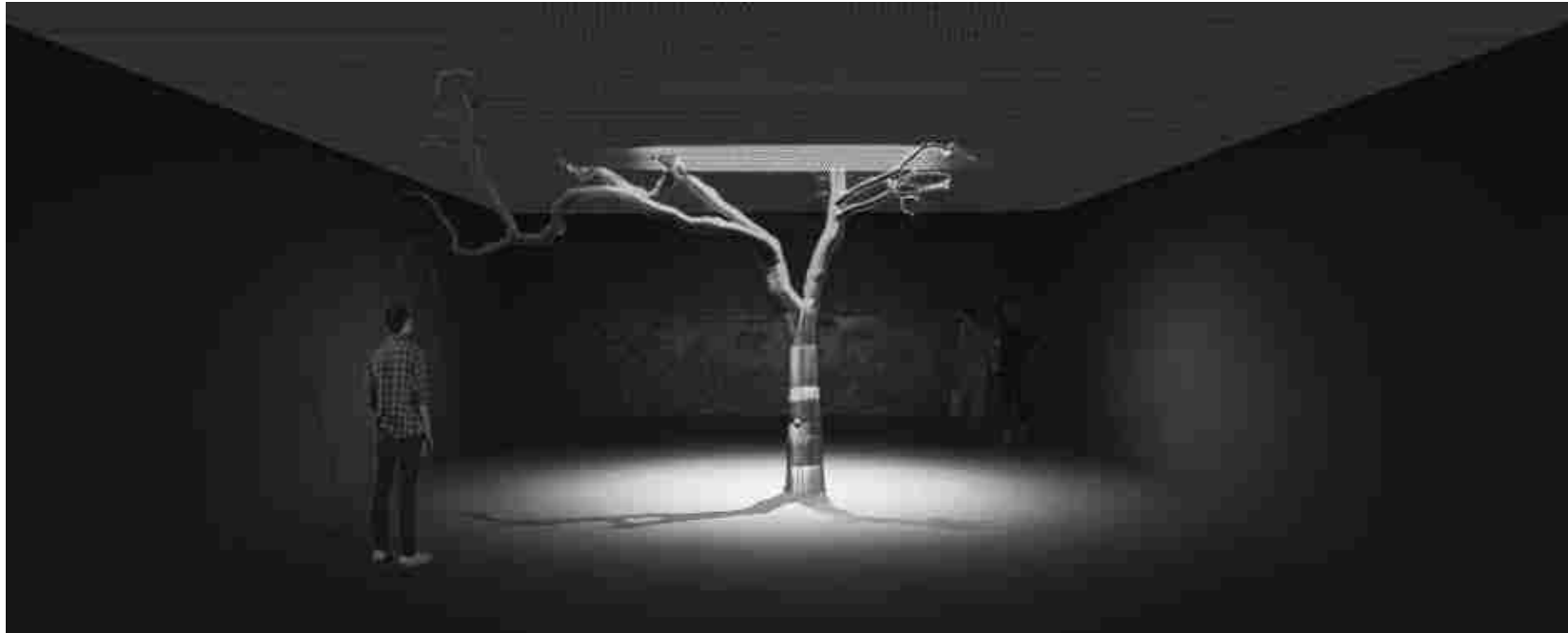

Fig: 7.17 Progression- Focal shift from the center to the backwall of the gallery (digital simulation).



Fig: 7.18 Progression- Focal Shift around the gallery (digital Simulation).

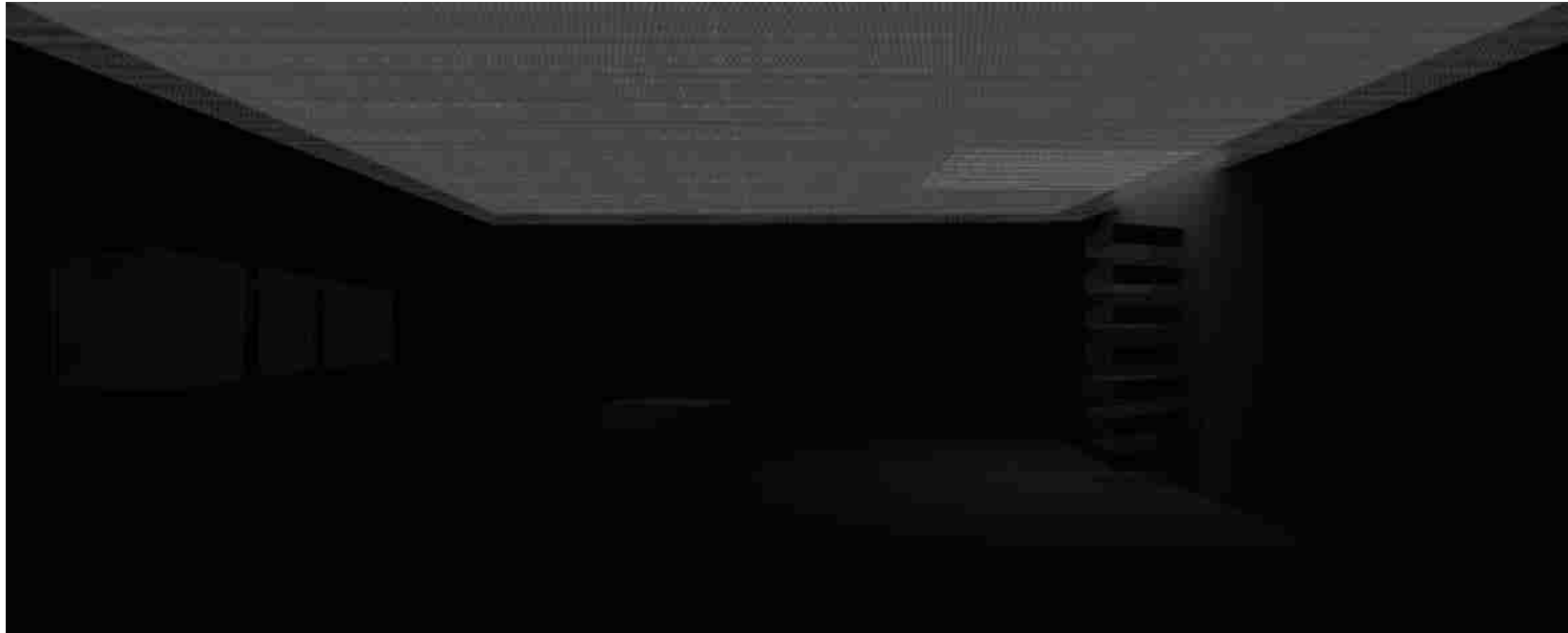

Fig: 7.19 Daily Transition (digital simulation)

8. Onsite: Gallery Development

The following chapter looks at the three test sites for the gallery. Each gallery has the ability to generate the daylighting scenes developed in chapter seven, so specific collections or lighting scenes were not generated for each site. However the procession through the gallery was studied.

These processions are designed to move visitors through the building by using light as a focal point. The final paths of procession are developed from earlier conceptual studies of light and dark. The project sites are not fixed locations, but generic environments conducive to the gallery's intended deployment. The thesis did not focus on site analysis or specific user capacities at any of these sites as it was not a primary goal of the project. Rather it takes a conceptual approach to how the gallery interacts at various locations based on the characteristics of the urban fabric.



8.1 Mexico City, Mexico Latitude 19.4°n Longitude 99.1°w

The gallery in Mexico City is configured as an urban gallery and sited in one of the city's many local plazas. Due to the warm climate the gallery has the potential to be operational year round. It is transported to the site on trucks and deployed using a crane.

Visitors enter into a bright lobby on the first floor. From there they move into a darker narrow hallway. Brightly lit stairs at the end of the hall guide the visitors to the galleries above. Once at the second level the visitors move through a light vestibule and into the gallery space. The light vestibule is intended to block undesirable light from disrupting the scenes within the gallery itself.

Fig: 8.1 Location of Mexico City



Fig: 8.2 Plaza Deployment

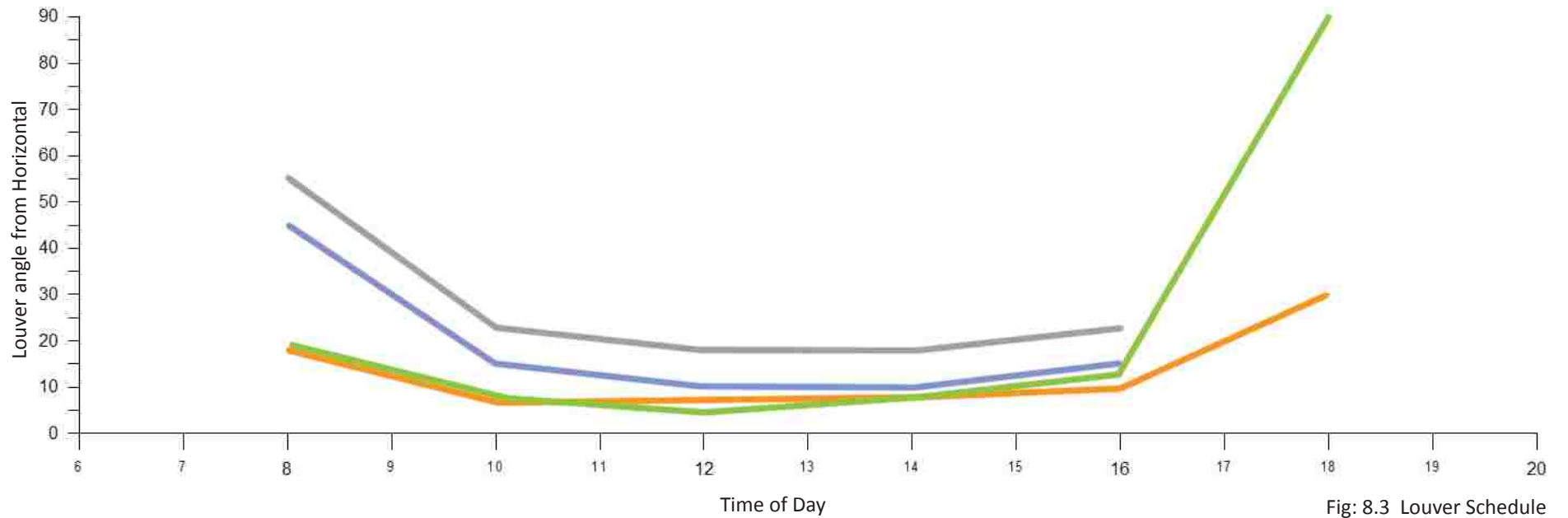

Fig: 8.3 Louver Schedule

Annual Hours of Operation:

Jan 8:00am - 5:30pm
 Mar 7:30am - 6:00pm
 Jun 6:45am - 6:30pm
 Sep 7:15am - 5:45pm
 Dec 8:00am - 5:15pm

- March
- June
- September- Overcast
- December

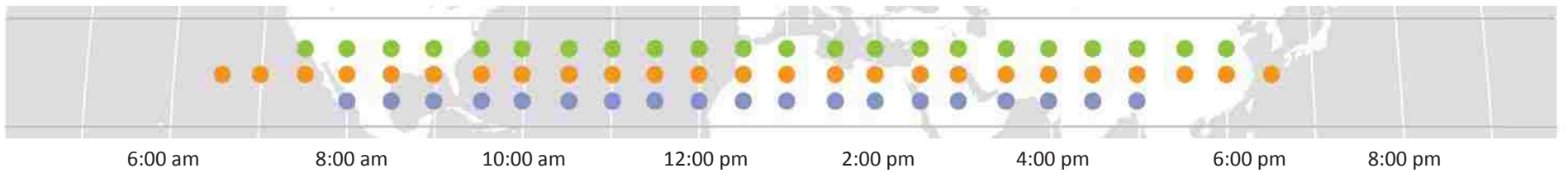

Fig: 8.4 Hours of Operation

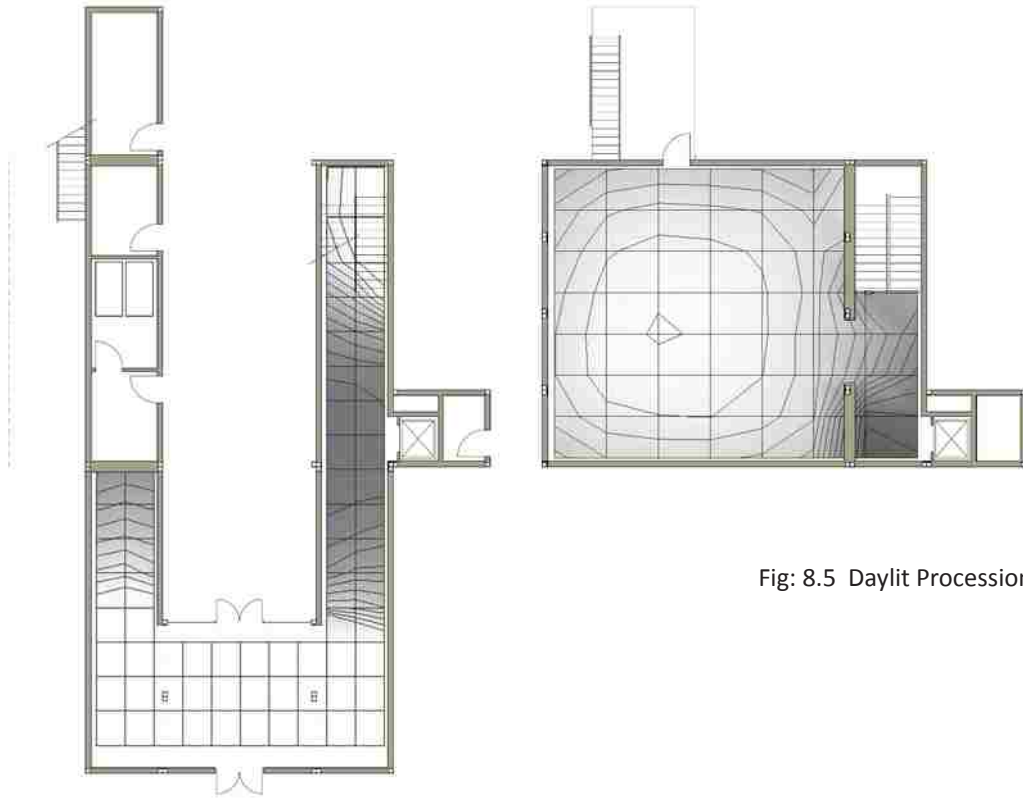

Fig: 8.5 Daylit Procession



Fig: 8.6 Gallery Constructed on Site



Fig: 8.7 Daylight Procession-stair

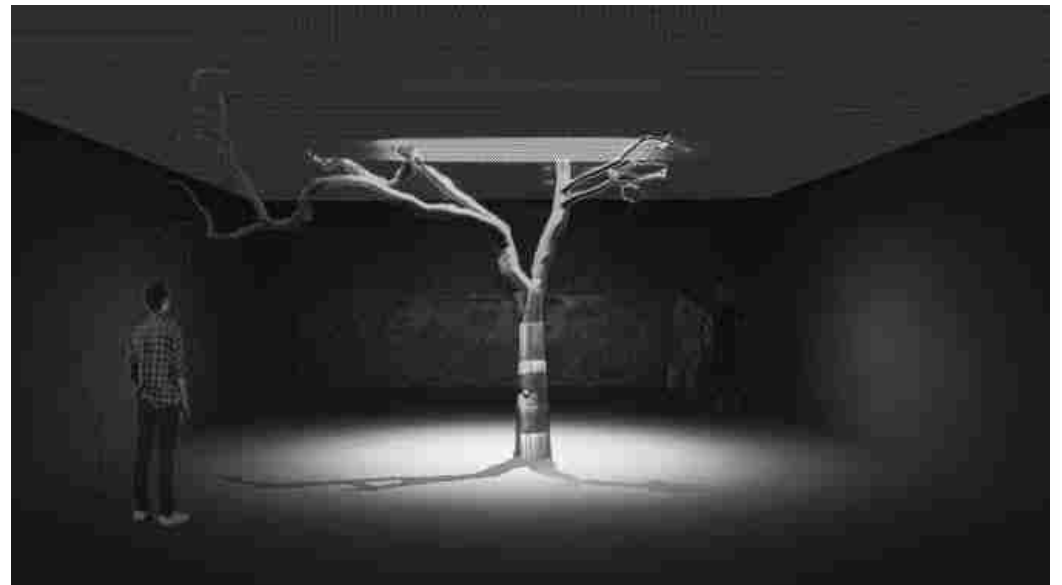

Fig: 8.8 Potential Gallery Scene



8.2 New York City, New York Latitude 40.7°n Longitude 73.5°w

An urban gallery is also deployed in New York City. However it is an extremely compact system designed to be erected quickly. This “guerilla architecture” has the potential to appear anywhere without warning. Its small footprint allows the gallery to be deployed in a variety of urban locations including broad sidewalks or in the parking lane on a street. The gallery is transported to the site via truck and deployed by crane.

Its temporal nature is accentuated by an open stair that brings visitors directly into the unconditioned gallery. For this reason it is better suited to milder seasons where mechanical heating or cooling is not necessary.

Fig: 8.9 Location of New York City



Fig: 8.10 NYC Park Deployment

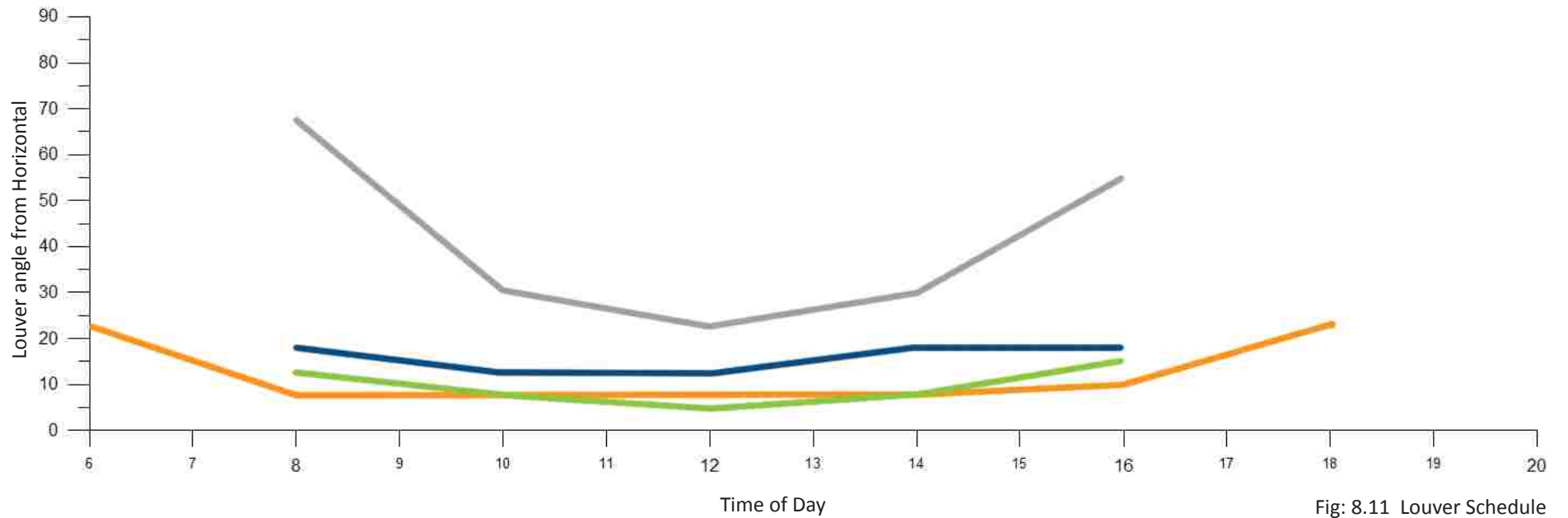

Fig: 8.11 Louver Schedule

Annual Hours of Operation:

Jan	8:30am - 3:45pm
Mar	7:00am - 5:15pm
Jun	5:30am - 6:30pm
Sep	6:30am - 5:00pm
Dec	8:30am - 3:30pm

- March
- June
- September- Overcast
- December

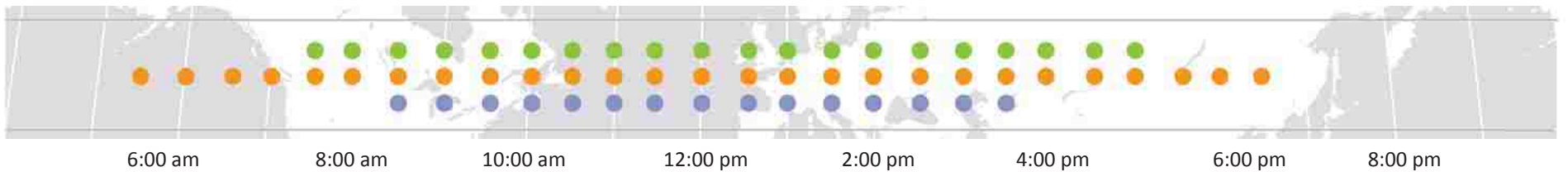

Fig: 8.12 Hours of Operation



Fig: 8.13 NYC Street Deployment



8.3 Nome, Alaska Latitude 64.5°n Longitude 165.4°w

A rural gallery is deployed in the tundra outside of Nome in conjunction with a hypothetical exterior installation like those by the artist Christo. Because of Nome's latitude, the gallery will not function ideally in winter months. However, heavy snows beginning in early October and lasting through April will prevent access to the site well before then. Therefore this site is operational from late spring to early fall. This gallery has the potential to be transported by truck or helicopter depending on road conditions. Due to the natural terrain the gallery is located atop a pier structure.

The one story gallery also directs movement through the use of focal points. A view window at the end of a dark hall moves visitors through the building. Light from the galleries then entices around a corner and into the exhibition spaces.

Fig: 8.14 Location of Nome



Fig: 8.15 Tundra Deployment

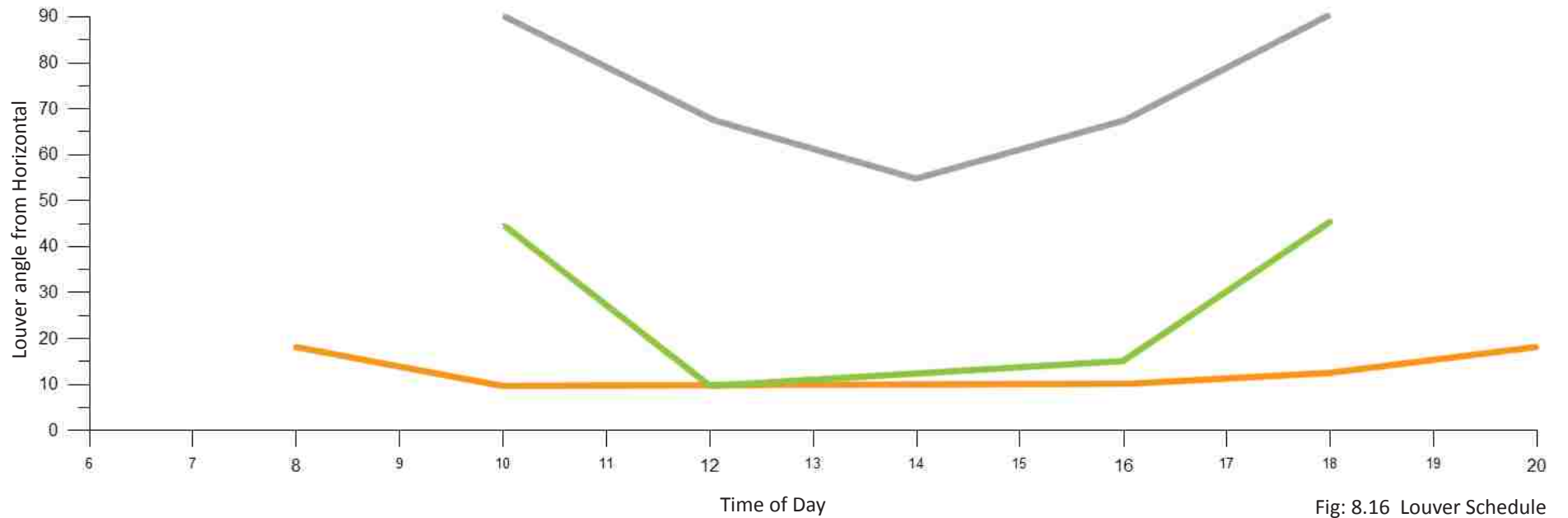

Fig: 8.16 Louver Schedule

Annual Hours of Operation:

Jan --
 Mar 9:45am - 6:30pm
 Jun 6:15am - 10:00pm
 Sep 9:15am - 6:30pm
 Dec --

- March
- June
- September- Overcast
- December

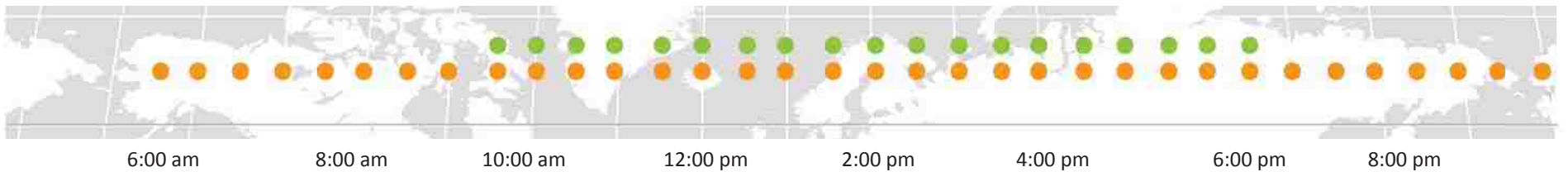

Fig: 8.17 Hours of Operation

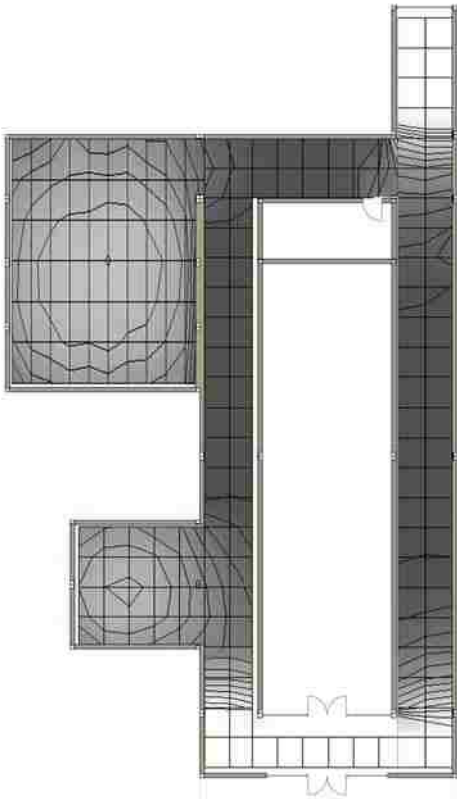

Fig: 8.18 Daylight Procession



Fig: 8.19 Gallery Constructed on Site



Fig: 8.20 Daylight Procession-view Window



Fig: 8.21 Potential Gallery Scene

9 Conclusions

This thesis never set out to completely resolve the relationship between displayed artwork and its light source. Rather it is intended to suggest alternatives for how we visually experience art based on lighting conditions. The daylighting control system and the daylighting scenes it creates are intended to challenge current theories in lighting art. This is achieved through the introduction of daylight as a dynamic element that requires viewers to experience a work of art under a variety of conditions over a period of time.

The original intent of the gallery was to explore the extent to which a universally adaptable daylight control system could deliver similar lighting results at a variety of locations under multiple conditions. However it was quickly realized that such a system has the ability to do far more than simply regulate levels of illuminance. By switching focus from the technical to the experiential aspects of daylight, a new set of possibilities and design issues were generated.

While I do not advocate this solution for every environment, it is my belief that in certain cases the introduction of a dynamic and interactive light source not only adds drama and excitement, but also challenges a viewer to confront the art under a variety of conditions, enabling them to come away with a more comprehensive understanding of the art itself.

9.1 Additional Applications

In addition to the applications set forth in the thesis, individual components of the system have practical applications in other Environments.

Single Locations

While the thesis explored the possibility of multiple sites, the designed daylight control system is perfectly suited to fixed locations as well. As long as adequate daylight is present, the system can be used to reshape any gallery space.

Technology and Industry

The daylight control system has the potential to also function in the vertical plane. While not functional as view windows, this system can perform well in space with a variety of lighting needs ranging adequate daylighting to black out conditions. The system is well suited to for spaces with highly specialized audio/visual display requirements. Recently computer and software retailers have begun developing highly interactive showrooms to display their products. A dynamic system would not only provide light control but also avoid the need for a black box isolated from the exterior environment.

9.2 Feasibility

For this project to become feasible additional research would need to go into the development of the gallery's environmental controls. The concepts outlined earlier in the thesis may serve as a starting point, but thermal and moisture controls in the museum environment are just as important as those for lighting. Extensive research would be needed to determine the most appropriate thermal control system for a wide range of locations. Ultimately, several control systems may be required based on appropriateness for the climate of the project site.



Fig: 9.1 Acropolis Airlift

References:

Baker, Nick, and Koen Steemers. *Daylight Design of Buildings*. London: James & James, 2002. Print.

Broudy, Liz. "Appendix D. Lighting." *Museum Design: Planning and Building for Art*. By Joan Darragh and James S. Snyder. New York: Oxford UP in Association with the American Federation of Arts and the National Endowment for the Arts, 1993. 263-71. Print.

Buchanan, Peter. *Renzo Piano Building Workshop: Complete Works*. Vol. 4. London: Phaidon, 2005. Print.

Casey, Valerie. "The Museum Effect: Gazing from object to Performance in the Contemporary Cultural-History Museum." Lecture. ICHIM 2003 Conference. Paris, France. 8-12 Sep. 2003. Archives & Museums Informatics Europe, 2003. Web. 25 May 2011. <http://www.valcasey.com/thesis/ichim/assets/casey_ichim.pdf>.

The Fondation Beyeler, ed. *Renzo Piano: Fondation Beyeler : a Home for Art*. Basel: Birkhäuser--Publishers for Architecture, 1998. Print.

Kahn, Louis I., and Nell E. Johnson. *Light Is the Theme: Louis I. Kahn and the Kimbell Art Museum : Comments on Architecture*. Fort Worth, TX: Kimbell Art Foundation, 1975. Print.

"Museums." *Daylight Performance of Buildings*. Ed. Marc Fontoynt. London: James & James (Science) for the European Commission, Directorate General XII for Science, Research and Development, 1999. 71-110. Print.

O'Doherty, Brian. *Inside the White Cube: The Ideology of the Gallery Space*. Berkeley: University of California Press, 1986. Print.

Rea, Mark S., ed. *The IESNA Lighting Handbook: Reference & Application*. Ninth ed. New York, NY: Illuminating Engineering Society of North America, 2000. Print.

Sheikh, Simon. "Positively White Cube Revisited." *E-flux*. E-flux, Feb. 2009. Web. 14 Sept. 2011. <<http://www.e-flux.com/journal/positively-white-cube-revisited/>>.

Siegel, Jennifer. *More Mobile: Portable Architecture for Today*. New York: Princeton Architectural, 2008. Print.

Slawik, Han, Julia Bergman, Maththais Buchmeier, and Sonja Tinney, eds. *Container Atlas: a Practical Guide to Container Architecture*. Berlin: Gestalten, 2010. Print.

Waltl, Christian. "Museums for Visitors: Audience Development- A Crucial Role for Successful Museum Management Strategies." Lecture. Intercom 2006 Conference. Taipei, Taiwan. 1-4 Nov. 2006. INTERCOM: International Committee on Management. National Museums Liverpool, 25 Feb. 2011. Web. 5 May 2011. <<http://www.intercom.museum/documents/1-4Waltl.pdf>>.

Figure Credits

Figure Number

- 1.1 <http://www.panoramio.com/photo/15858259> william Lile
- 1.2 Slawik, Han, Julia Bergman, Maththais Buchmeier, and Sonja Tinney, eds. Container Atlas: a Practical Guide to Container Architecture. Berlin: Gestalten, 2010. Print.
- 2.1 <http://www.toutfait.com/imageoftheday.php?&pageNo=42>Interactive
- 2.2 website < <http://tomeffect.wordpress.com/2011/04/29/interactive-museums/> >
- 3.1 website < <http://thespunkyscientist.blogspot.com/2011/04/lesson-of-unseen.html> >
- 3.2 website < <http://www.topbulb.com/find/grow-lights-bulbs.asp> >
- 3.3 website < <http://www.mediacollege.com/lighting/colour/colour-temperature.html> >
- 3.4 photos by author
- 3.5 website < <http://www.nasa.gov/centers/glenn/business/AtomicOxRestoration.html> >
- 3.6 table by author
- 3.7 Rea, Mark S., ed. The IESNA Lighting Handbook: Reference & Application. Ninth ed. New York, NY: Illuminating Engineering Society of North America, 2000. Print. 5-17.
- 3.8 Rea, Mark 5-17.
- 3.9 Rea, Mark 5-17.
- 3.10 website < <http://www.fondationbeyeler.ch/en/museum/impressions/impressions> >
- 3.11 website <<http://www.fotopedia.com/items/flickr-2370299271>>
- 3.12 website <<http://viewpictures.co.uk/Search.aspx?searchtype=adv&contributor=216>>
- 3.13 Buchanan. 76.
- 3.14 website < <http://www.fondationbeyeler.ch/en/museum/impressions/impressions> >
- 3.15 website < <http://www.fondationbeyeler.ch/en/museum/impressions/impressions> >
- 3.16 website < <http://www.fondationbeyeler.ch/en/museum/impressions/impressions> >
- 4.1 website < <http://www.dimensionsguide.com/shipping-container-dimensions/> >
- 4.2 website < <http://www.tractorbynet.com/forums/rural-living/141609-storage-dry-van-vs-shipping.html> >
- 4.3 Slawik, Han. 23.
- 4.4 website < <http://www.designtavern.com/2008/11/nest-architects-gorman-shipshop/> >
- 4.5 Slawik, Han. 33.
- 4.6 Slawik, Han. 177.
- 4.7 Slawik, Han. 39.
- 4.8 Slawik, Han. 95.GAD
- 4.9 website < <http://www.mmw.no/projects/culture/gad?gallery=photos> >
- 4.10 website < <http://www.mmw.no/projects/culture/gad?gallery=photos> >
- 4.11 website < <http://www.mmw.no/projects/culture/gad?gallery=photos> >

Figure Credits (continued)

Figure Number

- 4.12 website < <http://www.mmw.no/projects/culture/gad?gallery=photos> >
- 4.13 website < <http://www.mmw.no/projects/culture/gad?gallery=photos> >
- 4.14 website < <http://www.mmw.no/projects/culture/gad?gallery=photos> >
- 4.15 website < <http://www.mmw.no/projects/culture/gad?gallery=photos> >
- 4.16 website < <http://www.mmw.no/projects/culture/gad?gallery=photos> >
- 4.17 website < <http://www.archdaily.com/20709/container-art-bernardes-jacobsen>>
- 4.18 website < <http://www.archdaily.com/20709/container-art-bernardes-jacobsen>>
- 4.19 website < <http://www.archdaily.com/20709/container-art-bernardes-jacobsen>>
- 4.20 website < http://www.nicolavilla.com/NICOLA_VILLA/CONTAINER_ART.html >
- 4.21 website < <http://www.archdaily.com/20709/container-art-bernardes-jacobsen>>
- 4.22 website <<http://emilycarrrecruit.wordpress.com/2011/04/20/pne-container-art-2011-call-for-submissions/pne-container-art/>>
- 4.23 website < <http://www.archdaily.com/20709/container-art-bernardes-jacobsen>>
- 4.24 website < <http://www.flickr.com/photos/xoxoryan/323686728/> >
- 4.25 website < <http://www.flickr.com/photos/xoxoryan/323686728/> >
- 4.26 website < <http://chuly.com/2630664> >
- 4.27 website <<http://www.flickr.com/photos/xoxoryan/323696034/sizes/z/in/photostream/>>
- 4.28 website <<http://chofang.com/gallery/?picasaViewAlbumId=PapertainerMuseum%2C0> >
- 4.29 website <<http://www.flickr.com/photos/xoxoryan/323693663/sizes/z/in/photostream/>>
- 4.30 Slawik, Han. 405.
- 5.1 image by author
- 5.2 image by author
- 6.1 table by author
- 6.2 table by author
- 6.3 photos by author
- 6.4 image by author
- 6.5 image by author
- 7.1 image by author
- 7.2 image by author
- 7.3 image by author
- 7.4 image by author
- 7.5 image by author
- 7.6 image by author
- 7.7 image by author

Figure Credits (continued)

- 7.8 image by author
- 7.9 image by author
- 7.10 photo by author
- 7.11 photo by author
- 7.12 image by author
- 7.13 image by author
- 7.14 image by author
- 7.15 photo by author
- 7.16 photo by author
- 7.17 image by author
- 7.18 image by author
- 7.19 image by author
- 8.1 image by author
- 8.2 image by author
- 8.3 image by author
- 8.4 image by author
- 8.5 image by author
- 8.6 image by author
- 8.7 image by author
- 8.8 image by author
- 8.9 image by author
- 8.10 image by author
- 8.11 image by author
- 8.12 image by author
- 8.13 image by author
- 8.14 image by author
- 8.15 image by author
- 8.16 image by author
- 8.17 image by author
- 8.18 image by author
- 8.19 image by author
- 8.20 image by author
- 8.21 image by author
- 9.1 image by author