

---

Masters Theses

Student Theses and Dissertations

---

Spring 2018

## Effect of variation of parameters on biogas production using Aspen Plus & Dynamic Simulation using Mimic

Shruti Shrikant Karambelkar

Follow this and additional works at: [https://scholarsmine.mst.edu/masters\\_theses](https://scholarsmine.mst.edu/masters_theses)



Part of the [Chemical Engineering Commons](#)

Department:

---

### Recommended Citation

Karambelkar, Shruti Shrikant, "Effect of variation of parameters on biogas production using Aspen Plus & Dynamic Simulation using Mimic" (2018). *Masters Theses*. 7764.

[https://scholarsmine.mst.edu/masters\\_theses/7764](https://scholarsmine.mst.edu/masters_theses/7764)

This thesis is brought to you by Scholars' Mine, a service of the Missouri S&T Library and Learning Resources. This work is protected by U. S. Copyright Law. Unauthorized use including reproduction for redistribution requires the permission of the copyright holder. For more information, please contact [scholarsmine@mst.edu](mailto:scholarsmine@mst.edu).

EFFECT OF VARIATION OF PARAMETERS ON BIOGAS PRODUCTION USING  
ASPEN PLUS & DYNAMIC SIMULATION USING MIMIC

by

SHRUTI SHRIKANT KARAMBELKAR

A THESIS

Presented to the Faculty of the Graduate School of the  
MISSOURI UNIVERSITY OF SCIENCE AND TECHNOLOGY

In Partial Fulfillment of the Requirements for the Degree

MASTER OF SCIENCE IN CHEMICAL ENGINEERING

2018

Approved by

Joseph Smith, Advisor  
Douglas Ludlow  
Christi Luks

© 2018

Shruti Shrikant Karambelkar

All Rights Reserved

## **PUBLICATION THESIS OPTION**

This thesis consists of the following article, formatted in the style used by the Missouri University of Science and Technology

Paper I: Pages 3 to 36 will be submitted to Chemical Engineering Science journal

## ABSTRACT

Design and management for Biogas production have gained significance in growing dependency on Renewable energy resources. This would need a detailed information on steady state and dynamic behavior of systems. In order to make this process environmentally ecofriendly, its needs a lot of improvisation on process simulation. Anaerobic digestion helps treat this inefficient water to be converted into water fit for effluent purposes.

Byproducts contain consists of organic, inorganic and wastes which lead to a high COD content and thus, cannot be discarded into the outlets. The anaerobic digestion process. A study of these effects with simulation need to be validated against experimental results. A dynamic model has been simulated for operator training purposes and thus, real plant has been modeled using Mimic.

## ACKNOWLEDGMENTS

I would like to extend my sincere vote of thanks to Dr. Joseph Smith for his guidance and motivation. He has been the real catalyst throughout my Masters' who has directed me towards pursuing a great career. He has shown me the right path for me to excel with flying colors. He has been a great and a dedicated mentor, his guidance has set my foundation towards my career. I am also thankful to my committee Dr. Douglas Ludlow and Dr. Christi Luks for their support and patience in the completion of my Project. Also thankful for their prompt response and readiness for being a part of my committee. I am obliged to Haider Al-Rubaye for shaping and composing my thesis. It was a pleasure working with him and having a hands on experience with experiments while performing the setup for the Biogas production process. I express my gratitude to Dave Sextro and the entire team of Emerson, Chesterfield Office, St Louis, they helped and supported me throughout my internship with dynamic simulation.

I am grateful to my parents for their outstanding support and understanding, who have always stood by me in all my ups and lows. Dad who has always led me towards my success and my Mom who has imbibed the strength in me to pursue my dreams. I would like to mention my all-time buddies Shreyas and Aman who have always been positive throughout my journey towards my Graduation.

Last but not the least I would like to thank my closest pals Panky and Snehal without whom I would not have achieved what I had aspired for and my other friends in St Louis, making me feel home away from home.

## TABLE OF CONTENTS

	Page
PUBLICATION THESIS OPTION.....	iii
ABSTRACT.....	iv
ACKNOWLEDGMENTS .....	v
LIST OF ILLUSTRATIONS.....	viii
LIST OF TABLES .....	x
NOMENCLATURE .....	xi
 SECTION	
1. INTRODUCTION.....	1
 PAPER	
I.    EFFECT OF VARIATION OF PARAMETERS ON BIOGAS PRODUCTION USING ASPEN PLUS AND DYNAMIC SIMULATION MODEL USING MIMIC.....	3
ABSTRACT.....	3
1. INTRODUCTION.....	4
2. EXPERIMENTAL SETUP AND PROCEDURE.....	7
3. CHARACTERIZATION OF WASTEWATER FROM BREWERY.....	12
4. VALIDATION.....	13
5. RESULTS AND DISCUSSION.....	15
6. EFFECT OF DIFFERENT PARAMETERS ON MODEL.....	25
6.1. EFFECT OF TEMPERATURE.....	25
6.2. EFFECT OF OLR.....	27

6.3. EFFECT OF H <sub>2</sub> ADDITION/pH VALUE.....	28
6.4. EFFECT OF RECYCLE RATIOS.....	30
7. DYNAMIC SIMULATION USING MIMIC MODEL FOR ANAEROBIC DIGESTION.....	31
8. EXECUTION.....	32
REFERENCES.....	35
SECTION	
2. CONCLUSION.....	37
VITA.....	38



## LIST OF ILLUSTRATIONS

Paper I	Page
Figure 1. Anaerobic Digestion Degradation Process Flow.....	6
Figure 2. Process and Instrumentation Diagram.....	7
Figure 3. Two-Stages Expanded Granular Sludge Bed Reactor System.....	8
Figure 4. Validation of Process Model.....	15
Figure 5. Aspen Model.....	16
Figure 6. Experimental Observation in the Variation of Methane Composition for Different OLRs at Different Recirculation Rates .....	20
Figure 7. Experimental Observation in COD Removal Efficiency for Different OLRs at Different Recirculation Rates.....	21
Figure 8. Experimental Observation in Biogas Production Rate for Different OLRs at Different Recirculation Rates.....	22
Figure 9. Experimental Observation in COD from Pre-Acidification for Different OLRs at Different Recirculation Rates.....	22
Figure 10. Experimental Observation for Effluent COD Variation for Different OLRs at Different Recirculation Rates.....	23
Figure 11. Experimental Observation in the Variation in pH to Check Alkalinity of Effluent for Different OLRs at Different Recirculation Rates .....	24
Figure 12. Variations of Volatile Fatty Acids of Influent, PA, & Effluent for Different OLRs at Different Recirculation Rates.....	25
Figure 13. Growth Rate of Methanogens.....	26
Figure 14. Sensitivity Analysis at Thermophilic Temperature.....	26
Figure 15. Biogas Production for Different OLRs.....	27
Figure 16. Sensitivity Analysis at Mesophilic Temperature in Terms of Production Rate.....	28
Figure 17. Sensitivity Analysis at Mesophilic Temperature in Terms of kmol/hr.....	29

Figure 18. Sensitivity Analysis at Mesophilic Temperature to Study the Effect of the Recycle Ratios.....	30
Figure 19. Dynamic Model Using Mimic 3.7.2 for Anaerobic Digestion Process.....	33
Figure 20. Landing Model for R-01.....	33

**LIST OF TABLES**

Paper I	Page
Table 1. Composition of the Nutrient Medium. ....	10
Table 2. Characterization of Wastewater Sample.....	12
Table 3. Experimental Observation for Respective Recirculation Rates for each Organic Loading Rate and Hydraulic Retention Rate.....	18
Table 4. Characterization of Effluent for Various Recirculation Rates.....	19
Table 5. Characteristics of Granular Biomass.....	19

**NOMENCLATURE**

Symbol	Description
Mm	Millimeter
COD	Chemical Oxygen Demand
VFA	Volatile Fatty Acids
°C	Degree Celsius
°F	Degree Farenhite
Gal	Gallons
G	Gram
L	Liter
Mg	Milligram
ml	Milliliter
CH <sub>3</sub> COOH	Acetic acid
N	Nitrogen
CaCO <sub>3</sub>	Calcium carbonate
CSTR	Continuous Stirred tank reactor
MOC	Material of Construction
NH <sub>3</sub> -N	Ammonia
OLR	Organic Loading Rate
HRT	Hydraulic Retention Time

## **SECTION**

### **1. INTRODUCTION**

Biomass is becoming one of the promising renewable energy alternatives for the future. The growing application of anaerobic digestion for the treatment of the generated organic waste are much common today. In spite of the anaerobic digestion technique has been known for years, there were some doubts regarding its application basically of the complexity of microbial and physicochemical reaction. Hence, there was lot of work which was needed to understand the anaerobic digestion mechanisms which can provide stability and can enhance the performance of the process with better efficiency of the biogas plants operation.

The stability of the processes and its velocity are highly influenced by the composition of the feedstock and also by the supply of the microbial community with essential elements. Consequently, effective feedstock combination requires an ability to predict the consequences, whenever the new substrate is entered into the system. Dynamic Modelling and simulation provide an appropriate analytical alternative to study and improve the biogas generation process and also reduces the higher expenditure of cost and money involved in the laboratory experiments.

All the biogas production models contain various unknown parameters and complex structure which makes the input parameterization step quite difficult, it also requires a lot of assumptions. In order to overcome this problem, in this study, a relatively simple model was formulated with the help of Dynamic Simulation. This model will help to identify the important processes and inputs which are important in Biogas production.

This thesis is presented as a paper describing the work related to the treatment of wastewater from brewery industries, the study of effects of variation of parameters in enhancing biogas production using expanded granular sludge bed reactor (EGSB) and creating a dynamic simulation model using Mimic.

## **PAPER**

### **I. EFFECT OF VARIATION OF PARAMETERS ON BIOGAS PRODUCTION USING ASPEN PLUS AND DYNAMIC SIMULATION MODEL USING MIMIC**

Shruti S. K., Haider Al-Rubaye, Manohar M. S., Joseph D. Smith, Ph.D.

Chemical and Biochemical Engineering Dept., Missouri University of Science and  
Technology, Rolla, MO, 65409, USA

#### **ABSTRACT**

Biomass is looked upon as one of the promising renewable energy alternatives for the future. The growing application of anaerobic digestion for the treatment of the generated organic waste are much of need today. In spite of the conventional methods for anaerobic digestion, there are still unexplained doubts regarding its application basically considering the complexity of microbial and physicochemical reaction. Using simulation with Aspen Plus model various factors have been studied under sensitivity analysis to make conclusions on what factors help enhance the methane production. Thus, an Aspen model has been used for examining various parameters using various feedstock.

Dynamic Modelling and simulation provide an appropriate analytical alternative to study and improve the biogas generation process and also reduces the higher expenditure of cost and money involved in the laboratory experiments.

Dynamic Simulation model has been simulated using Mimic software for operator training purposes and further study on real life dynamic processes.

Keywords: Dynamic simulation, Aspen Plus, Organic Loading rate, Sensitivity analysis

## 1. INTRODUCTION

It is necessary to pretreat the process wastewater from brewery industries before letting it into the outlets open to the environment because of its high COD content and solid content along with organic, inorganic content. Pre-treatment can be a cost intensive process to the brewing companies and burning fossil fuels can have adverse impacts on the environment leading to pollution [2], but remains one of the easiest and easily available forms of energy. Given the ever-growing demand for energy and population versus the production, most of these fossil fuels would continue to deplete [8][10]. To cope up with this crisis, renewable energy resources are making their way to generate energy. Biofuels happen to be such a reliable renewable energy source which is currently undergoing a lot of research and one of them is the generation of biofuels from waste [3]. Anaerobic digestion process helps treat the waste water from breweries , thus, helps to hinder pollution. However, the percentages are not very satisfactory and would a lot of research and development to replace the traditional and conventional sources[2][4].

Biogas is the biofuel obtained from anaerobic digestion process which is typically composed of 50-70% methane, 30–50% carbon dioxide, and about 1% nitrogen, hydrogen, and hydrogen sulfate [11]. The anaerobic digestion process is in the real sense a biological degradation, wherein the microbes feed on the organic compounds in wastewater thus, releasing methane which is the major component in the biogas. [2]. Biogas, thus, has a great potential for being a sustainable energy resource as well as inhibiting greenhouse emissions[4]. The byproducts from the anaerobic digestion process can be used for domestic purposes, electricity generation, etc. For these specific purposes a reactor has been designed, called the Expanded Granular Sludge Bed reactor (EGSB). This design has



been setup in the lab for experimental purposes, it allows the separation of the three phases – solid, liquid, gases. The main advantage of this design is the recycle stream to enhance the production of methane gas. The expansion bed creates sufficient interaction between biomass and substrates. For enriching the biogas even more, Zuo investigated the effect of two stage reactors and concluded that it helps in lowering the (Volatile fatty acids)VFAs. The main factors affecting the Biogas production are it's composition, temperature inside the reactor, retention time, working pressure inside the digester, fermentation medium (pH), Chemical Oxygen demand (COD), volatile fatty acids present in it. Zuo studied a few of these factors to enhance the methane production in the biogas stream. To increase the methane production rate, Zuo experimented on the recirculation rates to investigate it's effects on the biogas stream[5]. The study proved that the recirculation rate when increased by 0.6 the methane concentration was enhanced and the biogas produced showed positive conversions and COD content plummeted to a satisfactory extent. The overall increase in the biogas yield from 0.5 L/g to 0.66 L/g by changing the recirculation rate from 0 to 1.4 concluded that the recirculation rate helps increase the production of biogas [6]. In the acidogenic step, one of the four steps of conversion to biogas, the transfer to methane gas was favored, thus, enhancing the methane composition [7].

Aspen Plus model to study various different aspects and effects of different parameters on biogas production have been studied. Al-Rubaye experimented with the different substrates with varying HRTs, temperature, and pressure of the system [3][9]. The anaerobic digestion process consists of four main steps: hydrolysis, acidogenesis, acetogenesis, and methanogenesis, as shown in Figure 1.

Hydrolysis is the first step where the conversion starts. In this step the addition of water breaks the chemical bonds between the large polymers (carbohydrates, proteins, and fats) to smaller molecules – monomers such as sugar, amino acids, and fatty acids. . The addition of water promotes the interaction of the cations and anions of the water in turn breaking their bonds as pH varies.

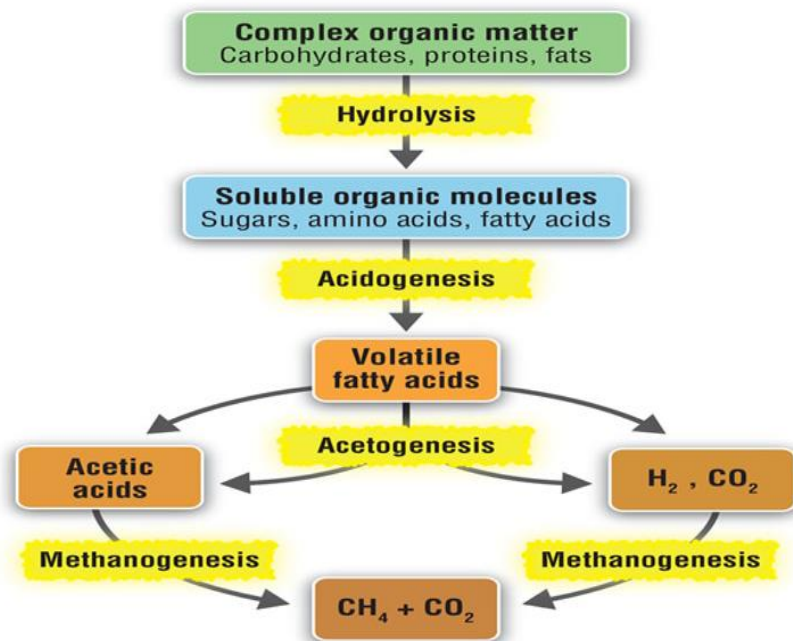

Figure 1. Anaerobic Digestion Degradation Process Flow

This primary step is initiated by extracellular enzymes. The second step is the Acidogenesis step in the conversion process. In this process, the microbes called the acidogens convert the simple monomers into volatile fatty acids, ketones, alcohols, carbon dioxide, and hydrogen. The third step is Acetogenesis in which the acetogens convert volatile acid groups into acetic acid, carbon dioxide, and hydrogen. These three bacteria

groups produce acetic acid: clostridium aceticum, acetobacter woodii, and clostridium termoautotrophicum. Other bacteria groups- homoacetogens, syntrophes, and sulphoreductors produce additional hydrogen and carbon dioxide. Final step is Methanogenesis carried by the group of methanogens which initiate the biological reaction to form methane and carbon dioxide from acetic acid, carbon dioxide, and hydrogen with the help of anaerobic methanogens bacterium groups.

## 2. EXPERIMENTAL SETUP AND PROCEDURE

Aspen model has been simulated for the experimental setup shown in the following figure. Process and Instrumentation Diagram for the same setup is shown in Figure 2. Two stage system was set-up for the anaerobic digestion as shown in Figure 3.

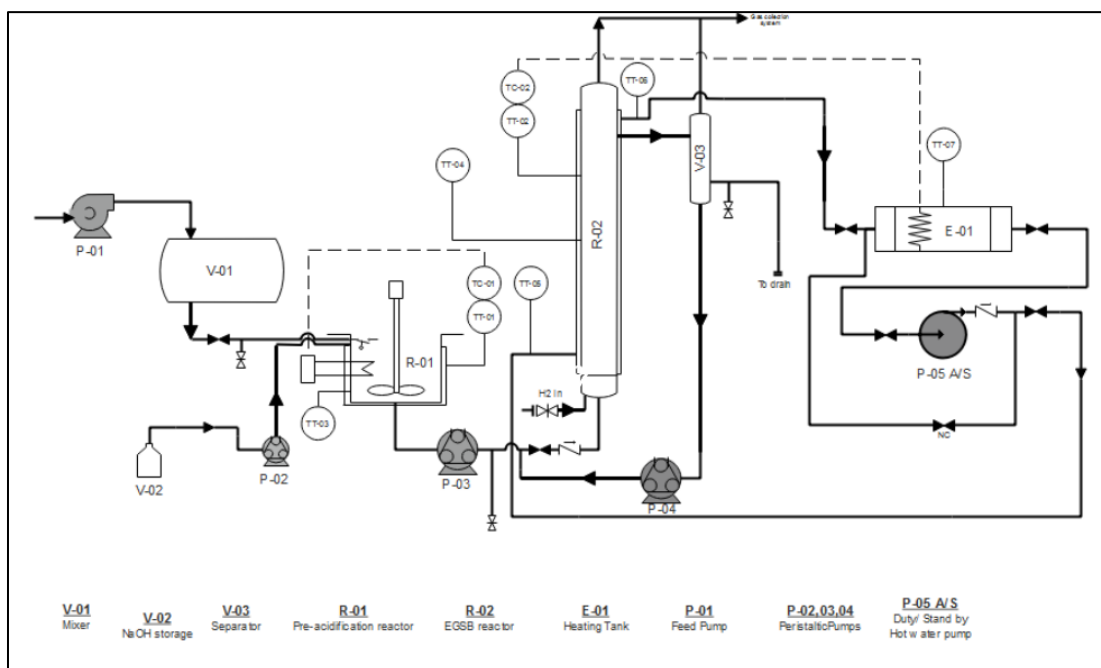

Figure 2. Process and Instrumentation Diagram

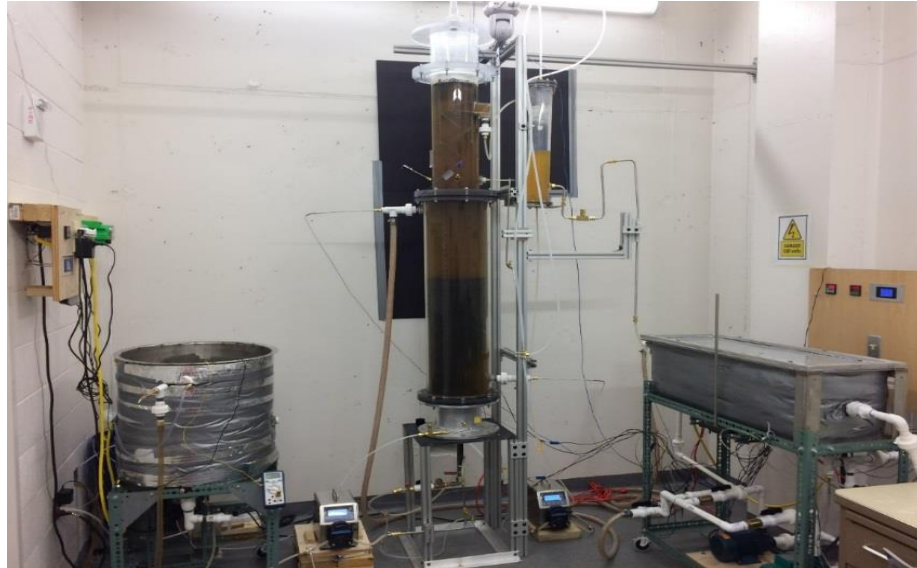

Figure 3. Two-Stages Expanded Granular Sludge Bed Reactor System

The Aspen model shows the flow chart of the progress of the anaerobic digestion process. The main units of the anaerobic digestion process have been modeled as shown in the Aspen model - process wastewater storage unit, pre-acidification (PA) reactor unit which consists of a CSTR unit, and hot water system. The pre-acidification section is where the two steps of the anaerobic digestion – Hydrolysis and Acidogenesis takes place.

In the storage unit of the system, 55 gal plastic tank V-01 with an horizontal orientation has been setup for the storage of the wastewater from Square One Brewery. In the storage section, the wastewater had been diluted in a ratio of 1:6. These sections and experiments were conducted at the department of material research center and chemistry of Missouri University of Science and Technology. The experimented and studied and have been conducted and followed as per the standard procedures provided by the United States Geological Survey and United States Department of Environmental Protection.

Next unit is the Pre-acidification unit wherein, the feed stored in the storage unit is let into the pre-acidification reactor R-01 with a capacity of 33 gal. MOC for this reactor tank is Stainless Steel with an agitator. For the efficiency of the process, Temperature is a key factor to be maintained so as for a stability in the process. To keep process stable, the reactor must operate in the range of 34°C–35°C. TC-01 is the Temperature controller to set the temperature in the specified range. pH meter controls and maintains the pH in the 7-8. The conversion from polymers to monomers is initiated due to a pH change. To maintain the expected pH by adding a sodium hydroxide (NaOH). NaOH solution is added with feed in V-02.

The pH change in the PA reactor launches the hydrolysis step of the process where large polymer chain molecules will break down to small monomers. The pH was maintained by adding a sodium hydroxide (NaOH) solution stored in a V-02 container using Milwaukee MC122 pH meter with peristaltic pump P-02 to achieve the pH range of 4.5–5.0 during the operation. Peristaltic pumps P-02 were used for this purpose. Also, for the pH stability of the system sodium bicarbonate ( $\text{NaHCO}_3$ ) can also be added manually. In the further step, further monomers are broken down into volatile fatty acids.

TT-03 thermocouple helps monitor the temperature across 7 main spots in the setup. Thermocouples TT-04, TT-05, TT-06 and TT-07 have been inserted at these points, which can be monitored thus maintaining the temperature of the system. At this stage, the volatile fatty acids content in the wastewater gets converted to amino acids, carbon dioxide and Hydrogen. This Hydrogen has been captured using the vacuum pumps P-05 A/S into a tank. The effects of recycling hydrogen back into the system has been studied later. The volatile fatty acids and acetic acids which were unreacted, are pumped back to the EGSB

reactor. The EGSB reactor performance shows variation with different recycle ratios when studied later. Using P-03 variable frequency drive peristaltic pumps (Model no. BT100S) from Golander, the unreacted stream is recycled to the EGSB reactor R-02. On the basis of different organic loading rates (OLR) - OLR 2 gCOD/L/day, 4 g COD/L/day and 6 g COD/L/day the effects can be investigated . Here, OLR 2 gCOD/L/day, 4 g COD/L/day and 6 g COD/L/day were investigated. The nutrient medium contains mineral bases, nutrient base and a buffer base required for the process as shown in Table 1[22].

Table 1. Composition of the Nutrient Medium

	Component	Amount of Component (mg/mL)
Mineral Base I	Cobalt (Co)	0.062
	Iron (Fe)	1.126
	Manganese (Mn)	0.0139
	Boron (B)	0.0044
	Zinc (Zn)	0.0119
	Molybdenum (Mo)	0.0020
	Nickel (Ni)	0.0062
	Selenium (Se)	0.0104
	Copper (Cu)	0.0026
	Mineral Base II	Calcium (Ca)
Magnesium (Mg)		2.36
Nutrient Base	Nitrogen (N)	13.9
	Phosphorus (P)	11.4
	Sulphur (S)	6.76
Buffer Base	Sodium Bicarbonate (NaHCO <sub>3</sub> )	40

The expanded granular sludge bed reactor was divided into three sections- lower part – aluminum plenum with nozzles for gas and liquid injections. Length of the reactor is about 63in, diameter is 7.5in and the working volume is 12 gal. For gas injection, a gas sparger has been installed and a T shaped distributor (171 holes, 2mm in diameter) has been installed for liquid injection. E-01 is used as a heating medium to maintain the temperature inside the jacket of the reactor which is made up of acrylic material. The temperature inside this jacket is also maintained using TC-02, Temperature controller which has a sensor plugged into it. Thermocouples TT-04, TT-05 and TT-06 have been inserted into the main spots of the reactor which can be monitored using Pico TC-08 data logger system. The biomass is charged in this lower section of the reactor to ensure efficient mixing of the waste water and the biomass. This design of EGSB reactor promotes the production of biogas. The upper section of this reactor is especially designed for ease of separation of the three phases- gas, liquid and solid biomass. Further the biogas is collected into a glass tank V-03 as shown in Figure 2. From this section the gas is let into another container where it displaces water pre-filled in the pre-calibrated tank which is equal to the amount of gas collected. The effluent from the tank V-03 is let into sewage, a part of which is recycled back to the reactor R-02. The last section is the hot water system wherein the heating tank with a capacity of 23 gal is used to maintain the temperature of the reactor R-02. A direct heating element and TT-07 have been installed inside the heating tank and is connected to the main reactor controller TC-02 to control the temperature of water, used as the heating medium. This hot water is circulated using the centrifugal pumps P-05 A/S, with one working at a time for every 30 minutes.

### 3. CHARACTERIZATION OF WASTEWATER FROM BREWERY

The summary of the analysis obtained from the waste water sample collected from Square One Brewery is shown in Table 2.

The sample was tested for total solids (TS), total volatile solid (TVS), total suspended solid (TSS), and total dissolved solids (TDS) content as per the procedures set by U. S. Geological Survey.

The sample collected from this brewery has a COD content of about 90 g COD/L, before dilution. For further analysis this sample was diluted to 20 g COD/L. Samples were also consistently collected from pre-acidification reactor and the main reactor. All these samples were collectively tested for it's COD, VFA, phosphate, sulphate, total ammonia, total nitrogen content. At the same time these samples were also analyzed for their pH and alkalinity [22].

Table 2. Characterization of Wastewater Sample

Characterization of wastewater sample	
VSS (mg/L)	23
TSS (mg/L)	1,542.0
TDS (mg/L)	80,266.0
pH	3-4

The equipment's used for the analysis were - spectrometer from HACH (Model no. DR3900) and reagents provided by HACH (TNT vails: 872, 823, 845, 865, 870, 833, and 828).



#### 4. VALIDATION

Kaparaju et al. investigate a few examples to optimize the processes of anaerobic digestion. He studied and created a simulation model to study the effect of serial digesters for the two stage anaerobic digestion, for which he noted an increase in the yield by about 10% [12]. Later, an in-depth study of various factors was focused on- hydraulic retention time for the expanded granular sludge bed reactor[13],[14]. The biogas production rate was reported to increase by 33-42% and 22-32% respectively when the respective HRT were increased from five to six times at a fixed OLR. Also, experimentally the effect of addition of Hydrogen back to the system was studied and proven to improve the yield by 33.42 % with no change in the COD removal efficiency[1].

There are numerous models that depict the anaerobic absorption energy. Some of these models center around the hindrances of the procedure [15] while another model will portray the AD procedure [17]. The anaerobic processing model no.1 (ADM1) is viewed as the most imperative model for the AD, which assumes that the substrate acquainted with the framework as a bolster will comprise of starches, proteins, and fats. Essentially, this model comprises of two sorts of responses: the biochemical responses and physico-substance responses. For the principal compose, the chemicals, regardless of whether intracellular or extracellular, will be the impetus. A crumbling step will be incorporated into this model, which just changes over the biomass into latent starches, proteins, and lipids by breaking the concoction structure of the biomass, which will influence the biogas creation rate. This progression and the hydrolysis step are controlled by the extracellular compounds.

Approving any proposed mimicked demonstrate is basic for making it broadly relevant. This should be possible by looking at the outcomes reproduced from the model with comes about created from exploratory setups that are working under comparative conditions. In this paper, comes about created from the model had been contrasted and genuine exploratory information keeping in mind the end goal to check the legitimacy of the model, three cases have been utilized as a part of this approval.

The model recreated two reactors, stoichiometric reactor utilized for the responses from the hydrolysis stage and ceaselessly mixed tank reactor (CSTR) for acidogenic, acetogenic and methanogenic stages. For approval, the three encourage cases (according to individual literary works) considered were- Case-1-dairy cattle excrement, structure of the fertilizer was taken from [Budiyono], Case-2 - bovine compost from Snertinge biogas plant, Germany according to Kaparaju [12], Case-3-wastewater produced from mechanical and agrarian exercises as indicated by Mahyar [2]. The undertaking is to apply the comparative conditions for each case and contrast them and the outcomes acquired from the trial information.

For Case-I, bovine fertilizer has been utilized as nourish which is dominantly, fiber (lignin, cellulose and hemicellulose) [Budiyono]. According to considers exhibited by Karthik [16], this excrement was utilized as substrate with a stacking rate of 0.33L/day at water driven maintenance time (HRT) of 15 days. As per this examination, 49.89% of methane was created, ascertained per gram dairy cattle fertilizer which falls in extend with recreated aftereffect of 46.25%. In Case-2, to upgrade biogas generation, Kaparaju exhibited the examination of one-advance CSTR with that of the two stage framework with two methanogenic reactors associated in arrangement[12]. Results demonstrates that serial

absorption, with consolidated working volume of 5L and 15 days HRT, could enhance change proficiency. As indicated by the model, CH<sub>4</sub> % was 62.52 and from the serial processing of the two reactors at thermophilic extend (55°C), CH<sub>4</sub> % was 68.36. As indicated by Case-3, CH<sub>4</sub> % of 70.7 was gotten at 3.0 g COD/L.day by seeding 60 L anaerobic expanded granular sludge bed (EGSB) with 45 L of dynamic biomass (no weakening). From the Aspen Plus model, recreations revealed CH<sub>4</sub> % incentive to be 59.51. These cases portraying their deviations from test and mimicked comes about have been appeared in Figure 4.

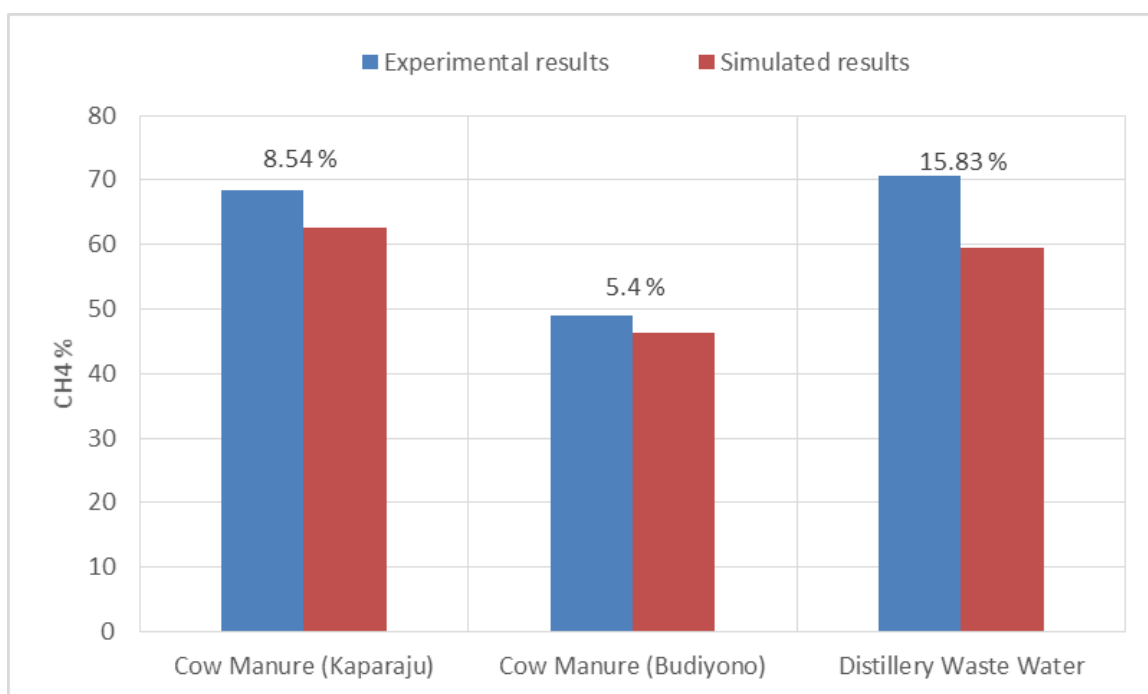

Figure 4. Validation of Process Model

## 5. RESULTS AND DISCUSSION

The sample was diluted from 90 g COD/L was diluted to 20 g COD/L and then stored in a tank for a few hours. To monitor the stability of the system, a sample was tested

from pre-acidification reactor to check the alkalinity and the COD content before it's fed into the reactor R-01. Once fed into the system, the wastewater has been treated with NaOH solution to maintain the pH below 5.0, temperature range to be mesophilic range - 35°C. Organic loading rate was varied from from 2 g COD/L/day, 4 g COD/L/day, and 6 g COD/L/day to check the behavior of the system. Also, for experimental purposes recycle ratios were increased from 20%, 30%, and 40% of OLR were recirculated) to study the variable effects of COD, VFA, and biogas production rate and methane composition.

Aspen Plus was model was designed to study the effects of various parameters on biogas production, shown in Figure 5.

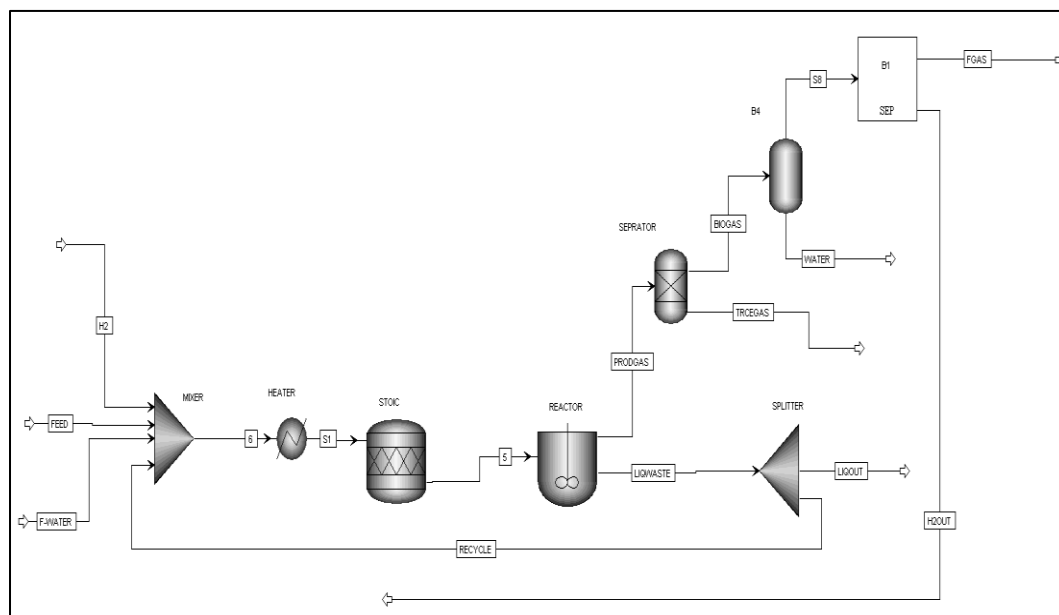

Figure 5. Aspen Model

The effluent from the central power source was broken down and found to contain a lot of COD and VFA alongside methanogenic bacterium gathering. A distribution explore was directed to enhance these issues. The methane synthesis was enhanced to 73.24%.

The Figure 6 demonstrates the variety of methane creation rate amid various OLRs and distinctive distribution rates. It demonstrates that the lower the OLR the higher the synthesis of methane in biogas, and it likewise demonstrates that the most astounding distribution prompts a high level of methane in the gas stream (i.e., 40% distribution rate at OLR 2 g COD/L/day has the greatest methane level of 73.2%).

The COD removal efficiency was enhanced to 96.84%, Figure 7 demonstrates the COD removal efficiency for various OLR ranges at various distribution rates. The experimental results show that higher that the distribution rate brings down the proficiency of COD removal efficiency (i.e., the 20% distribution at OLR 2 g COD/L/day has the greatest COD expulsion limit). The biogas generation rate was observed to be 19.45 gal/day [22]. The samples were collected from reactor R-01, reactor was analyzed to study the variation of various parameters such as COD, VFAs to study the variable effects of COD, VFA, and biogas production rate and methane composition. The three samples were taken for influent when the feed is charged, pre-acidification stage, effluent once the biogas is produced. VFA acts as an inhibitor to the process and the value reduces only after it gets treated in the reactor. EGSB reactors are designed to take heavy loads. The intricate design of these reactors allows superficial mixing of the two phases. Hence, this design has been preferred over the others. Table 3 shows these variations when the sample was tested for different HRTs against different OLRs, when charged to the reactor.

Table 3. Experimental Observation for Respective Recirculation Rates for each Organic Loading Rate and Hydraulic Retention Rates

No.	(OLR)	HRT , Day	Recycle , %	COD Influent , mg COD/L	COD pre- acidification , mg COD/L	COD Effluent , mg COD/L	VFA Influent, mg CH <sub>3</sub> CO	VFA Pre- acidification , mg	VFA Effluent, mg CH <sub>3</sub> COOH/ L
1	2	10	20	20,000.00	15575.67	631.67	2493.34	4112.34	146.67
2			30		13103.67	647.34	2508.67	3030.67	151.67
3			40		15234.00	776.00	2186.00	4057.67	150.67
4	4	5	20		14416.00	709.34	2373.34	4024.00	162.67
5			30		15557.34	955.34	3057	5044.00	204.67
6			40		15162.67	1134.3	2340	4227.34	174.00
7	6	3.34	20		14767.67	1292.3	2466.34	3680.00	290.67
8			30		15360.00	1213.3	2941.34	4950.34	223.67
9			40		15001.34	1375.0	2547.67	3543.34	198.66

Table 4 shows the analysis only for the effluent obtained for various recirculation rates. The effluent sample must fall under standard according to the norms so that the effluent can be discharged into the outlets. This process is the pretreatment before the sample is discharged. The effluent is analyzed for its total nitrogen content, total alkalinity and total ammonia content, sulfate and phosphorus content, this data has been data has been recorded as shown in Table 4.

Table 4. Characterization of Effluent for Various Recirculation Rates

No.	(OLR)	Recycle, %	Total Nitrogen, N mg/L	Total Alkalinity, CaCO <sub>3</sub> mg/L	Phosphorous, PO <sub>4</sub> <sup>3-</sup> mg/L	Sulfate, SO <sub>4</sub> <sup>2-</sup> mg/L	Total Ammonia, NH <sub>3</sub> -N mg/L	Phenol, mg/L
1	2	20	125.00	1350.33	214.00	87.56	187.00	4.63
2		30	62.33	1430.33	242.00	82.96	233.66	-
3		40	57.03	1356.67	227.00	93.60	163.00	4.83
4	4	20	66.53	1071.00	239.00	93.93	182.66	4.86
5		30	52.96	1316.00	302.00	99.06	232.33	-
6		40	53.06	716.34	245.00	105.67	110	6.37
7	6	20	32.50	1025.34	269.00	108.00	133.00	11.10
8		30	64.23	960.00	279.34	118.00	185.34	-
9		40	28.76	981.00	265.34	104.34	205.00	10.36

Table 5. Characteristics of Granular Biomass

Characterization of Granular Biomass	
VSS (mg/L)	60,914.66
TSS (mg/L)	422
TDS (mg/L)	5832
Particle size (mm)	2-5
pH	6.9-7.2

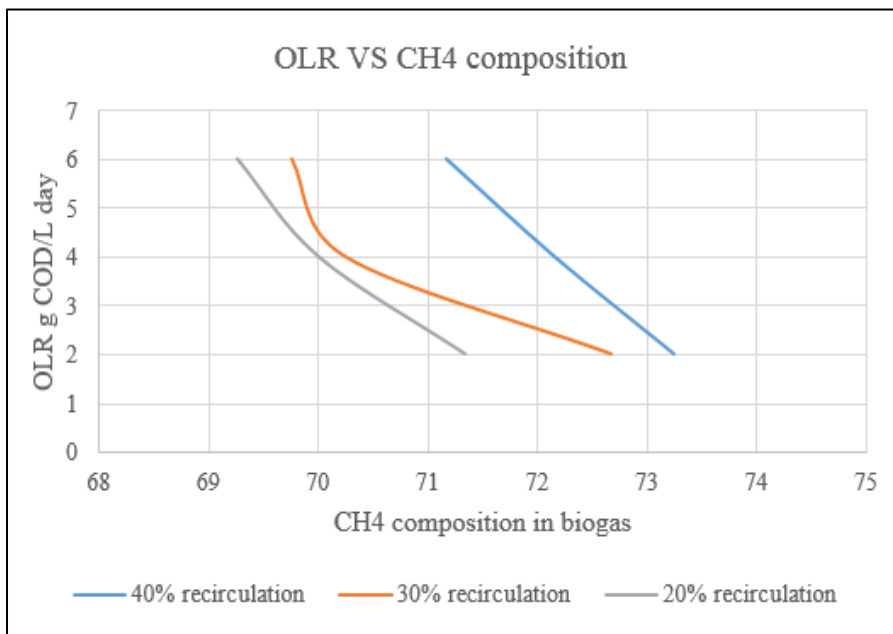

Figure 6. Experimental Observation in the Variation of Methane Composition for Different OLRs at Different Recirculation Rates

The EGSB reactor uses biomass as the source of energy. Biomass being the most researched upon, renewable source of energy has been experimented in this project. This biomass feeds on the feed charged to the reactor, which in this case is the wastewater from the brewery. The characteristics of this biomass have been listed in Table 5, pH being the most important characteristic. Hence, this process is a temperature and a pH sensitive process.

Figure 8 demonstrates the biogas creation rate for various OLRs at various distribution rates. The biogas generation increments with an expansion in OLR and an increment in the distribution rate. The most elevated distribution rate was 40%, however the greatest biogas creation rate appears for 30% in light of the fact that the reactor was upset during the process.



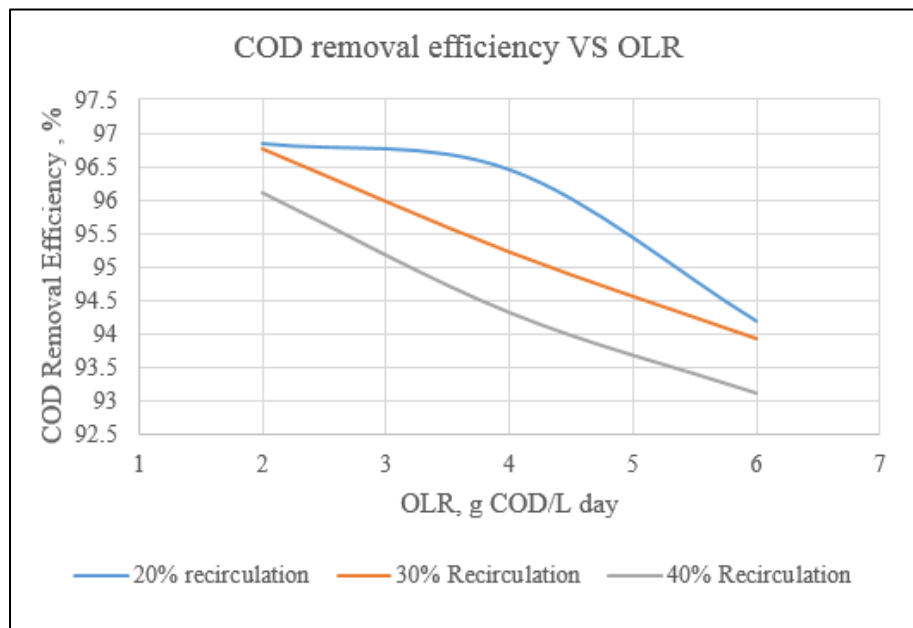

Figure 7. Experimental Observation in COD Removal Efficiency for Different OLRs at Different Recirculation Rates

Figure 9 and Figure 10 demonstrates the various situations led for COD investigation. The pre- acidification COD remains relatively steady amid ORLs values extending between 14000 g COD/L to 15600 g COD/L. The COD for the effluent stream shows huge outcomes (i.e., it has diminished from 20000 g COD/L to 631.66 g COD/L). The pH and alkalinity for the effluent streams at various OLRs and diverse distribution rates were studied [22]. These experimental observations have been verified with the validated Aspen model and these results have been compared. COD removal efficiency is comparatively high in EGSB reactors, a reason why these designs can take heavy loads. There can be reactor upset conditions if the reactor is been overfed, in this case the reactor needs resettling time to obtain the normal conditions, else the COD concentration in the effluent goes beyond the expected range.

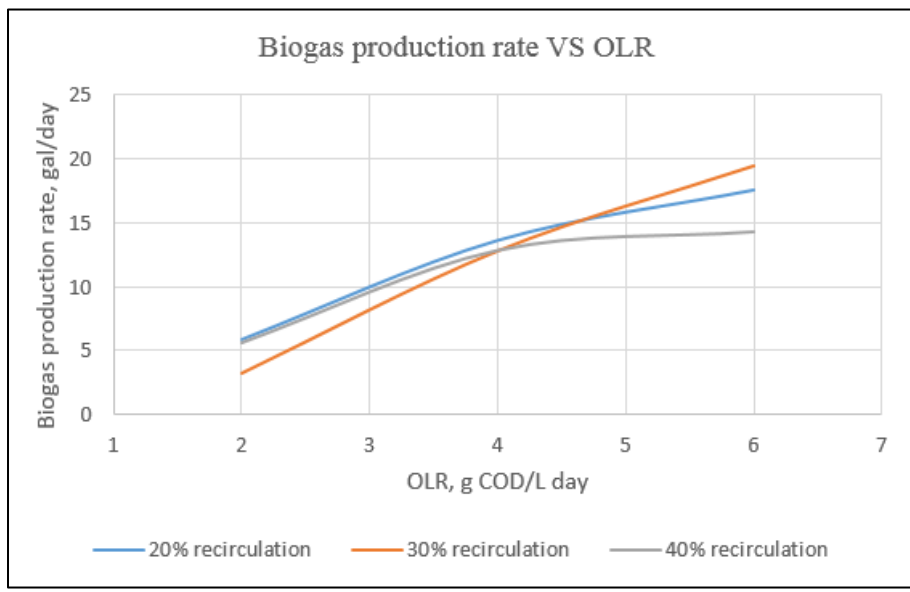

Figure 8. Experimental Observation in Biogas Production Rate for Different OLRs at Different Recirculation Rates

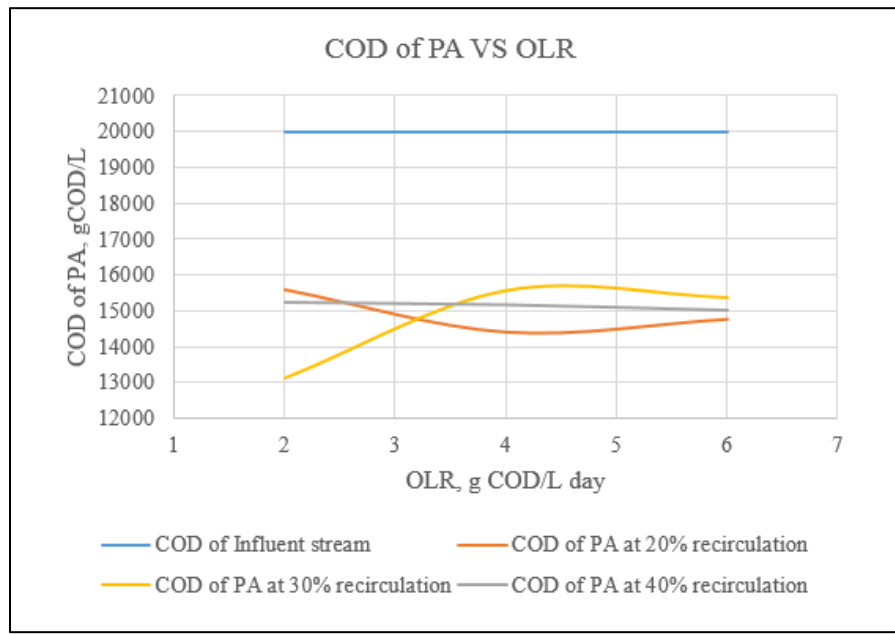

Figure 9. Experimental Observation in COD from Pre-Acidification for Different OLRs at Different Recirculation Rates

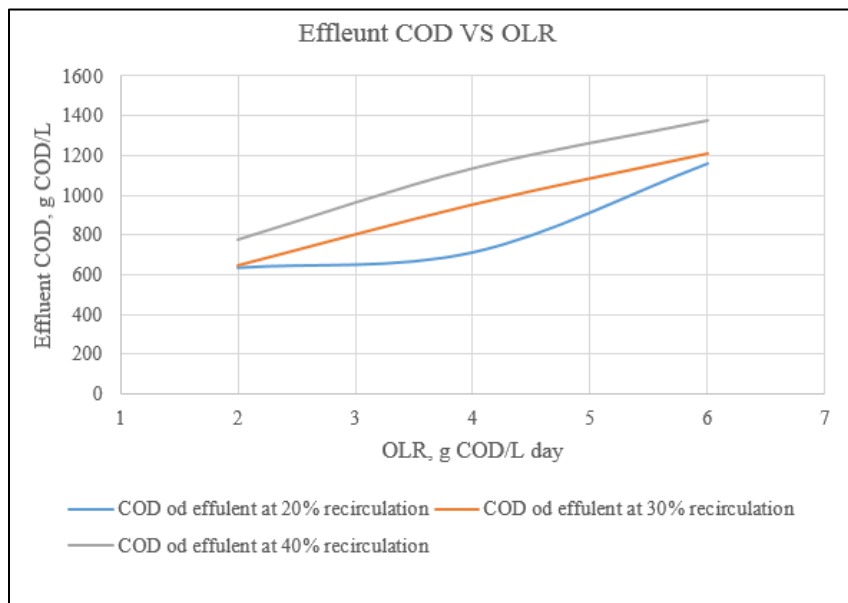

Figure 10. Experimental Observation for Effluent COD Variation for Different OLRs at Different Recirculation Rates

Figure 11 demonstrates the estimations of pH and alkalinity remains relatively stable. Aside from OLR 6 g COD/L/day at 40% distribution esteem, the alkalinity for this was bring down on account of hindrance to the reactor, where it suppressed the action of the procedure.

Unstable unsaturated fats at various phases of the procedure were inspected, as appeared in Figure 12[22]. The examples were taken from the influent stream after pre-acidification and the effluent stream for various OLRs at various distribution rates. The estimations of the VFA from the influent for various cases are comparable, a similar case with VFA of all the PA values, VFA demonstrate great outcomes indicating that all the VFA was consumed in the main reactor (i.e., VFA from 5044 g CH<sub>3</sub>COOH/L diminished to 146.66 g CH<sub>3</sub>COOH/L).

The examples were taken from the influent stream after pre-acidification and the effluent stream for various OLRs at various distribution rates. The estimations of the VFA from the influent for various cases are comparable, a similar case with VFA of all the PA esteems, the emanating VFA indicate great outcomes, and all the VFA was devoured in the primary power source (i.e., VFA from 5044 g CH<sub>3</sub>COOH/L diminished to 146.66 g CH<sub>3</sub>COOH/L).

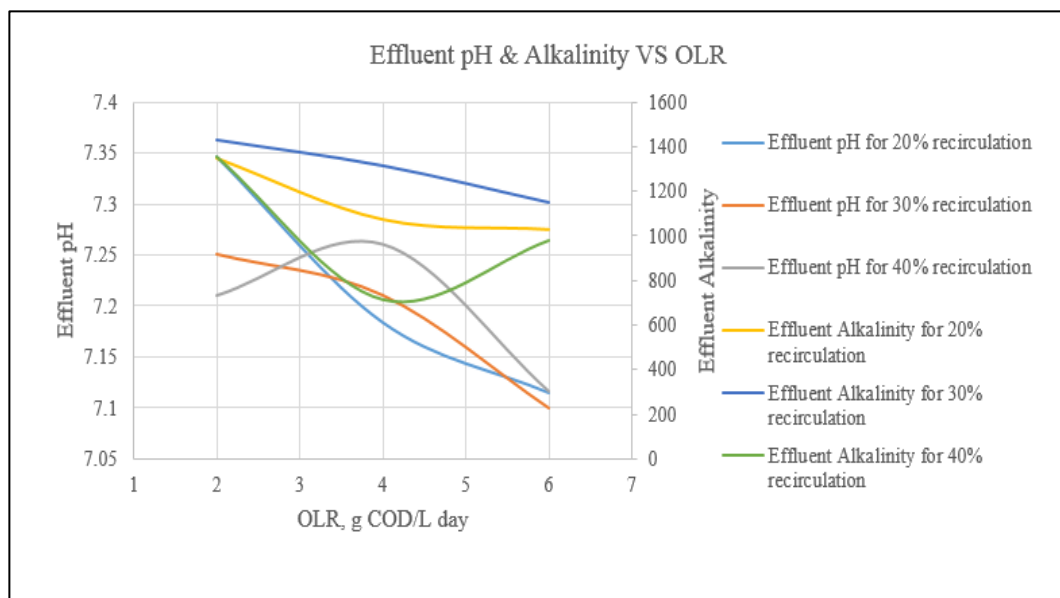

Figure 11. Experimental Observation in the Variation in pH to Check Alkalinity of Effluent for Different OLRs at Different Recirculation Rates

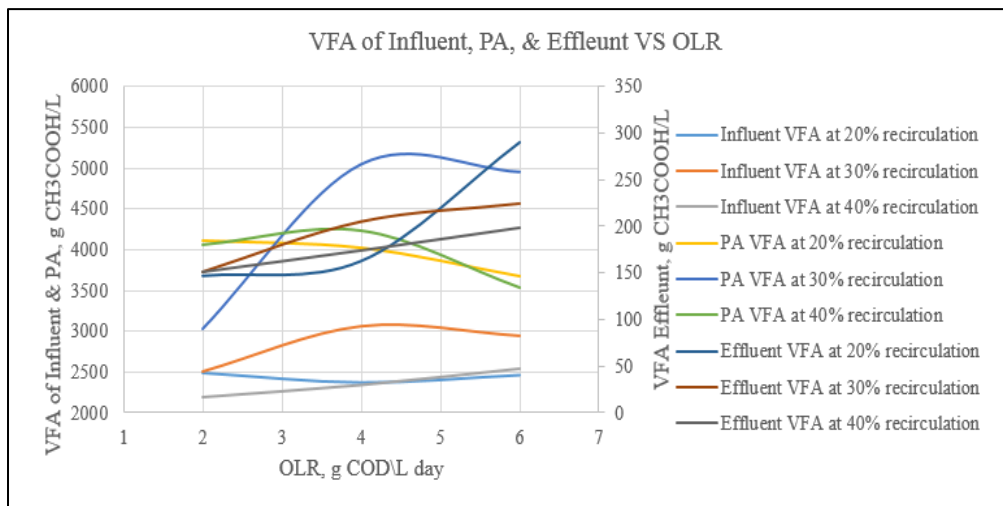

Figure 12. Variations of Volatile Fatty Acids of Influent, PA, & Effluent for Different OLRs at Different Recirculation Rates

## 6. EFFECT OF DIFFERENT PARAMETERS ON MODEL

### 6.1. EFFECT OF TEMPERATURE

Temperature plays an important role in the whole process of anaerobic digestion process. It doesn't only affect the quality but also have a significant impact on the quantity of biogas production. The temperature ranges for the anaerobic digestion can be as Cryophilic (below 35°C), Mesophilic (35 to 55°C) and the Thermophilic (above 55°C) ranges. The behavior of the system can be as shown in the Figure 13.

Out of all the three stages, it was observed that biogas production at thermophilic temperature was highest. These bacteria were most active in the range between 50-60°C but the Aspen Plus model suggests that Thermophilic range is not very feasible. The anaerobic digestion is favored by Thermophilic range more than that by Mesophilic range. This is a similar behavior shown by the Aspen model.

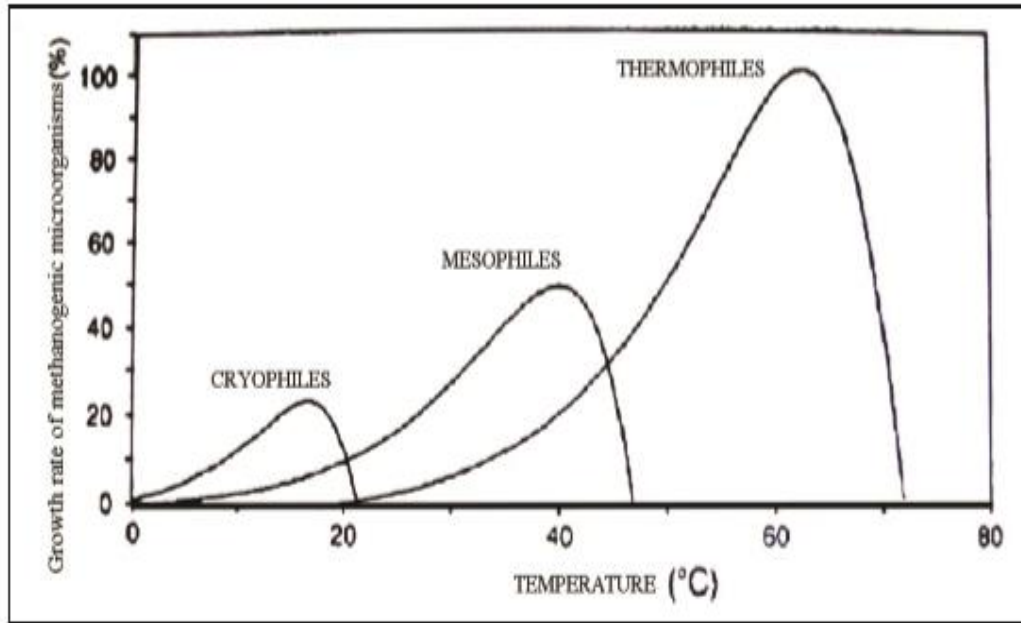

Figure 13. Growth Rate of Methanogens

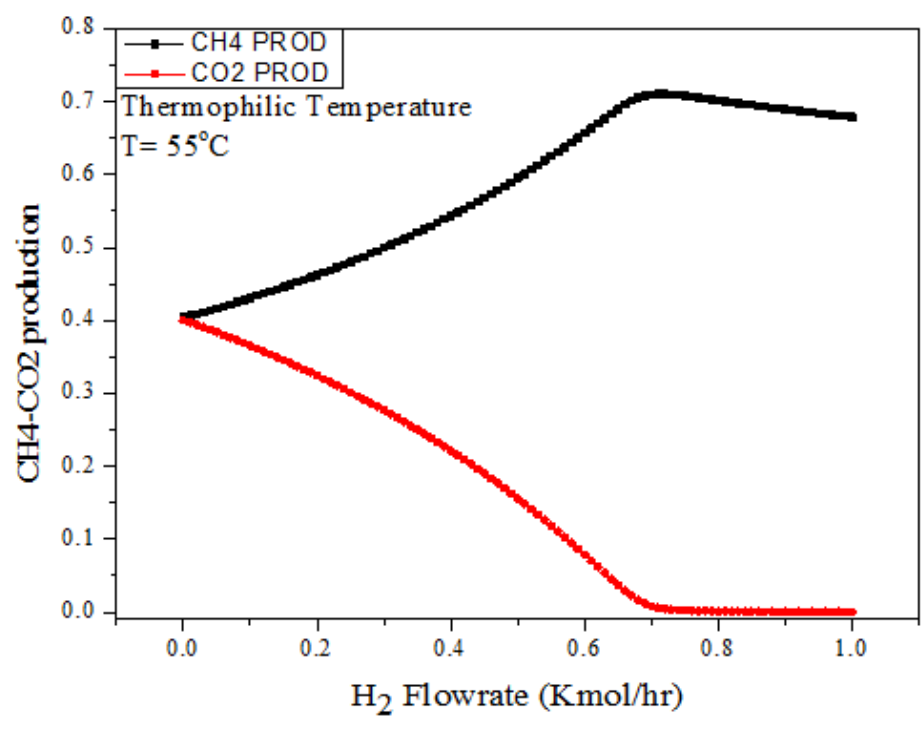

Figure 14. Sensitivity Analysis at Thermophilic Temperature

However, as shown in the Figure 14, the choice between the thermophilic and mesophilic temperature range is decided mainly by natural climatic conditions under which the plant is operating. But it is possible to create the required conditions for thermophilic fermentation with the help of an external heat, which is normally expensive. As per the graph, the injection of  $H_2$  also causes a few reactions in initial phase, phase before acetogenesis, acidogenesis to take place again resulting in more  $CO_2$  being produced against methane production. This can also be prove using reaction sets in sensitivity analysis in Aspen model.

## 6.2. EFFECT OF OLR

OLR basically defines the biological conversion capacity of any anaerobic digestion system. Hence, it is very important to set the OLR at the optimum level to achieve maximum efficiency as shown in the Figure 15.

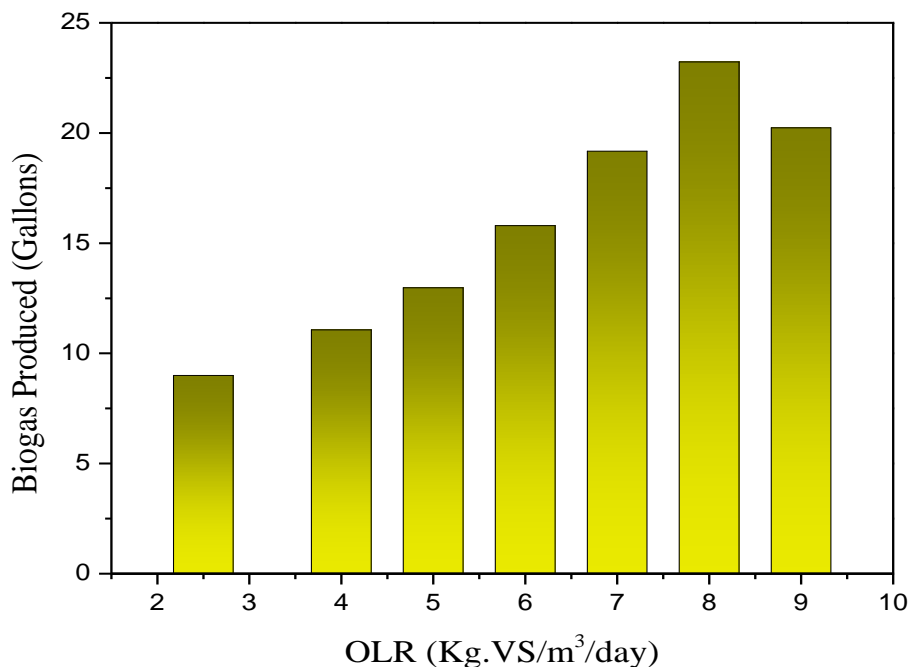

Figure 15. Biogas Production for Different OLRs

It can be concluded from the graph above, that, if the OLR is kept low, the anaerobic digester will be running inefficiently; on other hand, if we keep OLR high, there is a risk of system failure due to capacity overloading.

### 6.3. EFFECT OF H<sub>2</sub> ADDITION/pH VALUE

To achieve an optimum biogas production, it had been mainly observed that the pH value of the mixture in the digester system should vary between 6.25 to 7.50. This is because, in anaerobic digestion process, microorganism requires a natural or mildly alkaline environment to produce efficient gas.

It was observed that the Methanogenic type of bacteria are quite sensitive to pH value and they are more active at pH level of 6.5 at mesophilic temperature as shown in the Figure 16.

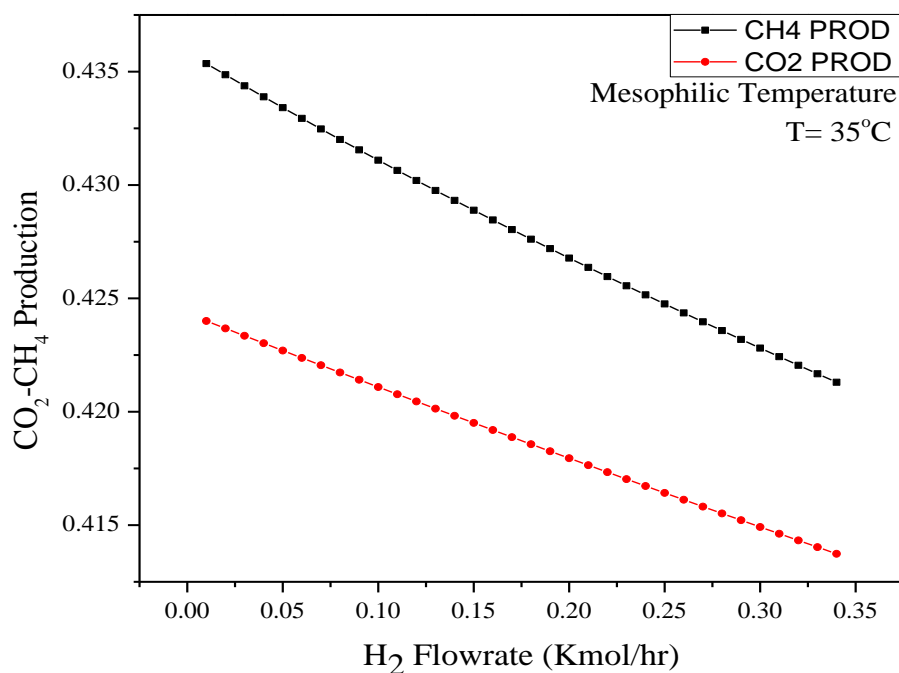

Figure 16. Sensitivity Analysis at Mesophilic Temperature in Terms of Production Rate



As we move ahead in the process, there is a constant increase in the concentration of ammonia due to the constant digestion of nitrogen, leading to pH value of above 8. To deal with this situation we can increase the temperature at cryophilic conditions, so that pH value stabilizes. The results have been shown in Figure 17. The graphs show an abnormal behavior and no significant change in methane production. On the other hand, Thermophilic range is more favorable. Mesophilic conditions are maintainable and thus, lesser expensive. The experimental observations have been considered under this temperature range. Most of the analysis also has been considered under this range.

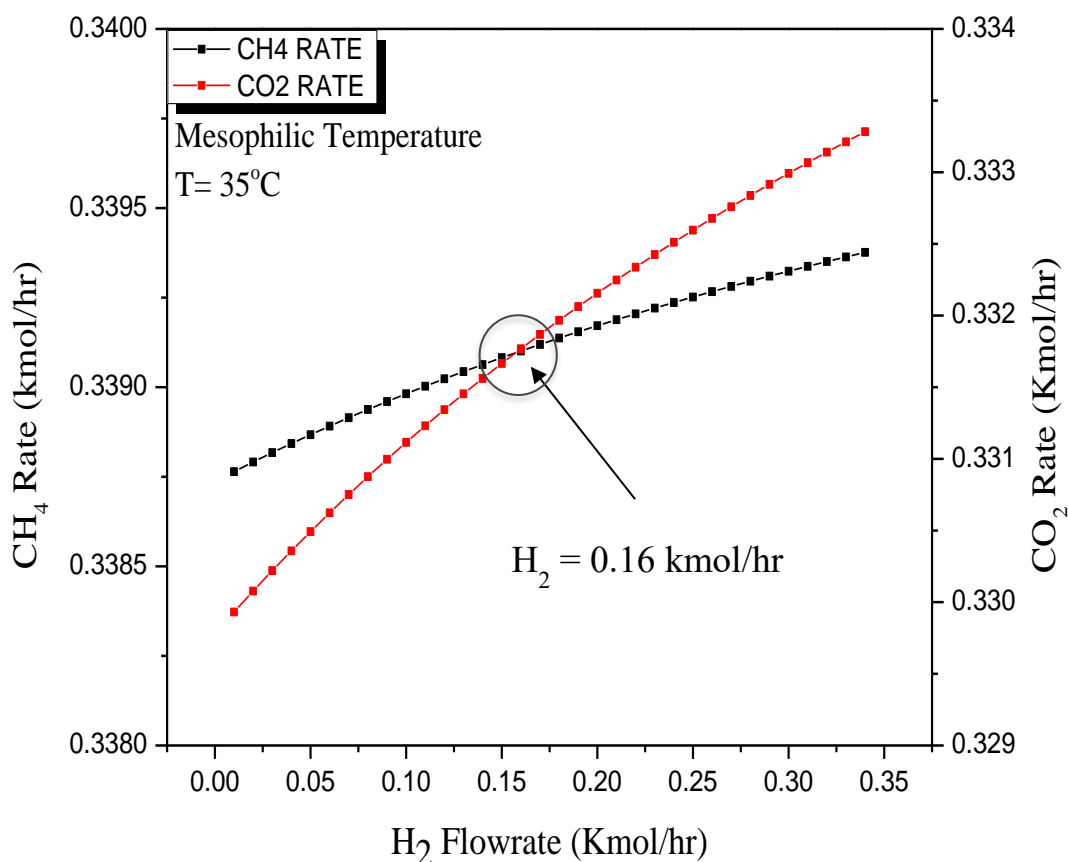

Figure 17. Sensitivity Analysis at Mesophilic Temperature in Terms of kmol/hr

#### 6.4. EFFECT OF RECYCLE RATIOS

As it has been studied and verified with the experimental observations, the recycle ratios increase the biogas production with efficient methane composition. As per the conclusions drawn from the Figure 18, it is obvious that till a certain optimum level the effect of recycle ratios favors the methane conversion. However, the simulation model does not show a significant conversion into methane.

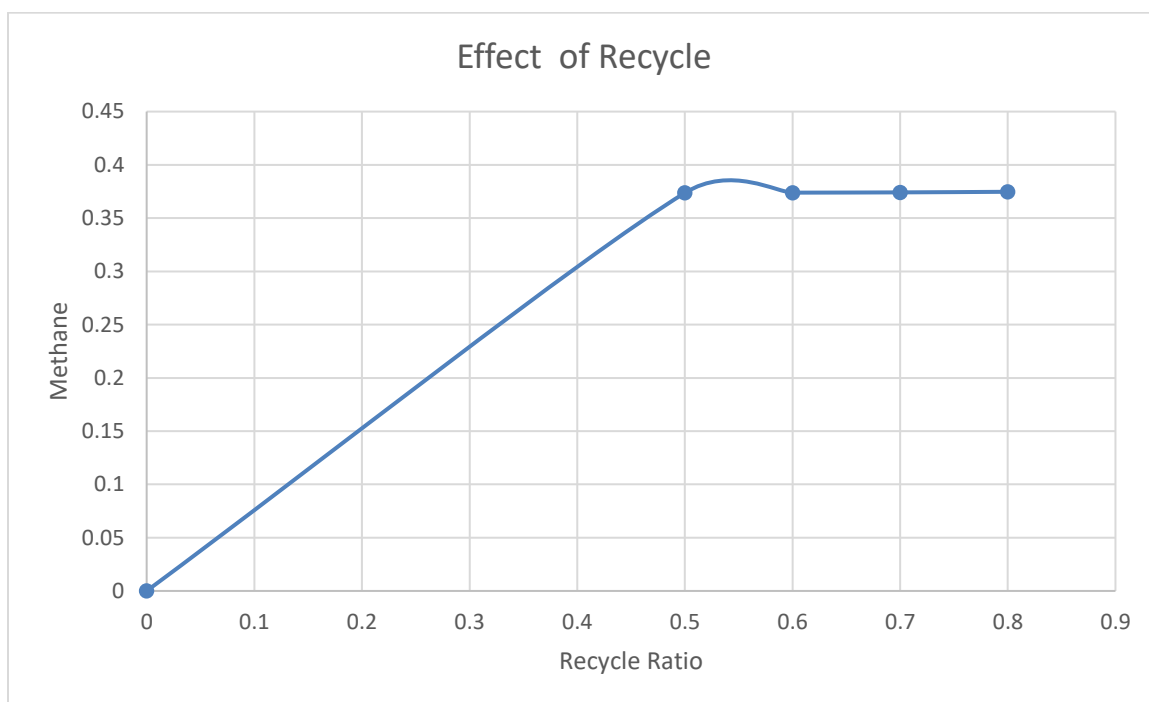

Figure 18. Sensitivity Analysis at Mesophilic Temperature to Study the Effect of the Recycle Ratios

The above graph is calculated for the feed rate of 0.24 l/day and Fgas stream rate of 0.207 kmol/hr.

## **7. DYNAMIC SIMULATION USING MIMIC MODEL FOR ANAEROBIC DIGESTION**

Mimic is the dynamic simulation software provided by Emerson Automation solutions, Pvt. Ltd. in Chesterfield, MO. Mimic has two types of models, Advanced Object based and Function Block based. Models are configured under areas of the simulation node. There is no restriction on the number of models which can be configured. At the simplest level, each model contains a group of blocks that calculates process values for some aspect of the desired process. Usually, a model will consist of a single DTB, LTB, or other IO function block, and its corresponding process simulation. Alternatively, users could group multiple DTB's and LTB's into a single model in order to consolidate, without affecting performance.

Models are downloaded into the Mimic run-time engine when a simulation node is started. A started node may or may not have active communications with the control system. While the node is executing, users may place it in the Paused state. In this state, model execution is paused until the user does a Resume. Additionally, a single model or all models may be Disabled. Disabled models will not execute, even though the simulation node is executing. Any values (IO, input to other models, etc.) the model was responsible for updating will retain their last value, until the model is enabled. Users can edit an executing model, using the Simulation Studio application. However, model changes will not take effect in the running simulation until a download occurs.

Models are downloaded into the Mimic run-time motor when a reenactment hub is begun. A began hub might possibly have dynamic interchanges with the control framework. While the hub is executing, clients may put it in the Paused state. In this state, show execution is delayed until the point that the client completes a Resume.

## 8. EXECUTION

Model execution is controlled by two parameters - Execution Priority and Scan Rate. Execution Priority is a parameter in the range 0-10. Assigning a '0' Execution Priority disables the model. Priority 1 is the highest and 10 the lowest. The default assigned priority on model creation is 5. Models assigned to Priority 1 are executed first, followed by Priority 2, and so on, with Priority 10 executed last. Once all the Standard Block Models are executed, the Advanced Modeling Objects are executed.

The Scan Rate can be 10 ms, 25 ms, 50 ms, 100 ms, 200 ms, 500 ms, and 1-10 seconds with models executing in 4 distinct groups. The above described Execution Priority works within the respective execution group. For example, for models executing in the 100ms group, models with execution priority 1 execute first followed by other models down the priority chain. Priority 1 at 100 ms is a different list than Priority 1 at 500 ms, but inside the given execution group, Priority 1 is always executed first.

Advanced Object based models default to a 1 second scan rate and can be assigned to the same execution groups as the Standard Models. These models do not have a configurable Execution Priority; they are always executed after the standard models in the selected scan rate. The figure shown below, Figure 19 shows the Advanced model using Mimic 3.7.2 for the anaerobic digestion process. Landing models act as an interface to these advanced models using logic as shown in Figure 20.

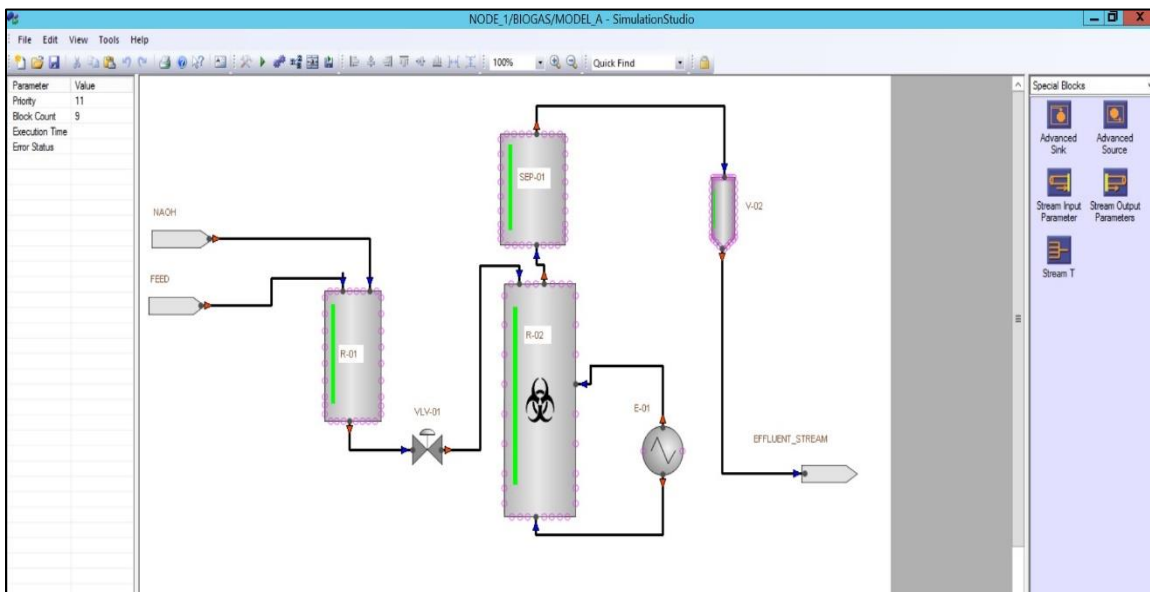

Figure 19. Dynamic Model Using Mimic 3.7.2 for Anaerobic Digestion Process

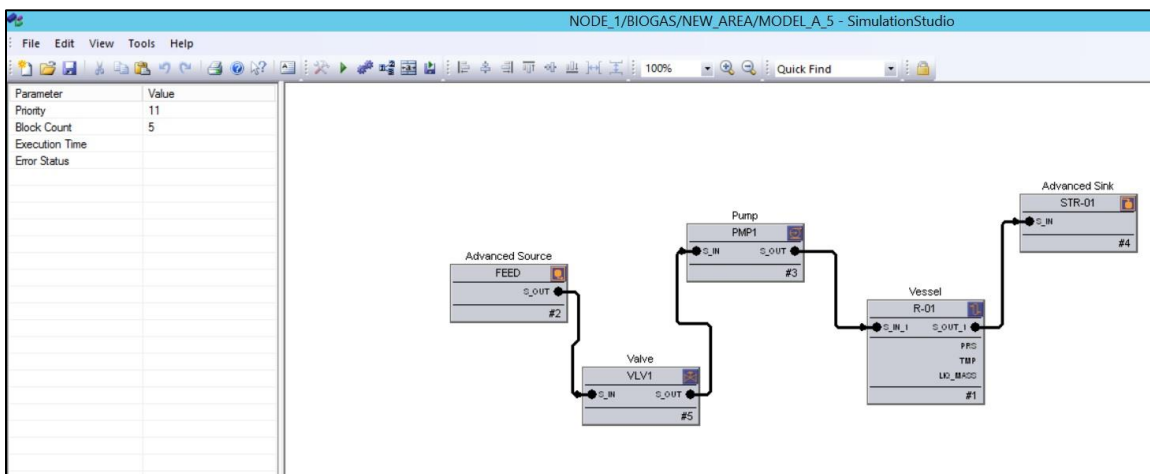

Figure 20. Landing Model for R-01

- Mimic Component Sets

Component Sets provide a simplified method for selecting and managing stream components. Component sets are selected and managed in Mimic Explorer under the library section. Any combination of chemical components found in the Thermodynamics

Properties Database can be grouped together. Once the component set is defined, it can be used in any Advanced Modeling Object by selecting the given name of the Component Set.

- Process Streams

Connections between modeling functions in base modeling functions are made with Wires. Wires pass the floating point value of the connection, the status, and the engineering units. In Advanced Modeling Objects, connections are made with Streams. Streams pass an array of information between the modeling objects including component concentration and activity, physical properties, and piping design information. The single Stream connection allows the user to quickly connect unit operation models and pass complete process data between them.

- Bioreactor

The bioreactor object provides a dynamic model of a batch bioreactor or fermenter with or without an agitator and sparge. The object can also model continuous biological reactions including startup and shutdown. General purpose biological kinetic equations for the effect of operating conditions on cell growth rate and product formation rate enable the user to readily match existing profiles of cell and product formations without the use of proprietary kinetics.

## REFERENCES

- [1] M. Ghorbanian, R. M. Lupitskyy, J. V Satyavolu, and R. E. Berson, "Impact of Hydraulic Retention Time at Constant Organic Loading Rate in a Two-Stage Expanded Granular Sludge Bed Reactor," *Environ. Eng. Sci.*, vol. 31, no. 6, pp. 317–323, 2014.
- [2] K. Moriarty, "Feasibility Study of Anaerobic Digestion of Food Waste in St . Bernard , Louisiana," *Natl. Renew. Energy Lab.*, no. January, 2013.
- [3] H. Al-Rubaye, S. Karambelkar, M. M. Shivashankaraiah, and J. D. Smith, "Process Simulation of Two-Stage Anaerobic Digestion for Methane Production," *Biofuels*, pp. 1–11, Apr. 2017.
- [4] N. J. Themelis, "Anaerobic Digestion of Biodegradable Organics in Municipal Solid Wastes," *Found. Sch. Eng. Appl. Sci. Columbia Univ.*, no. May, pp. 1–56, 2002.
- [5] Zhuang Zuo, Shubiao Wub, Wanqin Zhang, and Renjie Dong, "Effects of organic loading rate and effluent recirculation on the performance of two-stage anaerobic digestion of vegetable waste," *Bioresource Technology*, 556–561, 146 (2013).
- [6] Zhuang Zuo, Shubiao Wub, Wanqin Zhang, and Renjie Dong, "Performance of two-stage vegetable waste anaerobic digestion depending on varying recirculation rates," *Bioresource Technology*, 266-272, 162 (2014).
- [7] Zhuang Zuo, Shubiao Wub, Wanqin Zhang, and Renjie Dong, "Performance enhancement of leaf vegetable waste in two-stage anaerobic systems under high organic loading rate: Role of recirculation and hydraulic retention time," *Applied Energy*, 279-286, 147 (2015).
- [8] Yebo Li, Stephen Y. Park, Jiying Zhu, "Solid-state anaerobic digestion for methane production from organic waste," *Renewable and Sustainable Energy Reviews*, 821–826, 15 (2011).
- [9] R. S. Peris, "Biogas Process Simulation using Aspen Plus," 2011.
- [10] A. S. Dieter Dublin, *Biogas from Waste and Renewable Resources*. Weinheim, 2008.
- [11] A. Dhir and C. Ram, "Design of an Anaerobic Digester for Wastewater Treatment," *Int. J. Adv. Res. Eng. Appl. Sci.*, vol. 1, no. 5, pp. 56–66, 2012.

- [12] P. Kaparaju, L. Ellegaard, and I. Angelidaki, "Optimization of biogas production from manure through serial digestion: Lab-scale and pilot-scale studies," *Bioresour. Technol.*, vol. 100, no. 2, pp. 701–709, 2009.
- [13] M. Ghorbanian, R. M. Lupitsky, J. V Satyavolu, and R. E. Berson, "Impact of Hydraulic Retention Time at Constant Organic Loading Rate in a Two-Stage Expanded Granular Sludge Bed Reactor," *Environ. Eng. Sci.*, vol. 31, no. 6, pp. 317–323, 2014.
- [14] M. Ghorbanian, "Enhancement of anaerobic digestion of actual industrial wastewaters : reactor stability and kinetic," University of Louisville, 2014.
- [15] A. S. Dieter Deublin, *Biogas from Waste and Renewable Resources*. Weinheim, 2008.
- [16] K. Rajendran, H. R. Kankanala, M. Lundin, and M. J. Taherzadeh, "A novel process simulation model (PSM) for anaerobic digestion using Aspen Plus," *Bioresour. Technol.*, vol. 168, pp. 7–13, 2014.
- [17] D. J. Batstone, J. Keller, I. Angelidaki, S. V Kalyuzhny, S. G. Pavlostathis, A. Rozzi, W. T. M. Sanders, H. Siegrist, and V. A. Vavilin, *Anaerobic digestion model No. 1 (ADM1)*. IWA Publishing, 2002.
- [18] I. Angelidaki, L. Ellegaard, and B. K. Ahring, "A comprehensive model of anaerobic bioconversion of complex substrates to biogas," *Biotechnol. Bioeng.*, vol. 63, no. 3, pp. 363–372, 1999.
- [19] I. Angelidaki, X. Chen, J. Cui, P. Kaparaju, and L. Ellegaard, "Thermophilic anaerobic digestion of source-sorted organic fraction of household municipal solid waste: Start-up procedure for continuously stirred tank reactor," *Water Res.*, vol. 40, no. 14, pp. 2621–2628, 2006.
- [20] G. Luo and I. Angelidaki, "Co-digestion of manure and whey for in situ biogas upgrading by the addition of H<sub>2</sub>: process performance and microbial insights," *Appl. Microbiol. Biotechnol.*, vol. 97, no. 3, pp. 1373–1381, 2013.
- [21] P. Bhunia and M. M. Ghangrekar, "Analysis, evaluation, and optimization of kinetic parameters for performance appraisal and design of UASB reactors," *Bioresour. Technol.*, vol. 99, no. 7, pp. 2132–2140, 2008.
- [22] Manohar M. S., Haider Al-Rubaye, Shruti S. K., Joseph D. Smith, "Recycling effect in Expanded Granular Sludge Bed reactor.
- [22] Mimic Wiki files



## SECTION

### 2. CONCLUSION

The effect of variation of parameters has been studied successfully using Aspen Plus model. It has also been validated with the experimental results based on the observed data. Sensitivity analysis has been conducted for H<sub>2</sub> injection, temperature sensitivity and recirculation ratios. The results concluded that the higher the recycle ratios the higher the methane composition till a peak point is reached by the anaerobic digestion process. As for the OLRs, as the organic loading rate is increased, biogas production is enhanced till the reactor is stable. H<sub>2</sub> injection increases the methane production in the biogas stream, thus, enhancing biogas production. However, injection above a critical level can lead to a certain instability in the reactor as the pH of the system is greatly affected.

Also, a dynamic simulation model using Mimic software has been successfully designed and presented. Thus, the real life dynamic process can be modeled with Mimic for operator training purposes. Dynamic simulation thus, sets it's benchmark for the latest trends in industries for operational purposes and one of the models for anaerobic digestion have been presented in this project.

## VITA

Shruti Shrikant Karambelkar was born in Maharashtra (India). Shruti earned her bachelor's degree in Chemical Engineering from Bharati Vidyapeeth College of Engineering, Navi Mumbai. During this time, she found an opportunity to work with SI Group, an industrial project on a study of Phthalic Anhydride using partial oxidation process. She received her Bachelor of Engineering in June 2013.

Shruti joined Sameer Chemcon Engineering Pvt. Ltd as a Jr. Process engineer and then Tebodin India Pvt. Ltd. as a Process engineer with a total experience of two years. Shruti joined Missouri University of Science and Technology in January of 2016 for her Masters' degree program. There, she was given an opportunity to work as a graduate research assistant under Dr. Joseph Smith on a few projects. Shruti pursued a Co-Op with Emerson Automation Solutions during her Masters' degree program. Shruti Shrikant Karambelkar received her Master of Science in Chemical Engineering from Missouri University of Science and Technology in May of 2018.