

University of Windsor

Scholarship at UWindor

Electronic Theses and Dissertations

Theses, Dissertations, and Major Papers

2014

Modular Product Platform Configuration and Co-Design of Assembly Line

Mohammad Hanafy
University of Windsor

Follow this and additional works at: <https://scholar.uwindsor.ca/etd>



Part of the [Systems Engineering Commons](#)

Recommended Citation

Hanafy, Mohammad, "Modular Product Platform Configuration and Co-Design of Assembly Line" (2014). *Electronic Theses and Dissertations*. 5074.
<https://scholar.uwindsor.ca/etd/5074>

This online database contains the full-text of PhD dissertations and Masters' theses of University of Windsor students from 1954 forward. These documents are made available for personal study and research purposes only, in accordance with the Canadian Copyright Act and the Creative Commons license—CC BY-NC-ND (Attribution, Non-Commercial, No Derivative Works). Under this license, works must always be attributed to the copyright holder (original author), cannot be used for any commercial purposes, and may not be altered. Any other use would require the permission of the copyright holder. Students may inquire about withdrawing their dissertation and/or thesis from this database. For additional inquiries, please contact the repository administrator via email (scholarship@uwindsor.ca) or by telephone at 519-253-3000ext. 3208.

Modular Product Platform Configuration and Co-Design of Assembly Line

By

Mohammad Mahmoud Abdu Hanafy

A Dissertation

Submitted to the Faculty of Graduate Studies
through Industrial and Manufacturing Systems Engineering
in Partial Fulfillment of the Requirements for
The Degree of Doctor of Philosophy at the
University of Windsor

Windsor, Ontario, Canada

2014

©2014 Mohammad Hanafy

Modular Product Platform Configuration and Co-Design of Assembly Line

by

Mohmmad Mahmoud Abdu Hanafy

APPROVED BY:

R. Jiao, External Examiner
Georgia Institute of Technology

R. Gras
School of Computer Science

A. Azab
Industrial & Manufacturing Systems Engineering

Z. Pasek
Industrial & Manufacturing Systems Engineering

H. ElMaraghy, Advisor
Industrial & Manufacturing Systems Engineering

February 10, 2014

Declaration of Co-Authorship / Previous Publication

I. Co-Authorship Declaration

I hereby declare that this dissertation incorporates material that is result of joint research of the author and his supervisor Prof. Hoda ElMaraghy. This joint research has been submitted to journals and conferences that are listed below.

I am aware of the University of Windsor Senate Policy on Authorship and I certify that I have properly acknowledged the contribution of other researchers to my dissertation, and have obtained written permission from Prof. Hoda ElMaraghy to include that material(s) in my thesis.

I certify that, with the above qualification, this dissertation, and the research to which it refers, is the product of my own work.

II. Declaration of Previous Publication

This dissertation includes [5] original papers that have been previously published/submitted for publication in peer reviewed journals and conferences as follows:

Dissertation Chapter	Publication Title/Full Citation
2	Hanafy, M. and ElMaraghy, H., 2014. Developing of an Assembly Line Layout for Delayed Product Differentiation Using Phylogenetic Networks. International Journal of Production Research. (submitted)
3	Hanafy, M. and ElMaraghy, H., 2014. Modular Product Multi-Platform Configuration Model. International Journal of Intelligent Manufacturing. (Submitted)
3	Hanafy, M. and ElMaraghy, H., 2012. A Modular Dynamic Products Platforms Design Model. 23rd CIRP Design Conference 2013. Bochum, Germany: pp: 553-562.
4	Hanafy, M. and ElMaraghy, H. A., 2014. A Multi-Period Changeable Modular Product Assembly Model. Enabling Manufacturing Competitiveness and Economic Sustainability, Springer: 137-142.
5	Hanafy, M. and ElMaraghy, H., 2014. Modular Product Platform Configuration and Co-Design of Assembly Line Model. Computers & Industrial Engineering (to be submitted).

I certify that I have authorization from the copyright owner(s) to include the above published material(s) in my dissertation. I certify that the above material describes work completed during my registration as graduate student at the University of Windsor.

I declare that, to the best of my knowledge, my dissertation does not infringe upon anyone's copyright nor violate any proprietary rights and that any ideas, techniques, quotations, or any other material from the work of other people included in my dissertation, published or otherwise, are fully acknowledged in accordance with the standard referencing practices. Furthermore, to the extent that I have included copyrighted material that surpasses the bounds of fair dealing within the meaning of the Canada Copyright Act, I certify that I have obtained a written permission from the copyright owner(s) to include such material(s) in my dissertation.

ABSTRACT

In this dissertation, the main hypothesis is that formation of products families and platforms can be simultaneously achieved with their corresponding assembly lines using a holistic mathematical model to increase the effectiveness of mass customization and decrease development and assembly costs. A Phylogenetic Network algorithm, four different mathematical models, and postponement effectiveness metric have been developed and implemented to prove this hypothesis. The results of this research are applicable to many modular products such as consumer goods such as computers, laptops, tablets, power tools, home appliances and laboratory weighing scales which have multiple variants. The research provides a hybrid approach balancing between platforms production using make-to-stock strategy, then further customization using make-to-order strategy.

The Median-Joining Phylogenetic Network (MJPN) is used to model a delayed differentiation assembly line for a product family. The MJPN is capable of increasing commonality across the product platforms using the Median Vector concept. A Postponement Effectiveness metric was developed and showed that the determined assembly line strategy postponed the products delayed differentiation point more than other found in literature. A Modular Product Multi-Platform Configuration Model is introduced to design optimal products platforms which allow assembly and disassembly of components to form new product variants. A new model of Hierarchic Changeable Modular Product Platforms which defines the optimum hierarchy of the platform components is introduced, to enable delayed product differentiation. A Multi-Period Multi-Platform Configuration Model which accounts for demand fluctuation by including the cost and quantity of inventory of product platforms required for implementing the assembly/disassembly platforms customization was developed. Finally, a global product families and platforms formation mathematical model which fully integrates assembly task assignments, precedence relations, assembly cost was introduced. A family of touch screen tablets was used for illustrating the application and advantages of the newly developed product platform models.

This research makes a number of contributions. This is the first time mathematical models are able to flexibly determine the optimal number of product platforms using customization by assembly and disassembly. Inclusion of hierarchy or assembly sequence in platform formation as a variable is novel. This will eliminate assembly sequence ambiguity when designing platforms with duplicate components. The inclusion of inventory costs and quantities in platform design is also new. Finally, the complete integration of platform formation and assembly line design in one mathematical model is introduced for the first time.

To my father, who had enlighten my life
To my mother, the helper and the supporter
To my wife, who filled my life with hope and passion
To my supervisor, the guider through this journey

ACKNOWLEDGEMENT

The author expresses his gratitude to his supervisor Professor Hoda ElMaraghy. Her great efforts, support, knowledge and encouragement greatly inspired and driven the research to the right direction. Professor Hoda provided tremendous time, follow-ups, and dedication to research, which have been a great boost to solidify and materialize the scope and the thesis core.

The author also acknowledges the important role of the supervising committee. The committee members: Dr. Azab, Dr. Pasek and Dr. Gras have helped the author in clarifying his thoughts, ideas and results. They provided deep, sincere guidance and comments from the very beginning point of the comprehensive exam's topics. The author acknowledges the supportive and educational role of Dr. Waguih ElMaraghy. His discussions and knowledge about complexity and design methodologies have been of great value to the research. I also would thank all members of Intelligent Manufacturing Systems Centre (IMSC) for their great help and fruitful discussions through the course of this thesis.

Finally, the author would like to thank his family for the great support and love they provided. Without this kind of support, it would be impossible to complete this thesis.

TABLE OF CONTENTS

ABSTRACT	V
ACKNOWLEDGEMENT	VII
LIST OF FIGURES	XI
LIST OF TABLES	XIII
Chapter 1	1
Co-Design of Modular Product Platforms and Assembly Lines	1
1 Introduction	1
1.1 Background	1
1.2 Motivation	1
1.3 Engineering Problem Statement	2
1.4 Objectives	2
1.5 Research Scope	3
1.6 General Useful Guidelines	5
1.7 Definitions Used	5
1.8 Research Gaps	5
1.9 Research Plan	6
1.10 Thesis Statement	8
Chapter 2	9
Developing of an Assembly Line Layout for Delayed Product Differentiation Using Phylogenetic Networks	9
2 Introduction	9
2.1 Product Platform Concept	10
2.2 Assembly Lines	12
2.3 Literature Review	14
2.4 Problem Formulation	21
2.5 Case Study	23
2.6 Postponement Effectiveness Metric	26
2.7 Conclusions	33

Chapter 3	35
Modular Product Multi-Platform Configuration Model	35
3 Introduction	35
3.1 Motivation	35
3.2 Combined Assembly and Disassembly Concept in Forming Platforms	35
3.3 Model Development	37
3.4 Non-Linear Modular Product Multi-Platform Configuration Model	39
3.5 Initial Comparison between MPMP Model and Ben Arie's Model	42
3.6 Illustrating Example	42
3.7 Results	43
3.8 Case Study	47
3.9 Performance Evaluation	50
3.10 Contributions	53
3.11 Conclusions	53
3.12 A Hierarchic Model of Changeable Modular Product Platforms (Model 3)	54
Chapter 4	63
A Multi-Period Multi-Platform Configuration Model	63
4 Introduction	63
4.1 Literature Review	63
4.2 Problem Statement	64
4.3 Mathematical Model	65
4.4 Model decision variables	66
4.5 Mathematical model formulation	67
4.6 Illustrative Example	69
4.7 Results and Discussion	70
4.8 Contributions	72
4.9 Conclusions	72
Chapter 5	73
Modular Product Platform Configuration and Co-Design of Assembly Line Model (MPCA)	73
5 Introduction	73
5.1 Literature Review	73
5.2 Model Development	75
5.3 The Assembly Line Design Variables	77
5.4 Mathematical Model Development	78

5.5	Linearized Product Platform Assembly Line Model	81
5.6	Example	84
5.7	Results of Scenario A	84
5.8	Results of Scenario B	86
5.9	Model Verification	88
5.10	Contributions	89
5.11	Conclusions	89
Chapter 6		91
Conclusions and Future work		91
6	Discussion	91
6.1	Achievements	91
6.2	Conclusions	92
6.3	Significance	94
6.4	Limitations	94
6.5	Future Work	94
REFERENCES		96
APPENDIX A		101
VITA AUCTORIS		106

LIST OF FIGURES

Figure 1.1 Product platform research positioning.....	4
Figure 1.2 Other modular products that can make use of the proposed research	4
Figure 1.3 Models and metric developed through this research.....	7
Figure 2.1 Framework of assembly/disassembly product platform customization	14
Figure 2.2 Illustration of Assembly / Disassembly Modular Platforms (ADMP)	18
Figure 2.3 Taxonomy of different types of phylogenetic networks (Huson and Scornavacca (2011)	19
Figure 2.4 Flow chart of MJPN algorithm (adapted from Bandelt et al. 1999).....	20
Figure 2.5 Median vector concept adapted from (Bandelt et al. 1999)	21
Figure 2.6 Delayed product differentiation modular platform network model	22
Figure 2.7 The studied kettle’s product family (AlGeddawy and ElMaraghy 2010a)	23
Figure 2.8 Parts used in the kettle product family (AlGeddawy and ElMaraghy 2010a).....	23
Figure 2.9 A Cladogram showing delayed product differentiation layout (adapted from AlGeddawy and ElMaraghy 2010a).....	24
Figure 2.10 Delayed product differentiation modular platform network model results for the family of Kettles assembly system layout.....	25
Figure 2.11 Assembly line layouts comparisons regarding postponement effectiveness.....	27
Figure 2.12 Postponement Effectiveness (PE) metric illustration	29
Figure 3.1 Product platform customization by assembly and disassembly of components/modules	37
Figure 3.2 IDEF0 of Modular Product Multi-Platform Model (MPMP).....	37
Figure 3.3 Precedence of Product Components (Adopted from Ben-Arieh et al. 2009).....	43
Figure 3.4 Different locations for a duplicate component	44
Figure 3.5 Touch Screen 7’’ tablet	47
Figure 3.6 Assembly Precedence Diagram of the touchscreen tablets family.....	49

Figure 3.7 (a-c) Different comparisons between cost of assembling, cost of disassembling and cost of platform ratios to the total cost	52
Figure 3.8 IDEF0 of the Hierarchic Changeable Modular Product Platforms model	57
Figure 3.9 Dummy component explanation.....	58
Figure 3.10 Precedence Diagram of the tablets family showing speaker assembly positions.....	61
Figure 4.1 Multi-period Multi-Platform configuration model.....	65
Figure 5.1 Manual assembly line representation	75
Figure 5.2 Modular product platform configuration and co-design of assembly line model	75
Figure 5.3 IDEF0 of modular product platform configuration model and co-design of assembly line	76
Figure 5.4 Piece-wise linearization scheme.....	83
Figure 5.5 Model output containing products and platforms assignments for the first scenario (i.e. mass assembly and customization by disassembly).....	85
Figure 5.6 Model output containing products and platforms assignments for the second scenario - mass assembly, customization by assembly and disassembly.	87

LIST OF TABLES

Table 1.1 Literature matrix showing gaps in modular product families and platform design.....	6
Table 2.1 Incidence matrix of the kettles product family	24
Table 2.2 Comparison between different assembly line layouts including the newly proposed layout.....	32
Table 3.1 Comparison between MPMP model and Ben Arie’h’s model.....	42
Table 3.2 The comparison between the results of Ben Arie’h’s model and the MPMP model.....	45
Table 3.3 Results of the MPMP model using multiple platforms.....	46
Table 3.4 Costs and composition of each tablet	48
Table 3.5 Optimal multiple platforms and product families.....	50
Table 3.6 Model performance evaluation with varying number of products and components	53
Table 3.7 Comparison between model 2 and model 3 using the illustrative example (single platform)	58
Table 3.8 Comparison between model 2 and model 3 using the illustrative example (multiple platform)	59
Table 3.9 Costs and composition of each tablet	60
Table 3.10 Single and Multi Platform Optimum Hierarchy	61
Table 4.1 Results of the multi-period multi-platform model.....	70
Table 4.2 Model Performance.....	71
Table 5.1 Effect of days allowed for assembly (<i>ND</i>) on platform composition	88
Table 5.2 Effect of customization by disassembly time (<i>taj</i>) on platform composition.....	88
Table 5.3 Effect of line efficiency on platform composition.....	89

Chapter 1

Co-Design of Modular Product Platforms and Assembly Lines

1 Introduction

1.1 Background

In these days, products variety becomes a necessity. The customers are always asking for more new products with very fluctuating and uncertain demands and needs. These demands necessitate the development of different concepts that enhance Mass Customization. The competition to acquire new markets and even to preserve the existing one requires efficient production methods. Efficient methods mean decreasing the costs, while keeping the quality and prevent loss of functionality of the products. Most of the time the main strategy used to attain this type of competitive edge is called Mass Customization. Research in this field contains many different domains like: product families, product platforms and portfolios, assembly line design, production flexibility, delayed product differentiation. Ulrich (1995) discussed the product architecture concept impact on industrial corporations. He differentiated clearly between different product architecture: modular and integral. Also, he further divided the modular concept to: slot, bus, and sectional types. Erens and Verhulst (1997) extended the product architecture concept to product families, and suggested that there are three models that govern the product realization: function, technology, and physical.

1.2 Motivation

The modern industrial engineering research always cares for fulfilling fluctuating markets demand with a customer-focused perspective. Balanced and economical variations in products coupled with mass customization techniques increase the corporations' competitiveness. The assembly costs contribute for more than 20% of the final product price. Therefore, decreasing assembly costs become more crucial in the recent research. Many of the Original Equipment Manufacturers (OEMs) are now concentrating on the assembly of their products rather than totally manufacturing them. Hence, the field of product assembly has received much attention in industrial research. Product platform is considered one of the prominent and promising ways to decrease assembly costs. Normally, the product platform is being produced on a mass production scale, and then based on customer demand, the product platform is customized to fulfill different needs and create different products. The product platform concept embraces the concept of delayed product differentiation.

Delayed product differentiation is based on the creation of the platform that contains the most of the shared elements of a certain product family, which postpone the early customization of the platform, and enables the mass production of that platform. This concept needs to be more integrated with the product platform design to save more assembly costs.

In big corporations, the product platform is first designed then the design of the assembly line follows. This creates a gap between product platform design and assembly/manufacturing systems design. The results could be more time and costs, and the presence of a subjective feedback loop that must be mitigated by trial and error. An urgent need is rising now to develop different product platform and assembly system models that can efficiently deal with changeable and evolving product families and platforms along with utilizing the concept of delayed product differentiation, while reducing the costs for the whole process at the same time.

1.3 Engineering Problem Statement

The problem is how to integrate the design of product families (members of each family), product platforms (number of platforms, components composition and hierarchy), delayed product differentiation, and assembly system design (assembly assignment, number of stations) in one holistic mathematical model. The mathematical model(s) should minimize total assembly costs associated with products assembly and line design.

1.4 Objectives

Based on engineering problem statement, this research will be accomplished by working on three main objectives:

- First, it is required to develop a model that can integrate delayed product differentiation and products platforms concepts and avoid the drawbacks that will be discussed extensively in the literature. The Median Joining Phylogenetic Network (MJPN) algorithm that is used heavily in biology to identify ancestries of different species will be used to design product platforms and families. The algorithm avoids the determination of number of platforms a priori. The algorithm employs an assembly/disassembly strategy to form product platforms. It depends on forming a product platform that most of the products share, and then customizes it by adding or removing components in a well-defined way.
- Second, a more flexible mathematical model approach will be developed to target the same problem. The reason is that the algorithm of the MJPN cannot deal with some perspectives of product platforms including costs of assembly. Therefore, the mathematical model can tackle more aspects of product platform and assembly line formation.
- Third, a new Hierarchic Model of Changeable Modular Product Platforms Model will be proposed to deal with the components that can exist in different assembly positions. This model will give a new, well-defined, and complete definition of product platform and families formation.

- Fourth, a new Multi-Period Multi-Platform Model will be proposed to test the effect of for products and platforms' inventories using combined assembly and disassembly of components to derive products from their platforms.
- Fifth, a holistic model that combines and obtain product families, product platforms, assembly costs, employs delayed differentiation, and assembly line design will be proposed. This will be the first time to introduce such integrated model that is based on well-established solid mathematical foundations.

1.5 Research Scope

In Figure 1.1, the field of product families and platforms includes different classifications (physical (Erens and Verhulst 1997), functional (Kumar and Allada 2007), modular, and scalable (Simpson et al. 2001)), metrics, and frameworks. The main emphasis of the research is the modular product platforms configuration problem. These types of platforms depend on the formation of the optimum groups, modules, and platforms of different types of interchangeable components across product families. These platforms are assembled in a Make-To-Stock (MTS) model based on demand forecasting, in which the manufacturer is able to mass assemble the common platform of different products. Then different products can be derived from these platforms according to arriving customers' orders or Make-To-Order (MTO) model. The research is based on simultaneous assembly and disassembly of components of a mass assembled platforms to obtain different products. The proposed research utilizes both of MTS and MTO in a hybrid model of producing platforms with maximum number of shared components, then derives different products by assembling and disassembling components. Using the developed models would help in increasing market share due to adaptive responsiveness of corporations to uncertain customer demands.

The research scope includes broad range of product families: computers, touch screen tablets, home appliances (kettles, microwaves...etc.), power tools, and others (Figure 1.1 and Figure 1.2). A good example of assembly and disassembly concept is lab scales produced by Sartorius AG Incorporation (Figure 1.1). The scale main platform consists of 3 units: i) Weighing module, ii) display and control unit, and iii) no draft shield. This default platform enables the manufacturer to remove, for example, the no drafting shield if it is not needed. Also, the customers may ask for a high resolution weighing module which would be added when needed. Therefore, the main scale platform contains modules that are not shared by each possible combination of the lab scale. This illustrates the use and the benefits of the assembly and disassembly to derive different products from the same platforms. In this dissertation, two main methods will be used: integer mathematical programming and a median network heuristic algorithm.

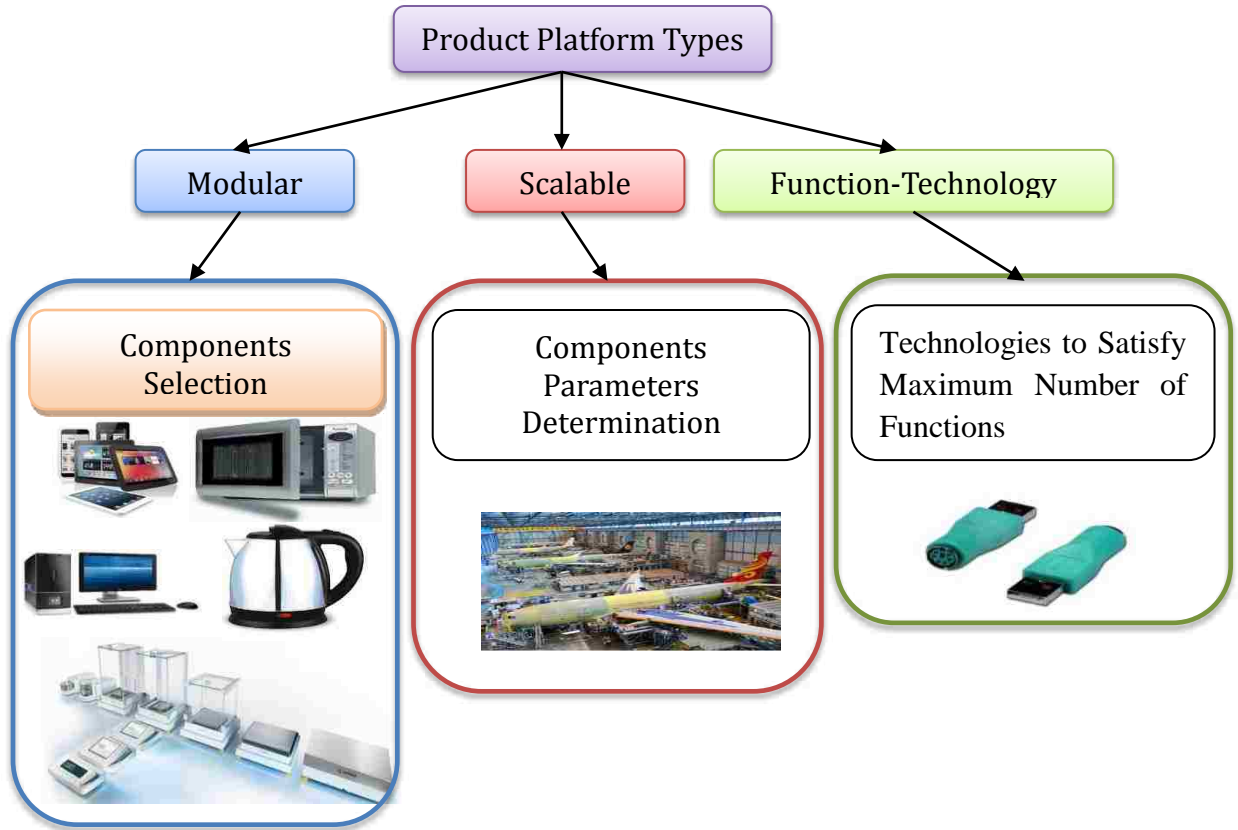

Figure 1.1 Product platform research positioning

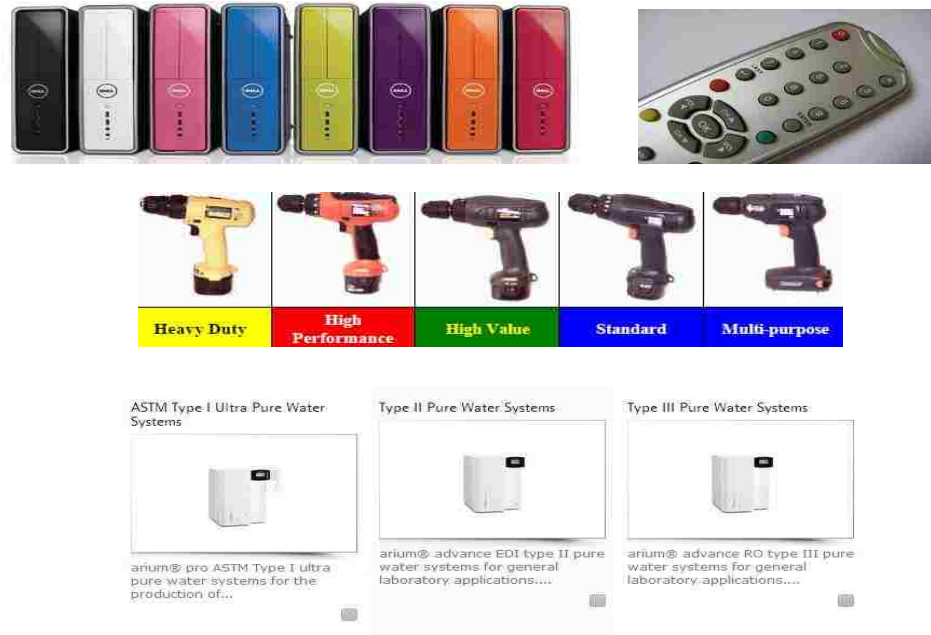

Figure 1.2 Other modular products that can make use of the proposed research

1.6 General Useful Guidelines

Generally, the developed mathematical models are able to determine when to use the disassembly concept to customize platforms to derive products. However, some guidelines can be followed to maximize the benefits of using combined assembly and disassembly to derive new product variants. It is assumed through the whole dissertation that each component in a product has three different assembly times or costs for: mass produced platform assembly, customization by assembly and customization by disassembly:

- Platform mass production times or costs should be smaller than platform customization to derive new components by assembly costs and times.
- Customization by assembly costs or times should be larger than customization by disassembly costs or times.
- Parts can be disassembled without damage to the part or surrounding parts (e.g. welding is not used).
- The maximum number of possible platforms is the number of products.

1.7 Definitions Used

Many concepts and definitions have been mentioned throughout the dissertation. These are listed below to clearly define their meaning as used in this research:

- Co-Design of Product Platforms and Systems: it means that the design of both of product platforms and their assembly lines are included in one mathematical model. Sometimes co-design is used to describe the collaboration of two or more individual in a certain project, but this is not the case here.
- Modular Product Platform: A set of sub-systems and interfaces which form a common structure, from which a stream of derivative products can be efficiently produced and developed (Meyer and Lehnerd 1997).
- Customization of platforms by assembly and disassembly: the manufacturer should mass assemble the product platforms, and then customize it later to derive different products by assembling or disassembling of components. This customization process takes place during manufacturing and, hence, is not considered rework or repair (Similar to Dell business model).

1.8 Research Gaps

The number of product platforms in present models must be determined a priori. The product platform models have nonlinear time exponential nature; hence meta-heuristics are needed. There is a lack of completely defining both of compositions and hierarchies of components inside their platforms. Furthermore, there is a lack of complete products platform formation models which

simultaneously integrate (or combine) the design of product platform with their corresponding assembly lines. Research gaps are summarized in Table 1.1.

Table 1.1 Literature matrix showing gaps in modular product families and platform design

References	Problem formulation technique	Several families /platforms? (Y,N, P)	Is Platform Hierarchy predetermined? (Y, N, NC)	Market demand included?	Manufacturing/Assembly costs? (Y, N)	Assembly line design (Y, N)
Huang et al. (2003)	Graph theory	N	N	N	N	N
Huang et al. (2005)	Math model, Genetic Algorithm	N	Y	Y	Y	N
Rai and Allada (2006)	Agent-based pareto	N	Y	N	N	N
Zacharias and Yassine (2008)	Math model	Y, P	Y	N	Y	N
Ben-Arieh et al. (2009)	Math model, Genetic Algorithm	Y	NC	Y	Y	N
AlGeddawy and ElMaraghy (2010a)	Cladistics algorithm	Y	NC	N	N	Y

NC: Not Complete

P: Predetermined

Y: Yes

N: No

1.9 Research Plan

In Figure 1.3, my research plan is based on several models and a metric:

- Expanding product platform design and configuration by making use of assembly and disassembly concept through a well-known scientific biological method “Phylogenetic Network”. This network is a clustering technique that is used to classify living organisms into well-defined groups by predicting their possible ancestors.

- Developing a Postponement Effectiveness metric to evaluate the newly used Phylogenetic Network efficiency in producing product platforms and families.
- As an extension to the Phylogenetic concept, a new mathematical model is proposed to form both of product families and product platforms of modular products; the target is minimizing number of platforms and costs associated with its assembly, postpone differentiation point by increasing commonality through assembly and disassembly concept. The model should be able to solve real life large-components scenarios. The model should be able to avoid possible previous instabilities and inefficiencies in literatures' models.
- A Hierarchic Model of Changeable Modular Product Platforms based on assembly costs is proposed to increase the capabilities of the previous model. The new model should be able to identify clearly the hierarchy of components inside each platform.
- A Multi-Period Multi-Platform Configuration Model is proposed to include inventory costs and quantities to the product platform formation. The model should identify product families and platforms and the expected inventories for multiple periods of production.
- A complete mathematical holistic model is proposed to co-design modular product platforms and families with assembly line design. This is the first time to provide full model that link product platforms design with assembly line design.

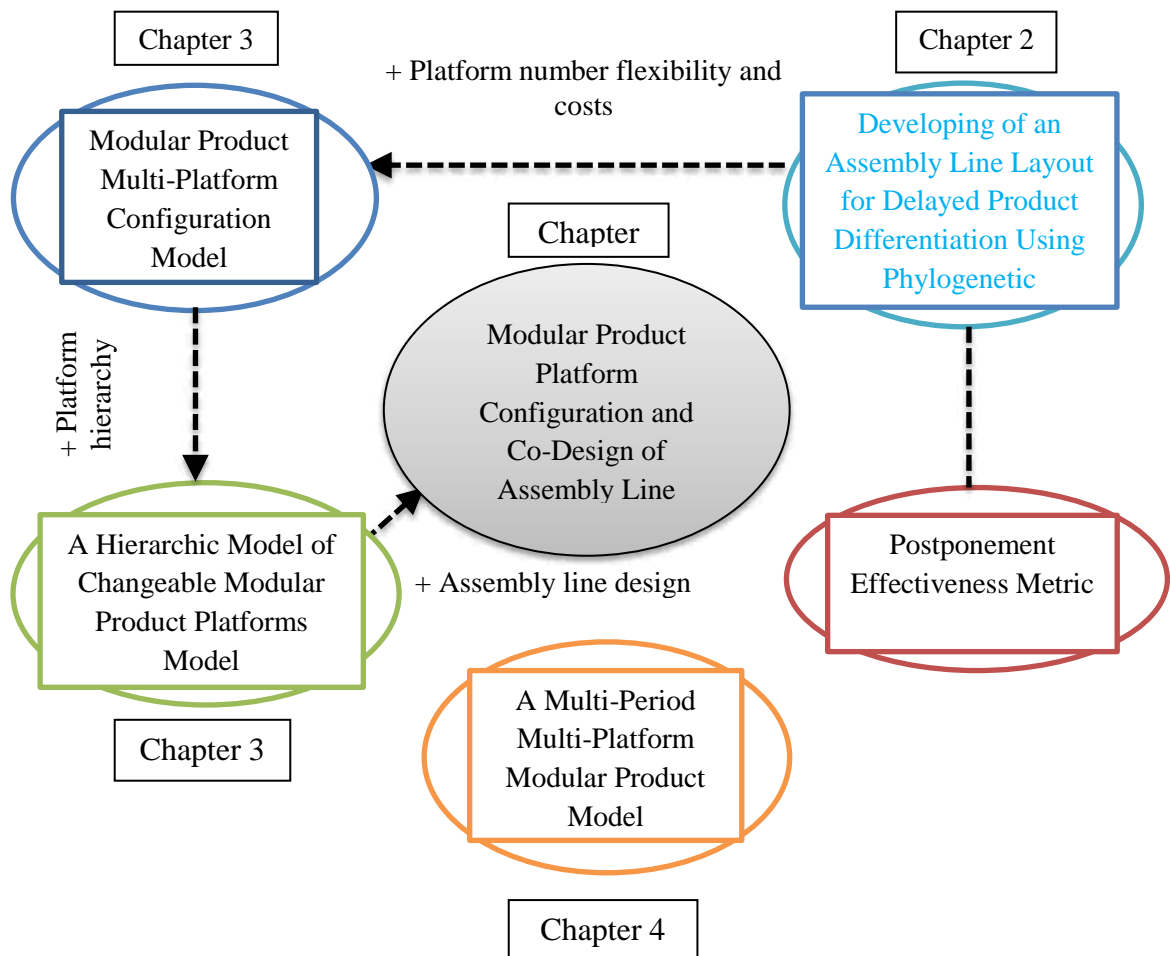

Figure 1.3 Models and metric developed through this research

1.10 Thesis Statement

The presented research based on the following thesis:

Formation of products families and platforms can be simultaneously achieved with their corresponding assembly lines using a holistic mathematical model to increase the effectiveness of mass customization and decrease development and assembly costs

Chapter 2

Developing of an Assembly Line Layout for Delayed Product Differentiation Using Phylogenetic Networks

2 Introduction

Market changes and increased variety make accurately prediction of future demands for products and their variants difficult. Effective formation of products platforms helps mitigate this uncertainty and decrease time-to-market and lead-time. Product platform entails grouping of core elements of product family members into common modules which are used to form different variants by combining different components. High commonality between product variants is achieved by maximizing similarity between grouped parts. A new Delayed Product Differentiation Modular Platform model, which applies Median-Joining Phylogenetic Networks (MJPN), is proposed. It is used for forming products platforms and determining the assembly line layout of modular product families. The MJPN is traditionally used for DNA sequences' mapping, analysis, clustering and for tracing evolutionary trends. The concept of Assembly/Disassembly Modular Platforms (ADMP), where both assembly and disassembly of components are used to derive the final product variants from the platform, is used. The proposed model determines the required number and composition of common platforms and defines the delayed product differentiation points. The developed dynamic assembly/disassembly platforms enhance routing and product mix flexibility due to the presence of different platforms that can be used to produce the same product variant. A family of household kettles is used to demonstrate the application of the proposed model. A metric is presented for determining the effectiveness of a given platform in delaying the product differentiation which increases the efficiency of mass customization. The proposed metric, applied to the case study, demonstrated that the proposed platform formation model using MJPN is better capable of postponing the product differentiation point.

The competition to acquire new markets and preserve existing ones necessitates responsiveness in producing the products and their variants in the required quantities and time. One of the main strategies used to attain such competitive edge is Mass Customization which helps provide different goods, products, and services to customers with nearly the quality and prices of mass produced products (Ferguson et al. 2010). Delayed product differentiation is considered an important enabler of mass customization (Blecker and Abdelkafi 2006). This concept is crucial and is often overlooked when considering the design of product families and their assembly systems. Delayed product differentiation is the ultimate merge between product platform design/formation (group of common modules) and assembly line layout (Jose and Tollenaere 2005). It is used to decrease assembly costs by forming product platforms with the maximum number of shared components, which can be customized later to produce different products (He et al. 1998).

In Figure 2.1, Mass Customization is affected by external and internal factors. External factors are related to uncertain customer demands and different user preferences in customizing products. While, internal factors are strongly linked to the company's design features, assembly and production management (Blecker and Friedrich 2006). Product Platform concept is considered an internal factor which has been used practically by a number of known corporations such as Sony (Sanderson and Uzumeri 1995), HP (Meyer 1997), Volkswagen (Wilhelm 1997), and Black and Decker's (Meyer and Lehnerd (1997)). Approaches to produce product platforms are divided into different branches: quantitative (Fujita et al. 1999), (Simpson et al. 2001), (Messac et al. 2002), and (Hernandez et al. (2003)) and qualitative (Martin and Ishii 2002), (Maier and Fadel 2001), and (Park and Simpson 2005)). Forming a product platform means determining two main aspects: product family composition and number of product platforms. Furthermore, a product family depends on several factors including: components commonality, product modularity, and number of product variants. Product platform formation research utilizes commonality measures and indices as well as optimization using different criteria such as maximum commonality or minimum functionality loss.

2.1 Product Platform Concept

Platforms have been categorized according to: modularity, scalability and functionality. Meyer and Lehnerd (1997) defined Product Platform as a: set of sub-systems and interfaces that form a common structure, from which a stream of derivative products can be efficiently produced and developed. Erens and Verhulst (1997) discussed the main concept of product platforms, but called it Product Families Architecture. The authors clearly defined the concept of "Modular Product Platforms", which can produce different products by varying some modular components. Lee and Tang (1997) discussed the implication of applying kits to postpone the differentiation of a large family of three-phase squirrel cage induction motor in MarelliMotori company. Kits refer to a set of components or processes that are represented as one item in the master assembly plan, which corresponds to a catalogue option. Applying kits decreased the time needed to customize motors according to customers' requirements by 85 % than without using kits. Despite that reduction, forming those kits depended only on experience rather than quantitative models. Jiao and Tseng (1999) developed a new approach to design Product Platform Architecture (PFA). That approach is an adaptable version of axiomatic design that depends on Functional Requirements (FR) and Design Variables (DP). Simpson et al. (2001) described another platform type: the Scalable Platform. They proposed a Compromise Design Support Problem Formulation; to design a product family of a universal electric motor by scaling up and down some parameters to produce motors with very similar structures but with variable performance.

Martin and Ishii (2002) developed metrics to assess the generational variety of a certain platform, which is an estimate of the effort needed to convert a platform to a future one. In addition, they described an index which determines the degree of coupling between different components. Jose and Tollenaere (2005) reviewed different methods used in identifying platforms for product families. Group Technology (e.g. MADROC, Production Flow Line, Rank Order Clustering, etc.),

Graph and Matrix Partitioning methods and Mathematical Programming methods were used to produce specific platforms for a group of products. The objective of the product platform research is to increase the common components in platforms, and increase distinctiveness between the derived products at the same time. This necessitates finding new methods to increase product components commonality in platforms while supporting product variety. Jiao et al. (2007) presented a literature survey that discusses and provide futuristic insights on many product platforms attributes: families, architectures, frameworks, product variety...etc.

Tian-Li et al. (2007) applied the Design Structure Matrix (DSM) with a partitioning algorithm using genetic algorithm to produce common platforms for complex products and groups interactions (e.g. a gas turbine platform required 22 cross-functional teams communication within GM corporation). Jiao (2012) formulated a model to integrate marketing, design and manufacturing decisions of product platform planning as a bi-level optimization problem. Jiao's model seeks to maximize the expected profits (first level) while satisfying capacity constraints (second level). Al-Salim and Choobineh (2009) proposed two optimization models (profit maximisation and option-value) to postpone the differentiation of a group of products. They used exhaustive search to solve small-sized problems and Tabu-constrained randomized search to solve large size problems. Their model depends on the assumption of negative correlation between the number of common processing stages of the products family and their market share. In other words, as the number of common processes increases, products become more similar and customers will not want to pay extra money for seemingly similar products.

Ben-Arieh et al. (2009) dealt with the multiple platforms configuration problem and proposed a mathematical formulation to configure single and multiple platforms by adding or removing components to the platform to form the final product. Their model requires specifying the expected number of platforms a priori and it fails to form effective platforms when demand for all products is equal. Furthermore, their model is not scalable and requires a genetic algorithm formulation to solve problems with large numbers of products and components. Lu et al. (2011) devised a cost model including operation delay cost and penalty delay cost, to compare costs of a normally differentiated and a postponed differentiated production of copper strips. The model was only used to compare available redesigned production lines not to obtain new ones. Rojas Arciniegas and Kim (2011) used Design Structure Matrix (DSM), Functional Structure Matrix (FSM) and Genetic Algorithms and proposed an Impact Metric (IM) to determine the optimal set of components to be shared among a group of products. The drawback of these methods is that they are all used in the functional domain. If a capacitor function is shared between products of the same platform it does not necessarily mean that an identical capacitor is used. However, if two products have a capacitor, then they belong to the same family.

According to the product platform literature, it is noticed that in forming the product platform and product family the products in each family and number of families to be assembled using the same platform must be determined a priori and these decisions are not well integrated in selecting the assembly line layout. In most cases, either the number of platforms or families is assumed,

which may produce suboptimal clustering of products. This assumption can undermine delaying the product differentiation which is one of the most important motivations when forming product platforms. Moreover, experience is used heavily in literature to form product platforms. Jose and Tollenaere (2005) suggested that more models and methods must be devised to increase common shared components in a platform, while providing distinctive products that entice customers to pay extra money for product variants. These shortcomings provide grounds for defining new methods and algorithms to deal with the complex issue of product families and platforms design.

2.2 Assembly Lines

The other internal factor is the assembly line layout and the associated incurred costs (Figure 2.1). The cost of assembly is important in determining the final product cost. It accounts for 20% of production costs, 50 % of total production time, and 30 to 50% of labour costs (Nof et al. 1997). In addition to decreasing assembly cost, platforms contribute to: 1) short lead time (Muffatto 1999), 2) customer satisfaction and 3) agility of response to the markets with demand uncertainties and unreliable forecasting (Suh et al. 2007). Assembly line is the group of successive stations used to perform certain assembly tasks to produce the final products. Henry Ford is considered the father of the assembly line concept (Alizon et al. 2009). Salveson (1955) was the first researcher to model assembly lines using linear mathematical programming. Companies are interested in concepts of assembly layouts that are robust in facing changing products and short life cycles. However, conventional assembly layout strategies like: flow line (Burbidge (1963), functional ((Flynn and Robert Jacobs (1986) , Montreuil (1999)), and cellular (Saghiri (2011) cannot deal efficiently with product demand uncertainties. To promote layout and material handling efficiencies, hybrid layout strategies have been developed such as distributed (Montreuil and Venkatadri 1991), Benjaafar and Sheikhzadeh (2000) and Lahmar and Benjaafar (2005)), modular (Irani and Huang 2000)) and agile (Kochhar and Heragu (1999) , Benjaafar (2002)) layouts. These layouts can improve operational performance and encourage the application of delayed product differentiation. Delayed Product Differentiation, if optimally applied, would lead to robust hybrid layout that can robustly respond to customers' requirements (Feitzinger and Lee 1997).

Proposing a layout (pure flow line, cellular, functional...etc.) often depends on the planner choice or a pre-defined layout instead of integrating this decision with product families and platform formation (red arrows in Figure 2.1). This can lead to suboptimal results compared with integrating layout decision with platform formation. In this chapter, a biological approach is used which is employed in evolutionary research of living species. Product modularity and product platforms and families design concepts are integrated into one model to determine the best assembly line layout for delaying product differentiation (blue arrows in Figure 2.1). A model that accounts for important factors such as product platforms and assembly layout strategies will enable efficient delayed product. The proposed biologically inspired model defines the optimal product families and platforms composition and the assembly line layout simultaneously. Using only common components across a certain platform limits the number of products to be derived from it

(Figure 2.1). To avoid this limitation, the principle of assembly/disassembly modular platform first proposed by Ben-Arieh et al. (2009) is used in the proposed model. The assembly/disassembly modular platform formation is analogous to the ancestry estimation in the field of biological and living organisms, which is used to trace their possible evolutionary paths. One of the famous techniques in ancestry estimation is Median-Joining Phylogenetic Network (MJPN) (Bandelt et al. 1999). Examining the literature, although product platform is used to produce multiple products, the authors believe that there is no contradiction when a platform also in the extreme represents one product variant provided that its production volume warrants it. As an example: in the minivan assembly plant in Windsor, Ontario, Canada, there is one platform to serve two models (Chrysler Town & Country and Dodge Grand Caravan). This means that it is economically beneficial to mass produce this platform to get these two models later by customization. Meanwhile, the Bugatti Veyron –for example - has a very special structure that cannot be shared with other cars; hence, it is its own platform. Therefore, the better definition for product platform is that it is the common shared components across a product family that can be economically mass-produced. However, in this chapter, the platform is used to produce different product not only one product.

The MJPN is a quantitative approach which combines several manufacturing concepts including Product Families and Platforms formation, Delayed Product Differentiation, and Product Mix Flexibility is employed to produce an efficient assembly line layout for modular product families (Figure 2.1) that is capable of effective delayed product differentiation. This is the first time that the Phylogenetic Network is used to form product families and platforms for the purpose of delaying the differentiation point. Chapter 2 is organized as follows: first section is the introduction, focused literature of product platform, assembly line and justification of the used method, section 2.3 includes a literature review of delayed product differentiation and the concept of assembly/disassembly platforms and the problem formulation. Finally, a case study, results, discussions and conclusions are presented.

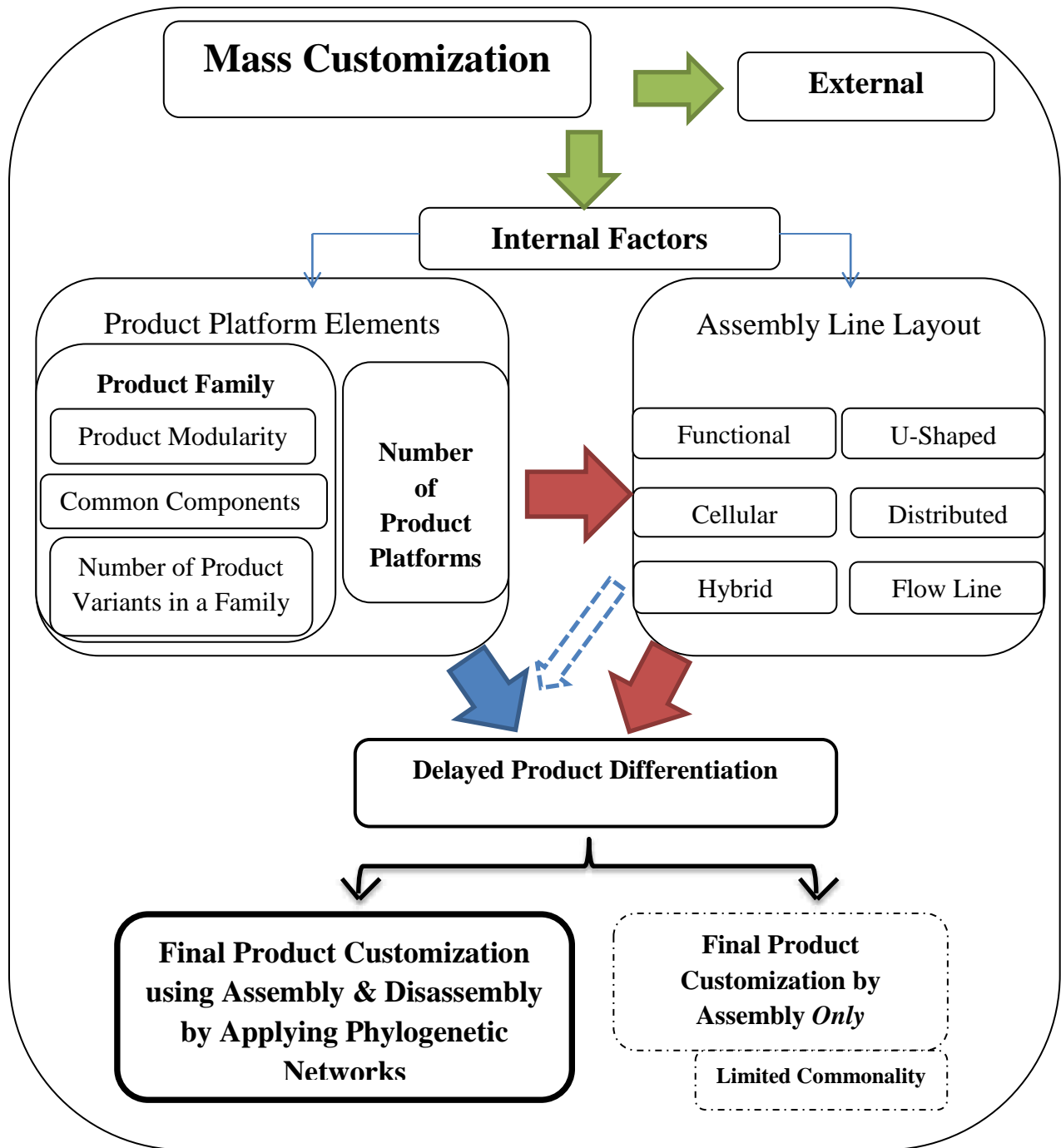

Figure 2.1 Framework of assembly/disassembly product platform customization

2.3 Literature Review

2.3.1 Delayed Product Differentiation

Delayed Product Differentiation (DPD) aims at postponing the final product assembly differentiation point as much as possible (He et al. 1998). Shin and Min (1991) divided

postponement into form postponement (labeling, packaging, assembly, and manufacturing) and time postponement (delaying product distribution until customer orders arrive). A cost model was developed to determine the percentage of postponed production according to the four form postponement aspects. Form Postponement is also defined as a concept which describes activities (components assembly, cloth dyeing) initiated after the arrival of customer orders (Blecker and Abdelkafi 2006). The application of these techniques allows assembly processes standardization, decreases the required workforce, and minimizes the number of working stations. Ulrich and Tung (1991) conceptually discussed one of the most important factors contributing to product variety in general which is Product Modularity. Lee and Billington (1994) discussed and enumerated different direct and hidden cost drivers and strategies that affect design for postponement for product variety. They also classified postponement into time and form types. They discussed the product variety postponement related to initial conceptual design, but did not apply it to producing actual products.

Garg and Tang (1997) proposed a time-correlation statistical model to study the effect of choosing the point of delayed differentiation in three different examples (Watches manufacturing, PC and Macintosh compatible printers and different market segments for a certain hypothetical product) on inventory levels. Their model only discussed two very broad and general factors: product lead time, mean and variance of product demand, and finally inventory level with little attention to differentiating product features; and no assembly line layouts were derived. Lee and Tang (1997) proposed a discrete time event model that captures costs associated with delayed product differentiation and discussed three main specific cases: Product Modularity, Standardization, and Process re-structuring. Their model considers only limited number of parts and processes; any further considerations of more features would greatly complicate the model. This analytical model does not synthesize but rather examines existing or proposed platform solutions. Sparling (1998) proposed a binary decision model to improve a European-based wine supply chain. The decision model helped in choosing the appropriate postponement strategy (e.g. deferred assembly, bundled manufacturing, uni-centric manufacturing, or deferred packaging) using different operational characteristic (e.g. process, technological, or market characteristics, and product differentiation). He et al. (1998) developed a mathematical model to select the optimized sub-assembly in a delayed differentiated product and proposed an equation to test those differential designs against the makespan time of the assembly system. No synthesis is performed by this model; only selection from a pre-determined group of integrated and modular sub-assemblies is carried out.

Swaminathan and Tayur (1998) suggested a stochastic mathematical model that minimises the inventory levels of vanilla boxes (semi-finished goods) which serve as containers for different final products. Their method dealt with similarities between both vanilla boxes contents and the final product requirements. Most of the vanilla boxes experience resources duplication. The content of the vanilla boxes (floppy disk, memory chips, hard drives...etc.) does not constitute a compatible sub-assembly (e.g. floppy disks do not interact or assemble with memory chips). Hence, the model is more suitable for inventory monitoring rather than effective delayed product differentiation.

Scholl and Becker (2006) developed a managerial Postponement/Speculation matrix (P/S matrix) which enlists four generic P/S strategies. Those strategies help in identifying the best actions to achieve economies of scale, scope or both in manufacturing and logistics. Swaminathan and Tayur (1999) improved their previous model by incorporating operations, design, assembly sequences, and life cycle costs. However, this model leads to resources duplications since complete similarity (i.e. every component is in every product) rather than major consensus similarity (i.e. most of components should be shared) is assumed.

Scholl and Becker (2005) surveyed 19 publications on postponement. He identified possible challenges and future research directions which include: postponement as a supply chain concept, integration of supply chain related concepts (JIT, vendor-managed inventory...etc.), postponement on the global supply chain scale (between countries rather than companies), postponement in the customized supply chain, postponement methodological upgrading. Shin and Min (1991) discussed design for postponement enablers: process standardization, process re-sequence, component standardization. They concluded that there is a need to adopt and develop large-scale models, algorithms, and new postponement methodologies that can be integrated in decision support systems. These models will instil the philosophy of product postponement in large corporations. Sparling (1998) used modularization characteristic curve to theoretically analyze the relation between interface constraints and the opportunity for components/systems modularization. The interface constraints represent the combined effect of added-value input, interface compatibility issues, degree of component customization, and mutual supplier-buyer interdependence. Scholl and Becker (2005) noticed apparently conflicting findings in the literature concerning the effect of form postponement on some operational measurements like inventory costs. Therefore, the later authors further classified form postponement into three according to the location of Product Differentiation Activity (PDA) with respect to the order point and the product delivery point. Ko and Jack Hu (2008) proposed a binary integer mathematical programming model; to solve the balancing problem for asymmetrical manufacturing configurations for a product family which shares common initial tasks.

Scholl and Becker (2006) used queuing theory to model six different manufacturing configurations which differ in the position of the delayed differentiation point (before or after order arrival) and the stocking policy (make-to-stock, make-to-order). They tested different queuing parameters (arrival rates, service rates, number of products...etc.) to determine best configuration, stocking policy, and the optimum place of differentiation point. As a drawback, the configurations were previously assumed and the details of the products were on the macro scale not on the components level. Jewkes and Alfa (2009) used a queuing Markov Chain model to test different factors of both suppliers and manufacturers such as customer order fulfillment delay, level of inventories, percentages of unsuitable items produced, degree of semi-finished goods completion. The model did not discuss the details of achieving DPD in manufacturing/assembly, or formation of product families or sub-assemblies to fulfill customer demands. AlGeddawy and ElMaraghy (2010a) proposed a novel technique for delayed product differentiation. They developed a novel

adaptation of Cladistics classification commonly used in biology to identify possible evolution trends for living organisms, by constructing a tree-like structure that groups species by the level of shared characters (ElMaraghy and AlGeddawy 2013). The model identified the expected asymmetric products assembly system layout that uses shared products characters. The resulting cladogram identifies the points of delayed product differentiation and resembles the physical assembly system layout for a set of kettle variants. AlGeddawy and ElMaraghy (2010b) extended this Cladistics model by adding product assembly line balancing constraints to the classification algorithm which resulted in a balanced tree-like system layout; and demonstrated it for the assembly of a set of automobile engine accessories. ElMaraghy and AlGeddawy (2014) proposed a new method combining liaison graphs, design structure matrix and Cladistics, to co-develop master process plan of a product family with different market segment and domains. Song and Kusiak (2010) proposed an evolutionary algorithm to mine historical data of a multi-attribute product demand to minimize the number of assembly operations and costs but did not mention arrangements or the exact combination of the components and modules or consider their assembly layouts. Urban and Wen-Chyuan (2006) provided decision makers with an operational procedure that contains two indices, to discover opportunities of form postponement without large processes re-design. These two indices depend on different times (time of customer order, time of product differentiation activity, maximum time to prepare MPS plan...etc.). The indices do not propose how the product families and platforms will be formed.

Although the research in delayed product differentiation is rich, some research gaps remain. First, most of the statistical and mathematical models used describe macro details (number of products, production rates, general costs, inventories), and they seldom describe the constituent modules of each products. Second, they examine and analyze scenarios instead of selecting the location of the point of delayed differentiation. Third, they do not suggest an assembly line layout rather they assume or use predefined layouts. Fourth, the use of both assembly and disassembly to arrive at the final product variant, which can increase the number of components shared across a product family, is rarely utilized. The concept of assembly/disassembly of components to form product platform is further discussed in the following section.

2.3.2 Assembly / Disassembly Product Platform Concept

Product platforms are essential cornerstone in delaying product differentiation (Feitzinger and Lee (1997). The most common products platform concept assumes only successive assembling or adding of components to a product platform to produce product variants. This assumption may limit the capability of the product platform to include more components that are shared by more products. However, Ben-Arieh et al. (2009) proposed the notion of assembling and disassembling components to and from platforms to customize products. This concept is illustrated in figure 2.2. Three products A, B, and C constitute a product family. Product A, B, and C share common components that form region X. This region is considered the product family platform. The manufacturers may mass produce the platform represented by region X or outsource it. Several differentiating components would be assembled to that platform to form each product. However,

when following the assembly/disassembly technique, the platform is expanded to include region Y, W and Z. For example, all components in Z region are disassembled from the produced platform, and the four remaining components needed for product A are assembled to obtain product A. All W region components are disassembled, and extra six components must be assembled to form product B. For product C, region Y components would be disassembled and additional three components would be assembled. The platforms formed using the modular assembly / disassembly platform strategy tend to include more components compared with the common additive only platform concept. A larger platform means further delaying of product differentiation, which enables mass production of a larger product portion (platform) and, hence, benefiting from both economy of scale for the product platform as well as economy of scope leading to multiple product variants. Disassembled components would be re-used in other product variants. Therefore, this approach is applicable to those components whose assembly is not permanent and can be disassembled safely, which excludes permanent joining methods such as welding, brazing, or riveting. In addition, the total assembly and disassembly time and cost should all be considered when justifying this approach. Many product families can make use of this technique such as: computers, tablets and home appliances, electronic goods, power tools, weighing scales...etc. where the components are modular and easy to assemble and disassemble. The assembly/disassembly of components from a platform to obtain product variant is very similar to the concept of evolution, acquiring and losing characteristics in biological organisms. To trace this kind of evolution, Phylogenetic Networks are used to predict living species' ancestry by linking between them and their descendants through gaining and losing of genes. In section 4, one of the well-known algorithms that construct the phylogenetic network which will be used in this research is discussed.

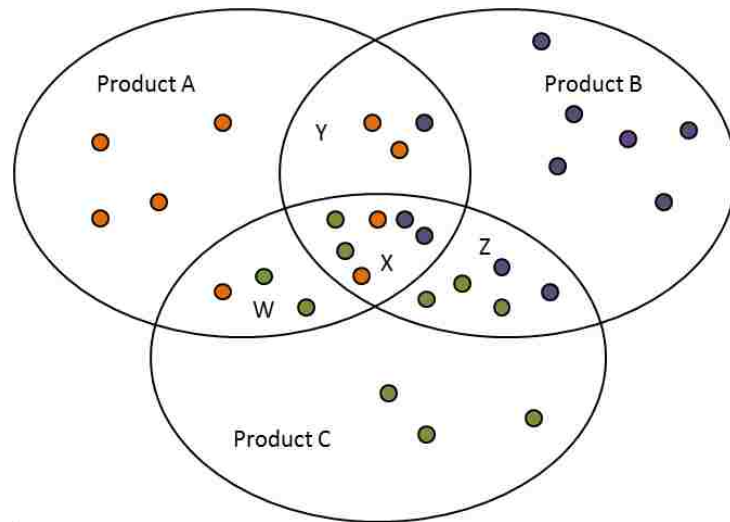

Figure 2.2 Illustration of Assembly / Disassembly Modular Platforms (ADMP)

2.3.3 Median-Joining Phylogenetic Network Algorithm

The definition of Phylogenetic Networks continued to evolve over time due to the large number of the derivatives obtained from the first concept of unity of species origins by Darwin. They are any

type of networks used to depict possible evolutionary paths in any type of sequences (e.g. Mitochondrial DNA). As shown in figure 2.3, there are two main categories: un-rooted and rooted networks. Research has been conducted on constructing the network and inferring some useful and specific relations from its outputs (Bandelt et al. (1999), Polzin and Daneshmand (2003), and Forster et al. (2001)). A comprehensive and useful literature on Phylogenetic Networks can be found in (Huson and Bryant (2006) and Huson and Scornavacca (2011)). Cladistics is a branch of rooted recombination phylogenetic networks. The most related research on assembly system layout design using cladistics is by AlGeddawy and ElMaraghy (2010a) and AlGeddawy and ElMaraghy (2010b).

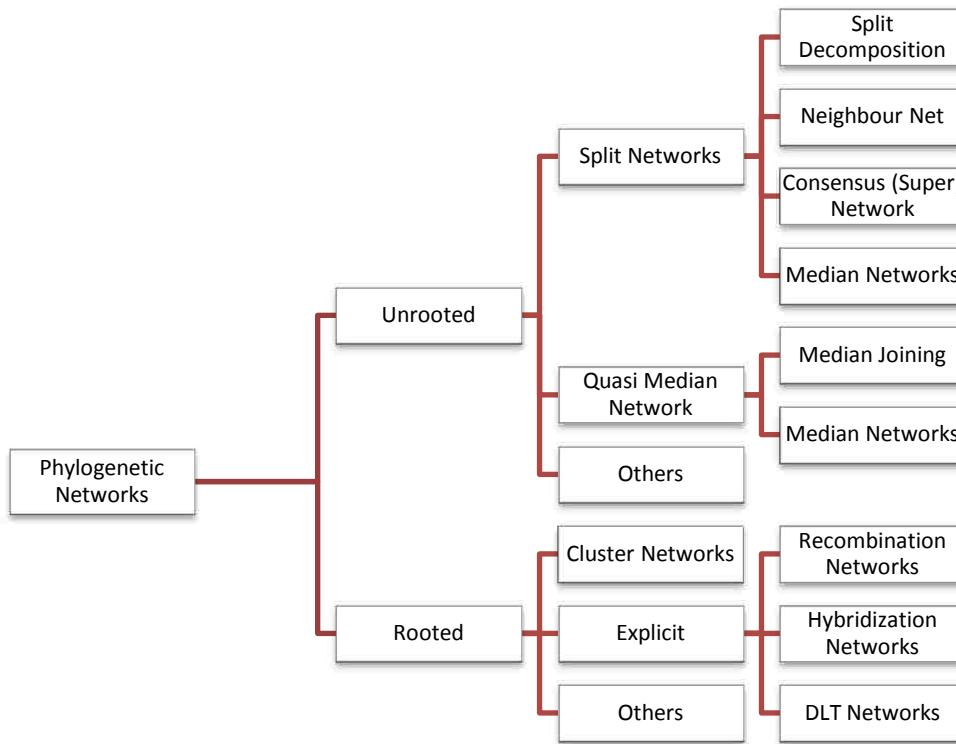

Figure 2.3 Taxonomy of different types of phylogenetic networks (Huson and Scornavacca (2011))

The Median Joining Phylogenetic Network (MJPN) is a branch of un-rooted phylogenetic networks used to trace and classify DNA sequences according to their relation to hypothetical ancestral nodes (median vectors) (Bandelt et al. 1999). Figure 2.4 represents the flow chart used to construct MJPNs; more information and an extra example are included in the appendix. It is worth noting that the flow chart of the MJPN is not mentioned in (Bandelt et al. 1999), but it is explained in wording. By looking at figure 2.5, the used network algorithm produces a network that relates DNA sequences – or products – to each other by Median Vector (MV). It is described in biology as: the ancestral node of a group of sequences (i.e. product variants in chapter 2) by the concept of majority consensus.

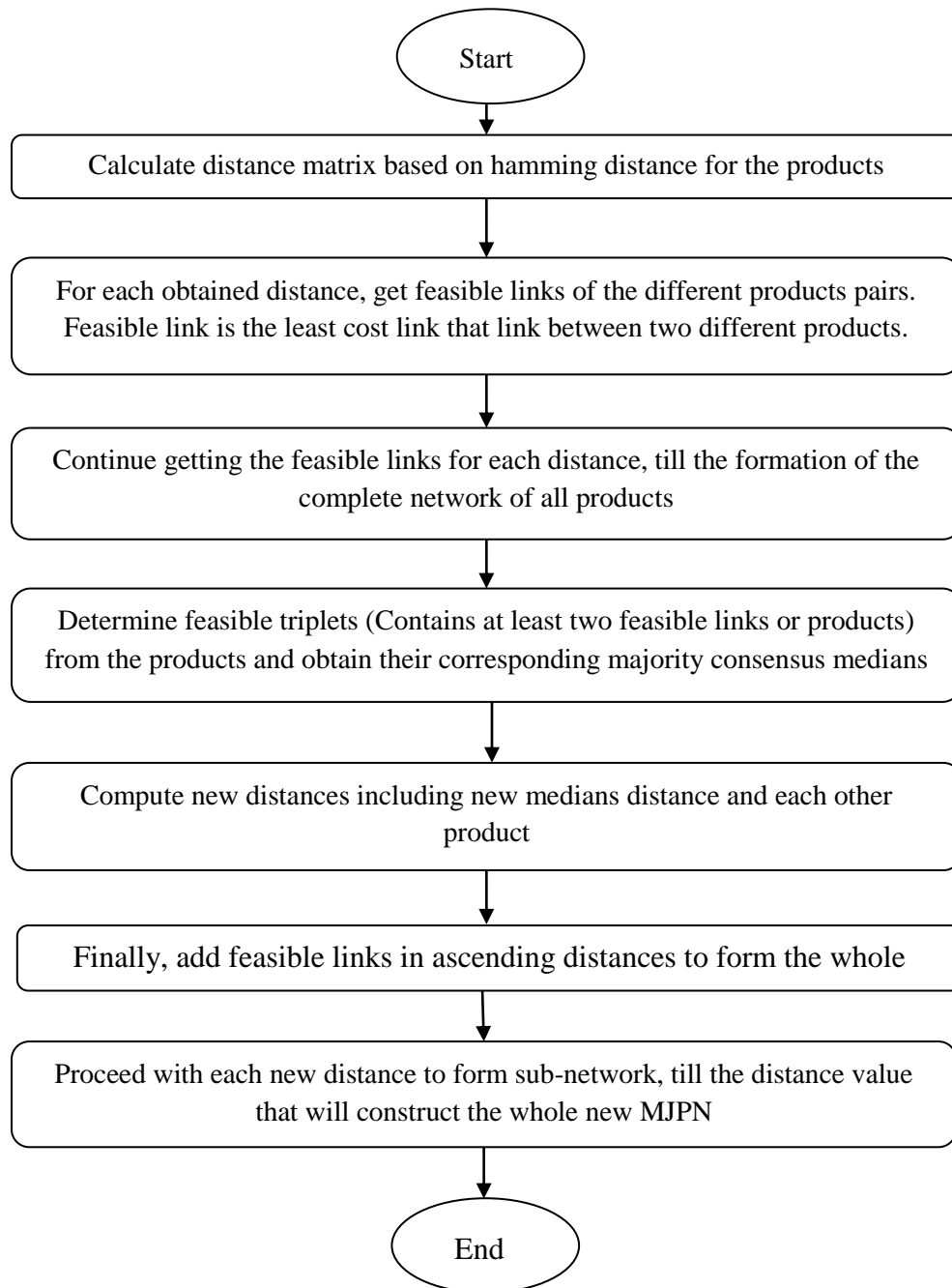

Figure 2.4 Flow chart of MJPN algorithm (adapted from Bandelt et al. 1999)

Majority Consensus median: is the median point that links the three products by a point representing all common parts between products (i.e. the normal family platform) as well as the components that the majority of products possess. Figure 2.5 discusses the relevance of MJPN to platform formation by showing three industrial products (similar to biological descendants) each of which is composed of a binary combination of assembling (adding) or disassembling (removing) a component (gene) from the defining binary string. The platform (M) – the ancestor - is considered the nearest to every product. After the assembly of platform (M), it can be easily used in the

assembly of product (J) by adding the first component, and the assembly of product (L) by adding the third component. Finally, it can produce product (K) by assembling the fifth component and disassembling the second one.

The only common component, using the basic platform definitions in (Meyer and Lehnerd 1997), is the fourth one, which is not enough to be called a platform. Several factors must be considered when using this method for forming product variants:

- Modularity of components
- Standard Interfaces between components
- Assembly / disassembly time ratio
- Presence of demand uncertainty for certain product variants

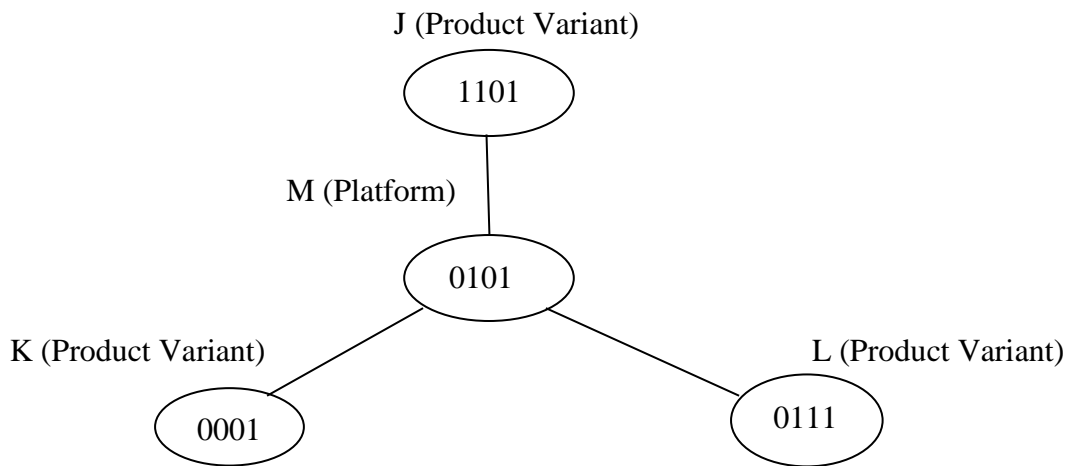

Figure 2.5 Median vector concept adapted from (Bandelt et al. 1999)

Each one of the previous factors influences the feasibility and applicability of the Delayed Product Differentiation Modular Platform Network model. Modularity of parts/components with standard interfaces, which can be easily assembled and disassembled, is essential for the success of the proposed method. A high (or at least equal) ratio of assembly/disassembly time and the time needed to assemble the main product platform is desirable since small assembly to disassembly time ratio diminishes the advantage of the proposed assembly/disassembly product platforms. If the products share many similar components, the majority consensus method will not use the disassembly when customizing the platform (M) – it would favor only assembly.

2.4 Problem Formulation

It is required to find an assembly line layout that is capable of effectively Delaying Product Differentiation for a modular product family using an Assembly/Disassembly Modular Platform (ADMP) derived from majority consensus medians used in MJPN as illustrated in Figure 2.6. The ADMP forms common platforms for different products not only by adding common components

that will be shared by every product, but also by adding components that may have to be disassembled if not needed in a certain product. The objective is to increase the commonality between members of product families, increase manufactures responsiveness and decrease products time-to-market. The components in each product are known but the number of platforms to be formed is not specified a priori – they are determined by the presented algorithm. The field of MJPN is well established with many available software packages. An algorithm adopted from (Bandelt et al. 1999) is utilized through Network 4.6.1 software (Fluxus-engineering.com 2012a) and Bandelt et al. (1999). A small schematic MJPN is shown in Figure 2.6 main block. A1 and A2 nodes refer to the species predicted ancestors (i.e. platforms), while the nodes D1 to D6 represent descendants (i.e. products).

The Network software is used in biology to construct phylogenetic networks, infer potential ancestral points for living species, and estimate time needed for species evolution. Examples may include: amino acids, virus RNA, mtDNA, and also linguistic data. Two main types of algorithms are implemented in the program: First, Median-Joining algorithm which is used to construct a full joined network of species and its inferred ancestry (i.e. products platforms in chapter 2). Second, Reduced-Median algorithm is used to infer the same network but only in case of difficulties in interpreting the full Median-Joining network (Fluxus-engineering.com (2012b)).

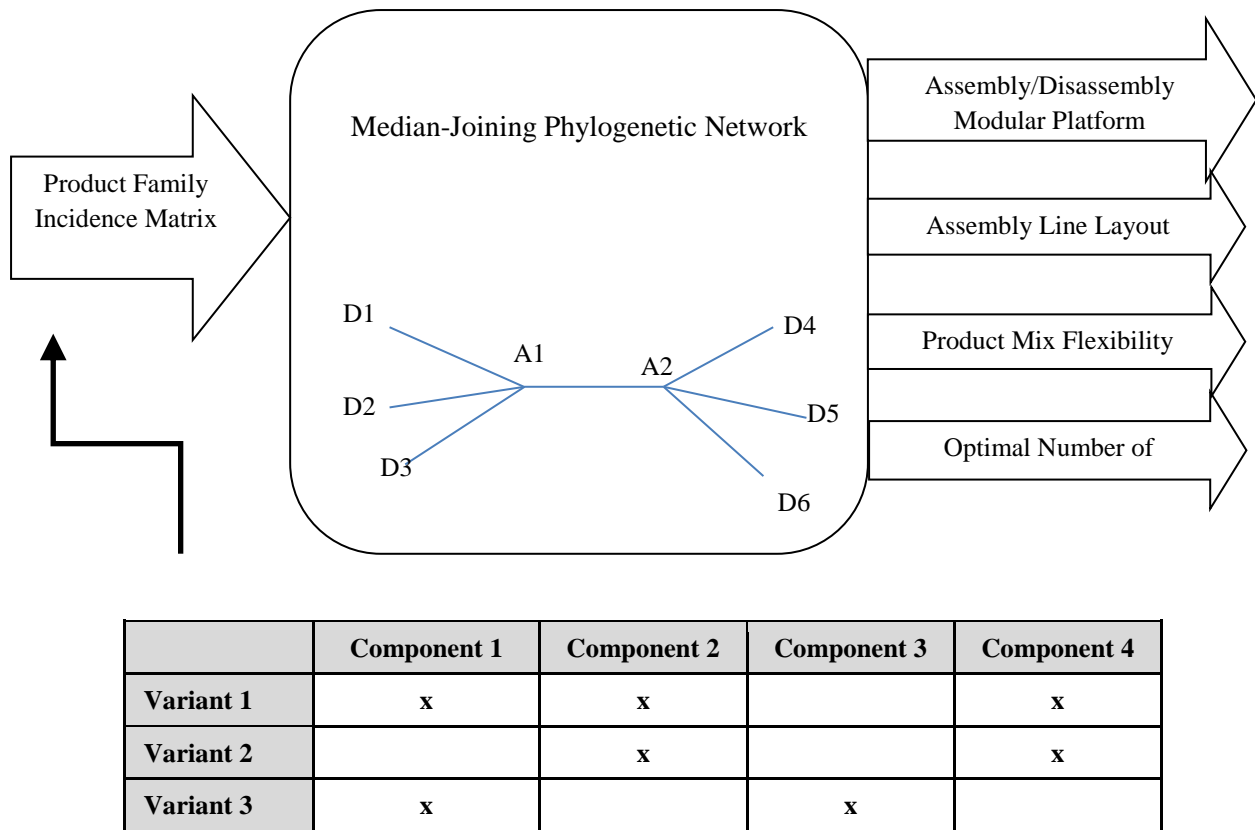

Figure 2.6 Delayed product differentiation modular platform network model

2.5 Case Study

To illustrate the benefits of using Median-Joining Phylogenetic Networks in Product platform formation, assembly line design, and delayed product differentiation, the following group of home appliances is used. Figures 2.7 and 2.8 illustrate a Kettle family which consists of five products; each of which is composed of a combination of 15 differentiating components. The family components incidence matrix describes in detail the constituents of each product. The incidence matrix in Figure 2.6 is the input to the MJPN algorithm for constructing the network. The output is the fully connected network which describes the relations between different product variants in the family and the intermediate majority consensus vectors joining/relating them.

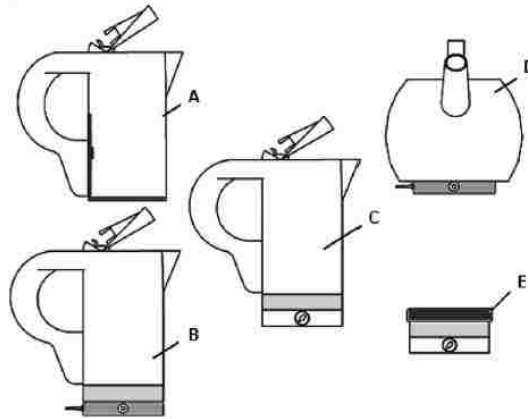

Figure 2.7 The studied kettle's product family (AlGeddawy and ElMaraghy 2010a)

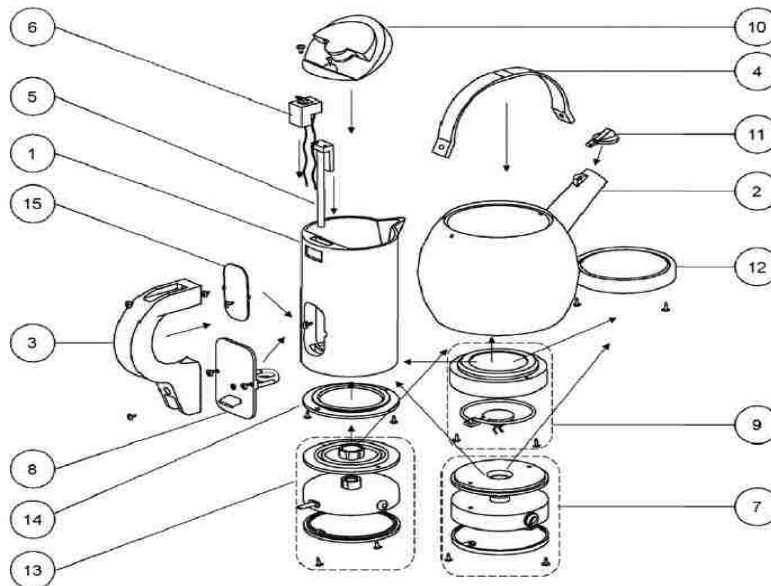

Figure 2.8 Parts used in the kettle product family (AlGeddawy and ElMaraghy 2010a)

Table 2.1 Incidence matrix of the kettles product family

Component Number	Product					
	Component Name	A	B	C	D	E
1	Plastic Body	1	1	1	0	0
2	Metal Body	0	0	0	1	0
3	Plastic Handle	1	1	1	0	0
4	Metal Handle	0	0	0	1	0
5	Boiling Checker	1	1	0	0	0
6	On-Off Switch	1	1	0	0	0
7	Temperature Control Unit	0	0	1	0	1
8	Side Coil Unit	1	0	0	0	0
9	Bottom Coil Unit	0	1	1	1	1
10	Door Unit	1	1	1	0	0
11	Steam Valve	0	0	0	1	0
12	Burner Surface	0	0	0	0	1
13	Detachable Base	0	1	0	1	0
14	Base Plug	1	0	0	0	0
15	Body Plug	0	1	1	0	0

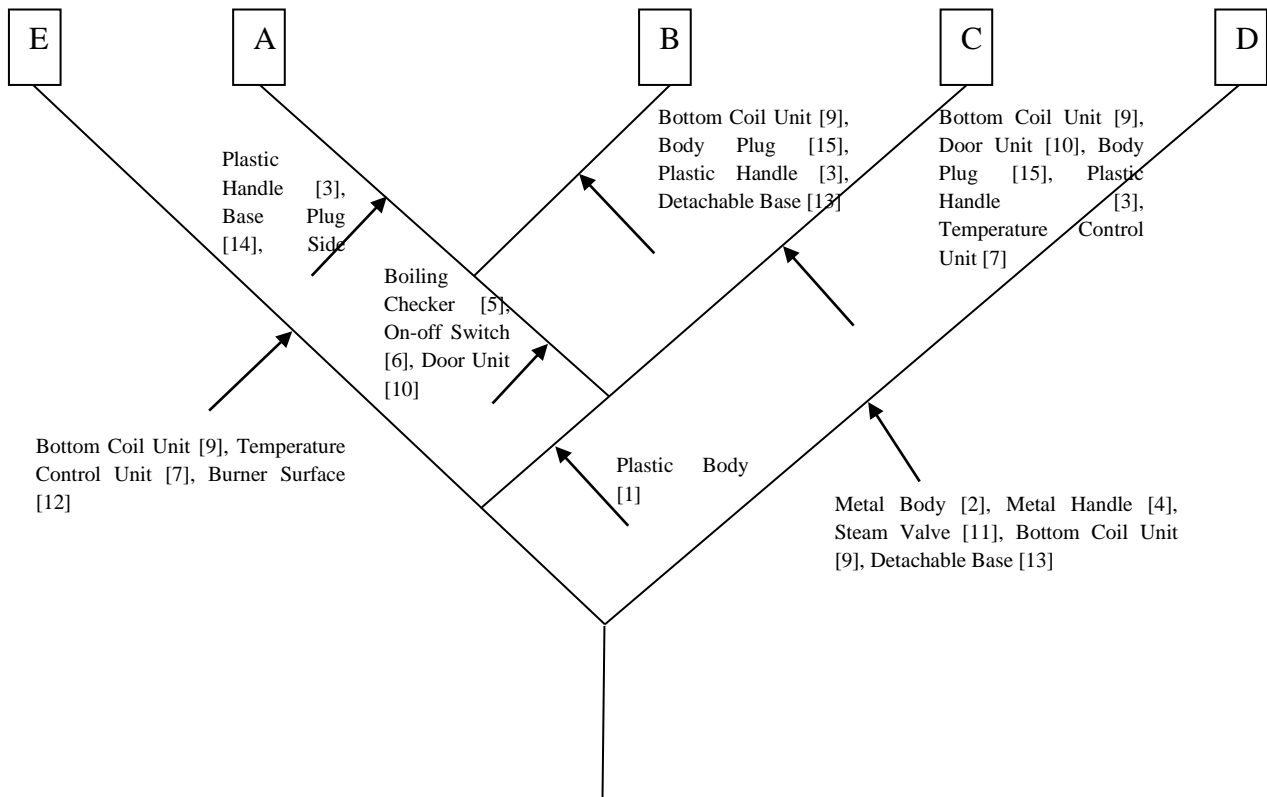
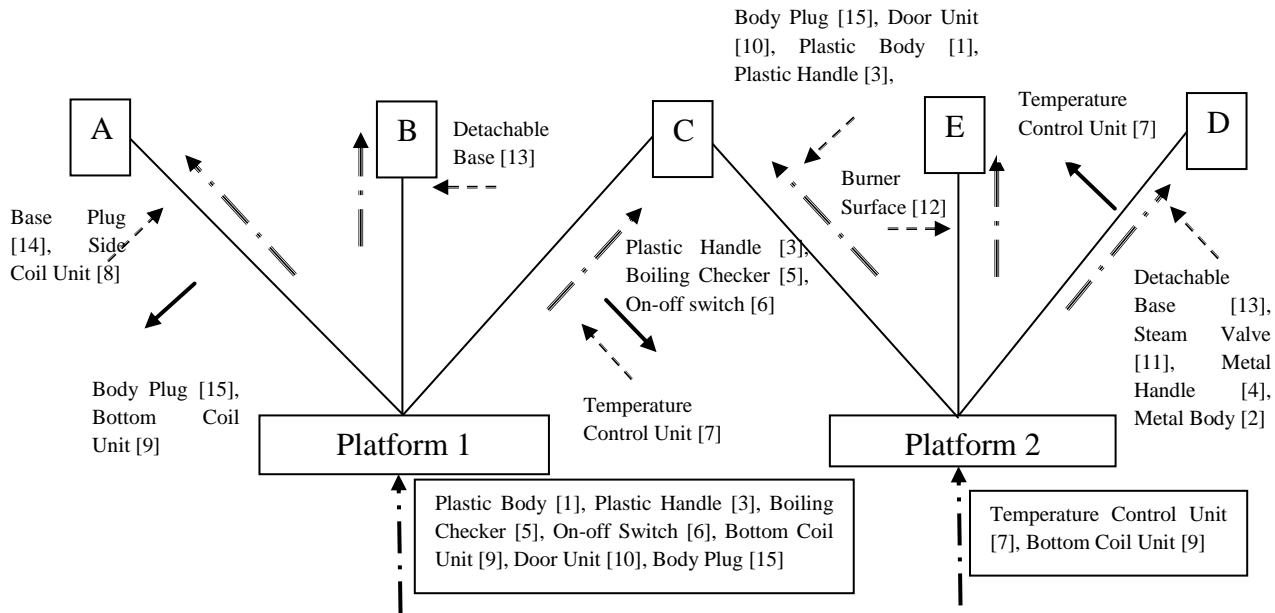

Figure 2.9 A Cladogram showing delayed product differentiation layout (adapted from AlGeddawy and ElMaraghy 2010a)

The Median Joining Phylogenetic Network (MJPN) was used to map the relations between products and their corresponding medians/platforms and the layout. In figure 2.10, two majority consensus medians/platforms were created. The first is the platform and differentiating point for products A, B, and C, and the second platform is used for products C, E, and D. The dash-dot lines represent the direction of assembly, the dashed lines refer to a component assembly, and the thick solid lines refer to component disassembly. After the assembly of the seven components of platform 1, two components (Base Plug and Side Coil Unit) would be assembled / added and both of Body Plug and Bottom Control Unit would be disassembled in order to produce product A.



Legend	
— · — · — · →	Assembly line flow direction
- - - - - →	Components to be assembled
————— →	Components to be disassembled

Figure 2.10 Delayed product differentiation modular platform network model results for the family of Kettles assembly system layout

Only the Detachable Base would be added to platform 1 to obtain product B. Product C requires the disassembly of 3 components (Plastic Handle, Boiling Checker and On-off switch) from the platform 1 and the assembly of the Temperature Control Unit. Product C can be produced using platform 2 (Temperature Control Unit, Bottom Control Unit) by adding three components - Body Plug, Door Unit, and Plastic Body.

Similarly, product E is produced by assembling the Burner Surface to platform 2. Product D is obtained by removing the Temperature Control Unit and assembling the Detachable Base, Steam

Valve, Metal Handle and Metal Body to Platform 2. It should be noted that product D needs more assembly and disassembly work since it has the least number of components shared with the rest of the kettle variants even after using the majority consensus median vector approach. Product C has components which are present in the two families of products (A, B, and C) and (C, E, and D). Therefore, product C may be produced using two different platforms as a base. This offers more flexibility in choosing the platform to use based on the production status and inventory consideration on the shop floor.

Two platforms were created by the MJPN that can be further customized to produce product C. This leads to Product Mix Flexibility - if the demand for product C increases, one or both platforms can be utilized in varying proportions to produce the required quantity of product C at any time. In addition to the economic benefits, this flexibility also contributes to decreasing job boredom on the assembly line and increasing workers' self-satisfaction.

It is informative to compare the results obtained using Cladistics and Delayed Product Differentiation Modular Platform Network model for the same case study. The Cladistics classification approach in figure 2.9 formed only one common platform for products A and B, and a single shared component between products A, B, and C (AlGeddawy and ElMaraghy (2010a) as it tends to share only common parts across different products. In the Delayed Product Differentiation Modular Platform Network model, the network tends to favour the major consensus components and more flexible platforms. Two platforms were identified, the first supports Products A, B and C, and the second supports Products C and E, and share a component with product D. It also provides a natural foundation for applying the assembly/disassembly concept of platform formation. In addition, Cladistics provides different possible cladograms that represent the suggested assembly layout strategies (Jenner (2004) , while MJPN produces a single network that represents the optimal delayed differentiation layout.

To provide a solid basis to assess the quality of the phylogenetic network against other layouts, a metric is devised to measure the ability of three layouts that are capable of delayed differentiation. From the case study, the Delayed Product Differentiation Modular Platform Network model produces more platforms than Cladistics and the other layouts. This increases the Delayed Product Differentiation Modular Platform Network model effectiveness to respond to customers and markets demands by quickly switching between different platforms to produce the required final products.

2.6 Postponement Effectiveness Metric

A new metric is proposed to compare the effectiveness of the Delayed Product Differentiation Modular Platform Network model in postponing products differentiation with other layout strategies (Figure 2.11). Effectiveness is a measure of the extent of delayed differentiation; hence, it can be used to compare results based on different layout strategies. The objective is to maximize the number of components in the core platforms, and increase the number of product variants, while

decreasing the number of different platforms. In addition, the number of components to be assembled or disassembled to obtain a product variant should be minimized.

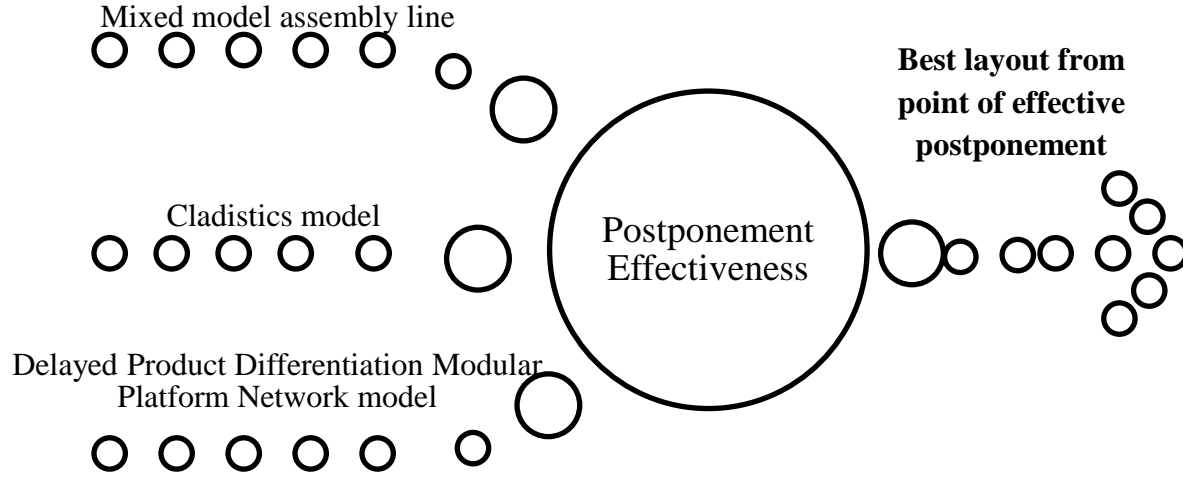

Figure 2.11 Assembly line layouts comparisons regarding postponement effectiveness

The proposed postponement effectiveness metric is a function of multiple factors: 1) Number of components in each platform, 2) Total number of components to be assembled in all platforms, 3) Total number of components to be disassembled from all platforms, 4) Assembly / disassembly times, 5) Number and Quantity of products that exists in a platform, and 6) Number of products that do not have a platform. The metric value is proportional to the number of products not contained in a platform and the total number of assembled and disassembled components after the point of differentiation. The metric is inversely proportional to the total quantity of components in each product, considering the total quantity of the products. Equation 2.1 expresses the delayed differentiation metric as a function of the previously mentioned variables. All other factors are kept constant and represented with constant w in Equation 2.2. This constant w can be used in the future to account for other factors that were not taken into consideration in this research. It is assumed to be constant across all examined layouts; hence, it will not affect the PE values. The metric is used to compare the layouts resulting from applying the various assembly strategies in Table 2.2 and test their effectiveness in postponing product differentiation. It is assumed that the minimum number of components to form a platform is two.

$$\text{Postponement Effectiveness (PE)} \propto \frac{(\varepsilon + \sum_{r=1}^s f_r) \sum_{r=1}^s \sum_{m=1}^n \sum_{p=1}^q Q_r (a_m X_{mr} + d_p Y_{pr})}{(\sum_{r=1}^s Q_r) (\sum_{j=1}^l \sum_{r=1}^s \sum_{i=1}^k t_{ij} Z_{ij} P_{rj} U_{rj})} \quad (2.1)$$

$$\text{Postponement Effectiveness} = w * \frac{(\varepsilon + \sum_{r=1}^s f_r) \sum_{r=1}^s \sum_{m=1}^n \sum_{p=1}^q Q_r (a_m X_{mr} + d_p Y_{pr})}{(\sum_{r=1}^s Q_r) (\sum_{j=1}^l \sum_{r=1}^s \sum_{i=1}^k t_{ij} Z_{ij} P_{rj} U_{rj})} \quad (2.2)$$

Where,

$$X_{mr} = \begin{cases} 1, & \text{if a component } m \text{ is assembled to obtain product } r \\ 0, & \text{otherwise} \end{cases}$$

$$Y_{pr} = \begin{cases} 1, & \text{if a component } p \text{ is assembled to obtain product } r \\ 0, & \text{otherwise} \end{cases}$$

$$Z_{ij} = \begin{cases} 1, & \text{if a component } i \text{ exists in platform } j \\ 0, & \text{otherwise} \end{cases}$$

$$P_{rj} = \begin{cases} 1, & \text{if product } r \text{ is made using platform } j \\ 0, & \text{otherwise} \end{cases}$$

$$f_r = \begin{cases} 1, & \text{if product } r \text{ does not exist in a platform} \\ 0, & \text{otherwise} \end{cases}$$

U_{rj} : Quantity of platform j needed for product r

Q_r : Quantity needed of each product

t_{ij} : Time needed to assemble component i in platform j

a_m : Time needed to assemble component m .

d_p : Time needed to disassemble component p

ε : Constant (≥ 1)

l : Total number of platforms

s : Total number of products

k : Number of components in a platform

n : Number of assembled components

q : Number of disassembled components

This new metric measures the extent of product differentiation delay for each assembly line layout. The postponement effectiveness is decreased as the point of form postponement approaches the last stages of the assembly line, and vice versa. Products differentiation is further postponed by having more commonality in the assembled platforms using the majority consensus concept. The more components in a certain platform, the more it serves diverse products, and the higher the value of the denominator. Therefore, as the value of PE approaches 0, more efficient platforms are produced, which can postpone the products differentiation point effectively.

The developed postponement metric is a relative measure. After PE is calculated for each assembly line layout, the values should be used to compare them. In figure 2.12, the relationship between the point of delayed differentiation and PE values is clarified. The number of components in a platform increases as PE approaches zero. This means more costs reductions, because of the utilization of economy of scale for platform production, and the economy of scope for the delayed differentiated product.

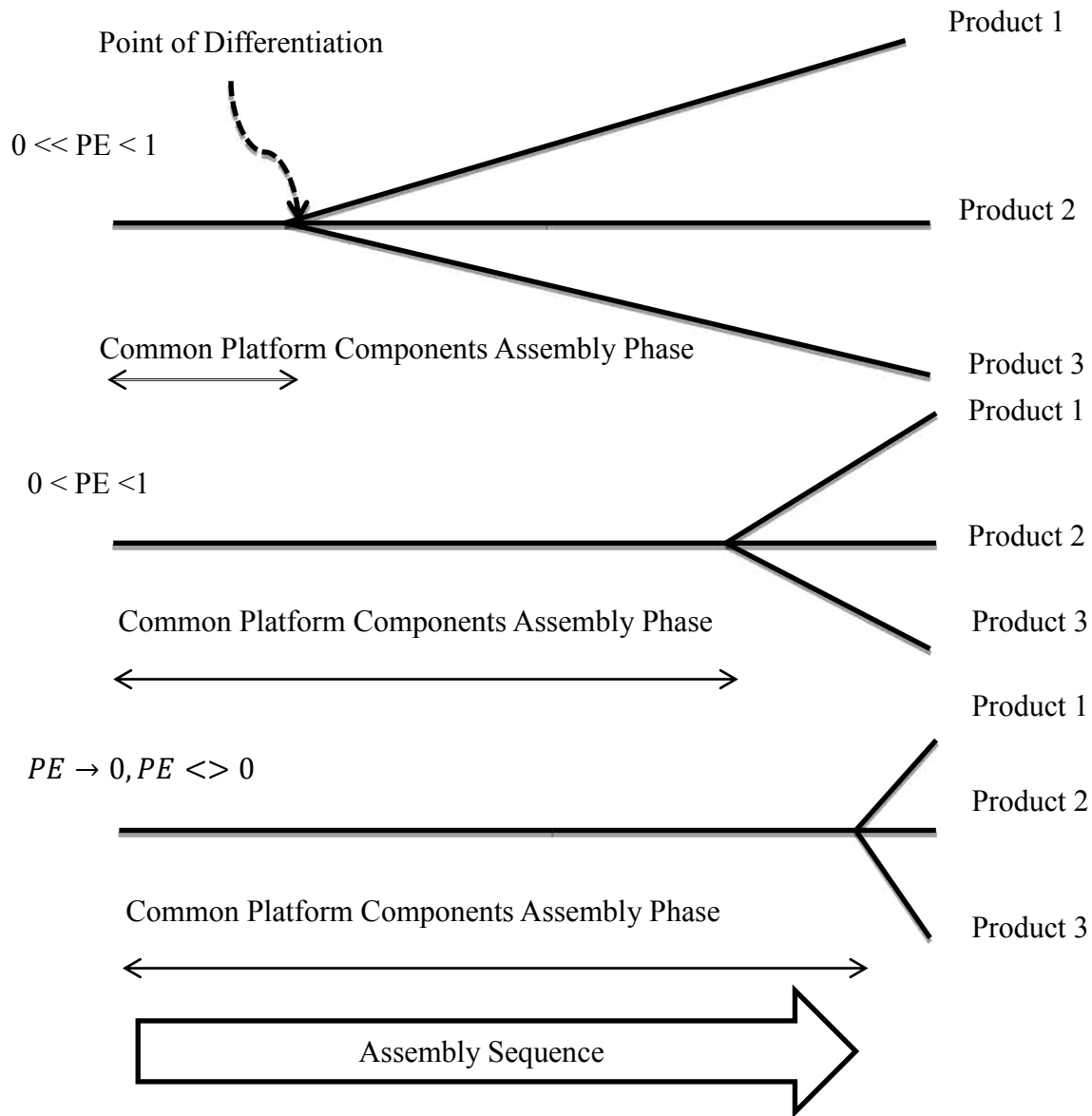

Figure 2.12 Postponement Effectiveness (PE) metric illustration

To test the new PE metric, different assembly layout strategies will be tested namely: mixed model assembly line, Cladistics assembly layout, and the delayed product differentiation modular platform assembly line. These different assembly layout strategies are used to solve the same

product platform formation problem. For the mixed model line; three lines would be needed, one for products A and B, one for C and E, and a third for D. This assumption is based on similarities and shared components between different products. The time of each assembly and disassembly operation is assumed to be one unit (i.e. the same).

Although the mathematical model in Ben-Arieh et al. (2009) uses the principle of product platform customization by assembly and disassembly, it can not solve for more than one platform. Therefore, numerical comparison is not possible between the results obtained using MJPN and those from the model by Ben-Arieh et al. (2009).

To compare between different strategies using the proposed metric, a demand rate of 100, 200, 500, 150, 50 piece is assumed for products A, B, C, D, and E, respectively.

For Mixed model lines (Using customization by assembly only)

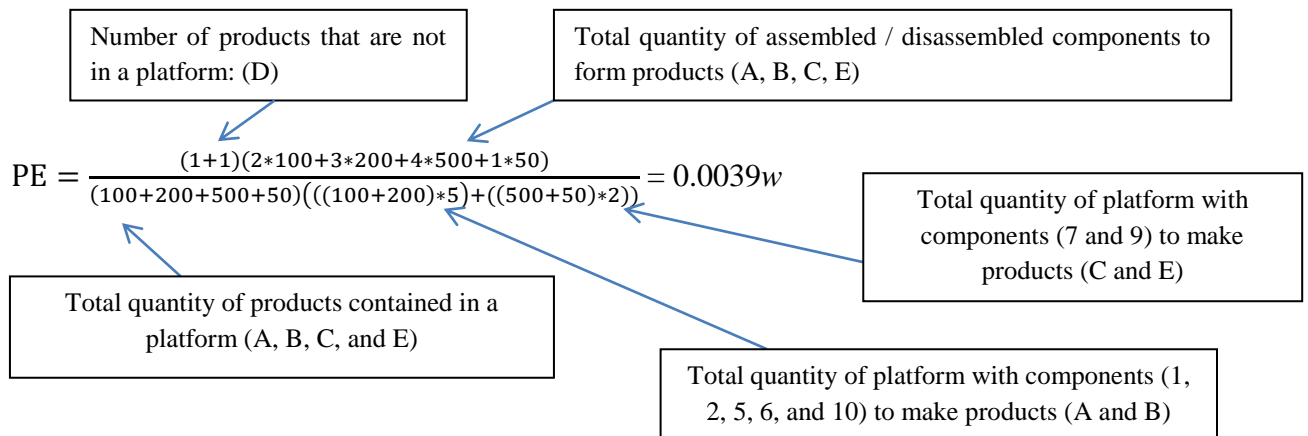

For Cladistics (Using platform customization by assembly only)

$$PE = \frac{(1+3)(100+200)}{(100+200)((100+200)*3)} = 0.048w$$

For the Delayed Product Differentiation Modular Platform Network model using customization by assembly/disassembly concept:

$$PE = \frac{(1+1)(4*100+1*200+4*500+1*50)}{(100+200+500+50)((100+200)*7)+((500+50)*2)} = 0.000487w$$

Regarding the mixed model case, only two platforms exist. The first platform contains five components and serves products A, B, and the second one contains 2 components and serves two other products C and E. Product D does not have a platform. In the assembly layout using Cladistics, the cladogram has one common platform that serves products A and B and contains four components. All other product variants are considered by the cladogram as separate products. This explains the large value of PE for the platform layout design obtained using the Cladistics model. The reason that the value of PE for the mixed model lines is smaller than that for the PE for the Cladistics model is that mixed model lines combined products C and E by their common platform

(Temperature control unit, bottom control unit). In MJPN, product D has one component shared with platform 2 after the removal of Temperature Control Unit (7). As a result, product D is considered a product with no platform when calculating PE for MJPN. Product C can be customized using the two platforms (1 and 2) as it is assumed that it is customised from platform 2. The PE for MJPN layout is the smallest compared with the other two alternatives. This is due to the large number of common components that form the majority consensus platforms (Platform 1(7 components) and Platform 2 (Two components)). Therefore, the products using Delayed Product Differentiation Modular Platform Network model experienced more delayed differentiation. The assembly line layout produced using Delayed Product Differentiation Modular Platform Network model has the best Postponement Effectiveness as one of the formed platforms contains seven components and serves three products. The other formed platform contains two components and serves three products.

Another demand rate is proposed to test the robustness of MJPN to demand rate. Robustness here indicates whether the degree of product platform postponement will be affected by the new demand rates or not. If the PE value is changed to favour another layout, then, the MJPN is sensitive to demand rates. Suppose that the new demand rate for products A, B, C, D, and E is 300, 600, 250, 60, and 100, respectively. The new values of PE for the three strategies are:

$$PE_{Mixed\ model} = 0.0011w$$

$$PE_{Cladistics} = 0.0015w$$

$$PE_{DPD\ platform\ network} = 0.00033w$$

Table 2.2 establishes a comparison between the assembly line layout defined by the Delayed Product Differentiation Modular Platform Network model and other types of assembly line layouts, based on the results and the sensitivity of PE and the MJPN.

The presented Delayed Product Differentiation (DPD) Modular Platform Network model offers many advantages, compared to other layouts strategies regarding decreasing customer order fulfillment delay, and using product platforms and low WIP and finished goods inventories. PE values are directly related to the four measures mentioned in Table 2.2. For the first demand scenario, the PE value of the DPD platform network model (MJPN) is lower compared to other two strategies. This means that the network is able to further delay point of differentiation, and produce sufficient quantity of platforms to cushion against inventory fluctuations which may affect negatively customer order fulfilment. There is no need to stock a large number of different platforms, because the obtained platforms from the phylogenetic network can be used to produce more products than Cladistics or mixed model layout. The ability of MJPN is always higher than mixed model and Cladistics strategies to form platforms. This can be attributed to using the majority consensus in phylogenetic networks. This concept ensures that not only components shared by every product are included in the platform, but also the components that are shared by

most of products as well. Two scenarios were examined, by changing the number of products demand, to test uncertainty of product demand rates. It is found that PE of the DPD platform network is still superior to the other two strategies due to the higher number of the shared components obtained by DPD platform network.

Table 2.2 Comparison between different assembly line layouts including the newly proposed layout

Types of Layouts Strategies Criteria	Mixed Model Assembly Lines	Cladistics Model	Delayed Product Differentiation (DPD) Modular Platform Network model
Customer Order Fulfillment	Delayed	Delay is minimized	Delay is lesser than Cladistics
Inventory Levels (WIP, Finished Goods)	Moderate, Moderate	Low, Moderate	Low, Low
Usage of Product Platform Concept	Possible	Possible	Yes
Robustness to Demand Uncertainty	Moderate	Low	Lowest

Chapter 2 makes several contributions. A new application of Median Joining Phylogenetic Network is proposed, to form product platforms inspired by biological analogies. The commonality between different products is increased by utilizing the principle of sequential assembly and disassembly. The Median Joining Phylogenetic Network algorithm has been applied to combine different concepts of mass customization such as: Delayed Product Differentiation, Assembly Line Layout, and Product Mix Flexibility. A metric is proposed to evaluate and compare the efficiency of platform formation and effectiveness of delayed product differentiation for different assembly lines layout strategies.

Saghiri (2011) relies heavily on qualitative measures such as experience and expert opinions in postponing the product differentiation. However, the three main themes of postponement terms and factors discussed in (Saghiri 2011) are included quantitatively in the proposed PE metric as follows:

- Postponement in terms of time length of the delay (l). In the proposed metric, this is equivalent to total time of assembling the components of a platform and the time of customization.

- Postponement in terms of time length of the delayed activity (d). In the proposed metric, this is the customization time component.
- Postponement in terms of value of the delayed activity (v). In the proposed metric, it is assumed that the value is proportional to the number of components present in each platform. In other words, the more components are included in the platform, the higher the value of the platform.

2.7 Conclusions

Customer demands and changing markets, technology and regulations are strong motivators for the proliferations of products variety. A new Delayed Product Differentiation Modular Platform Network model is proposed. This model uses Median Joining Phylogenetic Network, which is widely used approach in biology. The application of phylogenetic network is novel in the context of product platform design and formation in the manufacturing field. The network is used to form product platforms using principles of sequential assembly and disassembly, and to simultaneously suggest a hybrid assembly line layout to delay the point of product differentiation. This is accomplished by using the majority consensus concept, which includes not only the common shared components across products, but also the most shared ones. The model is able to recommend assembly strategies and associated layouts that are more capable of postponing product differentiation than other types of assembly strategies and their layouts. The used Median Joining Phylogenetic Network is a heuristic technique which can consider large number of products, and form their respective platforms. These platforms contain more common shared components than other methods reported in literature, hence, more delayed point of differentiation is achieved. A new metric of Postponement Effectiveness has been proposed to measure the extent of product postponement. It is found that the metric favours the platforms, families, and the hybrid assembly layout proposed by the phylogenetic network over other methods (Cladistics and mixed line model), due to the sequential assembly/disassembly of the products, which resulted in increased number of components in each platform. This means more commonality is achieved and more components are shared in each given platform by their respective products. Two scenarios were carried out to test robustness of DPD platform network against other layout strategies from the point of demand rate uncertainty. The majority consensus model is not limited to the use of assembly and disassembly strategy, it can also be used when assembly only is used in the platform customization.

The managerial implications of using the developed model for platform formation and assembly strategy and its associated line layout are numerous. First, the use of the assembly/disassembly product platforms is useful particularly in the presence of unpredictable and uncertain market demand for individual product variants as it allows flexibility in meeting actual demands when needed in response to customers' orders. Second, the majority consensus median by nature is a perfect representation of delayed product differentiation. Consequently, in the absence of accurate demands for each product variant, the factory can still utilize workers and machines to produce the majority consensus median product platform to stock for future customization as needed. This

increases factory utilization and responsiveness to fluctuating demands and decreases lead time. Third, manufacturers and managers often guard against uncertainty in demand for various product variants by producing completely assembled variants in anticipation of future orders with the added cost of inventory storage, un-sold products and obsolescence. This will not be the case when using the Delayed Product Differentiation Modular Platform Network model, where the costs of components inventory are decreased through the assembly of platforms that have more common components than other platform formation methods. Hence, instead of assembling totally finished products, only their platforms will be assembled. This supports a more flexible response to any new product mix and increases adaptability to market demand. Using the Median Joining Phylogenetic Network and assembly/disassembly modular product platforms helps mitigate the undesirable effects of varying market demands. Another advantage of using Assembly/Disassembly Modular Platform and Median Joining Phylogenetic Network is the possibility of producing different products using more than one platform. This provides more flexibility in production planning, and increases process planning possibilities. The Phylogenetic Network model in this research does not take into consideration the tooling, fixtures or manufacturing operations cost.

Chapter 3

Modular Product Multi-Platform Configuration Model

3 Introduction

Product variety becomes a necessity in response to market and customers' different demands and changing technological constraints. Customers increasingly ask for more new products the demand for which can fluctuate significantly, which necessitates the development of different concepts to enhance the application of mass customization. The competition to acquire new markets and preserve existing ones requires efficient production methods to decrease costs, while ensuring quality and preventing loss of product functionality. In the previous chapter, the Delayed Product Differentiation Modular Platform Network Model was used to propose a delayed differentiation assembly layout. The proposed layout depended on forming platforms with majority consensus shared components. However, the Delayed Product Differentiation Modular Platform Network model has some limitations: variants demand and various structure precedencies cannot be included. The different costs associated with assembly of platform and its customization need to be considered as well. The model has an algorithmic heuristic nature that does not guarantee optimality as well. Therefore, a well-formulated mathematical model is needed to overcome these obstacles.

3.1 Motivation

The literature revealed that most of product platform formation models do not exploit the principle of assembly and disassembly of components to form customizable product platforms. Moreover, most models assume the number of families and platforms in advance. The only model in the literature (Ben-Arieh et al. 2009) which uses assembly and disassembly of components to form platforms suffers from instability and nonlinearity. Additionally, it cannot deal with large number of products and components without resorting to genetic algorithm. Ben Arieh's model is not able to form platforms and families in cases where demand of one of the products is zero.

3.2 Combined Assembly and Disassembly Concept in Forming Platforms

Product platform formulations are based on determining the set of shared components across a product family. Traditionally, once the product platform representing the products, common core components is produced using mass assembly lines, further products can be derived by adding new components to the existing platform. This provides a certain amount of commonality across different products. To increase this commonality, Ben-Arieh et al. (2009) proposed to use the concept of both assembling and disassembling components to form and customize products platforms as illustrated in Figure 3.1. Thick lines represent the flow direction of assembly line for the product platforms and its variants. The product platform consists of four components: A, B, C,

and D. The assembled platform follows three different paths. The first path produces product variant number one by assembling components E and F to the product platform. The second path produces product variant number two by disassembling component C and assembling component G. The remaining product platforms produced are used to produce product variant 3, by disassembling two components (B and D) and assembling component H. The assembly and disassembly product platform model used to form new products and customize existing platforms has some limitations. First, the assembly should not be permanent (e.g. welding) as customization by disassembly would not be feasible without damaging the product modules. This situation causes the model to favor customization by assembly, which limits of the model flexibility. Second, the platform components assembly cost must be smaller than the cost of customized assembly and disassembly. If the platform components mass assembly cost is high, the model would favors producing each product independent of other products. Small platform assembly costs are achieved by outsourcing platform assembly or by designing a dedicated mass production line for it. Benefits of establishing products platforms are numerous. For scenario, the platform production provides safety for manufacturers against fluctuating market demands. If demand for a certain product is uncertain for a period of time, the manufacturer can still produce and stock the platform. This would help provide a more flexible and adaptable response to future customers orders. The inventory cost is also decreased. This is due to the storing of subassemblies of the produced platforms instead of storing multiple individual components.

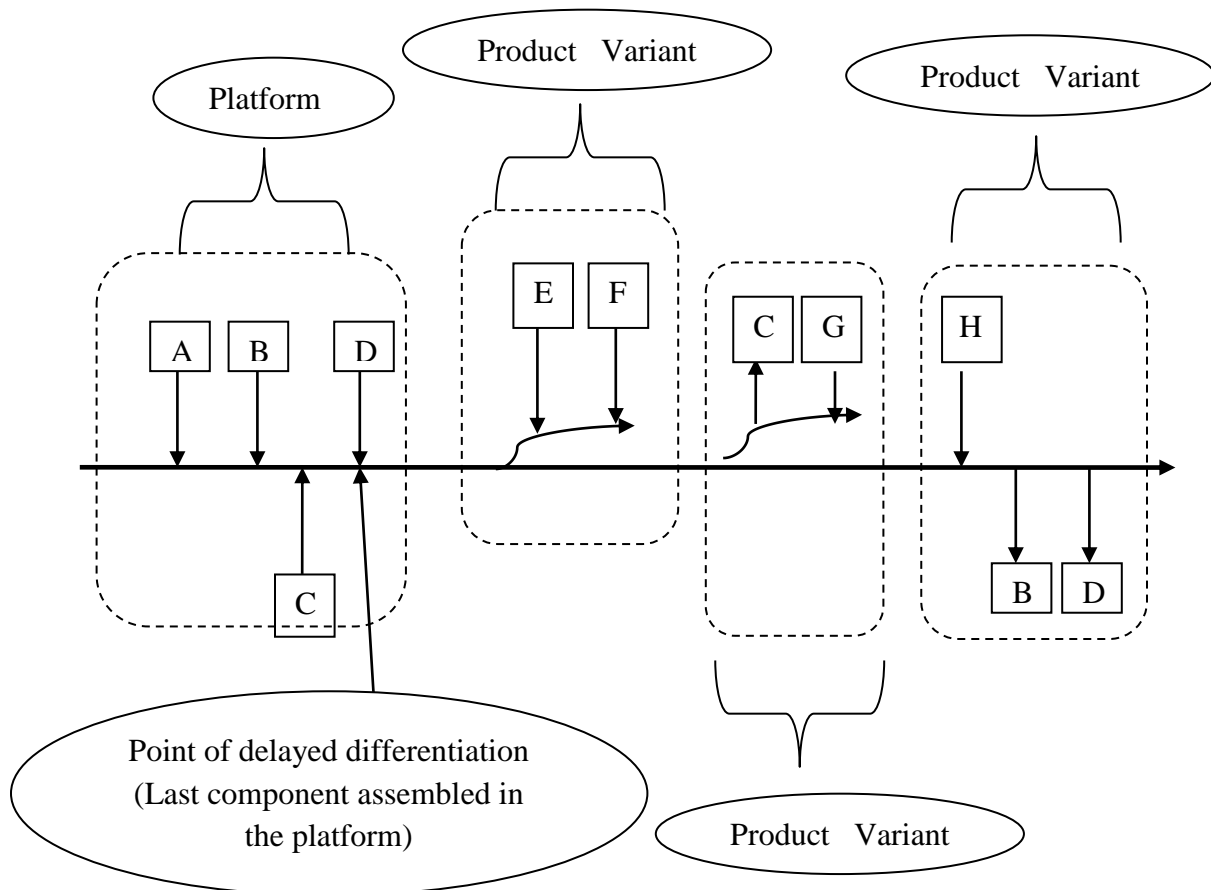

Figure 3.1 Product platform customization by assembly and disassembly of components/modules

3.3 Model Development

Many products are of a modular nature such as power tools, toasters, microwaves, computers, tablets, washing machines and precision weighing scales which consist of numerous components. By changing components in each family, companies can have multiple products that possess different specifications and target different market segments. Customers' demands change frequently. Consequently, product platforms should not be fixed, but rather, changeable and responsive to market demands. The changeability requires different platforms for changed product demands, different costs and product components composition.

The proposed model illustrated in Figure 3.2 combines different concepts into one model. These concepts include: changeable product families (ElMaraghy 2007), changeable product platforms (ElMaraghy 2009), delayed product differentiation (AlGeddawy and ElMaraghy 2010a), and the combined assembly and disassembly for customizing products platforms (Ben-Arieh et al. 2009). The model is computationally efficient and intelligent in dealing with large product families and platforms with complex inter-related components. The optimal number of platforms and families is determined by the model which produces more cost-effective and well-developed optimal solutions.

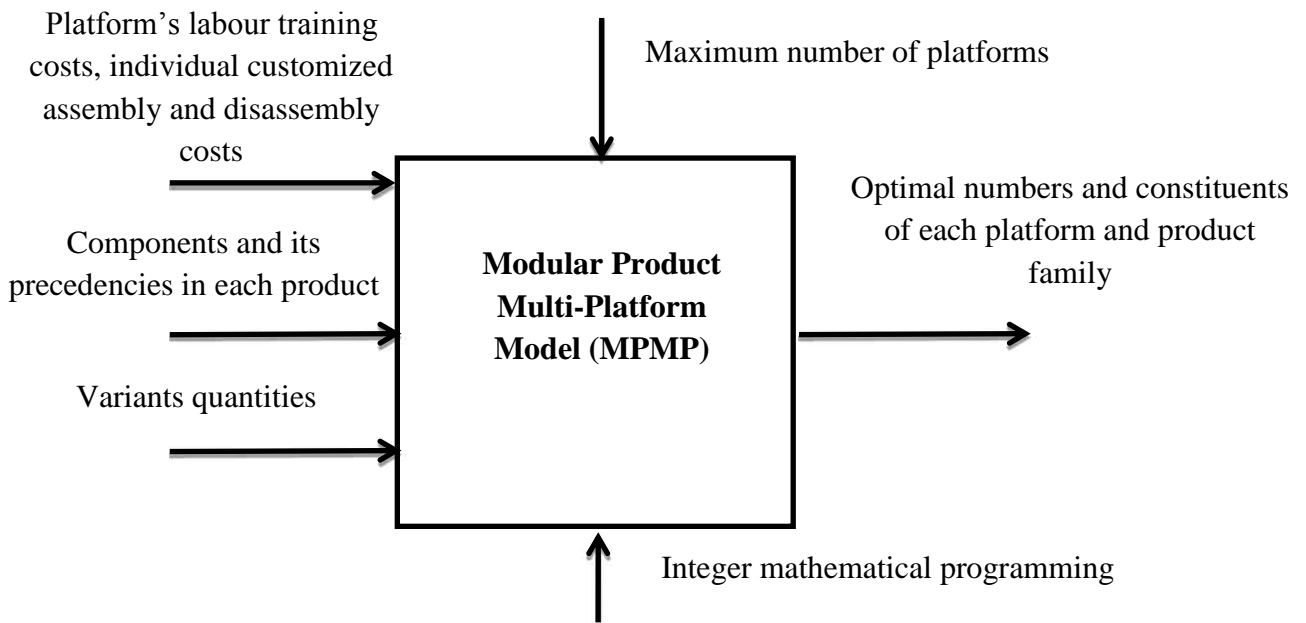

Figure 3.2 IDEF0 of Modular Product Multi-Platform Model (MPMP)

The mathematical model describes the optimization of combinatorial modular platform configuration of a combinatorial nature. The model parameters include:

MC_j : Cost of mass assembling a single component j into a platform

C_j : Cost of component j

AC_j : Cost of assembling component j to customize a certain platform

DC_j : Cost of disassembling a component j to customize a certain platform

c : Cost of labor training to assemble a certain platform type

d_k : Quantity of variant k

l : Maximum number of platforms

m : Maximum number of components

n : Maximum number of products

i : Platform index

j : Components set index

k : Variants set index

$$v_{jk} = \begin{cases} 1, & \text{if variant } k \text{ contains component } j \\ 0, & \text{otherwise} \end{cases}$$

$$p_{kjd} = \begin{cases} 1, & \text{if component } d \text{ succeeds component } j \text{ in variant } k \\ 0, & \text{otherwise} \end{cases}$$

The decision variables are:

$$x_{ij} = \begin{cases} 1, & \text{if component } j \text{ is assembled to platform } i \\ 0, & \text{otherwise} \end{cases}$$

$$y_{ik} = \begin{cases} 1, & \text{if variant } k \text{ is clustered to a family } i \text{ that uses platform } i \\ 0, & \text{otherwise} \end{cases}$$

$$a_{ijk} = \begin{cases} 1, & \text{if component } j \text{ is assembled to platform } i \text{ to form variant } k \\ 0, & \text{otherwise} \end{cases}$$

$$r_{ijk} = \begin{cases} 1, & \text{if component } j \text{ is disassembled from platform } i \text{ to form variant } k \\ 0, & \text{otherwise} \end{cases}$$

$$p_i = \begin{cases} 1, & \text{if platform } i \text{ exists} \\ 0, & \text{otherwise} \end{cases}$$

$$D_{ik} = \begin{cases} 1, & \text{if product } k \text{ has zero demand} \\ 0, & \text{otherwise} \end{cases}$$

$$p_k = \begin{cases} 1, & \text{if product } k \text{ is not in a platform} \\ 0, & \text{otherwise} \end{cases}$$

3.4 Non-Linear Modular Product Multi-Platform Configuration Model

In this section, the nonlinear objective function model is developed. The objective function – excluding last two terms – is adopted from Ben Arieh et al. (2009). New limiting constraints are developed and discussed. The following section describes the methods for the model linearization for performance improvement.

The objective function has four main terms representing the cost of i) platforms components mass assembly, ii) platform customization by components assembly, iii) platform customization by components disassembly, and iv) labor training cost for each platform:

$$\text{Minimize } Z \text{ (Total Cost)} = \sum_{i=1}^l \sum_{j=1}^m \sum_{k=1}^n (MC_j + C_j) x_{ij} y_{ik} d_k + \sum_{i=1}^l \sum_{j=1}^m \sum_{k=1}^n (AC_j + C_j) a_{ijk} y_{ik} d_k + \sum_{i=1}^l \sum_{j=1}^m \sum_{k=1}^n DC_j r_{ijk} y_{ik} d_k + \sum_{i=1}^l P_i c \quad (3.1)$$

Subject to:

$$\sum_{i=1}^l y_{ik} = 1, \quad k = 1, \dots, n \quad (3.2)$$

$$a_{ijk} - v_{jk} + x_{ij} + 1 \geq y_{ik}, \quad i = 1, \dots, l; \quad j = 1, \dots, m; \quad k = 1, \dots, n \quad (3.3)$$

$$a_{ijk} \leq y_{ik}, \quad i = 1, \dots, l; \quad j = 1, \dots, m; \quad k = 1, \dots, n \quad (3.4)$$

$$r_{ijk} - x_{ij} + v_{jk} + 1 \geq y_{ik}, \quad i = 1, \dots, l; \quad j = 1, \dots, m; \quad k = 1, \dots, n \quad (3.5)$$

$$r_{ijk} \leq y_{ik}, \quad i = 1, \dots, l; \quad j = 1, \dots, m; \quad k = 1, \dots, n \quad (3.6)$$

$$1 + x_{ij} \geq f_{kjl} y_{ik} + x_{il}, \quad i = 1, \dots, l; \quad j = 1, \dots, m; \quad k = 1, \dots, n \quad (3.7)$$

$$\sum_{k=1}^n y_{ik} \geq x_{ij}, \quad i = 1, \dots, l; \quad j = 1, \dots, m \quad (3.8)$$

$$\sum_{k=1}^n y_{ik} \geq P_i, \quad i = 1, \dots, l \quad (3.9)$$

$$\sum_{k=1}^n y_{ik} \leq P_i M, \quad i = 1, \dots, l \quad (3.10)$$

$$\sum_{k=1}^n y_{ik} \leq D_{mk}, \quad i, m = 1, \dots, l \quad (3.11)$$

$$p_k \geq 1 - D_{ik}, \quad i = 1, \dots, l; \quad k = 1, \dots, n \quad (3.12)$$

$$D_{ik} \leq d_k, \quad i = 1, \dots, l; \quad (3.13)$$

$$D_{ik} M \geq d_k \quad (3.14)$$

$$p_k \leq 1 - a_{ijk} \quad (3.15)$$

$$p_k \leq 1 - r_{ijk} \quad (3.16)$$

The term MC_j describes the cost of mass production of assembling component j to a platform. The C_j term represents the cost of any component j . The second objective function term explains the costs of assembling extra components into a certain platform to form a product variant. The third term represents the cost of disassembling components from a platform to form another product variant. The fourth term describes the costs of producing multiple platforms (labor training for each platform assembly). This platform term controls the formation of new platforms by the introduction of binary variable P_i , therefore, the target is to minimize the total cost of platform mass production (minimize number of product platforms), components to be added to a platform to form product variants, components to be disassembled from a platform to form a new variant and the costs associated with switching between platforms.

Constraint set (2) assigns each product to at least a single platform. Constraint set (3) determines that if variant k in platform i need component j to be added to the platform i then $a_{ijk} = y_{ik} = 1$. Constraint set (4) determines that if variant k is not in platform i , then no components should be added to that platform to form that product. Constraint set (5) confirms whether product k is in platform i and does not have component j already installed in platform i , then that component should be removed (i.e. $r_{ijk} = 1$). Constraint set (6) is preventing the removal of a component from a platform to form a product, if that component is not in the platform. Constraint set (7) forces the model if component l must precede component j to have component l in case platform i contains a certain product k that contains component j in its structure.

Constraint set (8) ensures that if no product is assigned to a certain platform, then the platform should not contain any components. Constraint set (9) forces the model to not include any platform costs if no product uses that platform. Constraint set (10) allows the presence of any platform which is used to construct at least one product. The set (11) is to ensure the binary nature of all decision variables in the model. Constraint sets (11-16) ensures that products should not be assigned to a platform, if their demand rate is zero.

3.4.1 Linearized changeable modular product platform assembly model

The next step is model linearization. Although only the objective function has nonlinear component, it still leads to a computationally expensive model. A linearization scheme is adopted from Peterson (1971). This linearization is as follows:

If $z * x$ are two multiplied linear variables, with z being a non-negative variable that has an upper bound M (equals 1 in this model, because z is binary), then the product of z and x can be replaced by the linear variable y such that:

$$Mx \geq y \geq z + M(x - 1) \quad (3.17)$$

$$z \geq y \quad (3.18)$$

In the proposed model, every two multiplied variables are replaced by one new variable and two sets of constraints. To adapt the linearization scheme to the model, suppose that variable x has indices i and j (x_{ij}), and variable z has d and k indices (z_{dk}). Accordingly, variable y must have all of their indices (y_{ijk}). Hence, the valid relation between the value of y_{ijk} and the other variables is:

$$Mx_{ij} \geq y_{ijk} \geq z_{dk} + M(x_{ij} - 1) \quad (3.19)$$

The decision variables used in the MPMP model are binary. As a result, all the upper bound M values are one. The above transformation is done on every two multiplied nonlinear variables that exist in the objective function:

$$xx_{ijk} = x_{ij}y_{ik} \quad (3.20)$$

$$xy_{ijk} = a_{ijk}y_{ik} \quad (3.21)$$

$$xz_{ijk} = r_{ijk}y_{ik} \quad (3.22)$$

$$\text{Minimize } Z \text{ (Total Cost)} = \sum_{i=1}^l \sum_{j=1}^m \sum_{k=1}^n (MC_j + C_j) xx_{ijk} D_k + \sum_{i=1}^l \sum_{j=1}^m \sum_{k=1}^n (AC_j + C_j) xy_{ijk} D_k + \sum_{i=1}^l \sum_{j=1}^m \sum_{k=1}^n DC_j xz_{ijk} D_k + \sum_{i=1}^l P_i c \quad (3.23)$$

Subject to:

$$x_{ij} \geq xx_{ijk}, \quad i = 1, \dots, l; \quad j = 1, \dots, m; \quad k = 1, \dots, n \quad (3.24)$$

$$xx_{ijk} \geq y_{ik} + x_{ij} - 1, \quad i = 1, \dots, l; \quad j = 1, \dots, m; \quad k = 1, \dots, n \quad (3.25)$$

$$y_{ik} \geq xx_{ijk}, \quad i = 1, \dots, l; \quad j = 1, \dots, m; \quad k = 1, \dots, n \quad (3.26)$$

$$a_{ijk} \geq xy_{ijk}, \quad i = 1, \dots, l; \quad j = 1, \dots, m; \quad k = 1, \dots, n \quad (3.27)$$

$$xy_{ijk} \geq y_{ik} + a_{ijk} - 1, \quad i = 1, \dots, l; \quad j = 1, \dots, m; \quad k = 1, \dots, n \quad (3.28)$$

$$y_{ik} \geq xy_{ijk}, \quad i = 1, \dots, l; \quad j = 1, \dots, m; \quad k = 1, \dots, n \quad (3.29)$$

$$r_{ijk} \geq xz_{ijk}, \quad i = 1, \dots, l; \quad j = 1, \dots, m; \quad k = 1, \dots, n \quad (3.30)$$

$$xz_{ijk} \geq y_{ik} + r_{ijk} - 1, \quad i = 1, \dots, l; \quad j = 1, \dots, m; \quad k = 1, \dots, n \quad (3.31)$$

$$y_{ik} \geq xz_{ijk}, \quad i = 1, \dots, l; \quad j = 1, \dots, m; \quad k = 1, \dots, n \quad (3.32)$$

$$xx_{ijk}, xy_{ijk}, xz_{ijk} = \{0,1\} \quad (3.33)$$

3.5 Initial Comparison between MPMP Model and Ben Arieh's Model

Table 3.1 lists some of the differences between the two models. The proposed MPMP model has numerous advantages over Ben Arieh's. MPMP has a linear objective function that enables it to solve large number of products and components. MPMP has a new variable which determines the optimal number of the platforms used to derive new products. The platform component in Ben Arieh's model forces the model to use specific number of platforms, whether they are needed or not. The families' variable in Ben Arieh's is not tightly constrained with other model variables. That weak formulation enables variables to take erroneous values and producing inaccurate results. MPMP model can handle periods with no product demand, while Ben Arieh's does not. In Ben Arieh's model, the subtraction of components' costs in the term shown in table 3.1 obtains negative costs and produce platforms with components that can be assembled in different places (Figure 3.4)

Table 3.1 Comparison between MPMP model and Ben Arieh's model

Model Name Point of Comparison	Ben Arieh's Model	MPMP Model
Complexity of objective function	Non-linear	Linear
Number of Platform Determination	Trial and error (In Ben Arieh's model, the platform determination component is $\sum_{i=1}^l A_i$, A is constant equal to platform cost, I: Maximum number of platforms)	New variable introduced to determine optimal number of platforms (P_i)
Assignment of product to family formulation	Weak formulation (y_{ik} is not linked tightly to other variables a_{ijk}, r_{ijk}, x_{ij})	Tight formulation
Ability to handle zero demand products	Cannot handle and will produce erroneous results	Can handle (Constraints 3.12 – 3.16)
Model stability with higher platforms	Not stable and produce negative costs with high number of platforms ($\sum_{i=1}^l \sum_{j=1}^m \sum_{k=1}^n (DC_j - C_j) r_{ijk} y_{ik} d_k$)	Stable model $\sum_{i=1}^l \sum_{j=1}^m \sum_{k=1}^n DC_j r_{ijk} y_{ik} d_k$

3.6 Illustrating Example

A case study is adopted from (Ben-Arieh et al. 2009) for illustration and comparison. A group of similar products in Figure 3.3 are given: 1, 2, 3 and 4. Each product is composed of different structure of components. The components in each product have a certain structure/precedence of assembly and disassembly. It is required to obtain their optimum product families and platforms, and determine which elements should be assembled or disassembled later to/from the different product platforms in order to minimize the considered assembly costs. The components names are: A- B- C- D- E- F- G- H. Their costs in (\$) are: 10-11-12-13-14-15-16-17, respectively.

The precedence relations in Figure 3.3 define the inter-relations between different components in each product. In product 1, components B and C are assembled separately on the base component A. Components D and E are assembled after component B. In product 2, component B and F are assembled on base component A. Then components D and E are assembled afterwards. The same applies in products 3 and 4. It is noteworthy that some components can be assembled in different places. For scenario, component E can be assembled after component B or C. There is no relation of precedence between components at the same level in any product.

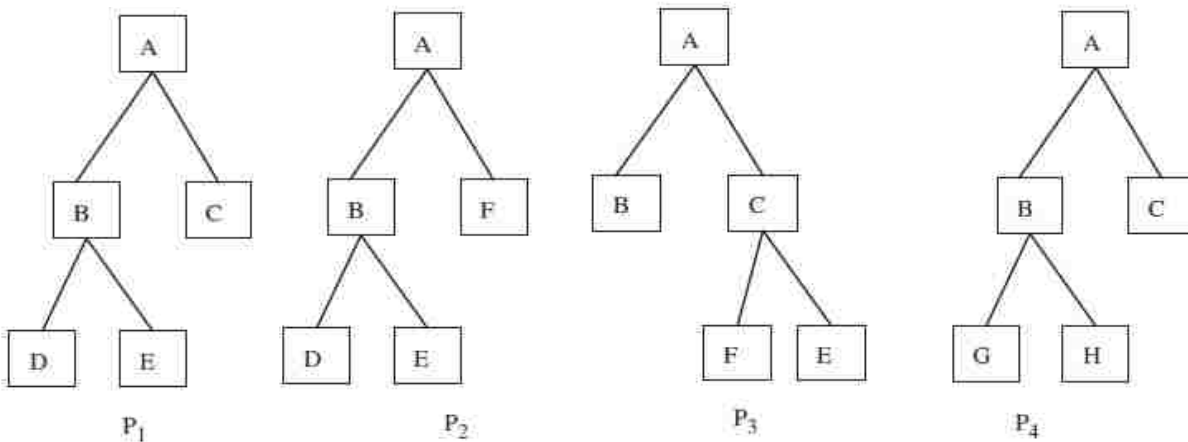

Figure 3.3 Precedence of Product Components (Adopted from Ben-Arieh et al. 2009)

3.7 Results

The mathematical model is implemented using OPL language and solved using IBM ILOG CPLEX Optimization Studio 12.4. A Windows PC with 3.12 GHz Intel Xeon processor and 4 GB RAM is used. In table 3.1, a comparison is made between results from Ben Arieh’s model and the CMPP model. It is worth noting that Ben Arieh’s model has been modified by eliminating the component cost C_j from the third disassembly cost term, to enable models comparisons. The removal of components cost C_j enables the model to solve for more than one platform. Ben Arieh’s objective function reaches negative values when the number of platforms increases. In the first demand scenario in Table 2, the platforms and assembly costs obtained from both models are identical. The second demand scenario, Ben Arieh’s model seemingly having lower cost than the MPMP model is not true. The reason is that his model adds component E to the platform, which is not completely valid. This is because component E can be located at two positions; assembled after components B or C. Ben Arieh’s model treats component E in two different ways; assembled after B for products 1, 2 and assembled after C in product 3, and disassembled for products that do not have them (figures 3.3 and 3.4). This can cause cost calculation confusion for the model in the case of platform (A, B, C, and E). It is not clear whether the platform should be assembled A, B and C—E, or A, C and B—E. In this case, MPMP model discard component C altogether to avoid confusion of component location.

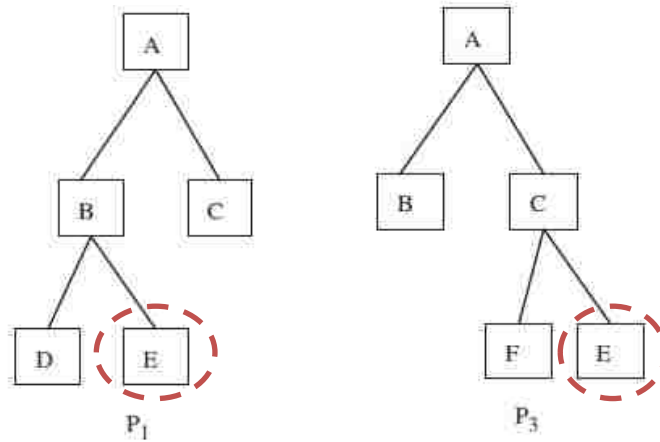

Figure 3.4 Different locations for a duplicate component

The duplicate components inclusion in the platform is not correct because the platform should have one defined structure for the entire family at a certain demand vector. In MPMP, the platform obtained is always valid, where A is the base component, and components B and C are always assembled after A. The third platform obtained coincides with that obtained by Ben Arieh's model. The fourth demand scenario has the same interpretation as the second case. Ben Arieh's model in the fifth demand period did not account for the cost of disassembling components G and H. This is the reason for the higher cost increase obtained using the proposed MPMP model. The matrix obtained of the disassembled components (r_{ijk}) in Ben Arieh's model does not contain components G and H that should be disassembled. This has also decreased the cost compared to the proposed MPMP model. The same comments are true for the remaining three cases. The MPMP model is able to solve some product platform scenarios that Ben Arieh's model cannot. If some products do not have demand, Ben Arieh's model fails to form the remaining platforms and families of other products.

The MPMP model is able to obtain platforms and families in cases 6 and 10 which have a zero demand of products 1 and 2 then products 3 and 4, respectively. The difference in solution time is always in favor of MPMP. Although the MPMP model is more complex than Ben Arieh's model, the entire model is linear.

The number of platforms is set to one as shown in Table 3.2. In table 3.3, the optimal platforms' number is achieved by allowing platforms to vary to its maximum value (number of products). To compare, both models the maximum number of platforms are set to four (maximum number of products). Ben Arieh's model did not converge to a solution even after 24 hours of continuous operation, which is expected given that it is a non-linear model.

Table 3.2 The comparison between the results of Ben Arieh’s model and the MPMP model

Labour Training Cost per Platform	Costs (MC _j , AC _j , DC _j)	Variants Quantities	Ben Arieh’s Model (Single Platform)	Total Cost (\$)	Time (Seconds)	MPMP Model	Total cost(\$)	Time (Seconds)	Difference in Times (%)
1000	2,4,3	[250 250 250 250]	AB	79750	1.52	AB	79750	0.39	74.34
		[700 100 100 100]	ABCE	77500	0.99	ABC	78000	0.38	61.62
		[100 700 100 100]	AB	79900	0.98	AB	79900	0.42	57.14
		[100 100 700 100]	ABCE	78700	1.52	ABC	79200	0.42	72.37
		[25 25 25 925]	ABCGH	80150	1.54	ABCGH	80675	0.43	72.77
		[0 0 700 200]	N/A	N/A	N/A	ABC	67600	0.32	N/A
100	2,4,3	[250 250 250 250]	AB	78850	0.96	AB	78850	0.42	56.25
		[700 100 100 100]	ABCE	76600	0.92	ABC	77100	0.43	53.26
		[25 25 25 925]	ABCGH	79250	1.53	ABCGH	79775	0.97	36.6
		[500 300 0 0]	N/A	N/A	N/A	ABDE	58600	0.33	N/A

This is not the case for the MPMP model. All above cases were solved in less than six seconds. This is a significant saving in computation time and it enables constructing platforms for more complex products. In Table 3.3, the same problem is solved by allowing more freedom in the number of platform. It is noticeable that the total cost of the single platform is larger than that for the multiple platforms. In the first demand scenario, product 3 and product 4 are produced without platforms (i.e. their platforms are the products themselves). Products 1 and 2 share the same platform [A, B, D, and E]. The proposed model always avoids duplicate components that can be assembled at different positions in the platform. This is clear in the previous platform combination, where A, B, D and E have specific assembly positions (i.e. B is assembled after A, D and E are assembled after B). For the second demand vector, products 1 and 2 must be produced separately, and products 3 and 4 use the same platform [A, B, C].

Table 3.3 Results of the MPMP model using multiple platforms

Labor Training Cost per Platform	Costs (MC _j , AC _j , DC _j)	Demand	Variants Quantities	Multiple Platform	Total multiple cost (\$)	Time (Seconds)
1000	2,4,3	1	[250 250 250 250]	- Products 3 and 4 are in separate platforms. - Products 1 and 2 are in same platform [A, B, D, and E].	76750	3.65
		2	[700 100 100 100]	- Products 1 and 2 are in separate platforms. - Products 3 and 4 are in the same platform [A, B, C].	74900	4.82
		3	[100 700 100 100]	- Product 2 is in separate platform - Products 1, 3, and 4 are in the same platform [A, B, C]	76100	4.85
		4	[100 100 700 100]	- Products 3 and 4 in separate platform. - Products 1 and 2 are in the same platform [A, B, D, and E].	75700	5.32
		5	[25 25 25 925]	- Product 4 is in separate platform. - Products 1, 2, and 3 are in the same platform [A, B].	78125	5.38
100	2,4,3	6	[250 250 250 250]	All products are in separate platforms.	73150	4.75
		7	[700 100 100 100]	All products are in separate platforms.	71500	3.72
		8	[25 25 25 925]	- Products 3 and 4 are in separate platforms. - Products 1 and 2 are in the same platform [A, B, D, E]	76075	5.35

For the third demand scenario, product 2 is done separately and products 1, 3, and 4 are produced using platform [A, B, C]. The fourth demand scenario has a solution similar to the first demand scenario with respect to composition of the resulting platforms and the products assigned to each platform. Fifth demand scenario has products 1, 2 and 3 produced by platform A and B, and product 4 - with the highest demand – produced on a separate platform. As the cost of labor training

decreases, both the sixth and seventh demand scenarios result in a separate platform for each product. The last demand scenario, products 1 and 2 with much similar structure share platform [A, B, D and E], meanwhile, the large demand of product 4 and the different structure of product 3 forces the model to produce each one of them separately. In his paper, Ben Arieh proposed a genetic algorithm to solve the same platform configuration problem. His developed genetic algorithm could not be reproduced, because some internal correction and assignment algorithms inside his GA are not sufficiently mentioned.

3.8 Case Study

A case study of touchscreen tablets product family is used to demonstrate the Modular Product Multi-Platform Configuration model (Figure 3.5). The tablets have different structures and different components resulting in 3 product variants. The inputs to the MPMP model are as follows:

- $MC_j = \$3.5$
- $AC_j = \$4.25$
- $DC_j = \$4.25$
- $c = \$1500$
- Maximum number of platforms = 10

Figure 3.6 shows the precedence relationships of the different components of the touchscreen tablet family. The used motherboard has three different variants and the speaker has two alternatives. Table 3.4 enumerates the components used in each tablet in the family including the cost.



Figure 3.5 Touch Screen 7'' tablet

Table 3.4 Costs and composition of each tablet

No.	Components	Cost(\$)	P1	P2	P3	P4	P5	P6	P7	P8	P9	P10
1	Steel Mid Frame	4	x	x	x	x	x	x	x	x	X	x
2	Battery 1 (4400 mAh)	16.5	x		x	x		x				
3	Battery 2 (8000 mAh)	30		x			x		x			
4	Battery 3 (10000 mAh)	38								x	X	x
5	Touchscreen Controller	3	x	x	x	x	x	x	x	x	X	x
6	Power Button	2.5	x	x	x	x	x	x	x	x	X	x
7	Default Speaker Assembly (Variant 1)	13		x		x		x	x	x		
8	Double Stereo Speaker Assembly (Variant 2)	10	x		x		x				X	x
9	Capacitive Front Panel Assembly	30	x			x	x	x	x	x		
10	Resistive Front Panel Assembly	42		x	x						X	x
11	Mother Board 1 (1Ghz Dual Core Processor, 512 Mb DD2 RAM, 8 Gb Flash Memory)	64.5	x			x	x					
12	Mother Board 2 (1Ghz Dual Core Processor, 2 Gb DD2 RAM, 8 Gb Flash Memory)	80		x				x	x	x		
13	Mother Board 3 (1.5Ghz Dual Core Processor, 1 DD2 RAM, 16 Gb Flash Memory)	95			x						X	x
14	LCD Display	38	x			x	x	x				x
15	LCD with IPS Display (Wide view)	47		x	x				x	x	X	
16	Back Cover	6	x	x	x	x	x	x	x	x	X	x

In Table 3.5, the first demand scenario for the touch screen tablet has seven platforms. The first platform serves a product family of products 1, 4 and 5. The platform contains components [1, 6, 9, 11, and 14] (i.e. steel mid frame, motherboard 1, power button, LCD normal display and front panel assembly). It is noticeable that the demand for the three product variants is similar and their constituent components are very close.

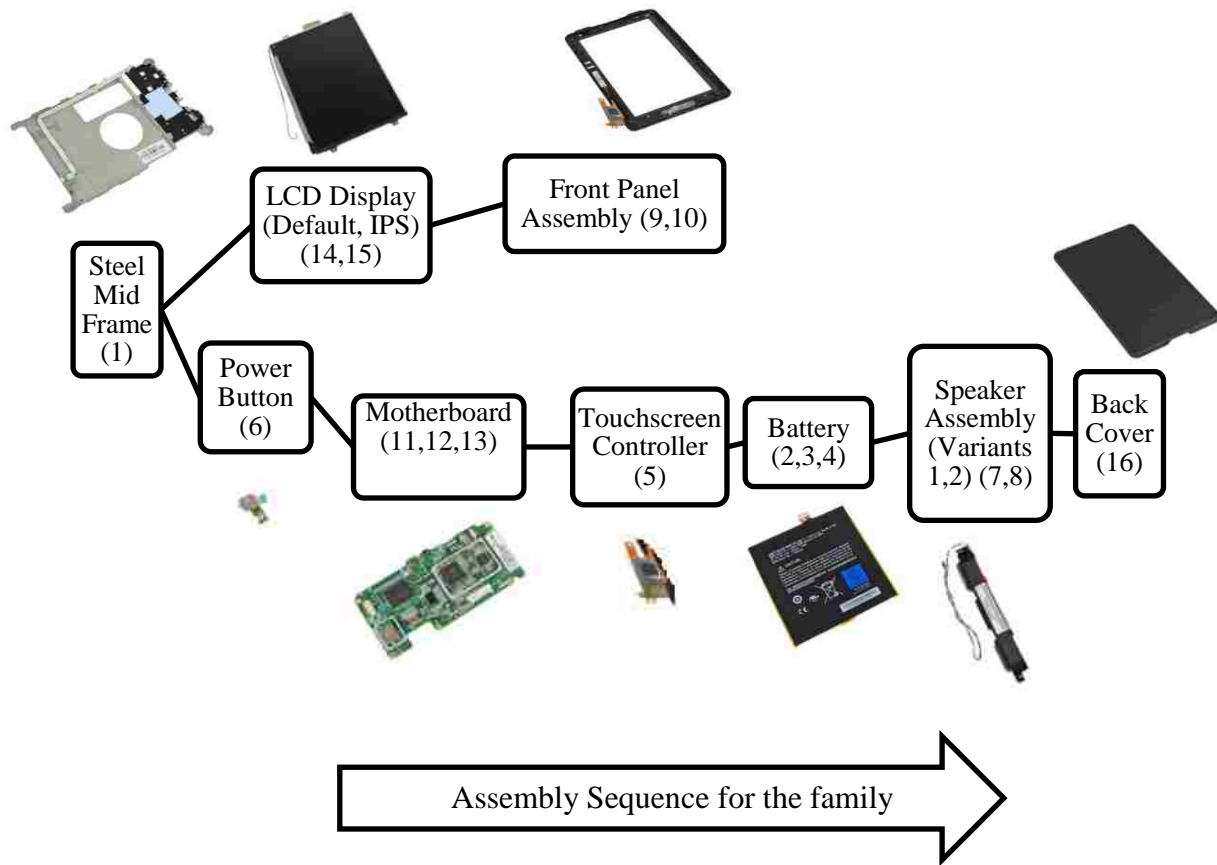

Figure 3.6 Assembly Precedence Diagram of the touchscreen tablets family

Hence, the model suggested a common platform for all three variants. The other products (products 2, 3, 6, 7, 8, 9 and 10) must be mass-produced independently in separate platforms. In the second demand scenario, the number of the product family members increased and changed from 1, 4 and 5 to 3, 4, 5 and 7, but the count of shared components decreased. The same result is obtained in demand scenario 5 but with different product family members; whereas the most shared components are the steel mid frame and the power button. The great variation in demand in Case 3 favors each product being produced separately. Case 4 resembles Case 1, with the exclusion of component 11 (Motherboard 1) because product 6 contains motherboard 2 instead of motherboard 1.

Table 3.5 Optimal multiple platforms and product families

Demand	Quantities	Multiple Platform	Total Multiple Cost	Time (Seconds)
1	[100 700 100 100 100 200 1000 300 400 800]	- Products 1, 4, and 5 are in one platform with components [1, 6, 9, 11, 14] - All other products are in separate platforms.	953300	25.33
2	[100 800 100 100 100 3000 1000 3000 6000 900]	- Products 3, 4, 5, and 7 are all in one platform with components [1, 6] - All other products are in separate platforms.	3893175	11.78
3	[1000 7000 100 900 500 200 1000 300 4000 800]	- All products are in separate platforms.	4031900	19
4	[500 700 100 100 100 200 1000 300 400 800]	- Products 4, 5, and 6 are all in one platform with Components [1, 6, 9, 14] - All other products are in separate platforms.	1036300	40.57
5	[800 100 100 100 100 2000 1000 300 400 300]	- Products 2, 3, 5, and 7 are served by one platform of components [1, 6] - All other products are in separate platforms.	1178175	45.65
6	[100 700 200 500 700 700 7000 3000 400 800]	- Products 3 and 9 use one platform of components [1, 5, 6, 10, 13, 15] - All other products are in separate platforms.	2996050	12.07

The model finds that it is more cost optimal to exclude the motherboard component altogether, and assemble it later. Despite the products complexity, the model is able to efficiently obtain optimal families and platforms since meta-heuristics were not needed.

3.9 Performance Evaluation

3.9.1 Cost components

A model performance evaluation was done using the assembly, the disassembly and the platform costs, plotted in four different graphs was done to measure their effects on the total considered cost.

In Figure 3.7a, the increase in the assembly cost directly increases the overall cost. This is because in many demand scenarios, the model uses the assembly for customizing product platforms more frequently compared to disassembly. For any increase in the assembly cost of component (AC_j), the total cost is directly affected. This is the same case in Figure 3.7b, but the horizontal axis here is c (labour training costs to assemble new platforms). This is logical as the increase in the cost of training for platforms must increase the total assembly costs.

It is required to test the effect of changing of (DC_j) on the total cost. Figure 3.7c, using demand scenario 6, shows that the disassembly cost increase does not affect the total assembly cost. In this demand scenario with the existing assembly and components parameters, the model favors not to use customization by disassembly because of the high components costs and low customization by assembly costs.

To determine cases which the model uses customization by disassembly, three parameters in scenario 6 are changed: components costs, allowable number of platforms and customization by assembly costs. The new components costs for components 1, 2, 3, 4, 5, 6, 7, 8, 9, 10, 11, 12, 13, 14, 15 and 16 are given as 4, 5, 3, 3, 3, 5, 4, 4, 4, 4, 4, 4, 4, 4, 4 and 6, respectively. Allowable number of platforms = 9 and customization by assembly cost = 9. The model determines that product 1 and 4 are in single family using a platform with components 1, 2, 5, 6, 8, 9, 11 and 14. Product 4 does not contain component 8. Therefore, to derive product 4 from the obtained platform, component 8, Double Stereo Speaker Assembly (Variant 2), has to be disassembled. This example provides insights on when the customization by disassembly is activated. Decreasing number of allowable platforms and components costs and increasing the customization by assembly costs promote the use of disassembly of components to derive products from platforms.

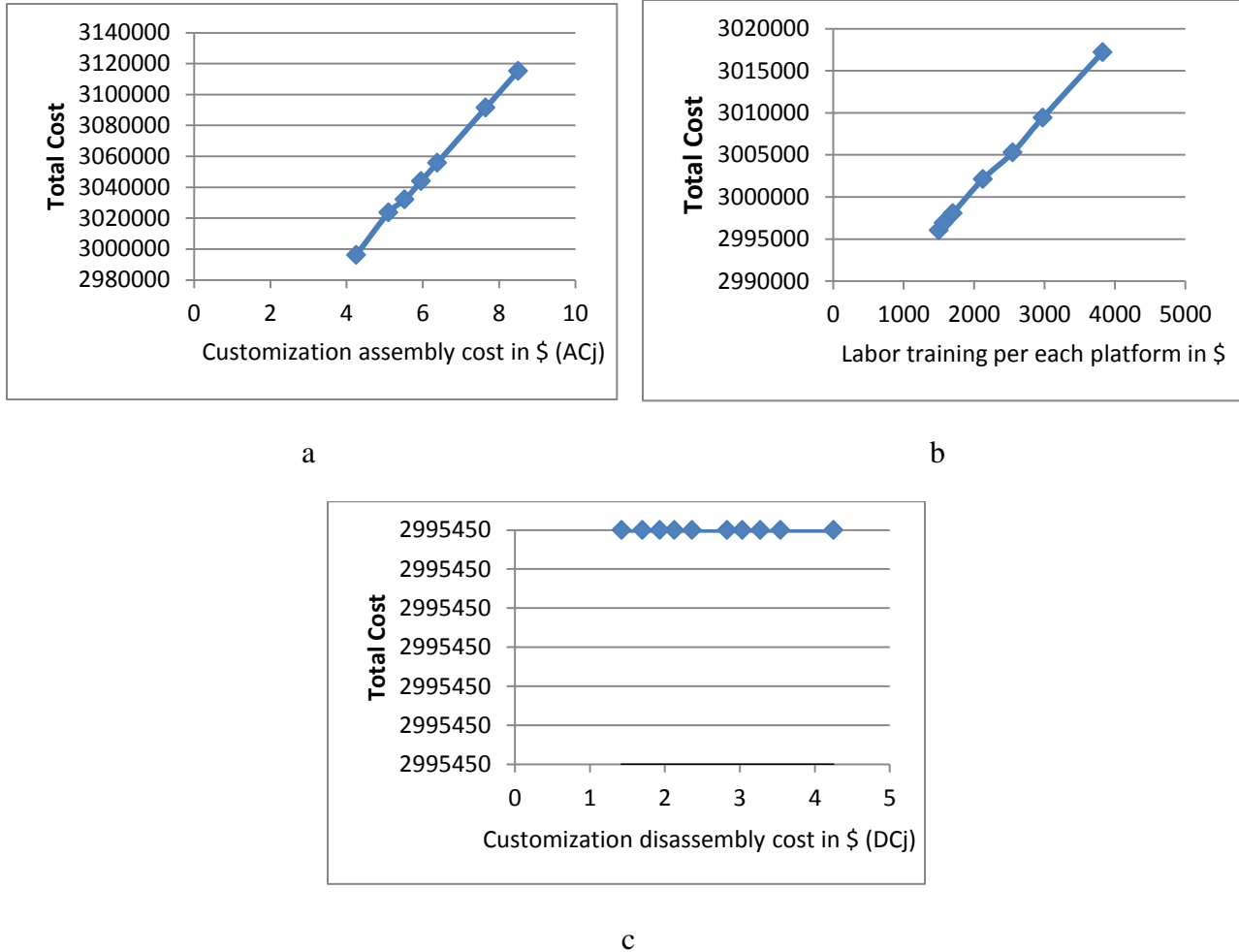

Figure 3.7 (a-c) Different comparisons between cost of assembling, cost of disassembling and cost of platform ratios to the total cost

3.9.2 Products and components numbers

In some products, the number of products and components may become large (i.e. number of different products not the produced quantities). Therefore, it is required to test the model sensitivity to the number of components and products. Table 3.6 shows time needed by the model to optimally define the number and composition of product families and platforms. The number of platforms is determined by the model. The maximum number of platforms is equal to the number of products. Two factors affecting the solution time are examined: the number of products and number of components per product.

Table 3.6 Model performance evaluation with varying number of products and components

Number of Distinctive Products	Number of Components (in each product)	Time (Seconds)
4	8	3-7
8	8	10
12	8	11
10	16	19-46
10	25	28 (0.08 % optimality gap)
15	25	127 (0.47 % optimality gap)
15	35	214 (0.45 % optimality gap)

In table 3.6, the first three cases represent an increase in the number of products only. It is noticed that the solution time needed increased by small percentage. However in the following cases, the increase in number of components increased solution time noticeably. Additionally, the optimality gap increased from the default 10^{-4} to a range of 0.08 (i.e. 47%). This indicates that sensitivity of the model to the number of components is higher than its sensitivity to number of products.

3.10 Contributions

A new Modular Product Multi-Platform Configuration model – MPMP has been developed to co-design product families and platforms. The model is linear which enables it to optimally solve large sets of products with numerous components. The cost of using assembly and disassembly to customize product platforms into individual variants was used to formulate the MPMP model which is significantly faster and more efficient than the closest model in the literature. The model is able to deal with large products demand fluctuation (i.e. including zero demand of some products).

3.11 Conclusions

Markets and customers have changing needs and demands for product variety. Decreasing assembly costs for different product families and platforms become a necessity. A new optimal product platform formation model was developed to combine the benefits of both mass production and customization. The proposed Modular Product Multi-Platform Model (MPMP) classifies different product variants into distinct families that use well-defined platforms. The non-linear

model is linearized after its formulation by adapting and modifying a linearization scheme found in literature. The exact number of platforms is not needed in the MPMP model because it obtains the optimal number and composition of each platform and its accompanying product family. The model is efficient due to its linear nature. The concept of the MPMP model depends on decreasing the total cost of the platforms' mass production and the further customization costs of the platforms to obtain the target product variants. The model depends on increasing commonality across platforms by using both assembly and disassembly of the components for customizing their platforms. Using assembly and disassembly in platform formation enables postponing of the product differentiation point.

Two case studies were used to demonstrate the model. Any change in the inputs to the model (e.g. variants quantities) affects noticeably the number and the composition of platforms and their corresponding families. Increasing a certain product variant demand, forces the model to favour the variant components in platform assembly. The improvement in the model solution time for a single product platform was noticeable, where computing time of MPMP is always better than that of Ben Arieh's model. For larger number of platforms, only MPMP is able to solve a typically large problem which is not the case for other models in the literature. A performance evaluation of cost components shows that the increasing component customization assembly cost increases the total assembly cost. This is not the same case for customization by disassembly cost. Decreasing or increasing disassembly cost does not affect total assembly cost indefinitely. If the model determines that disassembly concept is not used, then changing disassembly costs will not affect the total assembly costs. Three different factors can force the model to utilize disassembly principle: decreasing number of allowed platform, decreasing components costs (i.e. using cheap components) and increasing customization by assembly costs. Any combination of the previous factors can have the same effect on using disassembly principle. Another model performance evaluation revealed that the solution time of the model is affected by increasing both the number of components per products and number of products. Higher number of components has a greater effect on solution time than increasing products numbers. Using this model, companies can easily shift between make-to-stock (platform assembly) and make-to-order (platform to product customization) strategies. This flexibility in adopting different strategies increases the corporation's responsiveness, agility and adaptability to market and demand fluctuations.

3.12 A Hierarchic Model of Changeable Modular Product Platforms (Model 3)

3.12.1 Motivation

Looking at the obtained results (at setup cost 1000 and demand (100 100 700 100)), it is clear that the platform (ABDE) is used to make products 1 and 2. The problem here that component E – according to precedence constraints – can be placed on/after component B or component C. Although this case may be rare, the model must have the capability to locate component E exactly. A new model should aim at combining different concepts into one holistic model. The concepts include: changeable product families (ElMaraghy 2007), changeable product platforms (ElMaraghy

2009), delayed product differentiation (AlGeddawy and ElMaraghy 2010a), simultaneous assembly and disassembly processes (Ben-Arieh et al. 2009), and a newly proposed platform hierarchy variable. Therefore, hierarchical term refers to the ability of the proposed model to fully obtain optimal hierarchies of every product platform. The new variable is s_{ijd} where:

$$s_{ijd} = \begin{cases} 1, & \text{if component } d \text{ is assembled after component } j \text{ in platform } i \\ 0, & \text{otherwise} \end{cases}$$

This is the first time to introduce such a concept of platform hierarchy. Most of the literature deals with definite components positions, where each component has only one place to be assembled. But this may not be the case in springs, bolts, nuts, and any standard interchangeable part that can be present in more than one place in the assembly. Another very important modification is proposed. The matrix of added components a_{ijk} and removed components d_{ijk} must also be also modified to enable component redundancy, and to locate the exact location of the assembly of each component. The new added and removed matrices become:

$$a_{ijk} = \begin{cases} 1, & \text{if component } d \text{ is assembled after component } j \\ & \text{in platform } i \text{ to form product } k \\ 0, & \text{otherwise} \end{cases}$$

$$r_{ijk} = \begin{cases} 1, & \text{if component } d \text{ is disassembled from component } j \\ & \text{in platform } i \text{ to form product } k \\ 0, & \text{otherwise} \end{cases}$$

And because that platform hierarchy matrix now contains two types of information: platform composition and precedence, the platform composition matrix F_{ij} can now be eliminated from the new model. The new objective function becomes:

Min Cost c =

$$\sum_{i=1}^l \sum_{j=1}^m \sum_{d=1}^m \sum_{k=1}^n (PA_j + cc_j) s_{ijd} y_{ik} d_k + \sum_{i=1}^l \sum_{j=1}^m \sum_{d=1}^m \sum_{k=1}^n (AC_j + cc_j) a_{ijk} y_{ik} d_k + \sum_{i=1}^l \sum_{j=1}^m \sum_{d=1}^m \sum_{k=1}^n DC_j r_{ijk} y_{ik} d_k + \sum_{i=1}^l P_i c \quad (3.34)$$

The objective function obtained is nonlinear. This will increase drastically the time needed to solve real larger products and platforms. The same steps used before in previous models will be used here in this model. The coming substitutions are done on the objective function:

$$zx_{ijk} = s_{ijd} y_{ik} \quad (3.35)$$

$$zy_{ijk} = a_{ijk} y_{ik} \quad (3.36)$$

$$zz_{ijk} = r_{ijk} y_{ik} \quad (3.37)$$

The objective function will be:

$$\text{Min Cost } c = \sum_{i=1}^l \sum_{j=1}^m \sum_{d=1}^m \sum_{k=1}^n (PA_j + cc_j)zx_{ijdk} d_k + \sum_{i=1}^l \sum_{j=1}^m \sum_{d=1}^m \sum_{k=1}^n (AC_j + cc_j)zy_{ijdk} d_k + \sum_{i=1}^l \sum_{j=1}^m \sum_{d=1}^m \sum_{k=1}^n DC_j zz_{ijdk} d_k + \sum_{i=1}^l P_i c \quad (3.38)$$

Subject to:

$$Ms_{ijd} \geq zx_{ijdk} \quad (3.39)$$

$$zx_{ijdk} \geq y_{ik} + s_{ijd} - 1 \quad (3.40)$$

$$y_{ik} \geq zx_{ijdk} \quad (3.41)$$

$$a_{ijdk} \geq zy_{ijdk} \quad (3.42)$$

$$zy_{ijdk} \geq y_{ik} + (a_{ijdk} - 1) \quad (3.43)$$

$$y_{ik} \geq zy_{ijdk} \quad (3.44)$$

$$Ms_{ijd} \geq zz_{ijdk} \quad (3.45)$$

$$zz_{ijdk} \geq y_{ik} + (r_{ijdk} - 1) \quad (3.46)$$

$$y_{ik} \geq zz_{ijdk} \quad (3.47)$$

$$\sum_{i=1}^l y_{ik} = 1, \quad k = 1, \dots, n \quad (3.48)$$

$$a_{ijdk} + (1 - P_{kjd} + s_{ijd}) \geq y_{ik} \quad (3.49)$$

$$a_{ijdk} \leq y_{ik} \quad (3.50)$$

$$r_{ijdk} + (1 - s_{ijd} + P_{kjd}) \geq y_{ik} \quad (3.51)$$

$$\sum_{k=1}^n y_{ik} \geq P_i, \quad i = 1, \dots, l \quad (3.52)$$

$$\sum_{k=1}^n y_{ik} \leq MP_i, \quad i = 1, \dots, l \quad (3.53)$$

$$\sum_{d=1}^m s_{ijd} \leq u_j, \quad i = 1, \dots, l \quad (3.54)$$

$$M \sum_{k=1}^n y_{ik} \geq s_{ijd} \quad (3.55)$$

$$zx_{ijdk}, zy_{ijdk}, zz_{ijdk}, p_i, s_{ijd}, y_{ik}, a_{ijdk}, d_{ijdk} = \{0,1\} \quad (3.56)$$

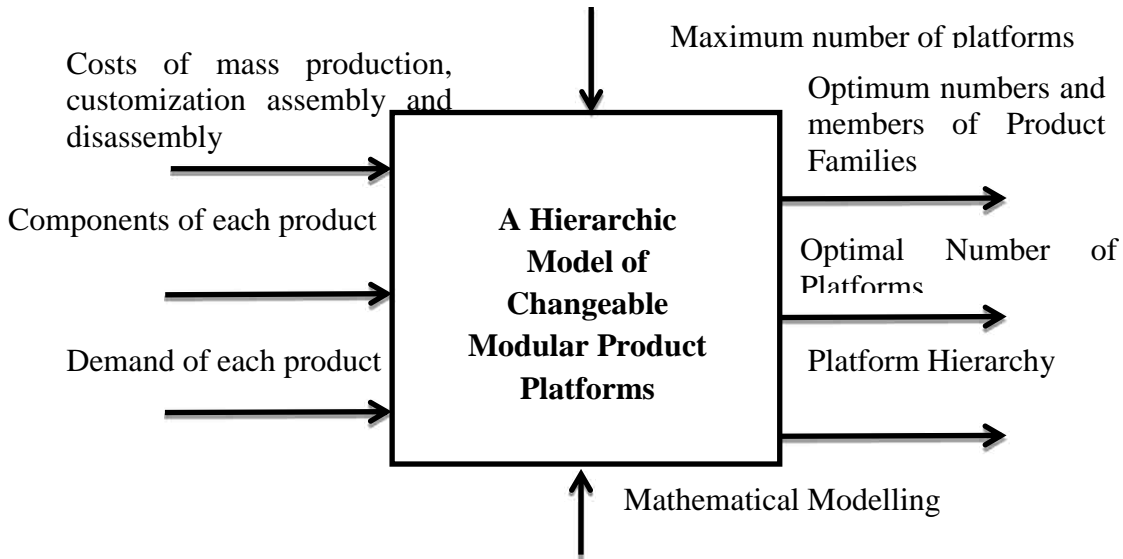

Figure 3.8 IDEF0 of the Hierarchic Changeable Modular Product Platforms model

The constraints from (3.30) to (3.35) are the necessary constraints to linearize the three quantities $(s_{ija}y_{ik}, a_{ijk}y_{id}, r_{ijk}y_{id})$. The set of constraints (3.36) is to ensure that every product belongs to only one family and one platform. Constraints set (3.37) is to assemble new component d to component j in a certain platform i to form product k, if components d and j belong to that product, and j precedes d in the original precedence matrix of the product, and not in the obtained platform. Set of Constraints (3.38) prevents assembling any component to a platform i, if the product k is not in platform i. Constraint (3.39) removes component d from component j in platform I to form product k, if the product is in the family served by that platform, and component d is not in product k. The existence or not of a certain platform, and hence determining adding or not its fixed associated costs is determined by constraints (3.40-3.41). Constraint set (3.42) is component and not product dependent, where the constraint determines the maximum number of components that can co-exist (assembled) on a parent component. The set (3.43) ensures that if no platform serves any product family, all of its components should vanish. Finally, the last set is for obliging variables to be binary.

3.12.2 Importance of a hypothetical dummy component

The objective function's first term contains the hierarchy cost summation $\sum_{i=1}^l \sum_{j=1}^m \sum_{d=1}^m \sum_{k=1}^n (PA_j + cc_j) s_{ija} F_{ik} q_k$ over all columns and rows components in the hierarchy matrix. The first value to be calculated is the cost of mass assembly of B and C components to the A component, and component A different costs will not be accounted for (figure 3.9a). Therefore, to include the A component in assembly and purchasing costs; an extra dummy component must be introduced A' (figure 3.9b). In this way, the cost of the assembly of component A as well as its purchasing cost will be calculated when the model begins with the dummy component row.

$$S_{ijd} = \begin{matrix} & A & B & C & D & E \\ A & 0 & 1 & 1 & 0 & 0 \\ B & 0 & 0 & 0 & 1 & 1 \\ C & 0 & 0 & 0 & 0 & 0 \\ D & 0 & 0 & 0 & 0 & 0 \\ E & 0 & 0 & 0 & 0 & 0 \end{matrix}$$

a. Without dummy component

$$S_{ijd} = \begin{matrix} & A' & A & B & C & D & E \\ A' & 0 & 1 & 0 & 0 & 0 & 0 \\ A & 0 & 0 & 1 & 1 & 0 & 0 \\ B & 0 & 0 & 0 & 0 & 1 & 1 \\ C & 0 & 0 & 0 & 0 & 0 & 0 \\ D & 0 & 0 & 0 & 0 & 0 & 0 \\ E & 0 & 0 & 0 & 0 & 0 & 0 \end{matrix}$$

b. With dummy component

Figure 3.9 Dummy component explanation

3.12.3 Example

The same illustrative example used in Changeable Modular Product Platform Assembly model is used. The only modification is the addition of the zero cost dummy components to each product composition and assembly precedencies. A comparison between model 2 (with no hierarchy criterion) and model 3 (with hierarchy criterion) shows the following observations. In the first demand vector (with setup cost 1000), model 2 seems to get a lower objective function value, and also chose the right product (Product 1) to be mass produced, then customized later by adding and removing components, to form the other products. On further investigation, because the model does not have the mechanism to differentiate between platform structures, it treats the component E (has two possible locations) as if it is in the right place in each product platform. Example, if E is in product 1 and 2 then it is attached to component B, and if E is in product 3, then it is attached to component C. Nearly the same case happened in second demand vector, when allowing the model to have multiple platforms, although model 2 produced the same objective function, but the first platform has the same issue with exact determining location of component E. The same above observation applies here also; model 2 is not efficient with large differences between product demand numbers. Another case, in the last demand vector, the large demand is repeated twice with the two products (1,3) that have different location of component E. Model 3 eliminated totally the addition of component E to the platform, because adding E to B or C in mass production will incur more costs.

Table 3.7 Comparison between model 2 and model 3 using the illustrative example (single platform)

Setup Cost	Costs (PA _i , AC _j , DC _j)	Demand	Single Platform (Model 3)	Cost (Model 3)	Single Platform (Model 2)	Cost (Model 2)
1000	2,4,3	[7000 100 100 100]	[ABCDE] (DE -> B)	523200	ABCDE	521100
		[25 25 25 925]	[ABCGH]	80675	ABCGH	80675
100	2,4,3	[25 25 25 925]	[ABCGH]	79775	[ABCGH]	79775
		[5000 100 5000 100]	[ABC]	767700	[ABCE]	749400

Table 3.8 Comparison between model 2 and model 3 using the illustrative example (multiple platform)

Setup Cost	Costs (PA_j , AC_j , DC_j)	Demand	Multiple Platform (Model 3)	Cost (Model 3)	Multiple Platform (Model 2)	Cost (Model 2)
1000	2,4,3	[7000 100 100 100]	[ABCDE]{1} (DE -> B) [AB]{2,3,4}	515900	[ABCDE]{1} [AB]{2,3,4}	515900
		[25 25 25 925]	[ABDE]{1,2} Separate {3,4}	76075	[ABCE]{1,3} Separate {2,4}	76075
100	2,4,3	[25 25 25 925]	[ABDE](DE->B) {1,2} Separate {3,4}	76075	[ABCE]{1,3} Separate {2,4}	76075
		[5000 100 5000 100]	Separate	725300	Separate	725300

3.12.4 Case Study

A case study of touch screen tablets product family consisting of six product variants is used to demonstrate the developed dynamic platform formulation model. The tablets have different structures and different components, hence different precedence constraints as shown in Figure 3.10. The mathematical model was programmed using AMPL language and solved using CPLEX 11.2.1 solver. The inputs to the model were as follows:

- $cost_p = \$2.5$
- $c_{aj} = \$4.25$
- $c_{rj} = \$4.25$
- $c = \$900$
- Total demand (number of tablets to be produced) for the six products, respectively = [9000 700 8000 400 9000 500]
- Maximum number of platforms = 1 or 6 (two scenarios were analyzed)

The motherboard used has three different variations; the speaker is designed so that it has two different possible assembly locations: either after the assembly of the battery, or just after the power button. The dummy component is an imaginary component used to decrease number of terms and their complexity in the objective function. Table 3.7 enumerates the components used in each tablet, and their costs as well.

3.12.5 Discussion

The model was solved for single and multiple assembly lines. In table 3.8, the product platform structure contains five main components: steel mid frame, power button, display, front panel assembly, and the speaker assembly in position 1. The model described clearly the position of the

speaker assembly – since it had two positions – and decided to attach it to the power button. This is suitable for products 1, 3, 5. For products 2, 4, 6, the speaker assembly will be removed from its position and added after the assembly of the battery. Then, according to the composition of each product, the components will be added as the product platform advances through the assembly line.

The next step is to allow the maximum number of components in the platform to be the total number of product variants. This increases the model flexibility in assigning the products to more platforms and assembly lines, to minimize the cost of products components, assembly, and disassembly. The total cost dropped by 2.89 % as a result. In that case, the model found that assigning each product to a separate assembly line is more economic than creating one unified platform for all of them.

This would be expected if the cost of initiating the assembly line is small compared to the expected cost of the components, mass produced platforms, and their combined assembly and disassembly operations. It is worth noting that by changing any input factor (e.g. product demand, assemblies' precedencies, and costs), all product platforms and product families change accordingly and evolve flexibly and easily. The obtained product platforms possess more shared components across the tablet family; this is the key to delayed product differentiation.

Table 3.9 Costs and composition of each tablet

No.	Components	Cost(\$)	P1	P2	P3	P4	P5	P6
1	Steel mid frame	4	x	x	x	x	x	x
2	Battery 1 (4400 mAh)	16.5	x			x		x
3	Battery 2 (8000 mAh)	30		x	x		x	
4	Touchscreen controller	3	x	x	x	x	x	x
5	Power Button	2.5	x	x	x	x	x	x
6	Speaker Assembly Position 1	10		x		x		x
7	Speaker Assembly Position 2	10	x		x		x	
8	Front Panel Assembly	42	x	x	x	x	x	x
9	Mother Board 1 (default)	64.5	x			x	x	
10	Mother Board 2 (High memory)	80		x				x
11	Mother Board 3 (High storage capacity)	90			x			
12	Display	45	x	x	x	x	x	x
13	Back Cover	6	x	x	x	x	x	x

Table 3.10 Single and Multi Platform Optimum Hierarchy

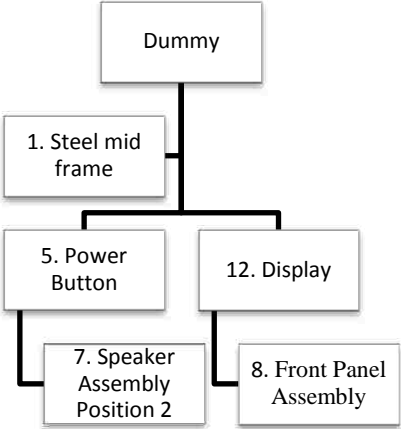
One Platform (i.e. one assembly line)	Cost (\$)	Maximum allowable Platforms (i.e. 6 platforms)	Cost (\$)
<p>Platform Hierarchy for all products</p> 	6459430	Each product has its independent platform (i.e. the product itself) and separate line of assembly.	6272630

Use of the model decreased the number of differentiating elements in the mass production phase, so the delayed differentiation process has become more efficient. The computation time using 3.12 GHz Xeon Processor and 4 GB RAM computer was less than 1 second for the one platform, and less than 5 seconds for the 6 platforms, which proves the efficiency of the model and its potential ability to handle more complex products.

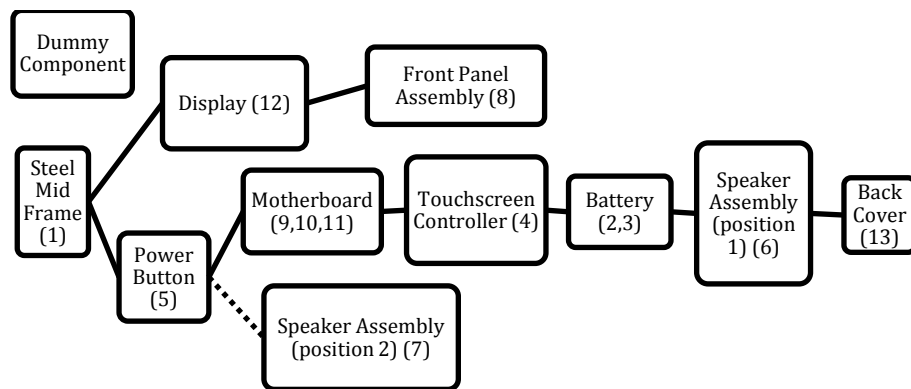

Figure 3.10 Precedence Diagram of the tablets family showing speaker assembly positions

3.12.6 Contributions

- The Hierarchic Changeable Modular Product Platforms Assembly Model implements a complete mathematical definition of Products Platforms Hierarchy.
- The products platforms hierarchy concept has been introduced for the first time; to avoid ambiguous assembly locations for similar component types.
- The model has been applied to a real case study (i.e. touch screen tablet) to define several products families and platforms hierarchy.

Chapter 4

A Multi-Period Multi-Platform Configuration Model

4 Introduction

Products variety is becoming a necessity to respond to market and customers' different requirements and challenging technological issues. Customers increasingly ask for more new products with very changing demands and needs. Novel concepts to enhance the application of Mass Customization should be explored. The competition to acquire new markets, and even to preserve existing ones, requires efficient production methods to decrease costs, while ensuring quality and maintaining product functionality. One of the prime strategies to cope with these challenges is the use of effective Product Platforms and Architectures. The use of the product architecture concept by industrial corporations were discussed and researchers differentiated clearly between modular and integral architectures and further divided the modularity to slot, bus, and sectional types (Ulrich 1995). The product architecture concept was later referred to as product platforms, and it was suggested that there are three models which govern the product realization: function, technology, and physical appearance (Erens and Verhulst 1997). Many researchers devised models for forming product platforms which assume that modules are assembled to a common core of components (platform). Very few researchers considered both assembly and disassembly of components to platforms to realize derivative products (Ben-Arieh et al. 2009). Inventory cushions are needed in such cases to safeguard against un-predictable changes in market demands. The only model devised to combine product platform design with inventory cushions has limitations (Maozhu and Rongqiu 2008). It is highly non-linear and can only form one product platform. In this paper, a new multi-period multi-platform formulation for the assembly/disassembly product platforms design which also incorporates inventory considerations is proposed.

4.1 Literature Review

Product Platform research is a large and diverse field. It considers many elements such as commonality measures and indices, and different optimization criteria (e.g. maximum commonality, minimum functionality loss). Platforms have been categorized depending upon: modularity, scalability (Simpson et al. (2001) and Simpson and Mistree (1999)) and functionality (Kumar and Allada 2007). A Product Platform is defined as a: set of subsystems and interfaces that form a common structure from which a stream of derivative products can be efficiently produced and developed Meyer and Lehnerd (1997).

Platform assessment metrics were developed to evaluate the generational variety of a platform defined as an estimate of the amount of effort needed to convert a platform to another as products

change (Martin and Ishii 2002). A coupling index which determines the degree of coupling between different products components was suggested. A top-down approach is used by obtaining “Minimum Spanning Network” to form a platform that can be used as a customizable baseline product to serve different customers’ needs (Hernandez et al. 2003). A thorough literature review of product architecture, modular design methods and platform formation techniques can be found in Jose and Tollenaere (2005). Similarity and sensitivity indices were used to form a suitable product platform for a multi-stage gear box (Kwang-Jae et al. 2006). The best platform components were those having highest similarity (physically or functionally) and the smallest sensitivity to changes in customers’ requirements. A utility-based compromise decision support method was devised to determine a platform map (two dimensional graph of two platforms variables) of a cantilever beam that serve different requirements and demands (Williams et al. 2007). A similar approach to select and decide the number and types of machines to be used in the production of those beams was also proposed. A simulation model was also proposed to determine suitable product family to maximize market share (Zacharias and Yassine 2008).

Researchers used Design Structure Matrix (DSM), Functional Structure Matrix (FSM) and Genetic Algorithm and proposed an Impact Metric (IM) to obtain the optimal set of shared components among a group of products (Rojas Arciniegas and Kim 2011). A mathematical formulation was proposed to configure single and multiple platforms by both adding or removing components to the platform to form the final product (Ben-Arieh et al. 2009). This model requires defining the number of platforms to be formed a priori, which is considered a drawback. The model resulted in negative costs when increasing the maximum number of platforms to be formed which is a serious flaw. The model’s objective function is nonlinear which increases the solution time. A number of plane cuts were included in the model which does not affect the solution time, and does not guarantee optimality. Another novel model used Cladistics, which is a classification technique used in biology, to form a tree-like layout of products components. It identifies common platforms and defines the best delayed product differentiation assembly point and subsequent variants assembly steps (AlGeddawy and ElMaraghy 2010a).

4.2 Problem Statement

Companies and corporations are always trying to increase their competitiveness. This competitiveness can be increased by adopting new assembly techniques and product platforms and safeguard them against changeable customer demands. Using product platforms, new assembly/disassembly technique with an inventory model can boost companies’ responsiveness and competitiveness across global markets. It is required to design a mathematical model to define the optimal numbers and members of products families and platforms, taking into consideration the proper inventories amount to guard against markets fluctuations. This is illustrated in Figure 4.1. The multi-period concept considers the demand of each product variant in each production period (e.g. variants demand each month). The multi-platform means that in each period different modular product platforms may be best to produce, customize, and/or store as inventory. The product platform, in this model, is a mass produced subassembly of different components which can serve a

number of products down to one product per platform. The model may determine that only one product per platform is optimal to mass produce due to high demand for that product in different production periods.

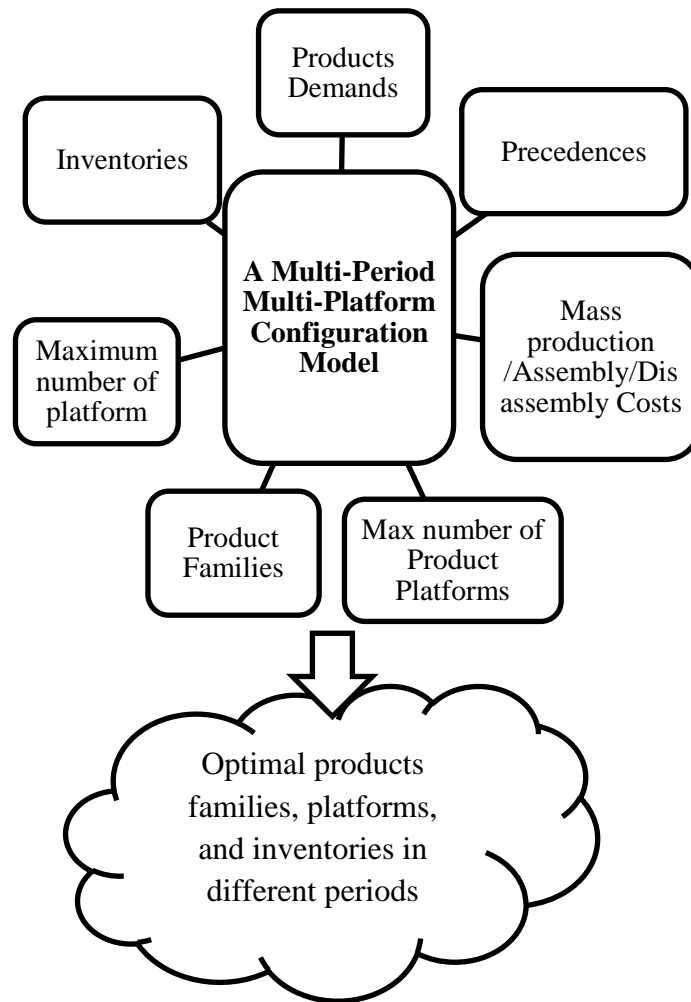

Figure 4.1 Multi-period Multi-Platform configuration model

4.3 Mathematical Model

In this section, the entire model is developed and discussed. First, all of the variables and parameters are enumerated as follows:

4.3.1 Model Parameters

p: Maximum number of production periods

l: Maximum number of platforms

m: Maximum number of components

n : Maximum number of products

CP_j : Mass production assembly of a component j to a certain platform

C_j : Cost of component j

d_{kt} : Demand of product k in period t

AC_j : Customization assembly cost of component j

DC_j : Customization disassembly cost of component j

c : Labor training cost of each platform

H_{prod} : Unit holding cost of product inventory

H_{plat} : Unit holding cost of platform inventory

$v_{jk} = \begin{cases} 1, & \text{if product } k \text{ contains component } j \\ 0, & \text{otherwise} \end{cases}$

$f_{kjd} = \begin{cases} 1, & \text{if component } j \text{ precedes component } d \text{ in product } k \\ 0, & \text{otherwise} \end{cases}$

s_{io} : Amount of starting platforms inventories

e_{io} : Amount of ending platforms inventories

s_{ko} : Amount of starting products inventories

e_{ko} : Amount of ending products inventories

4.4 Model decision variables

$y_{ik} = \begin{cases} 1, & \text{if product } k \text{ is assigned to platform } i \\ 0, & \text{otherwise} \end{cases}$

$a_{ijk} = \begin{cases} 1, & \text{if component } j \text{ is assembled to} \\ & \text{platform } i \text{ to form product } k \\ 0, & \text{otherwise} \end{cases}$

$r_{ijk} = \begin{cases} 1, & \text{if component } j \text{ is disassembled from} \\ & \text{platform } i \text{ to form product } k \\ 0, & \text{otherwise} \end{cases}$

$$P_i = \begin{cases} 1, & \text{if platform } i \text{ exists} \\ 0, & \text{otherwise} \end{cases}$$

p_{it} = Quantity produced of platform i in period t

p_{kt} = Quantity produced of product k in period t

I_{kt} = Amount of inventory of product k in period t

I_{it} = Amount of inventory of platform I in period t

4.5 Mathematical model formulation

Using a similar cost objective function as in Chapter 3, the mathematical model is formulated first as a nonlinear mixed integer model as follows:

Minimize Z (Total Cost) =

$$\begin{aligned} & \sum_{t=1}^p \sum_{i=1}^l \sum_{j=1}^m \sum_{k=1}^n (CP_j + C_j) x_{ij} y_{ik} p_{it} + \sum_{t=1}^p \sum_{i=1}^l \sum_{j=1}^m \sum_{k=1}^n (AC_j + C_j) a_{ijk} y_{ik} p_{kt} + \\ & \sum_{t=1}^p \sum_{i=1}^l \sum_{j=1}^m \sum_{k=1}^n DC_j r_{ijk} y_{ik} p_{kt} + \sum_{t=1}^p \sum_{k=1}^n H_{prod} I_{kt} + \sum_{t=1}^p \sum_{k=1}^n H_{plat} I_{it} \\ & + \sum_{i=1}^l P_i c \end{aligned} \quad (4.1)$$

Subject to:

$$\sum_{i=1}^l y_{ik} = 1, \quad k = 1, \dots, n \quad (4.2)$$

$$\begin{aligned} a_{ijk} - v_{jk} + x_{ij} + 1 & \geq y_{ik}, \quad i = 1, \dots, l; \quad j = 1, \dots, m; \\ k & = 1, \dots, n \end{aligned} \quad (4.3)$$

$$a_{ijk} \leq y_{ik}, \quad i = 1, \dots, l; \quad j = 1, \dots, m; \quad k = 1, \dots, n \quad (4.4)$$

$$r_{ijk} - x_{ij} + v_{jk} + 1 \geq y_{ik}, \quad i = 1, \dots, l; \quad j = 1, \dots, m; \quad k = 1, \dots, n \quad (4.5)$$

$$r_{ijk} \leq y_{ik}, \quad i = 1, \dots, l; \quad j = 1, \dots, m; \quad k = 1, \dots, n \quad (4.6)$$

$$1 + x_{ij} \geq f_{kjl} y_{ik} + x_{il}, \quad i = 1, \dots, l; \quad j = 1, \dots, m; \quad k = 1, \dots, n \quad (4.7)$$

$$M \sum_{k=1}^n y_{ik} \geq x_{ij}, \quad i = 1, \dots, l; \quad j = 1, \dots, m \quad (4.8)$$

$$\sum_{k=1}^n y_{ik} \geq P_i, \quad i = 1, \dots, l \quad (4.9)$$

$$\sum_{k=1}^n y_{ik} \leq P_i M, \quad i = 1, \dots, l \quad (4.10)$$

$$I_{i(t-1)} + p_{it} = I_{it} + \sum_{k=1}^n y_{ik} p_{kt} \quad (4.11)$$

$$I_{k(t-1)} + p_{kt} = d_{kt} + I_{k(t-1)} \quad (4.12)$$

$$I_{io} = s_{io} \quad (4.13)$$

$$I_{ip} = e_{io} \quad (4.14)$$

$$I_{ko} = s_{ko} \quad (4.15)$$

$$I_{kp} = e_{ko} \quad (4.16)$$

The objective function is composed of six terms. First term calculates the cost of forming products platforms (i.e. mass production assembly costs and components costs) across all periods. Second term calculates the cost of individually customizing different platforms formed by assembly to form different products across different periods. The customization by individual components/modules disassembly costs across periods are calculated by the third term. Fourth and fifth terms are concerned with inventory costs of finished products and unfinished platforms, respectively. Labor training costs to assemble a certain platform is determined by the sixth term.

Constraint sets (4.2 – 4.10) are discussed in details in Chapter 3. Constraint (11) ensures sufficiency of platforms inventories and production with the products needs in each period. Constraint set (12) preserves the initial and beginning products inventories. Constraint sets (13-16) assigns the initial and the end inventories of products and platforms to the model. In most cases, all of the initial and ending inventories are set to zeroes, to minimize holding costs and decrease quantities of obsolete products and platforms.

4.5.1 Model linearization

The proposed model is highly nonlinear. Hence, a linearization scheme is adopted from Peterson (1971), to linearize both of the objective function and the constraints to make it possible to find optimal products platforms and families in less computing time compared to the initial nonlinear model. The method depends on replacing each two nonlinear variables with one variable and two constraints. The linearization of the objective function is as follows:

$$\begin{aligned} \text{Minimize } Z \text{ (Total Cost)} = & \sum_{t=1}^p \sum_{i=1}^l \sum_{j=1}^m \sum_{k=1}^n (CP_j + C_j) g_{tijk} + \sum_{t=1}^p \sum_{i=1}^l \sum_{j=1}^m \sum_{k=1}^n (AC_j + \\ & C_j) q_{tijk} + \sum_{t=1}^p \sum_{i=1}^l \sum_{j=1}^m \sum_{k=1}^n DC_j s_{tijk} + \sum_{i=1}^l P_i c + \sum_{t=1}^p \sum_{k=1}^n H_{prod} I_{kt} + \\ & \sum_{t=1}^p \sum_{k=1}^n H_{plat} I_{it} \end{aligned} \quad (4.17)$$

Subject to:

$$M_1 u_{ijk} \geq g_{tijk} \quad (4.18)$$

$$g_{tijk} \geq p_{it} + M_1(u_{ijk} - 1) \quad (4.19)$$

$$x_{ij} \geq u_{ijk} \quad (4.20)$$

$$u_{ijk} \geq y_{ik} + x_{ij} - 1 \quad (4.21)$$

$$M_2 w_{ijk} \geq q_{tijk} \quad (4.22)$$

$$q_{tijk} \geq p_{kt} + M_2(w_{ijk} - 1) \quad (4.23)$$

$$a_{ijk} \geq w_{ijk} \quad (4.24)$$

$$w_{ijk} \geq y_{ik} + a_{ijk} - 1 \quad (4.25)$$

$$M_2 z_{ijk} \geq s_{tijk} \quad (4.26)$$

$$s_{tijk} \geq p_{kt} + M_2(z_{ijk} - 1) \quad (4.27)$$

$$r_{ijk} \geq z_{ijk} \quad (4.28)$$

$$z_{ijk} \geq y_{ik} + r_{ijk} - 1 \quad (4.29)$$

To linearize constraint 11, the same former procedure is used here again:

$$I_{i(t-1)} + p_{it} = I_{it} + \sum_{k=1}^n y_{ik} p_{kt} \quad (4.30)$$

$$M_2 y_{ik} \geq y1_{ikt} \quad (4.31)$$

$$y1_{ikt} \geq p_{kt} + M_2(y_{ik} - 1) \quad (4.32)$$

$$u_{ijk}, g_{tijk}, w_{ijk}, q_{tijk}, z_{ijk}, s_{tijk}, y1_{ikt} = \{0,1\} \quad (4.33)$$

4.6 Illustrative Example

It is required to obtain the optimal products families and platforms formation, using the proposed model, for the hypothetical four-product example where each has different assembly precedence constraints and different demands in each period. The used modular products example, shown in Figure 3.3, is adopted from Ben-Arieh et al. (2009).

The data used in solving the multi-platform multi-period problem is enumerated as follows:

$p = 4, l = 4, n = 4, CP_j = \$0.5, C_j = 10, 11, 12, 13, 14, 15, 16,$ and 17 for Components: A, B, C, D, E, F, G, and H, respectively.

$AC_j = \$2, DC_j = \$0.8, c = \$2000, H_{prod} = \$1, H_{plat} = \$2, (s_{io}, e_{io}, s_{ko}, e_{ko}) = 0, M_1 = 2000, M_2 = 500, d_{kt} = ((25 \ 100 \ 300 \ 400) (25 \ 300 \ 500 \ 200) (25 \ 400 \ 200 \ 100) (325 \ 800 \ 100 \ 200))$

Table 4.1 Results of the multi-period multi-platform model

Number Of Platforms	Product Families	Product Platform Components	Product Production Volumes (Variant Unit/Period)	Product Inventories (Variant Unit/Period)	Cost (\$)
1	All products are produced individually without families (i.e. fully customized assembly)	No Platform components (i.e. no mass production).	{(25 100 300 400) (25 500 500 200) (25 500 200 100) (325 500 100 200)}	{(0 0 0 0) (0 0 0 0) (0 200 0 0) (0 300 0 0) (0 0 0 0)}	294900
2	- Product 2 in one family (i.e. one platform and can be mass produced) - Other products are custom assembled.	- Product 2 platform components (A, B, D, E, and F).	{(25 100 300 400) (25 500 500 200) (25 500 200 100) (325 500 100 200)}	{(0 0 0 0) (0 0 0 0) (0 200 0 0) (0 300 0 0) (0 0 0 0)}	284900
3	- Product 2 in one family (i.e. one platform and can be mass produced) - Product 3 in one family (i.e. one platform and can be mass produced) - Other products are custom assembled.	- Product 2 platform components (A, B, D, E, and F). - Product 3 platform components (A, B, C, E, and F).	{(25 100 300 400) (25 500 500 200) (25 500 200 100) (325 500 100 200)}	{(0 0 0 0) (0 0 0 0) (0 200 0 0) (0 300 0 0) (0 0 0 0)}	278650
4	All products are mass produced	Each product is its own platform.	{(25 100 300 400) (25 500 500 200) (25 500 200 100) (325 500 100 200)}	{(0 0 0 0) (0 0 0 0) (0 200 0 0) (0 300 0 0) (0 0 0 0)}	270900

4.7 Results and Discussion

The Multi-Period Multi-Platform Model is programmed using the Optimization Programming Language (OPL) and IBM ILOG CPLEX Studio 12.4 as a solver. The model is solved by varying the number of platforms, starting with one platform (Table 4.1). The fourth column shown in Table 4.1 is the product variant demands per period (i.e. 25 is product 1 demand, 100 is product 2 demand, 300 is product 3 demand and so on). The model determines that products one, two, three, and four cannot be grouped into one common platform. Hence, each product variant should be assembled separately as an individual product with cost of assembly: $AC_j = \$2$ per component. To linearize the model, two constants M_1 and M_2 control the maximum number of platforms and products that can be produced. Therefore, these two constants act as capacity constraints. As a

result, the model recommends assembling extra products as a buffer (e.g. product two at the end of period two has 200 extra units as inventory, and has 300 extra units in period three) and store them for future period 4. In second scenario, the number of platforms is set to two. In this case, product two is contained in a separate platform and produced as in a mass production (i.e. by using $CP_j = \$0.5$ to assemble each component) by allocating it to platform two. Each other product is produced separately like the first scenario. Third case is allowing the three platforms to contain the four products. In this case, the model allocates product two to platform one and product three to platform two. Each of these two products is mass assembled.

Table 4.2 Model Performance

M1	M2	Time (seconds)	Cost(\$)
400	400	12	271600
400	500	73	271600
2000	400	270	271600
2000	500	540	270900
7000	400	600	271600
7000	500	1525	270900

In the last case (i.e. platforms = 4), it is the optimal solution. All products are produced in separate platform each. It is worth noting that the cost decreases by allowing more platforms. Platform inventories are zero, due to their relatively large holding costs. In this model, platform inventories are considered a work-in-process which are stored and brought upon request. The maximum number of platforms (i.e. number of products) is not always the optimal solution for different costs and product demands. The proposed model solution time ranges from two seconds for one platform and five minutes for four platforms. Customization by disassembly in this example was found to be suboptimal using this data set. Hence, the model chose either mass production assembly for all products or customized individual product assembly when differentiation is required.

A model performance analysis is done using variable M1 and M2 values (Table 4.2). These constants represent the maximum capacity of platform production and product production, respectively. The total assembly cost is equal to the last cost in Table 4.1. Two important notes: solution time increases with any increase in M1 and M2 value. First, this remark emphasizes the importance of properly assigning reasonable values for these factors, given product demands and requirements, that match or even less than the available capacities. Second, increasing or decreasing companies' capacities for platform and product production does not lower total costs beyond a certain point (Principle of diminishing returns).

4.8 Contributions

A mathematical model is proposed to account for inventories quantities and costs when designing product platforms and families. This is the first time to propose such a model. The principle of assembly and disassembly of components to form platforms and derive other products is included. Through model performance testing, the model is capable of determining the required factory assembly capacity needed to assemble such products and platforms.

4.9 Conclusions

A new mathematical model is proposed to decrease costs of assembly of modular products. This model obtains optimal products platforms using the concept of both assembly and disassembly of components to/from platforms to derive new products. In the literature, the only available model can obtain one platform for each group of products for one demand period using nonlinear mathematical model. The proposed Multi-period Multi-platform Modular Products Assembly model overcomes these drawbacks by developing a linear multi-period and multi-platform assembly model. The model is able to form optimal families and platforms and determine best inventory levels. Results showed – for the discussed example – that it is better to allow more platforms (i.e. mass production lines) to decrease assembly costs. Products inventories are kept to minimal, while platforms inventories are zero, because of large holding costs of work-in-process platforms. Companies' capacities for platform and product production must be chosen carefully. Increasing capacities for platform production does not always guarantee lower production and assembly costs. Many factors and costs are included in the model. Therefore as a future work, these factors could be investigated to determine their relative importance to the assembly costs.

Chapter 5

Modular Product Platform Configuration and Co-Design of Assembly Line Model (MPCA)

5 Introduction

Assembly line is the group of stations used to perform certain assembly tasks to produce final products (Figure 5.1). The design and balancing of assembly systems is not done concurrently with from the formation of the products platform configuration. After a group of products is defined, they are classified into groups or clusters which may have common / shared components. If these components are identified, then the designer can make use of the platform concept to produce each product platform as needed on a make-to-stock basis. Each of these platforms are customized later to produce different product variants. In previous chapters, it has been shown that using both assembly and disassembly of components to customize platforms can increase platform effectiveness. Therefore, integrating the concepts of products clustering and families' formation, platform formation and customization and assembly line design and balancing into one unified model would represent a considerable contribution to current industrial practice. This model will facilitate effective and efficient co-design of the assembly line and products platforms design.

5.1 Literature Review

Research in the area of assembly line design and balancing is rich. Henry Ford is considered the father of the assembly line concept (Hounshell 1985). Salveson (1955) was the first researcher to formulate the assembly line balancing problem as a linear mathematical model. Moodie and Young (1964) proposed a heuristic technique to balance assembly lines taking into account constant and variable task times. Kottas and Lau (1973) proposed a heuristic method to balance stochastic assembly line including labor costs. Buxey (1974) modified a positional weight method to balance assembly line containing identical parallel stations. Kao (1976) balanced an assembly line with stochastic task times using a dynamic model to decrease number of stations. Rosenblatt and Carlson (1985) proposed a solution procedure to improve production profit while minimizing number of assembly stations. Henig (1986) suggested a dynamic programming technique to balance an assembly line, to minimize number of stations given a cycle time. Johnson (1983) devised a branch and bound technique to minimize number of stations while balancing an assembly line. Shtub and Dar-El (1989) presented a methodology to select the best assembly systems based on different costs: research and development, production and acquisition, operating and support and finally retirement and disposal. He and Kusiak (1997) proposed a heuristic algorithm based on Tabu search approach to configure and schedule modular product family assembly on an assembly line. The drawback in their method is that the combined shared platform is assumed constant and obtained a priori. A survey discusses different balancing and sequencing techniques of serial and U-shaped

assembly lines is found in (Scholl 1999). Many useful surveys on assembly line balancing and production flow lines can be found in Erel and Sarin (1998). Sparling (1998) developed 3 different heuristics to balance multiple U-shaped assembly lines. Researchers have also considered obtaining the product platform from a family of products. However, this was done using heuristics and graph theory considering only precedence constraints, and did not take into account demand effect on product platform (De Lit et al. 2003). A large number of heuristics, meta-heuristics and exact methods had been proposed to balance different variations of assembly line ((Scholl and Becker (2006), Boysen et al. (2007), Boysen et al. (2009) and Ritt and Costa (2011)). Cladistics – used in biology - and DSM are used to define possible products platforms which can be used to construct an assembly layout (ElMaraghy et al. (2008), AlGeddawy and ElMaraghy (2010b) and ElMaraghy and AlGeddawy (2014)). However, in available literature, the researchers did not consider the use of both assembly and disassembly of components to increase the platform ability to derive more products.

All previously proposed models (Chapter 2, 3, and 4) deal with products and platforms without considering their assembly lines. This is normally the case in nearly all literature except very few researchers (He and Kusiak (1997) , AlGeddawy and ElMaraghy (2010b)) who proposed models that deal with both product platforms and assembly lines. A unified model capable of co-designing products platforms and assembly systems simultaneously is needed. The model should be able to form product families and assign them to suitable product platforms. The relatively new concept of combined assembly and disassembly to customize product platforms would be beneficial to use as well. The application of this concept can increase the amount of shared component across different products to form one shared platform. The proposed novel unified model is considered one of the very few models that effectively combine the design of product platforms and assembly systems.

The scope of application of this model includes –like previous models – different modular products such as computers, electronic goods, weighing scales, home appliances...etc. To conclude, the research gap in the literature can be explained by Figure 5.2, where it is needed to design an assembly line that enables obtaining both product platforms and product families' formation using assembly/disassembly of components. Hence, delayed product differentiation is enabled to provide mass customization advantage. As a result, the corporation will have faster market response and minimal lead time.

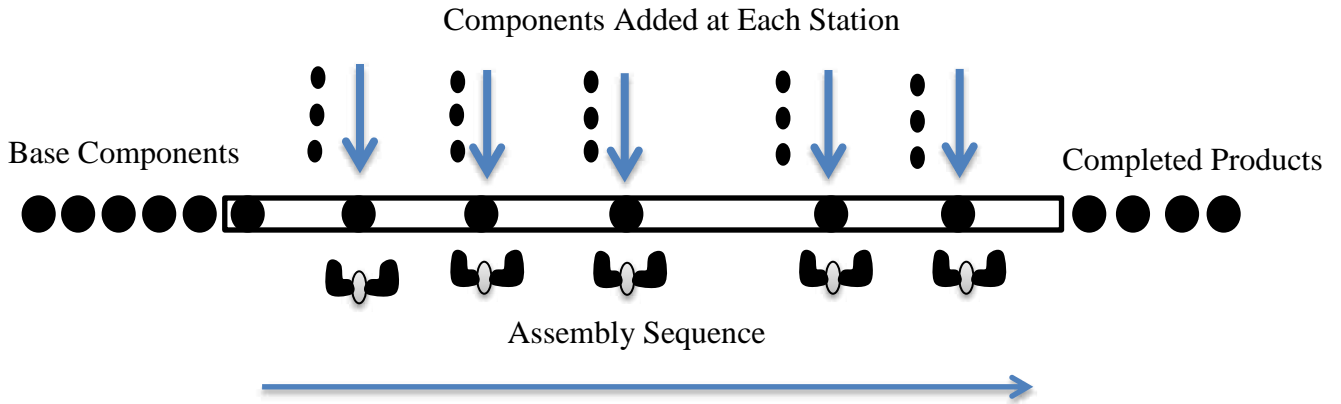

Figure 5.1 Manual assembly line representation

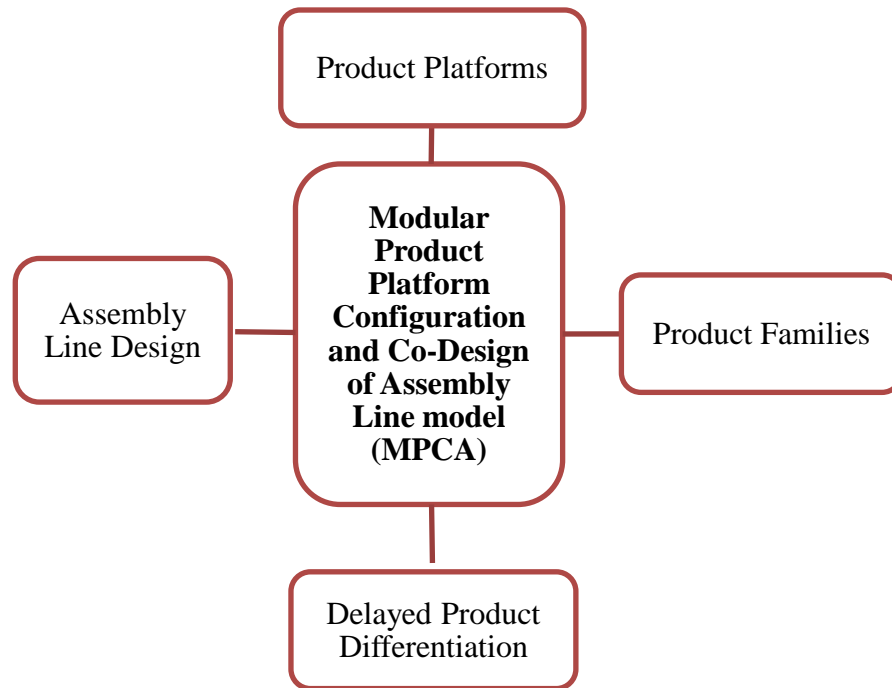

Figure 5.2 Modular product platform configuration and co-design of assembly line model

5.2 Model Development

The following mathematical model describes a mixed model manual assembly line that produces product platforms and families, and upon advance through the line, the platforms become more customized and differentiated to suit the requirements for various product variants. The model includes a mixture of parameters related to products families, platforms, and the assembly system parameters. In the previous product platform models, the costs of the assembly were explicitly

expressed. However, assembly and disassembly times are used in the combined model to represent assembly cost (Figure 5.3).

It is assumed that mass production stations will only assemble platform components or similar components to the assembled platform. This is a valid assumption, since large number of each product platform is needed for each product family. The non-platform stations will be assigned different assembly and/or disassembly operations. Therefore, it is assumed that each component has three different operation times. If the component is assembled at a platform station, then it has the smallest time of assembly (Mass production). If the component is assembled by a non-platform station, then it two times (Assembly or disassembly times) may be used depending on whether it is assembled or disassembled.

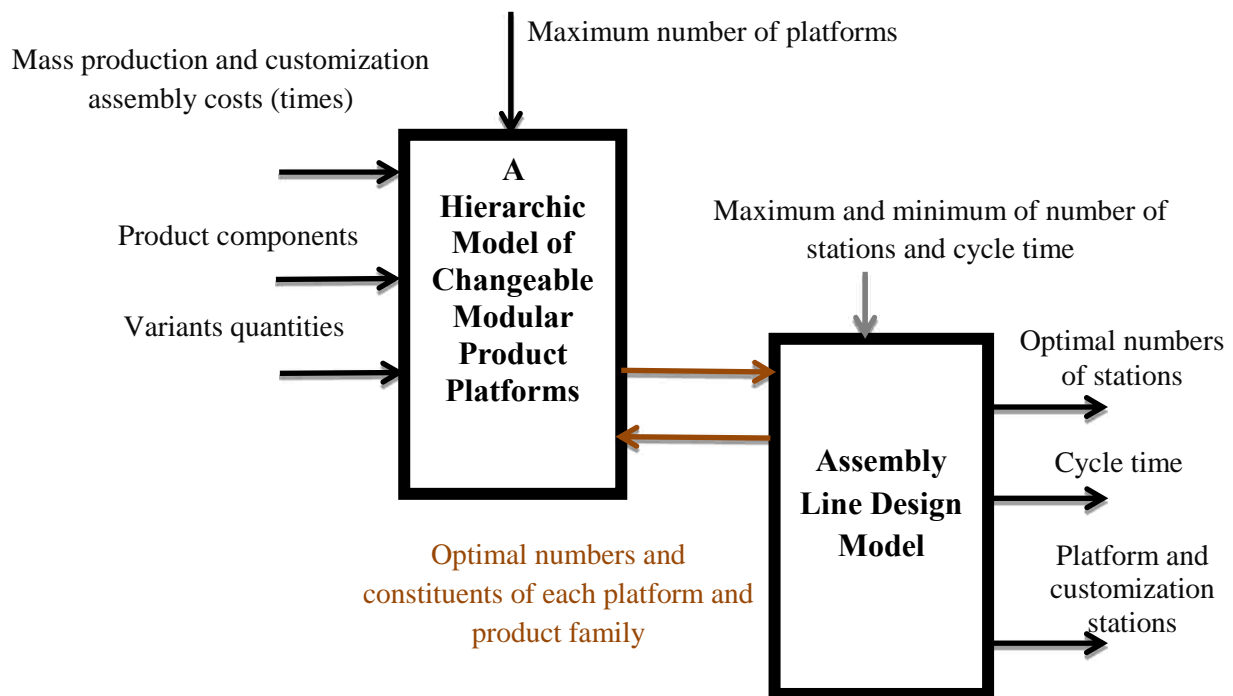

Figure 5.3 IDEF0 of modular product platform configuration model and co-design of assembly line

For the formulation of this model, several assumptions are assumed:

1. Mass production stations will only assemble platform components or similar components to the assembled platform components.
2. Non-platform stations are assigned customization assembly and disassembly operations.
3. Each component has three different times: mass assembly, customization by assembly, and customization by disassembly times.

4. Time of mass assembly of a component is less than customization by assembly time. This assumption is also valid since the learning curve for platform components assembly is much higher than that for other assembly and disassembly operations.
5. Customization by assembly time is less than customization by disassembly time. This is true for most components except for permanently joined ones.

The product platforms system model has two types of parameters and variables: product parameters and assembly line parameters. Different parameters and variables are used (e.g. $a_{ijdk}, r_{ijdk}, y_{ik}$) since the co-design model parameters use time instead of assembly costs:

t_{aj} : Time of component j assembly to a certain platform on a non-platform assembly station.

t_{rj} : Time of component j disassembly from a certain platform on a non-platform assembly station.

t_{pj} : Time of component j assembly on a platform assembly station.

u_j : Maximum number of components that can be assembled directly after component j

NS : Numbers of shifts

Efficiency: Assembly line utilization (assume a value of 0.7)

ND : Number of days (equal to one if not mentioned)

TS : Time of each shift (seconds)

$UB2$: Maximum cycle time

$LB2$: Minimum cycle time

$UB1$: Maximum number of stations

$LB1$: Minimum number of stations

s : Maximum number of stations

AA : The first dummy component in any product

5.3 The Assembly Line Design Variables

New variables are introduced to completely define assembly line design. Other variables are also introduced to assign different platforms and families to different stations as follows:

C: Optimized maximum cycle time

$$s_q = \begin{cases} 1, & \text{if station } q \text{ exists} \\ 0, & \text{otherwise} \end{cases}$$

$$x_{qijdk} = \begin{cases} 1, & \text{if component } d \text{ is assembled after component } j \\ & \text{in platform } i \text{ to form product } k \text{ at station } q \\ 0, & \text{otherwise} \end{cases}$$

$$y_{qijdk} = \begin{cases} 1, & \text{if component } d \text{ is disassembled from component } j \\ & \text{in platform } i \text{ to form product } k \text{ at station } q \\ 0, & \text{otherwise} \end{cases}$$

$$z_{qijd} = \begin{cases} 1, & \text{if component } d \text{ is assembled after component } j \\ & \text{in platform } i \text{ at station } q \\ 0, & \text{otherwise} \end{cases}$$

$y^4_{qijdk}, y^5_{qijdk}, y^6_{qijdk}, y^7_{qijdk}, y^8_{qijdk}, y^9_{qijdk}$: Linearization variables

$\lambda_1, \lambda_2, \lambda_3, \lambda_4, \lambda_5, \lambda_6, \lambda_7, \lambda_8$: Piecewise approximation variables (from 0 to 1)

y_1, y_2, z_1, z_2 : Piecewise approximation variables (continuous variables)

ee, ff, g, h : substitution variables for the upper and lower bounds of cycle time and number of stations

5.4 Mathematical Model Development

The co-design model uses nonlinear integer programming. The model consists of three main parts: product platform configuration, assembly line balancing, and the feedback loop between them. The feedback loop represents constraints which combine variables and parameters of both products platforms and the assembly line parts of the model to achieve their integration. The set of constraints (5.2 - 5.9) has been discussed in previous models:

$$\text{Minimize } C * \sum_{q=1}^t S_q \quad (5.1)$$

Subject to:

$$\sum_{i=1}^l y_{ik} = 1, \quad k = 1, \dots, n \quad (5.2)$$

$$a_{ijdk} + (1 - P_{kjd} + s_{ijd}) \geq y_{ik}, \quad i = 1, \dots, l; \quad j = 1, \dots, m; \quad k = 1, \dots, n; \quad d \neq j; \quad d \neq AA \quad (5.3)$$

$$a_{ijdk} \leq y_{ik}, \quad i = 1, \dots, l; \quad j = 1, \dots, m; \quad k = 1, \dots, n; \quad d \neq j; \quad d \neq AA \quad (5.4)$$

$$r_{ijdk} + (1 + P_{kjd} - s_{ijd}) \geq y_{ik}, \quad i = 1, \dots, l; \quad j = 1, \dots, m; \quad k = 1, \dots, n; \quad d \neq j; \quad d \neq AA \quad (5.5)$$

$$r_{ijdk} \leq y_{ik}, \quad i = 1, \dots, l; \quad j = 1, \dots, m; \quad k = 1, \dots, n; \quad d \neq j; \quad d \neq AA \quad (5.6)$$

$$1 + s_{ied} \geq s_{idl} + P_{kjl} y_{ik}, \quad i = 1, \dots, l; \quad e, d, j = 1, \dots, m; \quad k = 1, \dots, n; \quad e \neq d; \quad d \neq j; \quad l \neq AA; \quad ; \quad l \neq j \quad (5.7)$$

$$\sum_{d=1}^m s_{ijd} \leq u_j, \quad i = 1, \dots, l; \quad j = 1, \dots, m; \quad d \neq j; \quad d \neq AA \quad (5.8)$$

$$M \sum_{k=1}^n y_{ik} \geq s_{ijd}, \quad i = 1, \dots, l; \quad j = 1, \dots, m; \quad d \neq j; \quad d \neq AA \quad (5.9)$$

Assigns each customization by assembly of a component to the product platform to derive a new product to only one assembly station.

$$\sum_{q=1}^s x_{qijdk} = a_{ijdk}, \quad d \neq j; \quad d \neq AA \quad (5.10)$$

Assign each customization by disassembly of a component from a platform to derive a new product to only one station

$$\sum_{q=1}^s y_{qijdk} = r_{ijdk}, \quad d \neq j; \quad d \neq AA \quad (5.11)$$

Assign each platform component to be assembled to only one station

$$\sum_{q=1}^s z_{qijda} = s_{ijda}, \quad d \neq j; \quad d \neq AA \quad (5.12)$$

Forces the total of assembly, disassembly or mass assembly operations done on any station to be less than cycle time.

$$\left(\sum_{i=1}^l \sum_{j=1}^m \sum_{k=1}^n x_{qijak} a_{ijak} t_{aj} + y_{qijak} r_{ijak} t_{rj} \right) + \left(\sum_{i=1}^l \sum_{j=1}^m z_{qijda} s_{ijda} t_{pj} \right) \leq C, \quad q = 1, \dots, s \quad (5.13)$$

Constrains the total time of operations to be less than the total allowable time.

$$\sum_{q=1}^s \sum_{i=1}^l \sum_{j=1}^m \sum_{k=1}^n x_{qijdk} a_{ijdk} t_{aj} + y_{qijdk} r_{ijdk} t_{rj} + z_{qijd} x_{ijd} t_{pj} \leq Efficiency * NS * ND * TS * C * \sum_{q=1}^t S_q \quad (5.14)$$

Ensures that no station should exist if no operation is assigned to it.

$$\sum_{i=1}^l \sum_{j=1}^m z_{qijd} + \sum_{i=1}^l \sum_{j=1}^m \sum_{k=1}^n x_{qijdk} + \sum_{i=1}^l \sum_{j=1}^m \sum_{k=1}^n y_{qijdk} \geq S_q, \quad d \neq j; d \neq AA \quad (5.15)$$

Forces a station to exist in the case of presence of any operation (assembly disassembly or mass production).

$$\sum_{i=1}^l \sum_{j=1}^m z_{qijd} + \sum_{i=1}^l \sum_{j=1}^m \sum_{k=1}^n x_{qijdk} + \sum_{i=1}^l \sum_{j=1}^m \sum_{k=1}^n y_{qijdk} \leq M S_q, \quad d \neq j; d \neq AA \quad (5.16)$$

Ensures that mass assembly of platform components is before any customization by assembly for that platform.

$$\sum_{q=1}^s q z_{qiaf} \leq M(2 - y_{ik} - a_{ijpk}) + \sum_{q=1}^s q x_{qijpk}, \quad i = 1, \dots, l; d, f, j, p = 1, \dots, m; d \neq f; j \neq p; f \neq AA; p \neq AA; k = 1, \dots, n \quad (5.17)$$

Ensures that mass assembly of platform components is before any customization by disassembly assembly for that platform.

$$\sum_{q=1}^s q z_{qiaf} \leq M(2 - y_{ik} - r_{ijpk}) + \sum_{q=1}^s q y_{qijpk}, \quad i = 1, \dots, l; d, f, j, p = 1, \dots, m; d \neq f; j \neq p; f \neq AA; p \neq AA; k = 1, \dots, n \quad (5.18)$$

Ensures the right precedence of platform mass assembly of components.

$$\sum_{q=1}^s q z_{qija} \leq M(2 - y_{ik} - s_{ief}) + \sum_{q=1}^s q z_{qief}, \quad i = 1, \dots, l; d, j = 1, \dots, m \text{ where } d \neq j; k = 1, \dots, n \quad (5.19)$$

Ascertain that no customization by assembly should happen on a platform station.

$$(1 - z_{qief}) \geq x_{qijdk}, \quad q = 1, \dots, s; \quad i = 1, \dots, l; d, j = 1, \dots, m; \quad d \neq j; e \neq f; j = e \text{ or } j = f; d \neq AA; f \neq AA; k = 1, \dots, n \quad (5.20)$$

$$(1 - z_{qief}) \geq y_{qijdk}, \quad q = 1, \dots, s; \quad i = 1, \dots, l; d, j = 1, \dots, m; \quad d \neq j; e \neq f; j = e \text{ or } j = f; d \neq AA; f \neq AA; k = 1, \dots, n \quad (5.21)$$

Forces only one component in a platform to be assembled on a station.

$$\sum_{i=1}^l \sum_{j=1}^m \sum_{d=1}^m z_{qija} \leq 1, \quad d \neq j; \quad q = 1, \dots, s \quad (5.22)$$

Enables more platform components to be assembled on the same station with the dummy component (AA).

$$\sum_{j=1}^m \sum_{f=1}^m z_{qijf} + M(1 - z_{qbd}) \geq 2 \quad , \quad q = 1, \dots, s; \quad i = 1, \dots, l; \quad j \neq 1, \text{ where } b = \text{dummy component in a platform} \quad (5.23)$$

Preserves the assembly sequence of the customization by assembly components.

$$\sum_{q=1}^s qx_{qifjk} \leq M(2 - y_{ik} - a_{ijpk}) + \sum_{q=1}^s qx_{qijpk} \quad , \quad i = 1, \dots, l; \quad d, f, j, p = 1, \dots, m; \quad d \neq f; \quad j \neq p; \quad p \neq AA; \quad k = 1, \dots, n \quad (5.24)$$

Forces the model to disassemble any components from a platform before any needed assembly took place.

$$\sum_{q=1}^s qy_{qijfk} \leq M(3 - y_{ik} - a_{ijpk} - r_{ijfk}) + \sum_{q=1}^s qx_{qijpk} \quad , \quad i = 1, \dots, l; \quad d, f, j, p = 1, \dots, m; \quad d \neq f; \quad j \neq p; \quad p \neq AA; \quad k = 1, \dots, n \quad (5.25)$$

5.5 Linearized Product Platform Assembly Line Model

The above model is highly nonlinear. Therefore, a linearization scheme adopted and modified from (Peterson 1978) is used. In sets of constraints (5.13) and (5.14), three terms contain six binary variables, each two are multiplied by each other and replaced by one binary variable and two sets of constraints as follows:

$$\sum_{i=1}^l \sum_{j=1}^m \sum_{k=1}^n (y4_{qijk}t_{aj} + y5_{qijk}t_{rj}) + \sum_{i=1}^l \sum_{j=1}^m y6_{qijd}t_{pj} \leq C \quad , \quad q = 1, \dots, s \quad (5.26)$$

$$x_{qijk} \geq y4_{qijk} \quad (5.27)$$

$$y4_{qijk} \geq a_{ijk} + (x_{qijk} - 1) \quad (5.28)$$

$$y_{qijk} \geq y5_{qijk} \quad (5.29)$$

$$y5_{qijk} \geq r_{ijk} + (y_{qijk} - 1) \quad (5.30)$$

$$z_{qijd} \geq y6_{qijd} \quad (5.31)$$

$$y6_{qijd} \geq r_{ijk} + (z_{qijd} - 1) \quad (5.32)$$

$$\sum_{q=1}^s y7_{qijk}t_{aj} + y8_{qijk}t_{rj} + y9_{qijk}t_{pj} \leq Efficiency * NS * ND * TS * C * \sum_{q=1}^t s_q \quad (5.33)$$

$$y4_{qijk} \geq y7_{qijk} \quad (5.34)$$

$$y7_{qijk} \geq y_{ik} + (y4_{qijk} - 1) \quad (5.35)$$

$$y5_{qijdk} \geq y8_{qijdk} \quad (5.36)$$

$$y8_{qijdk} \geq y_{ik} + (y5_{qijdk} - 1) \quad (5.37)$$

$$y6_{qijdk} \geq y9_{qijdk} \quad (5.38)$$

$$y9_{qijdk} \geq y_{ik} + (y6_{qijdk} - 1) \quad (5.39)$$

In both of the objective function and constraint set (5.14), two multiplied continuous variables exist: C and $\sum_{q=1}^t s_q$. These two variables require different linearization method (Williams (1999), this because in previous chapters, one of the multiplied variables was binary. This enables the use of Peterson (1971), while in the present case, the two variables are continuous. This continuity requires the following procedure: the product of these two variables (C and $\sum_{q=1}^t s_q$) is substituted by two non-linear but separable variables: $y_1^2 - y_2^2$ - and Equations (5.39 to 5.48). The upper and lower bounds for both number of stations and cycle time is given by Equations (5.41 and 5.42). Equations (5.43 to 5.46) are the new boundaries for y_1 and y_2 , respectively. The new objective now is to minimize $y_1^2 - y_2^2$.

Where:

$$y_1 = \frac{1}{2}(\sum_{q=1}^t s_q + C) \quad (5.40)$$

$$y_2 = \frac{1}{2}(\sum_{q=1}^t s_q - C) \quad (5.41)$$

$$LB1 \leq \sum_{q=1}^t s_q \leq UB1 \quad (5.42)$$

$$LB2 \leq C \leq UB2 \quad (5.43)$$

$$ee = \frac{1}{2}(LB1 + LB2) \quad (5.44)$$

$$ff = \frac{1}{2}(UB1 + UB2) \quad (5.45)$$

$$g = \frac{1}{2}(LB1 - UB2) \quad (5.46)$$

$$h = \frac{1}{2}(UB1 - LB2) \quad (5.47)$$

$$ee \leq y_1 \leq ff \quad (5.48)$$

$$g \leq y_2 \leq h \quad (5.49)$$

The new objective function contains two quadratic but separable functions. Therefore, the next step is to approximate each of the non-linear terms (y_1^2 and y_2^2) using piece-wise linear approximation:

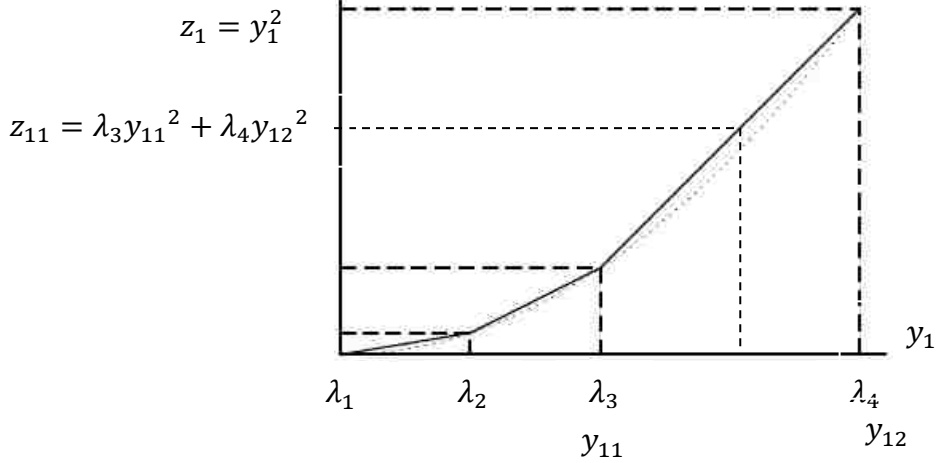

Figure 5.4 Piece-wise linearization scheme

Each of the two parabola's representing y_1^2 and y_2^2 is approximated by 3 segments and four points (Figure 5.4). Each point (z_1) on the approximated segments is calculated using a combination of y 's and λ 's. For example, consider the following value:

$$z_{11} = \lambda_3 y_{11}^2 + \lambda_4 y_{12}^2 \quad (5.50)$$

In the latter case, the unknowns are the λ 's and the z 's. The entire y 's are functions in the upper bound and lower bounds of the cycle time and number of stations. The following equalities are a derived generalization of the piecewise linearization scheme to fit in the proposed model. For z_1 and y_1^2 :

$$\lambda_1 + \lambda_2 + \lambda_3 + \lambda_4 = 1 \quad (5.51)$$

$$\lambda_1(ee) + \lambda_2(ee + (ff - ee)/3) + \lambda_3(ff - (ff - ee)/3) + \lambda_4(ff) = y_1 \quad (5.52)$$

$$\lambda_1(ee^2) + \lambda_2((ee + (ff - ee)/3)^2) + \lambda_3((ff - \frac{ff-ee}{3})^2) + \lambda_4(ff^2) = z_1 \quad (5.53)$$

For z_2 and y_2^2 :

$$\lambda_5 + \lambda_6 + \lambda_7 + \lambda_8 = 1 \quad (5.54)$$

$$\lambda_5(g) + \lambda_6(g + (h - g)/3) + \lambda_7(h - (h - g)/3) + \lambda_8(h) = y_2 \quad (5.55)$$

$$\lambda_5(g^2) + \lambda_6((g + (h - g)/3)^2) + \lambda_7((h - \frac{h-g}{3})^2) + \lambda_8(h^2) = z_2 \quad (5.56)$$

Using the previous linearization, the final objective function to be minimized is $z_1 - z_2$. These two variables represent the approximation of the multiplication of number of stations and the maximum cycle time. The set of constraint (5.33) are modified to become:

$$\sum_{q=1}^S \gamma_{qijk}^7 t_{aj} + \gamma_{qijk}^8 t_{rj} + \gamma_{qija}^9 t_{pj} \leq Efficiency * NS * ND * TS * (z_1 - z_2) \quad (5.57)$$

5.6 Example

Two different scenarios are used. The first one is to demonstrate product platform customization solely by assembling additional components/modules. The second scenario illustrates customization using both disassembly and assembly of components/modules. The illustrating example used in chapter 2 will be used to test the new co-design model. The example is composed of four products with 9 components each. The following parameters are used:

- Maximum number of platforms (l) = 2
- Maximum number of stations ($UB1$) = 15
- Minimum number of stations ($LB1$) = 5
- Minimum expected cycle time ($LB2$) = 2
- Maximum expected cycle time ($UB2$) = 10
- Assembly time of platform components = 2
- Customization assembly time of components = 4
- Customization disassembly time of components = 3
- Variants demand for [Product 1, Product 2, Product 3, Product 4] = [700 100 100 100]
- Maximum number of components that can be directly assembled after component j (u_j) = 2

5.7 Results of Scenario A

The mathematical model is programmed using AMPL and solved using CPLEX12.51. The assembly line co-design results are:

- Maximum cycle time = 8 seconds
- All products are customized using one platform containing components A and B.
- Total number of assembly stations = 8.

The model results regarding platform and product assignment to stations are shown in (figure 5.5). The main platform is mass assembled on station 1. The product platform is forwarded to stations 2 and 3. Component D is assembled in station 3 for two different products 1 and 2. Station 2 assembles component C to products 3 and 4. Station 4 receives two types of in-process products: component F is assembled to in-process product 2, component G is assembled to in-process product 4. Station 7 assembles components C and F to products 1 and 3, respectively. Station 9 receives in-process products from stations 7 and 4. Products 1 and 2 are finalized on station 9 by assembling components E to both of them. Station 10 finalizes in-process products 3 and 4 by assembling components E and H, respectively. The obtained layout does not represent any similar assembly

layout. The new layout is considered a hybrid of flow line (platform stations), cells (stations that produce same products are close) and functional layout (stations assemble same component to different products). It is similar to the modular assembly layout concept. Many companies use this type of layouts, but based on experience not on mathematical foundations. The model enabled delayed product differentiation by forming a common platform (A and B), then assembling components successively to derive new product variants from this platform.

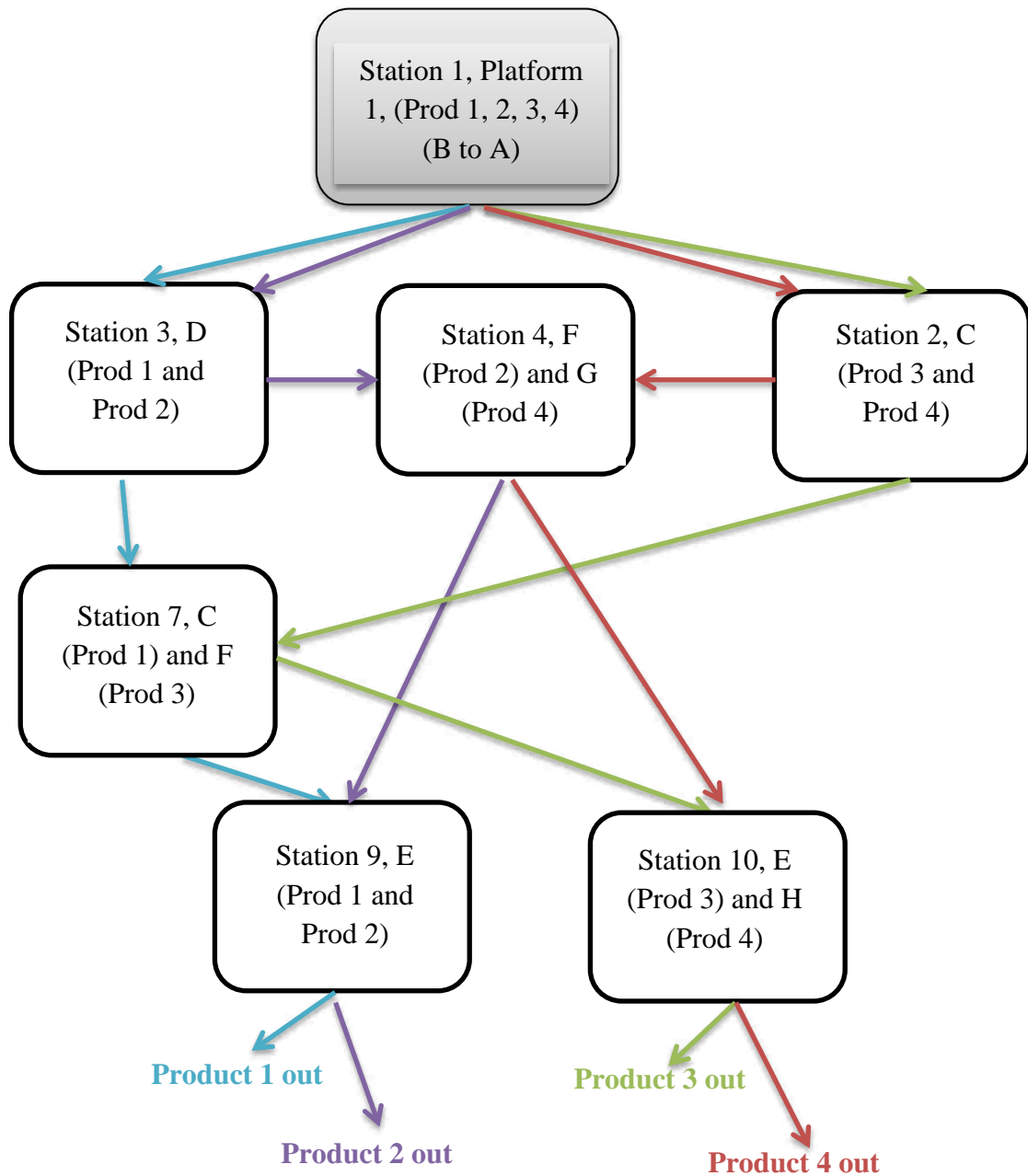

Figure 5.5 Model output containing products and platforms assignments for the first scenario (i.e. mass assembly and customization by disassembly)

In the previous example, only customization by assembly took place. New parameters are used to illustrate products customization by disassembling components/modules to derive products from the mass assembled product platforms:

- Maximum number of stations ($UB1$) = 12
- Number of platforms = 1
- Minimum number of stations ($LB1$) = 5
- Minimum expected cycle time ($LB2$) = 2
- Maximum expected cycle time ($UB2$) = 15
- Assembly time of platform components = 2
- Customization assembly time of components = 7
- Customization disassembly time of components = 3
- Number of days = 10
- Variants demand scenario [Product 1, Product 2, Product 3, Product 4] = [700000 100000 10000 10000]

5.8 Results of Scenario B

Figure 5.6 shows the complete assembly line layout. One platform containing components A, B and D. Components A and B are assembled on station 1, while component D is assembled to component B at station 2. The model showed that component D should be disassembled from those platforms dedicated to derive product 4. This means that station 2 does not need to assemble it from the beginning and should forward platforms used for product 4 to station 4 directly. Station 3 disassembles component D and assemble component C to derive in-process product 3. Station 4 assembles component C to in-process product 4. Station 5 assembles component F to in-process product 2 and assembles component G to in-process product 4. Station 6 performs two assembly operations: component C to in-process product 1 and component E to product 3. Product 1 and 2 are finalized at station 7 by assembling component E to both of them. Products 3 and 4 are finalized in station 8 by assembling F to product 3 and H to product 4. The obtained assembly layout is different than the first scenario. Although the two scenarios have one platform to derive the all of the products, but the composition of each platform is different. The platform in the scenario B has an additional D component because of the large quantities of products 1 and 2 to be produced. These two products and the platform share components A, B, and D. Similar to the scenario A, the layout represents a mixture of flow line, functional and cellular layouts. Most researchers adopt one type of layouts (e.g. serial line, U-shaped) when designing and proposing mathematical models for their proposed systems. This limitation is overcome by the proposed model, which co-designs

product families and platforms with their assembly systems without restrictions on the line layout shape.

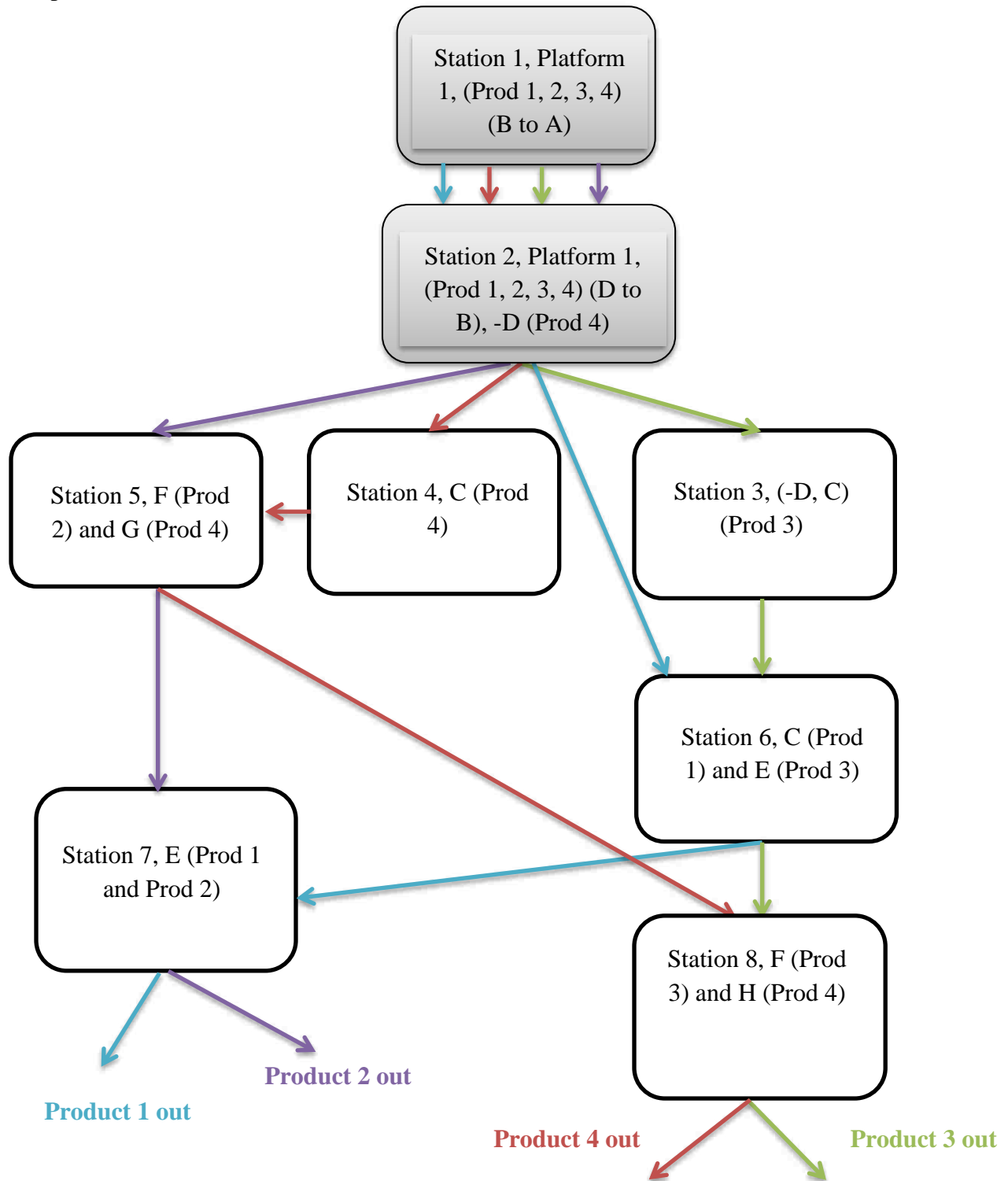

Figure 5.6 Model output containing products and platforms assignments for the second scenario - mass assembly, customization by assembly and disassembly.

5.9 Model Verification

Some model performance testing using parameters in the proposed model are carried out to evaluate the model. In this section, the number of days allowed for assembly (ND) or lead time, customization by disassembly time (t_{aj}), and line Efficiency are varied to show their effect on the resulting product platform composition. Except for the tested parameters, other parameters values are taken from scenario B. Table 5.1 shows that by increasing lead time, the number of platform components is decreased. This can be interpreted as: tight lead time schedules necessitate the presence of mass-assembled platforms that contain the most common shared components. This mass-assembled platform decreases the overall assembly time by including more components which validates the model result. It is expected that by increasing customization disassembly time (i.e. a component that need a lot of time to be disassembled), the model should not use the concept of disassembly. Table 5.2 confirms this assumption because the number of platform components decreased when the disassembly costs increased significantly relative to other costs. This also supports the model results. The model is also sensitive to the line efficiency. No solution is obtained when line efficiency drops to less than 70%. This is another evidence of the validity and the expected responsiveness of the model to changed parameters.

Table 5.1 Effect of days allowed for assembly (ND) on platform composition

Number of days allowed for assembly (ND) or lead time	Platform composition
2	A, B, D
3	A, B, D
6	A, B
9	A, B
15	A, B

Table 5.2 Effect of customization by disassembly time (t_{aj}) on platform composition

Customization by disassembly time (t_{aj}) (seconds)	Platform composition
3	A, B, D
10	A, B, D
15	A, B, D
20	A, B, D
30	A, B

Table 5.3 Effect of line efficiency on platform composition

Line Efficiency	Platform composition
0.1	Infeasible solution
0.3	Infeasible solution
0.5	Infeasible solution
0.7	A, B, D
0.99	A, B, D

5.10 Contributions

Many contributions have been made in this chapter:

- A new holistic model, Modular product Platform configuration and Co-design of Assembly line (MPCA), has been proposed and implemented. The model combines Product families, platforms and assembly lines design and allow their co-design.
- The model has been tested, analyzed, discussed and validated.
- The main hypothesis of this thesis that assembly lines can be co-designed with product families and platforms has been proven.

5.11 Conclusions

Fluctuating market demands and changeable customer requirements increase the need for product variety. Although product variety provides companies with competitive edge, it places pressure on its manufacturing facilities and capabilities. This negative effect can be relieved by careful design of product families and platforms. Past research always dealt with product platforms and their assembly and manufacturing lines as two separate activities. The proposed mathematical model, Modular product Platform configuration and Co-design of Assembly line (MPCA), provides a new framework to co-design products, their platforms and assembly systems. The model utilizes the principle of combined assembly and disassembly modular product platforms. These product platforms contain the most common components across the product family which can be further customized. The customization includes disassembly of existing components and/or the assembly of new ones. The model obtains optimal or near optimal: product families, product platforms, components to be assembled, and components to be disassembled, number of assembly stations, platform and non-platform components assignment, and cycle time. Due to the use of combined assembly and disassembly principle the model can postpone the differentiation point of different product platforms effectively. The model is validated by measuring model performance using multiple scenarios by varying different parameters including: assembly lead time, customization by disassembly time and assembly line efficiency. This novel model closes a literature gap by integrating assembly line design with products' families and platform configuration. In addition, it introduces an objective function that minimizes both of number of assembly stations and maximum allowable cycle time. This full integration between product platforms and assembly line design will

improve productivity of designers, and enable significant cost reductions and savings for manufacturing corporations.

Chapter 6

Conclusions and Future work

6 Discussion

Mass customization is becoming essential for manufacturing companies to gain competitive edge. Product platform formation and product families design is important enabler of mass customization. With careful design of product platforms and families, the manufacturers can reap the benefits of delayed product differentiation which postpones the differentiation point of a product platform to form different products. By implementing delayed differentiation techniques, assembly and inventory costs can be minimized. Manufacturers become more responsive and adaptable to fluctuating markets and customer demands.

There are three main categories of product platforms: modular, scalable, and functional. Many of consumer goods belong to the modular category, where different modules or parts and their numerous versions constitute the product. Product platforms require that products have a certain level of modularity and commonality, especially when taking into account assembly costs. To increase the level of commonality, a relatively new concept of simultaneous assembly and disassembly of components to customize their platform into the final product variants is used throughout the presented research. The assembly/disassembly principle relies on increasing the level of commonality by including components that are not shared amongst all product variants. Afterwards, these components are disassembled from the platform to obtain different products.

6.1 Achievements

Five different models and one metric have been proposed to fill and fix research gaps in the domain of products platform formation.

- A median-joining phylogenetic network is used to determine the number of platforms and their composition. This type of network is used extensively in biology to determine ancestors of a certain group of species and their inter-relations. The network is used to construct an assembly line layout showing obtained platforms. Postponement effectiveness metric to measure the used network effectiveness in delaying the point of differentiation has been developed. The metric is used to test results of a network representing a family of household kettles. The results of applying the metric showed that the used Median-Joining Phylogenetic Network was much effective in determining number of platforms, and postponing product differentiation than other techniques.

- A new mathematical model, Modular Product Multi-Platform Configuration Model, was proposed to include more aspects of product platforms like: flexible platform determination, assembly, disassembly and components costs. The model is able to obtain sub-families of the main product family. Each sub-family uses a separate product platform to minimize mass customization and assembly costs. The model is linear, which reduces computation time when dealing with large

number of products and components. A sensitivity analysis was carried out to test the correlations between total costs of products assembly and other different costs (i.e. labor training costs, customization by assembly and disassembly costs). Labor training and customization by assembly cost are proportional to the total costs. Customization by disassembly cost has an undetermined relation with total costs of products assembly. In some cases, increasing the product platform customization by allowing disassembly of some components/modules increases the total assembly costs and sometimes the decreases the total assembly costs. Therefore, each demand scenario requires some experimentation to determine the optimal disassembly cost that corresponds to the lowest total costs of products assembly.

- A novel mathematical model, Hierarchical Changeable Modular Product Platforms Model, is proposed to obtain both of hierarchy and composition of product platforms. In addition, the platform hierarchy model determines the optimal number of platforms and their respective product families. The platform hierarchy is introduced to eliminate potential errors in calculating cost when duplicate components exist.
- A novel Multi-Period Multi-Platform mathematical model has been introduced to consider costs and quantities of inventories with product platform and families formation. The model decreased the inventories of the platforms and products to their minimal level. It favors not to use the assembly and disassembly principle for customizing products platforms if inventories quantities and costs are considered.
- A new unified model, Modular product Platform configuration and Co-design of Assembly line model, has been introduced. It is one of the very few models introduced to address a large number of assembly and products aspects. This model is used to find optimal product families, platforms, number of assembly stations, cycle time, products and platforms assignments. The model proved that combined assembly and disassembly concept is preferable in case of single platforms with small number of assembly stations. The model also demonstrated that the optimal number of components is inversely proportional with the allowable lead time. In other words, mass assembly of platforms with large portion of components is needed for short lead times. The model shows that large disassembly costs obtain optimal platforms with small number of components. In that case, the number of components to be disassembled is zero, because the model will favour only mass assembly and customization by assembly processes. All of the models are linearized, to enable them to deal with more products and components than the most similar models found in literature.

6.2 Conclusions

Important conclusions which are derived based on the outcome of this research can be summarized as follows:

- Customization of platforms by disassembling components from the product platform to derive product variants is not suitable when the disassembly times are larger than assembly and mass assembly times of components.
- The number of platform can be determined optimally using the proposed models, with only specifying its maximum value (upper limit).
- Median-Joining Phylogenetic Network, which is used in biological classification, can be used to determine optimal number of families and platform composition for a group of products.
- Median-Joining Phylogenetic cannot incorporate costs or product demand when forming the platform. This can make this method less effective compared to mathematical modeling.
- Using the combined assembly and disassembly of components to form common platforms, and derive product variants from them has many benefits: decreasing lead time, decreasing work-in-process and finished products inventory, and delays the product differentiation point.
- Total assembly costs of products and their platform is proportionate with cost of labor training and costs of customization of platforms by assembly.
- Feasibility of using product platform customization by disassembly is affected by allowable or maximum number of platforms, costs of customization by disassembly and the costs of the products components.
- It has been proven that increasing number of components in products increases the solution time of the Modular Product Multi-Platform Configuration model more than increasing the number of product variants.
- It is important to know the composition of a product platform, but it is equally important to know the platform hierarchy or the components 'precedence within it.
- In the proposed Multi-Period Multi-Platform Configuration model, customization by disassembly is not favored by the model when inventory costs and quantities are included. Therefore, it can be concluded that customization by disassembly to derive products from platforms is more suitable for just-in-time assembly philosophy.
- Increasing or decreasing companies' capacities for platform and product production does not lower total costs beyond a certain point.
- Co-design of product platforms, families and assembly line using combined assembly /disassembly of components can be done simultaneously using mathematical modeling.
- Using of customization by disassembly in the co-design of product platforms, families and assembly line is favored by the model when having: large number of assembly stations, large products demand and large customization by assembly times.
- It has been proven that lead time decrease will lead to common platform with more number of mass-assembled components.
- Customization by disassembly has also an inverse effect on number of components in a platform (i.e. increased disassembly times promotes small number of platform components).
- Large increase in disassembly times leads the model to favor using of customization by assembly only.

- Low assembly line efficiency totally prevents the formation of platforms and produces infeasible solutions.

6.3 Significance

The proposed models for designing optimal products families and platforms, platforms hierarchies, assembly lines and metric developed for postponement effectiveness comparisons between different assembly layouts will enable effective modular product platform and families design, based on assembly costs and product components and modules. The delayed product differentiation strategy will be enhanced by increasing commonality of components by using assembly/disassembly platform concept. The assembly lines design will move into another frontier, Co-design of assembly lines with product platforms and families will be enhanced by taking into consideration the principles of delayed product differentiation. A new area of products-systems co-design, using assembly/disassembly of components to derive products from platforms, has been suggested using the proposed research. This topic is a very promising direction for future research.

The proposed models have significant benefits as they enable manufacturers to deal effectively and simultaneously with product platform and families' formation, and assembly line design. The application of this research findings and models would enhance product variants assembly productivity and, hence, provide manufacturers with a competitive edge in responding to changing market demands.

6.4 Limitations

The developed models have some limitations:

- The Phylogenetic Network does not consider the components and assembly cost, this may produce sub-optimal point of delayed differentiation.
- Although the Phylogenetic Network is more flexible than the models used in literature, it is limited to having a maximum number of $(N-2)$ platforms, where N is the number of distinctive products.
- The hierarchical model requires the maximum number of components that can be assembled after a certain component as an input. This maximum number is defined based on experience. If it is considered a variable then it can be obtained optimally.
- The Multi-Period Multi-Platform Model assumes that if any product assigned to a certain platform in a certain period, it will continue to be assigned to that platform in all periods.
- Due to its complexity, the final MPCA Model solves case studies of product platforms up to 8 products and 13 components.

6.5 Future Work

Many extensions could be included in future work. A mathematical model that designs product platform simultaneously with different assembly lines layouts such as U-shaped assembly lines

would be useful to develop. The U-shaped assembly line provides many benefits over other layouts, and is currently used extensively in industry. Also, it is suggested to develop a frame work for integrating product platform and families design with the new reconfigurable iFactory assembly layout in the IMS Center at University of Windsor. This integration will enable optimizing the performance of the iFactory, and to integrate product platform design with the iFactory using assembly/disassembly concepts. A new Design for Assembly/Disassembly mathematical model which includes a complete hierarchy of the products, based on assembly costs would help in the design phase of the product. This can present a new approach to design the relations between products components themselves, and to provide their respective families and platforms simultaneously. Probabilistic demand scenarios as well as accounting for the exact workers learning curves may be included in the proposed models. The linearization scheme used in MPCA model depends on determining only four linearization points. These points should be varied to determine their effect on overall model performance and optimal results. Meta-heuristics can be used to expand the models ability to handle larger number of products and components. All models assume that products and components already exist, and the target is to obtain their platforms. This can be extended by applying scalable platforms to obtain the parameters of each component, not only their clustering or hierarchy.

REFERENCES

- Al-Salim, B. and Choobineh, F., 2009. Redesign of production flow lines to postpone product differentiation. *International Journal of Production Research* **47**(20): 5563-5590.
- AlGeddawy, T. and ElMaraghy, H., 2010a. Assembly systems layout design model for delayed products differentiation. *International Journal of Production Research* **48**(18): 5281-5305.
- AlGeddawy, T. and ElMaraghy, H., 2010b. Design of single assembly line for the delayed differentiation of product variants. *Flexible Services and Manufacturing Journal* **22**(3-4): 163-182.
- Alizon, F., Shooter, S. B. and Simpson, T. W., 2009. Henry Ford and the Model T: lessons for product platforming and mass customization. *Design Studies* **30**(5): 588-605.
- Bandelt, H. J., Forster, P. P. and Röhl, A. A., 1999. Median-joining networks for inferring intraspecific phylogenies. *Molecular biology and evolution* **16**(1): 37-48.
- Ben-Arieh, D., Easton, T. and Choubey, A. M., 2009. Solving the multiple platforms configuration problem. *International Journal of Production Research* **47**(7): 1969-1988.
- Benjaafar, S., 2002. Design of plant layouts with queueing effects. *Management Science* **48**(5): 679-704.
- Benjaafar, S. and Sheikhzadeh, M., 2000. Design of flexible plant layouts. *IIE Transactions* **32**(4): 309-322.
- Blecker, T. and Abdelkafi, N., 2006. *Mass Customization: State-of-the-art and challenges Mass customization: challenges and solutions*, Springer.
- Blecker, T. and Friedrich, G., 2006. *Mass customization: challenges and solutions*, Springer.
- Boysen, N., Fliedner, M. and Scholl, A., 2007. A classification of assembly line balancing problems. *European Journal of Operational Research* **183**(2): 674-693.
- Boysen, N., Fliedner, M. and Scholl, A., 2009. Production planning of mixed-model assembly lines: Overview and extensions. *Production Planning and Control* **20**(5): 455-471.
- Burbidge, J. L., 1963. Production flow analysis. *Production engineer* **42**(12): 742-752.
- Buxey, G., 1974. Assembly line balancing with multiple stations. *Management Science* **20**(6): 1010-1021.
- De Lit, P., Delchambre, A. and Henrioud, J. M., 2003. An integrated approach for product family and assembly system design. *Robotics and Automation, IEEE Transactions on* **19**(2): 324-334.
- ElMaraghy, H., 2007. *Reconfigurable Process Plans For Responsive Manufacturing Systems Digital Enterprise Technology*. P. Cunha and P. Maropoulos, Springer US: 35-44.
- ElMaraghy, H. and AlGeddawy, T., 2013. *Cladistics for Products and Manufacturing*. CIRP Encyclopedia of Production Engineering: SpringerReference (www.springerreference.com). L. Laperrière and G. Reinhart, Springer-Verlag Berlin Heidelberg. 10.1007/SpringerReference_357769 2013-08-15 16:00:21 UTC
- ElMaraghy, H. and AlGeddawy, T., 2014. *Multidisciplinary Domains Association in Product Family Design. Advances in Product Family and Product Platform Design*. T. W. Simpson, J. Jiao, Z. Siddique and K. Hölttä-Otto, Springer New York: 71-89.
- ElMaraghy, H., AlGeddawy, T. and Azab, A., 2008. Modelling evolution in manufacturing: A biological analogy. *CIRP Annals - Manufacturing Technology* **57**(1): 467-472.
- ElMaraghy, H. A., 2009. *Changeable and Reconfigurable Manufacturing Systems*. London, UK, Springer Verlag.
- Erel, E. and Sarin, S. C., 1998. A survey of the assembly line balancing procedures. *Production Planning & Control* **9**(5): 414-434.
- Erens, F. and Verhulst, K., 1997. Architectures for product families. *Computers in Industry* **33**(2-3): 165-178.
- Feitzinger, E. and Lee, H. L., 1997. Mass customization at Hewlett-Packard: the power of postponement. *Harvard Business Review* **75**: 116-123.
- Ferguson, S., Olewnik, A., Malegaonkar, P., Cormier, P. and Kansara, S., 2010. Mass customization: A review of the paradigm across marketing, engineering and distribution domains. *ASME 2010 International Design Engineering Technical Conferences and Computers and Information in Engineering Conference, IDETC/CIE2010*, August 15, 2010 - August 18, 2010, Montreal, QC, Canada, American Society of Mechanical Engineers.

- Fluxus-engineering.com. (2012a). "Free Phylogenetic Network Software." Retrieved Feb 27th, 2012, from <http://www.fluxus-engineering.com/sharepub.htm#a1>.
- Fluxus-engineering.com, 2012b. Network 4.6.1.1. User Guide. F. T. Ltd.
- Flynn, B. B. and Robert Jacobs, F., 1986. A simulation comparison of group technology with traditional job shop manufacturing. *International Journal of Production Research* **24**(5): 1171-1192.
- Forster, P., Torroni, A., Renfrew, C. and Röhl, A., 2001. Phylogenetic Star Contraction Applied to Asian and Papuan mtDNA Evolution. *Molecular Biology and Evolution* **18**(10): 1864-1881.
- Fujita, K., Sakaguchi, H. and Akagi, S. (1999). "Product variety deployment and its optimization under modular architecture and module communalization. ASME Design Engineering Technical Conferences"
- Garg, A. and Tang, C. S., 1997. On postponement strategies for product families with multiple points of differentiation. *IIE Transactions (Institute of Industrial Engineers)* **29**(8): 641-650.
- He, D., Kusiak, A. and Tseng, T. L. B., 1998. Delayed product differentiation: a design and manufacturing perspective. *Computer Aided Design* **30**(2): 105-113.
- He, D. W. and Kusiak, A., 1997. Design of assembly systems for modular products. *Robotics and Automation, IEEE Transactions on* **13**(5): 646-655.
- Henig, M. I., 1986. Extensions of the dynamic programming method in the deterministic and stochastic assembly-line balancing problems. *Computers & Operations Research* **13**(4): 443-449.
- Hernandez, G., Allen, J. K. and Mistree, F., 2003. Platform design for customizable products as a problem of access in a geometric space. *Engineering Optimization* **35**(3): 229-254.
- Hounshell, D. A., 1985. From the American system to mass production, 1800-1932: The development of manufacturing technology in the United States, Johns Hopkins Univ Pr.
- Huang, G., Bin, S. and Halevi, G., 2003. Product platform identification and development for mass customization. *CIRP Annals - Manufacturing Technology* **52**(1): 117-120.
- Huang, G. Q., Zhang, X. Y. and Liang, L., 2005. Towards integrated optimal configuration of platform products, manufacturing processes, and supply chains. *Journal of Operations Management* **23**(3-4): 267-290.
- Huson, D. H. and Bryant, D., 2006. Application of Phylogenetic Networks in Evolutionary Studies. *Molecular Biology and Evolution* **23**(2): 254-267.
- Huson, D. H. and Scornavacca, C., 2011. A Survey of Combinatorial Methods for Phylogenetic Networks. *Genome Biology and Evolution* **3**: 23-35.
- Irani, S. A. and Huang, H., 2000. Custom design of facility layouts for multiproduct facilities using layout modules. *Robotics and Automation, IEEE Transactions on* **16**(3): 259-267.
- Jenner, R. A., 2004. Invited Review: The scientific status of metazoan cladistics: why current research practice must change. *Zoologica Scripta* **33**(4): 293-310.
- Jewkes, E. M. and Alfa, A. S., 2009. A queueing model of delayed product differentiation. *European Journal of Operational Research* **199**(3): 734-743.
- Jiao, J. and Tseng, M. M., 1999. Methodology of developing product family architecture for mass customization. *Journal of Intelligent Manufacturing* **10**(1): 3-20.
- Jiao, J., Simpson, T. W. and Siddique, Z., 2007. Product family design and platform-based product development: A state-of-the-art review. *Journal of Intelligent Manufacturing* **18**(1): 5-29.
- Jiao, J., 2012. Product platform flexibility planning by hybrid real options analysis. *IIE Transactions* **44**(6): 431-445.
- Johnson, R. V., 1983. A branch and bound algorithm for assembly line balancing problems with formulation irregularities. *Management Science* **29**(11): 1309-1324.
- Jose, A. and Tollenaere, M., 2005. Modular and platform methods for product family design: literature analysis. *Journal of Intelligent Manufacturing* **16**(3): 371-390.
- Jose, A. and Tollenaere, M., 2005. Modular and platform methods for product family design: Literature analysis. *Journal of Intelligent Manufacturing* **16**(3): 371-390.

- Kao, E. P., 1976. A preference order dynamic program for stochastic assembly line balancing. *Management Science* **22**(10): 1097-1104.
- Ko, J. and Jack Hu, S., 2008. Balancing of manufacturing systems with complex configurations for delayed product differentiation. *International Journal of Production Research* **46**(15): 4285-4308.
- Kochhar, J. S. and Heragu, S., 1999. Facility layout design in a changing environment. *International Journal of Production Research* **37**(11): 2429-2446.
- Kottas, J. F. and Lau, H.-S., 1973. Cost-oriented approach to stochastic line balancing. *AIIE Transactions (American Institute of Industrial Engineers)* **5**(2): 164-171.
- Kumar, R. and Allada, V., 2007. Function-technology-based product platform formation. *International Journal of Production Research* **45**(24): 5687-5714.
- Kwang-Jae, K., Dong-Uk, L. and Myeong-Soo, L., 2006. Determining product platform elements for mass customisation. *International Journal of Productivity and Quality Management* **1**(1-2): 168-182.
- Lahmar, M. and Benjaafar, S., 2005. Design of distributed layouts. *IIE Transactions* **37**(4): 303-318.
- Lee, H. L. and Billington, C., 1994. Designing products and processes for postponement. *Management of Design*, Springer: 105-122.
- Lee, H. L. and Tang, C. S., 1997. Modelling the costs and benefits of delayed product differentiation. *Management Science* **43**(1): 40-53.
- Lu, C. C., Tsai, K. M. and Chen, J. H., 2011. Evaluation of manufacturing system redesign with multiple points of product differentiation. *International Journal of Production Research* **50**(24): 7167-7180.
- Maier, J. R. A. and Fadel, G. M., 2001. Strategic decisions in the early stages of product family design. 6th Design for Manufacturing Conference, September 9, 2001 - September 12, 2001, Pittsburgh, PA, United states, American Society of Mechanical Engineers.
- Maozhu, J. and Rongqiu, C., 2008. The platform configuration for product family production. 2008 4th International Conference on Wireless Communications, Networking and Mobile Computing (WiCOM), 12-14 Oct. 2008, Piscataway, NJ, USA, IEEE.
- Martin, M. V. and Ishii, K., 2002. Design for variety: developing standardized and modularized product platform architectures. *Research in Engineering Design* **13**(4): 23 pp.
- Messac, A., Martinez, M. P. and Simpson, T. W., 2002. Effective product family design using physical programming. *Engineering Optimization* **34**(3): 245-261.
- Meyer, M. and Lehnerd, A. P., 1997. *The power of product platform – building value and cost leadership*, New York: Free Press.
- Meyer, M. H., 1997. Revitalize your product lines through continuous platform renewal. *Research Technology Management* **40**(2): 17-28.
- Montreuil, B., 1999. Fractal layout organization for job shop environments. *International Journal of Production Research* **37**(3): 501-521.
- Montreuil, B. and Venkatadri, U., 1991. Strategic interpolative design of dynamic manufacturing systems layouts. *Management Science* **37**(6): 682-694.
- Moodie, C. L. and Young, H., 1964. A heuristic method of assembly line balancing for assumptions of constant or variable work element times, Purdue University.
- Muffatto, M., 1999. Introducing a platform strategy in product development. *Proceedings of the 14th International Conference on Production Research*, 4-8 Aug. 1997, Netherlands, Elsevier.
- Nof, S. Y., Wilhelm, W. E. and Warnecke, H. H.-J., 1997. *Industrial assembly*, Kluwer Academic Publishers.
- Park, J. and Simpson, T. W., 2005. Development of a production cost estimation framework to support product family design. *International journal of production research* **43**(4): 731-772.
- Peterson, C. C., 1971. A note on transforming the product of variables to linear form in linear programs.
- Polzin, T. and Daneshmand, S. V., 2003. On Steiner trees and minimum spanning trees in hypergraphs. *Operations Research Letters* **31**(1): 12-20.
- Rai, R. and Allada, V., 2006. Agent-based optimization for product family design. *Annals of Operations Research* **143**(Copyright 2006, The Institution of Engineering and Technology): 147-156.

- Ritt, M. and Costa, A. M., 2011. A comparison of formulations for the simple assembly line balancing problem. Arxiv preprint arXiv:1111.0934.
- Rojas Arciniegas, A. J. and Kim, H. M., 2011. Optimal component sharing in a product family by simultaneous consideration of minimum description length and impact metric. *Engineering Optimization* **43**(2): 175-192.
- Rosenblatt, M. J. and Carlson, R. C., 1985. Designing a production line to maximize profit. *IIE Transactions* **17**(2): 117-122.
- Saghiri, S., 2011. A structural approach to assessing postponement strategies: construct development and validation. *International Journal of Production Research* **49**(21): 6427-6450.
- Salveson, M. E., 1955. The Assembly Line Balancing Problem. *Trans. ASME* **77**: 939-948.
- Sanderson, S. and Uzumeri, M., 1995. Managing product families: The case of the Sony Walkman. *Research Policy* **24**(5): 761-782.
- Scholl, A. (1999). "Balancing and sequencing of assembly lines."
- Scholl, A. and Becker, C., 2005. A note on "An exact method for cost-oriented assembly line balancing". *International Journal of Production Economics* **97**(3): 343-352.
- Scholl, A. and Becker, C., 2006. State-of-the-art exact and heuristic solution procedures for simple assembly line balancing. *European Journal of Operational Research* **168**(3): 666-693.
- Shin, D. and Min, H., 1991. Uniform assembly line balancing with stochastic task times in just-in-time manufacturing. *International Journal of Operations & Production Management* **11**(8): 23-34.
- Shtub, A. and Dar-El, E. M., 1989. A methodology for the selection of assembly systems. *International Journal of Production Research* **27**(1): 175-186.
- Simpson, T. W., Maier, J. R. and Mistree, F., 2001. Product platform design: Method and application. *Research in Engineering Design - Theory, Applications, and Concurrent Engineering* **13**(1): 2-22.
- Simpson, T. W. and Mistree, F., 1999. A Concept Exploration Method for Product Platform and Product Family Design. *Optimization in Industry II Conference - 1999, June 6, 1999 - June 11, 1999, Banff, Alb., Canada, American Society of Mechanical Engineers.*
- Song, Z. and Kusiak, A., 2010. Mining Pareto-optimal modules for delayed product differentiation. *European Journal of Operational Research* **201**(1): 123-128.
- Sparling, D., 1998. Balancing just-in-time production units: the N U-line balancing problem. *INFOR* **36**(4): 215-237.
- Suh, E. S., de Weck, O., Kim, I. Y. and Chang, D., 2007. Flexible platform component design under uncertainty. *Journal of Intelligent Manufacturing* **18**(1): 115-126.
- Swaminathan, J. M. and Tayur, S. R., 1998. Managing broader product lines through delayed differentiation using vanilla boxes. *Management Science* **44**(12): 161-172.
- Swaminathan, J. M. and Tayur, S. R., 1999. Managing design of assembly sequences for product lines that delay product differentiation. *IIE Transactions (Institute of Industrial Engineers)* **31**(11): 1015-1026.
- Tian-Li, Y., Yassine, A. A. and Goldberg, D. E., 2007. An information theoretic method for developing modular architectures using genetic algorithms. *Research in Engineering Design* **18**(2): 91-109.
- Ulrich, K., 1995. Role of product architecture in the manufacturing firm. *Research Policy* **24**(3): 419-419.
- Ulrich, K. and Tung, K., 1991. Fundamentals of product modularity. *Winter Annual Meeting of the American Society of Mechanical Engineers, December 1, 1991 - December 6, 1991, Atlanta, GA, USA, Publ by ASME.*
- Urban, T. L. and Wen-Chyuan, C., 2006. An optimal piecewise-linear program for the U-line balancing problem with stochastic task times. *European Journal of Operational Research* **168**(3): 771-782.
- Wilhelm, B., 1997. Platform and modular concepts at Volkswagen—their effects on the assembly process. *Transforming automobile assembly, Springer:* 146-156.
- Williams, C. B., Allen, J. K., Rosen, D. W. and Mistree, F., 2007. Designing platforms for customizable products and processes in markets of non-uniform demand. *Concurrent Engineering: Research and Applications:* 201-216.
- Williams, H. P., 1999. *Model Building in Mathematical Programming*, 4th Edition, Wiley.

Zacharias, N. and Yassine, A., 2008. Optimal platform investment for product family design. *Journal of Intelligent Manufacturing* **19**(2): 131-148.

APPENDIX A

In this appendix, the procedures of constructing the median-joining phylogenetic network to form the targeted assembly/disassembly platforms is illustrated (Bandelt et al. 1999). Consider as an example, four theoretical products with six possible components (Table A1):

Table A1. Incidence matrix of the four products

Products	Components					
	1	2	3	4	5	6
W	0	1	0	1	0	0
X	1	1	1	1	1	1
Y	0	1	1	1	0	1
Z	1	1	0	1	1	1

Each product is composed of different combination of products. In the table, if a product has a certain component, then the value corresponding is 1, and zero otherwise.

Step 1: Construct distance matrix between all products (Table A2)

Table A2. Products distances matrix

Products	Products			
	W	X	Y	Z
W		4	2	3
X			2	1
Y				3
Z				

To develop the distance matrix, the hamming distance between each two products is calculated. The hamming distance is the summation of the number of changes of components. For example, for products W and X, product W does not have components 2 and 3. Therefore, the hamming distance between product W and product X is 2.

Step 2: Determine different distance values (δ) and arrange them ascendingly

$$\delta_{XZ} = 1 < \delta_{WY}, \delta_{XY}, = 2 < \delta_{WZ}, \delta_{YZ} = 3 < \delta_{WX} = 4$$

Step 3: Using ascending deltas, construct completely connected acyclic network

At $\delta_{XZ} = 1$

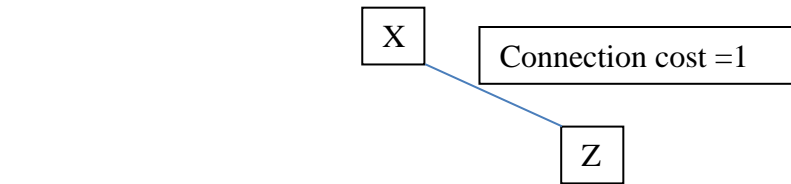

At $\delta_{XY} = 2$

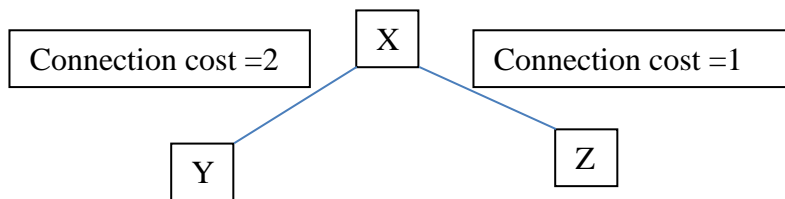

At $\delta_{WY} = 2$

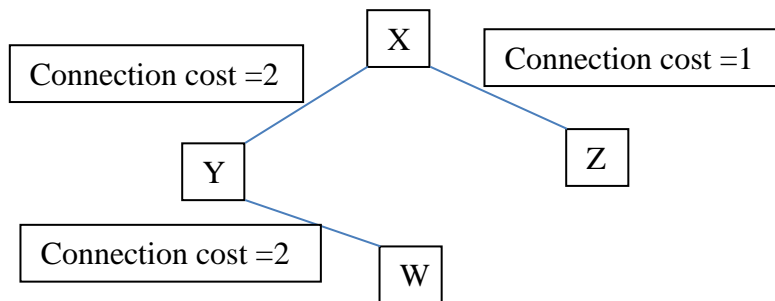

Figure A1. Different steps to construct the feasible links and triplets

At this point, there is no need to examine further deltas, as the whole connecting network is constructed. The next step is to determine the feasible triplets which are constructed from feasible links. The feasible link is the link with the minimum distance cost that connects product A with product B. Feasible triplets are those groups of products consisting of three products that have at least two feasible links.

Step 4: Determine feasible triplets

According to Fig.A3, triplet (X, Y, Z) and (W, X, Y) are feasible triplets.

Step 5: Determine major consensus platform for each triplet

Triplet (X, Y, Z) 's major consensus platform (M) has the composition (1 1 1 1 1 1) which is the most common elements shared across each product for each component (minimum two out of three components similarity must exist). Triplet (W, X, Y) has the major consensus platform (N) composition (0 1 1 1 0 1).

Step 6: Calculate the total cost to connect the majority consensus platform to its triplet and to other remaining products and select the least cost majority consensus platform to form the final median-joining network

$$\delta_{Total(MXYZ,W)} = \delta_{MX} + \delta_{MY} + \delta_{MZ} + \delta_{MW}$$

$$\delta_{Total(MXYZ,W)} = 0 + 2 + 1 + 4 = 7 \text{ (The chosen majority consensus)}$$

$$\delta_{Total(NWXY,Z)} = \delta_{NW} + \delta_{NX} + \delta_{NY} + \delta_{NZ}$$

$$\delta_{Total(NWXY,Z)} = 3 + 2 + 0 + 3 = 8$$

Step 7: Recalculate the distance matrix including the newly formed platform M

Table A3. New products and platform distances matrix

Products	Products				
	M	W	X	Y	Z
M		4	0	2	1
W			4	2	3
X				2	1
Y					3
Z					

Step 8: Rearrange the new deltas ascendingly and connect the products and the platform as in step 4 (Figure A2):

At $\delta_{MX} = 0$

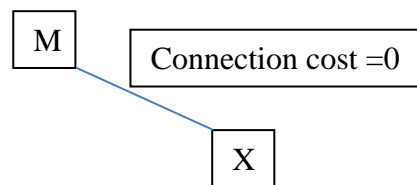

At $\delta_{MZ} = 1$

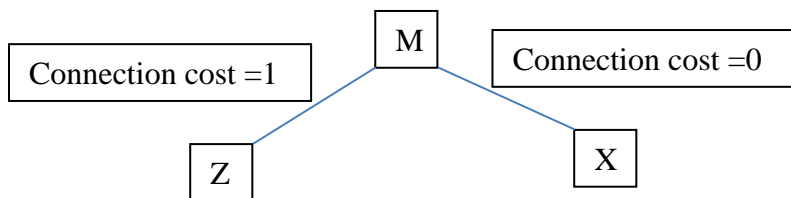

At $\delta_{MY} = 2$

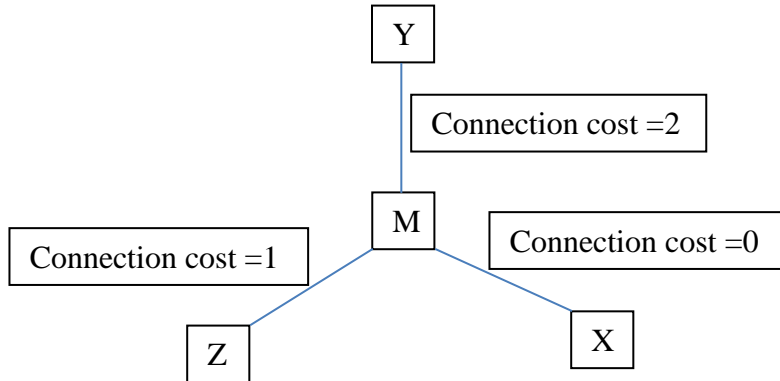

At $\delta_{WY} = 2$

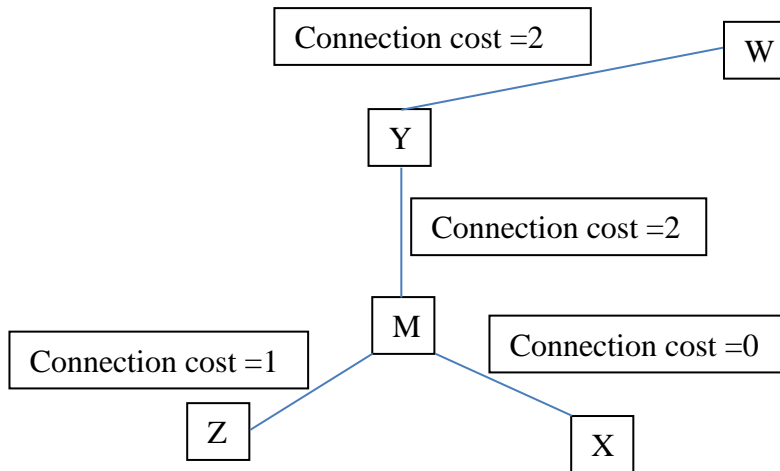

Figure A2. Steps to connect new medians to existing products

Since connection cost between M and X is zero, then product X is the median between products Z and Y. Assembled and disassembled components are now determined by looking at the component difference between each two products. In the biological sense, the algorithm stops at determining components difference (but not the assembly and disassembly part). In the industrial sense, the knowledge of whether the components are assembled or disassembled is crucial. In this paper, this can be done by comparisons between connected products, and determining which components are assembled and which are not, and not only components differences are different in two components 3 and 6 as in Figure A3:

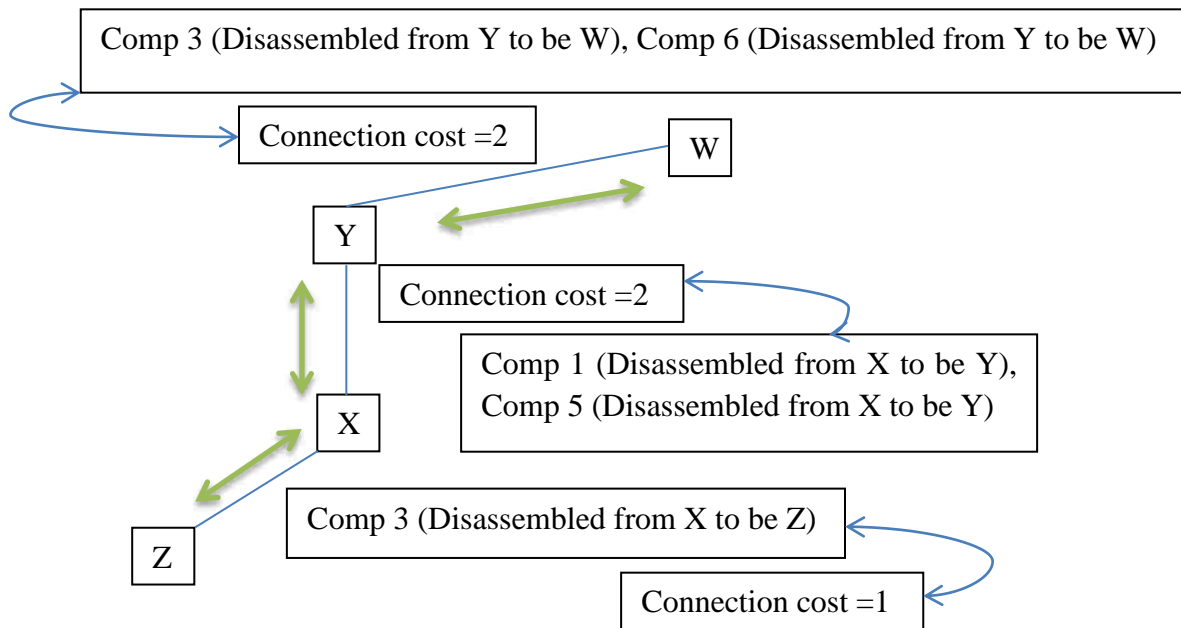

Figure A3. Final phylogenetic network connecting products and medians (Product X)

Thanks to the phylogenetic network, and depending on the connection cost between the platform and the derived products, each of Y and Z can be a platform candidate. This can happen if the demanded product mix changes, so either Y or Z can be the mass produced platform. Afterwards, they can be customized to form the initial platform X or modified to obtain W.

VITA AUCTORIS

Mohammad Hanafy was born in Egypt in 1982. He graduated from the Production and Mechanical Engineering Department, Cairo University, Egypt in 2005, where he also received the M.Sc. degree in Mechanical Design and Production in 2009. He joined the Intelligent Manufacturing Systems Centre (IMSC) as a Ph.D. student in 2009, at the University of Windsor in Ontario, Canada. He received multiple excellence academic awards in both Egypt and Canada. His research activities are focused on management and optimization of products platforms through co-design with manufacturing systems. He has published/submitted 8 conference and journal papers.

Publications:

- Hanafy, M. and ElMaraghy, H., 2014. Co-Design of Products and Systems Using a Bayesian Network. 47th CIRP Conference of Manufacturing Systems 2014. Windsor, Canada. (Accepted)
- Hanafy, M. and ElMaraghy, H., 2014. Developing of an Assembly Line Layout for Delayed Product Differentiation Using Phylogenetic Networks. International Journal of Production Research. (Submitted)
- Hanafy, M. and ElMaraghy, H., 2014. Modular Product Multi-Platform Configuration Model. International Journal of Intelligent Manufacturing. (Submitted)
- Hanafy, M. and ElMaraghy, H. A., 2014. A Multi-Period Changeable Modular Product Assembly Model. Enabling Manufacturing Competitiveness and Economic Sustainability, Springer: 137-142.
- Hanafy, M. and ElMaraghy, H., 2014. Modular Product Platform Configuration and Co-Design of Assembly Line Model. Computers & Industrial Engineering (To be submitted).
- Hanafy, M. and ElMaraghy, H., 2013. A Modular Dynamic Products Platforms Design Model. 23rd CIRP Design Conference 2013. Bochum, Germany: pp: 553-562.
- Hanafy, M. and ElMaraghy, H., 2011. Products' Features Dependency Inference using Bayesian Networks for New Product Designs. ICMS 2011 - 44th CIRP Conference on Manufacturing Systems. Wisconsin, USA.
- Hanafy, M., AlGeddawy, T. and ElMaraghy, H., 2010. Complex Adaptive Systems Applications in Manufacturing Systems Modeling. CATS 2010 - 3rd CIRP Conference on Assembly Technologies and Systems. Norway: pp: 215-211.
- Hanafy, M.A., Metwalli, S.M., 2009. Hybrid General Heuristic Projection Gradient for Frame Optimization of Micro and Macro Applications. ASME IDETC/CIE 2009 conference proceedings, DAC-13 Design Optimization Algorithms, San Diego, California, USA, paper # DET2009-87012.