

2011

Stage specific cotton water use crop coefficients in northeast Louisiana

Vipan Kumar

Louisiana State University and Agricultural and Mechanical College, vkumar4@tigers.lsu.edu

Follow this and additional works at: https://digitalcommons.lsu.edu/gradschool_theses

Recommended Citation

Kumar, Vipan, "Stage specific cotton water use crop coefficients in northeast Louisiana" (2011). *LSU Master's Theses*. 373.
https://digitalcommons.lsu.edu/gradschool_theses/373

This Thesis is brought to you for free and open access by the Graduate School at LSU Digital Commons. It has been accepted for inclusion in LSU Master's Theses by an authorized graduate school editor of LSU Digital Commons. For more information, please contact gradetd@lsu.edu.

**STAGE SPECIFIC COTTON WATER USE CROP COEFFICIENTS IN
NORTHEAST LOUISIANA**

A Thesis

Submitted to the Graduate Faculty of the
Louisiana State University and
Agriculture and Mechanical College
in partial fulfillment of the
requirements for the degree of
Master of Science

in

The School of Plant, Environmental and Soil Sciences

By

Vipan Kumar

B.Sc. Agri., Punjab Agricultural University, Ludhiana, India, 2008

May 2011

ACKNOWLEDGEMENTS

It is indeed a moment of great satisfaction and pleasure for me to express gratitude towards my key committee members Dr. Ernest Clawson, Dr. Donnie Miller and Dr. Theophilus Udeigwe; their zeal and enthusiasm were the source of inspiration for me. I am extremely thankful for the able guidance and attention which they bestowed upon me.

My foremost thanks and gratitude goes to Dr. Robert Rohli for his able guidance on climatological aspects of the research project. I also would like to thank Dr. Brenda Tubana, Dr. Don Labonte and Dr. Ron Sheffield and for their guidance, support, help and involvement in the committee.

Furthermore, my appreciation extends to faculty, staff and student workers (Dan and Garret) at LSU AgCenter Northeast Research Station, who helped me in executing field work and data collection. I am also grateful to Cotton Inc. for funding this research project.

I also want to express my special thanks to Charanjit Singh, Jaspreet Kaur, Kirandeep Kaur, Raghuwinder Singh and Rakesh Godara for their support and help at LSU. I also would like to acknowledge some of my lovable friends Gagan, Jasmeet, Lucky, Mandeep, Maninder, Narinder, Pardeep, Sukhbir and Sushi who are a great source of encouragement and inspiration for me.

Finally, I dedicate this thesis to my beloved parents, without whose blessings, this thesis would not have been possible.

TABLE OF CONTENTS

ACKNOWLEDGEMENTS	ii
LIST OF TABLES	iv
LIST OF FIGURES	v
ABSTRACT	vii
CHAPTER	
1. INTRODUCTION	1
2. REVIEW OF LITERATURE	5
2.1. Crop Evapotranspiration (ET_c) and Estimation or Measurement Techniques.....	6
2.2. Reference Evapotranspiration (ET_o) and Estimation Models/Techniques.....	11
2.3. Crop Coefficients (K_c).....	17
3. MATERIALS AND METHODS	26
3.1. Location Characteristics.....	26
3.2. Lysimeter Installation, Calibration and Maintenance.....	28
3.3. Reference Weather Station Establishment and Maintenance.....	31
3.4. Cotton Field Establishment.....	34
3.5. Data Collection and Analysis.....	37
3.6. K_c Calculation and Statistical Analysis	42
4. RESULTS AND DISCUSSION	44
4.1. General Crop Characteristics	44
4.2. Plant Growth on Lysimeters	46
4.3. Crop Evapotranspiration (ET_c)	46
4.4. Weather Measurements and Reference Evapotranspiration (ET_o).....	54
4.5. Crop Coefficients (K_c)	63
5. CONCLUSIONS	70
5.1. Summary	70
5.2. Findings	71
5.3. K_c Application for Irrigation Scheduling	71
REFERENCES	74
VITA	81

LIST OF TABLES

3.1. Information on instrumentation of reference weather station at the LSU AgCenter Northeast Research Station.....	32
3.2. Timeline for mowing, irrigation and rainfall on reference grass in 2010	34
3.3. Timeline on irrigation and drainage events for both lysimeters in 2010	36
4.1. General crop characteristics for cotton plants on the north lysimeter.....	44
4.2. General crop characteristics for cotton plants on the south lysimeter.....	44
4.3. General crop characteristics on the eastern side of the representative cotton field...	45
4.4. General crop characteristics on the western side of the representative cotton field...	45
4.5. Cotton growth stages and their approximate timing on both lysimeters.....	45
4.6. Summary of monthly climatic data daily mean values in 2010.....	61
4.7. Average K_c values for different growth stages and their duration.....	64
4.8. Approximate timing of cotton growth stages, K_c values (derived from Fig. 4.20) and cumulative growing degree days at LSU AgCenter Northeast Research Station 2010..	66
4.9. Regression coefficients for K_c as a function of days after planting (DAP) and cumulative growing degree days (CGDD).....	68

LIST OF FIGURES

3.1. Map of Louisiana highlighting Tensas Parish.....	27
3.2. Weighing lysimeters, viewed from the southeast toward the northwest, LSU AgCenter Northeast Research Station, Saint Joseph, LA.....	29
3.3. Weighing lysimeter in cross-sectional view	30
3.4. Calibration results for the north and south lysimeter in 2010.....	30
3.5. Reference weather station at the LSU AgCenter Northeast Research Station 2010.....	33
3.6. Cotton crop developing on weighing lysimeters and surrounding areas in 2010.....	35
3.7. Canopy cover highlighting 20, 50, 80, and greater than 90 % shading of ground surface (from top to bottom) on lysimeters during 2010 cotton growing season	39
4.1. Typical mass changes in the lysimeter at daily time scale.....	47
4.2. Mass changes in the north lysimeter resulting from rainfall (R), irrigation (I) and pumping (P) over the entire cotton growing season.....	48
4.3. Mass changes in the south lysimeter resulting from rainfall (R), irrigation (I) and pumping (P) over the entire cotton growing season	49
4.4. Daily ET_c from the north and south lysimeters over the entire growing season.....	50
4.5. Measured ET_c from both lysimeters over the entire growing season.....	51
4.6. Soil water potential in the north lysimeter measured at four depths by tensiometers.....	52
4.7. Soil water potential in the south lysimeter measured at four depths by tensiometers.....	53
4.8. Maximum and minimum air temperature over the reference grass surface in 2010...	55
4.9. Rainfall distribution during the 2010 growing season	55
4.10. Minimum and maximum relative humidity measured over the reference grass surface during the growing season 2010.....	56
4.11. Total solar radiation measured over the reference grass surface in 2010.....	57
4.12. Daily averages of horizontal wind speeds at 2 m height over the reference grass surface in 2010.....	57

4.13. Measured solar radiation R_S along with computed clear sky solar radiation R_{SO} during 2010 growing season	59
4.14. Average dew point temperature and minimum air temperature in 2010.....	60
4.15. Ratio of daily mean wind speeds from reference weather station to that of nearby LAIS weather station in 2010.....	60
4.16. ET_o over the standard grass surface during the 2010 growing season.....	61
4.17. Relationship of ET_o with weather variables in 2010.....	62
4.18. Straight line crop coefficients (K_c) curve for cotton during the 2010 growing season	64
4.19. Single day K_c values marked with specific cotton growth stages in 2010. Growth stages represent observations made on the DAP with which they are aligned.....	65
4.20. Crop coefficients (K_c) for cotton determined as function of days after planting.....	67
4.21. Crop coefficients (K_c) for cotton determined as a function of cumulative growing degree days.....	67
4.22. Average crop coefficients in relation to average canopy cover of both lysimeters in 2010.....	68

ABSTRACT

Cotton (*Gossypium hirsutum* L.) is an important commercial crop in the northeastern part of Louisiana. Research-based information for irrigation scheduling in cotton is lacking in this region. A two-step reference evapotranspiration (ET_o) - cotton crop coefficient (K_c) approach is considered a standard method of crop water use (ET_c) estimation. Therefore, a study was conducted to determine stage-specific cotton water use crop coefficients (K_c), a ratio of ET_c to ET_o at the LSU AgCenter Northeast Research Station in 2010. For ET_c estimation, paired weighing lysimeters were used. Cotton variety ‘Stoneville 5458 B2RF’ was planted on weighing lysimeters by hands and surrounding field using a vacuum planter under similar growing conditions typical of the region on May 12. Cotton plants on lysimeters and surrounding field were irrigated throughout the season. Other crop management practices were carried out following the LSU AgCenter recommendations. To estimate ET_o , an area of 102 m by 102 m seeded with Bermuda grass (*Cynodon dactylon* L.) was demarcated and a tower 10 m in height instrumented with weather sensors was installed in the center of demarcated area in July 2009. Daily measurements of maximum and minimum air temperature, minimum and maximum RH, wind speed, and total solar radiation were obtained and ET_o was estimated using the Standardized Reference Evapotranspiration Equation (SREE) of the American Society of Civil Engineers (ASCE). An average K_c value of 0.42 for initial growth stage (0 to 25 days after planting), 0.89 for developmental (26 to 60 days after planting) and 1.41 for mid-season (61 to 132 days after planting) were observed. With the development of these K_c values, a simple internet based tool can be designed to help producers conduct a more efficient irrigation scheduling which will subsequently improve water use efficiency in this region.

CHAPTER 1

INTRODUCTION

Cotton (*Gossypium hirsutum* L.) is an important fiber crop in the world (Texier 1993). Being a warm climate crop, it is grown in dry sub-tropical to tropical climates having adequate rainfall and ample sunshine during the growing period. Air temperature of 32 to 35 °C is considered optimum for normal growth of cotton plants with a minimum and maximum range of 16°C to 38°C (Wright and Sprengel 2005). Although perennial in nature, cotton is grown as an annual crop in most regions of the world. The major cotton producing countries are China, India, the United States, Pakistan, Brazil and Uzbekistan, which contribute approximately 80% of the world's cotton production. In 2010, the United States was the third largest cotton producer in the world with total harvested area of approximately 4.3 million hectares, yield of approximately 932 kg ha⁻¹, and total production of 18.3 million bales (USDA-FAS 2010).

In 2009, Louisiana ranked ninth in upland cotton production in the United States with total harvested area of 91 thousand hectares, yield of 845 kg ha⁻¹, and total production of 349 thousand bales (USDA-NASS 2010). In individual parish rankings within the state, Tensas was the leader in cotton production in 2009 with total irrigated cotton of approximately 8.3 thousand ha, yield of 889 kg ha⁻¹, and total production of 33.5 thousand bales (Louisiana Ag Summary 2009). Other leading parishes under irrigated cotton included Madison (5.1 thousand hectares), Franklin (4.3 thousand hectares), and East Carroll (2.6 hectares) (Louisiana Ag Summary 2009). All these parishes are located in the northeastern part of the state, making it a very important cotton producing region.

Louisiana annually receives high rainfall totals (approximately, 150 cm yr⁻¹ with varying distribution patterns with the months of June, July, and August often lacking adequate rainfall for

optimum crop growth. During summers, maximum growth and development of cotton plants occur with high crop water use (Tharp 1960). Cotton growth stages occurring during this period include squaring, blooming, and boll maturation. Marani and Horwitz (1963) observed that irrigation applied at the beginning of flowering helps increase lint yield by increasing number of bolls and boll size. A five year study conducted at the Macon Ridge Research Station in northeastern Louisiana has also shown that supplemental irrigation can increase seed cotton yield, varying from 0 to 2201 kg ha⁻¹ (Philips 1964). Therefore, application of irrigation becomes crucial for optimum cotton yield during peak summer months. Although 40 percent of cotton fields in Louisiana receive irrigation (Hague et al. 2003), information on amount of water to apply, application timing, and critical timing for cessation of irrigation is lacking (Hague et al. 2003). Producers often follow “feel and appearance” method for irrigation, which lack the quantification of water requirement at a given growth stage and is based on subjective judgment of crop and soil conditions.

Crop evapotranspiration (ET_c) measurement is an important criterion in calculating crop water requirement at a particular stage of the crop. Evapotranspiration is a combined term for evaporation, whereby water is lost from the soil surface, and transpiration, whereby water is diffused into the atmosphere from a plant surface through stomata. Energy is needed for water to evaporate either from soil or plant surfaces. To determine ET_c, a crop coefficient approach is followed as given below:

$$ET_c = K_c ET_o$$

where influence of weather conditions on ET_c is incorporated into reference evapotranspiration (ET_o) while crop characteristics are represented in crop coefficient (K_c) (Allen et al. 1998). Crop

coefficient (K_c) is simply a ratio of ET_c to ET_o (estimated over a standard grass surface). To follow this approach, information on K_c values is needed for different crop growth stages along with weather parameters measured over a reference grass surface of standard height, dense canopy, and surface resistance with adequate soil moisture to estimate ET_o as described in American Society of Civil Engineers (ASCE) ET_o equation (Allen et al. 2005). The FAO-56 Irrigation and Drainage paper provides K_c values for major crops (Allen et al. 1998), but regional variations in climate make these K_c values unsuitable for use across multiple regions. Therefore, locally developed K_c values for a particular crop are recommended for better estimation of crop water use.

To determine locally based K_c values for cotton in northeastern Louisiana, an attempt was made in 2009 using weighing lysimeter data to compute daily cotton ET_c at different growth stages (Hribal 2009) and weather data from the Louisiana Agrilimatic Information System (LAIS 2009) weather station at St. Joseph, LA in Tensas Parish to estimate ET_o using the Standardized Reference Evapotranspiration Equation (SREE) developed by ASCE (Allen et al. 2005). Average K_c values of 0.15, 0.60, and 1.39 for initial (22-29 days after planting), development (30-69 days after planting), and mid-season (70-136 days after planting) stages of cotton respectively, were observed. Although SREE was used to estimate daily values of ET_o , the availability of adequate fetch of the reference grass surface, along with all standards described for this grass surface in the ASCE- ET_o equation, was lacking. In addition, solar radiation data used in ET_o estimation was measured over the cotton canopy using a portable weather station, which further limited the accuracy of ET_o estimation and K_c determination.

To remedy the problems encountered in previous work (Hribal 2009) and to follow the standard methodology in ET_o estimation as described in the ASCE ET_o equation, the present study was

planned and conducted at the LSU AgCenter Northeast Research Station near St. Joseph, LA, in 2010 with the following objective:

- Determine stage specific crop coefficients for cotton in Northeast Louisiana

This study used data from paired weighing lysimeters for daily cotton ET_c calculation at the study site and inputs of meteorological variables recorded by a new weather station established in 2009 on a Bermuda grass (*Cynodon dactylon* L.) reference grass surface. All standards for reference grass surface are followed as described in the ASCE ET_o equation (Allen et al. 2005). This study also uses the SREE of ASCE for daily estimates of ET_o . The daily K_c values were determined using daily estimates of ET_c from lysimeter data and ET_o estimation from SREE of ASCE for different cotton growth stages during 2010.

This study provides the stage specific K_c values for cotton in Northeast Louisiana which will help cotton producers in determining quantity of irrigation water to be supplied at a particular growth stage and its frequency in this region. The findings from this study will be helpful in optimizing water resources and avoiding water stress to cotton during critical growth periods. Producers will also be able to follow efficient irrigation scheduling, which will further reduce the overuse of underground water, cost of production and better define water use efficiency in cotton.

CHAPTER 2

REVIEW OF LITERATURE

In today's world, irrigation has become a key component for successful crop production. Supplemental water application is often required to complete the life cycle of crop plants and produce higher yields. The basic aim of efficient water management strategies is not only to supply sufficient water to the crop in time to avoid any physiological stress but also to ensure against application of excess water. Therefore, irrigation management programs in agriculture demand estimation of crop water use at the field level, which aims to quantify the amount of water needed to replenish the depleted water in the crop root zone as a result of evaporative water loss called evapotranspiration (ET). Food and Agricultural Organization of United Nations (FAO) Land and Water Development Division has developed and disseminated most of the crop water use estimation methodologies using ET methodology at the field level (Kassam and Smith 2001). This includes FAO Irrigation and Drainage paper (I & D) No. 24 (Doorenbos and Pruitt 1975), Irrigation and Drainage paper (I & D) No. 33 (Doorenbos and Kassam 1979), and Irrigation and Drainage paper (I & D) No. 56 (Allen et al. 1998). Most of these methodologies involve more or less empirical estimation of ET using weather variables such as air temperature, humidity, wind speed, and solar radiation. Since early nineteenth century, continuous efforts of many researchers on ET estimation methodology have led to development of more robust and practical methods. These methods estimate the reference evapotranspiration (ET_o) indirectly as evaporative demand of the atmosphere while soil and crop factors are kept constant over a reference grass surface. Reference evapotranspiration (ET_o) and the crop coefficient (K_c) for a specific crop at a particular growth stage are used to compute crop evapotranspiration (ET_c) at that growth stage of the crop. This ' $ET_o - K_c$ ' approach of ET_c estimation, to know when to

irrigate and how much to irrigate, has become popular in recent years in irrigation scheduling programs. Besides these empirical approaches, weighing lysimeter is another promising technique to compute crop water use accurately from plants and surrounding soil. This technique of crop water use estimation is generally considered as one of the most reliable methods of ET_c estimation (Aboukhaled et al. 1982). Although the lysimeter methodology has many applications to other fields of study, its use to compute crop water requirements is well known. Lysimeter use in computation of ET_c includes all factors controlling the ET within the plant-soil system. The intent of this section is to review the available methodologies for ET_c and ET_o estimation and also K_c studies related to cotton.

2.1 Crop Evapotranspiration (ET_c) and Estimation or Measurement Techniques.

Crop evapotranspiration (ET_c) is an important variable in efficient planning and management of irrigation water in arable crops. It represents a major part of consumptive use of water supplied through irrigation and rainfall (Burt et al. 2005). Radiant energy is considered a driving component affecting the hydrological cycle on earth. The units for ET_c are water depth per unit time. For accurate irrigation scheduling programs in agricultural crops, it is foremost important to quantify daily and seasonal consumptive use of water by crops. Crop water requirements vary widely during the growing season mainly due to changes in canopy characteristics and climatic conditions (Doorenbos and Pruitt 1975), stomatal conductance of leaves, irrigation practices (Netzer et al. 2009), and soil characteristics (Burt et al. 2005). Within the crop canopy, aerodynamic roughness of the crop, resistance of crop canopy to the flow of heat, water vapors, and reflectance of the crop canopy to short wave radiations are attributes which affect ET_c during the growing season. At early stages of the crop, the evaporation component of ET dominates while the mature crop covers the majority of ground surface, leading to more transpiration than

evaporation and high water loss from larger leaf surfaces (Hanks 1992). In other words, the transpiration component surpasses the evaporation as the growing season progresses. Availability of soil water encourages crop growth leading to high crop water use while insufficient water content in soil leads to wilting or death of crop plants (Brady 1990). Crop coefficient (K_c) * Reference evapotranspiration (ET_o) is considered as an easy, convenient, and reproducible method for estimating consumptive water use of many crops under different climatic conditions (Doorenbos and Pruitt 1975; Wright 1982; Allen et al. 1998). This two-step approach has gained worldwide acceptance for estimating water requirements of a variety of crops. Besides the above mentioned approach described by FAO-56 Irrigation and Drainage paper, weighing lysimeter is another standard tool for estimating ET_c (Howell et al. 1985; Howell et al. 1991; Young et al. 1997). The use of a lysimeter for direct measurement of ET_c is made only for development of a K_c because of its expensiveness and technical expertise involved.

2.1.1 Soil Water Budget Method. Soil water balance approach is followed to compute ET_c estimation by measuring the components of the following equation:

$$ET_c = P+I-D-R+\Delta S$$

where ET_c denotes crop or actual evapotranspiration, P is precipitation and I is irrigation (water gains), D is deep percolation or drainage below root zone and R is surface runoff (water losses), and ΔS (change in soil profile water storage) represents water gain to or loss from soil water storage within the root zone (Malek and Bingham 1993). The change in soil water storage (ΔS) can also be negative, representing addition of water in soil water storage through irrigation or precipitation. All components in the above equation are expressed in millimeters per day. Among

these components, deep percolation is sometimes difficult to estimate and becomes a source of error in ET_c estimation (Farahani et al. 2008). In general, a neutron probe is used to measure moisture content (S) for a given soil profile and subtraction of this S for two consecutive days plus rainfall results in ET_c estimation per day.

2.1.2 Weighing Lysimeters. The lysimeter is another direct method of ET_c estimation under field conditions. A Lysimeter, in general, is a metallic tank of any shape filled with soils and plants grown on it. Several types of lysimeters are available for different purposes, but the weighing-type lysimeter is considered to be one of the most accurate methods of ET_c estimation while operating under representative field conditions (Burman et al. 1980). Weighing-type lysimeters are simply iron tanks of a circular or rectangular shape filled with a similar soil profile as that of the surrounding field that rest on the sensitive underground weighing scale. Small changes in weight of lysimeters at shorter intervals are assumed to be through evaporation from the soil surface and transpiration from plants grown onto the lysimeters. A continuous accounting of changes in masses of lysimeters is maintained using electronic equipment called a data logger. Daily changes in masses of the lysimeters are computed by subtracting masses of the lysimeters at the end of each day from the masses at the beginning of that day and are considered as water loss through ET but if rainfalls, the change in masses must account for this addition of water. This method is considered as one of the most precise for ET_c estimation against which other methods of ET_c estimation can be validated (Johnson et al. 2005).

2.1.3 Bowen Ratio. Bowen ratio is an indirect method of ET_c estimation which includes measurements of components of an energy balance equation and computed value of Bowen's ratio (β). This method was first suggested by Bowen (1926) with the following relationship in terms of fluxes:

$$\beta = H/LE \quad (\text{eqn. 2})$$

where β is Bowen ratio, H is sensible heat flux (W m^{-2}), and LE is latent heat flux (W m^{-2}). However, β is usually computed by gradients at two heights over a surface using the following relationship:

$$\beta = \alpha (C_p \Delta T / \lambda \Delta e)$$

where α is the ratio of turbulent transfer coefficients for sensible heat and water vapor (K_h/K_w , both in units of $\text{m}^2 \text{s}^{-1}$), C_p is specific heat of air at constant pressure ($\text{J kg}^{-1} \text{C}^{-1}$), ΔT is the air temperature gradient ($^{\circ}\text{C}$) between two heights above the surface, λ is latent heat of vaporization (J kg^{-1}), and Δe is vapor pressure gradient at the same two heights. This method is entirely based on the fact that most of the available radiant energy (net radiation) is used for evaporation as latent heat while the remaining part is used by sensible heat and soil heat flux (Burman et al. 1980). The surface energy balance equation is expressed as:

$$R_N = LE + H + G \quad (\text{eqn. 3})$$

where R_N is net solar radiation while LE (for evaporation) and H (for cooling or heating) are latent and sensible heat flux, respectively and G is soil heat flux (negative when soil warms up). The Bowen Ratio Energy Budget (BREB) method provides partitioning between LE and H (Fritschen 1965) and computes ET_c or LE as follows (using eqn. 2 and eqn. 3):

$$ET \text{ or } LE = R_N - G / (1 + \beta)$$

This method is mainly suitable for ET_c estimation over an irrigated natural surface like pasture, crops, and forest while accuracy of ET_c estimation decreases under dry conditions (positive and large β) or conditions where advection of energy occur (negative β) (Ohmura 1982).

Application of this method also involves assumptions of neutral atmosphere and good extensive fetch of the natural surface in upwind direction of wind flow (Angus and Watts 1984).

2.1.4 Eddy Covariance Method. Eddy covariance is also a direct method by which ET_c can be estimated. When some assumptions are met, the measurements of sudden fluctuations in vertical wind speed and humidity are made with a certain range of frequency to include effects of each tiny eddies, and summation of their product at shorter time interval directly gives ET_c (Rana and Katerji 2000). This technique actually refers to a system where different sensors with fast data acquisition and quick responding abilities are used to measure different weather variables and instantaneous estimation of turbulent fluxes of heat, water, and momentum are made using correlation techniques. The early eddy covariance systems named 'Evapotron' (Dyer and Mayer 1965) and 'Fluxatron' (Dyer et al. 1967) have been used successfully to estimate instantaneous vertical fluxes of heat and water vapor. Recent technological advances have improved the abilities of different electronic sensors for quick responses to different ranges of fluxes and quick data processing using micro-computers. This has led to this approach being a reliable technique to validate the energy balance equation and instantaneous estimation of vertical fluxes for heat, moisture, and momentum.

2.1.5 Other Methods. Other methods include Sap flow method, which entirely depends upon the plant physiology. This method is suggested and discussed by Cohen et al. (1988), Granier (1985) and Steinberg et al. (1990), which is based, on heat balance or heat pulse approach. The heat balance approach involves the artificial application of heat to the plant stem and measurement of heat losses using thermocouples. The difference between heat input and losses is considered to be utilized through convection of sap flow up the stem and is related to water flow (Kjelgaard et al. 1997). This method is used to estimate only transpiration from a plant or group of plants.

Meteorological equations can also be employed for ET_c estimation at shorter intervals. Failure of these equations to consider crop canopy characteristics limits this approach for application.

2.2 Reference Evapotranspiration (ET_o) and Estimation Models/Equations. When evapotranspiration is measured or estimated over a reference crop surface, it is considered as ET_o . Reference surface is conveniently assumed as a hypothetical crop (vegetative) surface with some specific characteristics (Smith et al. 1991; Allen et al. 1994; Allen et al. 1998). Characteristics of reference crop surface include uniformity, active growth of vegetation covering the soil surface with a particular height and surface resistance, no lack of available soil moisture, and a good fetch of surface grass. Reference evapotranspiration (ET_o) over such a surface is entirely influenced by weather and can be computed from weather data (Kassam and Smith 2001). Since early nineteenth century, many empirical equations and combination models have been developed by researchers from various fields but all of them are developed under a particular set of conditions, which restrict their use only under similar environmental conditions. A brief review of most of these models of combination theory and empirical equations follows.

2.2.1 Based on Empirical Relationship. In earlier times, many researchers made successful attempts to relate ET_o with weather variables like temperature, solar radiation, and relative humidity and they provided some empirical equations for ET_o estimation based on these weather variables. Some commonly used empirical methods based on different weather variables are briefly reviewed here.

2.2.1.1 Thornthwaite Method. In 1948, Thornthwaite derived an empirical equation for potential ET estimation by correlating ET with mean air temperature. A general form of the equation for unadjusted potential ET (based on standard month of 30 days and 12 hrs of sunlight per day) was given as:

$$ET' = 16 (10 T_a/I)^a$$

were ET' is unadjusted potential ET (mm), T_a is mean monthly air temperature ($^{\circ}\text{C}$), 'a' is a constant that varies with a variable called heat index I as cited by Xu and Singh (2001). The value of exponent 'a' is calculated with the following expression:

$$a = 67.5 * 10^{-8}I^3 - 77.1 * 10^{-2}I^2 + 0.0179I + 0.492$$

The value of 'a' lies between 0 and 4.25, while annual heat index (I) can be computed by summation of monthly values of heat index over 12 months. On a monthly basis, heat index is calculated as follows:

$$i = (T_a/5)^{1.514}$$

The unadjusted value of potential ET is adjusted depending upon the number of days (N) in a month and duration of mean monthly or daily daylight (d) as follows:

$$ET = ET' * (d/12) * (N/30)$$

The complexities and empiricism of an equation lacking in theoretical foundation and depending only on temperature are the basic hurdles for correct estimation of potential ET by this method.

2.2.1.2 Blaney-Criddle Method. Blaney and Criddle in 1950 gave an empirical expression to estimate the ET_0 which was entirely based on correlation of ET with air temperature and daylight factors. The mathematical relationship in terms of metric units is written as follows:

$$ET = kp (0.46T_a + 8.13)$$

where ET is reference evapotranspiration (in mm) for daily or monthly, k is monthly consumptive use coefficient (depending upon type of vegetation, time of year and location), p is

mean monthly percentage of annual day time hours (percentage of total day time hours for period of daily or monthly out of total day time hours of the year), and T_a is mean temperature in °C as cited by Xu and Singh (2001). Although this method has been revised (USDA-SCS 1970, Doorenbos and Pruitt 1975) and used extensively (Singh 1989), a limitation of this method is in its accuracy of ET estimation due to dependence on few variables and is mostly used for longer time period ET estimation (Wright 1985).

2.2.1.3 Hargreaves Method. Hargreaves and Samani (1985) suggested an equation for estimating reference grass ET which was based on air temperature, difference between maximum and minimum air temperature, and solar radiation. The form of this equation was given as

$$ET = 0.0023 TD_C^{0.5} (T_C + 17.8) R_S$$

where TD_C is the difference between maximum and minimum daily air temperature, T_C is mean air temperature in °C, and R_S is solar radiation in mm day⁻¹ or inches day⁻¹ which is proposed to be calculated from extraterrestrial solar radiation. Extraterrestrial solar radiation can be computed from a different set of equations or can be found from tables for a particular location and day of the year (Jensen et al. 1990).

2.2.1.4 Jensen and Haise Method. Jensen and Haise (1963) introduced an empirical relationship of potential ET with climatic variables like temperature and radiation. It is as given as follow:

$$ET = (0.014 T - 0.37) R_S$$

where ET is potential evapotranspiration (inches day⁻¹), T is mean air temperature in (°F), and R_S is solar radiation in (inches day⁻¹). This method was able to estimate potential ET for shorter time periods of 5 or 10 days.

2.2.1.5 Turc Method. Turc (1961) developed an empirical expression for estimating ET_o by correlating it with air temperature and solar radiation. The equation is written in the following form:

$$ET_o = 0.013 * (23.88 * R_s + 50) * T * (T + 15)^{-1}$$

where ET_o represents reference ET (mm day^{-1}); T is air temperature ($^{\circ}\text{C}$), and R_s is solar radiation ($\text{MJ m}^{-2} \text{ day}^{-1}$). It is one of the simplest and most accurate methods of ET_o estimation under humid regions (Jensen et al. 1990).

2.2.1.6 Priestley and Taylor Equation. Priestley and Taylor (1972) defined the term potential evaporation (PE) as “evaporation from horizontally uniform surface” and proposed a simplified version of Penman’s equation for estimation of potential ET based on temperature and radiations over a substantial land area. The empirical equation was expressed as follows:

$$PE = \frac{\alpha}{\lambda} \frac{\Delta}{\Delta + \gamma} (Q^* - G)$$

Where PE represents potential evaporation as depth of water, α is Priestly-Taylor’s coefficient, Δ is rate of change of saturation vapor pressure with temperature ($\text{k Pa } ^{\circ}\text{C}^{-1}$), λ is latent heat of vaporization (MJ kg^{-1}) γ is psychrometric constant, Q^* is net radiation ($\text{MJ m}^{-2} \text{ day}^{-1}$), and G represents soil heat flux ($\text{MJ m}^{-2} \text{ day}^{-1}$). The Priestley-Taylor PE equation provides a good alternative to Penman’s equation for estimating potential ET under humid regions (Gunston and Batchelor 1983).

2.2.1.7 FAO Radiation Method. In the Food and Agricultural Organization of United Nations 24 report, Doorenbos and Pruitt (1975) have described FAO radiation method as another

approach to compute ET_o using weather variables like radiation and air temperature. The empirical relation of ET_o is written in the following form:

$$ET_{ref} = c (0.408WR_S)$$

Where ET_{ref} represents ET_o as depth of water per day, c is a constant that varies with mean relative humidity and daytime wind speed, W is another constant that varies with temperature and altitude, and R_S is shortwave solar radiation. The dependence of this method only on temperature and sunlight hours makes it a useful method of ET_o estimation for areas where wind speed data are not available (Chiew et al. 1995).

2.2.1.8 FAO-24 Pan Evaporation Method. FAO Irrigation and Drainage Paper 24 on guidelines for predicting crop water requirements recommends values of pan coefficient ‘ c ’, which depends on a long term average of mean relative humidity, wind speed, and distance of windward side of a green crop. This pan coefficient is used in estimation of reference crop ET on daily time period (Doorenbos and Pruitt 1975).

2.2.2 Based on Combination Methods. In 1948, Penman introduced a theoretical method of ET_o estimation from an open water surface by combining the effects of radiation energy used for evaporation and aerodynamic movement of water vapor from an evaporating surface. This method has served as a fundamental approach for current methodology of ET_o estimation. The daily basis estimation of open water evaporation by the Penman formula using meteorological data is given as:

$$E_o = \frac{\frac{\Delta(R_n-G)}{\lambda} + \gamma E_a}{\Delta + \gamma}$$

where E_o represents open water evaporation rate ($\text{kgm}^{-2}\text{s}^{-1}$), Δ is proportionality constant ($\text{kPa}^\circ\text{C}^{-1}$), R_n is net radiation (W m^{-2}), G is heat flux density into the water body (Wm^{-2}), λ is latent heat of vaporization (Jkg^{-1}), γ is psychrometric constant ($\text{kPa}^\circ\text{C}^{-1}$), and E_a is isothermal evaporation rate ($\text{kg m}^{-2} \text{s}^{-1}$). The evaporation rate (kgm^{-2}) should be multiplied with 86400 to convert into mm day^{-1} .

FAO Irrigation and Drainage Paper No. 24 by Doorenbos and Pruitt (1975) recommended some modification to the Penman method for estimation of ET_o from a grass surface of 8 to 15 cm height and not short of water supply instead of water surface. The major modification to Penman's method includes a different shortwave reflection coefficient for grass (0.25 for grass and 0.05 for water), wind function in aerodynamic term, and adjustment factor. The modified FAO Penman method is given as:

$$ET_g = \frac{c(\Delta * R_n)}{\Delta + \gamma}$$

Monteith (1965) brought another modification to Penman's method by introducing a new term, canopy resistance (r_c), which takes into account the effects of crop morphology and specific plant characteristics on the ET rate. This modification led to a new method of ET_o estimation, called the Penman-Monteith equation. Some modifications in estimation of this resistance term are carried out afterward (Brown and Roosenberg 1973) and this method has evolved as one of the best available methods for ET_o estimation. In FAO Irrigation and Drainage Paper 56 (Allen et al. 1998), Penman-Monteith equation has been recommended as a standard method of ET_o estimation worldwide by defining the reference surface as a hypothetical grass surface with an assumed height of 0.12 m, with surface resistance of 70 s m^{-1} and albedo of 0.23 closely resembling the evaporation from extensive green grass of uniform height, actively growing, and

sufficiently watered. This FAO 56 paper provides guidelines for computation of ET_o and ET_c by using 'ET_o-K_c approach' which involves measuring or estimating meteorological data and a standardized calculation procedure depending upon available weather data and time scale.

Similarly, the Environment and Water Resources Institute (EWRI) of the American Society of Civil Engineers (ASCE) have standardized the reference surface and computation procedure of ET_o for inter-region transferability of K_c throughout the United States (Allen et al. 2005). Two reference surfaces (short crop similar to cool-season clipped grass and tall crop similar to full-cover alfalfa) were recommended for ET_o computation. The ET_o can be defined as the evapotranspiration rate from a uniform surface of dense actively growing vegetation having specified height and surface resistance, not short of soil water, and representing an expanse of at least 100 m of the same or similar vegetation (Allen et al. 2005).

2.3 Crop Coefficients (K_c). Crop coefficients (K_c) are defined as ratios of crop evapotranspiration (ET_c) to that of ET_o computed over a reference grass surface of standard height with no scarcity of available water (Wright 1982; Allen et al. 1998). Crop coefficients (K_c) values vary during the growing season with development of plants as fraction of ground covered by crop canopy changes (Allen et al. 2005). The general trend of K_c has been described in Irrigation and Drainage Paper No. 56, which describes the low value of K_c at initial stage, linear increase in K_c at development stage, almost constant value at mid-season, and decline in K_c late season (Allen et al. 1998). Based on lysimeter data and FAO Penman-Monteith ET_o estimates, Allen et al. (1998) documented K_c for irrigated cotton as 1.15 to 1.2 for mid-season and 0.4 to 0.5 for late season while K_c values for initial and development period vary widely depending on irrigation and rainfall. Many attempts have been made to determine the cotton K_c

values in different parts of the world. Below is the review of the cotton water use studies for computation of K_c values.

2.3.1 Cotton K_c . Farahani et al. (2008) conducted a study to develop K_c for short season cotton (*Gossypium hirsutum* L.) at Tel Hadya station in the Mediterranean region of northern Syria. Soil at the study site was classified as fine clay, 1.5-2.0 m deep with volumetric water contents of 38 and 22 % at field capacity and permanent wilting point, respectively (Ryan et al. 1997). Cotton variety 'Alleop-118' was managed for 3 years with similar cultural practices. For comparison among three growing seasons, the period from May 6 (one day after emergence) to September 24 (142 days after emergence) was used for representation of the growing season. A drip irrigation system was designed and managed to irrigate the plots and soil water content was regularly monitored with the neutron scattering method at weekly intervals. Irrigation was applied when soil water content in top 3 to 4 soil layers approached, but did not drop below, 50% of available soil water. Crop evapotranspiration (ET_c) was computed using the soil water budget method while ET_o was computed with the Penman-Monteith equation as described in FAO-56. Locally developed K_c curves and FAO-56 adjusted K_c curves were prepared for each year of the study. Mean seasonal ET_c values of 895, 927, and 813 mm were measured while seasonal ET_o values of 1204, 1224, and 1336 mm were measured in 2004, 2005, and 2006, respectively. In three years, the FAO-56 adjusted K_c curve was basically the same with an average K_c value of 0.20, 1.30, and 0.71 at initial, middle, and end of season, respectively. The locally developed K_c curve was different for each year and also differed from the FAO-56 adjusted K_c curve. Results showed that locally developed K_c values were generally lower by 24% for mid-season stage as compared to the FAO-56 K_c curve. On a seasonal basis, ET_c computed with FAO-56 adjusted K_c

values overestimated ET_c calculated with locally developed K_c values by 10, 10, and 33% in 2004, 2005, and 2006, respectively, with an average of 17% (or 150 mm water) for 3 years.

Suleiman et al. (2007) conducted an experiment to evaluate FAO-56 K_c and procedures for determining ET_c for deficit irrigation management of cotton in the humid climate of Griffin, GA in 2005. The mid-full season cotton variety 'DP 555 (BG/RR)' was planted in sandy soil of three automated rainout shelters. Three irrigation treatments of 40, 60, and 90 % irrigation threshold (IT) were applied. For irrigation scheduling, Cropping System Model (CSM)-CROPGRO-Cotton was used. Crop evapotranspiration (ET_c) was estimated from soil moisture measurements made through Time-Domain-Reflectometer and leaf area index measurements. Reference evapotranspiration (ET_o) was calculated using the Priestly-Taylor equation. Suleiman et al. (2007) observed K_c values of 0.51, 0.9, and 0.99 at initial stage for the 40, 60, and 90% IT treatments while for mid-stage, K_c values were 1.2 for 40 and 60% IT and 0.92 for 90% IT, respectively. K_c for end of season was observed to be 0.1 for 40%, 0.38 for 60%, and 0.58 for 90% IT (Suleiman et al. 2007).

In a semi-arid region of Lebanon, an experiment was conducted in clay soil to determine water use for cotton variety 'AgriPro AP 7114' in 2001 and 2002 at Tal Amara Research Station (Karam et al. 2006). Movable sprinkler systems were used for irrigation before emergence of the crop while drip system was used thereafter in both years. In 2001, ET_c was directly measured using two drainage lysimeters and ET_o was measured over rye grass grown onto two drainage lysimeters at weekly intervals. Average K_c values for initial growth stages (sowing to squaring), mid growth stages (first bloom to first open boll), and late growth stages (early boll loading to mature bolls) were 0.58, 1.10, and 0.83, respectively, during 2001 (Karam et al. 2006). These K_c values were used to estimate ET_c in 2002.

Mohan and Arumugam (1994) conducted a study to develop cotton K_c for the wet tropical climate of south India. Cotton 'MCU-9' was planted in a clay loam soil at Coimbatore during 1976 to 1985. The cotton crop was irrigated at approximately 25% maximum depletion of available water in the root zone during each growing season. Crop evapotranspiration (ET_c) was estimated from two gravimetric lysimeters planted with cotton while ET_o was estimated from a grass surface using the FAO modified Penman Method. Mohan and Arumugam (1994) identified four growth stages of cotton, namely initial, crop development, mid-season, and late season with 25, 55, 65, and 45 growing days, respectively. Average K_c for the six growing seasons were 0.46, 0.70, 1.01, and 0.39 for initial, crop development, mid-season, and late season growth stages, respectively. A simple linear relationship was also observed for K_c values against days with R^2 value of 0.471, 0.804, 0.898, 0.840 and standard error of 0.073, 0.094, 0.077 and 0.040 for each growth stage, respectively.

Ko et al. (2009) developed growth-stage specific K_c for cotton at Uvalde TX during 2006 and 2007. Cotton variety 'DP555' was planted into a silty clay soil in both growing seasons. Six large weighing lysimeters were used to estimate ET_c while one weighing lysimeter, installed and planted with fescue grass, was used to estimate ET_o (Lys ET_o). ASCE Penman-Monteith equation was also employed to estimate ET_o (ASCE ET_o). A lateral movable sprinkler system was used to irrigate the lysimeter fields while subsurface drip system was used for the grass lysimeter. A comparison between Lys ET_o and ASCE ET_o was made using a paired T test and RMSE and MRE statistics. Crop coefficients (K_c) values of 0.40 for seeding, 1.25 for 25% open boll, and 0.60 at 95% open boll stages were observed. Distribution of K_c over the entire growing season was fit with third order polynomial equations in both seasons.

Hribal (2009) determined cotton K_c for the northeastern part of LA by conducting an experiment using paired weighing lysimeters. Cotton variety ‘Deltapine 555 BR/RR’ was planted on paired weighing lysimeters and surrounding area and daily changes in lysimeter mass were used to compute daily values of ET_c . Reference ET_o was estimated by measuring daily air temperature, relative humidity, wind speed, and solar radiation with use of SREE of ASCE Penman-Monteith equation. A movable sprinkler system was used to irrigate the crop throughout the season. Irrigation was scheduled at 5 cm water loss from the upper soil surface or when 30 or 60 cm depth tensiometers attained a gauge reading of 70 to 80 centibars. Average K_c values for initial period (0 to 29 days after emergence), development period (30 to 69 days after emergence) and mid-season (70 to 136 days after emergence) were 0.15, 0.64, and 1.39 respectively. The major shortcomings in this methodology were a non-standard reference grass surface, inadequate fetch, and measurement of solar radiation from a portable weather station near the cotton field but not over the grass surface.

Allen et al. (1998) revised the K_c procedure and developed guidelines for basal crop coefficients, K_{cb} , for estimating crop water use. The K_{cb} separates evaporation and transpiration components of ET_c .

Howell et al. (2004) studied cotton water use using precision weighing lysimeters during 2000 and 2001 in the Northern Texas High Plains at Bushland TX. Cotton variety ‘Paymaster 2145’ was planted on a Pullman clay loam soil in each season and irrigated with a lateral movable sprinkler system. Three irrigation treatments (fully irrigated, deficiently irrigated, and dry land regimes) were applied. ET_c was calculated by measuring changes in lysimeter mass divided by their respective areas while ET_o was calculated using the FAO-56 ET_o equation. In both years,

mean adjusted K_{cb} values were calculated around 0.15, 1.23, and 0.20 for initial, mid-season, and late season stages, respectively.

Hunsaker (1999) conducted a two year study to develop K_{cb} for early maturing cotton in central AZ. The study was conducted in small and large level basins on well-drained, sandy loam soil. ‘DPL-20’, an early-maturing cultivar with a compacted primary fruiting cycle, was planted in both years. Three irrigation treatments high frequency (H), low frequency (L), and low-high-low frequency (LHL) were randomly applied to 18 small level basins while L and LHL treatments were applied to large level basins. Time-Domain-Reflectometry (TDR) and a site calibrated neutron probe were used to measure soil water content at 0 to 0.30 m and 0.40 m to 2.0 m with 0.20 m increments for small level basins while a 0 to 2.8 m soil depth was used for soil water measurements in case of large level basins. Cotton evapotranspiration (ET_c) was computed for each time period as a summation of measured changes in soil water storage including depth of irrigation and rainfall divided by number of days in that time period. An in line propeller-type water meter was used to quantify the amount of irrigation water applied. Arizona Meteorological Network weather station, situated over a uniform grass surface and about 300 m east of the field site, was used to measure daily weather data for E_o calculation using a modified Penman method. The computed basal K_{cb} for H and LHL frequency irrigation treatments was plotted against days after planting (DAP) and cumulative growing degree days (CGDD) with fifth order polynomial least squares regressions in addition to the straight line K_{cb} curve. Results have shown that cumulative ET_c for H frequency and LHL frequency irrigation treatments were similar for the first year while in the second year the H frequency irrigation treatment resulted in higher ET_c as compared to HLH frequency irrigation treatment. In case of the DAP curve, 0.20 and 1.30 were minimum and maximum values of K_{cb} but minimum and maximum values of K_{cb} were 0.11 and

1.31 respectively, for CGDD curve. For the straight line curve, values of K_{cb} were 0.23, 0.23 to 1.30, 1.30, and 1.30 to 0.40 for initial, crop development, mid-season and late season stages, respectively.

Hunsaker et al. (2003) made an attempt to develop and evaluate cotton K_{cb} estimation model based on normalized difference vegetation index (NDVI) for the Desert Southwest. The data collected for FACE (Free-Air CO₂ Enrichment) experiments in 1990 and 1991 were used to compute K_{cb} using FAO-56 dual K_c procedure for developing an NDVI-based K_{cb} estimation model. The soil for FACE experiments was classified as a Trix clay loam and a sub-surface drip irrigation system was employed for water supply. The details of FACE experiments have been previously described (Mauney et al. 1994; Hunsaker et al. 1994 and Pinter et al. 1994, 1996). Canopy height (h_c) and leaf area index (LAI) were measured at 7 to 14 day intervals for both growing seasons while daily ET_c was calculated with soil water balance equation. The daily grass ET_o was computed from daily measurements of weather parameters by AZMET weather station using the FAO Penman-Monteith method. Reflectance factors were measured 4 times a week using a hand-held four-band radiometer during both seasons, which were used to compute NDVI. In 1990, values for K_{cb} were around 0.2 after emergence while 3 months after planting, K_{cb} was approximately 1.1 to 1.3. Later in season, K_{cb} declined to approximately 0.7 to 0.5 at 150 days after planting (Hunsaker et al. 2003). In 1991, K_{cb} values were 0.15 during emergence, 1.1 to 1.3 90 days after planting, and declined to 0.7 to 0.6 at approximately 150 days after planting (Hunsaker et al. 2003). In both years, results showed that K_{cb} values and NDVI increased in a similar manner from early crop development until maximum K_{cb} was attained, when these parameters were plotted against days after planting. The maximum K_{cb} occurred at effective canopy closure in both years when NDVI values were 0.80 or above. Thereafter, K_{cb}

values started to decline while NDVI values showed a horizontal trend with a range of 0.85 to 0.92 until about 140 days after planting but started to decline after 140 days due to leaf senescence. To describe the distribution of K_{cb} over the entire growing season, NDVI-based K_{cb} model was developed using two separate regression functions. The first regression function was linear, which described the increase in K_{cb} with NDVI from early crop development ($NDVI \approx 0.15$) to effective crop canopy. This linear function resulted in an r^2 of 0.97. The second regression function was multiple regressions, which described the K_{cb} with growing degree days (GDD) along with a constant NDVI of 0.85 and 0.90 for the latter part of season. Both regression functions intersect at the time of effective full cover ($NDVI \approx 0.80$). The evaluation of the model was made with data collected for two plots within the ample N treatment of the 1998 cotton field experiment (Colaizzi et al. 2003). Results showed that the linear model had a tendency to overestimate the K_{cb} prior to NDVI reaching 0.80 while estimation was reasonably good during mid-season for both plots. However, there was underestimation of K_{cb} during the latter part of the season.

Hunsaker et al. (2005) evaluated and compared ET_c estimation, irrigation scheduling, and final lint yield of cotton using K_{cb} values based on frequent NDVI measurements and time-based locally derived K_{cb} curves during 2002 and 2003 in central AZ. Two main treatments (FAO based K_{cb} estimation method and NDVI based K_{cb} estimation method) were employed to 16 plots with a total of 32 plots in completely randomized design with incomplete blocking in sandy loam textured soil. Two gated pipe irrigation systems with 152 mm in diameter were installed and extended along the length of the field for irrigation purpose and irrigation scheduling was based on the estimated soil water depletion of more than 43% total available water of the effective rooting depth. Hunsaker et al. (2005) observed FAO-56 dual crop coefficients K_{cb} as 0.15 for

initial stage (35 days), 1.20 for mid-season (46 days), and 0.52 for end of season (day length not available) while NDVI-based K_{cb} estimation method led to two regression functions, one for initial period of crop development until NDVI attained a value of 0.80 which was a linear regression function and a second order for late season ($NDVI > 0.80$), which was multiple regression with variables of NDVI and GDD (Hunsaker et al. 2003). In this study, it was found that both methods were not significantly different in K_{cb} estimation but NDVI-based K_{cb} estimation method could provide real time K_{cb} estimation without any kind of adjustment, which was not the case for time based K_{cb} estimation method (Hunsaker et al. 2005).

Ayars and Hutmacher (1994) studied the contribution of groundwater to cotton water use by using column lysimeters. Two above ground column lysimeters of 45 cm diameter packed with panoche clay loam soil were connected to a hydraulic pillow manometer system, which was used to determine actual ET_c . Basal crop coefficients (K_{cb}) from a previous study was used to attain the information on contribution of groundwater for ET_c , which further led to modified K_{cb} . Modified K_{cb} for cotton using a contribution of 0.3 ds m^{-1} groundwater at depth of 1.2 m in lysimeters were presented (Ayars and Hutmacher 1994) and use of these modified K_c for cotton growing at 1.2 to 2.2 m depth of groundwater under a drip irrigation system showed 100 mm or less water application as compared to assumption of zero contribution of groundwater.

CHAPTER 3

MATERIALS AND METHODS

To determine single day crop coefficient (K_c) value of any crop at a particular location, crop evapotranspiration (ET_c) and reference evapotranspiration (ET_o) estimates are required for that location. This study involves the daily measurement of cotton ET_c using paired weighing lysimeters and daily estimates of ET_o using a Standardized Reference Evapotranspiration Equation (SREE) recommended by the American Society of Civil Engineers (ASCE) over a standard reference surface, which in turn facilitates the determination of daily K_c values for the entire cotton growing season. The details on the location characteristics, lysimeters, reference weather station, and methodology in calculating ET_c and ET_o and development of daily K_c values are described in the following sections.

3.1 Location Characteristics. The study site is located within the alluvial floodplains of the Mississippi River at the LSU AgCenter Northeast Research Station near St. Joseph, LA in Tensas Parish (Figure 3.1). The research station is located at $31^{\circ} 56'N$ and $91^{\circ} 14'W$, at an elevation of approximately 23 m above sea level. The soil at the study site is a predominately Sharkey clay (very-fine, smectitic, thermic Chromic Epiaquerts) with shrink-swell properties. Based on a 30-years weather data (1971-2000) collected from the National Weather Service-National Oceanic Atmospheric Administration (NWS-NOAA 2009) Cooperative Observer Program (COOP) at the study site and cited by Hribal (2009), the climate of this region can be classified as sub-humid with the maximum air temperature occurs in July and minimum air temperature in January while maximum rainfall occurs in the months of January and March. The 2010 cotton growing season at the study site extended from May to early October. The weather conditions were hot and dry during early and late portions of the growing season. The

accumulation of heat units was rapid during the months of June and July, with unusually high nighttime temperature (John Kruse, LSU AgCenter Cotton and Feed Grains Extension Specialist, personal communication). Moderate to severe drought with Palmer Drought Severity Index (PDSI) of (-2.0 to -2.9) and (-3.0 to -3.9) respectively, was observed during early and late season (NWS-NOAA 2010). Average monthly air temperature of 22.6, 27.3, 27, 27.2 and 24.3 °C was recorded during the months of May, June, July, August, and September, respectively, while accumulated rainfall of 3.9, 2.4, 9.6, 18.3 and 2.66 cm was recorded during these respective months. The average monthly air temperature for the months of June and August was 1.3 and 0.7 °C higher compared with mean air temperature recorded at the study site from 1971-2000, while the remaining months had similar air temperature as compared to the temperature data from 1971-2000 as cited by Hribal (2009).



Figure 3.1 Map of Louisiana highlighting Tensas Parish.

Accumulated rainfall of 10.1, 6.8, and 4.84 centimeters, recorded for the months of May, June, and September, respectively, was lower compared to average rainfall for these months from 1971-2000 as cited by Hribal (2009). The months of July and August resulted in normal rainfall as recorded in previous years. Overall, the 2010 growing season can be considered a “good season” for cotton production in Louisiana, with dry periods late in the season allowing for timely harvest (John Kruse, LSU AgCenter Cotton and Feed Grains Specialists, personal communication).

3.2 Lysimeter Installation, Calibration, and Maintenance. Weighing lysimeters are used directly to measure ET_c by measuring changes in weight of a crop/soil unit (Howell et al. 1995; Marek et al. 2006). To measure daily estimates of ET_c , paired weighing lysimeters were installed at the LSU AgCenter Northeast Research Station in 2005. The weighing lysimeters consisted of inner and outer tanks, repacked with soil to accommodate crop plants, and a weighing system beneath the inner tank. Details on the lysimeter site, installation, design, and calibration have been previously described (Clawson et al. 2009). The location of paired weighing lysimeters at present is shown in Figure 3.2. The lysimeter site shown in Figure 3.2 was shifted in 2008 to a nearby field to facilitate adequate crop fetch and ease of irrigation water supply. A lysimeter cross sectional view showing dimensions of the inner and outer tanks along with load cells is shown in Figure 3.3 (Clawson et al. 2009). To ensure the accuracy of mass measurements by the lysimeters, calibration was performed on February 19 and 20, 2010 for the north and south lysimeter, respectively. Calibration was performed by following Howell et al. (1995) method with local modifications. The inner tanks of each lysimeter were drained and soil removed from the surface of both lysimeters to reduce weight. A wooden board was placed on the leveled surface of both lysimeters and covered with fabric sheet to prevent evaporation. A tent was

erected over the lysimeter site to avoid wind interference during calibration (Howell et al. 1995). Twenty large weights made up of iron (each weighing 22.68 kg) were placed one by one on each lysimeter (loading of weights) and removed one after one (unloading of weights). At two points during loading of the weights, five small weights of 2.0, 1.0, 0.5, 0.2, and 0.1 kg were applied one by one on each lysimeter and then removed in reverse order, respectively. The calibration range for the weights was 0 to 453.59 kg. The weights were obtained from a commercial scale company and calibrated at the Mississippi Metrology Laboratory as described by Clawson et al. (2009). A time period of 90 seconds was used for settling of the weights with 1 minute time period of data recording. The individual load cell output, along with summed 4 load cell output, was recorded during each change in added weight using a Campbell Scientific Inc. CR 3000 data logger.



Figure 3.2 Weighing lysimeters, viewed from the southeast toward the northwest, LSU AgCenter Northeast Research Station, Saint Joseph, LA.

A total of 41 calibration data points were collected for each change in mass for both lysimeters. For analysis, both lysimeters mass were regressed on the summed output of 4 load cells (mVV^{-1}) using large weight calibration data points as shown in Figure 3.4 (Howell et al. 1995).

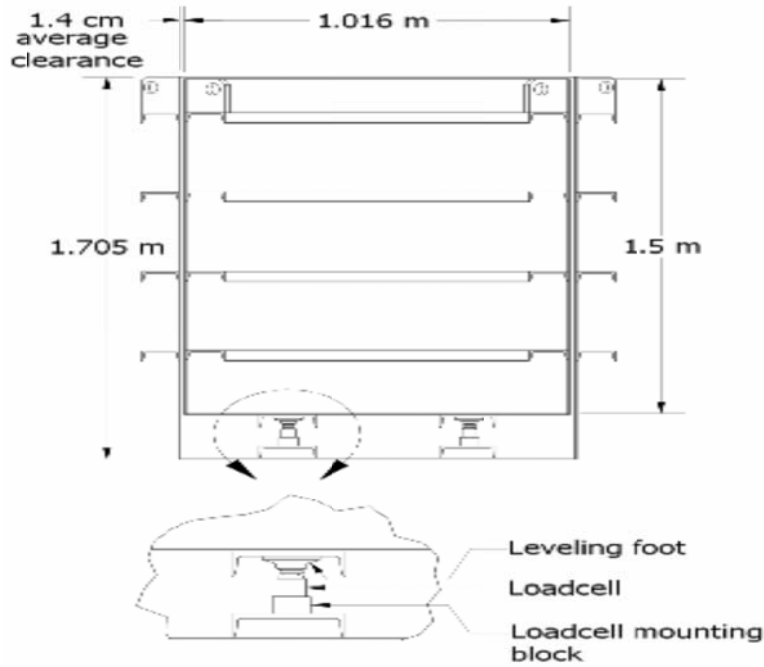

Figure.3.3 Weighing lysimeter in cross-sectional view (Image reproduced from Clawson et al. 2009).

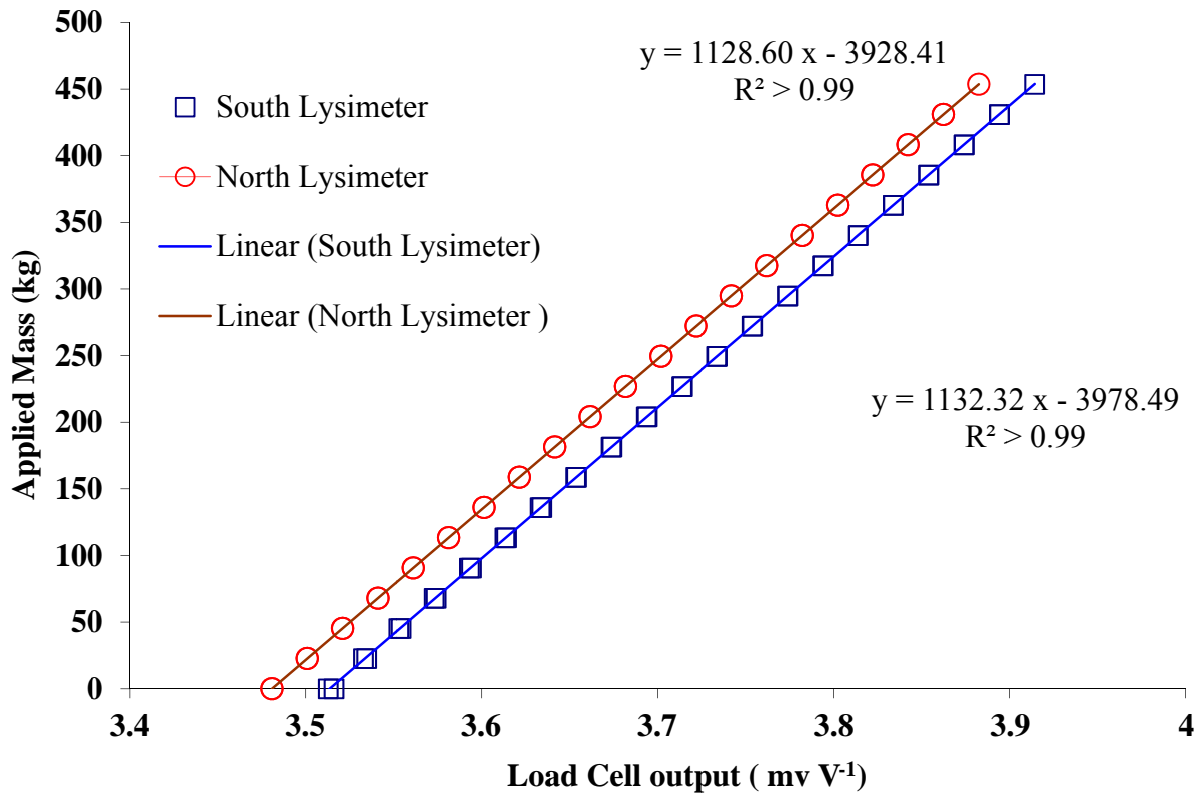

Figure 3.4 Calibration results for the north and south lysimeter in 2010.

Results indicated an R^2 value of > 0.9999 for both lysimeters (Figure 3.4). The standard error S_{yx} for the north and south lysimeters was 0.00339 and 0.0354 mm, respectively. The high R^2 values for both lysimeters and low standard error indicate a strong linear relationship between applied mass and load cell output, which further ensure the accuracy of lysimeter data during normal growing periods (Howell et al. 1995). During hysteresis evaluation, it was found that three initial data points deviated for the south lysimeter, which were removed to obtain the best fit regression equation. The offsets and slopes of regression equations for both lysimeters were determined using best fit regression equations. The values for offsets and slopes were 3928.41, 1128.60 for the north and 3971.51, 1130.47 for the south lysimeters. These offsets and slopes were used in data logger programming to convert raw outputs of load cells into equivalent masses (kgs) for seasonal data collection. Lysimeters were frequently inspected for abnormal mass changes during the data acquisition period. Any abnormal weight changes were scrutinized daily via data inspection and discarded. Every effort was made to avoid any addition of debris onto the lysimeters from surrounding areas during irrigation events. After rainfall events, excess water in the inner and outer tanks of the lysimeters were drained via a battery operated pump after rainfall or irrigation whenever field conditions allowed accessibility to the units. Sealing of rubberized fabric enclosing inner and outer tanks was inspected regularly to avoid any leakage of water to the outer tank. PVC conduits carrying load cell wires were regularly inspected and desiccants were frequently changed in the data logger to avoid any moisture accumulation.

3.3 Reference Weather Station Establishment and Management. As mentioned previously, procedures and standards have been set up by ASCE for the estimation of ET_o from daily measurement of weather variables (Allen et al. 2005). To meet these reference surface standards, an area of 2 hectares was laser leveled and seeded with common Bermuda grass (*Cynodon*

dactylon L.) 98/85 at a rate of 80 kg ha⁻¹ on April 17, 2009. An area 102 m by 102 m was demarcated from the reference site and divided into 3 sections for ease of irrigation application. A weather tower 10 m in height instrumented with different sensors was installed in the center of the demarcated area to allow a 50 m fetch of clipped grass surface in all directions (Allen et al. 2005) (Figure 3.5). Information on types of sensors, manufacturer, and installation heights is summarized in Table 3.1.

Table 3.1 Information on instrumentation of reference weather station at the LSU AgCenter Northeast Research Station.

Sensors	Manufacturer & Model	Height on Tower (m)
Wind direction & speed	RM Young, 05103.5 wind monitor	3 & 10
Temperature & humidity	Vaisala, HMP 45 AC	2 & 9
Solar radiation	Li-COR, LI200SZ	1.5
Net radiometer	Kipp&Zonen, NR lite	1.5
Data logger	Campbell Scientific, CR 3000	1.5
Radios (900 MHz)	Campbell Scientific, RF 401	1.5

A wind sensor at a height of 3 m and temperature humidity probe at 2 m were used to measure temperature, humidity, and wind speed. Wind speed at 3 m height was adjusted to 2 m height using a standard conversion previously described (Allen et al. 2005) as follows:

$$U_2 = \frac{4.87U_z}{\ln(67.8 Z_w - 5.42)}$$

Where U_z is wind speed (m s⁻¹) at height of Z_w above the ground surface. In addition to sensors listed in Table 3.1, three thermocouples at depths of 5, 10, and 25 cm and 3 soil heat flux plates were also installed in the ground near the tower to measure soil temperature and soil heat flux.

Instrumentation of the reference weather tower was completed in July 2009 and levees were constructed around the reference grass area to hold irrigation water. Regular inspection of



Figure 3.5 Reference weather station at the LSU AgCenter Northeast Research Station 2010. weather sensors was conducted to ensure proper functioning and maintenance. Desiccants were changed regularly to avoid malfunctioning of the data logger due to moisture accumulation in the data logger box.

In 2010, sensors for temperature, humidity, wind speed, and solar radiation were calibrated by Campbell Scientific Inc. and reinstalled on March 3. To avoid infestation of annual and broadleaf weeds, atrazine (1680 g ha^{-1}) and pendimethalin (693 g ha^{-1}) were applied to the Bermuda grass on January 28. Urea ammonium nitrate (UAN) was applied at the rate of 110 kg N ha^{-1} on February 19. For maintaining a standard grass height of 0.12 m throughout growing season (Allen et al. 2005), mowing of Bermuda grass was conducted at frequent intervals. Levees were also mowed to avoid any interruption for wind movement over the reference grass surface. A flood irrigation system was employed to irrigate the reference weather station throughout

growing season to ensure optimal growth of the Bermuda grass. Irrigation was applied on the basis of visual observation of grass and soil conditions. An ample supply of irrigation water was provided to ensure adequate moisture conditions. A timeline for mowing and irrigation for 2010 is summarized in Table 3.2.

Table 3.2 Timeline for mowing, irrigation and rainfall on reference grass in 2010.

Dates	Mowing	Irrigation	Rainfall (mm)
4/22/2010	Yes	No	No
5/17/2010	No	No	12
5/20/2010	Yes	No	12
6/4/2010	No	Yes	1
6/5/2010	No	No	17
6/25/2010	Yes	No	No
6/28/2010	No	Yes	No
6/29/2010	No	Yes	No
7/16/2010	No	No	25
7/18/2010	No	No	22
8/2/2010	Yes	No	No
8/3/2010	No	Yes	No
8/5/2010	No	No	37
8/13/2010	No	No	25
8/18/2010	No	No	63
8/22/2010	No	No	41
9/7/2010	Yes	No	7

3.4 Cotton Field Establishment. After field preparation and lysimeter calibration early in the season, a pre-plant irrigation was applied on May 5 to facilitate seed germination. Cotton (*Gossypium hirsutum* L.) variety ‘Stoneville ST 5458 B2RF’ was hand planted at a rate of 160,000 seeds ha⁻¹ (approximately 16 plants m⁻¹) in the lysimeter (single row) and surrounding areas on May 11. The remaining areas of the field were planted with a John Deere Vacuum planter. A few transplants were also prepared separately and used to fill in gaps around the lysimeter area. Hand thinning of cotton plants was conducted on May 24 to maintain a plant population of

approximately 12 to 13 plants per meter row on lysimeters and surrounding beds (Figure 3.6). The field was fertilized with UAN at a rate of 136 kg N ha⁻¹ using a fertilizer rig while the surrounding area of lysimeters was fertilized at a rate of 91 kg N ha⁻¹ on May 31. The lysimeters were not fertilized with UAN in the growing season. The fertilization of the surrounding areas of the lysimeters was carried out by creating a ridge near cotton plants and placing the fertilizer into the ridge using a syringe followed by covering with soil. Fertilizer was re-applied at a rate of 57 kg N ha⁻¹ on selected plants exhibiting slight chlorosis near lysimeters on June 25. Plant protection measures were taken to keep the crop free from insect and weed pests throughout the growing season as recommended by LSU AgCenter entomologists and weed scientists.



Figure 3.6 Cotton crop developing on weighing lysimeters and surrounding areas in 2010. Furrow irrigation was utilized on the entire field except the lysimeters, where water was supplied manually using containers. Irrigation was scheduled primarily based on visual observation and tensiometer readings. Irrigation was scheduled when 30 cm (1 foot) and 61 cm (2 foot) tensiometer readings reached 60 centibars or surface soil formed deep cracks. For each lysimeter, 80 liters of water equivalent to 5 cm water depth (equivalent to 2 inch irrigation depth) was used

at the time of irrigation. To maintain equal soil water status, lysimeters were also drained after irrigation or rainfall whenever fields were accessible. The irrigation and drainage events for both lysimeters have been summarized in Table 3.3. To monitor the soil water profile accurately, 4 sets of soil moisture Jet Fill tensiometers (Soil Moisture Equipment Corp., Santa Barbara, CA) were installed on both lysimeters and two other locations within the field by mid-June. Each set, consisting of 4 tensiometers, was installed at a depth of 30, 61, 91, and 122 cm onto lysimeters and two other locations in the field.

Table 3.3 Timeline on irrigation and drainage events for both lysimeters in 2010.

Dates	Irrigation	Drainage
6/3/2010	Yes	No
6/18/2010	Yes	No
7/13/2010	Yes	Yes
7/21/2010	No	Yes
8/3/2010	Yes	No
8/6/2010	No	Yes
8/19/2010	No	Yes
8/23/2010	No	Yes
9/16/2010	Yes	No

The tensiometer tubes were filled with a solution of algaecide and water, followed by air removal using a hand operated vacuum pump. The fluid reservoir for each tensiometer was also filled with algaecide solution and attached to the top of tube. The jets on the reservoir were pressed to top-off the liquid in the tensiometer tube. Each set of four tensiometers was installed at about 20 cm spacing on the plant row in the order of 91, 30, 122 and 61 cm depth. A soil probe was used to create holes for the tensiometers and the bottom soil collected from each hole was used to prepare slurry to ensure proper contact between tensiometers and the soil in the respective holes. The same order of the tensiometers was installed on the lysimeters and two representative locations. Regular monitoring of tensiometers was conducted for removal of air bubbles and

filling of tubes. Soil water potential (in centibars) was recorded from mid-July to mid-August. The length of tensiometer tube filled with liquid also adds some tension, in addition to soil water tension recorded by tensiometer gauge. Therefore, it becomes necessary to adjust the tensiometers readings according to depths of tensiometers. The extra tensions from tensiometers at depths of 30, 61, 91 and 122 cm were 3.0, 6.1, 9.1 and 12.2 centibars, which were subtracted from actual soil water tensions recorded by tensiometers gauges.

3.5 Data Collection and Analysis.

3.5.1 Crop Data. Growth stages are important partitions of the crop growth period to distribute K_c values over the entire growing season. Allen et al. (1998) reported K_c values for specific growth stages of cotton in TX which were identified by number of days: initial (30 days after planting), crop development (50 days after planting), mid-season (55 days after planting), and late season (45 days after planting). The phenological stages: match head square, bloom, boll opening and >60% bolls opening, were identified in the current research. Match head square growth stage was identified by comparing the size of squares to actual size of a match head. Bloom was the appearance of a white flower and boll opening was appearance of the cracked boll. These growth stages were measured from both lysimeters plants and two other representative sides of the field to know the growth behavior of the crop and timing of these growth stages. Growth stage measurements were recorded at 14 day intervals. To identify the growth stages, a 2 m section of 4 crop rows was selected on the east and west sides of the lysimeters. On lysimeters, it was 1.5 m crop row section marked by the lengths of the lysimeters. Ten representative plants of healthy vigor were marked from selected sections to assess the growth stages. If greater than five plants within the selected section were observed to show any of above referenced growth stages, the entire crop was assumed to have reached that particular

growth stage. In addition, various growth parameters indicating growth and development of cotton plants were measured on both lysimeters and representative sides of the field. These included plant height, total number of nodes on main stem, internode length, nodes above white flower (NAWF), and canopy cover. Plant height was recorded as the distance in cm from ground surface to the tip of plant. The internode length was recorded as the distance between the third and fourth nodes from top of the plant. The NAWF was recorded as the number of nodes above the uppermost white flower on first fruiting branch. Canopy cover was recorded as percent of ground surface covered by plant material. Canopy cover was measured by placing a yard stick between the lysimeter crop row and side rows and was calculated by taking ratios of the stick lengths shaded on both ends of the rows by plants to the total yard stick length. Photographs were regularly taken overhead centered at the middle of the lysimeter crop row with east and west side crop rows (Figure 3.7). These photographs were also used in corroborating the manual ratings of canopy cover. All growth variables were measured from selected sections of crop plants as described for growth stages at 14 day intervals. The additional growth parameter measurements were also helpful in determining growth pattern and cotton water use.

3.5.2 Lysimeter Data. Lysimeter mass data was recorded using a Campbell Scientific Inc. CR 3000 data logger at time scan of 1 second starting from May 12 to September 20. The output of each load cell, along with combined output of 4 load cells, was recorded at an interval of 5 and 15 minutes, which represented an average of all the measurements recorded at 1 second time scan in the previous 5 and 15 minutes. The data logger was programmed to convert raw outputs of load cells (mv V^{-1}) to kg by using best fit offsets and slopes for each lysimeter computed from the calibration. Although data acquisition using a data logger is possible at an interval of a few minutes to several hours, the 15 minute time interval is more suitable for recording of lysimeter



78 Days after Planting

Figure 3.7 Canopy cover highlighting 20, 50, 80, and greater than 90 % shading of ground surface (from top to bottom) on lysimeters during 2010 cotton growing season.

data to avoid the effect of wind and error in ET_c estimation (Howell et al. 1995). Therefore, data on lysimeter mass recorded at 15 minute time intervals were used to estimate lysimeter ET_c on a daily basis. For a particular time period, ET_c is calculated as the difference of lysimeter mass at the beginning and end of that time period. The positive difference between lysimeter mass recorded at consecutive midnights was regarded as cotton water use for the previous day. These lysimeter mass differences ($kg\ day^{-1}$) were then divided by respective evaporative areas of 1.551 and 1.553 to convert into equivalent water depths ($mm\ day^{-1}$) for the south and north lysimeters, respectively. These evaporative areas were calculated by using lengths and widths measurements of each lysimeter which also included half of the clearance areas between inner and outer tanks of the lysimeter. The average of both lysimeters ET_c was computed to represent the daily ET_c of the cotton field.

The lysimeter data recorded at 5 minute intervals was used to inspect the quality of data being collected. Any unusual behavior of load cell measurements and sudden fluctuation in lysimeter mass were also scrutinized. Events such as rainfall, drainage, addition or removal of lysimeter soil etc. were also identified using lysimeter data at 5 minute interval. Data for those days were discarded for daily ET_c estimation due to the fact that crop water use cannot be determined by simple subtraction of lysimeter mass for those days. These events occurred on 46 out of 132 days of data. Suspicious data of any kind was not used for daily ET_c calculation.

3.5.3 ET_o Estimation. Based on its accuracy, simplicity, validity on daily time steps, and transferability among climates, Standardized Reference Evapotranspiration Equation (SREE) of ASCE was selected for the daily estimates of ET_o in the current research. Moreover, other methods of ET_o estimation have been found to vary with regions and time steps in Louisiana (Fontenot 2004). The recommended ET_o equation by ASCE was actually the Penman-Monteith

equation, which was standardized in terms of vegetation height, aerodynamic and bulk surface resistance, and zero plane displacement height. The SREE developed by ASCE to estimate ET_o over reference surfaces on daily basis is given below:

$$ET_{SZ} = \frac{0.408\Delta(R_n - G) + \gamma \frac{C_n}{T + 273} U_2 (e_s - e_a)}{\Delta + \gamma (1 + C_d U_2)}$$

where ET_{SZ} is the standardized reference crop evapotranspiration for short (ET_{os}) or tall (ET_{rs}) surfaces (mm day^{-1}), R_n is calculated net radiation at the crop surface ($\text{MJ m}^{-2} \text{day}^{-1}$), G is soil heat flux density at soil surface ($\text{MJ m}^{-2} \text{day}^{-1}$), T is mean daily air temperature at 1.5 to 2.5 m height ($^{\circ}\text{C}$), mean daily wind speed at 2-m height (m s^{-1}), e_s is saturation vapor pressure at 1.5 to 2.5 m height (k Pa) calculated at daily time steps as the average of saturation vapor pressure at maximum and minimum air temperature, e_a is mean actual vapor pressure at 1.5 to 2.5 m height (kPa), Δ is slope of saturation vapor pressure-temperature curve ($\text{kPa } ^{\circ}\text{C}^{-1}$), γ is psychrometric constant ($\text{k Pa } ^{\circ}\text{C}$), C_n is a numerator constant that changes with reference type ($\text{K mm s}^3 \text{Mg}^{-1} \text{day}^{-1}$), C_d is a denominator constant that changes with reference type (s m^{-1}), and 0.408 is a coefficient with units of $\text{m}^2 \text{mm MJ}^{-1}$ (Allen et al. 2005). The values of C_n and C_d for short grass are 900 and 0.34, respectively, at daily time steps (Allen et al. 2005).

To compute daily estimates of ET_o by SREE, weather variables including solar radiation (MJ m^{-2}), minimum, maximum and dew point air temperature ($^{\circ}\text{C}$), minimum and maximum relative humidity (%), and wind speed (m sec^{-1}) are needed (Allen et al. 2005). All these weather variables were recorded at daily and hourly intervals using a Campbell Scientific Inc. CR 3000 data logger with time scan of 3 seconds starting May 12. The data for weather variables were averaged over one minute interval, which were then averaged over hourly and daily time steps by the data logger. Daily inputs of weather variables were plugged into the SREE to estimate ET_o on

a daily basis. Data recorded at short time intervals were used to scrutinize the accuracy of weather variables being recorded. The data for days having unusual values (e.g. maximum RH exceeding 100%) and/or incomplete values of weather variables were discarded. Data for approximately 95% of the growing days were found usable for daily estimates of ET_o . Some quality assurances were followed such as comparison of minimum and dew point temperature, wind ratio (wind speed at the study site to that of wind speed recorded from nearby weather tower), and different methods of extraterrestrial solar radiation estimation before use in SREE for ET_o estimation as described in ASCE ET_o equation (Allen et al. 2005).

3.6 K_c Calculation and Statistical Analysis. Single day values of cotton K_c were determined by taking a ratio of ET_c measured by lysimeters to ET_o estimated by SREE of ASCE. The entire cotton growing season was divided into smaller time periods separated by phenological growth stages and K_c values were averaged out for these time periods. The average K_c values for initial and mid-season growth stage were calculated and straight lines for these stages were fitted and connected to represent developmental stage of cotton as described in FAO-56 Irrigation and Drainage paper (Allen et al. 1998). The K_c values were determined until cotton plants were defoliated on September 21. The lysimeter data after defoliation was not used for determining K_c values. The distribution of single day K_c values over the growing season was fit with second order polynomial regression. The K_c values were regressed against days after planting and growing degree days. Growing degree days were calculated by assuming a base temperature of 15.6 °C for cotton as follows (Wright and Sprengel 2005).

$$GDD = \left\{ \frac{T_{\max} + T_{\min}}{2} \right\} - 15.6$$

where GDD represents growing degree days, T_{\max} is daily maximum air temperature and T_{\min} is

daily minimum air temperature. The daily maximum and minimum air temperature data from the reference weather station were used in growing degree days calculation.

CHAPTER 4

RESULTS AND DISCUSSION

4.1 General Crop Characteristics. The crop characteristics for cotton plants on the north and south lysimeters are summarized in Tables 4.1 and 4.2 respectively.

Table 4.1 General crop characteristics for cotton plants on the north lysimeter.

Dates	Average No. of nodes	Average Plant height (cm)	*Internode length (cm)	Canopy cover (%)	NAWF
06/15/2010	9	38	5.33	30.0	NA
06/24/2010	13	56	7.11	40.0	NA
06/29/2010	14	65	7.62	44.5	NA
07/13/2010	17	81	5.58	55.0	NA
07/28/2010	20	102	5.84	77.5	6
08/11/2010	22	112	4.57	81.8	4

*Internode length is the distance between the 3rd and the 4th internodes from the top of the plant

Table 4.2 General crop characteristics for cotton plants on the south lysimeter.

Dates	Average No. of nodes	Average Plant height (cm)	*Internode length (cm)	Canopy cover (%)	NAWF
06/15/2010	10	43	5.58	31.0	NA
06/24/2010	12	65	6.85	41.0	NA
06/29/2010	15	66	7.62	44.0	NA
07/13/2010	16	84	4.57	57.5	NA
07/28/2010	20	102	5.08	78.0	6
08/11/2010	21	107	4.31	80.5	4

*Internode length is the distance between the 3rd and the 4th internodes from the top of the plant

In general, plants showed normal growth and development in terms of these characteristics with rapid growth initially and slower growth at mid-August as indicated by internode length. The plants on the south lysimeter on an average were taller as compared to plants on the north lysimeter from mid-June to the mid-July but these differences in plant height were reverse in the

month of August. In addition to lysimeters, data on crop characteristics at two representative sites of the field have been summarized in Tables 4.3 and 4.4 respectively.

Table 4.3 General crop characteristics on the eastern side of the representative cotton field.

Dates	Average No. of nodes	Average Plant height (cm)	Internode length (cm)	NAWF
06/15/2010	9	37	5.08	NA
06/24/2010	12	51	7.11	NA
06/29/2010	13	62	6.60	NA
07/13/2010	17	90	8.12	NA
07/28/2010	19	102	4.82	5
08/11/2010	21	112	5.33	3

Table 4.4 General crop characteristics on the western side of the representative cotton field.

Dates	Average No. of nodes	Average Plant height (cm)	Internode length (cm)	NAWF
06/15/2010	9	34	5.58	NA
06/24/2010	12	58	7.36	NA
06/29/2010	14	61	6.60	NA
07/13/2010	17	89	8.12	NA
07/28/2010	21	114	6.35	5
08/11/2010	22	107	4.57	4

Table 4.5 Cotton growth stages and their approximate timing on both lysimeters.

Observation date (DAP)	Growth stage, Lys 1	Growth stage, Lys 2
45	match head square	match head square
60	bloom	bloom
105	boll opening	boll opening
130	>60 % bolls opening	>60 % bolls opening

The crop characteristics on both sites were similar and comparable to both lysimeters (Tables 4.1, 4.2, 4.3 and 4.4). Specific growth stages including match head square, bloom, boll opening and >60% open bolls were also observed on lysimeters plants (Table 4.5).

4.2 Plant Growth on Lysimeters. At the early stage, cotton plants on both lysimeters were similar in growth and development to the surrounding crop rows. The cotton plants on both lysimeters showed faster growth in mid-June and these plants were more vigorous, taller and dark green as compared to the surrounding areas by late June. These were possibly caused by residual Nitrogen from previous years in both lysimeters. The atypical plant growth on the lysimeters may have contributed to ET_c measurements that appeared unusually high from June 19 through June 25th. To control the growth of the plants and maintain a smooth crop canopy over the lysimeter area, selective trimming of leaves and branches was conducted on June 25 and irrigation was withheld during this period. This resulted in a decrease in total leaf area of lysimeter plants as compared to surrounding crop rows and water stressed conditions for lysimeter plants. The effects of the reduced leaf area and increasing water stress may have contributed to unusually low values of ET_c after June 25. Therefore, lysimeter data were not utilized for K_c calculations from June 19 to July 1, but the data points during these days have been highlighted on ET_c and K_c figures to illustrate the environmental influences on ET_c and K_c estimation. A rainfall event on July 1 restored the soil moisture on both lysimeter. After this period, irrigation application was restored on the basis of crop and soil conditions initially and tensiometers readings at mid-season. Cotton plants on lysimeters also had an atypical horizontal growth behavior as compared to the surrounding crop rows from mid-July to mid-August. ET_c and K_c may have been slightly overestimated during this period due to atypical evaporative areas of the lysimeters used for ET_c calculations. Cotton plants on lysimeters were even and smooth and on average similar to that of surrounding crop rows and the field for rest of the season.

4.3. Crop Evapotranspiration (ET_c). Daily changes in lysimeter mass were recorded from May 12 to September 20 for ET_c estimation. The typical changes in lysimeter mass at the daily time

scale are shown in Figure 4.1. The sinusoidal shape of the curve indicates little or no mass change from midnight to 8 am as there is no sunlight available to cause ET_c . With the onset of daylight, there is a gradual decrease in mass of the lysimeters until the evening hours due to occurrence of ET_c . However, the change in mass again stays constant from evening to midnight. The line AB in Figure 4.1 represents typical mass changes for the lysimeter on daily basis which was equivalent to cotton water use.

The evaporative area on lysimeter plays a vital role in ET_c calculation. It represents the surface area on the lysimeter from which ET_c takes place. A daily change in mass of lysimeter is divided by this evaporative area to get equivalent water depths (mm) of ET_c .

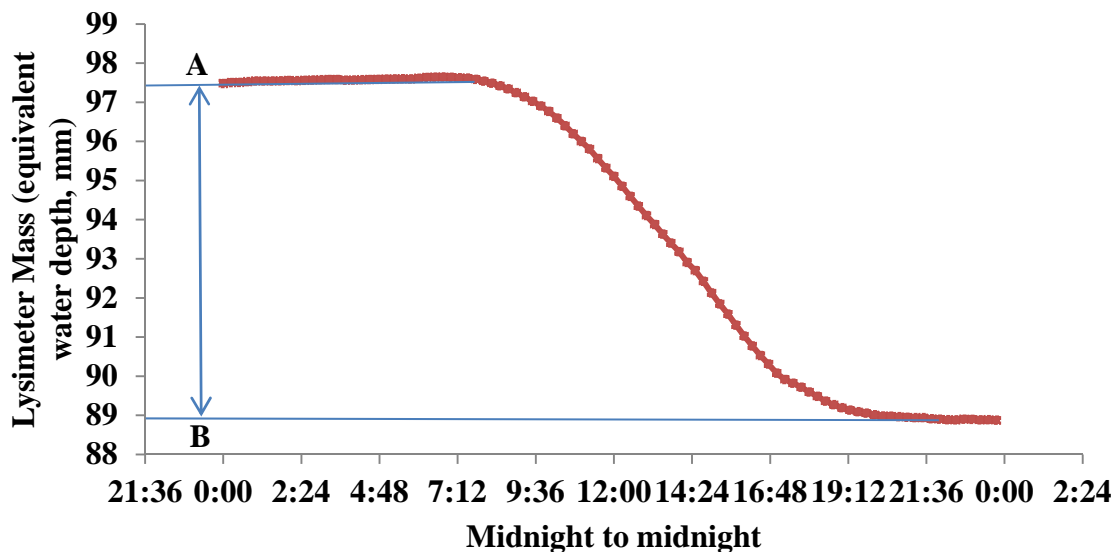

Figure 4.1 Typical mass changes in the lysimeter at daily time scale.

The changes in mass for the north and south lysimeters over the entire growing season are shown in Figures 4.2 and 4.3, respectively. There was a decline in total mass (equivalent water depth, mm) of both lysimeters from 45 to 65 days after planting (Figures 4.2 and 4.3) which was due to withholding of irrigation during this period to control the growth of cotton plants on the lysimeters. The pattern of changes in mass was approximately the same for both lysimeters over

the entire growing season. Rainfall and irrigation resulted in abrupt increases in mass of the lysimeters while pumping of excessive water from lysimeters resulted in abrupt decreases in mass (Figures 4.2 and 4.3).

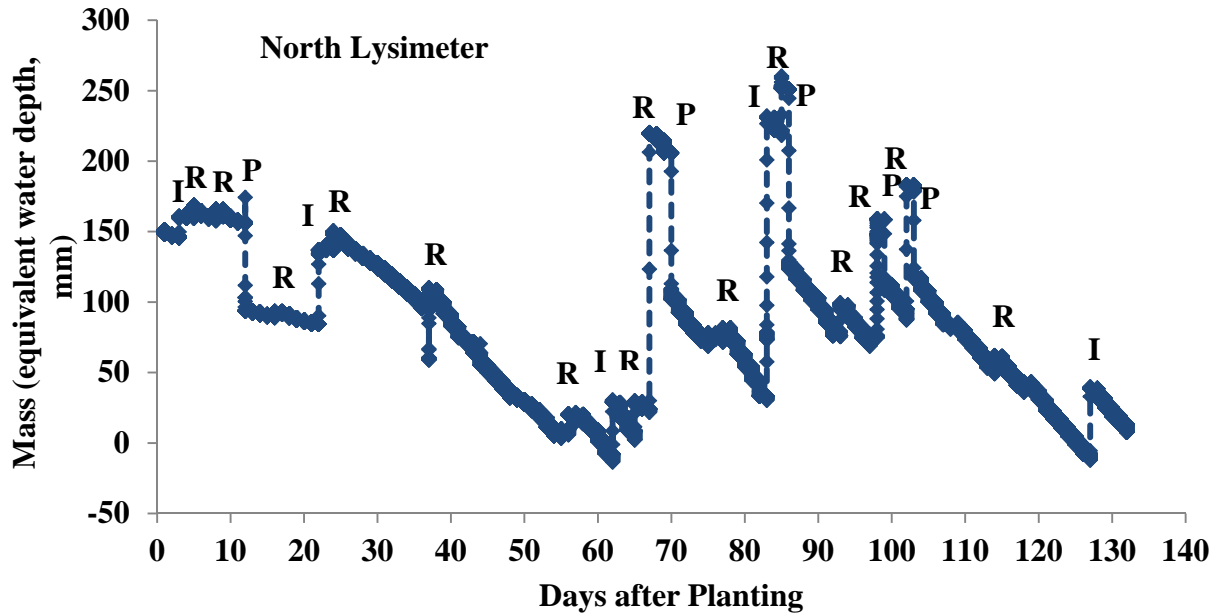

Figure 4.2 Mass changes in the north lysimeter resulting from rainfall (R), irrigation (I) and pumping (P) over the entire cotton growing season (0 mm represents the lowest mass over which lysimeter was calibrated) .

Both lysimeters remained within the calibration mass except for a few days during mid-July and mid-September when mass of lysimeters declined below minimum calibration mass. The data during these days were assumed valid because load cells of both lysimeters had shown linear trend with high R^2 value at the time of calibration, even with small masses (Clawson et al. 2009). Lysimeter mass was declined below scaled calibration mass due to usage of available water for ET_c in reconstructed soils in both lysimeters. After calibration, the soil profile at the time of refilling the top surface of lysimeters had good moisture content which was depleted with time leading to lysimeters mass below calibration mass during growing season. Maintenance of high values of ET_c during the period in which lysimeters mass were below the minimum

calibration mass suggest that soil water had not become limiting. Daily ET_c for both lysimeters is shown in Figure 4.4.

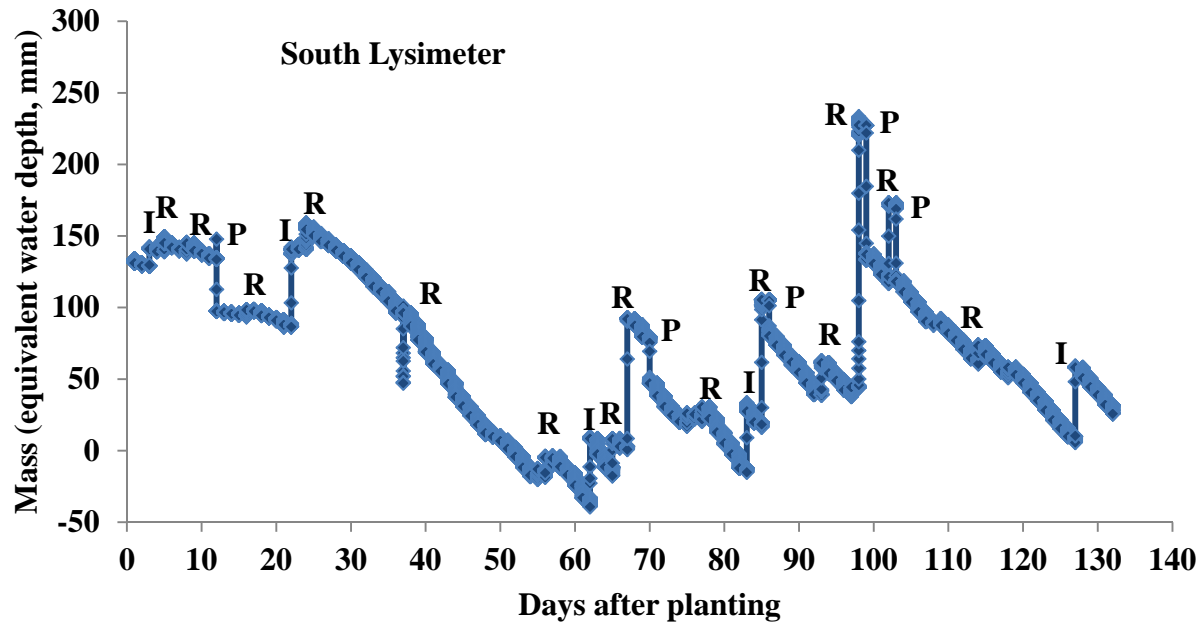

Figure 4.3 Mass changes in the south lysimeter resulting from rainfall (R), irrigation (I) and pumping (P) over the entire cotton growing season (0 mm represents the lowest mass over which lysimeter was calibrated).

Daily ET_c for both lysimeters was similar over the entire growing season. The maximum ET_c of 11.0 mm and 11.7 mm were observed for the north and south lysimeters, respectively, during the middle of July (65 days after planting). This was primarily attributed to better crop canopy and prevailing weather conditions during this period.

In comparison, ET_c was greater for the south lysimeter as compared to the north lysimeter during initial crop growth period but the trend changed from 65 to 105 days after planting for both lysimeters when greater ET_c was observed in the north lysimeter. The potential reasons for this pattern may include greater average plant height in the south lysimeter as compared to the north lysimeter at the initial growth period (Tables 4.1 and 4.2) and vice-versa for the north lysimeter as compared to the south lysimeter from 65 days after planting. However, both lysimeters were

generally within 0.5 to 1.3 mm ET_c difference of one another for whole growing season. A total cotton water use of 591 mm and 570 mm was observed over 92 usable days of ET_c data collection.

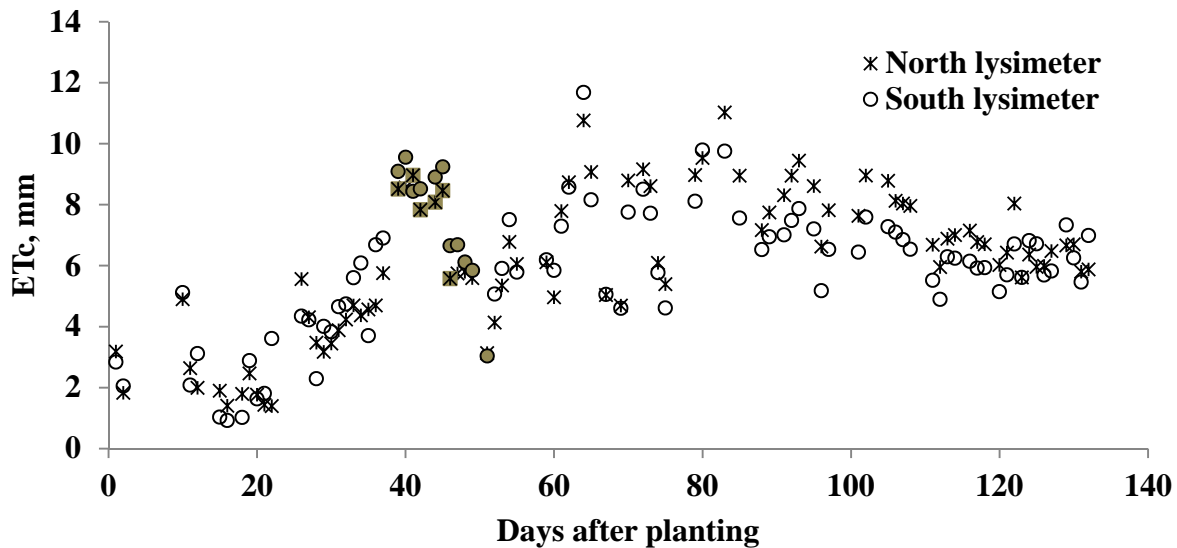

Figure 4.4 Daily ET_c from the north and south lysimeters over the entire growing season (Highlighting data points illustrate the effects of atypical vigorous plants growth and trimming on ET_c estimation).

Average daily ET_c was low at the early stage of crop growth due to low leaf area but began increasing with crop development and remained constant in mid-season due to the crop reaching maximum canopy cover, and declined toward the end of the season with the onset of leaf senescence. The cotton ET_c in the current research followed the pattern described in FAO-56 Irrigation and Drainage Paper (Allen et al. 1998). Average ET_c for both lysimeters over the entire growing season is shown in Figure 4.5. The average cotton ET_c ranged between 1.5 and 11.21 mm day⁻¹, reaching the peak at around 65 days after planting. The typical maximum cotton ET_c was measured ranging from 6 to 10 mm day⁻¹. Lower ET_c values of 4.5 to 6 mm day⁻¹ were also observed on a few days on both lysimeters after 60 days after planting. This decrease in ET_c was due to cloudiness along with calm winds on these specific days. Overall, The ET_c values do not vary widely from those (10 to 12 mm day⁻¹) reported by Howell et al. (2004) at Bushland and

(10 to 13 mm day⁻¹ in 2006, 7 to 10 mm day⁻¹ in 2007) reported by Ko et al. 2009 at Uvalde, TX. The maintenance of higher ET_c from 55 to 70 DAP indicates that soil water had not become limiting even though lysimeters mass had dropped below the calibration mass.

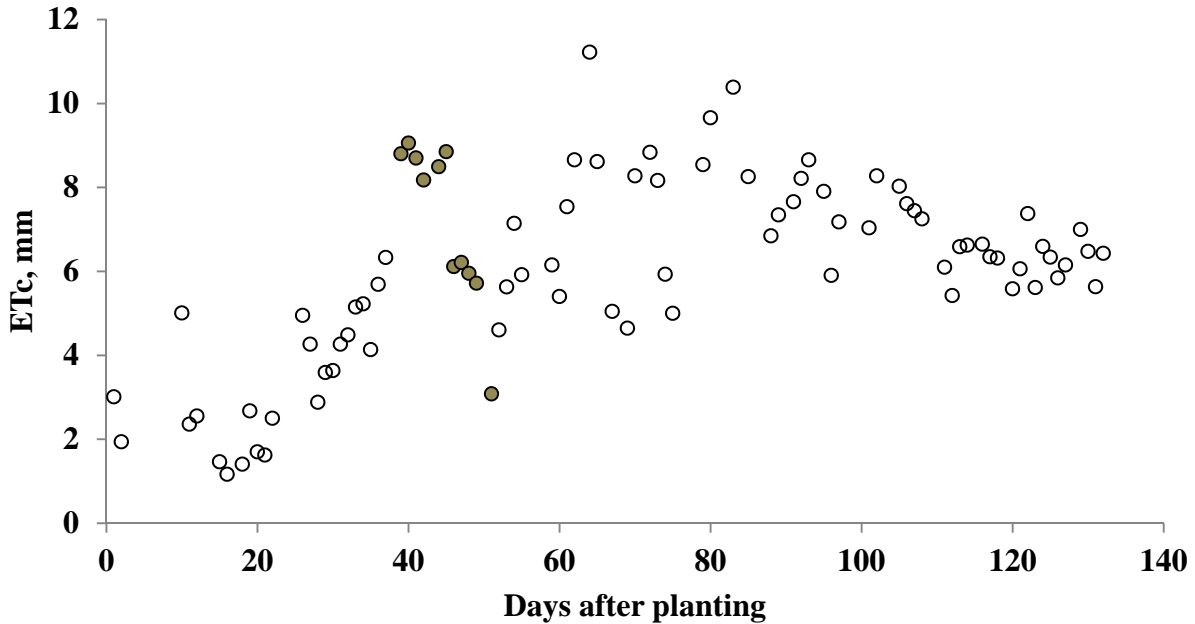

Figure 4.5 Measured average ET_c from both lysimeters over the entire growing season (Highlighting data points illustrate the effects of atypical vigorous plants growth and trimming on average ET_c estimation).

Tensiometer is a useful instrument which helps in monitoring soil water potential. Tensiometer does not quantify the available soil water but determine the tenacity with which water is held by soil particles. In general, a tensiometer gauge reading of 0 centibars indicates soil saturation. A tensiometer reading of 30-35 centibars indicates optimum moisture conditions for plant growth while a reading of 70 centibars or more is categorized as reduced availability of water in non-aggregated clay soils (Hensley and Deputy 1999). Soil water potential using tensiometers at different depths is shown for each lysimeter in Figures 4.6 and 4.7. The figures 4.6 and 4.7 indicate that there was no water scarcity across the entire soil profile during mid-season. In comparison, tensiometer readings indicated that the south lysimeter had a dry surface layer on a

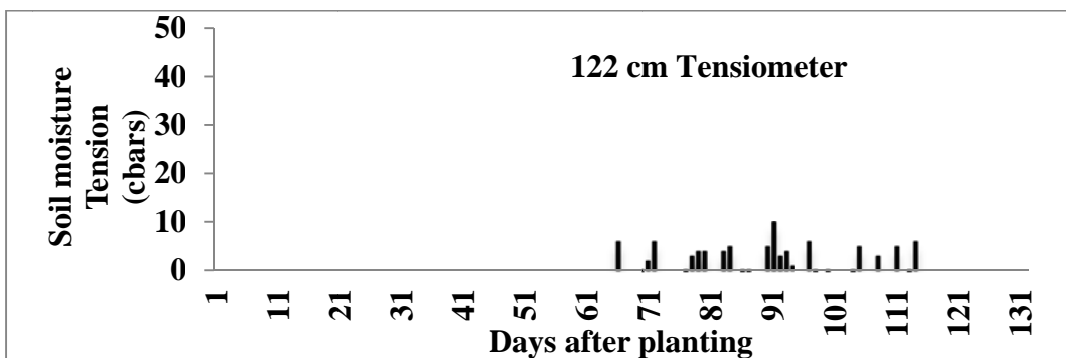
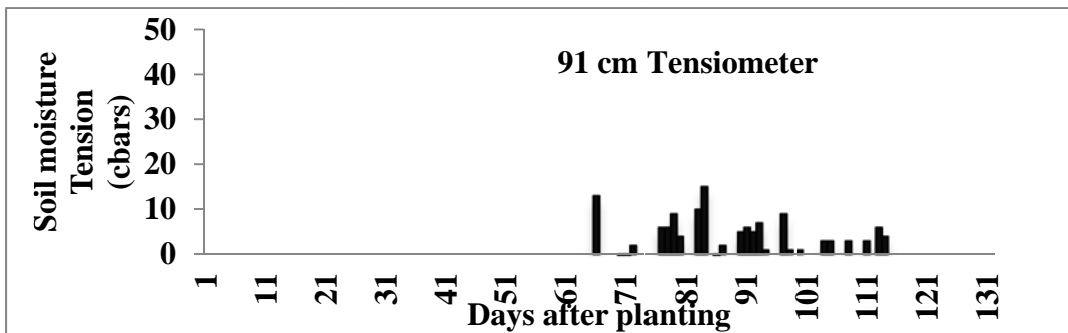
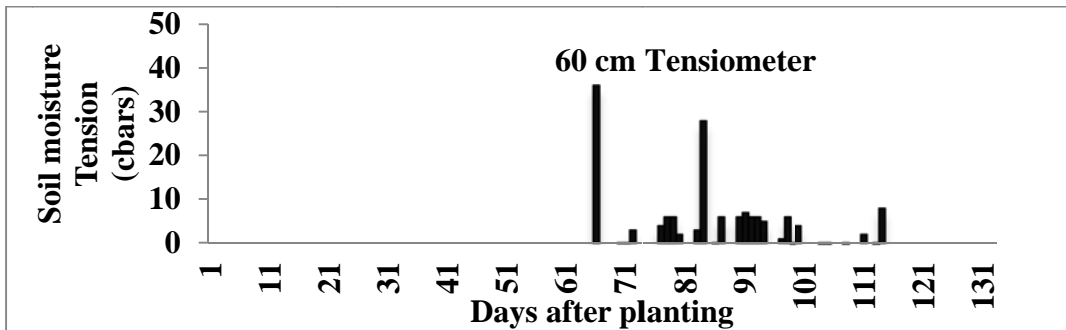
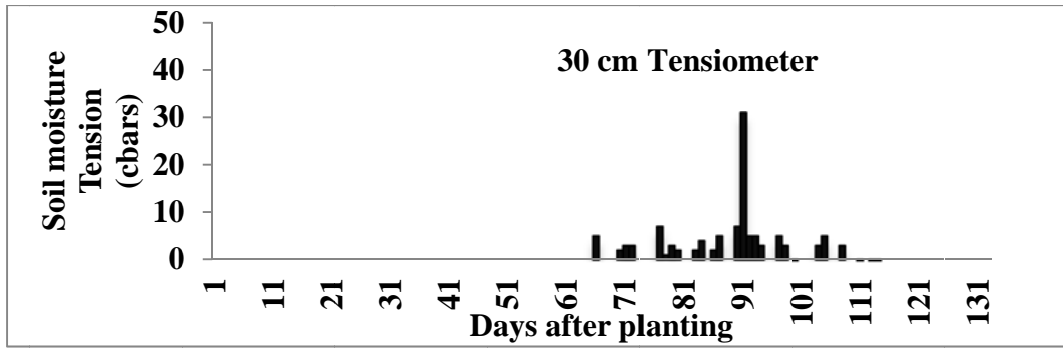

Figure 4.6 Soil water potential in the north lysimeter measured at four depths by tensiometers.

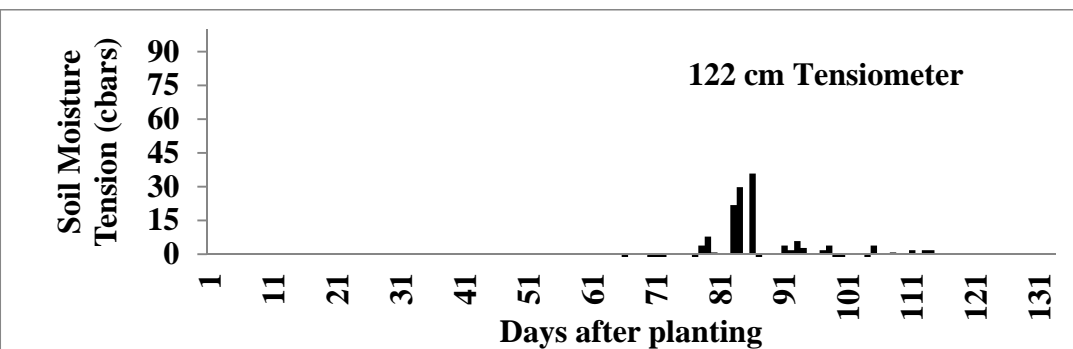
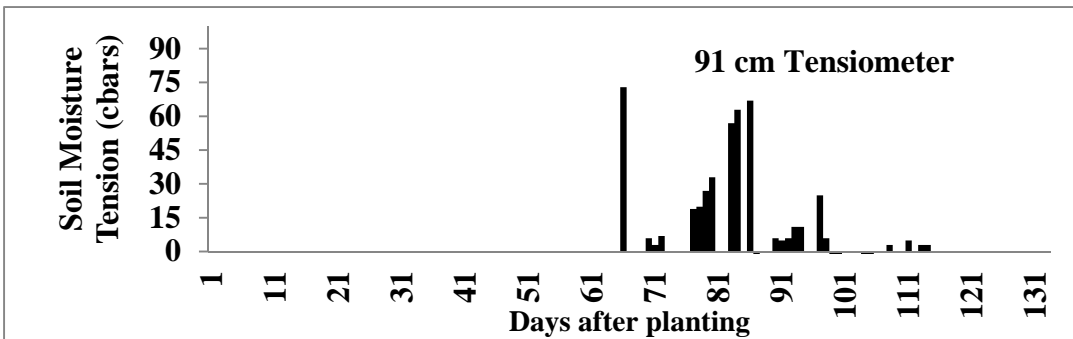
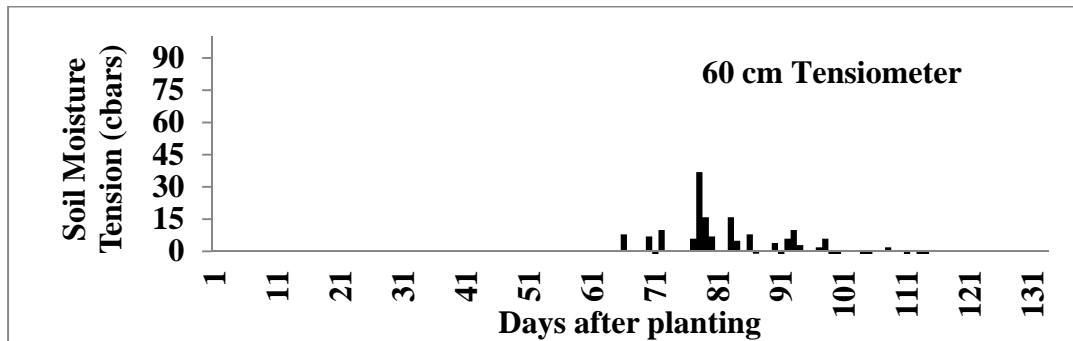
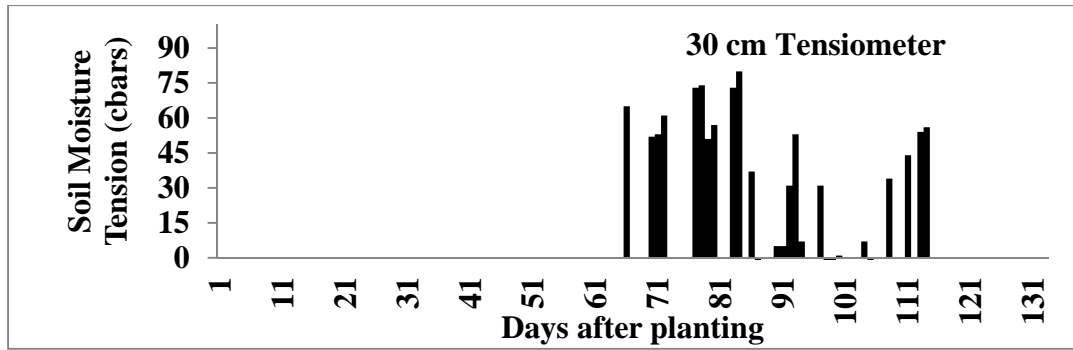

Figure 4.7 Soil water potential in the south lysimeter measured at four depths by tensiometers.

few days as compared to the north lysimeter during this period (Figures 4.6 and 4.7) but deep soil layers had ample moisture in both lysimeters as indicated from tensiometer readings at deeper soil layers. In the north lysimeter, readings for all tensiometers were less than 30 centibars during the data collection period while 30 and 91cm tensiometers readings in the south lysimeter were > 60 centibars on a few days. But for the majority of days, the tensiometer readings from 60, 90, and 122 cm depth were below 30 centibars, which indicated sufficient soil moisture at deeper layers in the south lysimeter.

4.4 Weather Measurements and Reference Evapotranspiration (ET_0). The variation in maximum and minimum air temperature over the reference grass surface is shown in Figure 4.8. The maximum air temperature varied from 25 to 37°C with a maximum value of 37°C on August 2 while minimum air temperature varied between 11 to 25 °C with a minimum value of 11°C on September 5. Both maximum and minimum air temperatures had similar trends with low values on some days due to rainfall or clouds. The distribution of rainfall during the data collection period is shown in Figure 4.9. Accumulated rainfall was approximately 346 mm during this period. There was little rainfall early in the season and the main period for rainfall was mid-July to the end of August. Maximum rainfall of 63 mm occurred on August 18. The pattern of minimum and maximum RH over the reference grass surface is shown in Figure 4.10. The changing trend of maximum RH was in close approximation with minimum RH through the growing season differing only in magnitude of change. The maximum RH varied between 85 and 95% with a maximum value of 95% on May 29 while minimum RH varied between 11 to 89% with a maximum value of 89% on August 8 which was due to high rainfall. The minimum RH fluctuated widely starting from July to the end of August, which was a period of frequent rainfall and possibly high temperature as well. Total solar radiation over the reference grass surface were

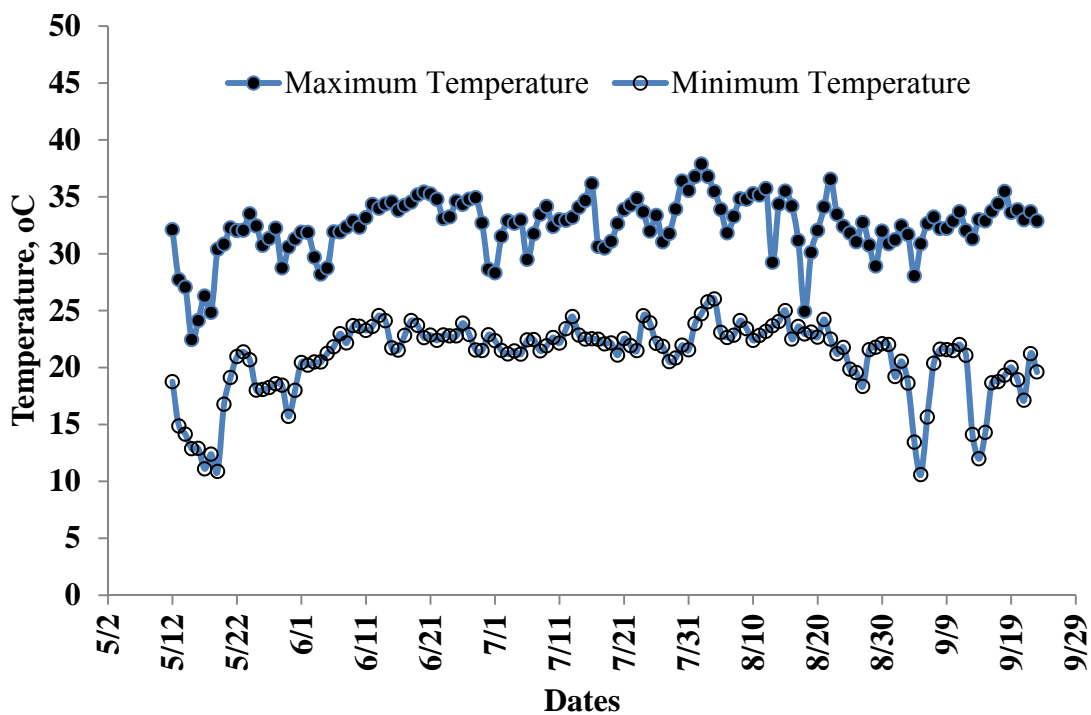

Figure 4.8 Maximum and minimum air temperature over the reference grass surface in 2010.

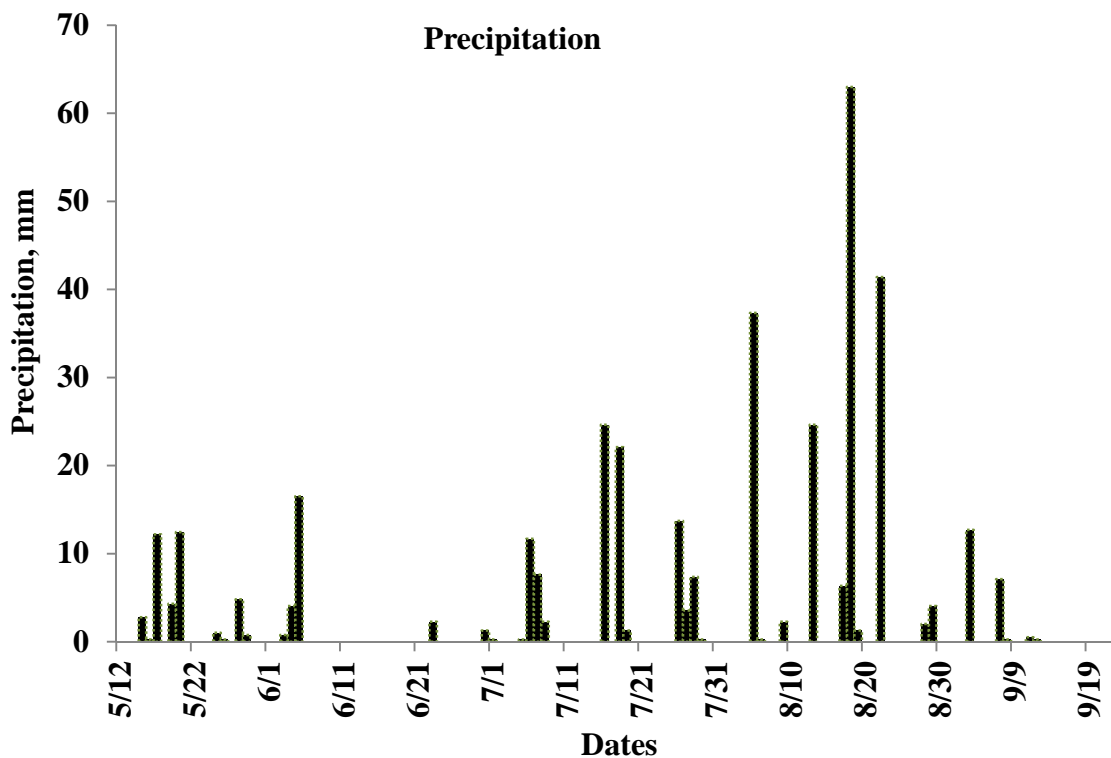

Figure 4.9 Rainfall distributions during the 2010 growing season.

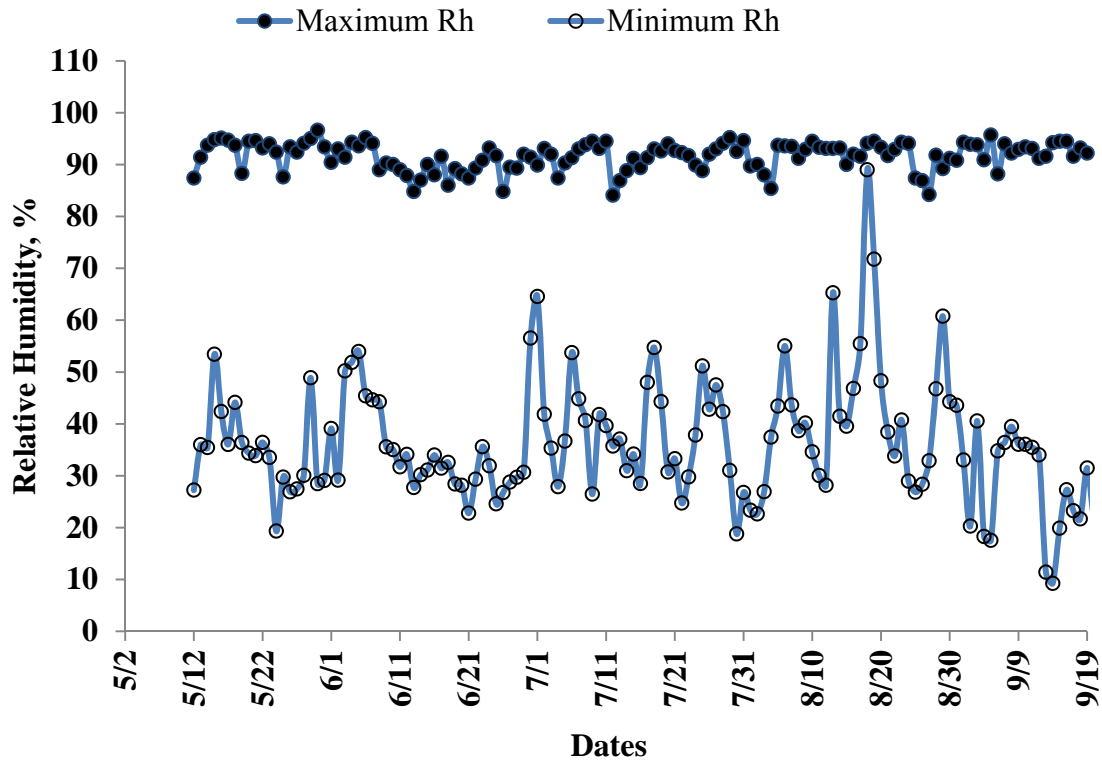

Figure 4.10 Minimum and maximum relative humidity (RH) measured over the reference grass surface during the 2010 growing season.

measured and plotted during the data collection period as shown in Figure 4.11. Total solar radiation varied greatly between 2.32 and 29.27 MJ m⁻² on a daily basis over the growing season. The large fluctuation in solar radiation was due to occurrence of cloudy or rainy days, which mainly occurred during July and August. The daily pattern of average horizontal wind speed at standard height of 2 m is shown in Figure 4.12. The daily average wind speed over the reference grass surface varied between 1 and 2.5 m s⁻¹ during the entire growing season except for a few days when it was above 2.5 m s⁻¹. The ASCE standardized reference ET equation manual recommends some quality control assurances for meteorological data acquired for ET_o estimation (Allen et al. 2005). The quality control assurances involve scrutiny of weather variables such as solar radiation, RH, temperature, and wind speeds. For solar radiations, measured solar radiation R_S and clear sky solar radiation R_{SO} are plotted against days of the year

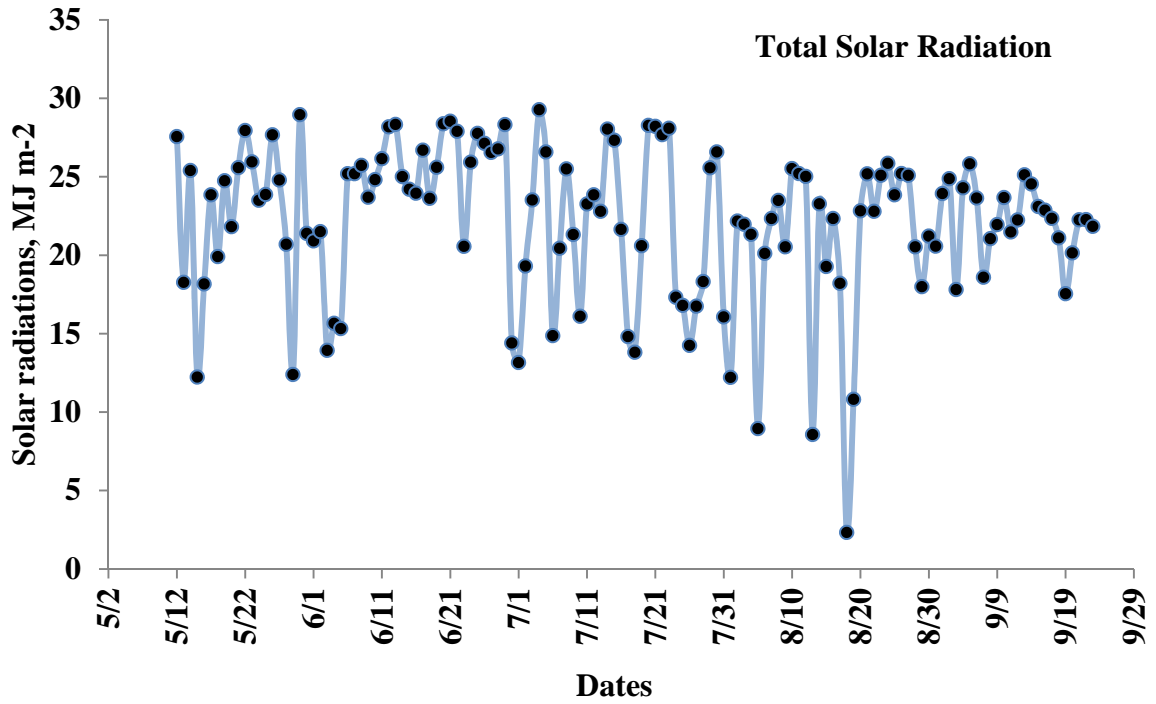

Figure 4.11 Total solar radiation measured over the reference grass surface in 2010.

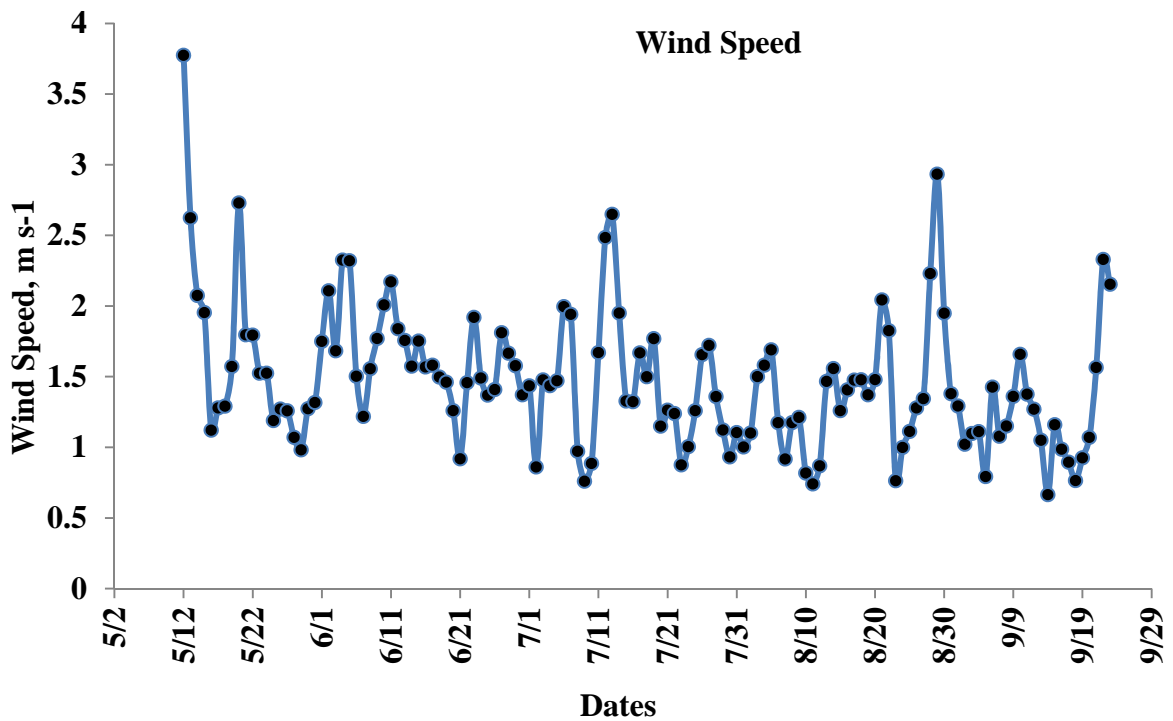

Figure 4.12 Daily averages of horizontal wind speeds at 2 m height over the reference grass surface in 2010.

and it is observed whether the upper values of measured R_S lie routinely above or below the computed R_{SO} curve by more than 3 to 5%. If it is so, there will be a problem with calibration and maintenance of the radiation sensor (Allen et al. 2005). The clear sky solar radiations R_{SO} were calculated using two different equations:

$$R_{SO} = (K_B + K_D) R_a \quad (\text{equation D.1})$$

where K_B is clearness index for direct beam radiation (unitless), K_D is transmissivity index for diffuse radiation (unitless), and R_a is extraterrestrial radiation ($\text{MJ m}^{-2} \text{ day}^{-1}$). The second equation for R_{SO} calculation is given below:

$$R_{SO} = (0.75 + 2 * 10^{-5} z) R_a \quad (\text{equation D.2})$$

where z is station elevation above sea level in meters. The R_{SO} calculated with these two equations along with measured solar radiations were plotted during the growing period as shown in Figure 4.13. The upper values of measured R_S were not continuously above or below the calculated R_{SO} values except a few days at the end of season. For temperature data assurance, minimum and average dew point temperatures are plotted against days of the year to check their patterns and it is assumed that daily average dew point temperature will approach minimum air temperature or remain below this temperature. The trend of average dew point temperature and minimum air temperature during the growing season is shown in Figure 4.14, which follows the pattern as described previously (Allen et al. 2005). For RH, there were no days when maximum RH exceeded 100% (Figure 4.10). To check the wind speed, wind speed ratio (wind speed from reference weather station to that of wind speed from nearby LAIS weather station) was plotted and shown in Figure 4.15, which approximately followed the constant values during the growing period except for a few days at the end of season (Allen et al. 2005).

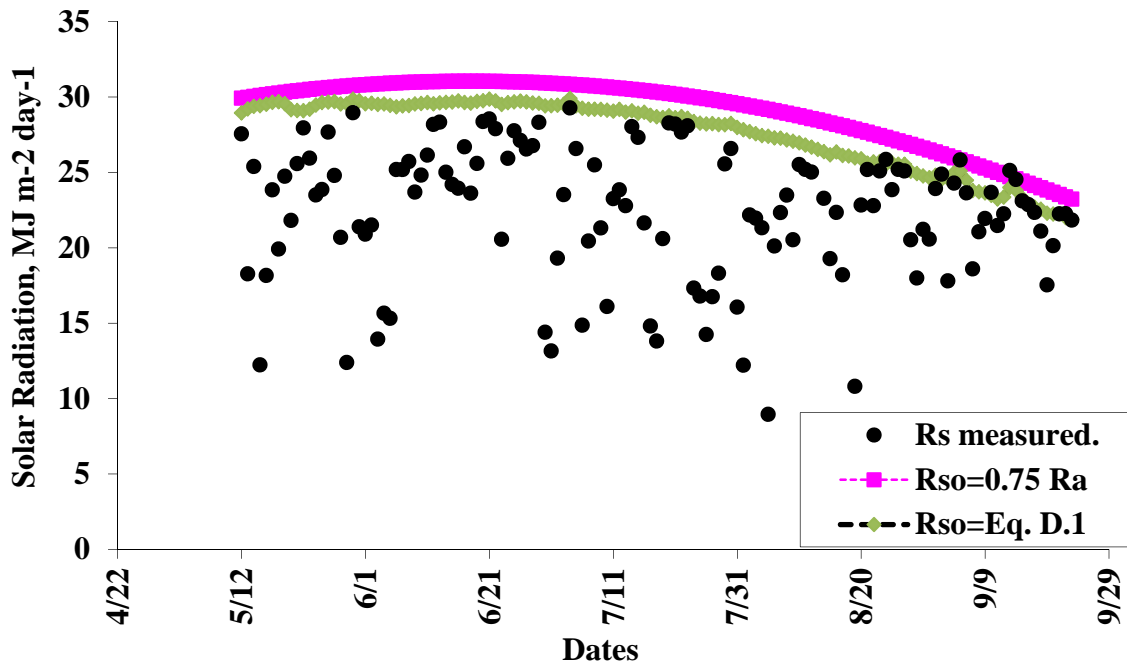

Figure 4.13 Measured solar radiation R_S along with computed clear sky solar radiation R_{SO} during 2010 growing season.

4.4.1 Reference Evapotranspiration ET_o . Daily measurements of maximum and minimum air temperature, maximum and minimum relative humidity, total solar radiation, and wind speeds were used in the SREE of ASCE to estimate daily rates of ET_o (Allen et al. 2005). The daily ET_o estimates are shown in Figure 4.16. The ET_o varied between 3.23 and 7.36 mm day⁻¹ during the crop growing season, which was close to those (2 to 9 mm day⁻¹) reported by Ko et al. (2009) at Uvalde, TX. Accumulated ET_o over the reference grass surface was around 523 mm through September 20 excluding the days of rainfall and irrigation. Reference evapotranspiration (ET_o) was higher at the beginning of the season but started declining after July. This can be attributed to high solar radiation and low precipitation early in season and reverse late in season (Figures 4.9 and 4.11). Reference evapotranspiration (ET_o) was also plotted against measured weather parameters to define the type of relationship. All these comparisons are summarized in Figure 4.17 which clearly shows the positive relationship of ET_o with maximum and minimum air

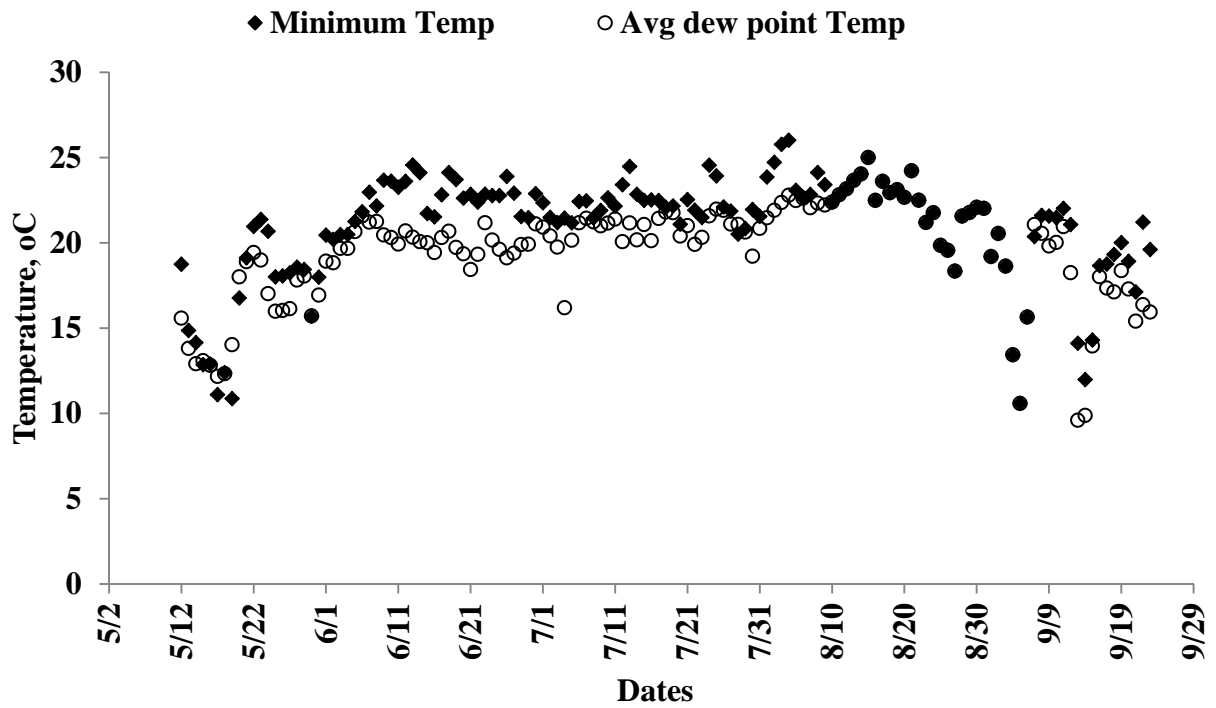

Figure 4.14 Average dew point temperature and minimum air temperature in 2010.

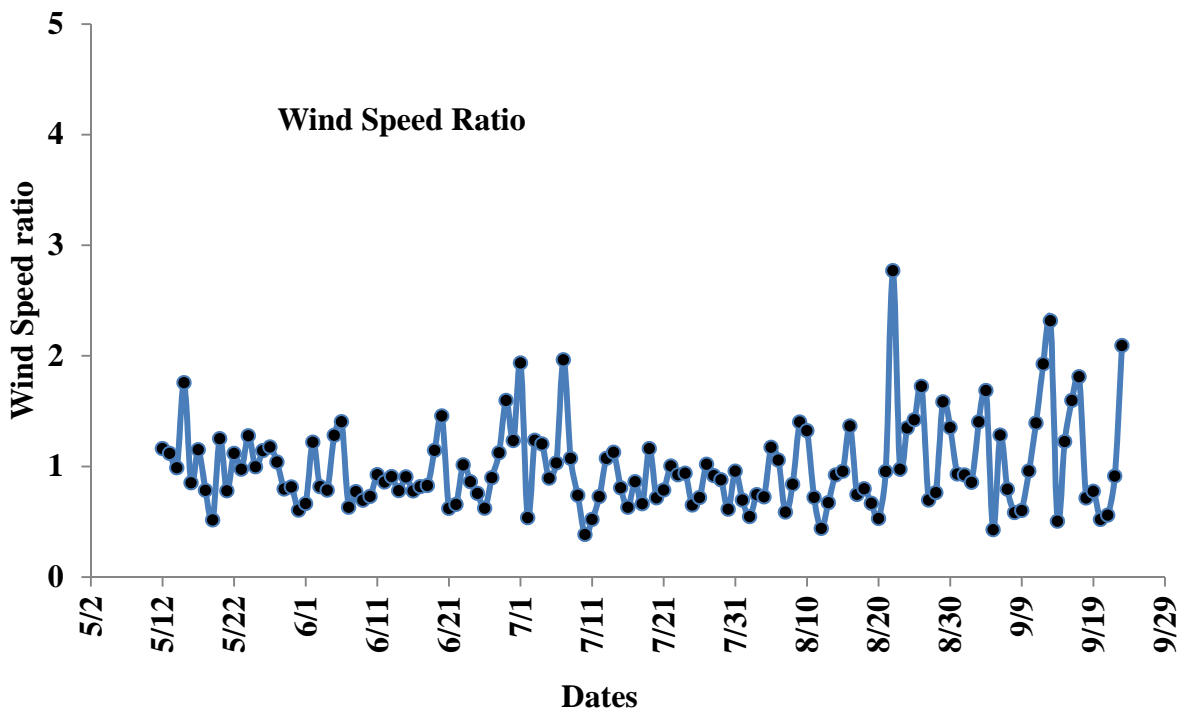

Figure 4.15 Ratio of daily mean wind speeds from reference weather station to that of nearby LAIS weather station in 2010.

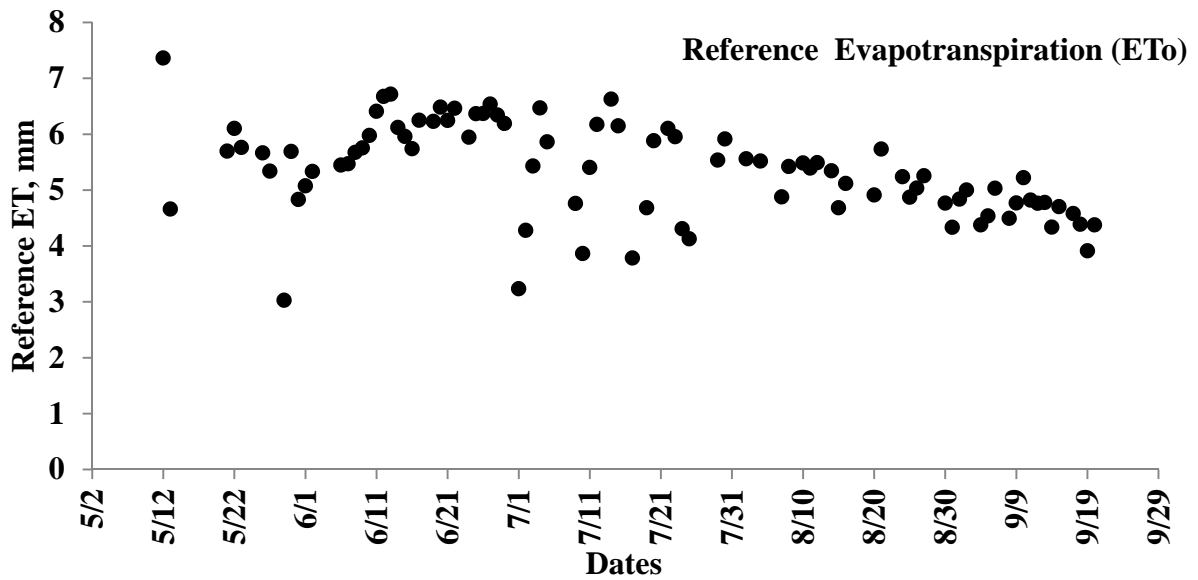

Figure 4.16 ET_o over the standard grass surface during 2010 growing season.

temperature, total solar radiation, and wind speed but negative relation with minimum RH while no clear relationship of ET_o with maximum RH is found.

Monthly climatic data of daily mean values has been summarized in Table 4.5, which includes maximum, minimum, and average dew point temperature, maximum and minimum relative humidity, solar radiation, ET_o estimates, and wind speed at 2 m height along with accumulated rainfall.

Table 4.6 Summary of monthly climatic data daily mean values in 2010.

Month	T _{max} (°C)	T _{min} (°C)	T _{dew} (°C)	RH _{max} (%)	RH _{min} (%)	Radiations (MJm ² day ⁻¹)	2m- wind (m s ⁻¹)	ET _o (mmday ⁻¹)	Rain (mm)
May	28.5	14.5	12.7	90.3	29.6	24.2	1.8	5.2	49
June	33.0	22.5	20.0	90.0	35.1	22.2	1.6	5.7	25
July	32.8	22.1	20.7	91.6	38.1	21.6	1.4	5.0	95
August	33.1	22.8	22.3	91.4	42.1	20.3	1.3	4.6	182
September	31.7	17.1	15.5	92.7	25.2	21.8	1.2	4.5	27

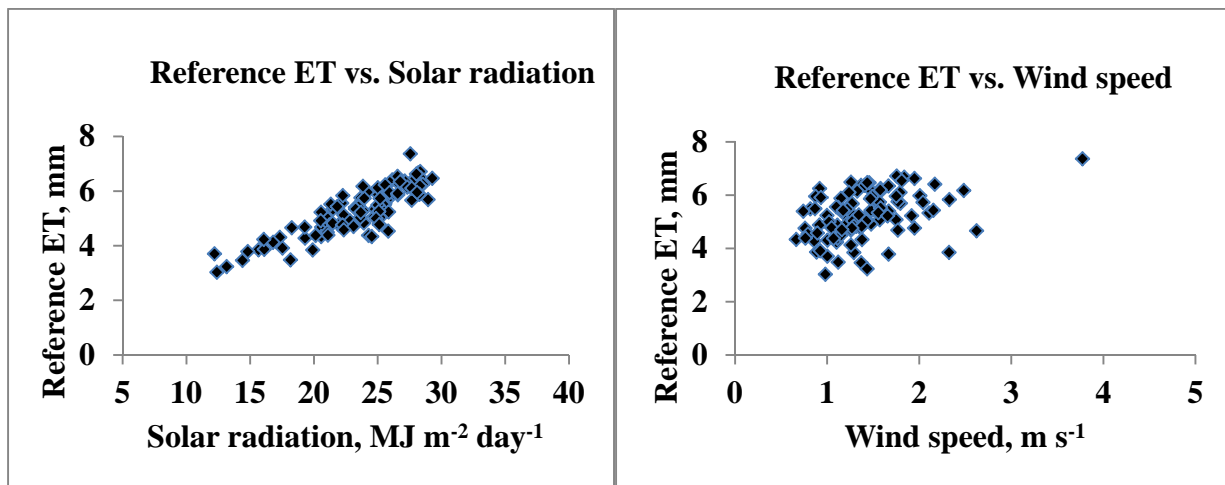
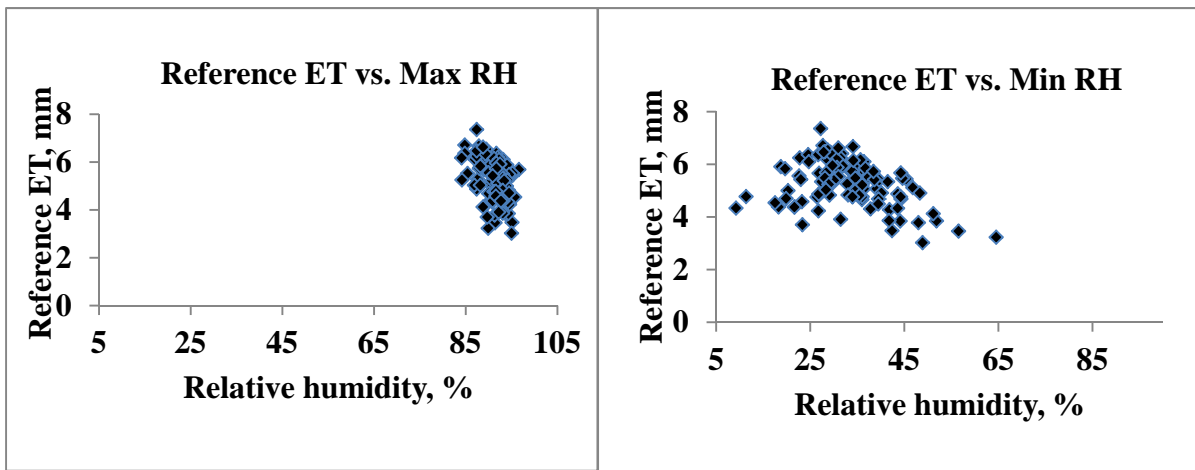
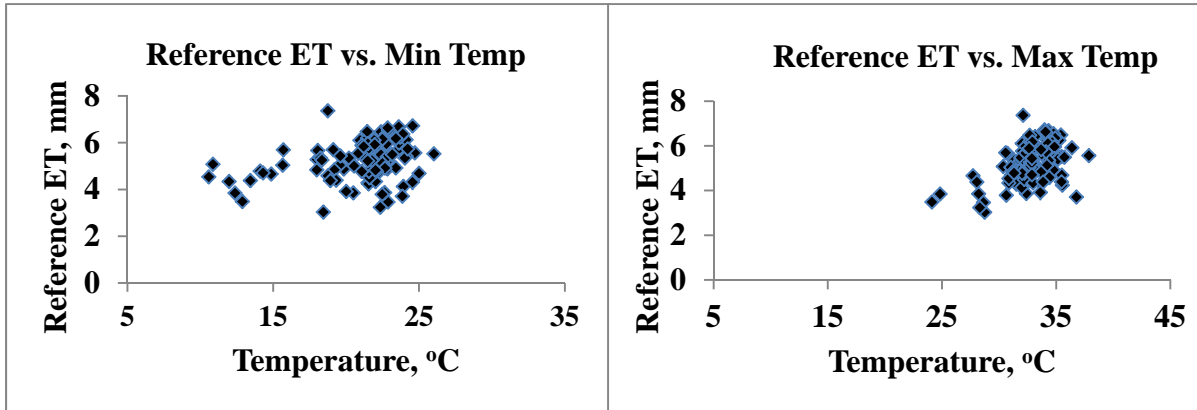

Figure 4.17 Relationship of ET_0 with weather variables in 2010 (After Hribal 2009).

4.5 Crop Coefficients (K_c). Crop coefficients (K_c) values were calculated as ratios of daily estimates of ET_c to that of daily ET_o estimates. A Straight line K_c curve was drawn by following guidelines as described in FAO-56 Irrigation and Drainage paper for different growth stages of cotton (Allen et al. 1998). This K_c curve represents an average ET_c from both lysimeters and ET_o from the reference weather station. The growth stages including initial, developmental, and mid-season were identified by visual observations of crop data on growth and development during the season. The initial growth stage spanned over 25 days after planting with 10% canopy cover while mid-season growth stage was assumed to be initiated at day of first bloom and when canopy cover reached to approximately 70%. The crop development period ranged from 35 to 40 days. The K_c data was determined only until defoliant application was applied. In general, K_c values for cotton followed the same pattern as described in FAO-56 Irrigation and Drainage paper (Allen et al. 1998). At the initial stage of crop growth, K_c values were low but increased with crop development and remained almost constant at full canopy cover (Figure 4.18). The highlighted data points in Figure 4.18 illustrate the effects of the vigorous plants growth and trimming on the K_c and these were not used in average K_c determination. The average K_c values for these growth stages along with duration of these growth stages are summarized in Table 4.6 for reference to end users of K_c values. The K_c values at initial and mid-season growth stages were higher than those from FAO-56 (Allen et al. 1998) and those reported at Uvalde, TX (Ko et al. 2009). In addition, the current research K_c values at initial and mid-season stages were higher when compared to those determined at Texas High Plains (Howell et al. 2004; 2006). At the Texas High Plains, approximate K_c values of 0.2, 1.2, and 0.8 were reported at emergence, first bloom, and first open boll growth stages, respectively (Howell et al. 2004; 2006). The higher K_c values in the current research at initial and mid-season growth stage may be attributed to

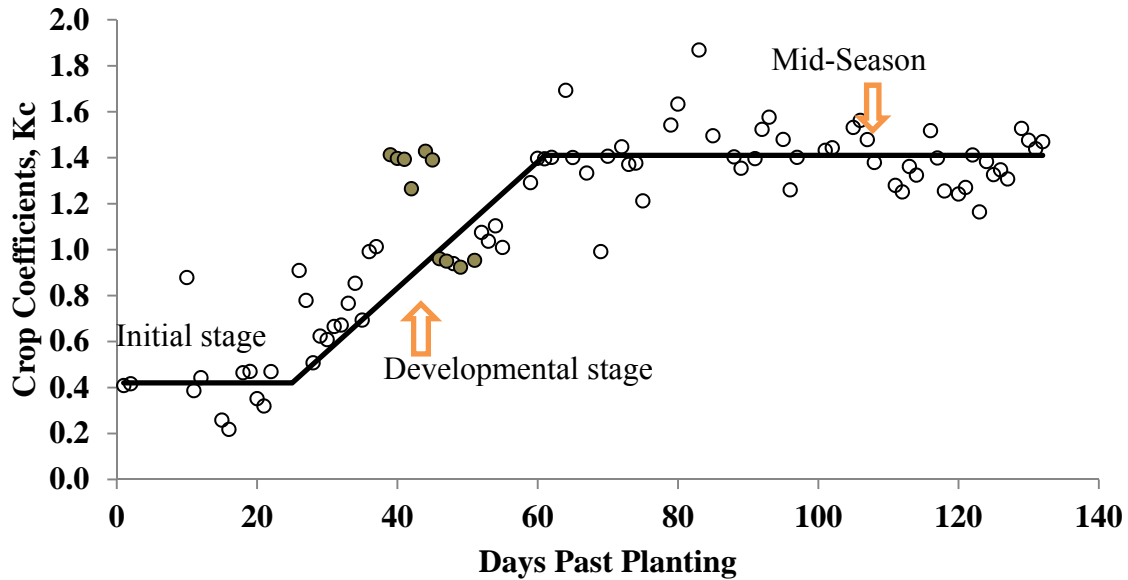

Figure 4.18 Straight line crop coefficients (K_c) curve for cotton during the 2010 growing season. (Highlighting data points illustrate the effects of atypical vigorous plants growth and trimming on K_c determination).

Table 4.7 Average K_c values for different growth stages and their duration.

Growth Stage	Duration of Stage (no. of days)	Average K_c values
Initial	25	0.42
Developmental	35	0.89
Mid-Season	72	1.41

variation in weather conditions, varietal difference, and crop management practices. As noted previously, the 2010 growing season was considered hot and dry early and late season with moderate to severe drought (NWS-NOAA 2010). This could be the main factor resulting in higher daily ET_c during these stages.

Apart from the straight line curve, K_c values over the entire growing season were also partitioned according to specific growth stages match head square, bloom, boll opening and >60% boll opening for use by cotton producers of this region. The K_c pattern over the growing season and

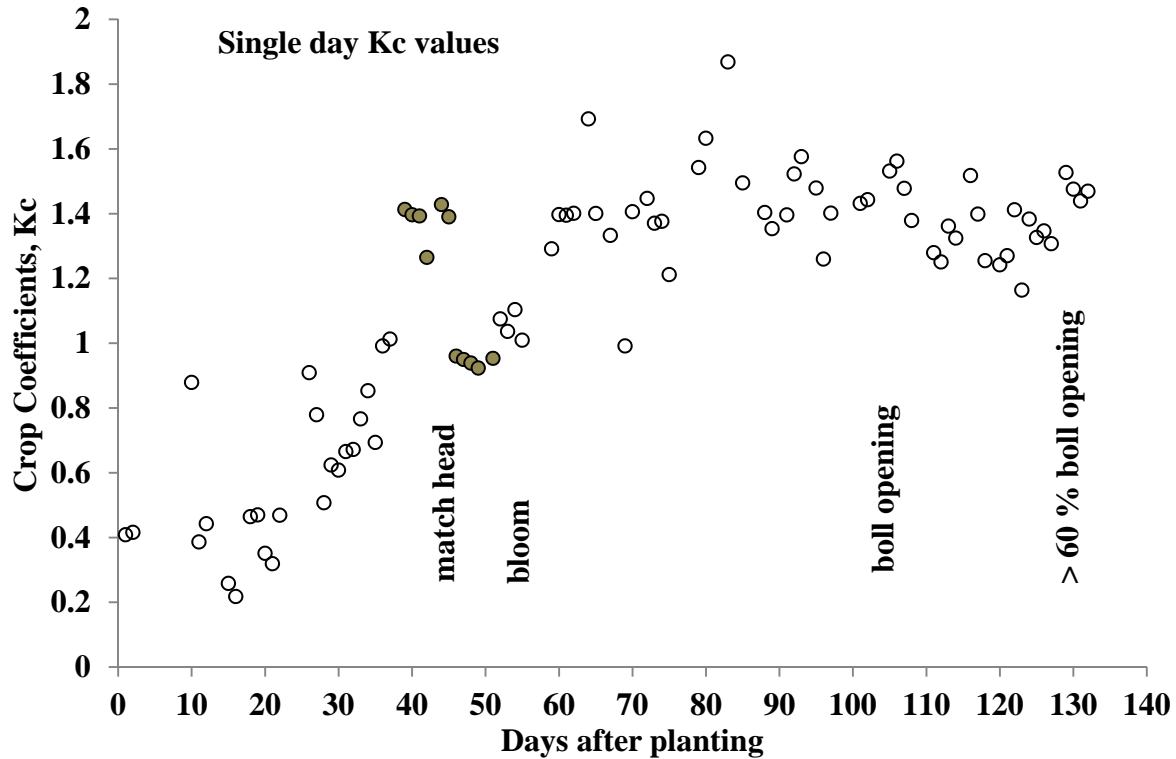

Figure 4.19 Single day K_c values marked with specific cotton growth stages in 2010. Growth stages represent observations made on the DAP with which they are aligned. (Highlighting data points illustrate the effects of atypical vigorous plants growth and trimming on K_c determination).

K_c values for these specific growth stages are shown in Figure 4.19 and Table 4.7. The K_c generally varied from 0.2 to 1.8 during the growing season with typical higher K_c of 1.4 during mid-season. As indicated in Figure 4.19 and Table 4.7, single day K_c values were lower at match head square, increased at bloom growth stage, but reached maximum during boll opening stage and then declined afterward. Besides time scale, temperature scale based on growing degree days (GDD) is used to express K_c curve (Hunsaker 1999) because it aids in transferability of K_c curve among seasons and sites (Howell et al. 2004). Therefore, K_c values were also expressed as a function of cumulative growing degree days (CGDD).

To express the K_c values against time and thermal scales over the growing season, polynomial regressions of second orders were used. Two K_c curves as function of days after planting (DAP)

and CGDD along with 95% lower and upper confidence limits are shown in Figures 4.20 and 4.21, respectively.

Table 4.8 Approximate timing of cotton growth stages, K_c values (derived from Fig. 4.20) and cumulative growing degree days at LSU AgCenter Northeast Research Station 2010.

Cotton growth stages	Observation date (DAP)	Crop coefficients (K_c)	Cumulative growing degree days ($^{\circ}$C)
match head	45	1.09*	984
bloom	55	1.23	1226
boll opening	105	1.53	2492
>60 % boll opening	130	1.33	3006

*Represents an estimate K_c value as data near this growth stage were missing. Growth stage observation intervals were insufficient to identify dates of transition between successive stages.

Daily K_c estimates over the growing season fit well with DAP and CGDD using second order polynomials, which resulted in R^2 values of greater than 75% along with PRESS (predicted residual sum of squares) very close to sum of squared residuals showing high prediction ability of regression models used. The regression coefficients and different statistics for K_c polynomial models are given in Table 4.8. For the DAP curve, the minimum and maximum values for K_c were 0.39 and 1.53, respectively, and this maximum K_c value occurred at around 105 DAP. Minimum and maximum K_c values were similar for the CGDD curve as that of the DAP curve and maximum K_c value occurred at 2492 $^{\circ}$ C-day for CGDD curve. As previously mentioned, canopy cover (%) was measured over both lysimeters and two other representative sites of the field at approximately 14 day intervals. Average canopy cover was calculated for both lysimeters during each measurement. Crop coefficients (K_c) values were regressed against average canopy cover using second order polynomial regression, which is shown in Figure 4.22.

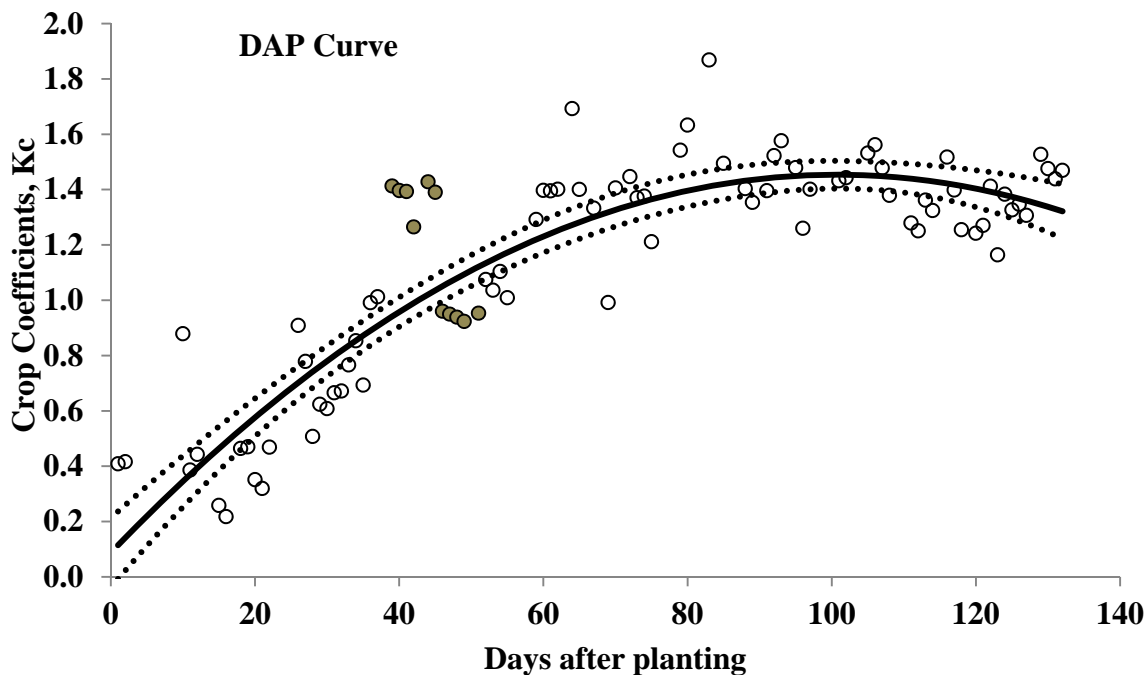

Figure 4.20 Crop coefficients (K_c) for cotton determined as a function of days after planting. (Highlighting data points illustrate the effects of atypical vigorous plants growth and trimming on K_c determination).

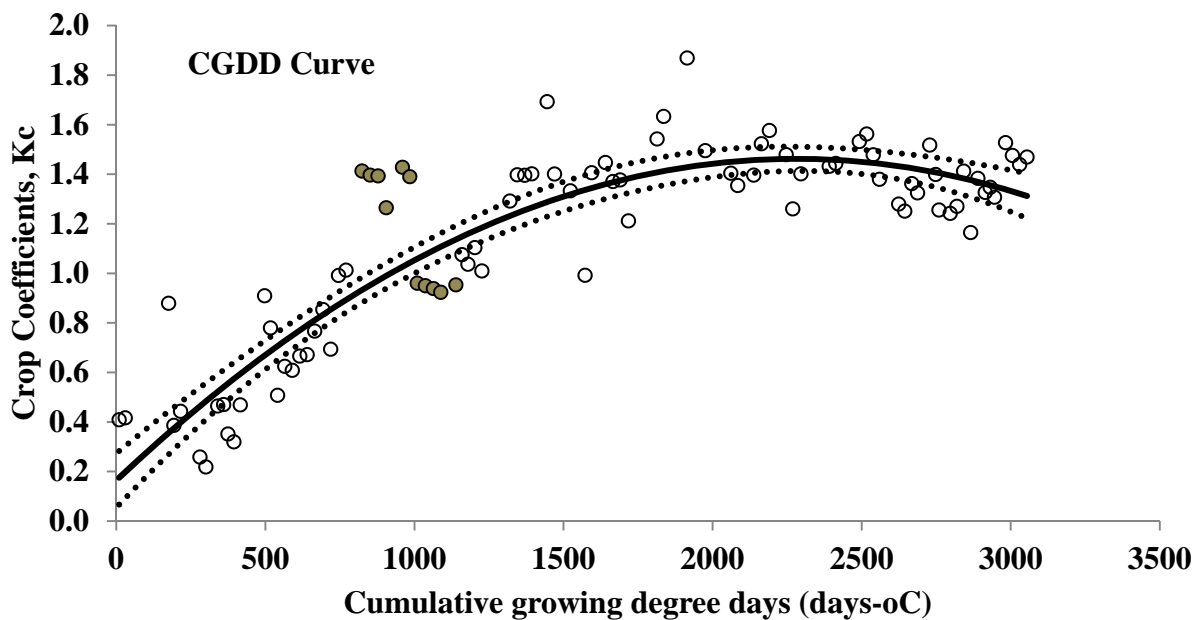

Figure 4.21 Crop coefficients (K_c) for cotton determined as a function of cumulative growing degree days. (Highlighting data points illustrate the effects of atypical vigorous plants growth and trimming on K_c determination).

Table 4.9 Regression coefficients for K_c as a function of days after planting (DAP) and cumulative growing degree days (CGDD).

Regression Coefficients*						
Index	Intercept	a_1	a_2	R^2	SE	n
CGDD	0.16373	0.00114	$-2.49686E^{-7}$	0.8491	0.018295	78
DAP	0.08726	0.02715	-0.00013482	0.8354	0.019111	78

*Regression coefficients for the polynomial $K_c = a_1X + a_2X^2$, where X is days after planting (DPP) or cumulative growing degree days (CGDD). R^2 is the coefficient of determination, SE (K_c) is standard error of K_c estimates and n is number of data points.

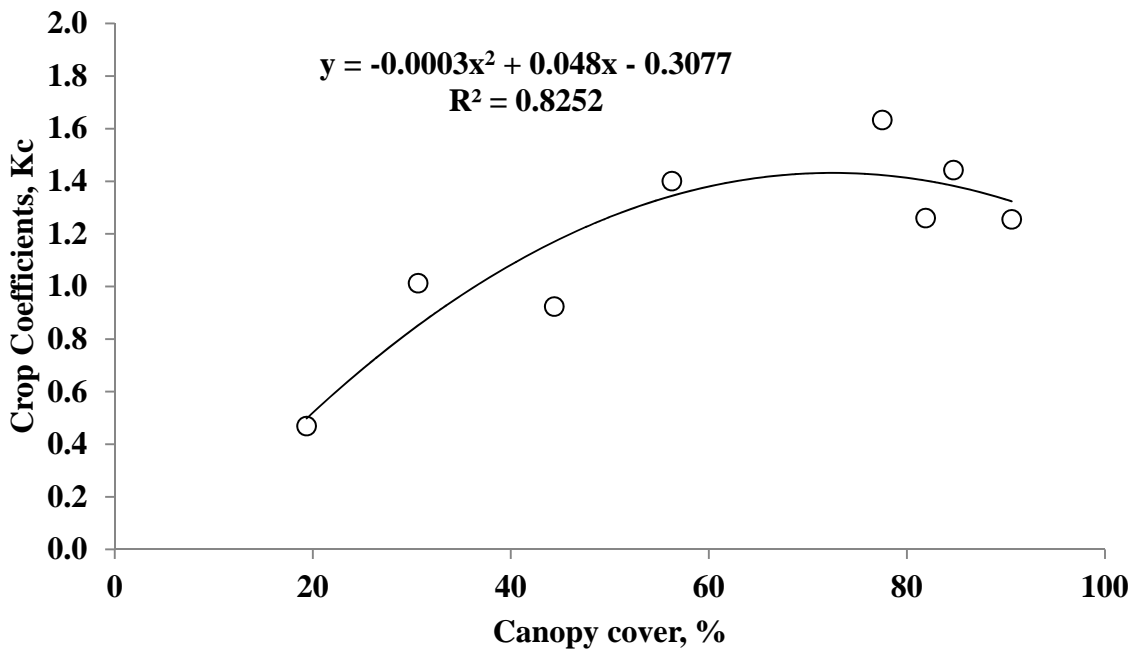

Figure 4.22 Average crop coefficients in relation to average canopy cover of both lysimeters in 2010.

As observed from Figure 4.22, the trend for K_c values first increased with increase in canopy cover at initial growth stages, leveled off when canopy cover reached 60 % and then declined after 80% canopy cover. The R^2 value of 82.52 % indicates that most of the variation in K_c was explained by % canopy cover. Therefore, the K_c values could also be predicted by using polynomial equation during the growing season, $y = -0.0003x^2 + 0.048x - 0.3077$ where x is

canopy cover measurements (%). This regression equation was based on few data points and this relationship will become better defined with additional years of data.

CHAPTER 5

CONCLUSIONS

5.1 Summary. This study was conducted to determine stage specific cotton water use crop coefficients (K_c) at the LSU AgCenter Northeast Research Station near St. Joseph, LA in Tensas parish during 2010. To estimate crop evapotranspiration (ET_c), paired weighing lysimeters reinstalled in 2008 at the study site were used. Cotton was manually planted on the lysimeters, centered on approximately 1 ha area while a John Deere vacuum planter was used for planting the remainder of the field. The lysimeters were calibrated and manually irrigated while furrow irrigation was utilized for the remainder of the field. To monitor soil water status, tensiometers were installed on the lysimeters and two representative sites of the field. Irrigation was scheduled on the basis of visual observation of the crop and soil conditions and tensiometers readings. Daily measurements of changes in mass of lysimeters were recorded during the entire cotton growing season. For daily estimates of reference evapotranspiration (ET_o), a weather tower on a Bermuda grass (*Cynodon dactylon* L.) with standard height and fetch was constructed and instrumented with different weather sensors. Reference grass was irrigated as needed to avoid any water stress during the growing period. Daily measurements of temperature, relative humidity, wind speed, and solar radiation recorded by the weather station were used in the Standardized Reference Evapotranspiration Equation (SREE) of the American Society of Civil Engineering to compute daily estimates of ET_o .

Crop coefficients (K_c) were determined by taking ratios of ET_c to ET_o on a daily basis. Single day K_c values were fitted with straight line curve partitioning into different growth stages for the entire season. In addition, two polynomial regression models were used to fit K_c values against days after planting and cumulative growing degree days. Crop growth stages including match

head square, bloom, boll opening and >60% boll opening along with other growth variables, were measured throughout the cotton growing season.

5.2 Findings. Accumulated cotton water use of 591 and 570 mm for the north and south lysimeter was observed from mid-May to September 20 excluding days with rainfall and irrigation events. Average ET_c from both lysimeters varied from 1 to 5 mm during mid-May to mid-June. ET_c values increased to 8 to 10 mm in the months of July and August. Cotton ET_c then declined to 6 mm in September due to onset of leaves senescence. Accumulated ET_o of 523 mm was observed over the reference grass surface from mid-May to September 20. High daily ET_o rates of 5 to 7 mm were observed until mid-July, after which it declined to 4 to 5 mm during the months of August and September.

A single day average K_c value of 0.42 for both lysimeters was observed at the initial stage (25 DAP) of crop growth. An average K_c values for the developmental stage (26 to 60 DAP) and mid-season stage (61 to 132 DAP) were 0.89 and 1.41, respectively, using a straight line curve, (Table 4.6). In addition, K_c values for match head square (45 DAP), bloom (55 DAP), boll opening (105 DAP) and > 60% boll opening (130 DAP) were 1.09, 1.23, 1.53 and 1.33, respectively (Table 4.6). Second order polynomial regressions fit well for K_c values against DAP and CGDD. A positive relationship of average K_c values to the crop canopy cover was also observed. Single growing season data are presented in this manuscript and additional years of study are needed.

5.3 K_c Application for Irrigation Scheduling. These determined K_c values are intended for use in irrigated cotton under similar soil, climatic, and crop management conditions. The K_c values for different growth stages of cotton will be helpful in estimating cotton water use and irrigation

scheduling in northeast Louisiana and nearby areas of Arkansas and Mississippi provided that these areas have similar climatic and soil types. The end goal of the whole project is to develop an on-line tool in which producers would enter the basic information like location, planting date, growth stage and date range over which they would like cotton ET estimation. However, the cotton producers can simply follow the steps given below for estimating the previous day's cotton water use (ET_c).

1. **Identification of crop growth stage.** Crop growth stages including initial, crop development, and mid-season can be identified based on days after planting as 0 to 25 DAP (Initial stage), 26 to 60 DAP (developmental stage), and 61+ days after planting (mid-season). The duration of these stages may vary with variety, weather conditions and management practices. Phenological stage match head square is categorized under crop developmental stage while bloom, boll opening and >60% bolls opening are categorized under mid-season growth stage.
2. **Select K_c value.** At a particular growth stage, select an average K_c value from Table 4.7 or predict a K_c value by using equation $K_c = a_1X + a_2X^2$ where X is days after planting, and a_1 and a_2 are polynomial regression coefficients presented in Table 4.9.
3. **Determine ET_o .** Access the following link for getting information on previous day's reference ET or contact the LSU AgCenter Northeast Research Station, St. Joseph, LA:
<http://weather.lsuagcenter.com/referenceET.aspx>
4. **Estimate ET_c .** Use the following equation to estimate the previous day's ET_c (Cotton water use):

$$ET_c \text{ (mm day}^{-1}\text{)} = K_c * ET_o \text{ (mm day}^{-1}\text{)}$$

Using this two-step $K_c * ET_o$ approach, cotton producers can quantify the amount of cotton water use on a daily basis and they can apply the requisite amount of irrigation at appropriate time. Cotton producers can plan irrigation schedules during growing season by preparing a water budget using daily cotton water use and based on the soil water holding capacity.

REFERENCES

- Aboukhaled, A., A. Alfaro and M. Smith, 1982: Lysimeters. FAO irrigation and drainage paper 39. Food and Agriculture Organization, Rome, Italy.
- Allen, R.G., M. Smith, A. Perrier and L.S. Pereira, 1994: An update for the definition of reference evapotranspiration. *ICID Bulletin* 43 (2): 1-34.
- Allen, R.G., L.S. Pereira, D. Raes and M. Smith, 1998: Crop evapotranspiration: guidelines for computing crop water requirements (FAO irrigation and drainage paper 56) Food and Agriculture Organization, Rome, Italy. Available at <http://www.kimberly.uidaho.edu/ref-et/fao56.pdf> Last Accessed: March 8, 2011.
- Allen, R.G., I.A. Walter, R. Elliot, T. Howell, D. Itenfisu and M. Jensen, 2005: The ASCE standardized reference evapotranspiration equation. American Society of Civil Engineers. Reston, Virginia.
- Angus, D.E. and P.J. Watts, 1984: Evapotranspiration-how good is the Bowen ratio method? *Agriculture Water Management*. 8:133-150.
- Ayars, J.E. and R. B. Hutmacher, 1994: Crop coefficients for irrigating cotton in the presence of groundwater. *Irrigation Science*. 15 (1): 45–52.
- Blaney H.F. and W.D. Criddle, 1950: Determining water requirements in irrigated areas from climatological irrigation data. Technical Paper No. 96, United States Department of Agriculture, Soil Conservation Service, Washington, D.C.
- Bowen, I.S. 1926: The ratio of heat losses by conduction and by evaporation from any water surface. *Physical Review*. 27:779-787.
- Brady, N.C. 1990: *The Nature and Properties of Soils*. New York, USA: Macmillan Publishing Co., Inc.
- Brown, K.W. and N.J. Roosenberg, 1973: A resistance model to predict evapotranspiration and its application to a sugar beet field. *Agronomy Journal*. 65: 341 - 347.
- Burman, R.D., P.R. Nixon, J. L. Wright and W.O. Pruitt, 1980: Water Requirements. In: Jensen, M.E. (Ed.), Design and operation of farm irrigation systems, ASAE Monograph, No. 3. 189-232.
- Burt, C. M., A. J. Mutziger, R. G. Allen and T.A. Howell, 2005: Evaporation research: review and interpretation. *Journal of Irrigation & Drainage Engineering*. 131(1):37-59.
- Chiew, F.H.S., N.N. Kamaladasa, H.M. Malano and T.A. McMahon, 1995: Penman-Monteith, FAO-24 reference crop evapotranspiration and class-A pan data in Australia. *Agricultural Water Management*. 28: 9–21.

- Clawson, E.L., S.A. Hribal, G. Piccinni, R.L. Hutchinson, R.V. Rohli and D.L. Thomas, 2009: Weighing lysimeters for evapotranspiration research on clay soil. *Agronomy Journal*. 101(4): 836-840.
- Cohen, Y., M. Fuchs, V. Falkenflug and S. Moreshet, 1988: Calibrated heat pulse method for measuring water uptake in cotton. *Agronomy Journal*. 80:398–402.
- Colaizzi, P.D., E.M. Barnes, T.R. Clarke, C.Y. Choi and P.M. Waller, 2003: Estimating soil moisture under low frequency surface irrigation using the CWSI. *Journal of Irrigation & Drainage Engineering*. 129:27–3.
- Doorenbos, J. and W.O. Pruitt, 1975: Guidelines for predicting crop water requirements. FAO irrigation and drainage paper No.24, Food and Agricultural Organization, Rome, Italy.
- Doorenbos, J. and A.H. Kassam, 1979: Yield response to water. FAO irrigation and drainage paper 33, Food and Agricultural Organization, Rome, Italy.
- Dyer, A.J. and F.M. Mayer, 1965: Automatic eddy-flux measurement with evapotron. *Journal of Applied Meteorology*. 4:622-625.
- Dyer, A.J., B.B. Hicks and K.M. King, 1967: The fluxatron- a revised approach to the measurement of eddy fluxes in the lower atmosphere. *Journal of Applied Meteorology*. 6: 408-413.
- Farahani, H.J., T.Y. Oweis and G. Izzi, 2008: Crop coefficient for drip-irrigated cotton in a Mediterranean environment. *Irrigation Science*. 26(5):375-383.
- Fontenot, R.L., 2004: An evaluation of reference evapotranspiration models in Louisiana. *Master's Thesis*. Louisiana State University, Baton Rouge. 66-68.
- Fritschen, L.J., 1965: Accuracy of evapotranspiration determinations by the Bowen ratio method, *International Association of Scientific Hydrology Bulletin*. 10:38-48.
- Granier, A., 1985: Une nouvelle méthode pour la mesure du flux de sève brute dans le tronc des arbres (A new method of sap flow measurement in tree stems), *Annals of Forest Science*. 42(2): 193-200.
- Gunston, H. and C. H. Batchelor, 1983: A comparison of the Priestley–Taylor and Penman methods for estimating reference crop evapotranspiration in tropical countries. *Agricultural Water Management*. 6: 65–77.
- Hague, S., A. Coco and D.J. Boquet, 2003: Irrigating cotton on alluvial soils in Louisiana. *Louisiana Agriculture* 46(2): 30-31.
- Hanks, R.J., 1992: *Applied Soil Physics*. New York, USA: Pringer-Verla New York, Inc.

- Hansley, D. and J. Deputy, 1999: Using tensiometers for measuring soil water and irrigation scheduling. Cooperative Extension Service, College of Tropical Agriculture and Human Resources, Manoa, Hawaii. Available at <http://www.ctahr.hawaii.edu/oc/freepubs/pdf/L-10.pdf> Last Accessed : April 12, 2011.
- Hargreaves G.H. and Z.A. Samani, 1985: Reference crop evapotranspiration from temperature. *Applied Engineering in Agriculture*. 1: 96-99.
- Howell, T.A., R.L. McCormick and C. J. Phene, 1985: Design and installation of large weighing lysimeters. *Transaction of ASAE*. 28(1):106-112, 117.
- Howell, T.A., A.D. Schneider and M.E. Jensen, 1991: History of lysimeter design and use for evapotranspiration measurements. In Lysimeters for evapotranspiration and environmental measurements, *Proceedings of the International Symposium on Lysimetry*, (Ed.) R.G. Allen, T.A. Howell, W.O. Pruitt, I.W. Walter and M.E. Jensen, 1-9, 23-25 July, Honolulu, Hawaii: American Society of Civil Engineers.
- Howell, T.A., A. D. Schneider, D. A. Dusek, T. H. Marek and J. L. Steiner, 1995: Calibration and scale performance of Bushland weighing lysimeters. *Transaction of the ASAE*. 38(4): 1019-1024.
- Howell, T.A., S.R. Evett, J.A. Tolk and A.D. Schneider, 2004: Evapotranspiration of full-deficit-irrigated, and dry land cotton on the northern Texas high plains. *Journal of Irrigation and Drainage Engineering*. 130(4): 227-285.
- Howell, T. A., S.R. Evett, J. A. Tolk, K.S. Copeland, D.A. Dusek and P.D. Colaizzi, 2006: Crop coefficients developed at Bushland, Texas for corn, wheat, sorghum, soybean, cotton, and alfalfa. In Examining the confluence of environmental and water concerns, *Proceedings of the World Water and Environmental Resources Congress*, 21-25 May, (CD-ROM), Omaha, Nebraska.
- Hribal, S., 2009: Crop coefficients for cotton in Northeast Louisiana. *Master's Thesis*. Louisiana State University, Baton Rouge, USA.
- Hunsaker, D.J., G.R. Hendrey, B.A. Kimball, K.F. Lewin, J.R. Mauney and J. Nagy, 1994: Cotton evapotranspiration under field conditions with CO₂ enrichment and variable soil moisture regimes. *Agricultural and Forest Meteorology*. 70:247-258.
- Hunsaker, D.J., 1999: Basal crop coefficients and water use for early maturity cotton. *Transactions of the ASAE*. 42(4): 927-936.
- Hunsaker, D.J., P.J. Pinter, Jr., E.M. Barnes and B.A. Kimball, 2003: Estimating cotton evapotranspiration crop coefficients with a multispectral vegetation index. *Irrigation Science*. 22(2): 95-104.
- Hunsaker, D.J., E.M. Barnes, T.R. Clarke, G.J. Fitzgerald and P.J. Pinter, Jr., 2005: Cotton

- irrigation scheduling using remotely sensed and FAO-56 basal crop coefficients. *Transactions of the ASAE*. 48(4): 1395-1407.
- Johnson, R.S., L.E. Williams, J.E. Ayars and T.J. Trout, 2005: Weighing lysimeters aid study of water relations in tree and vine crops. *California Agriculture*. 59(2):133-136. Available at <http://CaliforniaAgriculture.ucop.edu>
- Jensen, M. E. and H. R. Haise, 1963: Estimating evapotranspiration from solar radiation. *Journal of Irrigation and Drainage Division*, American Society of Civil Engineers, 89: 15-41.
- Jensen, M.E., R.D. Burman and R.G. Allen, 1990: Evapotranspiration and irrigation water requirements, ASCE manuals and reports on engineering practices No. 70, American Society of Civil Engineers, New York, 360.
- Karam, F., R. Lahoud, R. Masaad, A. Daccache, O. Mounzer, and Y. Rouphael, 2006: Water use and lint yield response of drip irrigated cotton to the length of irrigation season. *Agricultural Water Management*. 85(3):287-295.
- Kassam, A. and M. Smith, 2001: FAO methodologies on crop water use and crop water productivity. Expert meeting on crop water productivity. Paper No. CWP-M07, FAO, Rome, Italy.
- Ko, J., G. Piccinni, T. Marek and T. Howell, 2009: Determination of growth-stage-specific crop coefficients (K_c) of cotton and wheat. *Agricultural Water Management*. 96:1691-1697.
- Kjelgaard, J.F., C. O. Stockle, R.A. Black and G.S. Campbell, 1997: Measuring sap flow with the heat balance approach using constant and variable heat inputs. *Agriculture and Forest Meteorology*. 85:239-250.
- Louisiana State University Agricultural Center (LSU AgCenter), 2009: Louisiana AgSummary. Available at <http://www.lsuagcenter.com/agsummary/index.aspx>
- Louisiana Agriclimatic Information System, 2009. Station info: Northeast Research Station, LSU Agricultural Experiment Station. Available at <http://weather.lsuagcenter.com/reports.aspx?r=0> (Last Accessed: April 27, 2011), LSU AgCenter, Baton Rouge, LA.
- Malek, E. and G.E. Bingham, 1993: Comparison of Bowen ratio-energy balance and the water balance methods for the measurement of evapotranspiration. *Journal of Hydrology*. 146:209-220.
- Marani, A. and M. Horwitz, 1963: Growth and yield of cotton as affected by the time of a single irrigation. *Agronomy Journal*. 55:219-222.

- Marek, T., G. Piccinni, A. Schneider, T. Howell, M. Jett and D. Dusek, 2006: Weighing lysimeters for the determination of crop water requirements and crop coefficients. *Applied Engineering in Agriculture*. 22(6): 851-856.
- Mauney J.R., B. A. Kimball, P.J. Pinter, Jr., R.L. LaMorte, K.F. Lewin, J. Nagy and G.R. Hendrey, 1994: Growth and yield of cotton in response to a free-air carbon dioxide enrichment (FACE) environment. *Agricultural and Forest Meteorology*.70:31-48.
- Mohan, S. and N. Arumugam, 1994: Crop coefficients of major crops in South India. *Agricultural Water Management*.26(1&2):67-80.
- Monteith, J.L., 1965: Evaporation and the environment. In The state and movement of water in living organisms, *XIXth Symposium*.205-234.Society for Experimental Biology, Swansea, Cambridge University Press.
- National Weather Service-National Oceanic and Atmospheric Administration (NWS-NOAA), 2010: Climate prediction center. Available at http://www.cpc.ncep.noaa.gov/products/analysis_monitoring/regional_monitoring/palmer/2010/
- National Weather Service-National Oceanic and Atmospheric Administration (NWS-NOAA), 2009: Cooperative observer program. Available at <http://www.nws.noaa.gov/om/coop/standard.htm> (Last Accessed: April 27, 2011)
- Netzer, Y., C. Yao, M. Shenker, B.A. Bravdo and A. Schwartz, 2009: Water use and the development of seasonal crop coefficients for superior seedless grapevines trained to an open-gable trellis system. *Irrigation Science*.27:109-120.
- Ohmura, A., 1982: Objective criteria for rejecting data for Bowen ratio flux calculations. *Journal of Applied Meteorology*.21:595-598.
- Penman, H.L., 1948: Natural evaporation from open water, bare soil, and grass. *Proceedings of the Royal Society A*, London 193:120-146.
- Phillips, S.A., 1964: Cotton irrigation studies. Louisiana State University and Agricultural and Mechanical College Agricultural Experiment Station, Bulletin No. 579, 3-34.
- Pinter P. J. Jr., B. A. Kimball, J.R. Mauney, G. R. Hendrey, K. F. Lewin and J. Nagy, 1994: Effects of free-air carbon dioxide enrichment on PAR absorption and conversion efficiency by cotton. *Agricultural and Forest Meteorology*.70:209-230.
- Pinter, P.J. Jr., B.A. Kimball, R. L. Garcia, G. W. Wall, D.J. Hunsaker and R. L. LaMorte, 1996: Free-air CO₂ enrichment: responses of cotton and wheat crops. In Terrestrial ecosystems: responses to elevated carbon dioxide. (Ed.) G.W. Koch and H. A. Mooney, 215-249, Academic Press, Orlando, Florida.

- Priestley, C.H.B. and R. J. Taylor, 1972: On the assessment of surface heat flux and evaporation using large scale parameters. *Monthly Weather Review*.100:81-92.
- Rana G. and N. Katerji, 2000: Measurement and estimation of actual evapotranspiration in the field under Mediterranean climate: a review. *European Journal of Agronomy*, 13(2-3), 125-153.
- Ryan, J., S. Masri, S. Garabet, J. diekmann and H. Habib, 1997: Soils of ICARDA's agricultural experiment stations and sites: climate, classification, physical and chemical properties, and land use. Technical Bulletin. The International Center for Agricultural Research in the Dry Areas, Aleppo, Syria.
- Singh V. P., 1989: Hydrologic Systems: Vol. 2, Watershed Modeling. 320, Prentice-Hall, Englewood Cliffs, New Jersey.
- Smith, M., R. G. Allen, J.L. Monteith, A. Perrier, L. Perriera and A. Segeren, 1991: Report of the expert consultation on procedures for revision of FAO guidelines for prediction of crop water requirements. Food and Agricultural Organization, Rome, Italy.
- Steinberg, S.L., C.H.M van Bavel and M.J. McFarland, 1990: Improved sap flow gauge for woody and herbaceous plants. *Agronomy Journal*. 82:851–854.
- Suleiman, A.A., C.M. Tojo Soler and G. Hoogenboom, 2007: Evaluation of FAO-56 crop coefficient procedures for deficit irrigation management of cotton in a humid climate. *Agricultural Water Management*. 91(1-3):33-42.
- Texier, P.H., 1993: Le-cotton, cinquieme producteur mondial d huile alimentaire (The Cotton-fifth largest producer of edible oil). *Cotton Development*.8: 2-3.
- Tharp, W.H., 1960: The Cotton plant: How it grows and why its growth varies. Agriculture Handbook, United States Department of Agriculture, Agricultural Research Service 178: 17.
- Thorntwaite, C.W., 1948: An approach toward a rational classification of climate. *Geographical Review*.38:55–94.
- Turc, L., 1961: Evaluation des besoins en eau d'irrigation, évapotranspiration potentielle, formule climatique simplifiée et mise a jour. (English: Estimation of irrigation water requirements, potential evapotranspiration: A simple climatic formula evolved up to date). *Annales Agronomiques*.12:13-49.
- United States Department of Agriculture, Soil Conservation Service (USDA-SCS), 1970: Irrigation water requirements. Technical Release.21: 92.

- United States Department of Agriculture – National Agricultural Statistics Service (USDA-NASS), 2010: Louisiana Farm Reporter. 10:10. Available at http://www.nass.usda.gov/Statistics_by_State/Louisiana/index.asp
- United States Department of Agriculture – Foreign Agriculture Service (USDA-FAS), 2010: Country Statistics. Available at <http://www.cotton.org/econ/cropinfo/cropdata/country-statistics.cfm>
- Wright, J.L., 1982: New evapotranspiration crop coefficients. *Journal of Irrigation and drainage Engineering*.108(1):57-74.
- Wright, J.L., 1985: Evapotranspiration and irrigation water requirements. In *Advances in evapotranspiration. Proceedings of the National Conference on Advances in Evapotranspiration* American Society of Agricultural Engineers, 105-113, December 16-17, Chicago, IL.
- Wright D.L. and R.K. Sprenkel, 2005: Cotton growth and development. Agronomy department, Florida Cooperative Extension Service, Institute of Food and Agricultural Sciences, University of Florida. Available at <http://edis.ifas.ufl.edu/ag235> Last Accessed: March 8, 2011.
- Xu, C.Y. and V.P. Singh, 2001: Evaluation and generalization of temperature-based methods for calculating evaporation. *Hydrological Processes*.15: 315-319.
- Young, M. H., P. J. Wierenga, and C.F. Mancino, 1997: Monitoring near-surface soil water storage in Turfgrass using time domain reflectometry and weighing lysimetry. *Soil Science Society of America Journal*.61:1138-1146.

VITA

Vipan Kumar, the son of Sh. Mohinder Pal and Smt. Paramjit, was born in the small village of Rasoolpur Gharotian in Gurdaspur, Punjab, India. He attended the Arya Senior Secondary School, India, for elementary education. He studied at the Institute of Agriculture, Gurdaspur, India, and earned a Diploma in Agriculture (Two year program) from 2002 to 2004. He went to the Punjab Agricultural University, Ludhiana, for a Bachelor of Science (Hons.) with major in crop sciences from 2004-2008. His interest in the agricultural field motivated him for higher education. In June 2009, He was admitted into the Master of Science in agronomy under the supervision of Dr. Ernest L. Clawson at Louisiana State University. He will receive the degree of Master of Science in agronomy in May 2011.