

2008

Modeling and design of low cost customizable household robot

Bharat Narahari

Louisiana State University and Agricultural and Mechanical College, bniyengar@gmail.com

Follow this and additional works at: https://digitalcommons.lsu.edu/gradschool_theses



Part of the [Computer Sciences Commons](#)

Recommended Citation

Narahari, Bharat, "Modeling and design of low cost customizable household robot" (2008). *LSU Master's Theses*. 518.
https://digitalcommons.lsu.edu/gradschool_theses/518

This Thesis is brought to you for free and open access by the Graduate School at LSU Digital Commons. It has been accepted for inclusion in LSU Master's Theses by an authorized graduate school editor of LSU Digital Commons. For more information, please contact gradetd@lsu.edu.

MODELING AND DESIGN OF LOW COST CUSTOMIZABLE HOUSEHOLD ROBOT

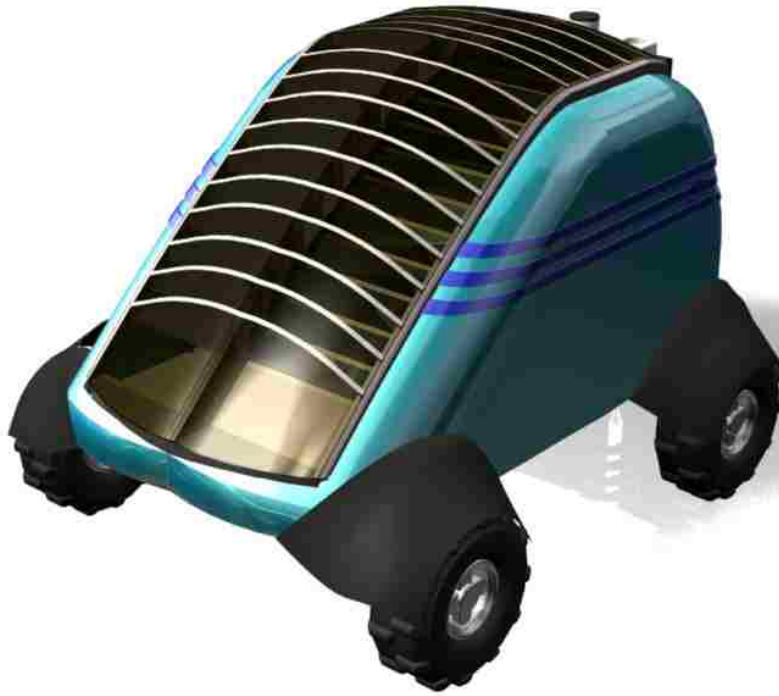
A Thesis
Submitted to the Graduate Faculty of the
Louisiana State University
Agricultural and Mechanical College
in partial fulfillment of the
requirements for the degree of
Master of Science in Systems Science

in

The Department of Computer Science

by
Bharat Narahari
B.E Information Technology, University of Mumbai, India, 2006
December 2008

agBot



Dedicated to the Robotics community

ACKNOWLEDGEMENTS

“Technologies take time-as much as 20 years- to move from invention to arrival in our lives. Because we assume adoption will be more rapid, we inevitably overestimate the short-term and under-estimate the long-term impact of new technologies”

-Paul Saffo: technology forecaster

This thesis was a team effort made possible by the support of Robotics Research Lab at LSU. Dr.S.S.Iyengar has been both my advisor and rich source of knowledge. He is the one who pushed me to the limits and has taught me to think creatively and do things which others can't even dream of. Without his tremendous and constant support I wouldn't have possibly imagined to do such a wonderful and technically challenging work. Thank you so much Dr.Iyengar for guiding and having trust in me. I would also like to thank Dr. Bijaya Karki and Dr. Brygg Ullmer for being in my committee. I would like to thank Jong Hoon Kim my lab partner for helping me in every aspect of building the robot. Lastly, to USA which has made me to think out of the box.

TABLE OF CONTENTS

ACKNOWLEDGEMENTS	iii
LIST OF TABLES	vi
LIST OF FIGURES	vii
ABSTRACT.....	ix
1. INTRODUCTION	1
1.1 Goal of Thesis	1
1.2 Summary of Thesis	2
2. TRENDS IN PERSONAL ROBOTICS	3
3. RELATED WORK.....	8
4. MATHEMATICAL MODELING.....	10
4.1 DC Motor Modeling	10
4.2 Kinematic Modeling	14
5. CONSTRUCTING 3D MODELS	19
6. POWER AND LOAD CALCULATION	24
7. ELECTRONICS AND CONTROL SOFTWARE	28
7.1 Electronics.....	28
7.2 Control Software.....	34
7.3 Mobile Intrusion Detection Using agBot.....	35
8. DISCUSSION.....	39
8.1 Application of CHR	39
8.2 Human-Robot Interaction	40
8.3 Peek into HERO Jr. Robot.....	41
8.4 Limitations of This Thesis	42
CONCLUSION.....	43
FUTURE WORK.....	45
BIBLIOGRAPHY.....	46
APPENDIX A: MATERIAL SELECTION AND FABRICATION.....	49
A.1 Material and parts Selection.....	49
A.2 Fabrication of Seeding and Drilling Mechanism	51

A.3 Fabrication of Broadcast spreader system	54
A.4 Fabrication of Pan/Tilt system	55
APPENDIX B: SCHEMATICS.....	57
APPENDIX C: ASSEMBLING CHR AGBOT	59
APPENDIX D: SUPPLIERS AND COST	67
VITA.....	68

LIST OF TABLES

Table 2.1: Recent domestic robots.....	6
Table 6.1 Mass calculation of agBot.....	24
Table 6.2 : Power consumption by drive motor.....	25
Table 6.3: Power consumption by Broadcast spreader system.....	26
Table 6.4: Power consumption by Electronic system.....	26
Table 6.5: Total Power consumption by agBot.....	27
Table 7.1: Image processing snippet.....	37
Table 7.2: Code snippet of MAPI.....	37
Table 7.3: Code snippet of sound API.....	38
Table A.1: Materials and Dimension for 3D models.....	49
Table A.2 Parts selection	50
Table D.1: Suppliers and cost.....	67

LIST OF FIGURES

Figure 2.1: Task based classification of robots.....	4
Figure 3.1: Robotic Platform Developed at UIUC	9
Figure 4.1: DC motor	10
Figure 4.2: Block diagram of DC motor.....	12
Figure 4.3: DC motor frequency response.....	13
Figure 4.4: DC motor Step response.....	13
Figure 4.5: Velocity of vehicle	14
Figure 4.6: Reference frames for CHR.....	15
Figure 4.7: Kinematic model simulation when orientation is varying.....	18
Figure 4.8: Kinematic model simulation when position is varying	18
Figure 5.1 Exterior view of agBot 3D model	20
Figure 5.2 Labeled parts of agBot.....	21
Figure 5.3: 3D model of agBot Chassis.....	22
Figure 5.4: 3D model of seeding and drilling mechanism.....	23
Figure 5.5: 3D model of broadcast fertilizer system.....	23
Figure 7.1: CHR Electronic Architecture	28
Figure 7.2: Basic Stamp configuration	29
Figure 7.3: Super carrier Board	30
Figure 7.4: EB500 Bluetooth Transceiver module	31
Figure 7.5: Sabertooth 10amp R/C Motor driver.....	32
Figure 7.6: Graph showing Amps versus RPM under No load	33
Figure 7.7: agBot software control system- RUI.....	34

Figure A.1: Seed Hopper and DC motors of Seeding and Drilling mechanism	52
Figure A.2: Front view of Seeding and Drilling Mechanism	53
Figure A.3: Side view of Seeding and Drilling mechanism	53
Figure A.4: The spinner of Broadcast system.....	54
Figure A.5: The gait of Broadcast system	55
Figure A.6: The spinner and gait	55
Figure A.7: Pan/Tilt system	56
Figure B.1: Main board Schematics.....	57
Figure B.2: Motor controller.....	58
Figure C.1: CHR parts	59
Figure C.2: Top view of agBot base	60
Figure C.3: Bottom view of agBot base.....	60
Figure C.4: U-clamp, plates and nuts.....	61
Figure C.5: Mounted motor on base	61
Figure C.6: Motor arbor.....	62
Figure C.7: Extension attached to arbor	62
Figure C.8: Wheel with extended shaft.....	63
Figure C.9: Gait system of broadcast spreader	63
Figure C.10: Spinner system attached underneath base.....	64
Figure C.11: Spinner and gait	64
Figure C.12: Fertilizer tank.....	65
Figure C.13: agBot with installed electronics, chassis and cover.....	65
Figure C.14: Assembled agBot.....	66

ABSTRACT

Just as the growth of Personal computer, Mobile phones and Automobiles took place in last 3 decades, the personal robotics industry still in its nascent stage, is heading in the same direction. This thesis explores the concept of customizable household robots (CHR) in the robotics community. An attempt has been made to design a customizable robot by extending the 2 wheel differential drive kinematic model to 4 wheel independent differential drive kinematic model. A framework for CHR is developed which will be able to do various household repetitive tasks. Just as we can assemble a PC by buying its individual components, in the same way in near future we should be able to assemble a robot at home to do specific/multiple tasks.

This thesis presents the kinematic modeling and 3D design of CHR agBot, agBot is a 4 wheel independently driven solar powered robot. It weighs approximately 25 lbs. It is equipped with various sensors like compass, ultrasonic, GPS, and vision. To validate the concept of customizable household robot, lawn maintenance module and security module have been implemented.

1. INTRODUCTION

The sheer urge to automate tedious and monotonous field job has lead to the very development in the area of robotics. To mimic the human like operation is the core objective of any robot. *Robotics* is an “applied science” which can incorporate high-technology, electronics, mechanics, pneumatics, remote actuation and, of course, the technology of creating, designing, building, ‘manufacturing’ and applying robots and robotic systems. To effectively conceive and then implement robotic designs calls for more than a working knowledge of many separate ‘sciences’, including electronics, mechanics, servo-mechanisms, computers, programming and a logical, ordered mind, even when brainstorming.

1.1 Goal of Thesis

Initially the goal of this thesis was to develop just lawn maintenance robot, but after careful observation and thorough survey of the existing trend in personal robotics industry, it became evident that there is a need for a complete paradigm shift in the evolution of household robot. This research project will explore and introduce the concept of customizable domestic household robot. This thesis concentrates on building a framework in the novel concept of CHR for advanced research in future. The foundations of CHR which this thesis will document are

- a) Simulation and Analysis of CHR
- b) Designing the framework for CHR
- c) Providing proof of concept of CHR

The objective of this thesis will be accomplished on successful testing of agBot, which is a first version of CHR. The basic premise of CHR is to use a single robot for various tasks. Unlike, today’s existing industry standard where the motto is “One robot one task”, CHR will focus on its core ideology of “One robot for every task”.

1.2 Summary of Thesis

Below is the flow of thesis

Chapter 2 investigates past and present trends in field of personal robotics, in correspondence with trends in other technology.

Chapter 3 describes some of the related work.

Chapter 4 discusses mathematical modeling for CHR.

Chapter 5 gives details of 3D modeling of CHR

Chapter 6 goes into power and load calculation

Chapter 7 details the electronics, sensors and controls system of robot.

Chapter 8 dwells into discussion

Chapter 9 gives conclusion and future work.

Appendix A Materials selection and Fabrication of modules.

Appendix B Electrical Schematics

Appendix C Assembling CHR agBot for lawn maintenance and mobile security

Appendix D Suppliers and Costs

2. TRENDS IN PERSONAL ROBOTICS

Before going into the trends of personal robotics, it is necessary to take a dive into the history of personal computers and its evolution, because robotics is an outgrowth due to solid support from PC industry. PC's evolved from huge calculators used in WW2 down to mainframes in 1960 and eventually to the PC in 1980s [29]. The journey of PC from inception to complete evolution took approximately 30 years. The initial inception years were filled with skepticism and it took nearly a decade to abolish that skepticism of adoption. The next decade the masses started adopting and accepting PC as part and parcel of their lives. The final decade we see emerging leaders in PC industry and can safely conclude that PC has reached its peak. Using the above observation, and recoining paul saffo's 30 year rule, one can surmise that "First Decade of new technology is confusion, Second decade is adoption and the Third decade is emergence of a market leader".

The rise of PCs was allowed by the creation of integrated circuits which could act as a complete computer. A company like Apple Computer in 1978 just had to pick a dozen or so of these premade "chips" and wire them together to launch a revolution. Subsequent growth of the industry was driven by ever-faster chips, coupled with expanding memory and disk storage. There were very few "qualitative" changes - the PC revolution was comparable to someone rewiring an engine to ever-faster speeds. The heavy lifting of creating mass-market ICs had already been accomplished. The reason this happened at all was because hundreds of millions, even billions of dollars had already been spent in the 1960s and 1970s to develop the integrated circuit to a cheap, mass-market product.

Robots were initially used in the automation sector to handle repetitive and simple tasks reliably, with the objective of cost reduction per product. Along with the increased speed of

embedded microcontrollers, the service robotic sector has started to grow [32]. Figure 2.1 provides a task based classification of robots in which service robots are divided into several subcategories. Domestic robots are being designed to assist humans with tasks such as vacuum cleaning, lawn mowing, mobile security, and window cleaning. [33]. Focus of this thesis is household robots, so in further part of the chapter we will discuss trends and present scenario of household robots.

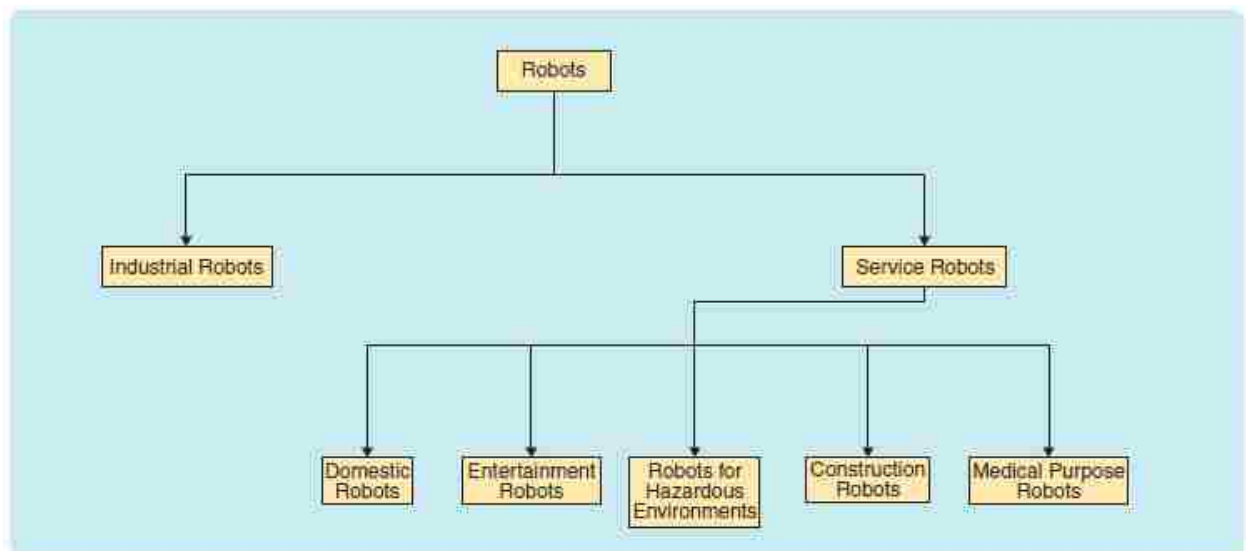


Figure 2.1: Task based classification of robots

Much of the credit goes to Irobot Corporation for introducing robots in household. It would be wise to say that Irobot was the one who pioneered household robotics revolution when they launched the floor cleaning robots. This completely changed the scenario of household robotics, because prior to that, robots were mostly associated with industrial zone and research laboratory. This resulted in foray of many other research institutions, which were only focusing on solving research problems, to jump into household robotics. While dealing with robotics, the roboticists have to deal with many sub categories like electronics, navigation, vision, sensors, and software

issues, which results in complex entity called as robot. And when thing get complicated there is a lot of possibility of it getting bugged. This clearly reflected in the initial issues of household robotics, where in, robots were behaving abnormally most of the times and performed at less than half of their efficiency, moreover they weren't exhibiting any artistic design qualities which made human robot interaction even worse.

In last 10 years, household robotics has hardly made any significant progress; this is a direct result of usage of same chips which were used for PC revolution, and the misconception that the already well established PC industry market will provide a good infrastructural framework for a push in household robotics industry. But this myth has to be given away, because the key component of a robot, as opposed to a PC, is real-time processing of sensory data in order to perform specific actuation. Chip plays very trivial role in this process, because, the major element which needs to do the task is the robot framework or we can call moving parts of robot mechanical architecture

In recent years, the household robotics has not witnessed any major breakthrough revolutionary product. Futurist in 1950s predicted there will be robot servants in next decade, but although there has been a major technological advances in the field of electronics and information technology which resulted in many intelligent devices in homes, but not anything which can be certified as a robot. The present situation of the household robotics portrays a lackluster scenario where, Irobot and other robotic companies have not been able take the household robotics into a leap beyond expectations. Their motto of "One robot one task" aptly fits their business profit model but fails when it comes to advancement in consumer robotics. Let us have a look at some of the robots which can be considered as domestic robots.

Table 2.1: Recent domestic robots

	Irobot Roomba which was introduced around 2000, vacuums the floor.
	Electrolux Trilobite same as Irobot's roomba
	Zucchetti Lawnbott is a lawn mowing robot
	Friendly Robotics robotic lawn mower

No doubt that all the future forecasters have predicted that world will be full of robots and robots will become a part and parcel of our lives, but that dream can only be realized if there is a paradigm shift in thinking and implementation of ideas relating to household robotics. When we

look back 3 decades and see the evolution of mobile phone and personal computer, we can conclude that when a technology reaches its peak point it becomes customizable. Personal Robotics is still evolving and will take more than three decades to reach its peak point.

3. RELATED WORK

In 1999 Chandler and Meiszer [33] created the *Lawn Shark* using a modified Toro electric push mower. This mower used two ultrasonic sensors (sonar) and an improved GPS system. Meiszer[34] explored the use of genetic algorithms to optimal place the satellites for the GPS system. Chandler later explored the use of textural analysis for intelligent mowing in [35].

“Autonomous full-scale vehicle guidance research in agriculture is well represented in the literature. Excellent references to automated vehicle guidance research in Canada, Japan, Europe and the USA can be found in Wilson, (2000), Torii, (2000), Keicher and Seufert, (2000) and Reid, et al., (2000). Much agricultural robotics research has been performed in controlled environments such as robotic picking of cherry tomatoes (Kondo, et al., 1996a), cucumbers (Van Henten, et al., 2002), mushrooms (Reed, et al., 2001) and other fruits (Kondo, et al.,1996b). In horticulture, robots have been applied to citrus (Hannan, 2004) and apples (Bulanon, et al., 2001). Also, milking robots have had much attention particularly in the Netherlands (Rossing, 1997).

Few journal articles are available regarding the development of Autonomous Robots for Field Applications. A weed control robot was developed by Baerveldt and Astrand (1998), and Bak and Jakobsen (2004) proposed a small field robot capable of traveling between crop rows to register the locations of crops and weeds using a camera and GPS receiver. If the robot is to be used solely for scouting, it can be as small as planet rovers (Biesiadecki et al., 2000, Kuroda, 2003). Gomide et al. (2003) used a radio-controlled robotic helicopter to cover a smaller area to improve the resolution, but it required a professionally skilled operator.

There is much interest in the development of Field Robots in Europe as evidenced by Wageningen University in the Netherlands which organized a Field Robot competition in 2003

and 2004 where students, faculty and research institutions were represented (Van Straten, 2004). AgBo, as described in this paper, competed in the 2004 competition.” [2][3][4]

Tony and Matthias [2] , have developed a test bed of two robots to investigate into the philosophies of robot used for agriculture. The have developed a platform consisting of GPS, compass, ultrasonic and SICK laser sensors to navigate across mushy agricultural field. According to them they have been quite successful in developing this robot. Below Figure 2.1 shows their platform



Figure 3.1: Robotic Platform Developed at UIUC

4. MATHEMATICAL MODELING

4.1 DC Motor Modeling

Consider a DC motor in below figure, whose rotor and shaft are assumed to be rigid. Assuming the following physical values:

Moment of inertia of the rotor $J = 0.01 \text{ kg} \cdot \text{m}^2$

Damping (friction) of the mechanical system $b = 0.1 \text{ Nms}$

(back-) electromotive force constant $K = 0.01 \text{ Nm/A}$

Electric resistance $R = 1$

Electric inductance $L = 0.5 \text{ H}$

V is the input voltage in volts

Ω is the angular velocity of shaft in radians per second

Θ is the shaft angle in radians



Figure 4.1: DC motor

System Equations:

The motor torque T is related to the armature current, i , by a torque constant K ;

$$T = Ki. \quad (1)$$

The back electromotive force (emf), V_b , is related to the angular velocity by:

$$V_b = K\omega = K \frac{d\theta}{dt}. \quad (2)$$

Based on Newton's law and combining with Kirchhoff's laws and from above figure we can write the following equation

$$J \frac{d^2\theta}{dt^2} + b \frac{d\theta}{dt} = Ki, \quad (3)$$

$$L \frac{di}{dt} + Ri = V - K \frac{d\theta}{dt}. \quad (4)$$

Using Laplace transform we can obtain a Transfer function from equation (3) and (4)

$$Js^2\theta(s) + bs\theta(s) = KI(s), \quad (5)$$

$$LsI(s) + RI(s) = V(s) - Ks\theta(s), \quad (6)$$

Where s denotes Laplace operator, from (6) we can express $I(s)$ as:

$$I(s) = \frac{V(s) - Ks\theta(s)}{R + Ls}, \quad (7)$$

And substituting the value of $I(s)$ in equation (5), we get

$$Js^2\theta(s) + bs\theta(s) = K \frac{V(s) - Ks\theta(s)}{R + Ls}. \quad (8)$$

The above equation (8) is shown in the block diagram in the figure below, also by using equation (8) we can derive a transfer function from the input voltage, $V(s)$, to the output angle, θ ,

$$G_a(s) = \frac{\theta(s)}{V(s)} = \frac{K}{s[(R + Ls)(Js + b) + K^2]}. \quad (9)$$

The transfer function from the input voltage, $V(s)$, to angular velocity, ω , is:

$$G_v(s) = \frac{\omega(s)}{V(s)} = \frac{K}{(R + Ls)(Js + b) + K^2} \quad (10)$$

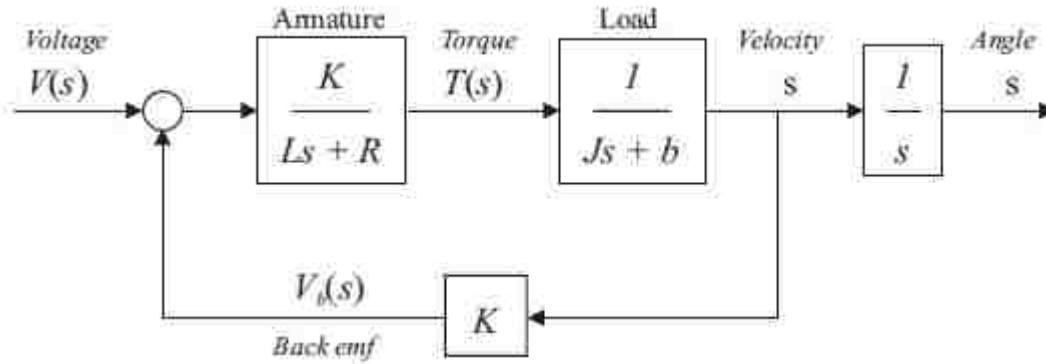


Figure 4.2: Block diagram of DC motor.

Before proceeding to simulate the above equation in MATLAB, we need to find the constant values for K, J, b, R, L, and V. Using the following data we will calculate the unknowns,

Power consumed by motor= 60 watts,

Speed N = 150 rpm, rotor inertia J is assumed to be 0.01 and supply voltage $V_t=12$ volts

Using the following equation we will calculate the value of K ,

$$\omega_m = \frac{V_t}{K} = \frac{(2\pi N)}{60} \quad (11)$$

We get $K= 0.023$ and $\omega=524$ rad/sec

Assuming the following values $b=0.1$, $R=1$, $L=0.5$, $J=0.01$, $K=0.02$, we proceed with the Simulation. Below is the frequency response of the DC motor in terms of bode plot.

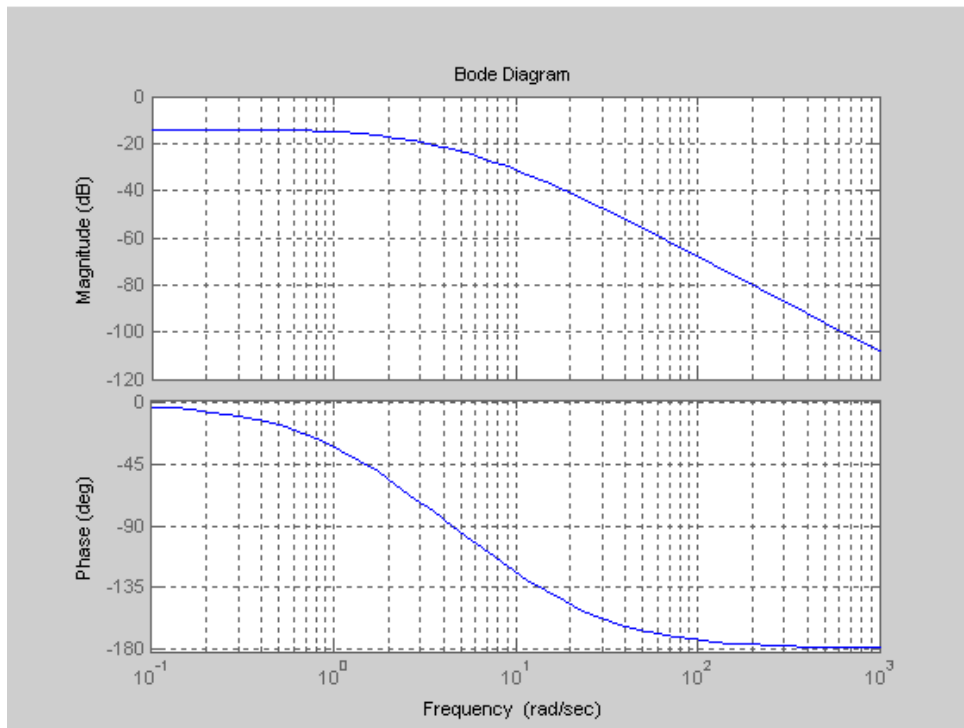


Figure 4.3: DC motor frequency response

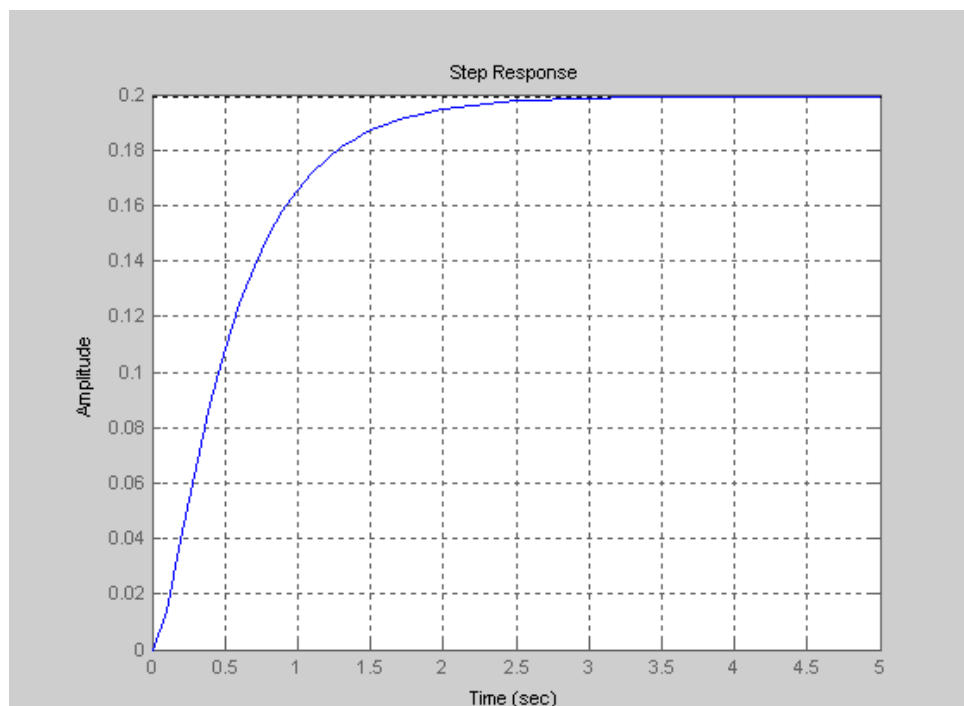


Figure 4.4: DC motor Step response

Response of agBot while reaching steady state is simulated below

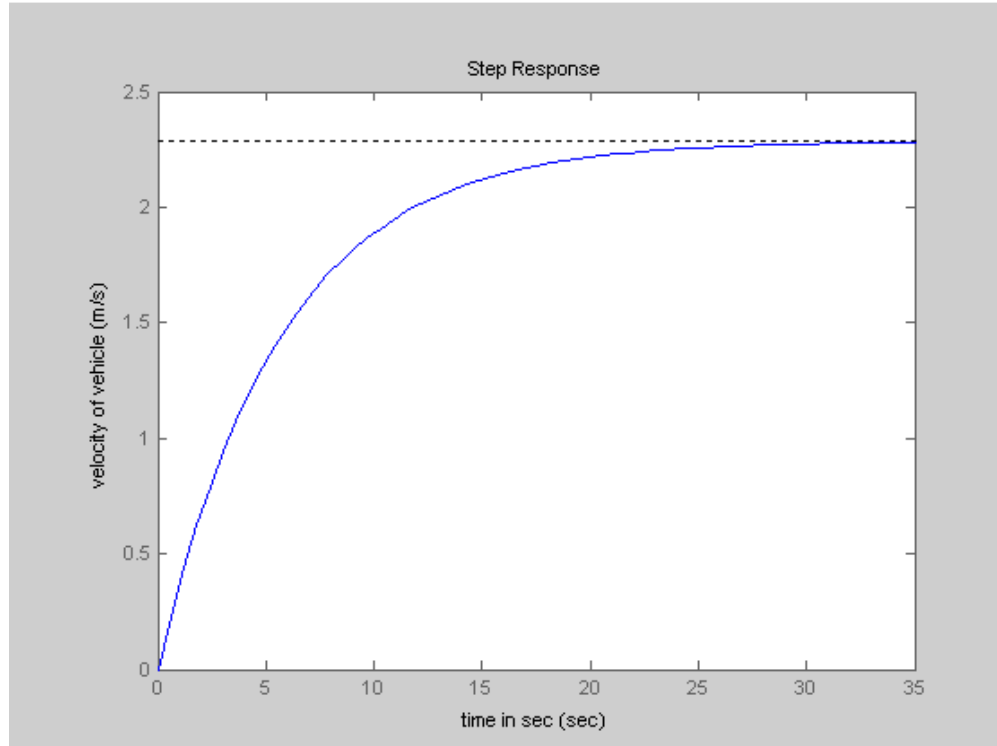


Figure 4.5: Velocity of vehicle

From the above plot we can see that it takes agBot, around 25 seconds to reach a steady state velocity of 2.25m/s

4.2 Kinematic Modeling

Differential driven Mobile robot is a self contained autonomous entity, which can move wholly with respect to its environment. Due to the entire body motion, it becomes difficult to estimate the robot's position, and there is no direct way of doing it , instead one much integrate the motion of robot with respect to time t by considering few other variables like the wheel slippage, wheel misalignment etc, which makes motion estimation a challenging problem. To tackle this problem we have to start bottom-up, we need to model the motion of wheels attached to the motors. If we consider each wheel on the robot as a separate entity that when worked in

coalition, results in motion of entire robot body. So it is imperative to get a clear model of wheels and its constraints on robot's mobility

In kinematic modeling we will describe the robot as a function of its geometry and individual wheel behavior, following are steps in kinematic modeling:

Step1: Define Reference frame for robot

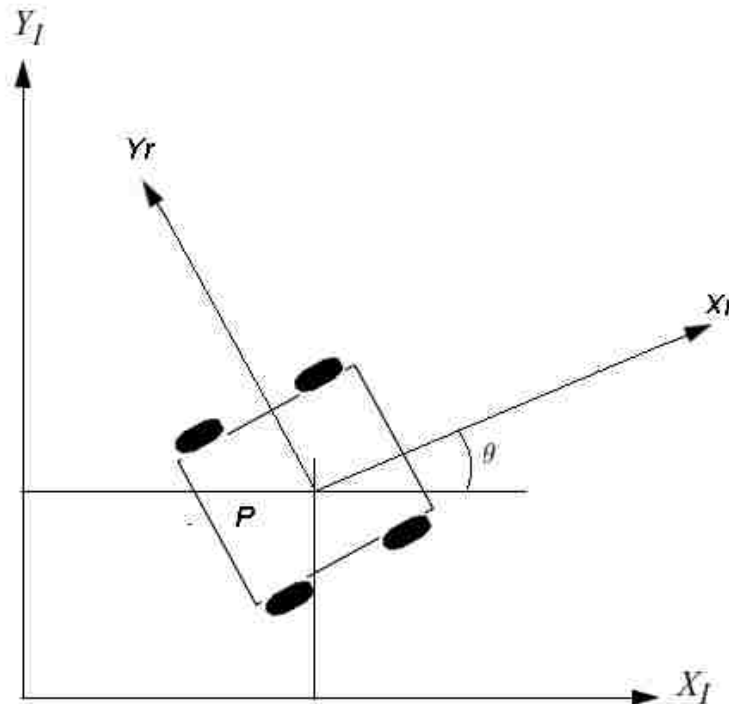


Figure 4.6: Reference frames for CHR

Figure: Local and global reference frame of robot

Before we define robot's global and local reference frame, we will have to make few assumptions, those are

We assume that the robot are rigid body and secondly

The surface of motion for robot is even plane horizontal

Based on the above assumptions, we establish a relationship between global and local reference frames. The global reference frames are defined in terms of (X_I, Y_I) . To define the local

reference point we P which the center of rotation of rigid body, by (X_r, Y_r) . Thus we can establish that to define a position of robot we need at least 2 dimension, and to establish a more concrete relation we need to introduce a third dimension which defines the orientation of robot and i.e. angular difference between global and local reference point. We will denote angular difference as θ . Finally we can describe the position of the robot using the a pose vector in the form of

$$v = [x; y; \theta] \quad (1)$$

Step2: Define Motion of robot

In order to describe the motion of the robot we need to define a relationship between global reference frame and local reference frame. This mapping can be done using a rotation matrix which is given as

$$R(\theta) = \begin{bmatrix} \cos\theta & \sin\theta & 0 \\ -\sin\theta & \cos\theta & 0 \\ 0 & 0 & 1 \end{bmatrix} \quad (12)$$

Therefore mapping is defined by

Local Reference frame (LR) = $R(\theta)$ * Global Reference frame (GR)

So if the orientation i.e $\theta = \pi/2$, then the rotation matrix will be

$$R\left(\frac{\pi}{2}\right) = \begin{bmatrix} 0 & 1 & 0 \\ -1 & 0 & 0 \\ 0 & 0 & 1 \end{bmatrix} \quad (13)$$

Step3: Kinematic model of robot

Using the above two equations we will model a simple scenario of robot motion, which will tell us how does the robot move, given its geometry and speeds of wheels. Let us consider the following

Four wheel independent differential drive robot.

Wheel diameter is d

Centroid of rigid body is denoted by C

Each wheel is at a distance of l from C

Each wheel is spinning at a speed of w_1, w_2, w_3 and w_4 .

Using the above criteria the kinematic model would predict the overall speed of robot in global frame.

$$GR = [x_1; y_1; \theta_1] = f(l, r, \theta, w_1, w_2, w_3, w_4) \quad (14)$$

From [1] , we get the following equation for differential drive robot

$$R(\theta)^{-1} \begin{bmatrix} \frac{r\dot{\phi}_1}{2} + \frac{r\dot{\phi}_2}{2} \\ 0 \\ \frac{r\dot{\phi}_1}{2l} + \frac{-r\dot{\phi}_2}{2l} \end{bmatrix} \quad (15)$$

Using the above equation, a simulation has been performed to plot the robot path in 2 different conditions,

- 1) When only orientation is changed and robot is travelling in constant speed , what will be it path.

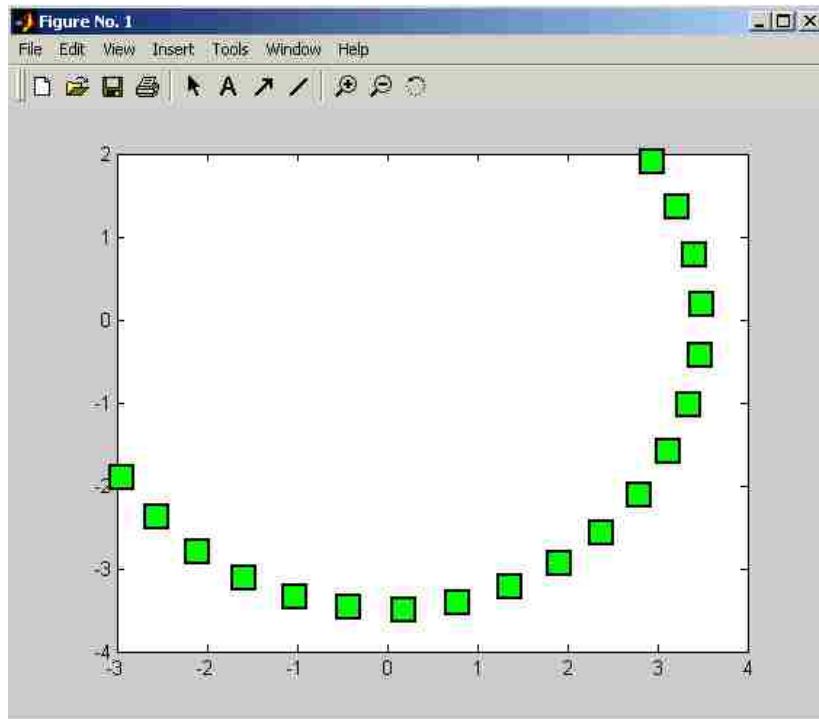


Figure 4.7: Kinematic model simulation when orientation is varying

2) When orientation is constant and position is changing

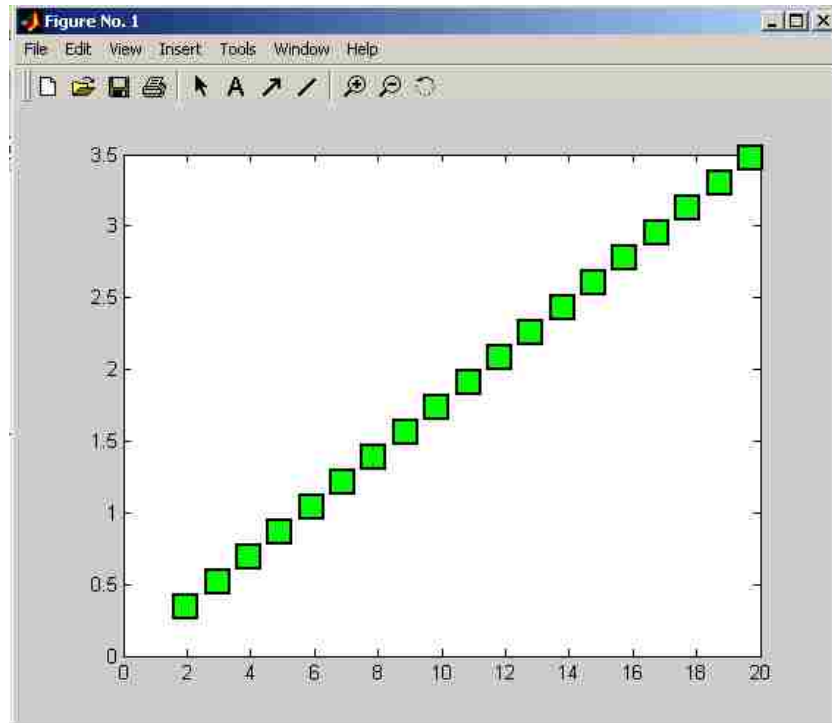


Figure 4.8: Kinematic model simulation when position is varying

5. CONSTRUCTING 3D MODELS

The main goal of this thesis was to develop an outdoor robotic vehicle which will fertilize the lawn, drill the soil and sow the seeds, and guard the house during night. Some of the main features which the robot should have are:

- a) **Outdoor terrain capabilities:** A minimum ground clearance of 2 inch was required after installing the spreader system beneath the base. The height of the spreader system is approximately 5 inches. So a wheel size of approximately 14 inch diameter is required to satisfy the above criteria. Moreover to drive outside, while carrying a total weight of 50 pounds, the robot should be equipped with high torque motor and should have a speed of at least 6 mph.
- b) **Technical details:** The microcontroller used should have enough number of IO pins in order to control several components like, 4 drive DC motors, 2 auger DC motors, 2 servos for broadcast spreader, 1 servo for seed sowing, 2 servos for panning and tilting camera. Drive motor controller should have a rating of 10 amps per motors, continuous and should have the feature of feeding the signal via RC receiver. Battery charger should be on board and should start automatic charging when the battery level falls below the threshold. A 20 watt solar panel is required to charge the batteries.
- c) **Mechanical details:** Robot chassis will be constructed using aluminum and the motors will be fitted using a clamp and L-bars. The broadcast spreader will be developed using plastic and the actuators will be servo motors. Seed dispenser system will be equipped with a seed hopper for seed storage and the drilling system will be made out of auger screw controlled by DC motors. L-bars will be used for mounting solar panels. Batteries

will be mounted in specialized battery container. So the overall weight of the robot will not exceed 50 pounds after all components and batteries are mounted. The body of the robot will be made out of thin aluminum and will be colored using a spray paint.

With a list like this, it's much easier to begin visualizing and drawing up the plan. By drawing a visual plan of the entire system with the above mentioned requirements, would give us a good picture of the overall system and possibly help in detecting flaws. Before getting into drawing the individual components, we started by drawing the big picture, i.e. the structure and looks of the agBot. The process was started by drawing few rough sketches using pencil and paper. As soon as we were convinced of the paper design, we started designing the model using 3Ds max software. In Below figure 5.1 are some of the designs of agBot from different angle. The main aspect while designing the 3D model were, outer appearance, colors, shape and size.

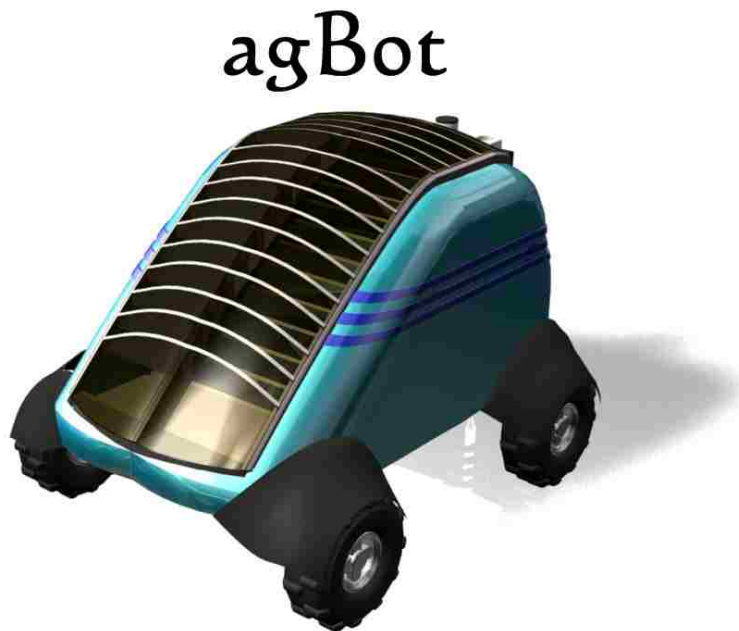


Figure 5.1 Exterior view of agBot 3D model

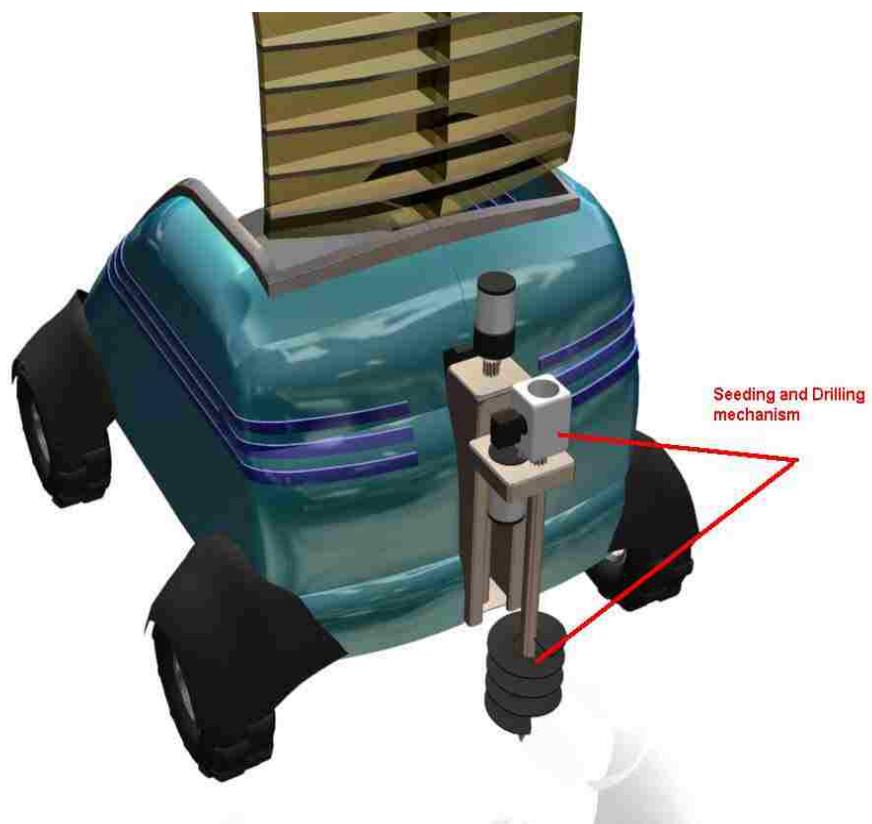
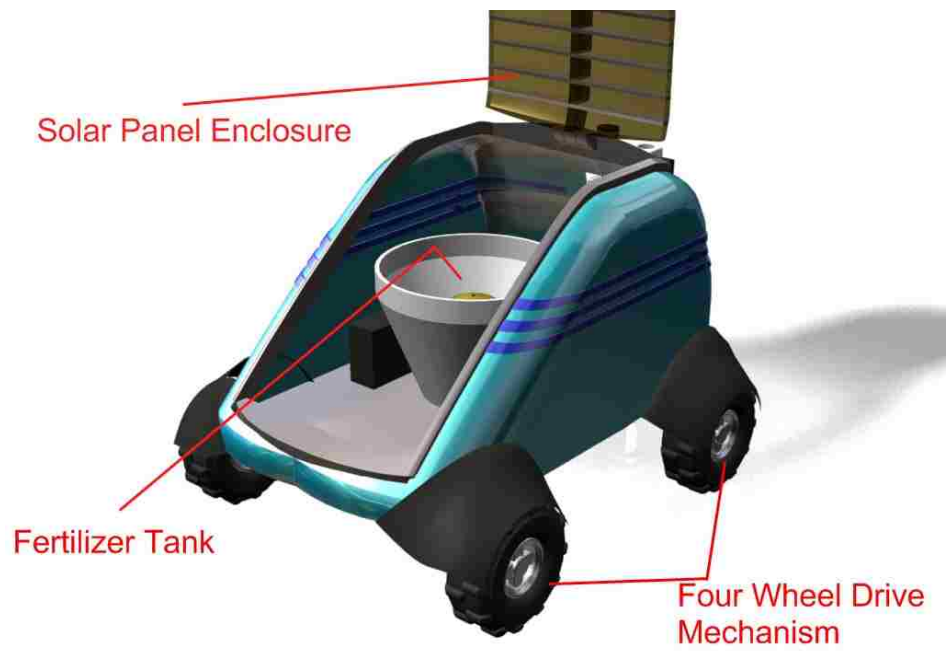


Figure 5.2 Labeled parts of agBot

The next step in modeling agBot was to go further and do a modeling of internal parts. So we started by modeling the chassis. Below figure 5.3 shows the results of modeling.

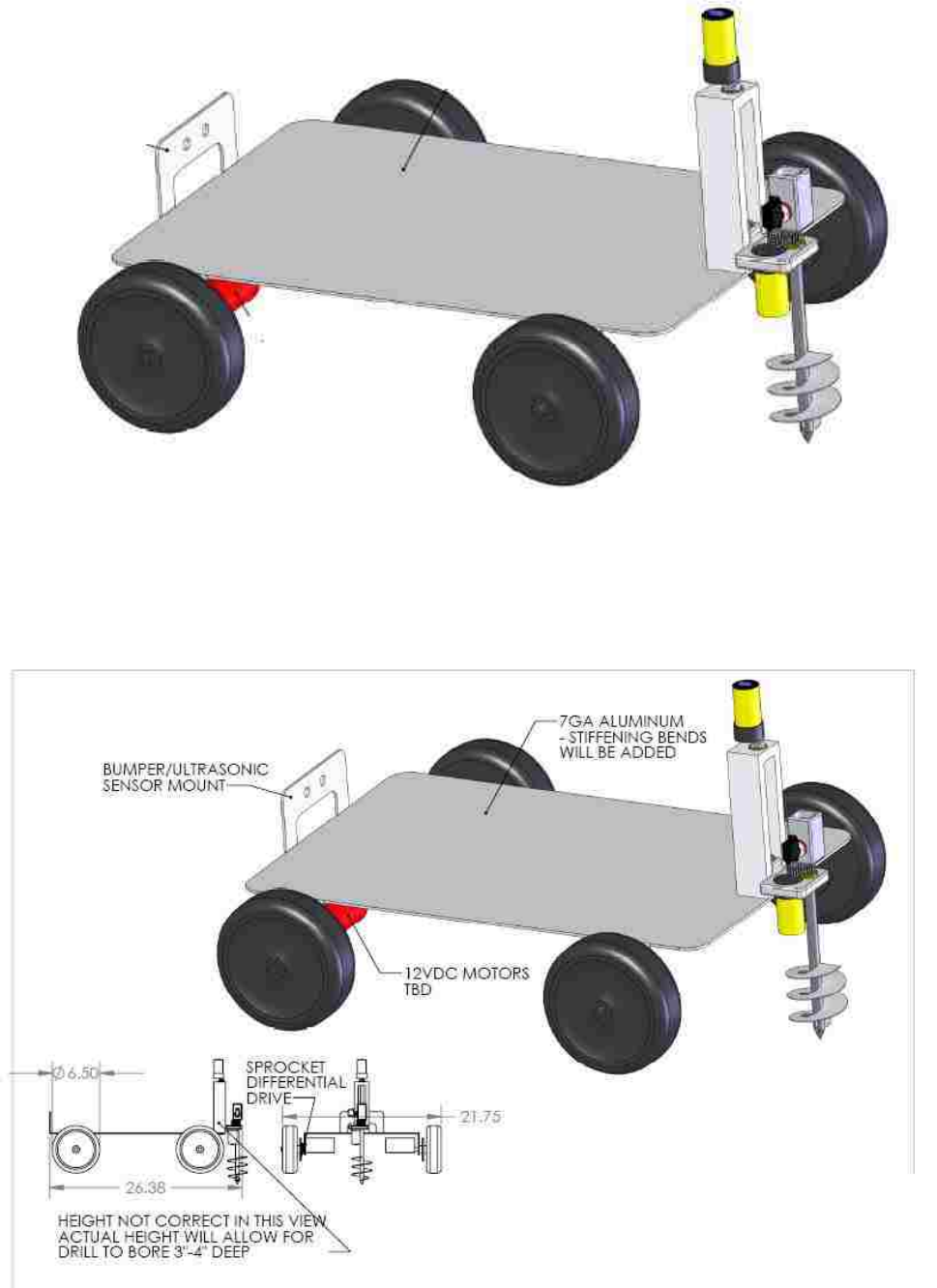


Figure 5.3: 3D model of agBot Chassis

Next we modeled the seeding and drilling system

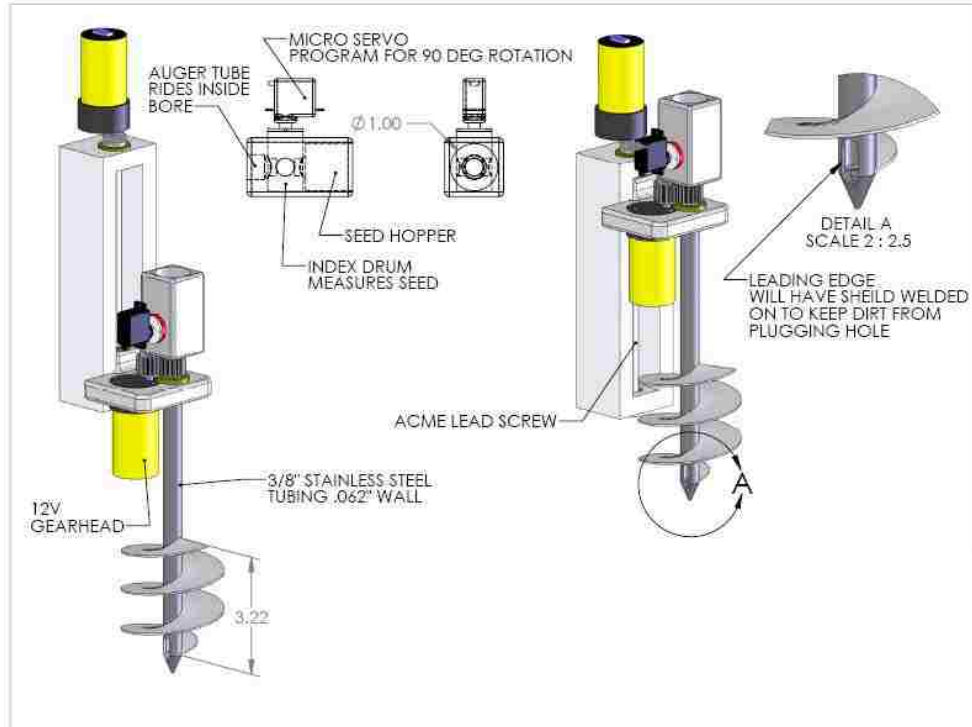


Figure 5.4: 3D model of seeding and drilling mechanism

Next on the pipeline was the broadcast spreader system to be modeled.

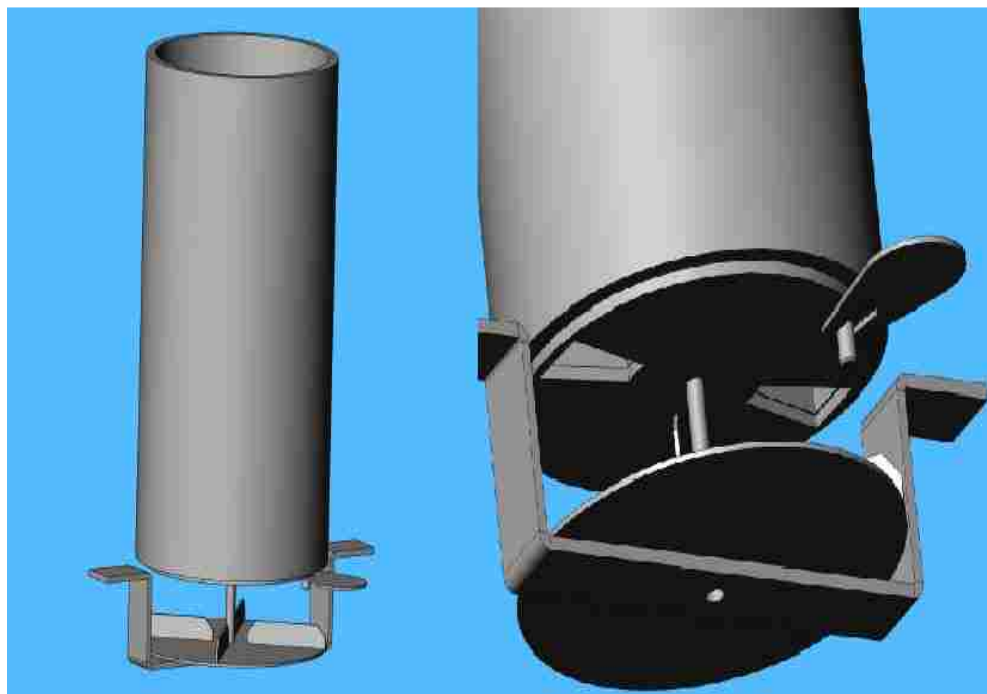


Figure 5.5: 3D model of broadcast fertilizer system

6. POWER AND LOAD CALCULATION

The most important step before material selection is to calculate the power and load of the robot. These are the two most important variables in deciding the batteries, motors, wheels and electronics. First we will write down the weight of individual components. Below is the table showing weights.

Table 6.1 Mass calculation of agBot

Part name	Weight in lbs	Total weight in lbs
Motor	3	$3 * 4 = 12$
Aluminum chassis	7.5	7.5
U clamps for motor	1	$1 * 8 = 8$
Seeding and Drilling system	4.5	4.5
Broadcast spreader system	3	3
Chassis body	4	4
Wheels	3	$3 * 4 = 12$
		(Table contd..)

Batteries	5.7	$5.7 * 2 = 11.40$
Solar panel	4.2	4.2
Electronics	1	1
	Total Weight	67.6 lbs

The total weight of the robot comes out to be approximately 67 pounds.

The total battery requirements are calculated using following formula below:

Table 6.2 : Power consumption by drive motor

Power consumption by Drive motor	
Drive Motor Voltage:	12v
Expected current draw:	4 amps
Number of motors:	4
% of Time Motors are used:	75
Total Power consumption by the Drive motors: $(\text{Voltage} * \text{current}) * 4 * \% \text{ of Time Motors used}$	
: 144 watts	

Table 6.3: Power consumption by Broadcast spreader system

Power consumption by Broadcast spreader system	
Drive Motor Voltage:	12v
Expected current draw:	0.5 amps
Number of motors:	1
% of Time Motors are used:	80
Total Power consumption by the Drive motors: (Voltage * current) * 1*% of Time Motors used	
: 4.8 watts	

Table 6.4: Power consumption by Electronic system

Power consumption by Electronic systems	
Microcontroller + Bluetooth Voltage:	5v
Expected Total current draw:	0.8 amps
Total Power consumption: (Voltage * current) *% of Time used + energy loss due to wire resistance	
: $4*1+0.15 = 4.6$ watts	

Table 6.5: Total Power consumption by agBot

Total Power consumption =

Power consumption by Electronic systems +

Power consumption by Broadcast spreader system +

Power consumption by Seeding and Drilling system + Power consumption by Drive motor +

4.6 + 4.8 + 7.2 + 144 = 160 watts of power is consumed by agBot every hour

7. ELECTRONICS AND CONTROL SOFTWARE

7.1 Electronics

The basic electronic subsystem of the robot is shown in figure 7.1. The robot is powered using two 12v sealed lead acid battery which is charged using 20 watt solar panel. The control software is loaded wirelessly using Bluetooth and also the sensor data is retrieved using Bluetooth. Two micro controllers are used, one acts as a master and the other acts as a slave. The master controller is used for actuation and to run the navigation algorithm, and the slave controller is used to handle the sensor input.

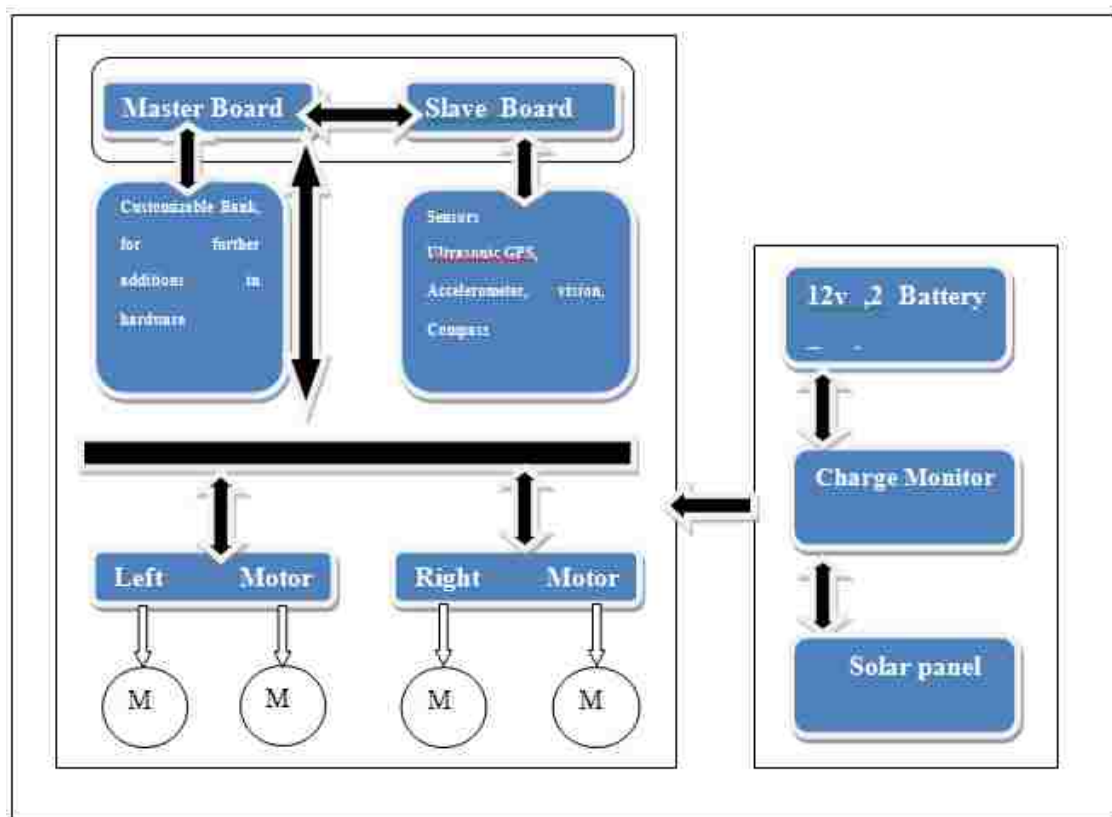


Figure 7.1: CHR Electronic Architecture

Released Products	BS2p24-IC
Package	24-pin DIP
Package Size (L x W x H)	1.2"x0.6"x0.4"
Environment	0° - 70° C ** (32° - 158° F) **
Processor Speed	20 MHz Turbo
Program Execution Speed	~12,000 instructions/sec
RAM Size	38 Bytes (12 I/O, 26 Variable)
Scratch Pad RAM	128 Bytes
EEPROM (Program) Size	8x2K Bytes, ~4,000 Instructions
Number of I/O pins	16 +2 Dedicated Serial
Voltage Requirements	5 - 12 vdc
Current Draw @ 5V	40 mA Run / 350 µA Sleep
Source / Sink Current per I/O	30 mA / 30 mA
Source / Sink Current per unit	60 mA / 60 mA per 8 I/O pins
PBASIC Commands	61
PC Programming Interface	Serial Port (9600 baud)
Windows Text Editor	Stampw.exe (v1.1 and up)



Figure 7.2: Basic Stamp configuration

In order to facilitate faster prototyping we purchased the super carrier board, which had on board prototyping area and DIP's to insert the Basic stamp IC. The Super Carrier Board has the following features:

- a) 3" x 4" Double-sided plated through-hole prototype board
- b) Sockets support BS1-IC, JS1-IC, and all 24 pin BS2 modules
- c) On-board voltage regulator accepts 6-30 VDC, from wall-pack or battery
- d) Serial programming port (DB9) can be used for run-time communication (BS2 series)
- e) AppMod header for easy expansion
- f) Size measures 7.7 x 10.2 cm (3"x 4") [27]

Below is the figure showing the super carrier board

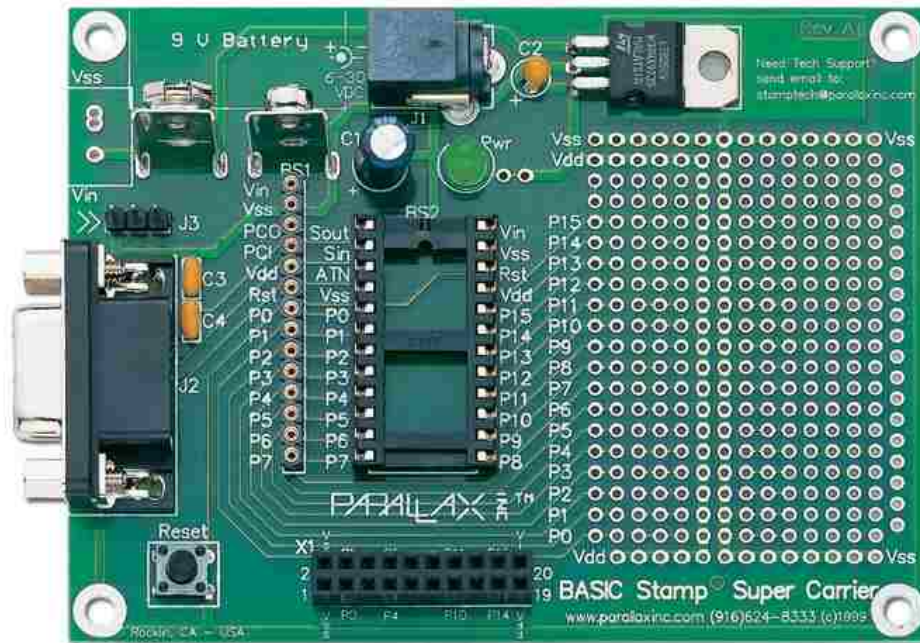


Figure 7.3: Super carrier Board

After further investigations, we decided that to test our prototype we will be using Bluetooth as a means of communicating with the robot. The Eb500 EmbeddedBlue Bluetooth transceiver module is compatible with the basic stamp and super carrier board also provides a app mod for easy installation.

Technical Specifications include:

- a) Frequency: 2.4 GHz FHSS (Frequency Hopping Spread Spectrum)
- b) Transmit Power: 4dBm (max) class 2 operation
- c) Open field range: 300 feet
- d) Bluetooth: Compliant with the v1.1 standard
- e) Receiver Sensitivity at 0.1% BER: -85dBm

Key Features:

- a) Easy integration with the BASIC Stamp 2 Series for point-to-point communication

- b) Seamless connectivity with standard Bluetooth devices
- c) Perfect for wireless cable replacement
- d) Optional Pass-Key
- e) Encryption 56bit and 128bit

The maximum transmission power of the EmbeddedBlue module is 4 dBm which corresponds to 2.5mW. The actual power will vary from about 0.5mW up to 2.5mW depending on distance and interference. The EmbeddedBlue module reduces its transmission power to the minimum level that will keep a strong solid signal. This allows the module to conserve power when located in close proximity to the other radio. [27]. Below is the figure of Bluetooth module

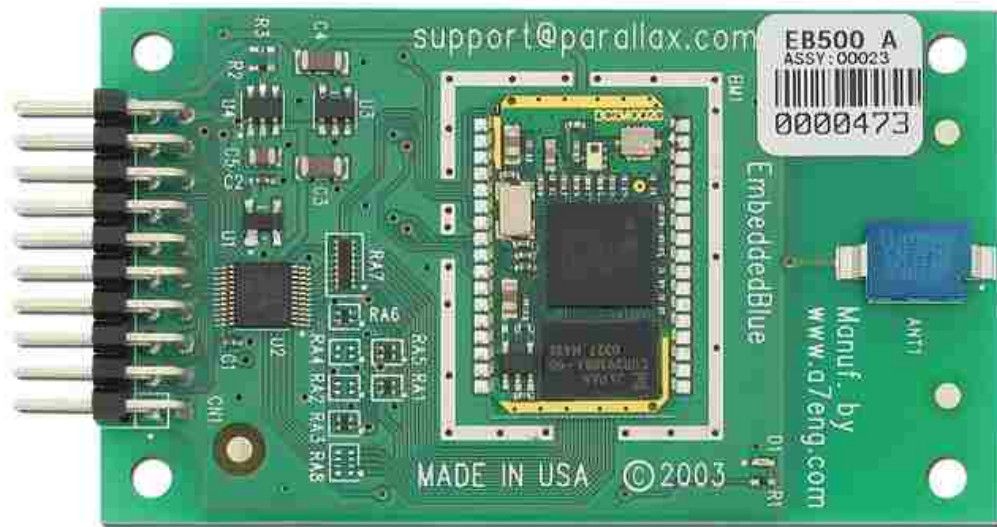


Figure 7.4: EB500 Bluetooth Transceiver module

The fourth important module of electronic configuration is the motor driver. After deciding the motors, we found out its stall current to be about 5 amps. So we decided to go with a 10 amp motor driver. Since we had a good experience with the Dimension Engineering's

Sabertooth RC motor driver, we opted for an high end configuration of the motor driver which was even compatible with the RC interface and Basic stamp.

Technical specification:

- a) Up to 18V in: 10A continuous, 15A peak per channel.
24V in: 8A continuous, 10A continuous with additional heatsinking/airflow, 15A peak per channel.
- b) Synchronous regenerative drive
Ultra-sonic switching frequency
Thermal and overcurrent protection
Lithium protection mode

Out of the box, it can supply two DC brushed motors with up to 10A each. Peak currents of 15A are achievable for a few seconds. It also provides Overcurrent and thermal protection. The figure below shows the sabertooth motor driver along with the graph of Amps versus RPM.

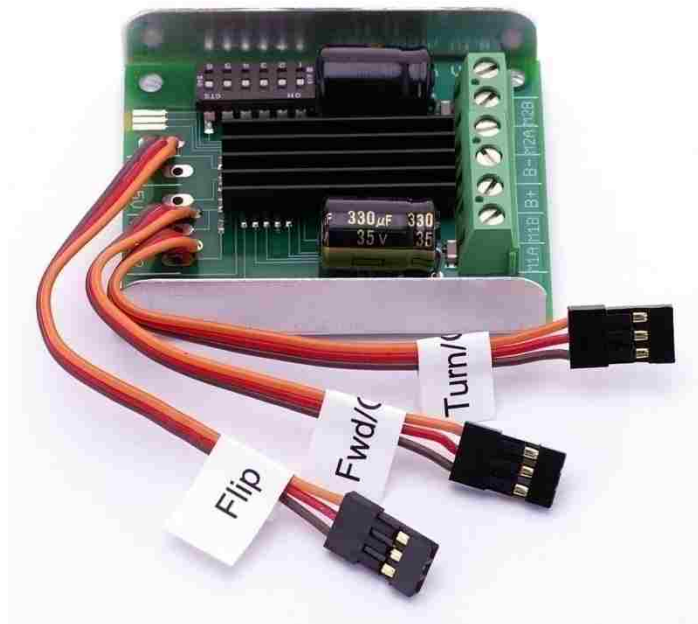


Figure 7.5: Sabertooth 10amp R/C Motor driver

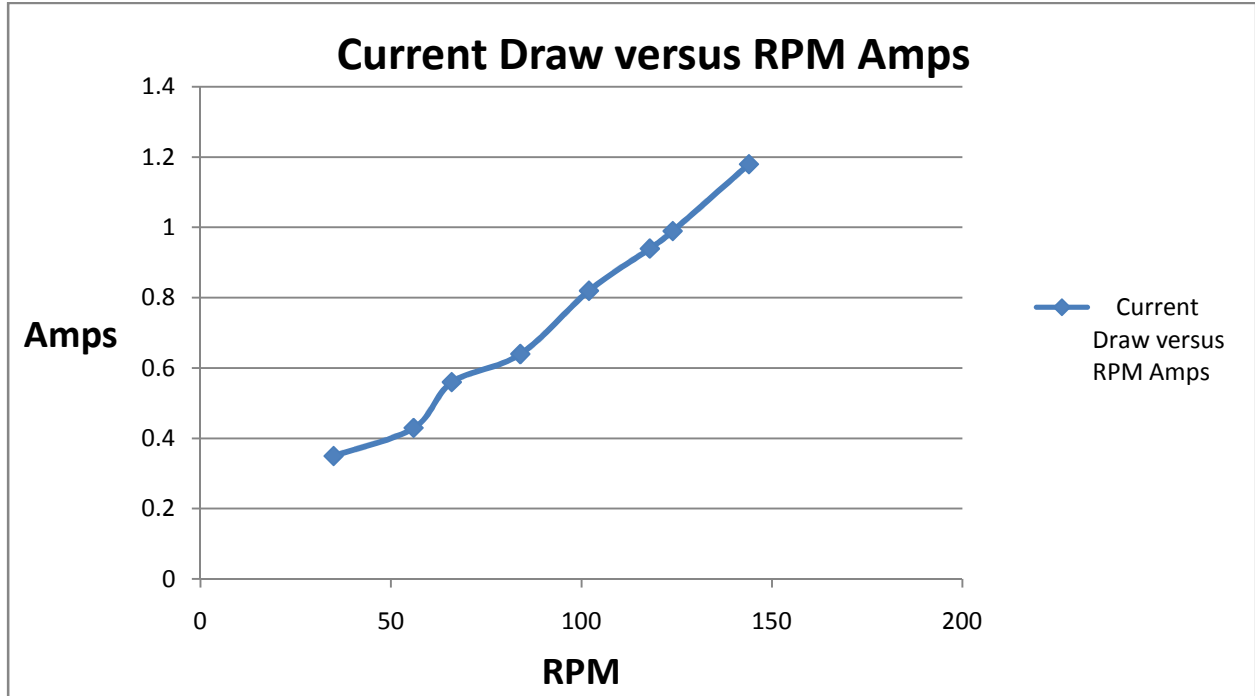


Figure 7.6: Graph showing Amps versus RPM under No load

Next we conducted test on the Seeding and drilling system. Following is our analysis

- a) Controlling DC motors was very easy and efficient. We could easily control its speed using PWM routines.
- b) We realized that to drill into a tough soil we need to change the motors to a much powerful ones. Initially the system was designed as a prototype to drill into sand, so if we wanted the system to be able to drill in to mud, the motors require triple the torque of the existing ones.
- c) The seeding system is controlled by the servo, so the timing routine works perfectly so as to release one seed at a time.

Below is the figure showing drilling and seeding system attached to the robot.

7.2 Control Software

CHR software framework supports both wireless remote control and autonomous mode. To be controlled wirelessly, Bluetooth communication channel is implemented. CHR firmware is written in PBASIC and a Robotics User Interface (RUI) is developed for wireless control of the agBot. Below is the figure of RUI:

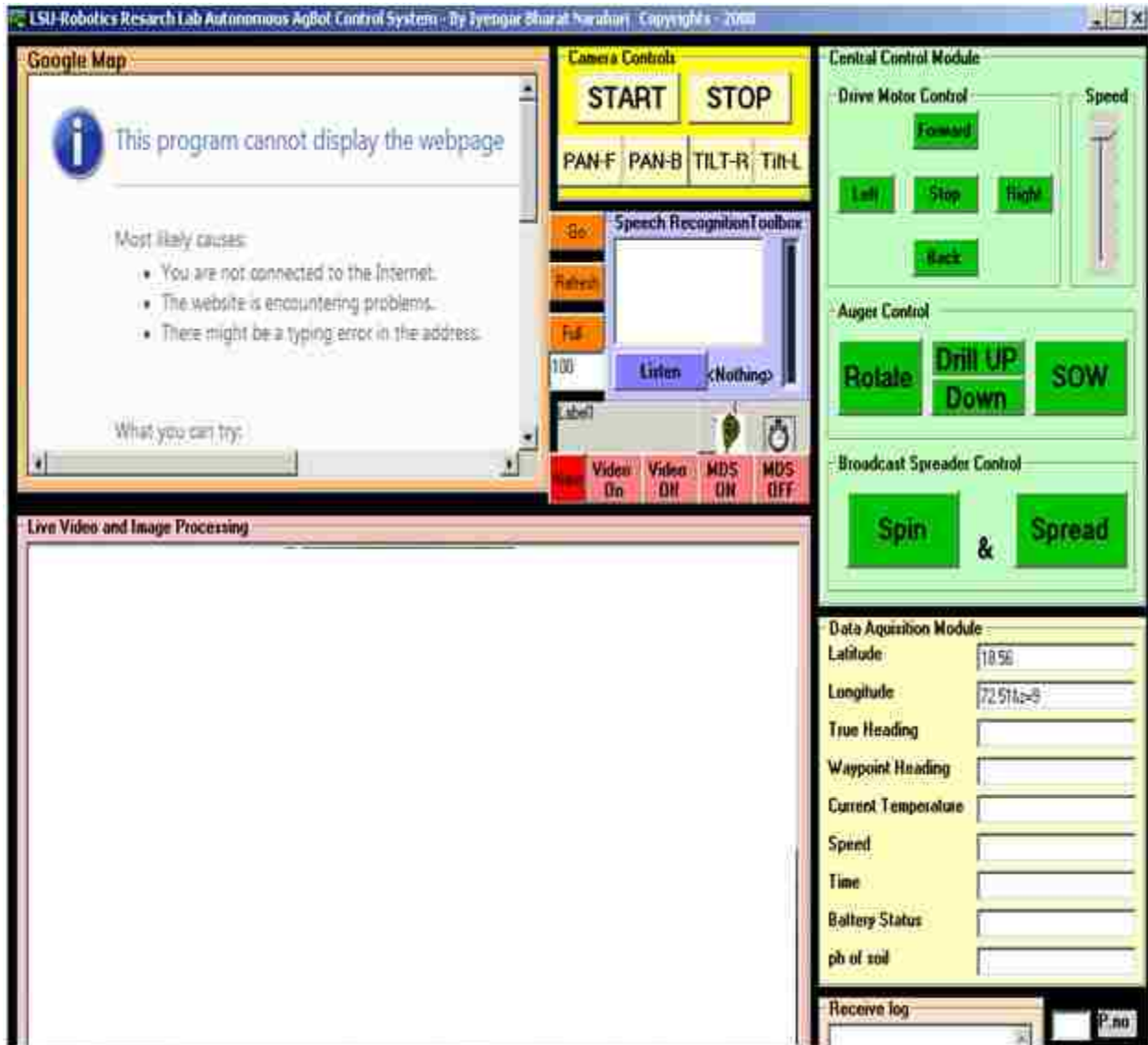


Figure 7.7: agBot software control system- RUI

As we can see from the above figure, the software control system is divided into mainly 7 parts,

- 1) Google maps browser
- 2) Live video
- 3) Speech recognition
- 4) Data Acquisition Module
- 5) Broadcast spreader control
- 6) Auger control
- 7) Drive motor control

The following modules were tested successfully for the wireless communication

- 1) Speech Recognition: The robot has been trained to recognize few words; we have trained the robot to process words like, forward, back, stop, left, right, drill, seed and spread. The robot was able to recognize these words at a hit rate of 85% every time.
- 2) Auger control: The auger is used for drilling and sowing seeds.
- 3) Drive motor control: The basic functions like, moving forward, backwards, turning left and right and stopping were the primary routines tested through wireless channel.
- 4) Live video: We can see what robot sees, a night vision camera is mounted on the robot using a pan and tilt arrangement. In this way we can 360 degrees without actually turning the robot.

7.3 Mobile Intrusion Detection Using agBot

It's intriguing, how a maintenance robot can provide security. When agBot detects any intrusion, the first thing it will do is , set out a loud alarm, this will in turn shock the intruder, and

will set the intruder in back foot. Next, while setting off a loud alarm, it will capture the images of the intruder and immediately mail it to the owner.

The intrusion detection software works by detecting changes in the pixel patterns by analyzing the real time video. Algorithm for IDS is given below

Step 1: Real Time Image Processing

Live Video signals are received from agBot to the base station, to get live signals, we have used an API made available by windows i.e. avicap32.dll. This api provides us the functions to access the signals and project it onto the GUI. Following the process of loading the api and using it to get the live video signals,

```
Private Declare function capGetDriverDescriptionA  
Lib"avicap32.dll"() As Boolean  
"Get Driver name and version  
driver=capGetDriverDescriptionA(x, strName, 100, strVer,100)
```

Step 2: To display the output from a video capture device, we need to create a capture window, connect to the device, scale the output to fit the window, set the preview rate, and finally tell it to start previewing. Create a child window with capCreateCaptureWindowA so we can display it in a picturebox.

Step 3 : To retrieve an image from the preview window, use SendMessage to copy the data to the clipboard. Then transfer the image to the picture box.

Step 4: Finally, to close the preview window, disconnect from the device and destroy the preview window.

Below is a snippet of the image processing code.

Table 7.1: Image processing snippet

```
For i = 0 To 320 / chkpixel - 2
For j = 0 To 240 / chkpixel - 2
'select a point
' c = GetPixel(Form1.Picture1.hdc, i * chkpixel * Tppx, j * chkpixel * Tppy)

c = Picture1.Point(i * chkpixel * Tppx, j * chkpixel * Tppy)
'analyze it, Red, Green, Blue
R = c Mod 256
G = (c \ 256) Mod 256
B = (c \ 256 \ 256) Mod 256
```

Image processing was very fast, and so was mailing the images; it was done using Mail Application Programming Interface (MAPI). Below is the snippet for MAPI. Mail is sent using opening a session in MAPI and this is done by creating an object of default mail client. Once the object is created, a session is created by logging in with specific username and password, then using MAPImessage object, a mail is composed using subject, mail body and attachment and then it is sent to the user.

Table 7.2: Code snippet of MAPI

<i>MAPISession1.SignOn</i>	<i>'Open up a MAPI session:</i>
<i>MAPIMessages1.SessionID = MAPISession1.SessionID</i>	<i>'Point the MAPI messages control to the open MAPI session:</i>
<i>MAPIMessages1.Compose</i>	<i>'Start a new message</i>
<i>MAPIMessages1.MsgSubject = MailSubject</i>	<i>'Set the subject of the message:</i>
<i>MAPIMessages1.MsgNoteText = MailMsg</i>	
<i>MAPIMessages1.RecipIndex = 0</i>	<i>'First recipient</i>
<i>MAPIMessages1.RecipType = 1</i>	<i>'Recipient in TO line</i>
<i>MAPIMessages1.RecipDisplayName = MailAddress</i>	<i>'e-mail name</i>
<i>MAPIMessages1.ResolveName</i>	
<i>MAPIMessages1.AttachmentIndex = 0</i>	
<i>MAPIMessages1.AttachmentPosition = 0</i>	
<i>MAPIMessages1.AttachmentName = "Intrusion Detected.JPG"</i>	
<i>MAPIMessages1.AttachmentPathName = "I:\Animation_AgBot\AgBot\Software\intruder.jpg"</i>	

And lastly, loud alarm is triggered by the WINMM.DLL api. Below is the usage of sound api. Once the intrusion is detected a WAV file is played using this api.

Table 7.3: Code snippet of sound API

```
Private Declare Function sndPlaySound Lib "WINMM.DLL" Alias _  
    "sndPlaySoundA" (ByVal lpszSoundName As String, ByVal uFlags As _  
    Long) As Long
```

```
Const SND_ASYNC = &H1  
Const SND_LOOP = &H8  
Const SND_NODEFAULT = &H2  
Const SND_SYNC = &H0  
Const SND_NOSTOP = &H10  
Const SND_MEMORY = &H4
```


8. DISCUSSION

This thesis is an attempt to introduce the concept of customization in the field of personal robotics. Customization is the need of the hour, if personal household robots need to make an impact in the lives of human beings. As we witness a rapid customization in the field of internet, mobile phones and pc, it is quite evident, this is what the masses are expecting and they won't settle for anything less. In Further part of discussion we put forth ways of extending the concept of CHR and its implication. Also we discuss major issues relating to human robot interaction and its role in shaping the aesthetics and design of robot. In the end we discuss about some of the limitations of this study and view some of the application of CHR.

8.1 Application of CHR

Since this is the introductory concept of CHR, there are endless possibilities in extending and adding variations in its framework. This thesis has presented CHR in the form of a robotic vehicle, but it is not necessary for CHR to be a robotic vehicle, it can be anything from a biped, octopus, crawler, roller etc, it only depends upon our imagination on how we want to project CHR. The prime importance is the concept of CHR which presents us with new opportunities in the direction of customizable robot to fit our needs. In this thesis we have extended CHR to different domain like lawn maintenance and mobile security. One can even imagine CHR to be used as a complete mobile entertainment system which can also act as a postal mail box. In a country like India where internet reach is only 2% and 40% of the population is still illiterate, we can use CHR in remote villages to provide education for children's in school. CHR can be loaded with all necessary educational materials and by using tele-operation one can guide CHR to classes to deliver educational contents. This will lead to a growth in connectivity across India where one can reach a student sitting in north of India and a teacher solving doubt, sitting in

south of India. Thus we can form a network of CHR across a country and tackle grass root problems effectively be it India or Nepal.

8.2 Human-Robot Interaction

When we look at the relationship between human-human and human-pet, it oozes with emotions and interactions. Research have shown that relationship with pets like cats, dogs and rabbits create a measure of emotional attachment which can even replace loneliness and provide some sort of therapeutic benefits. Prior to designing a robot toy , companies found during their market survey that ,if the toy resembles more like real animals in appearance and behavior then it would influence the owner for a deeper emotional attachment. This has resulted into growth of other technologies like the artificial fur, interactive touch sensors which provide a more real pet like appearance and simulate the same behavior when stroked resulting in more bonding between human and robot. A study done by Sherry turkles group at MIT revealed that children who owned AIBO , started naming it as if it were real entity and attributed AIBO emotional qualities like crying , if ever the robot dog was lost. The interactive aspect of robot is the most important and essential criteria for its acceptance.

Japanese robot scientist who have led the research in parent robotics by recognizing that robots have potential to interact with in daily life for performing myriad of tasks. This task can range from mowing a lawn, to vacuuming house, drying clothes, guarding house and taking care of elderly people. These task are considered to be a master and slave relationship, but David Levy in his thesis “Love and sex with Robots” has broken the myth of master and slave relationship between robots, and taken it to an unimaginable level of a sex partner. Indeed when we are moving to an era where robots can interact with us not only in a response to stimuli way but more at a personal level.

8.3 Peek into HERO Jr. Robot

Hero robot was sold as an educational and home robot. The operating system envisioned for CHR will be far more robust and modular in nature than the OS built for Hero Jr. Hero Jr. had an OS which was built on limited memory and slower CPU, due to these limitations, advanced features could not be embedded into its firmware. But the present scenario of advancement in processing technology and mass storage opens new avenues in feature additions. The tele-operation of HERO robot from neighboring house was a breakthrough in terms of communication technology. But what if we need to monitor our house in London using HERO robot by sitting in USA, is it possible using present communication technology? This question poses a very interesting problem mainly in wireless communication and brings us back to the same question of, how much should the robot be intelligent.

First let us discuss the aspects of intelligence for the above example. The question of local intelligence and global intelligence has been a topic of debate for a long time. If we equip our Household robot with all the intelligence required to do common tasks, will it add more processing pressure on the robot to handle the common yet complicated tasks? Or, if we implement the solar system based intelligence wherein all the planets revolve around the main processing component i.e the sun. This type of scenario demands for local intelligence where in the local agent only takes the input and filters the data and sends it back to the main processor sitting outside the local reference frame. The main processor then processes complicated information using its powerful hardware and sophisticated software framework and guides the local agent with output. This sort of intelligence passing mechanism requires stable network.

If we have the local and global intelligence implemented in household robot will it lead to utopian society? The answer lies in further investigation of the link between global and local

points. This problem can be further analyzed by implementing a simple yet critical task by using the fundamentals of local and global intelligence. A simple yet powerful variable like the noise which is an integral part of any communication channel can cause havoc is a known fact. So when we talk about critical task allocation to the household robot, how can we be sure that the noise will not be the cause of latency in the communication channel? Latency will become a major variable when critical tasks need to be executed. So this brings us back to the same question of should we go with the local and global intelligence or embed all the intelligence locally? , It is a matter of future investigation to find a feasible solution for this problem.

8.4 Limitations of This Thesis

The thesis work was conducted over a period of 15 months, where in kinematic model, 3D model; parts fabrication, electronics and communication link were developed. Since this is the first prototype of CHR built from ground up, most of the principles of human robot interaction are left for future version. In this work the goal was to develop a prototype to test the feasibility of CHR. Also due to limitations in budget, there were restrictions on usage and fabrication of custom components, because the prototype was to be developed using readily available off shelf components.

CONCLUSION

The first phase of investigation was performed to test the feasibility of robots in lawn maintenance and seeding operation. After we conducted surveys of the homeowners with backyards, we realized that a robot with additional features like house guarding at night excited quite a few people. The initial low cost test robot which had only two motors and 4 wheel drive configuration proved to be weak. This robot was able to travel in flat surfaces but was getting easily stuck, in the grass and uneven turf. To rectify, this we developed a second more powerful robot i.e the *agBot* which had 4 powerful motors and 14 inch high size wheels, agBot proved to be quite effective and economical as it was developed for under \$1000. Due to its high wheel size it was able to easily maneuver, even on uneven turf and over thick grass. The seeding process proved to be quite a success as the mechanism worked flawlessly; the system was able to drill into loose soil but in order to drill into actual touch soils we need to change the low torque motor.

The broadcast spreader system also worked according to our expectation, the spreader was attached to a low powered non geared DC motor which was able to spin the spreader at 500 rpm but would easily stop on even half pound of load. The solar panel provided 20 watts of power only when the orientation of the panel was perpendicular to the sunlight. It took nearly 5 hours of good sunlight to completely charge the 84 watts of sealed lead acid battery. The garmin GPS behaved erroneously most of the time and it was partially due to blockage of sky because of high trees on the coates hall perimeter, but once we shifted to clear sky we were able to get good reception and the accuracy was up to 3m.

Thus in conclusion, agBot has proved to be a successful first prototype for as a customizable household robotics platform, which has resulted into further investigation of the

existing problems. It's low cost and off shelf components have really proved to be superior in addition to, easy to build chassis and modular components placement. This thesis hopefully will prove to be a starting point for customization in household robot with the motto of "one robot many tasks".

FUTURE WORK

The following additions are expected to be incorporated in the second phase of investigation

- 1) Replacing powerful parallax board with mini-itx board for more processing needs.
- 2) Investigation of human robot interaction
- 3) Modifying the chassis to accommodate more electronics and adding more powerful motors
- 4) Testing the concept of multi robot coordination system
- 5) Adding onboard motion detection sensor for faster detection
- 6) Incorporating Wi-Fi by replacing the Bluetooth
- 7) Adding High resolution camera's

BIBLIOGRAPHY

- [1] Biesiadecki, J., W., Maimore, J., Morrison: 2000. The Athena SDM Rover: a testbed for mars rover mobility. Available at: <http://robotics.jpl.nasa.gov/people/mwm/sdm-mobility/> Accessed 21 Oct 2004
- [2] Tony E. Grift , Matthias Kasten , Yoshisada Nagasaka 2006 Development of Autonomous Robots for Agricultural Applications, Crop Protection Conference
- [3] Cho, S.I., D.S. Lee, J.Y. Jeong. 2002. Weed plant discrimination by machine vision and artificial neural network. *Biosystems Engineering* 83 (3), 275-280.
- [4] Kassler, M. 2001. Agricultural Automation in the new Millennium. *Computers and Electronics in Agriculture* 30 (2001), 237–240.
- [5] Baerveldt, A., J., B., Astrand. 1998. Vision-guided mechanical weed-control. Halmstad University. Available at: <http://www.hh.se/staff/bjorn/mech-weed/>. Accessed 21 Oct 2004.
- [6] Bulanon, D.M., T. Kataoka, Y. Ota, and T. Hiroma. 2001. A machine vision system for the apple harvesting robot. *Agricultural Engineering International: the CIGR Journal of Scientific Research and Development*. Manuscript PM 01 006. Vol. III
- [7] Keicher, R., H., Seufert: 2000. Automatic guidance for agricultural vehicles in Europe. *Computers and Electronics in Agriculture* 25 (12), 169–194.
- [8] Kondo, N., M. Monta, T. Fujiura. 1996a. Fruit harvesting robots in Japan. *Advances in Space Research* 18 (1/2), 181-184.
- [9] Kondo, N., Y. Nishitsuji, P.P. Ling and K. C. Ting, 1996b. Visual feedback guided robotic cherry tomato harvesting. *Transactions of the ASAE* 39-6, 2331-2338
- [10] Reed, J.N., S.J. Miles, J. Butler, M. Baldwin, and R. Noble. 2001. Automatic mushroom harvester development. *J. of Agricultural Engineering Research*, 78(1) 15-23.
- [11] Reid, J.F., Q., Zhang, N., Noguchi, M., Dickson: 2000. Agricultural automatic guidance research in North America. *Computers and Electronics in Agriculture* 25 (12), 155–167.
- [12] Rossing, W. and P.H. Hogewerf. 1997. State of the art of automatic milking systems. *Computers and Electronics in Agriculture* 17 (1), 1–17.
- [13] Torii, T.: 2000. Research in autonomous agriculture vehicles in Japan. *Computers and Electronics in Agriculture* 25 (12), 133–153.
- [14] Van Henten, E.J., J. Hemming, B.A.J. Van Tuyl, J.G. Kornet, J. Meuleman, J., Bontsema, E.A. van Os. 2002. An autonomous robot for harvesting cucumbers in greenhouses. *Autonomous Robots* 13, 241-258.

- [15] Van Straten, G. 2004. Field Robot Event, Wageningen, 5-6 June 2003. *Computers and Electronics in Agriculture* 42(2004) 51-58.
- [16] Will, J., T. Stombaugh, E. Benson, N. Noguchi, and J.F. Reid. 1998. Development of a flexible platform for automatic agricultural guidance research. ASAE Paper 983202. St. Joseph, MI.
- [17] [Elkaim et al, 1997] Gabriel Elkaim, Michael O’Conner, Thomas Bell and Bradford Parkinson. System Identification and Robust Control of Farm Vehicles Using CDGPS. *IONGPS-97*, Kansas City, MO, USA, Vol 2:1415-1424, 1997.
- [18] [Billingsley, 2000] John Billingsley. Low cost GPS for Autonomous Robot Farmhand. *Mechatronics and Machine Vision in Practice 2000*. 119-126, Hervey Bay, QLD, Australia, September 2000.
- [19] <http://www.parallax.com/dl/docs/cols/nv/vol3/col/nv83.pdf> “Where in the world is Basic stamp”
- [20] <http://www.pages.drexel.edu/~weg22/gpsEmaxx/gpsEmaxx.html> “GPS waypoint navigation”
- [21] Mobile Robots-Inspiration to implementation – Joseph Jones, Anita Flynn, Bruce Seiger
- [22] Speed Controllers
<http://homepages.which.net/~paul.hills/SpeedControl/SpeedControllersBody.html>
- [23] The motor control tutorial www.dprg.org/tutorials/2003-10a/motorcontrol.pdf
- [24] Robot Localization and Kalman Filters http://www.negenborn.net/kal_loc/
- [25] Solar panel systems <http://www.solarhome.org/solarlearningcenter.html>
- [26] Introduction to solar energy <http://www.affordable-solar.com/>
- [27] Basic stamp, super carrier Board <http://www.parallax.com>
- [28] Motor driver <http://www.dimensionengineering.com>
- [29] Paul Saffo, “Paul Saffo and 30 year rule”, Design World 1992, Available:
<http://www.saffo.com/aboutps/interviews/Pauldesignworld1992.PDF>
- [30] Irobot, <http://www.Irobot.com>
- [31] Robot Business conference , http://www.theregister.co.uk/2006/06/23/irobot_angle/

[32] I.F. of Robotics, "Service robots," 2005
<http://www.ifr.org/pictureGallery/servRobAppl.htm>

[33] Rand C. Chandler, Katherine A. Meiszer, A. Antonio Arroyo, "LawnShark: A New Platform for Autonomous Mowing and Navigation", Volume 5, April 29-30, 1999, University of Florida, Gainesville, Florida.

[34] Katherine A. Meiszer, "Using a Genetic Algorithm to Determine Optimal Beacon Placement for a Beacon Navigation System," UF Master's Thesis, 2001.

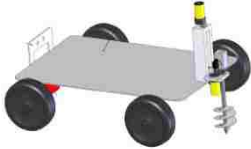
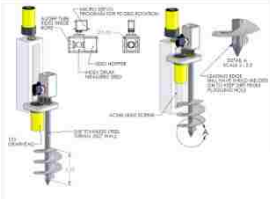
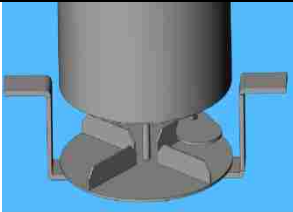
[35] Rand C. Chandler, A. Antonio Arroyo, Michael Nechyba, Eric M. Schwartz, "The Next Generation Autonomous Lawn Mower", Volume 4, May 4-5, 2000, Florida Atlantic University, Boca Raton, Florida

APPENDIX A: MATERIAL SELECTION AND FABRICATION

A.1 Material and parts Selection

Once we were satisfied by the 3D models and done with our power and load calculations, we prepared a manufacturing data which contained part list for the corresponding model. Below is the table A.1 containing the material list.

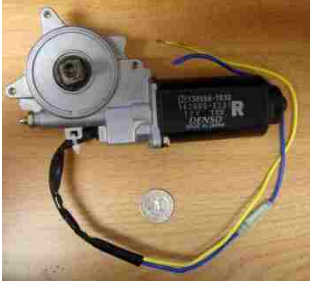



Table A.1: Materials and Dimension for 3D models

3D Model	Materials	Dimensions(in inches)
	Aluminum for chassis, U-clamps, L-plates	24 x 16 x 0.5 4 inch U clamp, 4 inch L plate
	Lexan bars,	9 x 2.5 x 2.5
	Lexan sheet	6.5 inch diameter (2 pcs)

(Table Contd..)

Now we will select wheels, motors, batteries, solar panel, charge controller, wireless camera and pan/tilt system.

Table A.2 Parts selection

Parts	Figure	Quantity
<p>12v DC Motor 150 rpm – 500 oz in</p>		<p>4</p>
<p>Wheel 14 inch x 2inch</p>		<p>4</p>
<p>12v SLA Rechargeable Batteries 7 AH (84 watt)</p>		<p>2</p>
<p>20 watt solar panel</p>		<p>1</p> <p>(Table contd..)</p>

25 amps 12v DC DUAL battery charge controller		1
2.4 GHz wireless camera		1
Pan/Tilt system		1

A.2 Fabrication of Seeding and Drilling Mechanism

Due to the uniqueness of the design, it was difficult to find the exact part which fits our needs. So we decided to fabricate our own parts in our machine shop. Since we already generated the fabrication datasheet from the 3D model, it got us started very quickly in machining the parts. Following is the part list that was used to create the seeding and drilling mechanism.

- 1) Right angle plate
- 2) Lexan bar
- 3) 2 12v DC motor
- 4) 1 servo motor
- 5) Lead screw – is used for translating rotational to linear motion

- 6) Nut and bolts
- 7) Steel Auger

In order to automate the function of drilling two DC motors were used, one for rotation and other motor is attached to a Lead screw for linear motion. Lead screw is used for translating rotational motion to linear motion. One of the DC motor is directly attached to the steel auger for creating a circular motion and the other is attached to the lead screw using spur gears to increase the torque. Below are some of the figures showing the actual fabricated product.

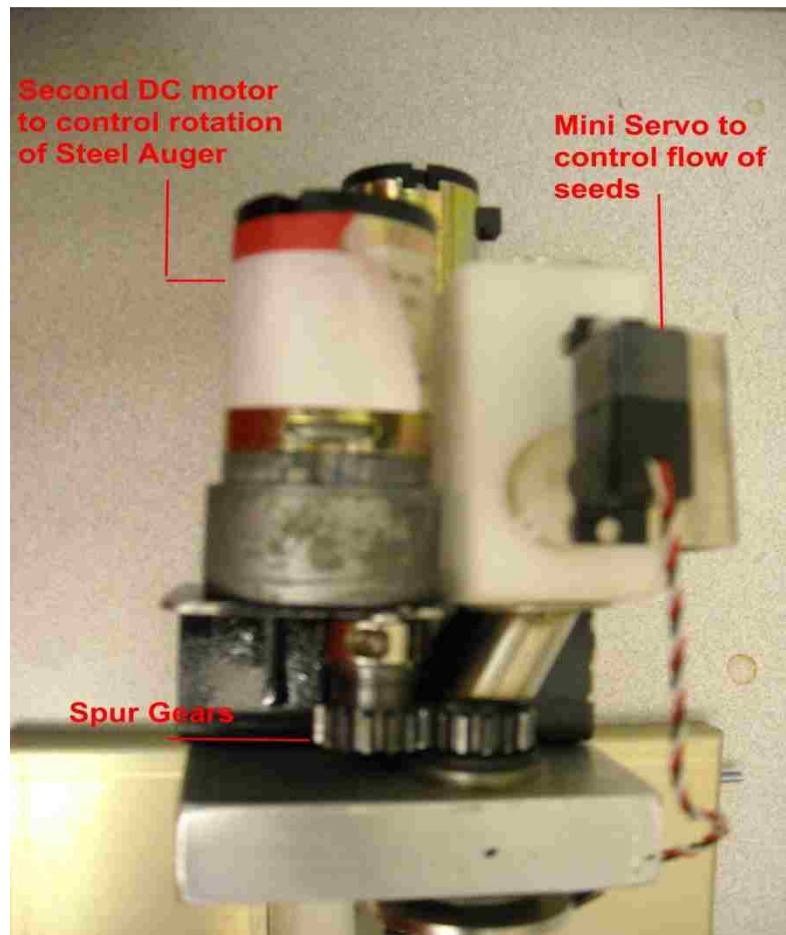


Figure A.1: Seed Hopper and DC motors of Seeding and Drilling mechanism

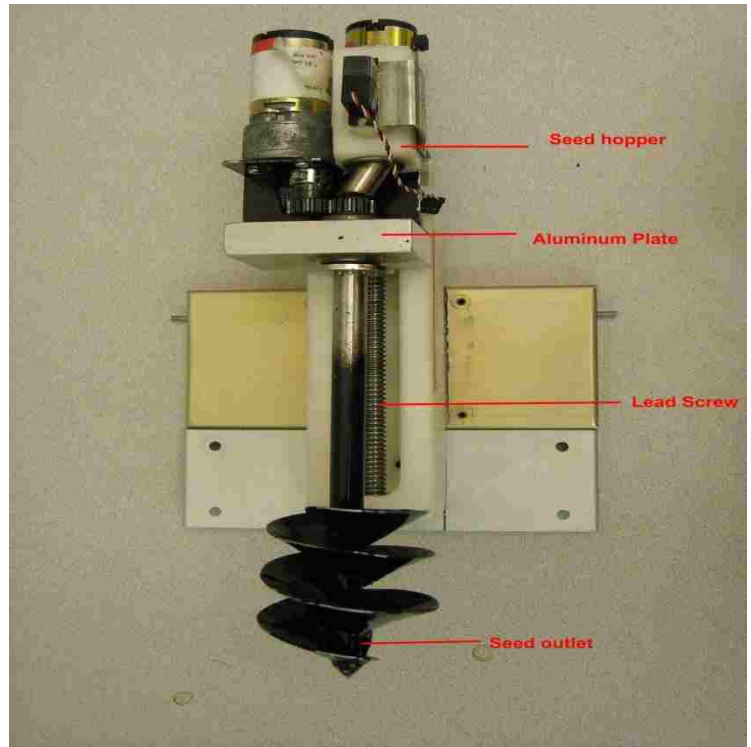


Figure A.2: Front view of Seeding and Drilling Mechanism

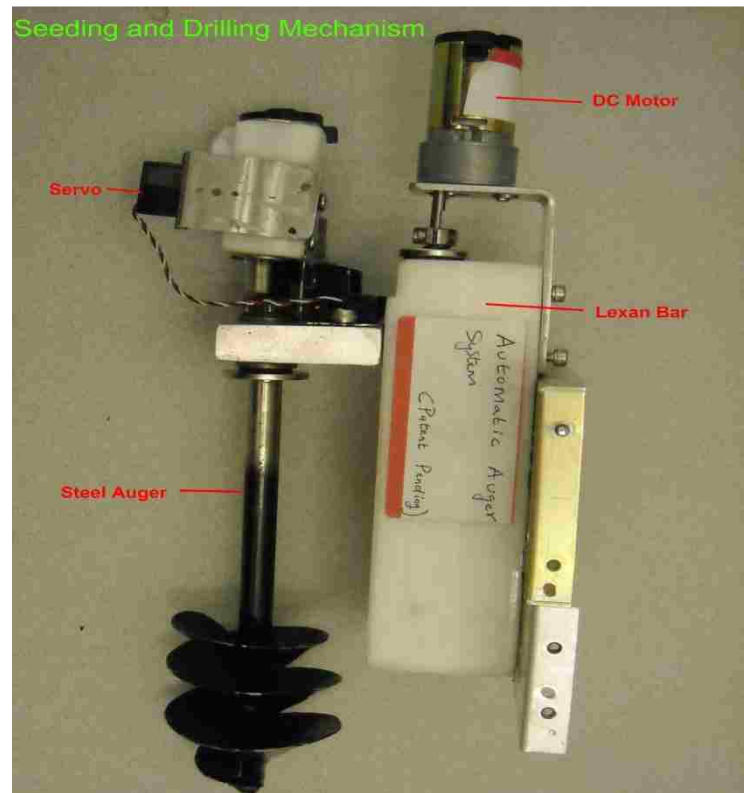


Figure A.3: Side view of Seeding and Drilling mechanism

A.3 Fabrication of Broadcast spreader system

The broadcast spreader system was quite simpler to machine than the seeding and drilling system. Broadcast spreader system consists of following parts:

- 1) Lexan Sheet
- 2) Acrylic plate
- 3) Servo motor for opening the gait of spreader system
- 4) 12v DC motor used as a spinner
- 5) L plates for mounting.

The broadcast spreader system gets attached beneath the base of robot. Due to its height of 5 inches below the base, we needed a wheel size of 14 inch diameter in order to get a clearance of 2 inches. Once the fertilizer tank, mounted on the center of the base is loaded with fertilizer the gait of the system can be opened and closed in order to allow fertilizers to pass through the opening and fall onto the spinner so that the fertilizers get spread. We can also control the speed of the spinner. Below are some of the figures of fabricated system.



Figure A.4: The spinner of Broadcast system

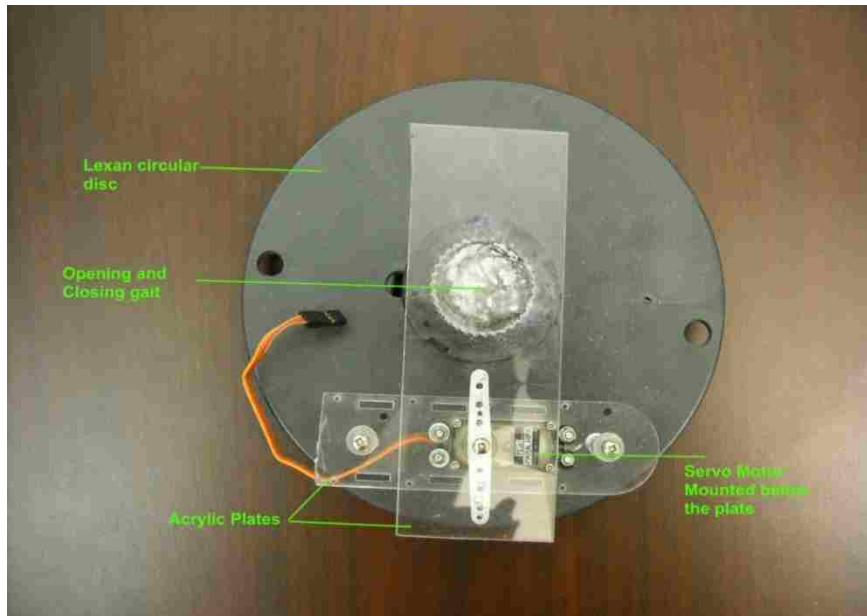


Figure A.5: The gait of Broadcast system

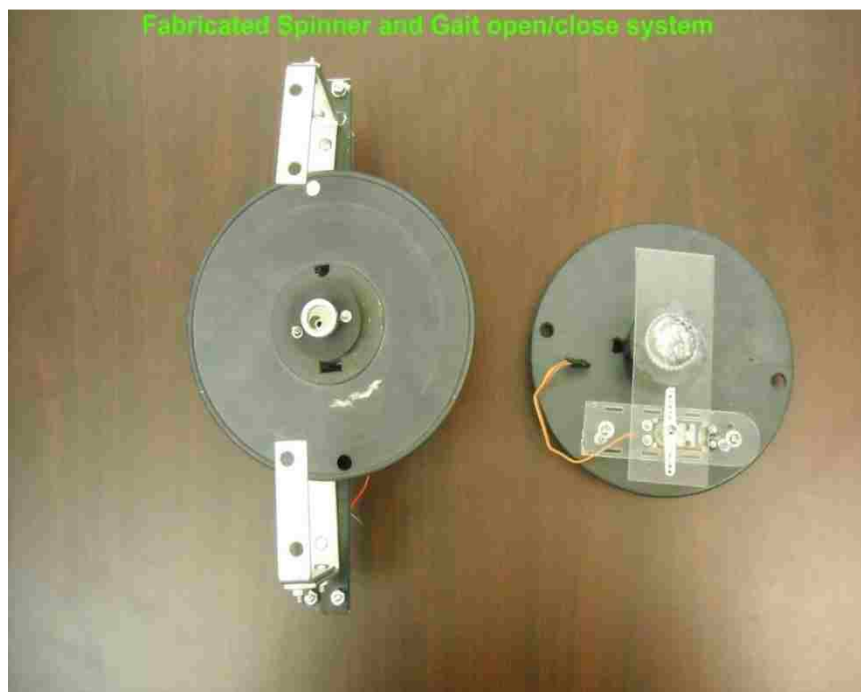


Figure A.6: The spinner and gait

A.4 Fabrication of Pan/Tilt system

Pan and tilt system was the easiest of the lot to create. The main purpose of using a pan/tilt system is

a) For Tele-operation.

b) To provide security using motion detection system as a guarding entity during night time.

Both the above functions are software oriented and discussed in later part of the thesis. The parts required to construct this system include the following,

- 1) 2 servo motor
- 2) A wireless camera
- 3) 2 aluminum L-plates
- 4) 2 U plates

Below are few figures showing the pan/tilt arrangement.

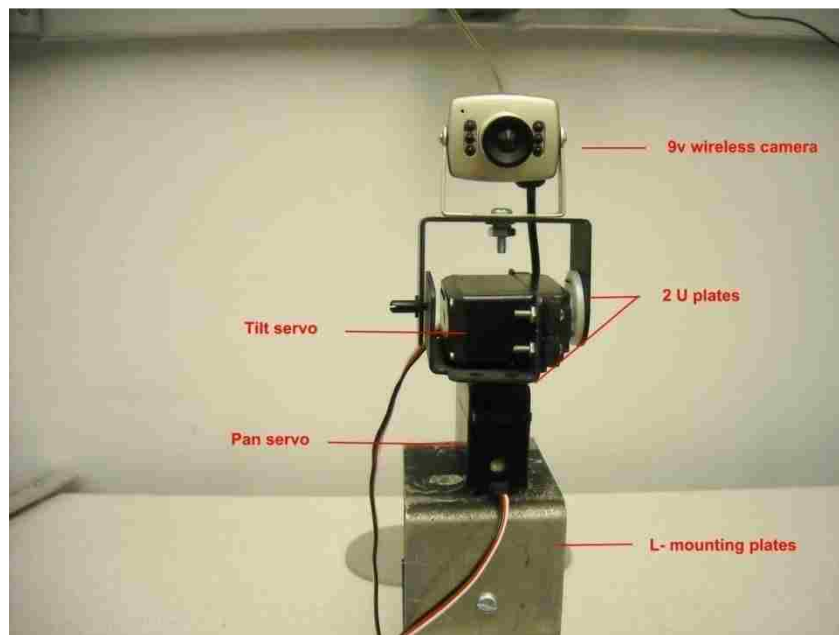


Figure A.7: Pan/Tilt system

APPENDIX B: SCHEMATICS

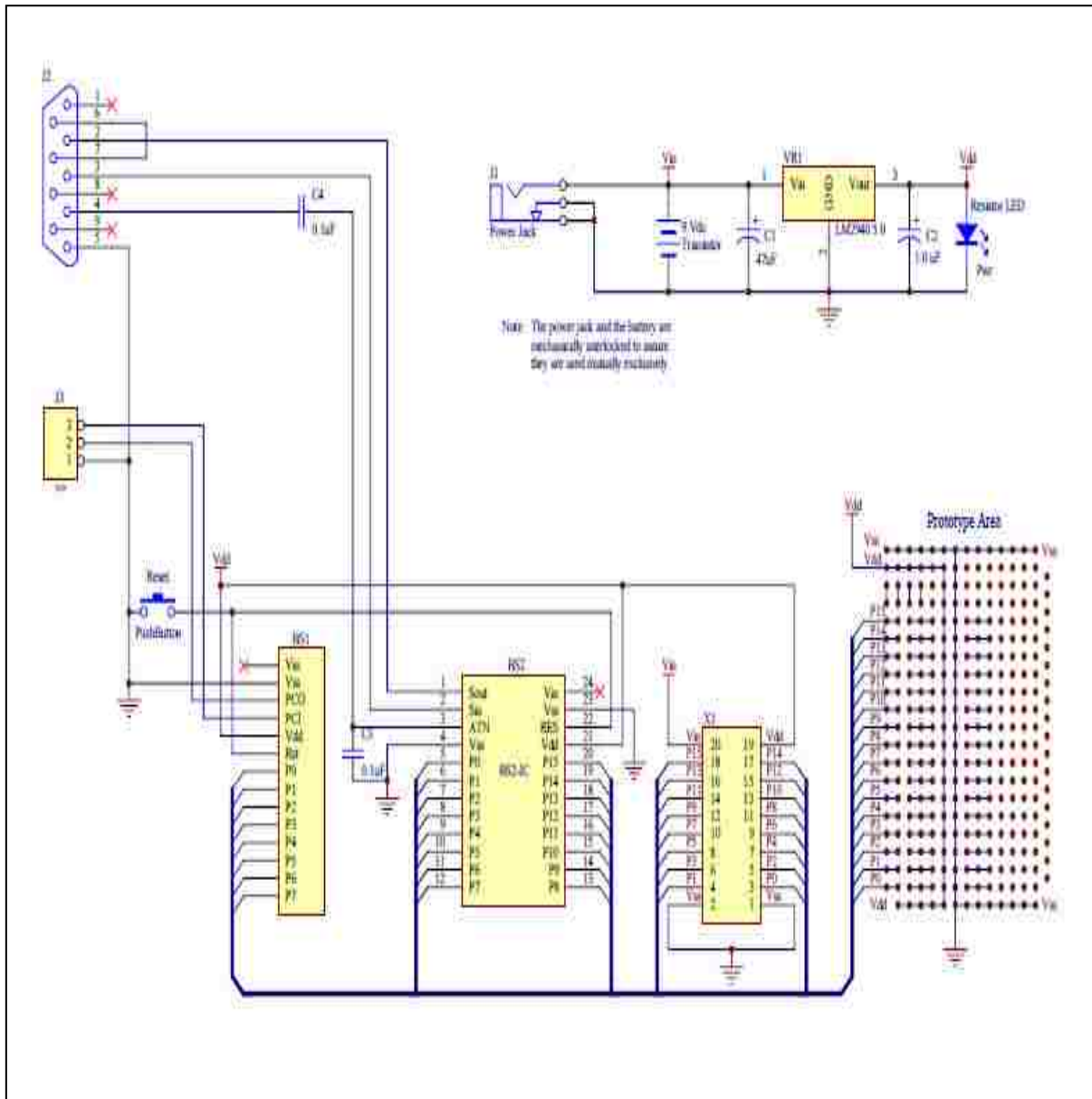


Figure B.1: Main board Schematics

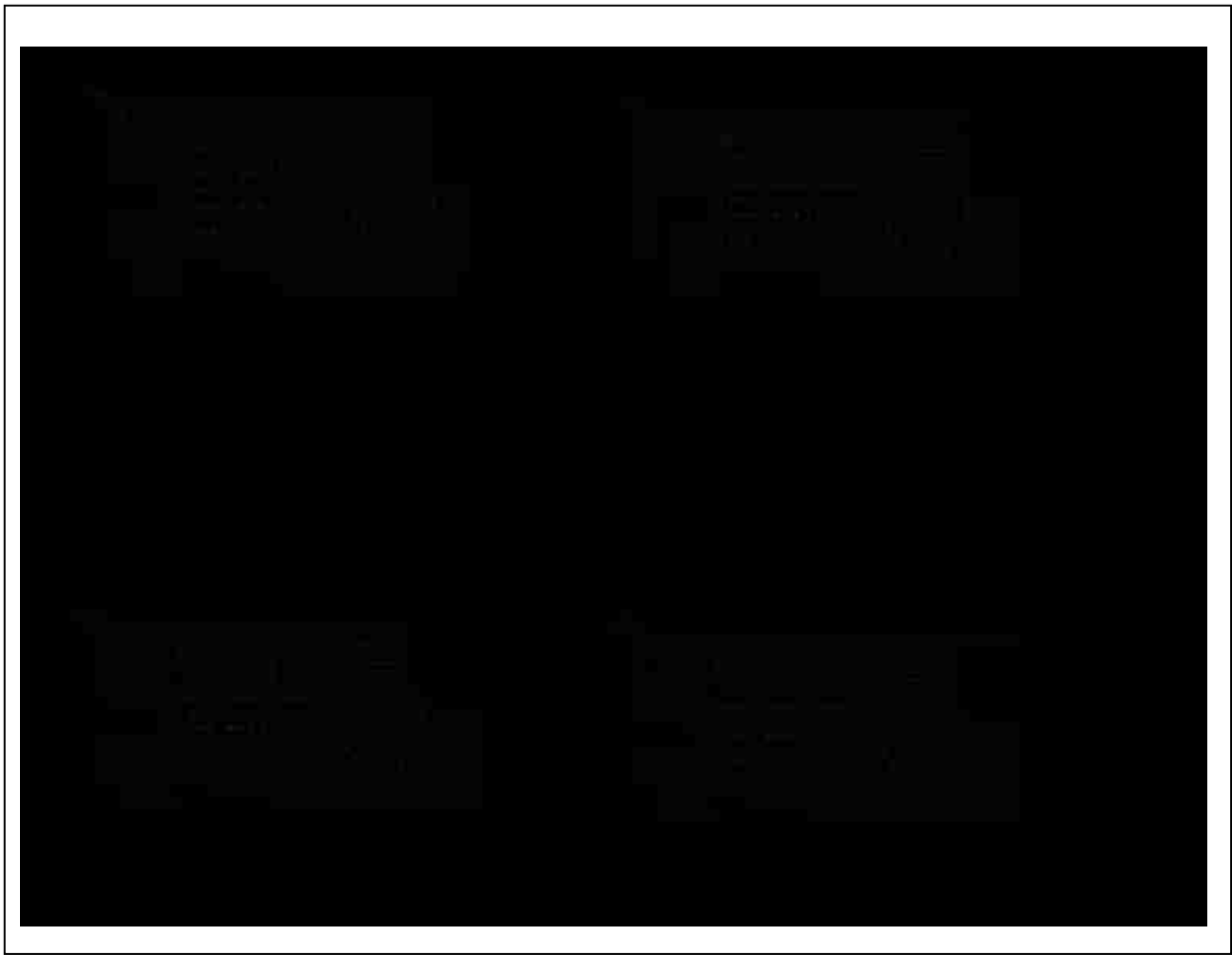


Figure B.2: Motor controller

APPENDIX C: ASSEMBLING CHR AGBOT



Figure C.1: CHR parts

The most important aspect of any robot's perfect working is its base. We call it foundation of the robot. In this thesis we have spent our bulk of time designing a base which will be strong and stable to hold all the electronics and modules of agBot. For the matter of fact we have gone to such an extreme that we tried 3 different configurations for agBot mainly,

- a) 2 Wheel drive
- b) 4 Wheel drive using 2 motors
- c) 4 Wheel drive using 4 motors

With our experimentation we have finally decided on the option c, this gives us the best stability and precision control. The base is built on a tough grade aluminum sheet have 4 strong DC motors operating at 12v and having 150 rpm with 5amp of load current. Below is the figure of our base.



Figure C.2: Top view of agBot base

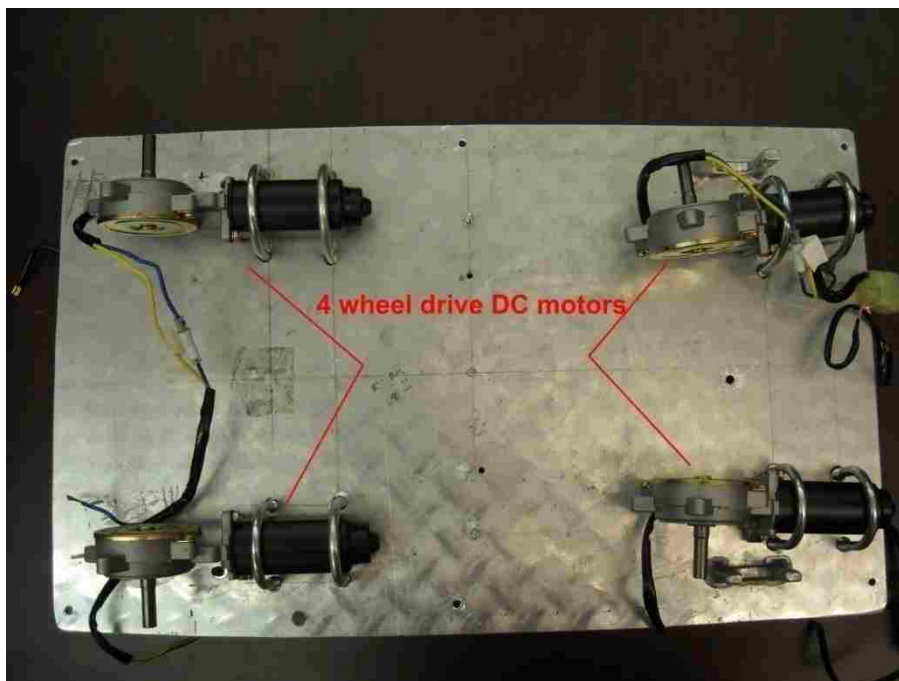


Figure C.3: Bottom view of agBot base

After the selection of base we moved onto mounting motors. The easiest way to mount the motors was to clamp it on the base using a U-clamp. Below figure shows U-clamp

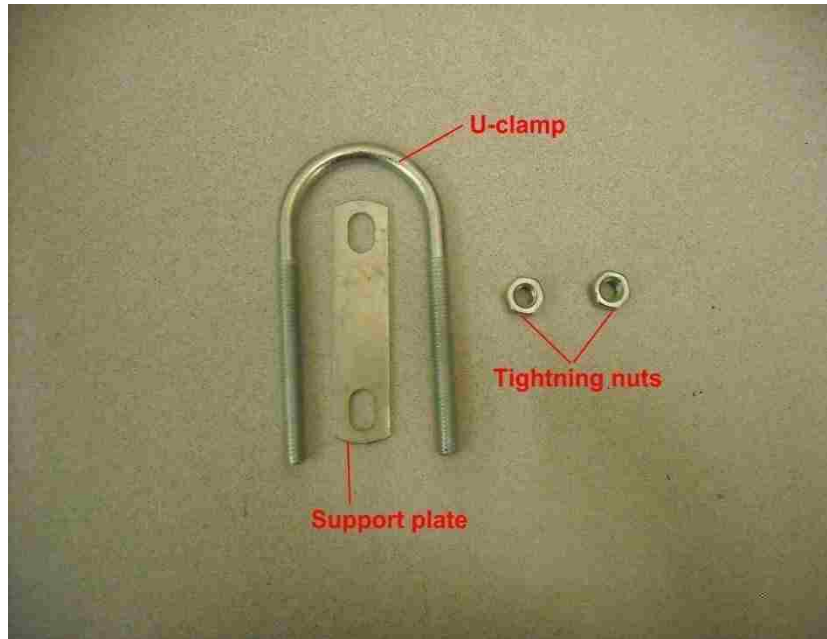


Figure C.4: U-clamp, plates and nuts

A close up view of motor mount is shown below.

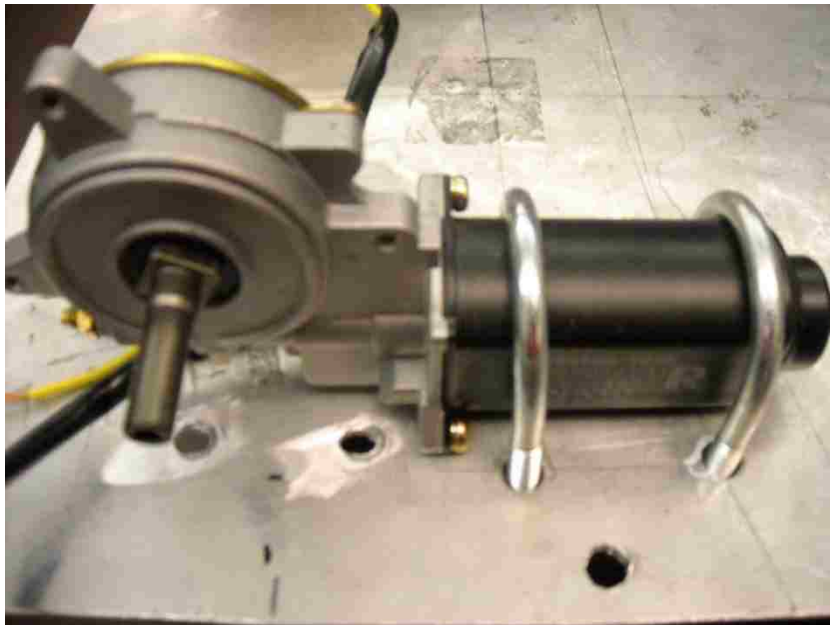


Figure C.5: Mounted motor on base

Now we come to the most difficult aspect of the entire thesis, it is mounting of large wheels on a motor shaft. First difficulty faced was, we needed a longer shaft in order to attach 14 inch

wheel. After much of investigation we found an extension which was only 2 inches in length, but we coupled that 2 inches shaft with a 5 inches threaded rod, in order to make the total length to 7 inches, which is what we required. Below figure shows the mounting process of wheels.



Figure C.6: Motor arbor



Figure C.7: Extension attached to arbor



Figure C.8: Wheel with extended shaft

Next we will attach the broadcast spreader system,

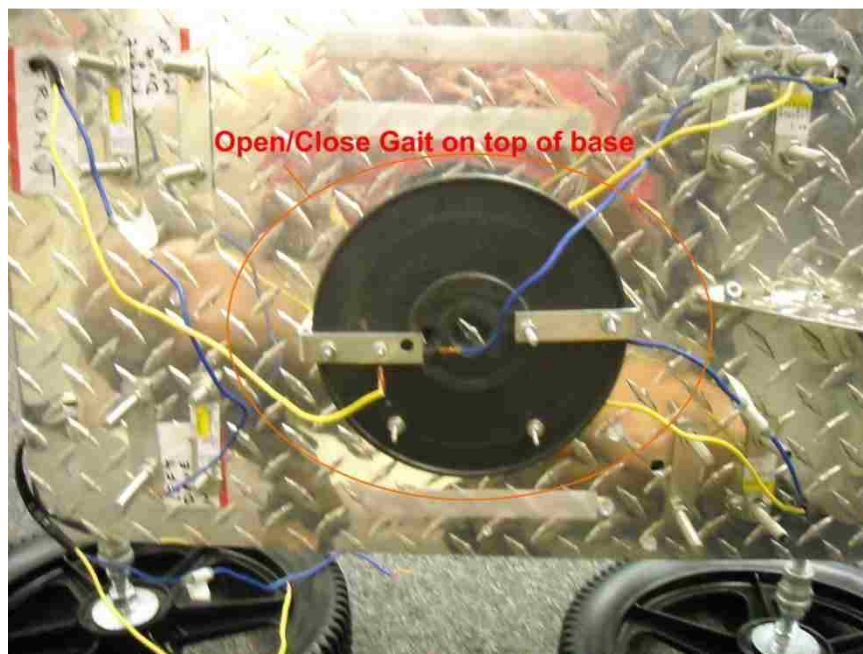


Figure C.9: Gait system of broadcast spreader

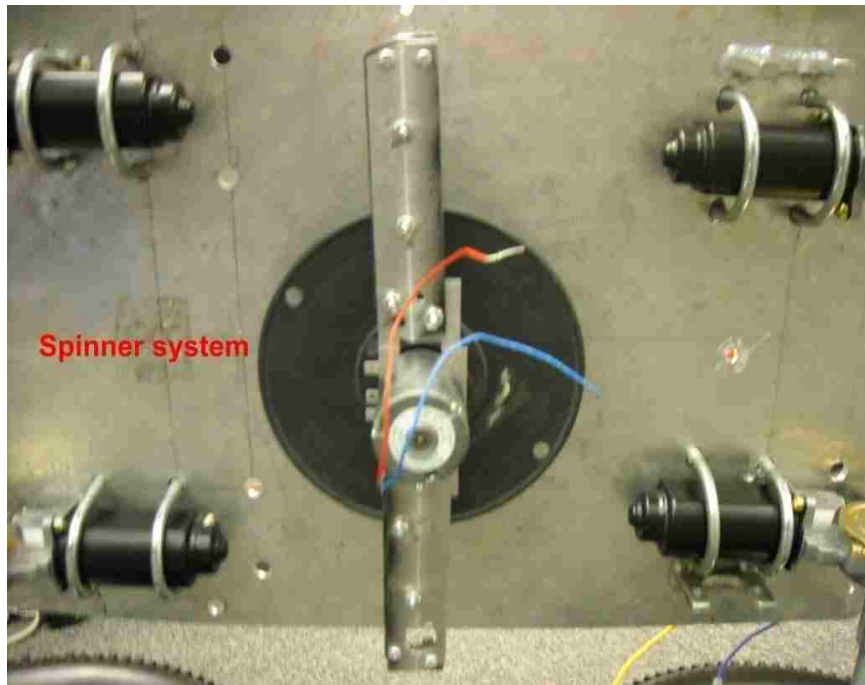


Figure C.10: Spinner system attached underneath base

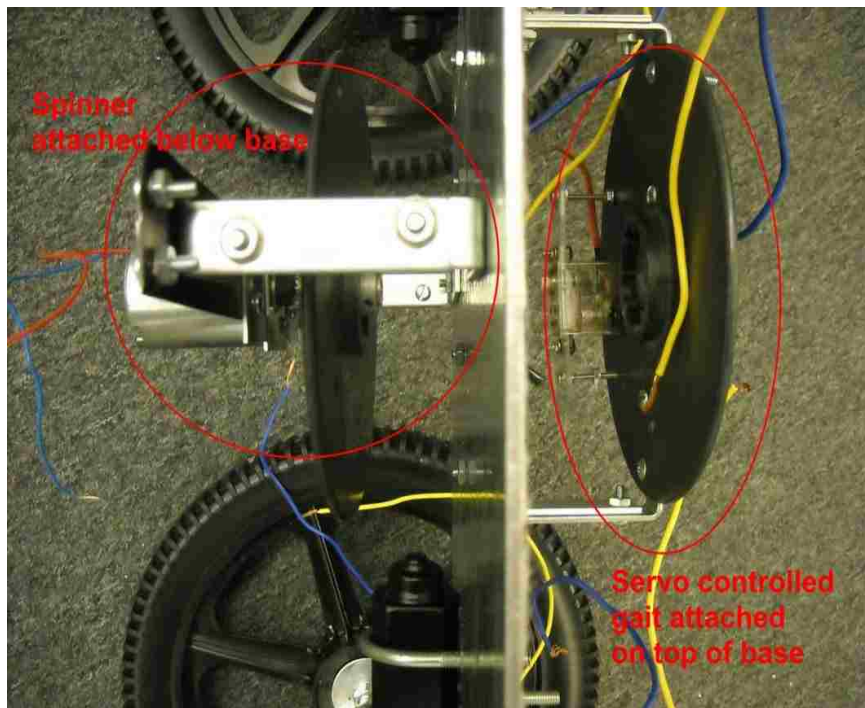


Figure C.11: Spinner and gait



Figure C.12: Fertilizer tank

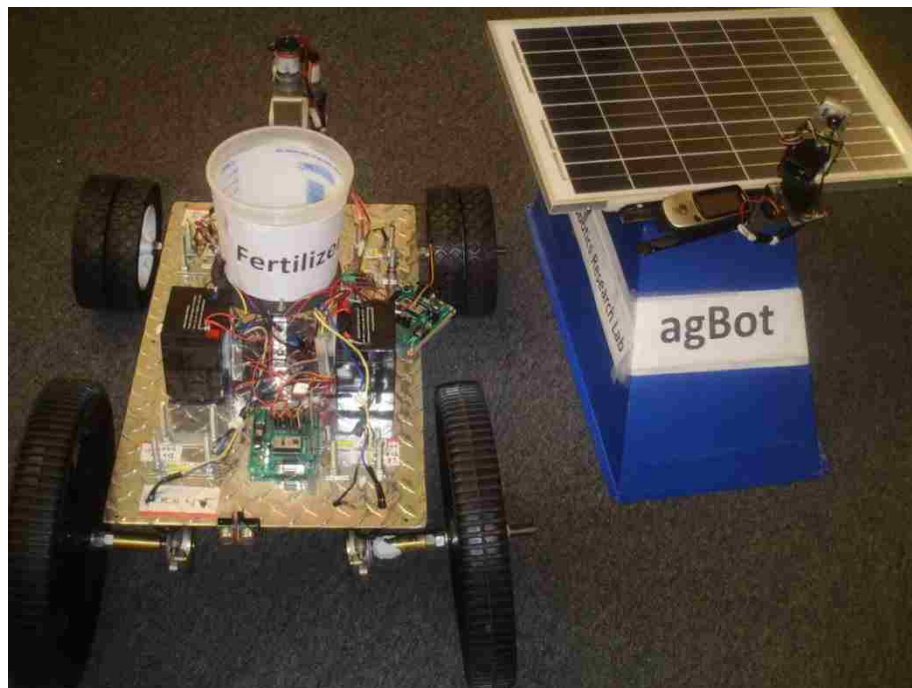


Figure C.13: agBot with installed electronics, chassis and cover

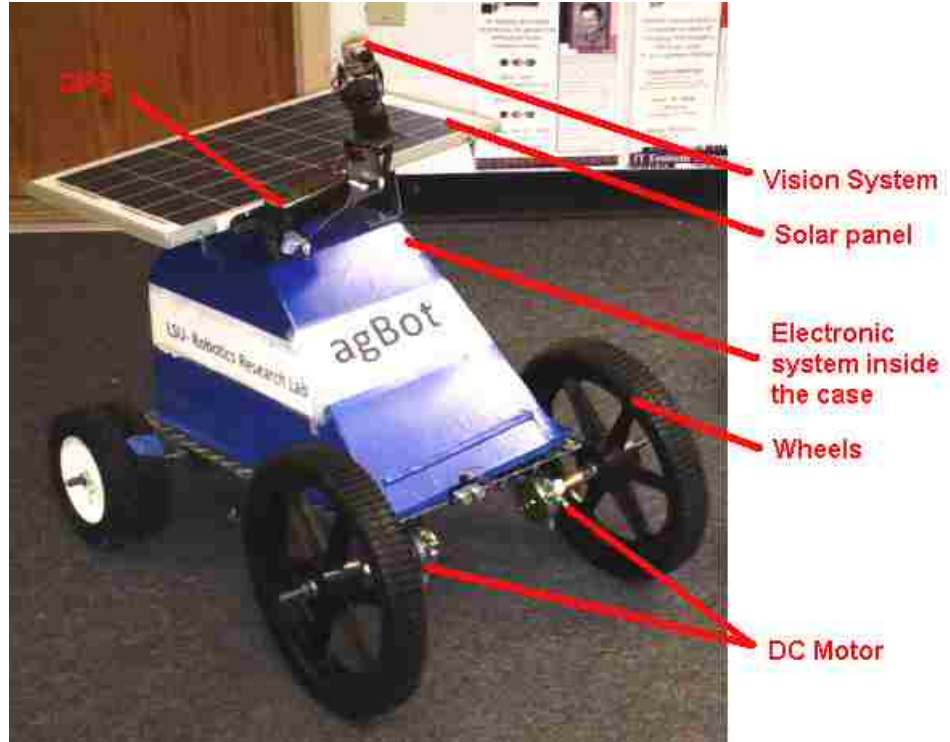


Figure C.14: Assembled agBot

APPENDIX D: SUPPLIERS AND COST

Table D.1: Suppliers and cost

Sr.No	Component	Qty	Each US\$	Totoal US\$	Supplier
1	Basic Stamp 2p	2	80	160	Parallax
2	Bluetooth-eb500	1	80	80	Parallax
3	Motor controller	2	65	130	Dimension Engineering
4	DC motor	4	15	60	Surplus store
5	Wireless camera	1	20	20	Ebay
6	GPS	1	150	150	Amazon
7	Wheels	4	15	60	Ebay
8	Solar panel	1	150	150	150
9	Batteries	2	30	60	Radioshack
10	Wires ,switch,fuse	4	3	12	Radioshack
11	Servo motor	3	10	30	Ebay
12	Aluminum	1	50	50	Lowes
13	Steel	1	20	20	Lowes
			Grand Total	\$822	

VITA

Bharat Narahari is the son of Mr. Narahari Rangarajan and Mrs. Pushpa Narahari. He was born in August 1983, in Mumbai, India. Bharat received his bachelor's degree in information technology (First Class) from University of Mumbai. He was credited for the best final year project in which he had developed an Autonomous Mobile Intelligent Robot. Before joining LSU, Bharat worked as a lecturer in K.J.Somaiya Engineering College, which was his alma mater. Bharat began his graduate studies in spring of 2007 in the Department of Computer Science under the able guidance of Dr.S.S.Iyengar and began working towards his master's thesis in the Robotics Research Lab of LSU. He completed his thesis under his mentor Dr.S.S.Iyengar, titled "Modeling and Design of Low Cost Customizable Household Robot", and will be graduating with the degree of Master of Science from LSU in December 2008. He will join the doctoral program in computer science at LSU, spring 2009.