



Hybrid Simulation Framework for Multi-hazard Testing

Elias Strepelias, Nikolaos Stathas, Xenofon Palios*, Stathis Bousias

Department of Civil Engineering, University of Patras, Patras, Greece

Email address:

ilstrepelias@upatras.gr (E. Strepelias), stathas@upatras.gr (N. Stathas), xenpal@upatras.gr (X. Palios), sbousias@upatras.gr (S. Bousias)

*Corresponding author

To cite this article:

Elias Strepelias, Nikolaos Stathas, Xenofon Palios, Stathis Bousias. Hybrid Simulation Framework for Multi-hazard Testing. *American Journal of Civil Engineering*. Vol. 8, No. 1, 2020, pp. 10-19. doi: 10.11648/j.ajce.20200801.12

Received: January 22, 2020; Accepted: February 12, 2020; Published: March 2, 2020

Abstract: The design of complicated structures which, under accidental actions, have to fulfill a certain performance level, has been a scientific challenge with social and economic implications, particularly in the field of earthquake engineering. Experimental testing on structures would shed light to the deriving issues, however the full-scaling requirements of the specimens and the most out of date existing laboratory facilities do not facilitate it. For that reason, it is generally proposed the testing structure to be decomposed in its components and the part of scientific interest can be laboratory tested, whereas the other substructures are analytically modelled. That approach is known as hybrid simulation method (HS) and lends itself as an efficient tool in unveiling the nonlinear response of structural systems, especially when testing in full-scale is sought. The present research aims to evaluate the technical aspects of implementing a robust, advanced hybrid simulation (HS) platform, based on technological advancements and combining user friendliness and effectiveness. In addition, the capabilities of the advanced platform pave the way to future research extensions towards studying multi-physics problems beyond the field of earthquake engineering. The good performance of the updated hardware configuration of the new platform was evaluated via a series of verification tests on a pinned steel cantilever column subjected to lateral loading in its elastic and inelastic response region and finally, making use of the advanced application platform as a whole, a hybrid simulation test was carried out on an industrial piping system under earthquake excitation.

Keywords: Hybrid Simulation, Substructures, Control System, Earthquake Engineering, Multi-hazard

1. Introduction

New structures are expected to satisfy the ever-increasing performance levels and any failure in satisfying their complicated functions has significant social and economic implications. New methods of construction, innovative materials and the requirements for structures' enhanced performance/quality in structural, environmental, maintenance, durability, sustainability and resilience terms, challenge modern engineering. The computational tools available fail to offer reliable models representing accurately the complicated, non-linear response of structures (e.g. cracking, residual deformation, stiffness/strength degradation, strength increase due to strain rate effects, redistribution of forces due to unforeseen actions) and it is not uncommon to see existing models being often used beyond their calibrated range of application. This is also depicted in the conservatism that characterizes present codes of practice.

Although experimental testing is expected to provide reliable answers to the aforementioned problems, its use is rather limited as existing facilities cannot cope with the increasing and varying testing needs (especially when testing at full-scale becomes necessary for avoiding the issues linked to testing scaled-down specimen), while the cost of upgrading the existing, or building new facilities is prohibitive and, in the long run, ineffective. An effective solution to the aforementioned issues is to make better use of existing testing facilities via new approaches –sub-structured testing [1]. In sub-structured testing, a structure is discretized in individual components (substructures) in such a way that numerical modelling is employed only for the sub-structures whose response is relatively well known through analytical tools (numerical substructures), while the rest sub-structure (s) are physically tested in the lab (physical substructures) [2]. The approach has been generalized and the term Hybrid Simulation (HS) method has prevailed, incorporating the many possible configurations of sub-structured testing [3-6].

2. Hybrid Simulation

2.1. Hybrid Simulation Architecture Framework

In hybrid simulation, a simulation coordinating software manages the status and the flow of information among sub-structures. In addition, it may (or may not) perform the task of numerically solving the equations describing the problem at hand (for seismic testing, the integration of the differential equations of dynamic equilibrium). The structure may be decomposed in numerical only, experimental only, or numerical and experimental sub-structures. At each loading step, the value of the target displacement to be executed is delivered to every substructure via network and the corresponding force is received as feedback. Obviously, attention has to be paid that the boundary conditions among the substructures closely represent the actual ones. For the physical substructures, servo-hydraulic actuators are employed to apply the target displacement to specimens (and return the respective reaction forces), while structural analysis software is used to return the reaction force from each numerical sub-structure [1, 5]. A schematic depicting the strategy of hybrid simulation is shown in Figure 1, where a bridge structure is discretised into its central pier (physical substructure) and its deck and two pairs of bearings (numerical substructures). This unified (numerical-experimental) approach maximizes effectiveness as it combines realism, flexibility and thrift, and making effective use of available laboratory infrastructure.

The outmost advantage of hybrid simulation comes into picture when structures need to be tested at full scale, while

available laboratory facilities usually fall short in satisfying this demand [4, 7-10]. The need for testing at full scale derives from the inability to satisfy similitude requirements for scaled models, the complicated nature of the structure [9-11] or from the strongly nonlinear nature of the response of many structures. Hybrid simulation with sub-structuring is also the method of choice in those cases that the response of a particular part of the structure is only of interest, while the rest can be satisfactorily modelled numerically.

One important asset of hybrid simulation is that discretizing the structure into a distributed system of sub-structures, the individual sub-structures (be it numerical or physical specimens) can be located at different, geographically distributed, but network-connected facilities [3, 4, 7]. Depending on the available capabilities of each facility (e.g. in-house developed software, experience in specialized numerical techniques, specific laboratory devices and facilities, capability of applying specific type of loading on specimens), each research group treats independently and with the most appropriate tools the (numerical or physical) sub-structure assigned to it. At each time step, the deformation at the interface of sub-structures is sent to be applied to every substructure and the respective reaction force is expected. Various simulation coordinator software has been developed for the implementation of hybrid simulation method: examples include, OpenFresco (Open-source Framework for Experimental Setup and Control) UI-SimCor (University of Illinois Simulation Coordinator) and ISEE (Internet-based Simulation for Earthquake Engineering).

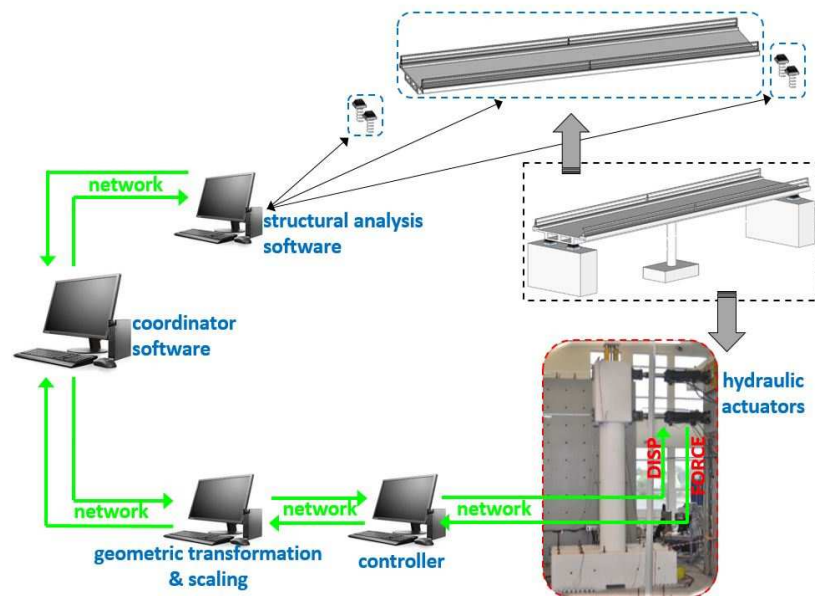

Figure 1. Schematic of application of hybrid simulation method.

2.2. Typical Issues with Existing HS Infrastructure

Even though hybrid simulation has been very efficient at the field of Earthquake Engineering [1, 2, 8, 12] (for which it was first developed), its application to other scientific fields is not

straightforward mainly due to the coupling between the different loading types applied simultaneously. Examples of such cases are fires induced to structures during or after an earthquake, the response of bridge seismic protection systems (bearings) at low temperatures, the soil-structure interaction,

the response of pressurized energy networks crossing seismic faults and wind-plus-wave loading on offshore structures.

In addition to the existent gap in theoretical knowledge for expanding HS to fields beyond earthquake engineering, application of HS presents complex technical issues and requires specialized competences. It is for this reason that the method is applied in only a limited number of facilities worldwide. As a multitude of components are employed in HS (i.e. simulation coordinator software, compatible numerical analysis software, communication protocol, servo-hydraulic control systems, etc.), the user is facing many technical issues. For widening the range of application of HS, not only users should be exempted from the overburden incurred, but further developments are necessary for expanding the application of the method to cases of different actions and their combinations /coupling thereof (e.g. earthquake and fire) [13, 14]. It is worth noting that, except for some special cases in earthquake engineering, numerical analysis software do not a priori support network communication liaising with the coordinator software and laboratory control systems (which respect certain limitations). Research groups assemble the hybrid simulation platform by selecting available tools (often developing new ones) and combining them with the control testing system in the host lab.

Additionally, most of the existing laboratory facilities either do not possess the appropriate equipment or their servo-hydraulic actuator control system is outdated or technically hard to use, consisted of custom-made electronic components lacking flexibility/capability of expansion, network communication, reliability and testing quality. The heart of the hybrid simulation platform employed so far at the Structures Laboratory (StruLab) of the University of Patras (GR), is a main (master) controller unit that can handle up to four actuator controllers (slave units). All slave units are synchronized with a timing board that sets the clock to the whole system and communicate signals from individual actuators to the master controller via dual-ram technology. All numerical computations necessary for calculating – and subsequently applying –force/displacement increments are carried out at the master controller, or in an external computer that communicates the result to the master unit via network. The main disadvantages of the existing hardware concerning the hybrid simulation platform comprise:

Extended, analog type, wiring with high noise to signal ratio that degrades the performance and the accuracy of the controller lack of inter-communication among the units controlling each actuator (slave units)

Limitation in the number of actuator control units supported by the main testing controller

Further to the above, it should also be noted that future needs will, in addition, require test execution at (near) real-time, posing additional restrictions to the hardware to be employed.

Last, but not least, flexibility requirements dictate that a next-generation HS platform should allow interaction among any combination of selected analysis software and testing hardware. Different approaches have been followed in the past:

the case-specific implementations and the generalized frameworks. In the case-specific implementations, the solution chosen is tailored to the needs of the problem at hand – this approach results in easier to handle implementation but cannot be extended to different problem cases. The direction of generalized hybrid simulation frameworks avoids case-specific solutions and can be adopted in different projects. Such frameworks include *UI-SimCor*, *OpenFresco HybridFEM* and *Mercury* developed at US, *UT-Sim* from the University of Toronto and *ISEEdb* of NCREE, Taiwan.

HS is a method with great potential that may (and will) be extended to study diverse problems in the future. Thus, a distinct characteristic for next-generation HS platform should also be the capacity to expand beyond the needs of earthquake engineering, responding to the evaluation of the broader multi-hazard/multi-physics structural performance. Examples of multi-physics phenomena include, among others, thermomechanical problems in fires following earthquakes [15, 16], structures subjected to offshore hazards (tsunamis) or offshore structures suffering sea waves and wind [9, 10, 13, 14], response of energy effective systems mounted on buildings under seismic loading [12].

The present research describes the investigation and implementation for a next generation, versatile and technically easier HS platform.

3. Development of Advanced HS Platform

The platform developed and presented in the following strives to account for the drawbacks of existing systems and satisfy future needs in structural testing. The implementation followed three distinct interventions:

- New, high-end controller and data acquisition hardware.
- New, real-time, operating software and associated controller software with advanced safety features.
- New test coordination platform.

3.1. Controller Hardware

The intended expansion of hybrid simulation method in new scientific directions requires availability of advanced tools (hardware), communication protocols and control/coordinator software creating a versatile platform to be efficient for various complicated experimental setups.

For this reason, state-of-the art components were acquired: power supply, analog input/output, digital output, loadcell and optical encoder signal conditioner etc., offering efficient support of Ethernet protocol with real time response down to I/O level (EtherCAT type), capability of high real time testing (reduction of delays), suitability for small data quantities and cost effectiveness.

Utilizing the industrial components, control units were assembled and positioned on the servo-hydraulic actuators, reducing the distance between signal sources (force, displacement, servo-valve voltage, valve on/off etc.) and point signal conditioning (amplification and AD conversion). As

can be seen in Figure 2, a single digital bus facilitates internal communication among all the actuator control units (no matter their number) and the master controller software. In the master unit, proper software performs all the computations necessary to actively control any servo-hydraulic actuator. In addition, both the control parameters of the actuators (PID parameters) and the hybrid test algorithm can be held at the same CPU and the real-time feature is ensured by an internal timing board.

The new philosophy, the capability of self-diagnosis offered by the components, the high-speed communication, the standardized industrial components and simplified cabling will relieve users from potential problems usually observed in complicated structural tests, offering many advantages:

- The adoption of standardized, certified components guarantees high level quality standards and ensures robustness and reliability characteristics even in difficult environmental conditions, such as laboratory environments vulnerable to dust and humidity conditions.
- The reduction of the distance between the analogic components and the analog-to-digital converters by mounting the control units on the servo-hydraulic actuators, offers high decrease of noise to signal ratio which is essential in obtaining accurate hybrid test results.
- A single master control unit can manage simultaneously many slave control units with no upper limit at their number that are also capable of direct communication among them, thanks to improved transfer performances of Ethernet/EtherCAT technologies.
- The simplification of the wiring system (Figure 3) between the master unit and the actuators' components – reduction to two cables only (power supply and EtherCAT bus) - improves the information transfer and acquisition procedure during the tests in a demanding laboratory environment.

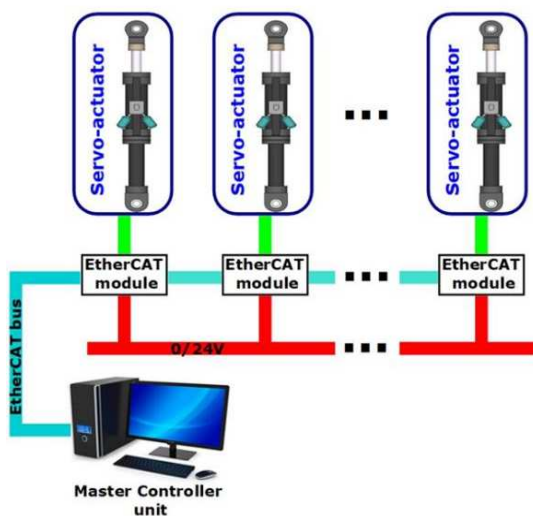

Figure 2. Schematic hardware architecture of the advanced HS application platform.

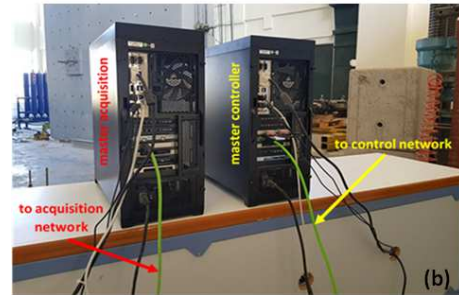
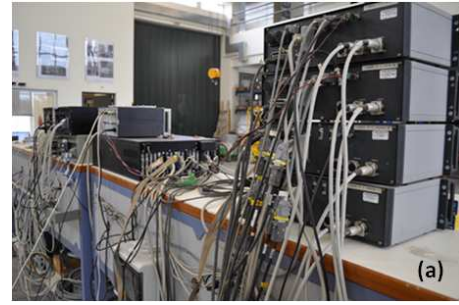

Figure 3. Typical wiring system: (a) existing HS application platform, (b) advanced HS application platform.

3.2. Operating System and Software

The real time feature is a dominant characteristic of the developed controller software and it is achieved placing the master controller software and the control software of each actuator on the same CPU. The master controller software is executed on a machine with real time operating system for multicore processors (Windows Embedded Compact) to reduce the control time step to 1ms. To enhance user-friendliness, the new master controller software was upgraded as well as the data acquisition system interface. The simulation coordinator software is not affected by the modifications mentioned above, as it treats both numerical and physical substructures as network nodes (via IP addresses). The communication between coordinating software and main controller is achieved by custom-made software (Matlab).

A significant advantage resulting from these advances is that its implementation can cope with future challenges of applying HS to fields beyond earthquake engineering: examples include testing of offshore structures (e.g. wind turbines), thermo-mechanical (fire) testing, structural testing to coastal hazards (e.g. tsunami), testing of electrical equipment (e.g. disconnect switches), structural acoustics testing, blast testing, etc. Although sound theoretical basis for all these areas of interest is still under development, the first attempts in expanding HS show that the method can be used to provide a viable way for experimentation in problems that, otherwise, require extremely difficult (if even feasible) or expensive, full scale testing of complete systems [9-18]. With its advanced, real-time operating system and communication scheme, high-fidelity components and its open architecture permitting appropriate control approaches (e.g. forward compensation) to be implemented, the updated platform can be considered as a tool ready to incorporate future theoretical developments in studying multi-physics problems via:

- a. Offshore structures testing: HS alleviates conflicts of the different scaling laws involved in representing hydrodynamic (Froude similitude) and aerodynamic (Reynolds similitude) phenomena [9, 10]. As the platform can operate at reduced control time increment (1ms), it makes it feasible to apply calculated aerodynamic forces (with Froude similitude) in near real-time to an offshore structural model that is placed in a wave-generation basin.
- b. Coastal engineering testing: perform structural testing without physically representing fluid forces (tsunami). Fluid forces are calculated and the seismic simulation HS scheme is employed, with the difference that a force-based numerical integration scheme is used [13, 14] and resulting forces are applied in real-time (RT) via a loop shaping control scheme – the latter may be programmed in a software routine that substitutes the default control scheme (PID) of the platform controller.
- c. Thermo-mechanical (fire) testing: in a performance-based approach, HS increases the accuracy of the evaluated performance by integrating a physical specimen with a structural system model. However, time scales between structural deformation and that resulting from heat transfer differ, yielding problems to HS application [15, 16, 17]. Heat transfer analysis is first performed, followed by nonlinear structural analysis for determining resulting displacements under the action of gravity loading and a temperature history for each element. The physical specimen placed in a furnace is subjected to actuator-applied displacements and a temperature history profile that is regulated by the furnace controller on the basis of the gas temperature history. While the temperature history in the numerical model and that in the furnace should be synchronized in time, discrepancies occur: as the numerical integrator proceeds to the next time step displacement calculation, the measured reaction force changes due to temperature change in the furnace and the value of the reaction force returned to the integrator at the end of the previous step (and used for calculating next displacement increment) is no longer valid. These issues have to be corrected via some error compensation scheme which, though, does not always provide a stable solution – the issue is still a subject under study.

An issue concerning numerical substructures is how to deal with the considerable computational effort required by some types of substructures, e.g. analysis of large area soil medium, heat diffusion analysis in structural elements, while ensuring that will not cause delays in the communication with the rest substructures - particularly the experimental ones being susceptible to relaxation phenomena. For such type of substructures, it is widely accepted that the numerical substructures should be held in parallel processing computational systems using open access software (e.g. Opensees-SP).

3.3. Test Synchronization Software

With flexibility and versatility being the key characteristics for a next-generation HS platform, *UT-Sim* platform was

chosen for coordinating the individual tools (numerical-experimental) selected for handling the substructure modules. Being the most recent HS platform, *UT-Sim* offers:

- a. Connection to sufficient number of software for simulating analytical substructures. Depending on the needs or the characteristics of the structure examined, *ABAQUS* (incorporating fire simulation), *OpenSees*, *VecTor*, *Zeus*, *S-Frames* as well as *Matlab*, *C++* or *Fortran*-based custom software.
- b. Time integration that can be performed either by *UT-Sim* itself or by using other modules such as *OpenSees*, *S-Frame*, *ABAQUS* and can also be performed in super-computer for systems with very high number of degrees of freedom.
- c. Standard communication protocol (TCP-IP) between modules. The *Strulab-API* script developed in the past at Structures Laboratory [3] can also be employed for the communication between the testing equipment of the laboratory and the *UT-Sim* software.
- d. Communication to controllers lacking networking capabilities: tools are provided for performing analog I/O with actuator controllers.
- e. Compatibility with different programming languages, namely *C++*, *Fortran*, *LabVIEW* and *MATLAB*, allowing future extensions.

4. Advanced Platform Verification and Application

A series of preliminary validation tests has been carried out to assess the performance of the new platform. The new controller was tested in two different cases: the first was used to test the new hardware components' performance and the second to compare the performance of the new controller to that of the existing (but well-established) control system and validate proper cooperation of the *UT-Sim* platform with the new hardware.

4.1. System Verification

The testing campaign was preceded by the calibration of a servo-hydraulic actuator using the new control system. A high-stiffness steel frame was used for the force calibration of a servohydraulic actuator along with a reference loadcell between the end of the actuator and the frame. To verify the controller under displacement control the reference load cell was removed and the actuator was commanded under a series of sinusoidal signals with different amplitude-frequency combinations. As depicted in Figure 4, no difference was observed between the reference and measured displacement (the error is very small - near the inevitable control error).

Subsequently, with the reference loadcell inserted between the stiff frame and the actuator, the latter was commanded to impose a reference load pattern which was recorded by both the actuator's and the reference loadcell. As Figure 5 shows, no hysteresis appears in the signal, a critical feature for

assuring high accuracy results.

The second series of tests was conducted on a test setup designed to compare the new control system with respect to the existing one, in terms of accuracy and stability. Despite its drawbacks, the existing system has been proven very reliable in very demanding tests in the past (hybrid simulation testing). The two control systems were compared in a linear and nonlinear range of specimen response. The experimental setup comprised a steel column that rested on a steel clevis blocked by replaceable threaded bars and subjected to lateral loading (Figure 6). Such type of connection has been proven to yield quite consistent and reproducible results [19].

The tests were conducted under displacement control by both control systems. Input comprised series of sinusoidal displacement histories of increasing amplitude and constant frequency (Figure 7a). The displacement level was selected so as the four M20 grade 8.8 threaded bars which controlled the rotation of the clevis, remained in the elastic region of response. Test results showed (Figure 7b) that the two systems exhibited the same response and, in addition, the hardware configuration of the new system yielded a much more stable force signal. The latter is essential in hybrid simulation tests, since the feedback force is used to calculate target displacement of the next step and any force measurement error would lead to errors in the calculated and subsequently in the imposed displacement.

In order to assess the new control system for a nonlinearly responding specimen, two of the M20 threaded bars were removed (Figure 8a) while the two remaining were machined to 14mm of diameter – the column was then pushed monotonically until yielding of the bars (Figure 8b). The tests were performed imposing the same displacement history by both the previous existing and the newly developed control systems, using virgin bars in each test series.

The comparison between the two force displacement curves led to the same results with the linear tests. The two control systems showed the same stable behavior (Figure 9) even in the nonlinear range – the difference in force (0.5kN) between the two tests is due to the bar replacement procedure: a change of 2mm in the lever arm between the clevis pin and the second pair of bars lead to such difference.

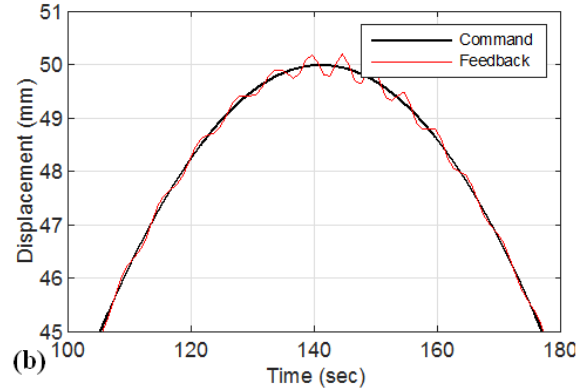
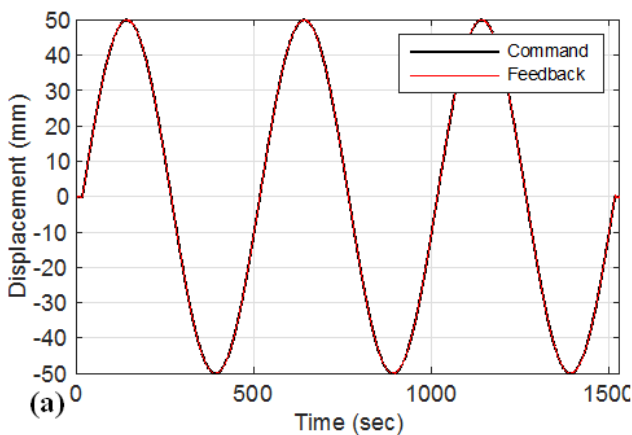

Figure 4. (a) Comparison between reference displacement and actuator's feedback, (b) comparison between reference displacement and actuator's feedback at maximum displacement.

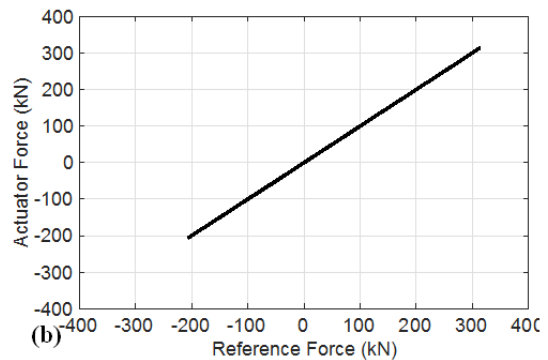
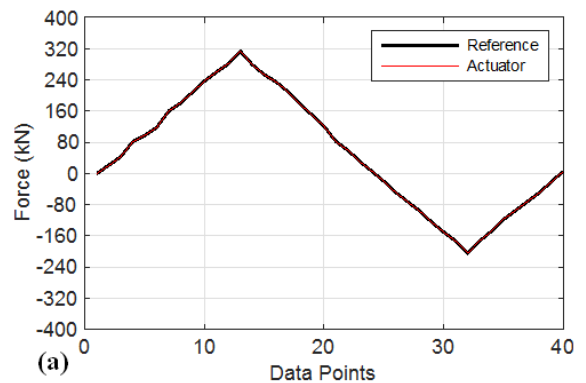

Figure 5. (a) Comparison of reference load and actuator's feedback, (b) calibration curve.

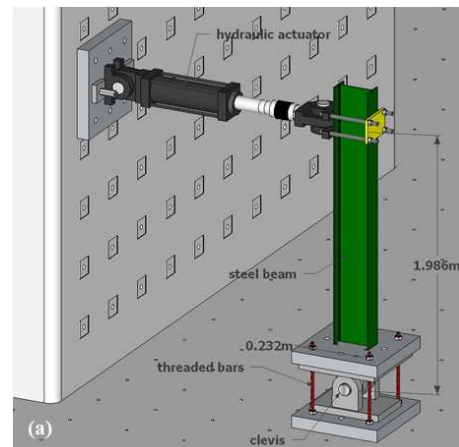



Figure 6. (a), (b) Test setup, (c) clevis connection.

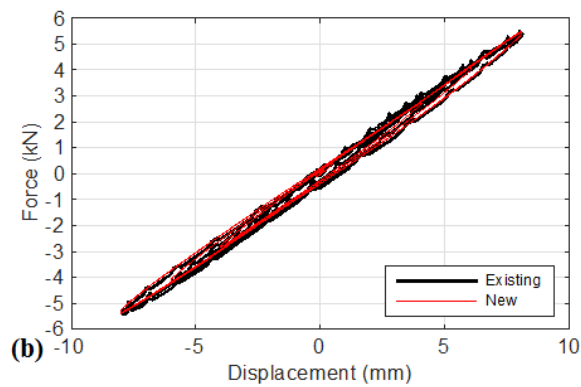
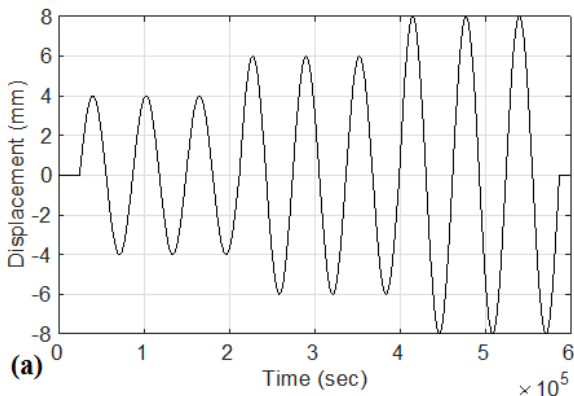

Figure 7. (a) Loading history, (b) comparison of force-displacement loops.

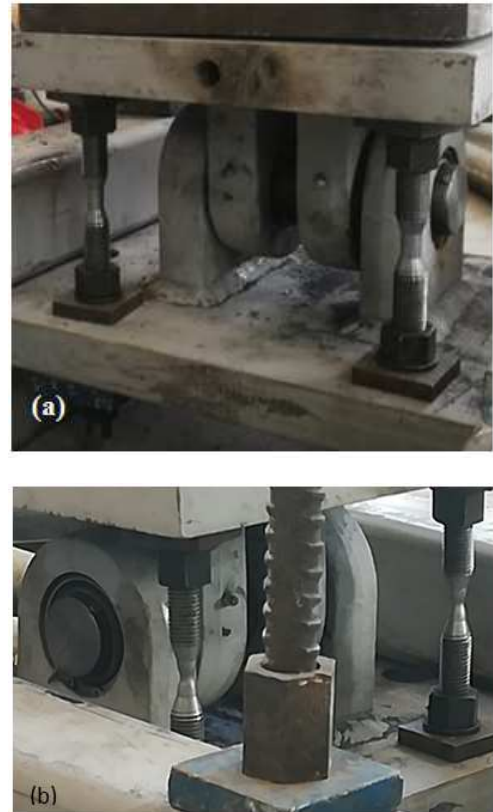

Figure 8. (a) Clevis with smoothed threaded bars, (b) yielding of the bars.

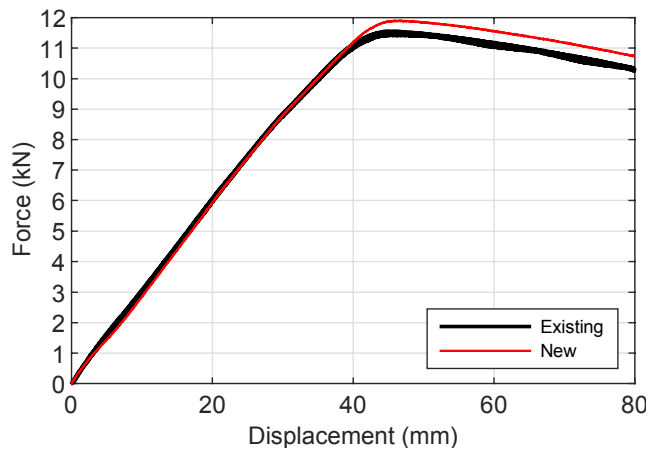

Figure 9. Force-Displacement curve under monotonic loading.

4.2. Hybrid Simulation Application

Based on the preliminary validation tests and in order to check the application platform as a whole, hybrid simulation on an industrial piping system was performed in the elastic range of response. The physical substructure consisted of a steel pipeline, part of an industrial piping system, that connects two adjacent building (numerical) infrastructures (Figure 10a). The *UT-Sim* platform was used with OpenSees analysis software performing the numerical integration. Due to the simplicity of the two connected structures (1 DOF structures) the response from the numerical substructures was provided without delays – nevertheless, for much larger problems a parallel-processing version of the same software

(OpenSees SP) could have been used (within the UT-Sim platform) for reducing eventual time delays causing force-drifting in the restoring force measured from the physical substructure.

To simplify the testing conditions and obtain a clear view of the system performance, displacements along the longitudinal piping axis was considered – thus, a supporting/guiding device fixed to laboratory strong floor was utilized (Figure 10b). The device not only supported a part of the piping system, but also restrained its deformation to all directions except for the longitudinal one. To minimize the friction effect from the clamping parts of the guiding device on the piping system (that affects the force fed back to the numerical analysis), Teflon layers were inserted between them, further sprayed with copper lubricant. To that extend, preliminary tests were carried out to ensure the performance of the new system and to investigate the effect of the clamping device on the friction level. Two cyclic tests under identical in amplitude and frequency sinusoidal displacement signals were performed (Figure 11a). During the first test the pipe was firmly clamped in the transverse direction by the guiding device, whereas the clamping parts were left loose during the second test to decrease the contribution of friction. It was shown (Figure 11b) that in the latter case, friction effect on the measured restoring force was reduced by approximately 50%.

To verify the performance of the advanced platform to a more demanding experimental test campaign, the piping system was tested via hybrid simulation under earthquake excitation. Based on the previous results, the clamping parts of the guiding device were kept loose, while care was exercised in the selection of the signal amplitude so as to keep specimen response within the elastic region. During each loading step of HS, the displacement command was first converted in analog form and then transmitted to the control software to be applied by the actuator. Upon completion of the loading ramp, the measured restoring force was communicated to the coordinating software in analog form and (after its conversion in digital form) was subsequently used in the integration module (OpenSees) to yield the displacement increment to be applied in the next loading step. Figures 12a, b show the measured force and reference/imposed displacements, respectively. The measured force signal appeared very stable (the value of the force is transferred to the coordinating software with very small error) and the new control system managed to impose the reference displacement with minimal error.

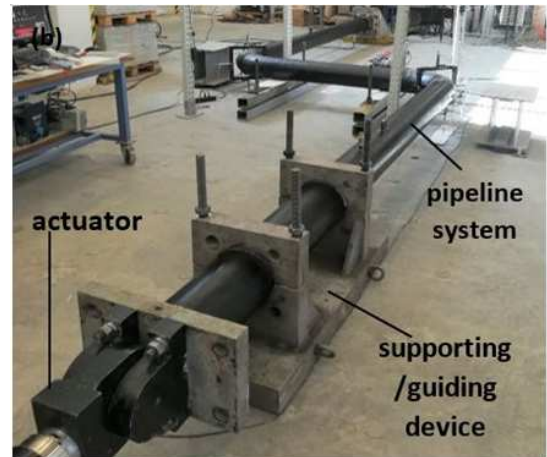

Figure 10. (a) Schematic hybrid simulation configuration, (b) Test setup.

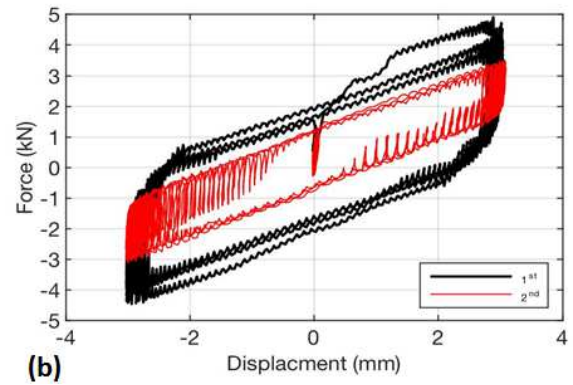
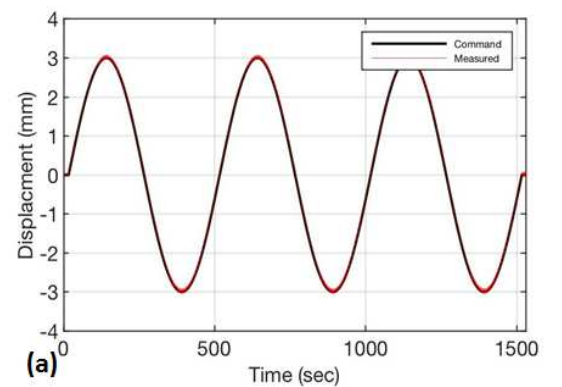
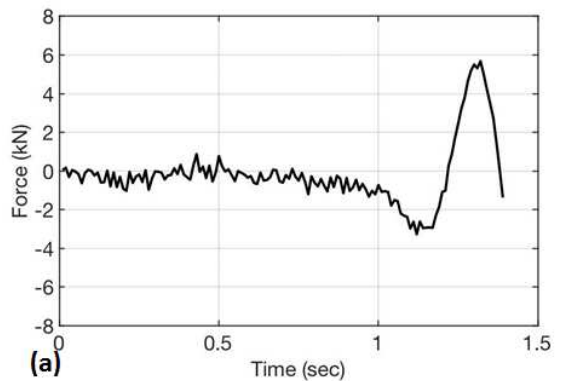
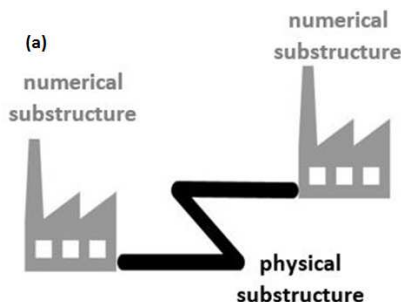

Figure 11. (a) Sinusoidal input, (b) Force – displacement loop.



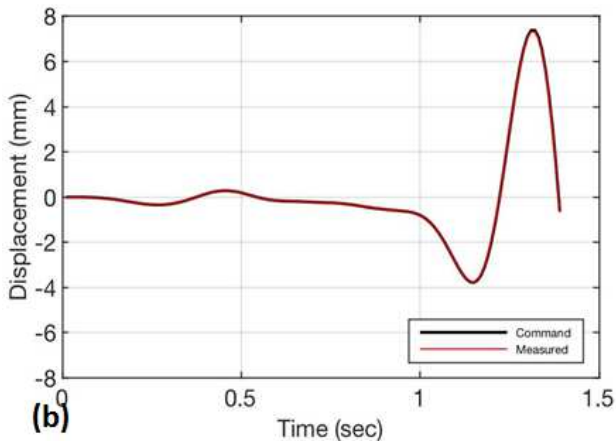

Figure 12. (a) Measured force, (b) Reference/imposed displacement.

5. Conclusions

To deeply comprehend the response of large scale, complicated structures, hybrid simulation has been widely accepted as the most appropriate tool, especially in Earthquake Engineering for which the method was initially developed and been applied for quite some time. In HS, structures are discretized in numerical and physical substructures (with the latter being the focus of research interest), so as to optimize the combined use of available reliable software and laboratory facilities. The present research aims in developing a roadmap for the expansion of hybrid simulation method in multi-physics and multi-hazard problems and in creating an application platform built by robust industrial hardware of high quality, relevant control and simulation coordinator software simplifying – to the extent possible - the use of HS and making it applicable to a wider range of problems. The benefits of developing an advanced hybrid simulation application platform, are:

- a. The capability of expanding hybrid simulation to complicated structures exposed to actions beyond seismic, combined or not (e.g. thermo-mechanical problems)
- b. The testing time step reduced to the level of nearly real-time testing, combining the communication protocol with real-time operating system and standardized modules (EtherCAT input/output modules)
- c. The enhanced reliability of HS application by using equipment based on widely approved industrial standards and modern automation technology
- d. A reliable and useful testing platform with flexible architecture and adaptability to demanding requirements:

 - e. 1) Reduction of noise to signal ratio by digitalizing the analog signal close to the signal source, an important requirement for accurate hybrid tests.
 - f. 2) Internal communication each time step among the slaves and the master units via robust digital bus.
 - g. 3) Enhanced simulation coordinator system with single way of communication and precise synchronization of the distributed units.

- h. Multi-processing computer systems - compatible with the advanced software can be used in analyzing structures of high computational effort.
- i. The simplified software architecture in combination with the latest advanced computer performances lead to improved control performances (speed, safety, quality).

The performance of the new control system was validated by conducting series of verification tests on a pinned cantilever specimen subjected to lateral load – results were then compared to those obtained by performing the same test via the existing control system. Based on the satisfactory results of the new control system verification tests, hybrid simulation on a steel pipeline setup (physical substructure) joining two adjacent building infrastructures (numerical substructures) was conducted, utilizing the developed advanced hybrid simulation platform.

The implementation of an advanced hybrid simulation application platform for large-scale structural experimental tests open to further development, will maintain the recent research activity and broaden the research interest in cutting-edge scientific fields with wide range of applications.

Acknowledgements

The research is carried out at Structures Laboratory (StruLab), Department of Civil Engineering, University of Patras, Greece and has been co-financed by the Operational Program "Human Resources Development, Education and Lifelong Learning" and is co-financed by the European Union (European Social Fund) and Greek national funds, Project "Supporting researchers with emphasis on young researchers - EDVM34". The generous advice of Dr. P. Pegon, Dr. J. Molina and Dr. M. Peroni of the ELSA lab, JRC (EU) and of Prof. O-S Kwon of the University of Toronto is greatly acknowledged.

References

- [1] Sextos A. and Bousias S., (2014) Recent advances in real time and hybrid simulation for earthquake engineering purposes. International Conference on "Computational Methods for Engineering Technology", Naples.
- [2] Palios X., Molina X., Bousias S. N. and Strepelias E., (2007) Testing rate-dependent bridge isolation devices via the pseudodynamic testing method and sub-structuring. 2nd Int Conf on Advances in Experimental Structural Engineering, Shanghai, China.
- [3] Bousias S., Kwon O-S, Evangelioiu N., Sextos, A. (2014) Implementation issues in distributed hybrid simulation. 6th World Conf. of Structural Control and Monitoring, Barcelona
- [4] Bousias S., Sextos A., Kwon O-S., Taskari O., Elnashai A. Evangelioiu N., Di Sarno L. (2017) Intercontinental Hybrid Simulation for the assessment of a three-span R/C highway overpass. Journal of Earthquake Eng., Vol. 23, No. 7, pp. 1194–1215.
- [5] Bousias S. N. (2014) Hybrid Simulation of Stiff Structures: Overview and Current Advances. Journal of Structures, Article 825692, doi: 10.1155/2014/82569.

- [6] Palios X., Strepelias E. and Bousias S. N. (2013) A novel strategy for the hybrid simulation of stiff structures. 5th International Conference on Advances in Experimental Structural Engineering (AESE), Taipei, Taiwan, November 2013.
- [7] Sextos A., Bousias S., Taskari O., Evangeliou N., Kwon O.-S., Elnashai A., DiSarno L. and Palios X., (2014) An intercontinental hybrid simulation experiment for the purposes of seismic assessment of a three-span RC bridge. 10th US Conference on Earthquake Engineering, Alaska.
- [8] Stathas N., Skafida S., Bousias S. N., Fardis M. N., Digenis S. & Palios X., (2015) Hybrid simulation of bridge pier uplifting. Bulletin of Earthquake Engineering, Special Issue: "Large scale and on-site structural testing for seismic performance assessment", 15 (8), pp. 3385-3398.
- [9] Bachynski, E., Chabaud, V. and Sauder, T. (2015) Real-time hybrid model testing of floating wind turbines: sensitivity to limited actuation. Energy Procedia 80: 2 – 12, doi: 10.1016/j.egypro.2015.11.400
- [10] Bachynski, E., Thys, M., Sauder, T., Chabaud, T., and Sæther, L-O. (2016) Real-Time Hybrid Model Testing of a Braceless Semi-Submersible Wind Turbine: Part II — Experimental Results. ASME 2016 35th International Conference on Ocean, Offshore and Arctic Engineering, Korea, 2016, <https://doi.org/10.1115/OMAE2016-54437>
- [11] Christenson, R. (2016) Real-time hybrid simulation for Marine Structures. International Workshop "Hybrid 2020 – State of-the-art and future directions for hybrid modelling and simulation", ETH.
- [12] Wang Y. L., Mosalam K. M., Günay S. and Lu W. S., (2017) Seismic response evaluation of zonal hanging curtain wall system using hybrid simulation. 16th World Conf. on Earthq. Eng., Santiago Chile, paper 1308.
- [13] Nakata N., (2015) Force-based hybrid simulation for expanding capabilities and applications to multi-hazards. EU-US-Asia workshop on hybrid testing, JRC Ispra, October 2015.
- [14] Nakata, N. (2016) Advances in Hybrid Simulation to Coastal Hazard. International Workshop "Hybrid 2020 – State of-the-art and future directions for hybrid modelling and simulation", ETH.
- [15] Wang, X., Kim, R., Kwon, O-S. and Yeo, I. (2019) Continuous Real-Time Hybrid Simulation Method for Structures Subject to Fire. Journal of Structural Engineering, Volume 145, Issue 12, [https://doi.org/10.1061/\(ASCE\)ST.1943-541X.0002436](https://doi.org/10.1061/(ASCE)ST.1943-541X.0002436).
- [16] Whyte C., Mackie K. R. and Stojadinovic B., (2016) Hybrid Simulation of thermomechanical structural response. Journal of Structural Engineering, ASCE, 142 (2).
- [17] Mosalam, K. and Gunay, S. (2014) Seismic performance evaluation of high voltage disconnect switches using real-time hybrid simulation: I. System development and validation. Earthquake Engineering and Structural Dynamics, Volume: 43, Issue: 8, p. 1205-1222, <https://doi.org/10.1002/eqe.2395>.
- [18] Sauder T. (2015) Real-time hybrid testing: envisioned applications (and challenges) in marine technology. EU-US-Asia workshop on hybrid testing, JRC Ispra, October 2015.
- [19] Rodgers, J. E. and Mahin, S. A., (2004) Effects of connection hysteretic degradation on the seismic behavior of steel moment-resisting frames. Berkeley, CA, Pacific Earthquake Engineering Research Center.