



ELSEVIER

Contents lists available at ScienceDirect

Cognitive Psychology

journal homepage: www.elsevier.com/locate/cogpsych

Frames of reference in spatial language acquisition

Anna Shusterman^a, Peggy Li^b^a Dept. of Psychology, Wesleyan University, Middletown, CT 06459, United States^b Dept. of Psychology, Harvard University, MA 02138, United States

ARTICLE INFO

Article history:

Accepted 13 June 2016

Available online 15 July 2016

Keywords:

Spatial language

Spatial language acquisition

Spatial cognition

Frames of reference

Cognitive development

Left-right

Front-back

ABSTRACT

Languages differ in how they encode spatial frames of reference. It is unknown how children acquire the particular frame-of-reference terms in their language (e.g., left/right, north/south). The present paper uses a word-learning paradigm to investigate 4-year-old English-speaking children's acquisition of such terms. In Part I, with five experiments, we contrasted children's acquisition of novel word pairs meaning left-right and north-south to examine their initial hypotheses and the relative ease of learning the meanings of these terms. Children interpreted ambiguous spatial terms as having environment-based meanings akin to north and south, and they readily learned and generalized north-south meanings. These studies provide the first direct evidence that children invoke geocentric representations in spatial language acquisition. However, the studies leave unanswered how children ultimately acquire "left" and "right." In Part II, with three more experiments, we investigated why children struggle to master body-based frame-of-reference words. Children successfully learned "left" and "right" when the novel words were systematically introduced on their own bodies and extended these words to novel (intrinsic and relative) uses; however, they had difficulty learning to talk about the left and right sides of a doll. This difficulty was paralleled in identifying the left and right sides of the doll in a non-linguistic memory task. In contrast, children had no difficulties learning to label the front and back sides of a doll. These studies begin to paint a detailed account of the acquisition of spatial terms in English, and provide insights into the origins of diverse spatial reference frames in the world's languages.

© 2016 The Authors. Published by Elsevier Inc. This is an open access article under the CC BY-NC-ND license (<http://creativecommons.org/licenses/by-nc-nd/4.0/>).

E-mail addresses: ashusterman@wesleyan.edu (A. Shusterman), pegs@wjh.harvard.edu (P. Li)

<http://dx.doi.org/10.1016/j.cogpsych.2016.06.001>

0010-0285/© 2016 The Authors. Published by Elsevier Inc.

This is an open access article under the CC BY-NC-ND license (<http://creativecommons.org/licenses/by-nc-nd/4.0/>).

1. Introduction

1.1. Background

How does language acquisition interact with conceptual development? Amid a resurgence of exploration and debate about the Whorfian hypothesis (Bloom & Keil, 2001; Boroditsky, 2003; Christie & Gentner, 2012; Gleitman & Papafragou, 2013; Pinker, 2007; Whorf, 1956; Wolff & Holmes, 2011), the domain of spatial cognition has provided fertile ground for examining language-thought interactions (e.g., Bloom, Peterson, Nadel, & Garrett, 1996; Bowerman & Choi, 2003; Dasen & Mishra, 2010; Hespos & Spelke, 2004; Hickmann & Robert, 2006; Landau, Dessoalegn, & Goldberg, 2010; Li & Gleitman, 2002; Pederson et al., 1998; Pyers, Shusterman, Senghas, Spelke, & Emmorey, 2010; Shusterman, Lee, & Spelke, 2011). The development of frame-of-reference (FoR) concepts represents one particularly interesting case study. Languages vary widely in the availability and frequency of FoR terms (Levinson, 1996, 2003; Majid, Bowerman, Kita, Haun, & Levinson, 2004; Pederson et al., 1998). For example, whereas English prefers egocentric terms (“left”, “front”) for describing small-scale tabletop arrays, some languages (e.g., Tselal, Haillom, Guugu Yimitirr) disprefer or even lack such terms and prefer geocentric (sometimes called ‘absolute’) terms instead, like “north” or “uphill”. This cross-linguistic diversity raises questions about how such concepts are acquired in the first place, and how children come to understand the terms and concepts that they will need to communicate in whichever culture they are raised.

Early philosophers (Kant, 1768) and developmental researchers (Acredolo, 1977; Piaget, 1928) argued that children’s spatial representations are primarily egocentric. In contrast to this position, the reports of cross-linguistic variation in spatial language, especially the evidence that some cultures prefer geocentric FoR, raises skepticism about the claim that children’s initial FoRs are predominantly egocentric rather than geocentric (Majid et al., 2004). Furthermore, a number of studies have indicated a correlation between the dominant FoRs in a specific language community, and the availability of FoR representations in non-verbal cognitive tasks in members of that community (Haun & Rapold, 2009; Haun, Rapold, Call, Janzen, & Levinson, 2006; Pyers et al., 2010; cf. Li, Abarbanell, Gleitman, & Papafragou, 2011), suggesting that language experience might causally influence the conceptual representation of FoRs. Collectively, these findings have raised a number of questions. First, what are the conceptual origins of these FoR representations: how robustly are they represented in children prior to substantial input from their culture and language? Second, how does experience with language and culture interact with early-arising conceptual representations?

The current studies investigate children’s ability to learn frames of reference words, using a novel-word training paradigm, in order to begin to address these questions about language acquisition and conceptual abilities in the spatial domain. To set up our study, we must first introduce some terminology regarding the range of reference frames that are discussed in previous literature and characterize the cross-linguistic variations that appear in the world’s languages.

1.2. Frames of reference

1.2.1. Defining entities and coordinate axes

We use spatial language every day, but we do not normally think about the different types of spatial expressions available to us. Consider a child hearing a novel spatial expression for the first time (“The apple is ZIV of the doll”). The child could attribute numerous meanings to the novel spatial word “ZIV.” For example, the speaker could mean the apple is to the north of the doll. In this case, the speaker would be using an *environment-based* (or *geocentric*) frame of reference, where she is describing the relationship between the doll and the apple using a constant fixture of the environment (e.g., the North Pole). Alternatively, the speaker could describe the position of the doll using an expression with an *object-centric* frame of reference, where the meanings of the expressions depend on the orientation of an object not anchored to earth (e.g., the doll or the speaker).

In essence, frame-of-reference (FoR) concepts are abstract mental structures—coordinate frameworks that organize a set of spatial relations. These coordinate frameworks can be derived from

any entity or set of entities in the world onto which axes may be imposed. As can be seen from the examples above, the entities providing the axes can be stationary entities anchored to earth (environment-based or geocentric FoR) or entities that move freely relative to the earth (object-centric FoR). The distinction between geocentric and object-centric FoR is a natural one, given by the physical world in which we reside.

Within the object-centric FoR, researchers further distinguish between *egocentric* frames (one's own left) and *non-egocentric* object frames (e.g., some other girl's left, the ship's left). Traditionally cognitive psychologists single out the egocentric FoR as privileged because, as this FoR relates to the self and specifically to one's own body, it underlies how we receive sensory information from the world and specify our muscular actions. They refer to all other frames as *allocentric*, or other-centered. Environment-based FoRs, such as rooms, buildings, and local terrain, are also *allocentric*, but they are defined over stable areas fixed to the earth rather than moveable objects, and they provide axes such as *window-side/wall-side*, *front/back*, and *uphill/downhill*. In sum, FoRs can be divided into three distinct categories: egocentric object-based, non-egocentric object-based, and environment-based (see Fig. 1; Newcombe & Huttenlocher, 2000; Shusterman & Li, 2016).

1.2.2. Scope, extension, translation, rotation, and primariness

In addition to the entities that define the coordinate axes, there are other considerations on how to apply the FoR terms. First, FoRs can vary in their **scope** – the scale of space to which they apply. For example, terms like *north* and *south* take the whole earth as their scope, while terms like *uptown* and *downtown* in Manhattan are limited to the island. In principle, all coordinate axes can be used to cover a wide region of space. For instance, terms like *left* and *right* can be used to refer to the left and right sides of a person's body, limiting their scope to the body. They can also be used to refer to other objects, not only immediately off to the left and right sides of the person (e.g., the box to the person's left), but also of locations miles away from the person; for example, San Francisco's Golden Gate Bridge is to the left of a person standing on Constitutional Avenue and facing the White House in Washington, DC. In practice, however, the scope is often restricted and often depends on the FoR. Locating the Golden Gate Bridge using the reference frame of a person or even a building in a faraway city, such as Washington, DC, is oftentimes not useful or even sensible since such relations may be difficult to compute (Brockmole & Wang, 2005). Besides computational difficulty, other practical matters may also limit the scope. For instance, to reduce communicative confusion, geocentric terms such as *uptown* and *downtown* may be limited to within the town or city, rather than extending beyond it to other adjacent towns or cities. Manhattanites' *uptown/downtown* may be such an example, and it contrasts with Tzeltal Mayans' *uphill/downhill* which they allow to refer to directions even when off the mountain that defined those terms (Brown & Levinson, 1993). The scope covered may thereby also be a matter of agreed upon convention and negotiations that resulted in successful communication.

From the above discussion of scope, one can see that spatial terms are not limited to the area within the borders of the defining entities. That is, "left" does not just mean a certain side of one's body; rather, "left" means the direction of the axes set up by one's body (i.e., a leftward direction). Similarly, "uphill" in Tzeltal does not just label locations on the hill, but is used to define directions even when off the mountain. We call the problem of deciding how to apply scope to a frame of reference the problem of **extension or projection**.

Furthermore, the axes set up by one's body can be applied onto another object. In the example "the cup is to the left of the saucer," the saucer is a circular object that does not itself provide a left-right axis. The speaker's left-right axis is imposed onto the saucer, which serves as the ground in the spatial relation. We call this the problem of **translation** because the left-right relation is defined by transferring the center of the body's coordinate axes a certain distance, without rotation, to the new ground object.

In addition to translation is the problem of **rotation**. Object-centered FoR terms like "left" can refer not just to the axis set up by one's own body, but the left of any other entity. Thus, the left-right axes of other entities may be rotated with respect to the speaker's own left and right. For example, the left-right axis of a listener who is facing the speaker is rotated 180° with respect to the speaker such that the speaker's right is the listener's left.

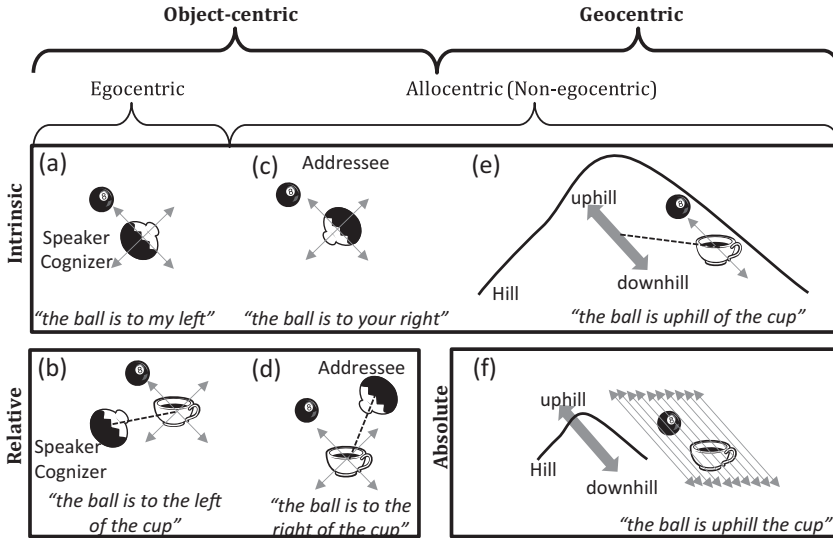

Fig. 1. Relationship between different FoR classifications. Object-centric vs. geocentric divide FoRs into those anchored (e and f) vs. not anchored (a–d) to earth. Egocentric picks out FoRs from one's own perspective (a and b) and treats all others as allocentric (c–f). For the relative, intrinsic, absolute tripartite typology, relative vs. intrinsic differ in whether the ground object is a distinct entity from the one contributing the axis (b and d) or the same entity (a and c). Intrinsic vs. absolute differ in whether the axis is bounded locally (e) or extends indefinitely (f).

Finally, we may want to consider the **primariness** of the coordinate axis – whether the coordinate axis is *primary* or *secondary*. By definition, a *secondary* axis is defined with respect to another (i.e., primary) axis. For example, because the left and right sides of a body are symmetrical, what gets labeled as the “left” or “right” depends upon what is front and back. The left-right axis is thereby secondary to the front-back axis. We generally have the intuition that learning “left” and “right” is difficult; indeed, some languages lack such terms and refer to objects to one’s left or right sides undifferentially (e.g., simply as “to your side”; Levinson, 2003; Svorou, 1994). However, it is also curiously the case that geocentric FoRs sometimes lack differentiating terms for opposing directions on the secondary axis (e.g., *crosshill* for Tselal Mayans, and *crossdown* in Manhattanites). This observation is consistent with the possibility that it is cognitively more taxing to differentiate the two sides of an axis on the basis of another axis, and such differentiation may be less successful communicatively, especially if no features distinguish the two sides, and subsequently less likely to be adopted and conventionalized into the language.¹ After all, the addressee needs to be aware of the words’ relation to the primary axis in order to learn their meanings.

1.2.3. Relative, intrinsic, and absolute

Surveying over twenty languages, Levinson and colleagues from the Max Planck Institute at Nijmegen suggested that the FoRs in the world’s languages can be categorized into three types—*relative*, *intrinsic*, and *absolute*. They further showed that languages vary according to which of the three types is preferred or available. Notably, Levinson’s tripartite taxonomy is cross-cutting to the one we described above involving egocentric vs. non-egocentric object-centric FoRs (see Fig. 1 for a schematic comparison of the taxonomies). This alternative taxonomy characterizes the relations between a *figure* object (i.e., the entity to be located) and a *ground* object (i.e., the reference entity) via a

¹ To differentiate the axis roughly orthogonal to the primary axis of “uphill/downhill” or “uptown/downtown”, Tselal Mayans use “sunset/sunrise” and Manhattanites use “East/West”, terms that are unrelated to the primary axis but distinguishable from features in the environment.

viewpoint/coordinate (i.e., the entity that defines the coordinate system). *Intrinsic* frames (e.g., “The cup is to the left of me”) consist of binary relations, involving a figure (cup) and a ground/viewpoint, where the ground (me) is the source of the viewpoint (my left). *Relative* frames (e.g., “The cup is to the left of the saucer”) consist of ternary relations, where the relation between the figure (cup) and ground (saucer) is specified by a third party’s viewpoint (e.g., speaker’s left or addressee’s left). Thus, *relative* frames expand the instances covered by the *intrinsic* frames by allowing the ground to be another entity besides the one that defines the coordinate system. Finally, *absolute* frames are reserved for relating the figure to the ground via the viewpoint of an environment-based frame. However, in order to qualify as an absolute frame, the region of space covered by the frame must be infinite. Therefore, environment-based FoRs with scope restrictions (like Manhattan uptown–downtown example) are classified by Levinson as intrinsic, not absolute.

This taxonomy has received validation from cross-linguistic studies because the typing of languages leads to consistent patterns (e.g., all languages have intrinsic FoRs, but only some have relative FoRs). One possibility for explaining why some languages never develop relative frames of reference is that reasoning about relative frames of reference requires its learner or speaker to make a big conceptual leap from intrinsic frames of reference, and hence relative expressions do not surface in all the worlds’ languages.

Another possibility, separate from difficulties in computing relative frames of reference, is that adding relative frame of reference expressions to a language introduces ambiguities (see also Janzen, Haun, & Levinson, 2012). For instance, in a language that exclusively uses intrinsic frames of reference and lacks relative frames of reference, the expression “the ball is to the right of the girl” is unambiguous: the ball is on the side of the girl determined by the right side of her body since the girl has to be the source of the coordinate axis. However, in a language with the relative frame of reference, such an expression could be ambiguous between the intrinsic meaning and the relative one (the girl’s right or someone else’s right). To reduce miscommunication and ambiguity, perhaps it is simpler if languages do not make use of relative frame of reference expressions when intrinsic or geocentric frames of reference are available, sufficient, and unambiguous for indicating directions and locating objects.

We might also expect that communities are driven to develop conventions to reduce the ambiguity when using relative frames of reference. For example, some languages might always use the speakers’ perspective in relating the figure to the ground, while others might make use of the perspective of an imaginary listener who is facing the speaker to relate the figure to the ground (Levinson, 2003; see Fig. 2 for example). Sometimes the developed conventions differ depending on the particular coordinate axes (front-back vs. left-right). These various instantiations can be seen in languages such as Hausa, Tamil, and English when these languages locate a figure relative to a non-fronted object (i.e., an object that has no front, such as a ball; Fig. 2e). In Hausa, one can think of the coordinate system of the speaker being projected onto the ball to determine front-back and left-right (Fig. 2a). In Tamil, one can think of the coordinate system as being rotated onto the ball so that the front-back and left-right relation is from the perspective of someone imaginary facing the speaker (Fig. 2b). In English, determining left-right is a direct projection just like in Hausa, but determining front-back is a rotation like Tamil (Fig. 2c). Our experiments will explore which instantiation is preferred by children.

As elegant as Levinson’s taxonomy is at capturing cross-linguistic patterns, the taxonomy disregards some distinctions that may be relevant for understanding the acquisition of FoRs in children. For example, the *intrinsic* category under Levinson’s taxonomy applies both to body-based terms and to larger FoRs such as a building or a room (e.g., door side, window side), contrasting with cardinal directions (north, south). However, it is possible that children would treat the intrinsic FoR of their own body differently from the intrinsic FoR of a room. Furthermore, Levinson’s body-based intrinsic FoR does not distinguish between egocentric and non-egocentric (“to my right” vs. “to his right”), which is also likely to affect the ease with which these uses are initially acquired. Thus, for purposes of understanding children’s acquisition of spatial reference frames, we consider (1) which *entities* children can conceive as the source of a coordinate framework, (2) the *scope* to which they are willing to apply this framework, and (3) the *flexibility* of their application of the FoR terms to novel situations. In the following section, we review past empirical work on children’s acquisition of such terms.

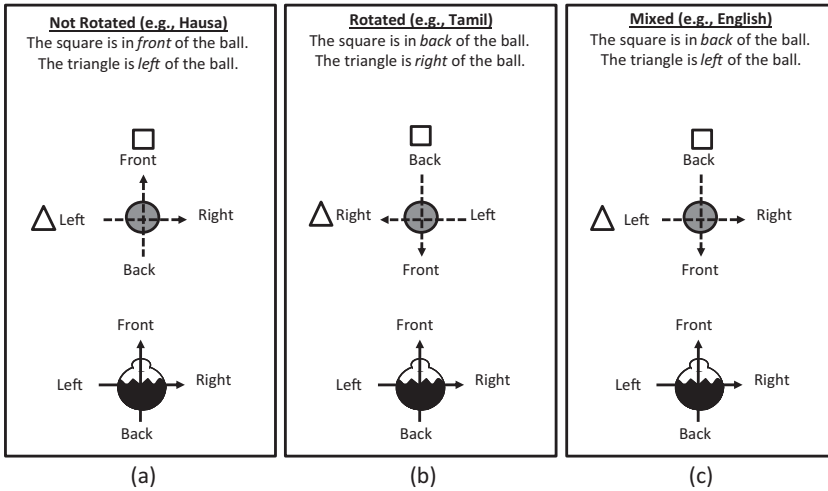

Fig. 2. Relative languages develop different conventions to resolve ambiguities. Languages may differ in whether the coordinates of the speaker are translated onto the ground object with (b) or without (a) rotation. Sometimes rotation varies across axes within a language (c).

1.3. Developmental origins of spatial frame-of-reference concepts

Where do FoR concepts come from? One possibility is that spatial representations might be linguistically or culturally derived, with children growing up in an absolute-language speaking community learning one set of spatial concepts and children growing up in a relative-language community learning another. On this view, children may need to construct conceptual representations of space in a slow, effortful, and language-dependent manner from cultural and linguistic input in their communities (Bowerman & Choi, 2003; Brown & Levinson, 2000; de León, 2001; Levinson, 2001).

Evidence for the language-dependent and effortful view of language acquisition comes from previous observational studies on the acquisition of frame-of-reference terms. On the basis of children learning relative languages, Piaget argued that children first apply spatial terms to their own bodies. However, children acquiring absolute languages do not show this pattern (Brown & Levinson, 2000; de León, 1994, 1995). In fact, language-specific developmental trajectories are evident quite early in the acquisition process. In Brown and Levinson's description of the acquisition of absolute spatial reference terms in Tselal, 2-year-olds know the words "uphill" and "downhill" as places, but do not use them relationally. By 3;6, productive relational use of these terms in constructions like "X is uphill of Y" is observed in speech samples. It is not until 7 or 8 that Tselal speaking children are as successful as adults at giving spatial commands to others for manipulating tabletop objects (Brown & Levinson, 2000; for characterizations of spatial language acquisition in other absolute languages, see de León, 1994, 1995).

Studies exploring the acquisition of relative spatial terms in children learning a relative language reveal a similar pattern of partial early acquisition followed by protracted elaboration that lasts several years. For instance, the initial mapping of the words *left* and *right* to the child's own body parts can be successfully taught to English-speaking children as young as 4 years old over the course of a single training session (Shusterman & Spelke, 2005). However, learning to apply the terms "left" and "right" to other people's viewpoints is extremely protracted with the acquisition of a full-fledged, adult-like meaning for these terms taking several years (e.g., Irwin & Newland, 1977; Piaget & Inhelder, 1948/1967; Rigal, 1994, 1996). In sum, the acquisition of FoR terms follows a protracted time course for both absolute and relative languages, with key differences between their specific acquisition patterns (Brown & Levinson, 2000; de León, 1994, 1995; Levinson, 2001, 2003; Piaget, 1928; Piaget & Inhelder, 1948/1967; Rigal, 1994, 1996).

Additional arguments that experience plays a major role in the development of spatial FoR concepts comes from reported correlations between spatial language and performance on non-verbal tasks (Haun, Rapold, Janzen, & Levinson, 2011; Haun et al., 2006; Levinson, 2003; Majid et al., 2004; Pederson et al., 1998; Pyers et al., 2010; Shusterman & Spelke, 2005; but see Abarbanell, Montana, & Li, 2011; Li & Gleitman, 2002; Li et al., 2011). For example, Haun et al. (2006) used an implicit spatial learning task to see whether participants would recognize a pattern in which hidden objects preserved either egocentric or geocentric relations across two arrays. Speakers of Hai||om, an absolute-FoR language in Namibia, performed much better at learning the pattern when geocentric spatial relations were preserved rather than egocentric ones, while the reverse was true for speakers of Dutch, a relative language. The findings led researchers to argue that language learning “seems to play an important role in this divergent specialization of the intellect” (Haun et al., 2006, p. 17568).

The findings of language-specific trajectories in learning spatial words and in solving non-verbal tasks is consistent with the claim that FoR representations are acquired through experience with culture and language. However, these findings do not address whether or how innate conceptual precursors might interact with language experience in shaping adult FoR representations. To address the possible role of conceptual precursors in spatial FoRs, Haun et al. (2006) tested German-speaking 4-year-olds, who likely had not acquired left-right language, and three non-human species of great apes on modified versions of the same implicit spatial learning task described earlier. Both children and apes successfully learned a pattern across two arrays in which hidden objects maintained geocentric/allocentric relations, but not across arrays in which the hidden objects maintained egocentric relations. This pattern contrasted with adult Dutch speakers mentioned above, who successfully learned the egocentric pattern. From these findings, Haun et al. concluded that humans and other species share a conceptual representation of space that supports geocentric FoR. Learning an absolute language capitalizes on these universal representations, while learning a relative language increases the salience of the egocentric FoR, creating cross-cultural variations in thought.

Although many developmental psychologists have presumed that egocentric representations precede allocentric representations (Acredolo, 1977; Piaget, 1928), other studies lend support to the idea that allocentric frames of reference are available early in development (Huttenlocher & Presson, 1973, 1979; Nardini, Burgess, Breckenridge, & Atkinson, 2006; Presson, 1980). A large literature on spatial cognition in animals also suggests that neural representations, most importantly hippocampal place cells and entorhinal grid cells, contain allocentric codes of the environment (Hafting, Fyhn, Molden, Moser, & Moser, 2005; Knierim, Kudrimoti, & McNaughton, 1995; O’Keefe & Nadel, 1978), raising the possibility that allocentric representations shared across species are recruited for learning geocentric language in humans.

Is there similar evidence for egocentric representations that could support the acquisition of relative languages? Studies on the neuroscience and psychology of spatial representation suggest that egocentric representations exist alongside allocentric representations during development; in fact, egocentric and allocentric representations are often not mutually exclusive (Huttenlocher & Presson, 1979), and can even support each other within a single task context (e.g., Burgess, 2006; Huttenlocher & Presson, 1973; Nardini et al., 2006; Wang & Spelke, 2002). A recent study by Janzen et al. (2012) suggests that there are distinct patterns of neural activation in response to identical spatial displays depending on the reference frame indicated by a linguistic context, highlighting flexibility in choosing among reference frames.

As an example, in a developmental version of a classic task by Simons and Wang (1998), children were asked to remember an array of objects on a round table (Nardini et al., 2006). Children then either walked to a new position at the table (yielding a novel presentation of the array in a body-based frame of reference, but a consistent presentation in a room-based frame of reference), stayed in place while the table rotated (novel body-based and room-based presentations), or walked to a new position as the table rotated (novel room-based but consistent body-based presentations). Overall, 3- to 6-year-old children benefited from consistency in either the room- or body-based frames of reference, in a way that suggested an additive effect of consistency with egocentric and allocentric memory representations.

A growing consensus in the literature suggests that organisms entertain multiple representations of space simultaneously (Burgess, 2006; Burgess & O’Keefe, 2003; Colby, 1998; Landau & Stecker,

1990; Newcombe & Huttenlocher, 2000). Given the evidence from the developmental and animal literatures, then, language acquisition could build on all, some, or none of these conceptual representations. In the current experiments, we ask whether and how underlying spatial representations could influence and support the process of language acquisition.

1.4. Motivation for the present studies

The findings from developmental and comparative studies provide a glimpse at the link between evolutionary and cultural forces on human language and conceptual representation (Gentner, 2007). They raise the hypothesis that children invoke innate conceptual representations in the process of acquiring meanings for spatial terms. To date, however, no studies have directly tested this hypothesis in order to see how conceptual precursors affect the course of word learning (Majid et al., 2004).

To examine the development of FoR language and concepts, we designed a word extension task and training protocol. We introduced novel spatial words to children and compared children's acquisition of terms for different frames of reference. The design allowed us to examine (1) children's biases in their initial acquisition of these spatial terms (e.g., showing preference for left-right or north-south interpretations), (2) their patterns of learning when given structured input and feedback about word meanings (e.g., consistent with left-right or north-south interpretations), and (3) and their spontaneous generalization of these terms to novel situations. We tested English-speaking 4-year-old children, for three reasons. First, they do not yet know which FoR is preferred in their linguistic community; Haun et al. (2006) demonstrate that 4-year-old children are not influenced by their language background in an egocentric vs. allocentric rule guessing game, while 8-year-old children are. Second, they do not yet fully know the FoR words being tested (Shusterman & Spelke, 2005; Shusterman et al., 2011), although they likely have some partial knowledge about spatial FoR terms (e.g., that "left" and "right" are opposite directional terms; Dessalegn & Landau, 2008). Third, children at this age are capable of learning some left-right meanings, as demonstrated in a prior training study (Shusterman & Spelke, 2005).

If language learning capitalizes on specific conceptual precursors, then we expect to see systematic biases in children's initial interpretations of novel words. If children's biases are geocentric, as predicted by Haun and colleagues' cross-species and cross-cultural findings, then we expect children to interpret novel FoR words as meaning north-south, and to learn north-south meanings for novel spatial terms more readily than left-right. If children's early spatial representations are egocentric, as suggested by previous developmental research (Acredolo, 1977; Piaget & Inhelder, 1948/1967), then we expect the reverse pattern.

Alternatively, both FoRs could be equally privileged and recruited for word learning. In this case, we might expect some children to favor egocentric interpretations, while others favor geocentric interpretations. We might even see individual children vary within their own preferences, but for children to learn both kinds of FoR words equally well when given disambiguating input.

Finally, if FoR concepts initially emerge from language learning, then we expect variability in children's initial hypotheses about the novel words, and we expect children to have difficulty learning the meanings of the words with minimal disambiguating input.

1.5. Summary of experiments

Our paper is divided into two parts. In the first part of our paper (Experiments 1–5), we begin by contrasting egocentric body-based and environment-based FoRs. We focus on three separate questions: (1) whether children spontaneously construe novel spatial words in terms of a body-based or environment-based frame of reference; (2) whether and how children constrain the situations in which to apply these frames of reference; and (3) how – with what input – children eventually learn the adult-like meanings of FoR terms.

In the second part of our paper (Experiments 6–8), we focus on one particular body-based axis: left-right. It is well-documented from comprehension studies that acquisition of "left" and "right" is

protracted (Piaget & Inhelder, 1948/1967; Rigal, 1994, 1996). “Left” and “right” pose additional learning problems because mature understanding of left-right requires a flexible capacity to compute another person’s or entity’s left and right in addition to one’s own. There are many reasons these FoRs might be difficult to learn, including high variability in the input (e.g., left sometimes referring to the child’s left and sometimes not); competition with environment-based FoRs; or cognitive demands such as perspective-taking or mental rotation. Therefore, we explore in depth where and why children’s learning of these FoRs breaks down, addressing the issues of extension, translation, and rotation. Importantly, these studies allow us to see in what ways relative FoRs, which do not surface in all languages, pose particular difficulties for children.

2. Experiment 1: left-right body-based vs. environment-based FoR

In Experiment 1, we introduced children to the novel spatial terms ZIV and KERN (e.g., This wall is to the “ZIV” of you). The goal was to assess children’s initial bias to either interpret the terms as meaning left-right or north-south, and their ease of learning left-right or north-south meanings when given feedback consistent with only one of those interpretations.

2.1. Experiment 1: methods

2.1.1. Participants

Twenty children (mean 4;7, range 4;2–4;11; 8F) recruited from around Cambridge and Boston, MA participated in sessions lasting approximately 20 min. Participants received a small prize and travel reimbursement.

2.1.2. Training set-up (Fig. 3)

The training room was 11 × 12 feet and furnished. The experimenter always faced the children throughout the session.

2.1.3. Pretest (8 trials)

Children were given an initial pretest to ensure that extraneous cues did not affect their responses. We expected 50% chance performance on the pretest since it tested comprehension of completely novel words. On each trial, identical containers were placed on either side of the child. Children were given directions with the novel words “ZIV” or “KERN” (e.g., “The prize is in the box on the ZIV side”). Children indicated a container, which was then set aside to be opened after the pretest. No feedback was given. The child faced east for the first four trials and west for the last four. “ZIV” requests and “KERN” requests were each given half the time, in a pseudorandom order avoiding repeated strings or alternations.

2.1.4. Word introduction

Children were then given instructions about the meaning of novel spatial terms (see [Appendix A](#)’s basic neutral script). The script was ambiguous about whether the words meant north-south or left-right. The wording mentioned both the environment and the child (e.g. “This wall is to the ZIV of you”), so that children would have a basis to use either framework. Children faced only one direction during this portion because turning would disambiguate the intended reference.

Seven *probe* questions tested whether children were paying attention (e.g., “Everything that way is ZIV of you. Can you point to the ZIV?”). Two *object-switch* questions tested whether they could apply the terms to new toys placed on their ZIV and KERN sides. Children received corrective feedback if needed.

2.1.5. Bias test (4 trials)

Next, we turned the children 180 deg and asked about new toys placed on their ZIV and KERN sides (“Can you show me the toy on the ZIV side?”). This manipulation revealed whether children mapped

the novel terms onto their bodies or to the environment (Fig. 3b).² No feedback was given. Children completed four trials to assess how consistently they mapped the novel words after the rotation.

The first two test trials were in the center of the room and the second two trials were in the corner of the room. The purpose of using the corner location was to assess whether children used *themselves* as the origin of the spatial relation (with ZIV extending in one direction and KERN in the other from their body) or *the center of the room* as the origin (with both toys either in the ZIV or KERN half of the room).

2.1.6. Structured feedback session (maximum 24 trials)

As before, identical containers were placed on both sides of the child during each trial, and the experimenter used “ZIV” or “KERN” to disclose the prize’s location. However, this time, children received feedback to disambiguate the novel words’ meanings, by immediately opening the box they selected. Children were randomly assigned to one of two feedback conditions: half of the children received feedback consistent with left-right meanings throughout the session, and half with north-south. Correct boxes contained prizes and incorrect ones were empty, with ‘correct’ being defined by the condition to which the child was randomly assigned (left-right or north-south). Trials were blocked in six-trial sets; children turned 180 deg between each block. Feedback ended after eight consecutive correct responses, with a maximum of 24 trials.

2.1.7. Post-test (8 trials)

Children received a post-test, structured like the pretest with no feedback, to see whether they had learned the intended word meanings.

2.1.8. Left-right comprehension (8 trials)

After the experiment, children were tested for their knowledge of the real words “left” and “right.” The test was identical to the pre- and post-tests, except real words replaced “ZIV” and “KERN.” The left-right comprehension test served to verify whether children at this age could correctly identify “left” and “right,” and to rule out the possibility that prior knowledge of left-right meanings contributed to how children interpreted and learned these novel words.

2.2. Experiment 1: results

2.2.1. Pretest and word introduction

Children did not know the intended meanings of the words on the pretest (55% correct, $t[19] = 0.87$, $p > .1$, $d = .2$). After the initial word introduction, children were highly accurate on the probe (98% correct, $t[19] = 34.87$, $p < .0001$, $d = 8.00$) and object-switch trials (90% correct, $t[19] = 6.84$, $p < .001$, $d = 1.54$), indicating that they were paying attention prior to the 180-deg rotation.

2.2.2. Bias test

For each child, we calculated the percentage of bias test trials out of four in which they gave an answer consistent with a geocentric interpretation. The two trials at the center of the room and the two trials at the corner were combined since performance did not differ between them ($t[19] = 0$, $p = 1$; Wilcoxon $Z = -1.38$, $p = .89$; MH std = .94, $p = 1$; n.s.).³ Children gave geocentric responses 70% of the time, significantly above 50% chance ($t[19] = 2.32$, $p < .05$, $d = .52$; Wilcoxon $Z = -2.13$, $r = .48$, $p < .03$). Twelve of 20 children gave predominantly geocentric responses (3 or 4 geocentric responses out of 4 trials), and four of 20 children gave predominantly egocentric responses (Fig. 4a); this

² The “geocentric” pattern is consistent with children mapping the novel terms to frames of reference established by stationary entities in the environment (e.g., the cabinet, the wall) or cardinal directions. In Experiment 1-2, we further explore the basis of children’s “geocentric” mapping. The “egocentric” pattern is consistent with children mapping the novel terms to their own left and right as well as the possibility of the experimenter who always faced them. However, Experiment 1I-3 renders mapping the words to the experimenter’s left-right unlikely.

³ We supplement t -tests with non-parametric tests whenever the distribution is non-normal and/or the sample size small.

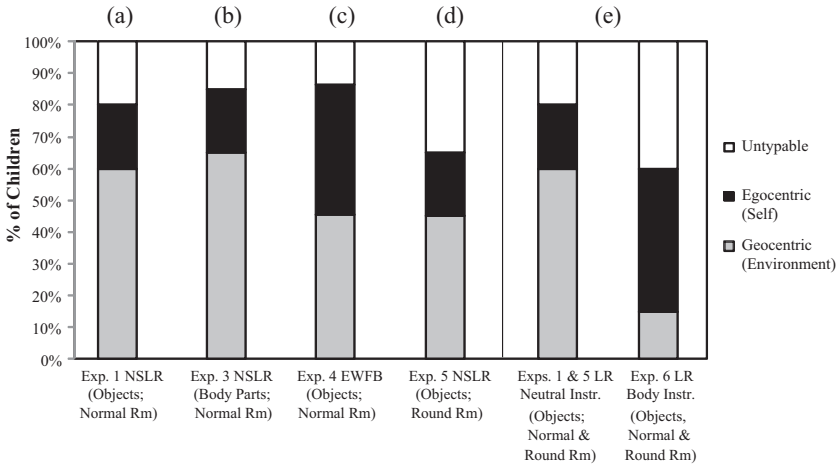

Fig. 4. Distribution of performance on bias assessment trials across experiments, after 180-deg turn. Participants were categorized as egocentric or geocentric if they gave three or more consistent responses out of four, and untypable otherwise. NSLR, EWFB indicate the axes tested. Objects refers to object queries (“The prize is on the ZIV side”); body refers to body part queries (“Raise your ZIV leg”).

2.3. Experiment 1: discussion

Experiment 1 tested children’s initial mapping of novel spatial words and their subsequent learning through structured feedback. The bias assessment task revealed that children had a preference to attribute environment-based meanings rather than body-based meanings to the novel spatial words. One potential problem, however, was that children always sat across from the experimenter. Body-based interpretations would thus be ambiguous about whether the words referred to their own left-right or the experimenter’s left-right. Might children have avoided body-based interpretations because they noticed that the terms are ambiguous, and therefore preferred the unambiguous environment-based interpretation? We conducted a short follow-up (Experiment 1B) testing this alternative by removing the conflict between perspectives by facing the child and experimenter in the same directions.

An additional 12 children (mean 4;7; range 4;0–4;11; 6F) were tested only on the Word Extension and Bias Assessment portion of the study. The experimenter always stood to the right of the child and faced the same direction as the child (Fig. 3c). Objects placed to the left (or right) of the child were therefore also to the left (or right) of the experimenter. If conflict in perspective led children to prefer an environment-based interpretation, this set-up, which involved a shared perspective between the child and experimenter, should have encouraged body-based interpretations by reducing environment-based interpretations.

The 12 children performed well above chance on the probe questions and object-switch questions (99% and 96% correct), indicating that they were paying attention. Importantly, these children gave geocentric responses 77% of the time ($t[11] = 2.40, p < .05$) on the bias assessment trials. Nine of 12 children gave predominantly geocentric responses and one of 12 gave predominantly egocentric responses. The children’s response pattern did not differ from the previous 20 children’s ($MWU = 106.5, p = .55, n.s.; t[30] = .5, p = .62, n.s.$), indicating that facing direction of the child and the experimenter did not account for the response preference.

Collectively, these results show a preference in children to interpret novel spatial terms as referring to the environment and not to their own bodies. Children were also successful at learning environment-based meanings. By contrast, they had difficulty learning egocentric meanings. These results provide the first direct evidence that children invoke their environment-based representations

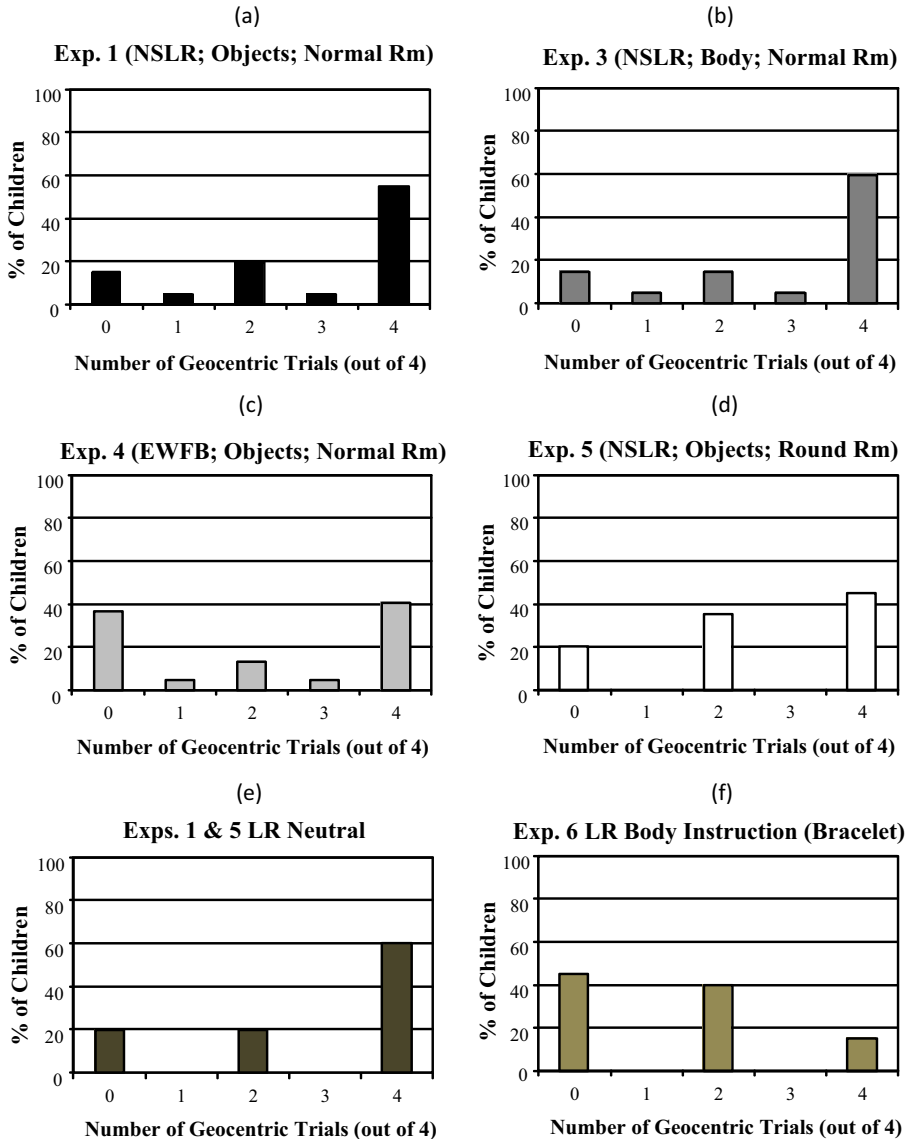

Fig. 5. Bias assessment results across experiments showing distribution by number of trials with geocentric response. Bars represent percent of participants giving geocentric responses on 0, 1, 2, 3, or 4 out of 4 possible trials.

of space in spatial word learning. The findings are consistent with the claim that children might generally privilege geocentric FoR, as suggested by Haun et al. (2006).

However, it is possible that children's success at learning environment-based meanings in Experiment 1 falls short of abstract and adult-like environment-based FoR concepts like *north* and *south*. For instance, children could have taken the novel terms to be adjectives describing the position of particular walls in the training room, applying a narrow scope to the spatial terms, not as terms specifying cardinal directions. Experiment 2 tested the limits of children's environment-based meanings.

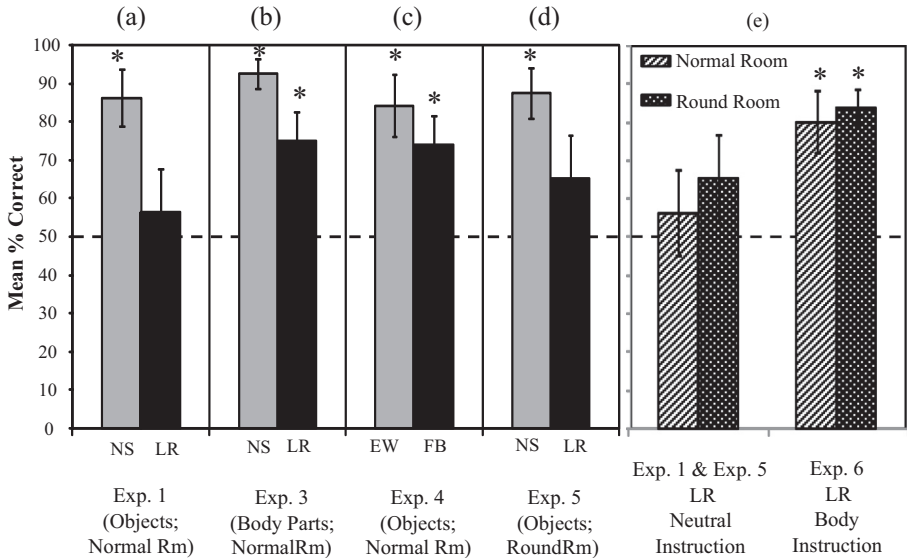

Fig. 6. Experiments 1 and 3–6 post-test scores. Light bars show responses for children in geocentric feedback conditions and dark bars for children in egocentric conditions. Above-chance performance ($p < .05$) indicated by asterisks.

3. Experiment 2: extending scope and contexts for environment-based FoR

3.1. Experiment 2: rationale and methods

In Experiment 2, we asked how abstractly children construed the environment-based meanings of novel terms. We used a shortened version of the Experiment 1 training protocol that excluded the pre- and post-tests to induce fast-mapping of the English terms “north” and “south” with 12 children (mean 4;5, range 4;4–4;11; 4F). The words “north” and “south” were determined through pilot studies to be novel to children this age. Three generalization tests (Fig. 7a–c) followed the training protocol:

3.1.1. New facing direction test (4 trials)

Children faced north or south and were asked to point to the north and south, requiring them to point forwards or backwards. This contrasted with training, when children had only pointed to the sides. Thus, this task tested children’s generalization to a new response type, and assessed the possibility that children responses were based on a low-level sensorimotor response to point to their sides when hearing the novel words.

3.1.2. New origin test (8 trials)

Children had to transfer the origin of the coordinate system from their own bodies to a stuffed animal. Children sat with the animal next to them. Identical toys were placed on the animal’s left and right sides, and the experimenter asked children to indicate the toy to the north or south of the animal. Critically, although both toys were on the same side (north or south) of the child, only one toy was to the north or south of the animal. Thus, if children responded without considering the new origin, they would respond correctly only 50% of the time.

3.1.3. New environment test (8 trials)

Children were led outside the training room to see whether they could track north and south after losing perceptual contact with the training environment. Children were asked to point to north and south after each of four movements: after moving to the hallway just outside of the training room

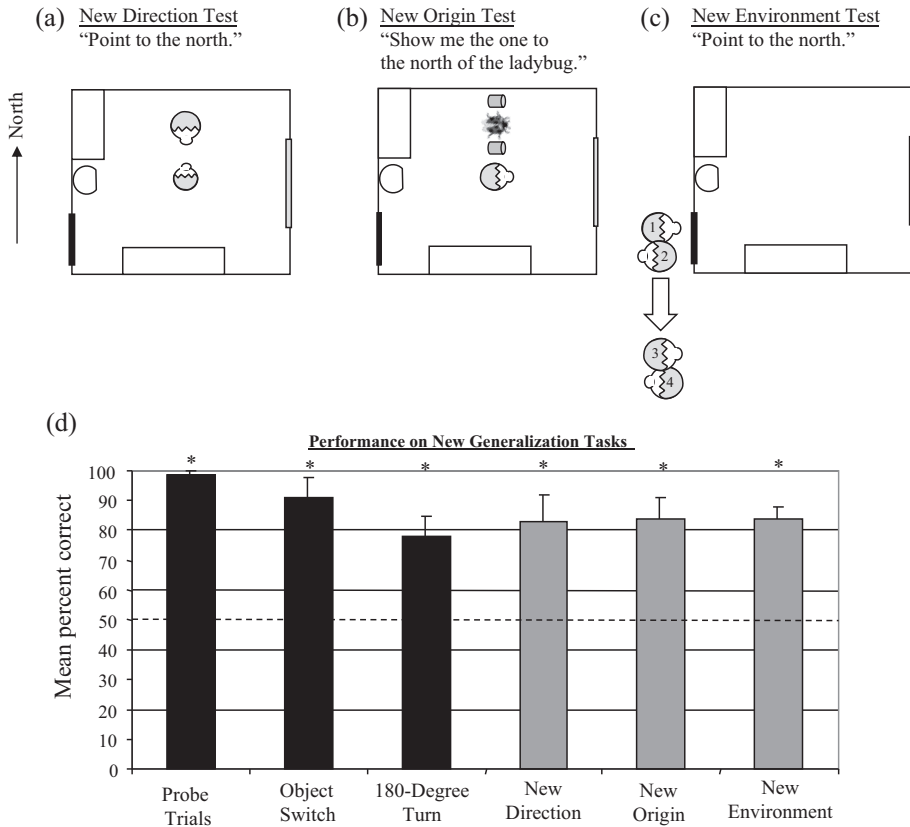

Fig. 7. Experiment 2 design and results. (a) New Direction test; (b) New Origin test; (c) New Environment test. Heads in the schematic for the New Environment test represent each of the four locations from where the child was asked to point to the north and south. (d) Percent correct responses. Black bars: replication of Experiment 1. Gray bars: accuracy on three generalization tests. Above-chance performance indicated by asterisks. (New Environment bar includes angled and straight points if children pointed to the correct side; see Results in section of Experiment 2 for further explanation.)

and turning to look into the training room; after turning in place 180 deg to look away from the training room; after walking 4 m up the hall; and after turning 180 deg again, resulting in 8 trials total.

3.2. Experiment 2: results

As in Experiment 1, children mapped the terms with above-chance accuracy on the probe (97% correct, $t[11] = 20.77$, $p < .0001$, $d = 5.88$), and object switch (90%, $t[11] = 6.917$, $p < .0001$, $d > 10$) trials (Fig. 7d, black bars). For the bias assessment test, combining trials in the center and corner of the room, which did not differ significantly from each other ($t[11] = .692$, $p = .504$; Wilcoxon $Z = .480$), children selected the geocentric response on 79% of trials, significantly above 50% chance, $t(11) = 4.841$, $p < .001$, $d = 1.25$. Nine of 12 children gave predominantly geocentric responses, and 0/12 gave predominantly egocentric responses. Thus, as in Experiment 1, children spontaneously interpreted and rapidly learned environment-based meanings.

Furthermore, children robustly generalized the geocentric meanings to new contexts (Fig. 7d, gray bars). In the New Facing Direction test, children's accuracy was 83%, well above chance with chance defined as 25% for each of the four walls; $t(11) = 6.205$, $p < .0001$, $d = 1.00$. In the New Origin test,

accuracy was 84%, above chance with chance defined as 50% for choosing between the two identical toys; $t(11) = 4.861$, $p < .001$, $d = 1.42$.

In the New Environment test, children were taken outside the training room. For two trials, they looked into the room from just outside the doorway. We wondered whether children would point at an angle toward the walls in the room, as though *north* and *south* were adjectives describing particular walls, or whether they would point straight out to their sides as one might for cardinal directions. The responses were mixed: seven children pointed straight, four children pointed to the walls, and one child did both. On the next two trials, when turned away from the room, children lost perceptual contact with the training room. At this location, facing away from the room, two of 12 children pointed (slightly backward) toward the walls, nine of 12 pointed straight, and one child gave a mixed response. After moving up the hallway, 12/12 of the children pointed in cardinal directions straight out to their sides for all four trials.

Collapsing across all eight trials, and only counting responses as correct if the children pointed straight, mean accuracy was 70%, well above a conservative chance level of 50%, $t(11) = 3.402$, $p < .01$, $d = .99$. Including angled pointing responses, mean accuracy was 84%, $t(11) = 8.421$, $p < .0001$, $d = 2.43$, indicating that children were tracking directions even after losing perceptual contact with the training environment, traveling a distance, and turning several times.

3.3. Experiment 2: discussion

Experiment 2 replicated the finding of a spontaneous geocentric bias in novel spatial word meanings and illuminated children's interpretation of these terms. In the New Direction test, children were accurate at pointing when facing untrained directions, eliminating the possibility that they developed a simple association between the novel words, visual cues, and a sensorimotor response (e.g., when I see the cabinet and hear "north," extend my right hand).

In the New Origin test, children had to suppress any tendency to focus on their own bodies in order to transfer the coordinate origin to a stuffed animal beside them. A request for "the toy to the north of the bear" had only one correct answer, even though half the time *both* toys, as well as the bear, were on the north side of the child, and half the time *neither* was on the north side of the child. Previous work distinguishing absolute from intrinsic FoR suggests that absolute FoR terms are defined by abstract, flexible relations (Levinson, 2003). Children's success at this relational test indicates they quickly developed meanings for the terms consistent with Levinson's theoretical descriptions of absolute FoR.

In the New Environment test, children demonstrated an impressive ability to maintain an internal sense of the directions without direct visual aid from the training environment, even after substantial movement and turning. This finding favors the possibilities raised in Experiment 1: children are predisposed to rely on generally geocentric representations of space, not just features of local environments.

A few children initially indicated the walls of the room when asked to point, as though the terms referred concretely to the walls and not to abstract cardinal directions. However, within just a few trials down the hallway, and with no corrective feedback, all children updated their interpretation in favor of cardinal directions. Other than this hint that children's initial interpretations were limited in scope, the speed with which children adjusted their interpretations, and their overall success on all the three tasks, suggests that children's initial interpretations of the novel words were indeed geocentric—abstract, flexible, and broad in scope.

Having established in Experiments 1 and 2 that many children spontaneously selected environment-based interpretations over other possible meanings of the novel words in the context provided here, we next asked about the robustness of this preference under various input conditions (Experiments 3–5).

4. Experiment 3: body-focused context

In Experiments 1 and 2, children showed a readiness to adopt an environment-based frame of reference for objects next to them. Speakers of absolute languages are reported to use absolute terms

even to refer to their bodies (Haun & Rapold, 2009; Majid et al., 2004). Experiment 3, therefore, tested whether children's preference for environment-based terms would be observed even if the terms were taught and tested on the left and right sides of their own bodies, rather than on separate objects.

4.1. Experiment 3: methods

A new group of 20 children (mean 4;7, range 4;1–4;11; 9F) was introduced to ZIV and KERN on their own bodies (“This is your KERN arm”). The task was identical to Experiment 1, except children received instructions to “wiggle” or “point to” their body parts instead of choosing toys or boxes (e.g., “Can you raise your ZIV arm?” or “Can you touch your KERN ear?”; see Appendix A for instructions). In the feedback session, children were praised after a correct answer or corrected after a wrong answer. As in Experiment 1, half of the children received left-right feedback and half received north-south feedback.

4.2. Experiment 3: results

4.2.1. Pretest and word introduction

Children performed at chance on the pretest (48% correct, $t[19] = -0.567$, $p = .61$, $d = .14$, n.s.) when they were asked to “wiggle” or “point to” their body parts using the terms ZIV and KERN. After a brief introduction to these terms, they answered the probe (99%, $t[19] = 49.0$, $p < .0001$, $d = 4.32$) and switch questions (from arms to legs) with high accuracy and above 50% chance (88%, $t[19] = 6.097$, $p < .0001$, $d = 1.34$).

4.2.2. Bias test

Results did not differ between the center versus corner of the room ($t[19] = 0$, $p = 1$; Wilcoxon $Z = -.138$, $p = .89$; MH std = .935, $p = 1$; n.s.), so responses were combined for analysis. When asked to “wiggle” or “point to” their body parts, children selected geocentric meanings 72.5% of the time, above 50% chance ($t[19] = 2.592$, $p < .02$, $d = .58$; Wilcoxon $Z = -2.32$, $p = .02$, $r = .52$). Thirteen of 20 children gave predominantly geocentric responses, and 4/20 gave predominantly egocentric responses (Fig. 4b). This distribution was non-normal (Shapiro-Wilk $W = .711$, $p < .01$; Fig. 5b) and similar to the proportion of geocentric responses in Experiment 1 (Experiment 2: 72.5% vs Experiment 1: 70.0%, $t[38] = .204$, $p = .84$, $d = .06$; MWU = 191.5, $p = .82$, n.s.).

4.2.3. Structured feedback and post-test

Children in the north-south (NS) and left-right (LR) conditions required similar numbers of feedback trials to criterion (NS: 15.6 vs. LR: 16.4, $t[18] = 2.67$, $p = .79$, $d = .38$; MWU = 44, $p = .67$, n.s.). Both groups performed above chance on the post-test (NS: 92.5%, $t[9] = 11.129$, $p < .0001$, $d = 3.54$; LR: 75%, $t[9] = 3.254$, $p = .01$, $d = 1.04$). The NS group was marginally better than the LR group on the post-test ($t[18] = 2.040$, $p = .06$, $d = .96$; Fig. 6b). Comparing post-test performance in this body-oriented instruction to Experiment 1's object-oriented instruction, a 2-way ANOVA on the post-test, with Instruction (Experiment 1 or Exp 3) and Terms (NS or LR) as between-subjects factors, revealed a main effect of Terms ($F[1,36] = 8.74$, $p < .01$, $\eta_p^2 = .20$) and no effect or interaction with Instruction (p 's $> .13$, n.s.).

4.2.4. Left-right comprehension test

Children scored on average 58.8% correct on the comprehension task, not different than 50% chance ($t[19] = 1.11$, $p = .28$, $d = .25$). There was a marginally significant negative correlation between participants' “left” and “right” comprehension scores and their preference for the geocentric response on the bias assessment trials (Pearson's $r = -.43$, $p = .06$), suggesting children who know “left” and “right” were less likely to give geocentric responses. Thus, a mutual exclusivity word-learning strategy (i.e., thinking ZIV and KERN is not “left” and “right”) cannot explain children's preference for geocentric interpretations. If anything, children who knew “left” and “right” were more likely to attribute egocentric, not geocentric, interpretations to the novel terms.

4.3. Experiment 3: discussion

Surprisingly, children exhibited the environment-FoR preference with reference to their bodies (Experiment 3) just as they had for objects (Experiment 1). Thus, a typical child, having heard one arm labeled as her “ZIV arm,” would turn 180 deg and spontaneously decide that that the same arm was now the “KERN arm.” These findings suggest that children are attuned to a non-egocentric spatial concepts from a young age—even if they are being raised in an English-speaking environment in which relative spatial terms like *left* and *right* dominate.

Unlike Experiment 1, we found moderate success on learning left-right meanings despite children’s initial preference to map words onto environment-based meanings. With feedback, along with body-centered requests like “raise your ZIV arm,” children were able to benefit from the stable mapping between egocentric spatial terms and sides of their bodies.

Although these data demonstrate that children more easily map spatial terms to environment-based representation than to body-based representation, the environment-based interpretations emerged in a context where the two contrasting FoRs were based on an asymmetrical environment (a normal room with windows and furniture) and a symmetrical body axis (the child’s left-right). Thus, our results might have been due to the fact that children found it easier to map directional terms to a marked, asymmetrical referent rather than an unmarked, symmetrical one. Experiments 4 and 5 addressed this possibility. In Experiment 4, children were tested on their front-back axis, pitting two asymmetric FoRs against each other. In Experiment 5, children were tested on their left-right axis but in a completely symmetrical room, pitting two symmetrical FoRs against each other.

5. Experiment 4: front-back body-based vs. environment-based FoR

The purpose of Experiment 4 was to see whether children’s preference for geocentric interpretations would arise only when the alternative was their own symmetrical left-right axis, or whether such interpretations would also arise if the words were applied to their front-back axis. Children were introduced to novel spatial terms ZIV and KERN (e.g., This wall is to the “ZIV” of you). The procedure was identical to Experiment 1 with two exceptions. First, words were introduced on the front-back/east-west axis instead of the left-right/north-south axis. Second, the experimenter always stood to the side of the participant, instead of in front of her, when placing the objects (in order to avoid reaching around the child and to avoid a possible interpretation of near/far from the experimenter; Fig. 3e and f). Participants were 22 children (mean 4;5, range 4;0–4;10; 8F) recruited from the local community.

5.1. Experiment 4: results

5.1.1. Pretest and word introduction

Children did not know the intended meanings of the words on the pretest (51% correct, $t[21] = 0.169$, $p = .87$, $d = .04$), but were highly accurate on the probe (95% correct, $t[21] = 16.554$, $p < .0001$, $d = 3.52$) and object-switch trials (object-switch: 89%, $t[21] = 5.923$, $p < .0001$, $d = 1.26$), indicating that they were paying attention.

5.1.2. Bias test

Performance did not differ between the two trials at the center of the room and the two trials at the corner ($t[21] = .624$, $p = .54$; Wilcoxon $Z = -.557$, $p = .58$; MH std = .632, $p = .53$, n.s.), so we combined the responses for analysis. Children gave geocentric interpretations 52% of the time (compared to 50% chance: $t[21] = .234$, $p = .82$, $d = .05$; Wilcoxon $Z = -.242$, $p = .81$, $r = .51$, n.s.). Ten of 22 children gave predominantly geocentric responses (three or four geocentric responses out of four trials), and nine of 22 children gave predominantly egocentric responses (Fig. 4c). This distribution was non-normal (Shapiro-Wilk $W = .76$, $p < .01$; Fig. 5c), with children split between either predominantly choosing geocentric responses or egocentric responses. However, this pattern, with children’s front-back axis,

was not significantly different from Experiment 1 when children's left-right axis was used ($t[40] = 1.35, p = .18, d = .42; MWU = 172.5, p = .20$).

5.1.3. Structured feedback and post-test

All measures indicated that front-back (FB) and east-west (EW) meanings were equally easy to learn. Both required similar number of feedback trials to criterion (FB: 16 vs. EW: 17 trials, $t[20] = .654, p = .65, d = .19; MWU = 53.5, p = .65$). Post-test scores were similar for children learning FB and EW (74% vs. 83%, $t[20] = .933, p = .36, d = .40; MWU = 44.5, p = .27$; Fig. 6c); both scores were above chance (FB: $t[10] = 3.139, p = .01, d = .95$ and EW: $t[10] = 4.242, p = .002, d = 1.24$). Comparing post-test performance in this EW-FB axis to Experiment 1's NS-LR axis, a 2-way ANOVA on the post-test, with Axis (EW-FB or NS-LR) and Terms (Geo or Ego) as between-subjects factors revealed a main effect of Terms ($F[1, 38] = 5.37, p < .03, \eta_p^2 = .12$), with an advantage for geocentric terms, and no effect or interaction with Axis (p 's $> .38, n.s.$).

5.2. Experiment 4: discussion

In Experiment 4, children were presented with novel spatial terms along their front-back axis rather than their left-right axis. The script was identical to Experiment 1, ensuring that any difference in children's bias or learning would be due to the particular axis chosen and no other experimental variables. In this case, no strong preference for the geocentric interpretation was observed; children were equally likely to select egocentric interpretations as geocentric ones. Similarly, children were easily able to learn both geocentric (east-west) or egocentric (front-back) meanings. These results suggest that the tendency toward geocentric interpretations of novel terms observed in Experiments 1, 2, and 3 is specific to the left-right axis.

These findings suggest that symmetry plays a role in shaping how children encode frames of reference. In the current experiment, two asymmetrical axes were pitted against each other – the front-back axis of the child's own body and the environment-based axis of the landmark-rich testing room. Both FoRs were robustly accessible to children for word learning.

Importantly, in the context of two competing asymmetrical axes, children did not switch to an overall preference for the egocentric interpretation. This is striking because the front-back axis is a highly salient asymmetry. The two objects were presented in front of and behind the child: one was in front of them and visible, and the other was not. Therefore, in addition to the body-based spatial interpretation of the novel terms, children could have mapped ZIV and KERN onto meanings like "the one I can see" and "the one I can't see." Despite this salient perceptual asymmetry, children were split in their initial interpretations, with approximately half of them still choosing the geocentric interpretation.

The learnability of the front-back frame of reference matches the learnability of an east-west frame-of-reference, but does not trump it. This provides a metric for the availability of geocentric representations in young children – environment-based representations seem to be approximately as salient and available as one's own front and back. Front-back concepts are already available by the age of two years (Levine & Carey, 1982); two-year-olds who did not know the words 'front' and 'back' could correctly orient objects so that they faced forward in a parade or so their fronts faced each other in a tea party scenario. Geocentric representations therefore appear to be readily available for word learning and perhaps for other tasks, since they compete on equal footing with well-established front-back representations.

Experiment 4 demonstrated that both body-based and environment-based FoR are easily and equally available to children when they are matched for symmetry (both asymmetrical in this case). This raised the question of whether children's frame-of-reference concepts, both body and environment, are rooted in low-level perceptual input or abstract mental models of space. Experiment 5, therefore, tested whether children's ability to invoke environment-based representations was due to external perceptual cues in the environment – notions like "poster-side" or "window-side" – or truly abstract geocentric concepts.

6. Experiment 5: impoverished cues for environment-based FoR

6.1. Experiment 5: rationale and methods

Experiment 5 took place in a round room devoid of perceptual cues. Thus, no information was present that could highlight the asymmetry of the environment and consequently cue children to the asymmetry of the directional terms. If children in the previous experiments had mapped the terms directly to features in the environment, the availability of geocentric representations should disappear in a featureless room. On the other hand, if children had mapped the terms to conceptual representations of geocentric directions, they should continue to demonstrate a readiness to interpret the terms geocentrically in their initial bias and in their subsequent acquisition of north/south meanings.

Furthermore, a featureless room might diminish the relative salience of the environment-based frame, enabling children to focus on the body-based frame and possibly acquire left-right terms more easily. Indeed, prior studies show that features of the environment affect spatial reasoning (Acredolo, 1977, 1978, 1979; Restle, 1957). In particular, Acredolo (1977) demonstrated that 4-year-olds more often respond egocentrically when searching for hidden objects in featureless rooms, and have to be reminded of their changed location in the room to take into account geocentric relations.

The procedure was identical to Experiment 1, but was carried out in a landmark-free environment (an all-white, soundproof, symmetrically lit, 10' round room). To minimize distractions in this sparse environment, we used small compact envelopes holding pictures instead of small boxes holding toys. Twenty new children (mean 4;7; range 4;2–4;11; 11F) were tested. As in Experiment 1, each child received feedback consistent with a left-right or north-south interpretation for the novel words ($n = 10$ for each group), with the experimenter facing the child throughout.

6.2. Experiment 5: results

6.2.1. Pretest and word introduction

Replicating Experiment 1, children's pretest performance was at chance, 47% correct ($t[19] = -.82$, $p = .42$, $d = .18$, n.s.). Children learned the terms quickly, with above chance performance on the probe trials, 97% correct ($t[19] = 28.687$, $p < .0001$, $d = 6.4$) and object switch trials, 90% correct ($t[19] = 5.812$, $p < .0001$, $d = 1.30$).

6.2.2. Bias test

After turning 180 deg, children's performance did not differ between the trials in the center and at the side of the room ($t[19] = .37$, $p = .72$; Wilcoxon $Z = -.378$, $p = .71$; MH std = .378, $p = .71$), so we collapsed these for analysis. Children gave geocentric responses 62.5% of the time. The response in the round room was not significantly different from 50% chance ($t[19] = 1.422$, $p = .17$, $d = .32$; Wilcoxon $Z = -1.387$, $p = .17$, $r = .31$) nor from the 70% geocentric responses observed in the normal room in Experiment 1 ($t[38] = .61$, $p = .55$, $d = .20$; $MWU = 179$, $p = .57$). Nine of 20 children responded geocentrically, and 4/20 egocentrically (Fig. 4d), resulting in a non-normal distribution (Shapiro-Wilk $W = .78$, $p < .01$; Fig. 5d).

6.2.3. Structured feedback and post-test

The north-south (NS) group required fewer feedback trials to reach criterion than left-right (LR) group (NS: 13 trials vs LR: 19 trials, $t[18] = 2.142$, $p = .04$, $d = 1.04$, $MWU = 25$, $p = .06$). Children in the NS condition scored somewhat higher than the children in the LR condition on the post-test (NS: 88% correct vs. LR: 65% correct; one-tailed $t[18] = 1.70$, $p = .05$, $d = .80$; one-tailed $MWU = 35$, $p = .09$; Fig. 6d). Children in the NS condition performed significantly above chance on the post-test ($t[9] = 5.582$, $p < .0001$, $d = 1.77$), while children in the LR condition did not ($t[9] = 1.328$, $p = .21$, $d = .43$). Comparing post-test performance in this feature-free room to Experiment 1's feature-rich room, a 2-way ANOVA on the post-test, with Room (Round or Normal) and Terms (LR, NS) as between-subjects factors revealed a main effect of Terms ($F[1, 36] = 7.67$, $p < .01$, $\eta_p^2 = .18$) and no effect or interaction with Room (p 's $> .60$, n.s.).

6.2.4. Left-right comprehension

This group of children scored statistically higher than chance on left-right comprehension (65% correct, $t[18] = 2.54$, $p = .021$, $d = .58$). However, left-right knowledge was not correlated with a tendency to give geocentric responses for the bias assessment trials, Pearson's $r = -.13$, $p = .13$.

Including all the children from Experiments 1, 3, and 5, for whom we assessed biases on the NS-LR axis, we found no correlation between percent correct on left-right comprehension and geocentric response ($n = 55$; Pearson's $r = -.21$, $p = .12$). This is true even if we take into consideration of the possibility that some children consistently mis-mapped left-right with right-left (Pearson's $r = -.12$, $p = .40$). Furthermore, for children assigned to the LR-feedback conditions, comprehension of real left and right was not correlated with the number of trials they needed during structured feedback ($n = 29$; Pearson's $r = -.15$, $p = .42$) nor how well they learned the novel terms when the feedback was consistent with left and right meanings ($n = 29$; Pearson's $r = .21$, $p = .28$). In sum, children's comprehension of left-right was not predictive of how they interpreted the novel words nor how well they subsequently learned the meanings of these novel words.

6.3. Experiment 5: discussion

The initial bias in a featureless room was 62.5%—not significantly different from chance nor from the robust preference for geocentric interpretations observed in Experiment 1. In the post-test, the NS group outperformed the LR group both in needing fewer trials to criterion and in their final percent correct. Most importantly, the lack of perceptual features in the environment did not help children focus on a body-based frame of reference to more easily learn left and right. Thus, the impoverished testing environment had little or no effect in promoting “left” and “right” as candidate word meanings.

We conclude that an environment devoid of landmarks and other asymmetries does not substantially attenuate or hinder the learning of geocentric meanings. This is quite remarkable, given that in order to keep track of absolute directions in a featureless room, children must be able to keep track of their own movements across a series of 180-deg turns, since no other information is available for mapping the terms. The finding suggests that children engage a geocentric representation of the environment even in the absence of external perceptual cues, and that they rely on internal mental models of space, rather than external cues, in generating potential referents for directional terms.

Experiments 4 and 5 were designed to challenge the interpretation that children are biased to interpret novel spatial words geocentrically. Experiment 4 pitted geocentric representations against a highly salient asymmetry on the body, the front-back axis, and Experiment 5 removed environmental cues that might have provided support for environment-based meanings. In both cases, the preference for geocentric interpretations was diminished compared with its strength in Experiments 1–3, when training was presented in the context of a feature-rich environment and contrasted with the left-right axis. Nevertheless, in both cases, many children showed an initial preference for the environment-based meaning, and children readily learned the environment-based meanings when given feedback. Together, Experiments 4 and 5 highlight the resilience of children's geocentric FoR representations – they are apparent even when pitted against the child's own front-back axis, and even with no perceptual supports.

The overwhelming evidence from Experiments 1–5 is that children can easily learn geocentric spatial terms. The goal of the remaining experiments, Part II of this paper, turns to examine children's acquisition of body-based object-centric terms. Experiments 6 through 8 focused on the acquisition of “left” and “right,” object-centric terms known to be notoriously difficult for children. Like Experiments 1–5, we varied the input children received in a systematic way in order to articulate children's cognitive biases when acquiring spatial terms.

7. Left-right object-centric FoRs

7.1. Challenges of left and right

In our experiments, children typically failed to acquire “left” and “right” meanings (Experiment 1 & 5), but they had no difficulties in acquiring “front” and “back” (Experiment 4). In other language

comprehension studies, [Kuczjac and Maratsos \(1975\)](#) showed that by 5 years of age, children have almost adult-like mastery of “front” and “back”, and they can point to the “front” and “back” of an object about six months before they can point to its “sides.” By contrast, children struggle with the concept of “left” and “right.” In previous studies, they do not consistently apply the terms correctly to their own bodies until around 6 or 7 years of age, and they do not have full adult mastery of these words until after 9 years of age ([Benton, 1959](#); [Elkind, 1961](#); [Harris, 1972](#); [Piaget, 1928](#); [Rigal, 1994](#)).

Why do “left” and “right” pose such difficulty relative to “front” and “back”? We note that the left-right axis is less salient than the front-back axis in a number of ways. First, humans face and walk forwards rather than sideways, so the front/back axis may be more salient because it also determines what we see (versus what we cannot see) and where we are going (versus where we are coming from).

Second, humans’ front and back sides are physically different from each other, while our left and right sides are symmetrical. The left-right axis is, therefore, a secondary axis to the front-back axis; one must first know which sides are front and back in order to determine which sides are left and right. On these grounds, it is logical that children acquire front-back terms before left-right terms because learning left and right presupposes noticing and understanding the primary front-back axis.

Third, humans may in general have particularly poor perceptual memory for left-right orientation of visual information, even in adulthood (e.g., [Corballis & Beale, 1976](#); [Dehaene, Izard, Pica, & Spelke, 2006](#); [Gregory, Landau, & McCloskey, 2011](#)). This may be true of our visual system for reasons that may or may not be related to our bilateral symmetry.

The low salience of the left-right axis could affect children’s acquisition of left-right spatial terms in several ways. One possibility is that children’s left-right concepts are relatively weak or undeveloped, making it difficult for children to reason about them for purposes of word learning. Certainly, there are many non-linguistic tasks in which children clearly show very little sensitivity to left-right relations, such as map use ([Shusterman, Lee, & Spelke, 2008](#)) and memory for picture orientation ([Gregory et al., 2011](#)). Consistent with general left-right difficulties observed in human children, researchers working with animals have reported extreme difficulty teaching animals to associate a different sound with each side of their body (e.g., to lift the left paw when hearing a ring and the right when hearing a buzz; see [Corballis & Beale, 1976](#) for a review).

A challenge to the idea that left-right concepts are undeveloped is that children (and non-human animals) *do* show sensitivity to left-right relations in some navigation tasks: after becoming disoriented (through turning in place), they detect and use left-right relations in the shape of the boundary (e.g., [Lee & Spelke, 2010](#)) and possibly other features of the environment ([Nardini, Atkinson, & Burgess, 2008](#); [Twyman, Friedman, & Spetch, 2007](#)). Nevertheless, the representations that support their successful use of left-right relations when they are disoriented may be limited in their potential to support word learning. First, these spatial representations might be informationally encapsulated as some researchers have suggested (e.g., [Hermer & Spelke, 1996](#)) and therefore inaccessible to the language system. Second, they might be implicit, with behavior consistent with left and right knowledge emerging from other elements of spatial knowledge (e.g., distance to environmental boundaries), but not explicitly represented. Third, the concepts of ‘left’ and ‘right’ that are evident in reorientation tasks are more limited to those that need to be learned in language; children only need to invoke egocentric left and right in reorientation ([Wang & Spelke, 2002](#)), whereas full mastery of non-egocentric left and right is required for learning a relative language. Fourth, children may be less likely to entertain a secondary axis as the source of possible meanings for the novel words. That is, whereas children might be able to entertain left and right concepts in reasoning about space, they might not assume that different words would label identical-looking sides.

If children’s difficulty with left-right language lies in the low salience of the left-right dimension, then instruction that increases this salience might enhance children’s learning of these terms. Additionally, if the difficulty lies in the fact that meanings tied to a secondary axis are dispreferred, then instruction that emphasizes the sides of the body (secondary axis) and rules out a competing interpretation (e.g., geocentric or primary axis) should help them zero in on the body as the source of the meaning of left and right. Indeed, our Experiment 3 provided hints that the acquisition of “left” and “right” is made less difficult when the words are systematically introduced on the child’s own body. Using body-centric phrases (e.g., “this your ZIV arm”), 4-year-olds *were* eventually able to learn left-right meanings for parts of their bodies. Children learned that their ZIV (left) arms were still

their ZIV (left) arms and had not become their KERN (right) arms after they turned 180 deg, and they succeeded in a game with body-based instructions (e.g., “wiggle your KERN arm”). Experiment 3 thus raised the possibility that left-right terms are at least minimally learnable at this age. However, it left unanswered how flexibly children could extend the body terms to novel situations via extension, translation, and rotation. Experiments 6–8 therefore address the learnability of different aspects of left-right FoR terms.

7.2. Overview of Experiments 6–8

In Experiment 6, we emphasized from the very beginning that the meaning of the novel words was body-centric, i.e., associated with sides of the body. In addition to body-centric instructions, we used a bracelet to temporarily make the child’s left and right sides physically different and break the symmetry between the left and right sides. Placing a bracelet on one arm might help the child to realize that his ZIV arm is always his ZIV arm no matter where he turns, because the bracelet is still on the same arm. With the bracelet removed, we then addressed the problem of extension by asking whether children could correctly apply the novel words to talk about objects to their sides.

In Experiment 7, we addressed the problems of translation and rotation, two problems raised by the relative frame of reference. Because relative frames of reference involve computing relationships with three objects, rather than the two used in intrinsic frames of reference, relative frames of reference are computationally more difficult than intrinsic ones. Intrinsic frames include those that refer to the parts of the body (the left side) as well as extensions of this reference frame (to my left). Relative frames, however, always require translation to a different ground object. They can also require rotation to a different perspective. One question is whether children can flexibly extend simple, newly-learned egocentric spatial terms to novel contexts in a relative frame of reference.

In Experiment 7, we explored whether children could easily extend their newly learned ZIV and KERN meanings, via translation to a new figure and ground. We assessed how children interpret relative frame of reference expressions such as “Which envelope is to the ZIV of the cup?”. Do they systematically choose an appropriate option? If they are systematic, do they prefer an interpretation that aligns with a direct projection like Hausa (Fig. 2a) or a rotated projection like Tamil (Fig. 2b)?

Experiment 8 explicitly addressed the problem of rotation. We asked whether children could learn labels for, or even attend to, the left and right sides of a doll. In other words, can they learn the non-egocentric sense of “left” and “right” when given consistent and structured input emphasizing the body-centric origins of these terms? Previous work suggests that the mental rotation involved in computing and attending to the left-right axes of other objects is a relatively difficult spatial problem both for children and adults (e.g., Dehaene et al., 2006; Piaget & Inhelder, 1971). Nevertheless, such labels might be easier for children to learn if they are given clear information about how to apply left-right spatial terms to non-egocentric origins.

In all of the studies, we tested 4- and 5-year-olds and used the structured input method developed in Experiments 1–5 to understand children’s interpretations of novel words. We systematically varied the input children received about the novel spatial words and tested how they interpreted and extended these meanings. Specifically, we directly compared children’s ability to learn spatial terms depending on the reference axes (front-back vs left-right), type of spatial relations (intrinsic vs. relative), and egocentricity (own vs. other’s left-right). We also gave feedback to guide them toward specific intended meanings to see which meanings were learnable under what input conditions.

8. Experiment 6: body-centric vs. neutral input

8.1. Experiment 6: rationale

Experiment 6 built on the prior experiments by extending our detailed exploration of geocentric FoR acquisition to egocentric left-right. In Experiment 3, although children were asked to identify their body-parts with novel words (“raise your ZIV arm”), these words were introduced in an ambiguous sentence context that might have minimized children’s body-based interpretations. In Experiment

6, we highlighted the body-centric interpretations with unambiguous instructions, emphasizing from the outset that the meaning of the novel words should be associated with sides of the body. In addition, we gave the child a bracelet to wear on just one hand, in order to differentiate and break the symmetry between the left and right sides.⁴ The bracelet was removed after a few turns so that children had to encode the new terms in memory rather than continually use the bracelet as a cue to the terms' meanings. We asked whether these instructional changes affect children's initial interpretations and subsequent acquisition of left-right meanings.

A second goal of Experiment 6, going beyond Experiment 3, was to explore whether children could extend newly learned egocentric spatial terms to objects at their left or right sides. Accordingly, after the body-focused word introduction, feedback and post-test trials used objects placed on the children's sides (as in Experiment 1).

A third goal was to explore the effects of different settings on word acquisition, akin to Experiment 5's featureless room. Accordingly, children were tested in either the regular or the round room. We wondered whether the rich setting might support an environment-based frame of reference that would compete with the body-based frame of reference targeted here.

8.2. Experiment 6: methods

Twenty 4-year-old children (mean 4;6, range 4;2–4;10; 9F) were recruited. Half of them were tested in the regular testing room of Experiment 1 while half were tested in the round room of Experiment 5. These children were compared to the group of 20 children (mean 4;5, range 4;2–4;11; 10F) assigned to the left-right condition in Experiments 1 and 5. All methods followed Experiment 1, with one exception: children in Experiment 6 received body-centric instructions instead of neutral instructions during the word introduction phase (see [Appendix A](#) to compare the Basic Neutral Script of Experiment 1 with the Body-centric Script of Experiment 6).

The body-centric script started by emphasizing the child's body as the source of the word meanings ("Your body has two sides, a ZIV side and a KERN side") and connected the label to the child's sides as well as to specific parts (e.g., "this is your ZIV side" and "this is your ZIV arm"; see [Appendix A](#), body-centric introduction). This body-centric instruction was accentuated by putting a bracelet on one of the child's arms and explaining that the side with the bracelet was the ZIV arm. The bracelet stayed on throughout training and was removed between feedback trials 8 and 9.

8.3. Experiment 6: results

8.3.1. Pretest and word introduction

We found chance performance on the pretest (50% correct, defined as consistent with "ZIV" being left and "KERN" being right, $t(19) = 0.03$, $p = .97$). Children learned the words quickly, performing above chance on the probe (89% correct $t[19] = 12.91$, $p < .001$, $d = 2.9$) and object-switch trials (95%, $t[19] = 13.08$, $p < .001$, $d = 2.9$).

8.3.2. Bias test

Trials at the center and corner of the room did not differ and were collapsed for analysis ($t[19] = 1.45$, $p = .16$; Wilcoxon $Z = -1.42$, $p = .16$; MH std = 2.83, $p = .16$; n.s.). The distribution of geocentric⁵ responses was non-normal (Shapiro-Wilk $W = .78$, $p < .001$; [Fig. 5f](#)). Three of 20 children gave predominantly geocentric responses (three or four geocentric responses out of 4 trials), and nine of 20 children gave predominantly egocentric responses ([Fig. 4e](#), right stacked bar). This contrasted with the neutral-instruction group (Experiment 1), in which 12 of 20 children gave predominantly

⁴ Our decision to mark only one hand was also influenced by findings from [Newcombe and Huttenlocher \(1992\)](#). In their study, they asked similar-aged children to identify objects next to "sticker" hands. Children were more often confused about the referenced hand when both hands were marked with distinct stickers ("The Donald Duck side" vs. "The Mickey Mouse side.") than when only one hand was marked ("The sticker side" vs. "The other side").

⁵ The analyses are reported in percentage of geocentric responses to be consistent with previous experiments. To obtain the percentage of egocentric responses simply requires subtracting the percentage of geocentric condition from 1.

geocentric responses and four of 20 children gave predominantly egocentric responses, $\chi^2(2) = 8.66$, $p = .01$, Fisher's Exact $p = .02$ (Fig. 4e, left stacked bar and Fig. 5e).

There was no hint that participants were more likely to entertain geocentric interpretations in the regular room (48.8% geocentric) than in the round room (55.0% geocentric). In a 2 Instruction (body-centric, neutral) \times 2 Room (round, rectangular) ANOVA with the percentage of geocentric responses as the dependent variable, we did not find a main effect of Room, $F(1,36) = .164$, $p = .69$, nor of Room \times Instruction, $F(1,36) = 1.473$, $p = .23$. We did find a main effect of Instruction, $F(1,36) = 8.018$, $p < .01$, $\eta_p^2 = .182$ (Fig. 6e), indicating that the children were significantly less likely to have a geocentric response when given body-centric instructions.

8.3.3. Structured feedback and posttest

Children learned left-right meanings significantly faster with body-centric instructions than they did with neutral instructions. Given body-centric instructions, they reached the criterion for successful learning (8 correct answers in a row) after 16 trials compared to 21 with neutral instructions. In a 2 Instruction (neutral, body-centric) \times 2 Room (round, rectangular) ANOVA with the number of trials to criterion as the dependent variable, we found a main effect of Instruction, $F(1,36) = 7.379$, $p = .01$, $\eta_p^2 = .17$, confirming that when the instruction was body-centric, children reached criterion earlier. We did not find a main effect of Room, $F(1,36) = 1.225$, $p = .28$, or Room \times Instruction interaction, $F(1,36) = .428$, $p = .52$.

Posttest scores were higher for children with body-centric instructions than with neutral instructions, 82% vs. 61% correct (Fig. 6e). A 2 (Instruction: neutral, body-centric) \times 2 (Room: round, rectangular) ANOVA, with percent correct as the dependent variable, revealed a main effect of Instruction, $F(1,36) = 5.20$, $p = .029$, $\eta_p^2 = .13$, and no main effect of Room, $F(1,36) = .469$, $p = .50$, nor of Room \times Instruction, $F(1,36) = .07$, $p = .79$. Thus, the context in which the word was introduced affected children's acquisition of left-right meanings: body-centric language helped children latch onto the body-centric meanings of novel left-right terms. Testing space did not affect word learning.

8.3.4. Real word test

Children in the body-centric instruction group scored 58% percent correct on their knowledge of the real words "left" and "right," marginally above 50% chance ($t[19] = 2.04$, $p = .06$, *n.s.*, $d = .3$). Real word knowledge did not correlate with geocentric responses on the bias assessment (Pearson's $r = .074$, $p = .76$), number of trials to criterion during structured feedback ($r = .136$, $p = .57$), or post-test scores ($r = -.025$, $p = .92$). This was similar to the pattern observed in children who had received neutral instructions (from Exps. 1 and 5, regular room): they scored above chance as a group on real words "left" and "right" (67.3% correct; $t(18) = 2.3$, $p = .03$), but the percent correct on this test did not correlate with performance on the bias assessment ($r = .02$, $p = .93$), number of trials to criterion ($r = -.33$, $p = .17$), nor post-test scores ($r = .22$, $p = .36$). Thus, children's actual "left" and "right" knowledge cannot fully explain their interpretation or learning of "ZIV" and "KERN," our stand-ins for those real words.

8.4. Experiment 6: discussion

Prior studies demonstrated the difficulty of learning egocentric "left" and "right," in contrast to learning egocentric "front" and "back" and environment-based terms like "north" and "south." Experiment 6 revealed that 4-year-olds *could* successfully learn left-right word meanings in a single session if the words were introduced in a body-centric context. Their success at this task suggests two important conclusions. First, despite children's tendency to use environment-based frames of reference along the left-right axis in several circumstances, they can be taught egocentric "left" and "right."

Second, this experiment provides suggestive evidence about the mechanism that children use to learn the egocentric frame of reference. Children can realize that egocentric terms are body-based if they are explicitly used to describe their own bodies. They can learn to associate physical and proprioceptive differences (e.g., bracelet/no bracelet, dominant/non-dominant hand) with egocentric terms such as "my left" and "my right." They might further notice that when they turn around, the words tied to these physical differences turn with them. By contrast, when children first hear spatial phrases with

egocentric meanings without body-based references (e.g., “Get the plate on your left”), they might mistakenly interpret them as environment-based terms.

The successful learning observed here implies two mechanisms that likely support the acquisition of left and right: (1) proprioceptive cues that break the symmetry of the body, and (2) constancy of the terms while the body is rotated. This account echoes common methods that adults use to teach children left and right (e.g., telling them that they write with their right hand), and children’s reports about how they learned left and right (e.g., noting which arm they broke or which hand has a prominent freckle). Even so, it remains to be seen whether this account fully describes children’s learning of left and right under more natural conditions.

Another unanswered question is whether children’s learning of the word meanings was supported by the bracelet, the body-based instructions, or both. We suspect that the bracelet is unnecessary because children can readily learn labels for the left and right sides of their own bodies without the aid of a bracelet after playing a dance game similar to the one here (“Can you shake your ZIV leg?” Experiment 3; see also Shusterman & Spelke, 2005). Nonetheless, the bracelet in conjunction with the body-based instructions might have lowered the working memory demands of the task, enabling the children to map the terms more easily and benefit more rapidly from the instructions and feedback.

In sum, Experiment 6 revealed that egocentric left and right were not too difficult for children to quickly acquire, and that children quickly solved the problem of extending these terms beyond their own bodies. Experiment 7 explored the generality of their newly learned word meanings.

9. Experiment 7: projecting body-centric terms

9.1. Experiment 7: rationale

Experiment 7 served as a replication and extension of Experiment 6. In Experiment 6’s word introduction phase, children were introduced to ZIV and KERN on their bodies and provided cues that ZIV and KERN could apply beyond their own bodies. They were also exposed to such cues during the pretest, when they were asked to choose the container with the prize on the basis of objects located on their ‘ZIV’ and ‘KERN’ sides. In Experiment 7, children received no such pretest, and were exposed to a similar script that *only* introduced ZIV and KERN as body-centric terms. Then we assessed how flexibly children could use these terms in two generalization tests. In the *intrinsic trials*, children heard these novel words in intrinsic frames of reference expressions for the first time, of the form “X is to the ZIV of you.” We assessed how easily they used these words to pick out objects to their sides. In the *relative trials*, we tested how children spontaneously interpreted relative frame-of-reference expressions of the form “X is to the ZIV of Y”, where Y is an entity other than the child.

We used two different types of relative trials. Half of the children were asked to interpret relative expressions using a non-fronted object – a cup – to see whether they could impose axes onto the cup, and whether they would follow a standard convention for doing so (e.g., transferring their own egocentric axes onto the cup). The other half of children were asked to interpret relative expressions using a fronted object – a doll – to see whether children would integrate the doll’s axes into their interpretations of these expressions. On half of the doll trials, the doll’s frame of reference conflicted with the child’s axes (e.g., the doll’s left was on the child’s right). These generalization trials allowed us to see whether the doll’s axes would influence the child’s choices in interpreting the novel word meanings. If children’s responses changed with the doll’s turn, then it would imply that they considered that the doll also had a ZIV and a KERN side like themselves. Further, if children’s responses differed between the cup and the doll condition, it would imply that they were sensitive to the doll’s orientation in computing the meanings of ZIV and KERN. Thus, the two tests in Experiment 7 assessed how readily children solved the problems of *extension* beyond their own body (intrinsic trials) and *translation* to a new coordinate origin (relative trials). In addition, the relative trials with the doll allowed us to assess children’s spontaneous solution to the problem of *rotation* (relative trials with fronted object).

9.2. Experiment 7: methods

9.2.1. Participants

Thirty children (mean 5;0, range 4;0–5;9, 14F) were recruited and tested at the Museum of Science, Boston. The children were tested individually in a corner of an exhibit hall. An additional three children were tested but excluded because they scored 0% correct on the last two memory check trials (see below).

9.2.2. Word introduction (8 trials)

Children were introduced to novel spatial words, “ZIV” and “KERN”, using a script similar to Experiment 6 (see [Appendix B](#) for Experiment 7 and [Appendix A](#) for Experiment 6). Unlike Experiment 6, the novel words only referred to sides or body parts of the child (e.g., “This is your ZIV hand”), and were not used in examples as directional terms to describe locations of objects outside the child’s own body (e.g., “This toy is to the ZIV of you”).

Children answered eight questions involving body-parts during the Word Introduction. Four were probe questions that tested whether they paid attention (“I am putting a bracelet on your ZIV hand. ... Which hand did I put the bracelet on – ZIV or KERN?”). Four were switch questions to see whether children could extend the novel terms to new body parts (e.g., “Can you raise your ZIV leg?”). If the children did not respond correctly, the experimenter gave corrective feedback.

9.2.3. Intrinsic language generalization (8 trials)

On each trial, the experimenter placed two identical-looking envelopes, one on either side of the child. The child was told that one of the envelopes contained a sticker inside, and then asked the child to point to the envelope with the sticker (“The sticker is on the ZIV side. Can you show me the envelope on the ZIV side?”). The dependent measure was which envelope the child chose. The child was allowed to open the envelopes for the first two trials. For all remaining trials, including the relative language trials below, the child was asked to refrain from opening any envelopes. After four trials, the child was turned 180 deg and tested on four more trials. The turn manipulation revealed whether the child mapped the novel terms onto their body or to the environment. The experimenter kept the selected envelopes in a pile to be opened after the experiment.

9.2.4. Relative language generalization (12 trials)

Children were randomly assigned to the Fronted Object or Non-Fronted Object condition ($n = 15$ in each). In the Non-Fronted condition, the object was a red cup, a ‘non-fronted’ object that lacks a front-back axis. On each trial, two identical-looking envelopes were placed on either side of the red cup and the child had to identify the target envelope from the experimenter’s instructions (“The sticker is on the cup’s ZIV side. Can you point to the envelope on the cup’s ZIV side?”). In these sentence frames, the cup is the ground object and the envelope/sticker is the figure object. The objects were positioned either directly in front, to the left, or to the right of the child ([Fig. 8a–c](#)), with four trials per position. In all cases, the experimenter sat facing the same direction as the child, but slightly behind to one side.

In the Fronted condition, the instructions were mostly identical to the Non-Fronted condition. A doll, which has a front-back axis, replaced the cup. For all three positions ([Fig. 8a–c](#)), the doll was faced the same way as the child for two trials and was turned to face the opposite direction for two trials. The turn midway through each 4-trial block was noted by the experimenter (“Look. I am turning the doll.”). As before, children answered queries about ZIV and KERN (“Can you point to the envelope on the doll’s ZIV side?”).

9.2.5. Memory check (4 trials)

At two different points in the experiment, children were polled to see if they still remembered how the novel words referred to their own body. The first time was right after the child turned 180 deg during the intrinsic language generalization trials. The second time was at the end of the experiment. Children were asked to raise their arms (“Can you raise your ZIV arm?”), once for ZIV and once for KERN, with order counterbalanced across children and no feedback given. The purpose of the memory check was to verify that children had learned ZIV and KERN during the Word Introduction phase. If

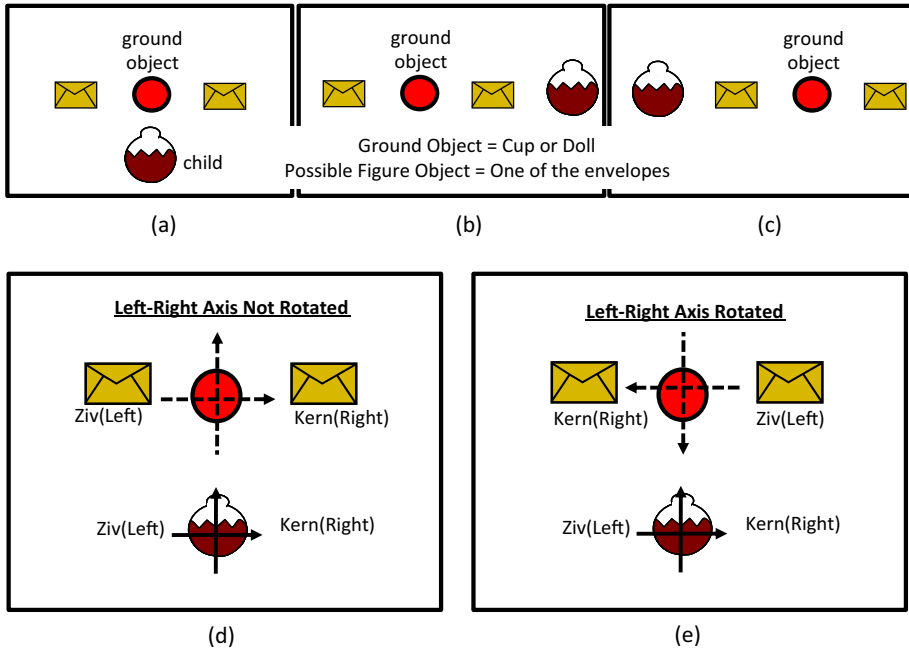

Fig. 8. Testing for systematic relative frames of reference interpretations of ZIV and KERN in Experiment 7. (a–c) Depicts the setup of the envelopes and cup in relation to the child during testing. (d and e) Depicts two possible interpretations for ZIV and KERN when the cup and envelopes are placed in front of the child.

children failed the memory check, there was no reason to expect that they would be systematic on the novel extensions of the spatial words. In line with Experiment 6, which showed that children were able to fast-map and retain these new words, the average percent correct for the memory trials was high (91.7% correct, $t(32) = 13.01$, $p < .001$, $d = 2.3$). With the exception of three children out of 33 tested, all children scored at least 75% correct on these four trials. The three children reversed ZIV and KERN at the second time point, scoring 0%, while all other children scored 100%. Because we were interested in how children who had learned the words as body parts extended these words to novel situations, we excluded these three children from analyses.

9.3. Experiment 7: results

9.3.1. Word introduction

Children learned the words quickly, performing above chance on the probe questions (96.7% correct, $t(29) = 23.55$, $p < .0001$, $d = 4.3$) and object switch questions (88.3% $t(29) = 11.50$, $p < .0001$, $d = 2.1$).

9.3.2. Intrinsic language generalization

Children correctly indicated the envelope to their immediate left and right sides 95% of the time, compared to 50% chance, $t(29) = 24.23$, $p < .0001$, $d = 4.4$. Further analyses divided the four trials prior to the 180-deg turn and the four trials after the turn (Fig. 9a). Performance was 95% for both sets of trials, $t(29) < .001$. Children were almost always correct, even on the very first trial. Thus, as in Experiment 6, children were easily able to extend the terms ZIV and KERN to objects at their sides.

9.3.3. Relative language generalization

Analyses of the relative language trials assessed how children interpreted the novel terms. Did they systematically project their own axis onto the ground object (like Hausa, as in Fig. 8d) or did they

rotate their axis (like Tamil, as in Fig. 8e)? Did children treat the doll, a ground object with its own front-back axis, differently than the cup by considering the doll's orientation?

As a first pass, disregarding the type of ground object used, the children were typed according to whether they applied their own axis directly onto the ground object (Fig. 8d, no rotation) or rotated their own axis and applied it onto the ground object (Fig. 8e, rotation) for each of the three placements of cup/doll and envelopes shown in Fig. 8a–c. The first three columns of Fig. 9c show the results for the three positions. To be typed, children had to respond in the same way for at least 3 out of the 4 trials tested in each position. Those who did not meet this criterion were considered “Untypable.” Finally, children were typed for their consistency across all 12 relative trials. Here, they were typed two ways, using both a relaxed criterion of a consistent response on nine out of 12 trials (Fig. 9c, column 4; $p = .05$ on binomial test) and a stringent criterion of a consistent response on 11 of 12 trials (Fig. 9c, column 5; $p = .002$ on binomial test). As seen in Fig. 9c, the majority of children transferred their own axis, without rotation, to reliably interpret relative uses of ZIV and KERN. Impressively, more than half of them did so consistently across all 12 trials regardless of whether the ground object was in front or to one side of them.

To address whether children considered the orientation of the ground object, we compared responses to the fronted object (doll) and the non-fronted object (cup). The percentage of trials in which children applied their own axis directly onto the ground object (see also Fig. 9b) was entered into a Mixed ANOVA with Ground Object as a between-subjects variable (2 levels: cup, doll) \times Position as a within-subjects variable (3 levels: front, left, right) ANOVA. There was no effect of nor interaction with Ground Object, suggesting that children did not consider the orientation of the doll in their responses (Ground Object: $F(1,28) = .49$, $p = .49$, n.s.; Ground \times Position: $F(2,56) = .33$, $p = .72$, n.s.). There was also no effect of Position ($F(2,56) = .53$, $p = .59$, n.s.).

To examine this question more closely, we also focused on the 15 children in the doll condition. We compared the six trials in which the doll faced the same direction as the child with the six trials in which the doll faced the opposite direction from the child (Fig. 9d). There was no difference in responses across the two facing directions (Wilcoxon signed-ranks, $Z = -.17$, $p = .86$). When the child and the doll faced opposite directions, the majority of the children still interpreted ZIV and KERN with respect to their own left and right rather than with respect to the doll.

Finally, taking the direct projection of one's own axis onto the ground object as the “correct” response, performance on the relative trials was contrasted with performance on the intrinsic trials (compare Fig. 9b with a). Performance was worse on the relative (relative: 82% “correct” vs. intrinsic: 95% correct, $t(29) = 12.718$, $p < .0001$). The relative trials required children to consider translational movement, because the center of the coordinate system was not their own body but rather a separate object (i.e., the ball or the doll), and this computation carried a cost. Nonetheless, for the relative trials, the majority of the children projected their own axis onto the ground object above chance, 81.7% correct, $t(29) = 6.831$, $p < .0001$, $d = 1.2$. This suggests that upon learning how the novel words refer to their bodies, English-speaking children have reasonable guesses about how these words can be used in relative frame-of-reference expressions: they directly project their own left-right axis onto the new ground object.

9.4. Experiment 7: discussion

The Word Introduction phase of the current experiment replicated Experiment 6 by demonstrating that children can learn the novel words ZIV and KERN as referring to sides of their bodies. They appropriately extended the words to various body parts. In addition, whereas children were given two instances of how to extend ZIV and KERN to objects at their sides in Experiment 6, the current experiment asked whether they could spontaneously do so without any prior examples. Indeed they could, suggesting that there were no major conceptual barriers to extending egocentric left-right axes beyond their bodies. Experiment 7 further tested whether children could spontaneously understand and interpret relative uses extending the novel terms to new ground objects. We found that children were systematic in their responses. As a group, they overwhelmingly adopted their own body's coordinate system and applied it directly onto the ground objects in order to select the correct (ZIV or KERN) figure objects.

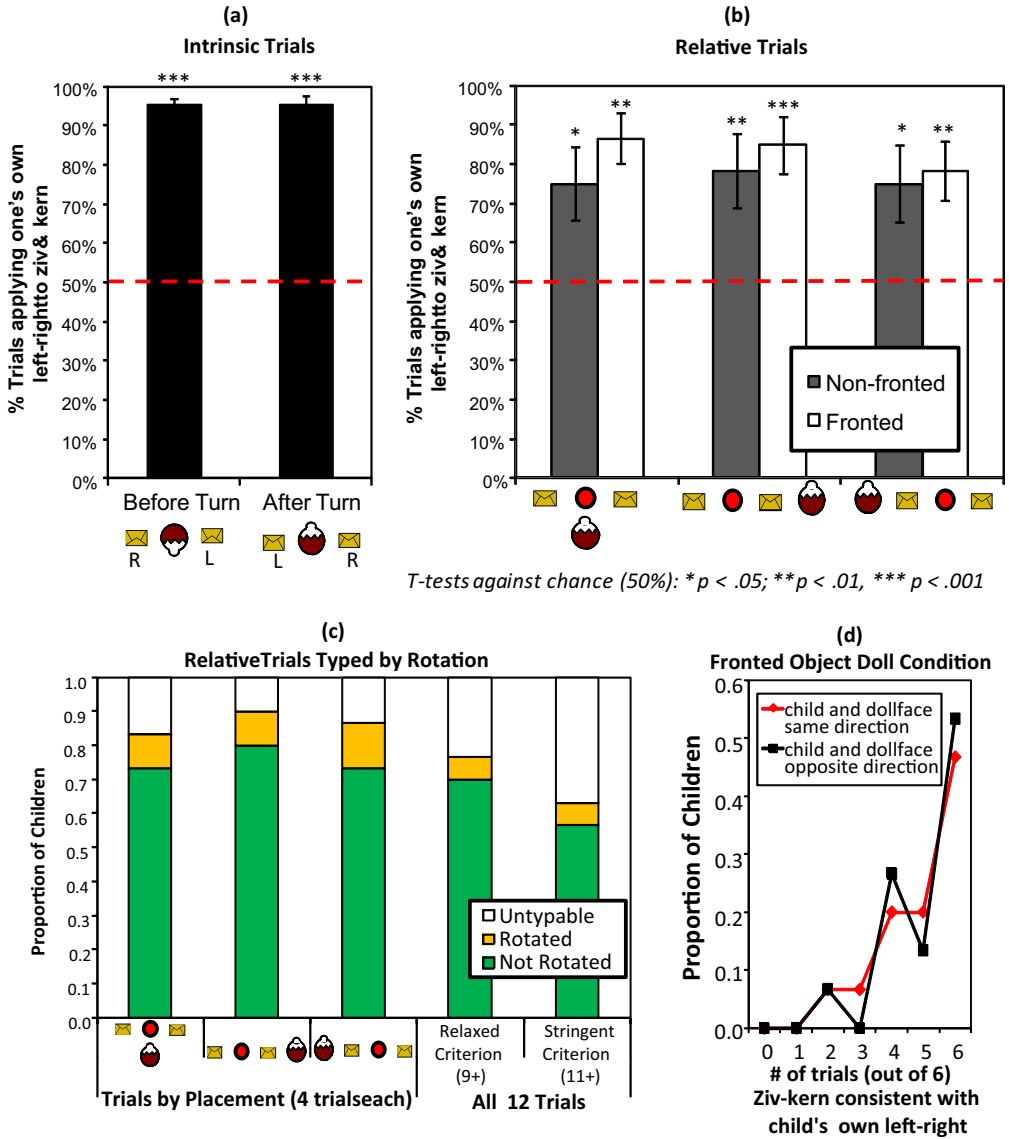

Fig. 9. Comprehension of ZIV and KERN in novel contexts (Experiment 7). (a and b) Show the percentage of trials where child applied their own left and right to the ground object. (a) Intrinsic trials where the child served as the ground object. See Fig. 8a for setup. (b) Relative trials where either a cup or a doll served as the ground object. See Fig. 8b and c for setup. Asterisks indicate *t*-tests against chance (50%): * $p < .05$; ** $p < .01$; *** $p < .001$. (c) Children's responses on all relative trials (doll and cup) typed by how they applied the ZIV-KERN axis to the doll or cup (rotated or unrotated with respect to their own left-right axis; see Fig. 8d and e). (d) For doll trials only, children's responses separated by whether the doll the same or different direction than the child. Children tended to align ZIV and KERN with their own left and right sides, regardless of which way the doll was facing.

The tendency of children to project, rather than rotate, their own axis onto a ground object directly in front of them (Fig. 8d vs. e) concurs with developmental studies of how children learn body-centric words like “left,” “right,” “front,” and “back” under natural circumstances (see Levinson, 2003 for a review). These studies showed that children learning languages that have rotated axes as conventions

often go through a stage in which they do not rotate the axes. For example, in learning relative uses of “front” and “back,” many English-learning children do not correctly adopt the convention of rotating the front-back axis when using a non-fronted object as the ground to talk about spatial relations to other objects (as in Fig. 2c, English example). Instead they first project their own front-back axis on to the cup (as in Fig. 2a, like Hausa), only later adopting the traditional English convention. Together, these results suggest that children do not have a problem computing relative relationships when their own perspective is involved. Rather, they may struggle with computing spatial relationships that require axis rotation, and with learning how such relationships are conventionalized in their language.

The results of Experiments 6 and 7 demonstrate that children do not have much difficulty with two of the three problems of left-right relations: extension beyond their own body and translation to a new coordinate origin. Experiment 7 further demonstrates that English-speaking children are not naturally inclined to rotate the coordinate axis when project novel terms to the left-right sides of a doll or a non-fronted object. In Experiment 7, children ignored the doll’s left-right axes, but they were not given any particular reason or motivation to attend to the doll’s orientation; they essentially treated the doll just like the cup. Nevertheless, it is possible that children can solve the problem of rotation too, if they are given sufficiently structured input that clearly demonstrates this convention. Experiment 8 tested this possibility.

10. Experiment 8: non-egocentric body-centric FoR

Experiment 8 (8A, 8B, and 8C) tested children’s word learning for a non-egocentric object-centered frame of reference. In Experiment 7, children did not rotate their own left-right axis and apply it to another object. However, they were not given any explicit instruction or reason to do so. Therefore, in Experiment 8, we taught them the novel terms directly *on* the doll. In previous comprehension studies, Rigal (1994) showed that children first identify the left and right sides of themselves at seven years old, but fail to identify the left and right sides of people facing them until nine years old (see also Piaget & Inhelder, 1971).

It is important to keep in mind that our studies are word-learning studies exploring the input conditions under which children can learn different meanings. Under natural learning conditions, there are at least two reasons why non-egocentric left and right might be difficult to acquire. First, children may lack relevant experience, if adults tailor their child-directed speech to talk about the child’s left and right more than any other kinds of left and right.⁶ More advanced speakers often tailor their spatial language to the level of the listener (Schober, 2009) and English-speaking children more often hear left-right language applied to themselves than to others (Martin & Sera, 2006). Second, children may not be conceptually ready to learn non-egocentric uses of left and right. Computing another person’s (or object’s) left-right requires one either to mentally rotate one’s own axes and apply them to another body, or to construct a truly “object-centered” mental representation that includes the left-right axis of that object. Either way, computing another person’s left and right seems to require spatial skills that are not required for determining one’s own left and right.

The structured introduction of the novel spatial terms allowed us to see whether children can learn the words on a doll when given clear instructions. We used the body-centric script that was successful in Experiment 6, but referred to the doll instead of the child’s own body (i.e., “The doll has a ZIV side and a KERN side.”). The experimenter and the child sat facing the same direction, to minimize the number of perspectives that the child would have to consider. The left-right instruction condition was contrasted with a front-back training condition, to determine which response patterns were specific to the non-egocentric object-centered frame of reference and which were specific to the left-right axis.

Experiment 8 contained three parts. In 8A, we assessed children’s initial interpretations of novel spatial terms (ZIV and KERN) when taught on a doll. In 8B, we assessed children’s ease of learning

⁶ The same possibility may apply also to the input of front and back. Kuczjac and Maratsos (1975) found that language comprehension of others’ “front” vs. “back” comes in after child’s own “front” vs. “back” despite the fact children know how to determine the front and back of animals and can line them up in a parade (Levine & Carey, 1982).

the doll's left and right when given feedback. In 8C, we used a non-verbal spatial memory task to further illuminate children's encoding and representations of FoRs relevant to the doll.

10.1. Experiment 8A: methods (Initial interpretations applied to non-egocentric entities)

10.1.1. Participants

Fifty-five children (mean 4;9, range 4;0–5;11; 33F) were assigned to either the LR (left-right; $n = 27$) condition or the FB (front-back; $n = 28$) condition. With the exception of eight participants who were tested in the laboratory (same 11×12 furnished room as Experiment 1), all participants were tested on a small stage in the corner of an exhibit hall at the Museum of Science, Boston. In-laboratory participants received a prize and travel reimbursement, and museum participants received stickers.

10.1.2. Word introduction (9 trials)

Children were given instructions about the meaning of novel spatial terms while they sat facing the same direction as the doll (Appendix C). For the left-right condition, the doll was in front of the child so that ZIV and KERN were aligned with the child's and the doll's left and (see Fig. 10a, Position 1). For the front-back condition, the doll was to the left of the child so that ZIV and KERN were aligned with the child's and the doll's front and back (see Fig. 10b, Position 1). Body-centric language was used (e.g. "This is the doll's ZIV side.") 8 Seven probe questions (e.g., "Can you point to the doll's ZIV arm?"; Appendix C) tested children's initial learning. Two object switch questions tested whether they could generalize the terms to new toys placed on the doll's ZIV and KERN sides.

10.1.3. Bias test (12 trials)

The bias test assessed whether children mapped the novel terms onto the doll's body (i.e., object-centered frame), onto the environment (geocentric frame), or onto their own bodies (egocentric frame). The bias was determined by comparing how the children interpreted ZIV and KERN before and after the doll and the child each moved. Their movements dissociated the three different frames of reference (see Fig. 10a for left-right condition and b for front-back condition).

For each trial, the child was asked about a set of two identical toys, one placed on each side of the doll ("Can you show me the toy on the ZIV side?"). No feedback was given. For the first four trials, the child and doll faced the same direction as the word introduction phase (Position 1, Fig. 10a for LR and b for FB). Then the experimenter turned the doll 180-deg (Position 2, Fig. 10a and b) and asked about new toys placed on the doll's ZIV and KERN sides for four trials. Finally, the experimenter turned the child 180 deg and asked the same question with new objects for four last trials (Position 3, Fig. 10a and b).

10.2. Experiment 8A: results

10.2.1. Word introduction

For the word introduction trials, performance on the probe questions was high (89% correct), as was performance on the object switch trials (84% correct). Comparing the FB and LR conditions, scores did not differ on the probe questions (FB: 87% vs. LR: 92% correct; $t(53) = 1.01$, $p = .32$, n.s.) nor the object switch questions (FB: 82% vs. LR: 85% correct; $t(53) = .31$, $p = .42$, n.s.), indicating that the two groups were comparably attentive to the task. All scores were above 50% chance (t -tests, FB: $t(28) > 4.36$, LR: $t(27) > 5.47$, $ps < .001$, $ds > .8$).

10.2.2. Bias assessment

Children were classified either as Egocentric (self-centric), Object-centered (doll-centric), or Geocentric (environment-centric) if they gave at least 11 of 12 responses consistent with one of those frames of reference. They were otherwise classified Untypable (Fig. 11). Although the novel words were introduced in identical doll-centric sentences in both conditions, the LR and FB groups differed in their interpretations of ZIV and KERN. While 46% of the FB children interpreted the novel words with respect to the doll, only 11% of the LR children did so (Fisher's exact $p = .007$). In contrast, the

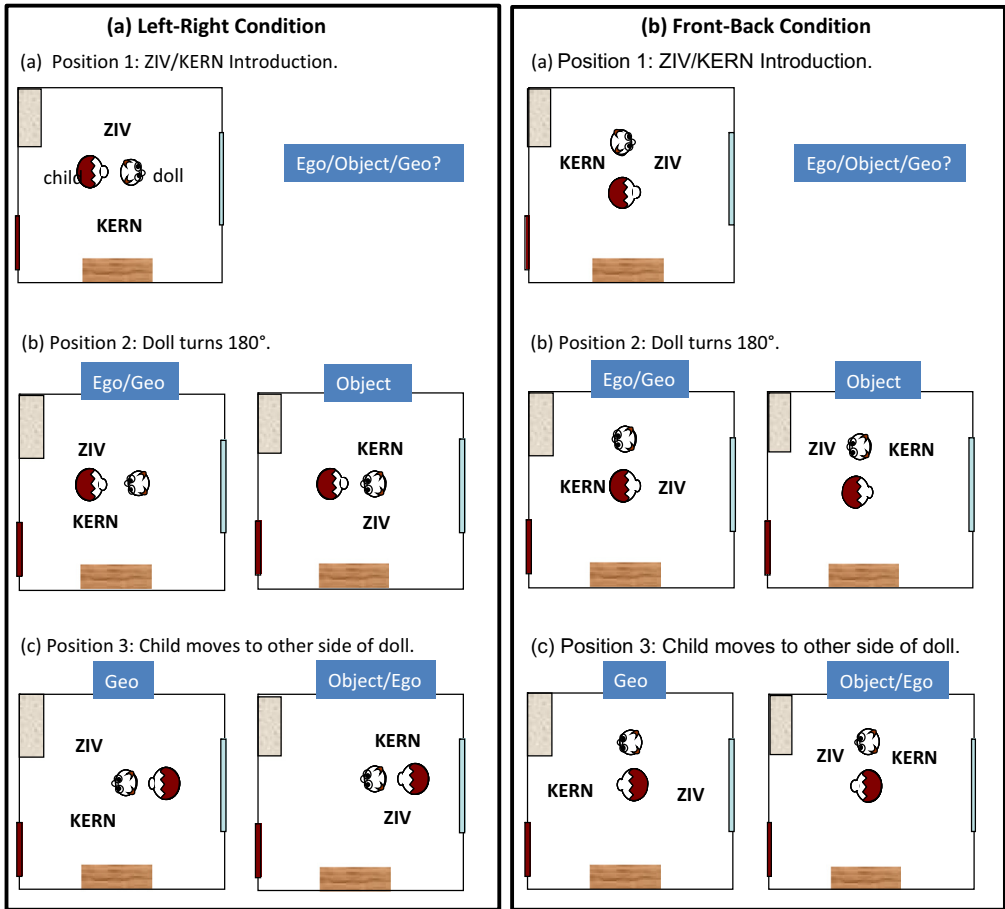

Fig. 10. Setup for Experiments 8A and 8B. The three facing directions of the doll and child for (a) LR condition and (b) FB condition. Position 1: Experimenter introduces the novel words followed by querying child of ZIV and KERN. Position 2: Doll turns followed by querying of ZIV and KERN. Position 3: Child turns followed by querying of ZIV and KERN. Boxes indicate the frames of reference that correspond to each possible response pattern. Thus, egocentric, (non-egocentric) object-centered, and geocentric frames of reference each correspond to a unique pattern of responses in Positions 2 and 3.

LR group tended to interpret the novel words with an environment-based (geocentric) frame of reference, while the FB group rarely did so (LR: 44% vs. FB: 7%, Fisher's Exact $p = .002$). Rarely did children in either group consider egocentric meanings by applying their own axes onto the doll (FB: 4% vs. LR: 11%, Fisher's Exact $p = .35$, n.s.).

10.3. Experiment 8A: discussion

With a doll-centric introduction on a doll's front-back axis, children preferred to use the doll's frame of reference in ascribing meanings to novel spatial terms (in other words, the non-egocentric object-centered meaning). In contrast, with an identical introduction on the left-right axis, children interpreted the novel words as having geocentric meanings, despite the fact that the instructions emphasized the doll's body. Thus, we see a difference between the front-back and left-right axis when interpreting novel spatial words, and a tendency to prefer a geocentric interpretation when learning terms for the left-right axis.

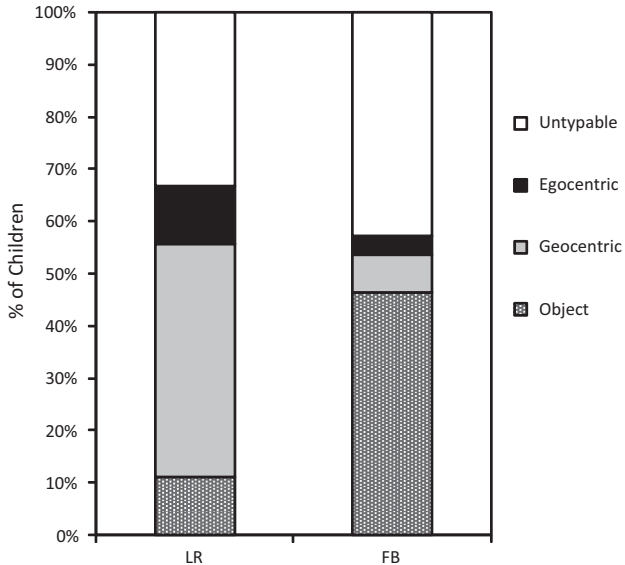

Fig. 11. Children typed by their biases for interpreting ZIV and KERN when introduced on either LR sides or FB sides of a doll (Experiment 8A).

11. Experiment 8B: learning non-egocentric terms through feedback

The word introduction in Experiment 8A left the interpretation of the meanings up to the children, and the data suggested that children spontaneously construed terms along the left-right axis as having geocentric meanings. Experiment 8B explored whether these children could learn the doll's "left" and "right" if they received structured feedback. A subset of the children in Experiment 8A participated in an immediate follow-up feedback session to see whether they could override their initial geocentric interpretations and learn the doll's left and right. The feedback followed the same body-centric script that was successful in teaching egocentric left-right in Experiment 6, but focused on the doll's body instead of the child's.

11.1. Experiment 8B: methods

11.1.1. Participants

Eight children (mean 4;6, range 4;3–4;10; 4F) from Experiment 8A participated in a structured feedback study and post-test. These children were all tested in the 11 × 12 furnished laboratory room of Experiment 6.

11.1.2. Structured feedback session (maximum 24 trials)

Feedback was given to disambiguate the novel words' meanings. Children received feedback consistent with the words meaning "left" and "right." Identical-looking envelopes were placed on the left and right sides of the doll. One contained a sticker and one was empty. The experimenter used "ZIV" or "KERN" to disclose the location of the hidden sticker ("The sticker is on the doll's ZIV side"). Children chose an envelope and were allowed to open it immediately. Correct envelopes contained stickers. Incorrect envelopes were empty. Trials were blocked in 6-trial sets. The doll turned 180 deg between each block. At each turn, the experimenter said "Look! I am turning the doll." Feedback ended after eight consecutive correct responses or after 24 trials, whichever came first.

11.1.3. Posttest (8 trials)

A post-test assessed whether the children learned doll-centric meanings (i.e., the doll's left and right). For the first four trials, the child and the doll sat as they did during the Word Introduction phase (Fig. 10a, Position 1). For the last four trials, the doll was turned 180 deg (Fig. 10a, Position 2). For each trial, identical-looking envelopes were placed at the sides of the doll, and the child had to point to the envelope indicated by the experimenter ("The sticker is on the doll's ZIV side"). The children were told that they would not open the envelopes until the very end.

11.2. Experiment 8B: results

During the structured feedback trials, no child gave eight correct answers consecutively, so all children completed all 24 trials. On average, children scored 54% correct on the posttest, not different from 50% chance, $t(7) = .41$; $p = .69$, n.s., $d = .15$. Thus, there was no evidence that children learned the non-egocentric meanings of "left" and "right."

11.3. Experiment 8B: discussion

Although 4-year-olds can be taught egocentric (i.e., their own) left-right when the body-centric meanings of the terms are emphasized (Experiment 6), they seem to be unable to learn non-egocentric (i.e., a doll's) left-right even when the doll-centric meanings of the terms are emphasized (Experiment 8A and 8B). This difference in performance parallels the late acquisition of non-egocentric left-right in typical development, and suggests that there is some additional skill required for non-egocentric left-right that is not required for egocentric left-right.

Experiments 8A and 8B show that children have difficulty learning words for the left and right of another entity. However, this could be a failure to understand the communicative intent of the speaker rather than a conceptual problem. In Experiment 8C, we explored whether children have difficulty conceptually representing the left and right sides of another object (a doll). Instead of a word extension task, we used a spatial memory task in which children had to track coins hidden in the doll's left or right pockets.

12. Experiment 8C: non-egocentric object-centric representations

12.1. Experiment 8C: methods

12.1.1. Participants

Forty-six children who completed Experiment 8A, but not 8B, participated in Experiment 8C. Children were assigned to the same conditions they were assigned to for Experiment 8A; 19 of the children were in the LR condition, and 27 were in the FB condition.

12.1.2. Procedure

Children were introduced to a doll with two empty pockets. For the children in the FB condition, the pockets were on the front and back of the doll. For children in the LR condition, the pockets were on the left and right of the doll. For each trial, children watched as the experimenter hid a coin in one of the pockets. Children were told to remember where the coin was hidden. They then closed their eyes and counted with the experimenter to five. Finally, with eyes open, children were asked to point to the pocket with the hidden coin. The experimenter then opened the pocket(s) to reveal whether the correct pocket was chosen.

There were six trials. For the first pair of trials (Position 1), the doll remained stationary. For the second pair (Position 2), the doll was turned 180 deg after the child opened her eyes. For the final pair (Position 3), the child moved 180 deg to the other side of the doll after opening their eyes. Note that the orientation and movement of the doll and child for the three positions mirrored those of Experiment 8A (see Fig. 10).

12.2. Experiment 8C: results

Fig. 12 shows the results of the coin search for the LR and FB group by position. Correct score was entered into a 2 Condition (LR, FB) \times 3 Position (1, 2, 3) ANOVA, with Position as a within-subjects factor. We found a main effect of Condition, with the FB group outperforming the LR group (93% vs. 77% correct; $F(1,44) = 19.76$, $p < .001$, $\eta_p^2 = .31$). We also found a main effect of Position, $F(2,88) = 9.734$, $p < .001$, $\eta_p^2 = .18$, and a Position \times Condition interaction, $F(2,88) = 14.148$, $p < .001$, $\eta_p^2 = .24$. Specifically, whereas there was no effect of Position for the FB group (t -tests, $p > .43$), the LR group's Position 1 (100% correct) was better than Position 2, 58%; $t(18) = 6.10$, $p < .001$, $d = 1.4$ and Position 3, 74%; $t(18) = 3.75$, $p = .001$, $d = .9$. Position 2 and 3 did not differ statistically ($p = .14$), but t -tests against chance indicated that percentage correct was above chance for Position 3, $t(18) = 3.38$, $p < .01$, $d = .8$, and not Position 2 ($t(18) = 1.14$, $p < .21$, $d = .27$).

The fact that children performed worse on Position 2 is consistent with their difficulty in representing the left or right sides of other objects. For Position 1, neither the child nor the doll moved, so children do not necessarily have to represent the sides of the doll to succeed. They could remember the coin's location with respect to the environment (e.g., next to the window) and with respect to themselves (e.g., their left). For Position 3, only the child moved. Again, children could rely on the coin's location with respect to the environment, without relying on the doll's left or right, to successfully retrieve the coin. For Position 2, the doll moved and so the coin's location remained invariant only with respect to the doll. It is only by noting the facing direction of the doll *and* identifying the left or right side that the child could succeed at retrieving the coin.

Revealingly, children's chance performance on Position 2 (58% correct) was better than what was expected had they had entirely disregarded the doll's movement. That is, if they noted the relation of the coin either with respect to the environment or with respect to their own perspective, and did not factor in the doll's rotation, they would have always chosen the incorrect location (e.g., the side next to the window) and therefore be below chance. The 58% correct does not arise because of children who were always correct or always incorrect. The majority of the children (12 out of 19) scored exactly 50% correct. This suggests that although 4-year-olds, as a group, appreciate that the location of the coin is tied to the doll, they have difficulty tracking the coin's change of location when the coin is either in the left or right pocket.

12.3. Experiment 8C: discussion

This coin search task is not about word learning and communicative intent. Rather, it is a spatial memory task that has a right and wrong answer. Here, we found that children had no problems retrieving coins on the doll's front-back axis, but struggled with non-egocentric left-right. Because the set-up and procedure were directly analogous to the word-learning task in Experiment 8A, the failure to represent the doll's left and right in the non-linguistic task is revealing. Since children had difficulty tracking the left and right of the doll in Experiment 8C, it is logical that they would not even consider (Experiment 8A) or learn (Experiment 8B) non-egocentric object-centered left-right language (i.e., the doll's left and right).

These data begin to explain why children always learn the words "left" and "right" as applied to their own body before they ever learn how to talk about others' "left" and "right." The inability to correctly point to the "left" or "right" of other people (e.g., Rigal, 1994) has to do with the fact that children cannot represent those relationships. Other research suggests that the ability to compute others' left and right takes several years to develop (Lasky, Romano, & Wenters, 1980). Lasky et al. (1980) set up a tabletop display in which there was a clown face painted in the center and one hiding place to each side of the clown's face. Children who lost visual contact with the display could not locate an object hidden to either the left or right side of the clown at above chance level until about 9 years of age. Interestingly, this is around the age that Rigal (1994) reported that children learn the language for talking about other people's left and right.

One previous study suggests that it may be possible to teach 4-year-old children how to think about other people's left and right with a visual aid. Just as we marked one arm of the child with a bracelet, Newcombe and Huttenlocher (1992) marked one hand of the child with a sticker; they then

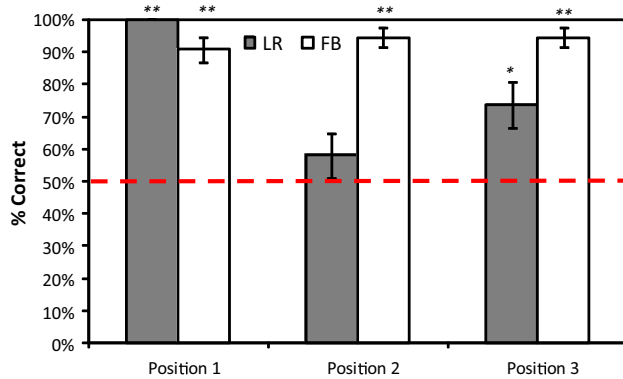

Fig. 12. Children's ability to retrieve a hidden coin from the doll's left-right pockets vs. the doll's front-back pockets (Experiment 8C). See Fig. 10 for the three positions. Asterisks indicate significance of t -tests against chance (50% correct): * $p < .01$; ** $p < .001$.

introduced and marked the same hand of a doll next to and facing the same direction as the child. Afterward, they showed the child how the doll looked when turned 90, 180, and 270 deg. In each case, they pointed out the hand of the doll with the sticker, subsequently removed the sticker from the doll, and asked which of the doll's hands would be the sticker hand at each position. Impressively, most 4-year-olds could correctly identify the correct hand. The success reported in [Newcombe and Huttenlocher \(1992\)](#), contrasted with the failure described here to represent a doll's left-right in Experiment 8, raises an obvious question about the underlying reason for this difference. We see two possibilities. First, perhaps helping children to note the correspondence between their own left-right and another's left-right, as Newcombe and Huttenlocher did, paved the way for success in their task. Second, Newcombe and Huttenlocher showed children the correct answer (how the doll would look with a sticker on one hand in each position) before testing them, whereas we asked children to generalize to new positions of the doll. Given Newcombe and Huttenlocher's introduction, could children identify the correct hand if the doll was situated at a new orientation or location, or identify the same hand of another doll or person? The limits of children's abilities should be explored by further research.

[Newcombe and Huttenlocher \(1992\)](#) also tested the perspective-taking abilities of three- to 5-year-old children, using a task in which children had to imagine the doll's perspective from different vantage points and report which item would be in a certain position from that vantage point. They reported above-chance performance even in three-year-olds for left-right problems (e.g., which item would be on the doll's sticker-hand side), indicating successful representation of non-egocentric left-right much earlier than we find here. However, chance was defined in that paper as 25%, since there were four locations. We hypothesize that children restricted their responses on each trial to the items on either side of the doll, but were indifferent about which side they chose (and excluding the front/back options). Such a response pattern would result in 50% correct responses, exactly what the paper reports. In sum, although even young children seem to be able to differentiate the left-right axis from a near-far or front-back axis, they seem to struggle profoundly with differentiating the left and right sides of an entity other than themselves and computing spatial relations based on a non-egocentric left-right frame of reference.

13. General discussions

The strategies and conventions that communities converge upon to talk about space vary greatly ([Levinson, 1996](#)), with some preferring geocentric (absolute) frames of reference and other preferring object-centered (relative) frames of reference. While these cross-linguistic variations have served as the starting point of many inquiries into the relationship between language and thought in adult

speakers (e.g., Levinson, Kita, Haun, & Rasch, 2002; Li & Gleitman, 2002; Li et al., 2011; Majid et al., 2004; Pederson et al., 1998), few have asked to what extent children are ready to learn the range of spatial words in the worlds' languages (Haun et al., 2006; Majid et al., 2004). The current experiments addressed this question by testing children in a systematic fashion through manipulating the input children hear about novel words, the environments in which they were introduced the words, and the axes to which these words were applied. These subtle experimental variations reveal nuanced patterns about children's readiness to learn spatial language.

In Part I, five experiments tested children's initial interpretations of and the ease of learning for the novel spatial terms. The results support the position that cognitive precursors allow children to easily learn geocentric meanings, contrary to older literature suggesting that children are predominantly egocentric and have difficulties considering alternative frames of reference (Acredolo, 1978; Piaget, 1928). In three of the experiments (Experiment 1–3), the majority of children interpreted the novel spatial terms with an environment-based frame of reference, and in all five experiments, children readily learned environment-based interpretations when given brief, structured feedback. Moreover, they inferred a great deal of information about the terms with very little exposure. They knew how to apply the terms to new facing directions, new figure objects, and new coordinate origins. Their ability to reason about environment-based FoR was based on abstract, conceptual representation of space and not on concrete features of the room (Experiments 2 and 5). They readily extended the meanings of the terms to cardinal directions to compute novel spatial relations both inside and outside the training room. The acquisition process documented in these experiments suggests that children "fast-mapped" geocentric meanings of novel spatial terms (Carey & Bartlett, 1978).

Of course, there are many ways in which children's semantic acquisition was not semantically complete or truly "geocentric." Understanding the basis of geocentric terms requires further learning and conceptual development. For instance, understanding the true meanings of *north* and *south* requires an understanding that the earth is a sphere, a concept that is acquired long after 4 years of age (Vosniadou & Brewer, 1992). Furthermore, when children learn geocentric terms in a natural linguistic community rather than in an artificial training study, they need to learn the conventions regarding how their language communities derive and use geocentric terms. Communities vary in how geocentric terms are derived (e.g., "north", "seaward", "uphill"), so children need to learn which elements are relevant to their language, especially if the word's origin provides no clues. Children also have to learn conventions about the scope of space to which these words apply (e.g., "uphill/downhill" in Tzeltal Mayan extend beyond the hill, but "uptown/downtown" in Manhattan does not extend beyond the island). Thus, even with a predisposition to understand that spatial terms might be geocentric, children in real language learning situations likely need to revise their initial lexical concept in order to accommodate both cultural conventions and conceptual change (Brown & Levinson, 2000; de León, 2001).

Nonetheless, what children surmised about the geocentric words' initial meanings is quite impressive. There was no evidence for slow and effortful learning. On the contrary, children's inferential machinery and spatial intuitions are rich enough to support spontaneous generalization of the new terms to novel circumstances. Our findings are consistent with Haun et al.'s (2006) and Nardini et al.'s (2006) conclusions that geocentric representations of space are readily available to children, and provide the first direct evidence that children's language acquisition draws upon these precursors. Furthermore, our findings are consistent with Huttenlocher and Presson's (1979) studies of school-aged children's performance on spatial perspective-taking tasks detailing the importance of the environment-based spatial framework in children's spatial cognition (see also Huttenlocher & Vasilyeva, 2003; Presson, 1980).

What is the relative status of geocentric representations versus object-centric frame of reference? Haun et al. (2006) suggested that there is an evolutionary bias for allocentric/geocentric representations, and that children will experience "relatively greater difficulty of acquiring a predominantly egocentric coding system" because they have to override the initial bias (p. 17572). Indeed, the 4-year-olds in the present study, like those in Haun et al.'s study, are from a culture that promotes relative concepts and preferentially uses relative language, and yet children appear to have less difficulty with geocentric reference frames than with egocentric ones. In three of our five experiments in Part I (Experiments 1–3), the majority of children showed a strong preference for the environment-based

interpretation; they did not even favor egocentric left-right interpretations when the spatial words had been used to describe body parts (Experiment 3). In Experiments 4 and 5, with increased salience of an egocentric reference frame (front-back) or decreased salience of an environmental reference frame (blank room), children showed a slightly attenuated preference for environment-based interpretation, but nonetheless seemed to more easily learn the environment-based meanings when given disambiguating feedback.

We consider several possibilities of why geocentric FoRs might be privileged or readily invoked in word-learning situations. A first possibility is that children show a geocentric preference because they take geocentric relations to be more stable. In a communicative setting, assuming a geocentric FoR eliminates the problem of deciding whose perspective – the speaker's or the listener's – takes precedence. Although children did not show evidence of responding differently when the conflict between their perspective and the experimenter's was removed, children's bias toward environment-based interpretations may arise as a more general heuristic to minimize ambiguity. A related possibility is that when referencing and locating something in space, it is preferable to choose a FoR using entities anchored to earth rather than entities that move, in order to maximize the stability of the representation of the location (Gentner, 2007; Haun et al., 2006). Hence, when forced to choose, children may weigh geocentric relations more heavily than object-centric relations.

Our experiments, however, already suggest that children do not always privilege geocentric FoRs over object-centric or egocentric FoRs: the vulnerability of egocentric object-based reference frames is specific to left-right, not front-back, axes. When novel words were introduced in neutral instructions along children's sagittal axis (Experiment 4), fewer children favored geocentric meanings. When the novel words were introduced on a doll's (non-egocentric) body using body-centric language (Experiment 7), children favored front-back meanings over geocentric ones. Finally, when input conditions were equated for front-back and left-right, the advantage for front-back was apparent: in both the egocentric (i.e., child's own body; Experiment 3 vs. Experiment 1) and non-egocentric (i.e., the doll; Experiment 8) cases, the front-back concepts were much more readily considered by children as possible word meanings.

It is conceivable that children's interpretation of novel words as meaning "front" and "back" might have been related to the fact that 4-year-old children already know the words "front" and "back". However, it is well documented that children have both egocentric and non-egocentric front-back concepts early in development (Johnston, 1988; Johnston & Slobin, 1979; Kuczajac & Maratsos, 1975; Levine & Carey, 1982). Even before acquiring the words "front" and "back," 2-year-old English-learning children correctly oriented people, animals, and objects so that they faced forward in a parade or so that their fronts faced each other in a tea party scenario (Levine & Carey, 1982). Thus, contrary to the conclusions of Haun et al. (2006), children do not struggle with egocentric or object-based reference frames *per se*; the difficulties are specific to left and right.

A possibility, then, is that the advantage for geocentric FoRs may be specific to situations where geocentric relations are pitted against left-right relations. Psychologists have long noted that we have particularly poor perceptual memory for left-right orientation of visual information. Many studies on perspective-taking, for example, indicate that even when children show facility with some aspects of this problem, especially when it is simplified to reduce task demands, even older children fail when the foils include left-right reversals (Huttenlocher & Presson, 1979; Newcombe & Huttenlocher, 1992; Presson, 1980). Some have suggested that a failure to encode left-right is linked to our bilateral symmetry or aspects of brain wiring (e.g., Corballis & Beale, 1976; Dehaene, 2009), and a pervasive orientation-independence in the visual system (Dehaene et al., 2010). Therefore, given difficulties in reasoning about left-right, children find it difficult to learn "left" and "right" language. A challenge to the idea that left-right concepts are undeveloped, however, is that children do show sensitivity to left-right relations in many tasks, such as spatial reorientation (e.g., Lee & Spelke, 2010).

We consider another alternative to explain the specific difficulty children have with left-right relations. The left-right axis is a secondary axis whose differentiation is dependent on the primary front-back axis. Figuring out the meaning of the two symmetrical sides, "left" or "right", therefore, requires noticing how these words are linked to the front-back axis, an axis that was not mentioned at all in the discourse. This added level of relational complexity might make it harder for a child (listener) to correctly identify the intended meaning of the experimenter (speaker). Indeed, the same reason may

explain why in geocentric languages, where the environment is rarely symmetrical, there are often no distinct labels for the two sides of the secondary axes (e.g., Tselal Mayan has “uphill” and “downhill,” but lacks distinct terms for the two sides of the crosshill axis).

How then do children figure out left-right meanings? Our data indicate that left-right meanings, especially egocentric left-right meanings, are within grasp for young children (Exps. 3, 6, and 7). Although less prominent than front-back or geocentric relations, the left-right relation can be drawn out through emphasis on the learner’s own body by capitalizing on the proprioceptive or kinesthetic differences felt from moving the left and the right sides of the body (e.g., raise your ZIV arm, Experiment 3). This finding aligns with clinicians’ success in using associated motor memory that differentiates two sides to train children on left-right discrimination (Greenspan, 1975; Jeffrey, 1958).

Children’s left-right learning can also be supported by explicit input emphasizing the body as the source of the words’ meanings (“Your body has two sides: a ZIV side and a KERN side”). When explicitly told that their body had two sides, children interpreted and learned the novel words as meaning their own left or right sides (Experiment 6 and 7). Furthermore, they extended these newly learned egocentric body terms in new contexts, not only to pick out objects to their immediate sides, but also to pick out figure objects in relation to another ground object besides themselves. Thus, 4- and 5-year-old children are capable of understanding both intrinsic and relative frames of reference when using their own left and right sides as the coordinate axis.

The current data suggest that children are more equipped to break into a system of relative spatial language than others have implied (Haun et al., 2006; Levinson, 2003). While children do have difficulty learning the full-blown left-right system used in relative languages, they are readily able to learn egocentric object-centered meanings like “to the right of me” and “to the right of the cup” so long as they do not have to engage other perspectives or use mental rotation. Thus, there is more to the picture than overcoming an evolved bias that favors geocentric concepts (Gentner, 2007; Haun et al., 2006).

The acquisition of left and right draws interest because some studies have indicated a causal effect of learning such language on spatial cognition and behavior (Haun et al., 2006; Pyers et al., 2010; Shusterman & Spelke, 2005). Under natural conditions, children typically learn egocentric left-right around 5–7 years of age; this correlates with their flexible use of landmarks in spatial reorientation (Hermer-Vazquez, Moffet, & Munkholm, 2001). Subsequent studies have indicated that slightly younger children who are taught egocentric left-right language correspondingly succeed on this task (Shusterman & Spelke, 2005), while adults whose atypical language input kept them from acquiring stable left-right language also exhibit difficulties in such a landmark-based reorientation task (Pyers et al., 2010). In all of these studies, it is the acquisition of egocentric left-right language that appears to be important for the development of at least some kinds of spatial behavior (see also Haun et al., 2006). However, there are multiple senses associated with the notion of ‘acquired left and right’ – egocentric with the body as the ground object, egocentric with another object as the ground, or non-egocentric. An important question for future research is to examine which one of these senses of left-right drives the causal effect observed in the previous studies. Given the variety of senses in which one can be said to have ‘acquired’ left and right – egocentric with the body as the ground object, egocentric with another object as the ground, or non-egocentric – an important question is which sense of left-right is important for these effects. Some possibilities include language acquisition serving to concretize representations by making them more enduring and explicit, or by providing labels to be recruited as mnemonic aid (Landau et al., 2010). Moreover, although language acquisition can strengthen left-right reasoning (Pyers et al., 2010; Shusterman & Spelke, 2005), it is worth pointing out that children and adults who have not acquired left-right language can often nonetheless solve spatial tasks requiring egocentric (viewpoint-dependent) left-right relations at above chance levels (Abarbanell et al., 2011; Li et al., 2011; Nardini, Thomas, Knowland, Braddick, & Atkinson, 2009). The current data also make plain that, under the right input conditions, children can rapidly acquire and extend many varieties of egocentric left-right. Five-year-old (and perhaps younger) children seem to be conceptually prepared to think about egocentric left-right, including its extension beyond the grounding object and translation to new grounds, though they tend not do so spontaneously and they benefit from some guidance to focus on these spatial relationships.

While children could learn egocentric left-right, they struggle mightily with non-egocentric left-right. The 4- and 5-year-old children in our study did not entertain or learn left-right meanings when the novel words were introduced on a doll's left and right sides using body-centric language ("The doll has a ZIV side and a KERN side."). Their failure to entertain such meanings contrasted with their easy learning of front-back meanings (Experiment 8A), and persisted despite clear disambiguating feedback as to which sides were "ZIV" and "KERN" when the doll turned in front of them (Experiment 8B). In this manipulation, the children never heard contradicting or confusing input – that is, the novel words always applied exclusively to the doll's left or right – and yet they could not figure out the meanings. Therefore, the difficulty in acquiring left-right terms cannot be fully explained by the fact that the input children hear will sometimes be contradicting or confusing. Nor can this difficulty be explained by adults' tendency to tailor their speech to the perspective of the child: the children in Experiment 8B were systematically exposed to non-egocentric uses of left and right, but were unable to benefit from this structured input.

Figuring out the meaning of "left" and "right" on the basis of one's own body ought to be easier than the meaning of "left" and "right" of another person. Children have no proprioceptive sense of another person's left and right. There are no visually salient cues that distinguish the left and right sides of another person or other symmetrical entity. Consequently, children must rely on mental rotation to align their own left and right with the other entity's, or otherwise construct a truly object-centered spatial schema of that object, in order to determine which is "left" and which is "right."

Given the complexity of the spatial relation that children must track, it is perhaps not surprising that children never consider the non-egocentric left-right meanings in our tasks. We asked whether the challenge was in mapping this concept to a word, or in representing the spatial relation itself. Children failed to retrieve the hidden coin from the doll's left and right pockets after rotation (Experiment 8C), suggesting that 4- and 5-year-old children appear to be truly unready to think about non-egocentric left and right language (see also [Lasky et al., 1980](#)).

Our finding that egocentric left-right is privileged over non-egocentric left-right matches the developmental progression reported by [Rigal \(1994\)](#) in English- and French-speaking children from New Zealand and France. Both groups of children progressed similarly in their comprehension of "left" and "right" expressions. Rigal generalized that between 5 and 7 years of age, children first figure out how the words map onto their bodies (e.g., "left eye"), and they correctly learn to identify the left and right sides of people facing the same directions as themselves (e.g., "left of the boy"). Between 8 and 11 years of age, according to Piaget and other researchers, children learn to identify the left and right sides of people facing them, and work out how to talk about entities to the left and right sides of these people. This acquisition of non-egocentric left-right is likely to correspond with other conceptual and linguistic developments. We hypothesize that during this last period, children also work out the conventions of their language, such as whether the axis is rotated or not for non-fronted ground objects. We also predict that improvement in children's ability to solve conceptual tasks requiring non-egocentric left-right, such as mental rotation, will be related to the acquisition of language for non-egocentric left and right. A piece of evidence in line with this hypothesis comes from ASL signers: for many sign languages, including American Sign Language (ASL), constructions are typically signed from the perspective of the signer and not the addressee ([Emmorey, Klima, & Hickok, 1998](#)). Children learning ASL, who are exposed primarily to non-egocentric left-right as input, acquire left and right language much later than English-speaking children ([Martin & Sera, 2006](#)). However, adult ASL signers exhibit enhanced mental rotation relative to non-signers ([Emmorey et al., 1998](#)). It is unknown whether it is the extensive practice processing non-egocentric left-right relations in language comprehension, or the experience engaging other spatial computations, that underlies this enhancement in ASL signers. More study is needed to specifically test the connection between non-egocentric left-right language and mental rotation.

Our data, like previous studies, leave unanswered the question of how children eventually come to learn non-egocentric uses of left-right. [Martin and Sera \(2006\)](#) suggest that improvements in one's ability to reason about the perspective of another person and to perform mental rotation are necessary for mastering full use of left-right use. These abilities may undergo substantial development in childhood. For example, mental rotation speed and accuracy continue to improve into the teenage years (e.g., [Hale, 1990](#); [Kail, Pellegrino, & Carter, 1980](#); [Willis & Schaie, 1988](#)). Such improvements in mental

rotation abilities may allow children to grasp how language is used to describe the left-right sides of other people or objects.

It is equally possible that language learning can lead children to analyze, via analogy, relations that they would not otherwise compute (see [Gentner, 2003](#), for a proposal). Perhaps, having first figured out how “left” and “right” apply to their own body, children begin considering the notion that other people have “left” and “right” sides as well. Consequently, they learn to encode such spatial relations that they normally would not consider. If so, we might expect that adult speakers of languages lacking left-right frames of reference would not necessarily notice and make use of left-right relations of other objects in solving spatial tasks, like the nonlinguistic task of Experiment 8B. There is some evidence this is the case; in a similar set-up to Experiment 8C, [Abarbanell and Li \(2009\)](#) showed that not all adult speakers of Tselal, a language that lacks left-right spatial language, made use of a toy animal’s left-right to correctly retrieve a hidden coin.

Where do all these studies leave us? Recall that our inquiry began with the question of what cognitive capacities children bring to learning the spatial words. To start, we focused on children’s acquisition of two contrasting types of reference systems – an environment-based (“geocentric”) coordinate system and a body-based (“egocentric”) coordinate system. Our findings generally support [Haun et al.’s \(2006\)](#) hypothesis that geocentric representations of space are readily available, and provide the first direct evidence that children’s language acquisition draws upon these precursors. However, contrary to Haun and colleagues, our findings do not support their claim of a corresponding difficulty in acquiring egocentric terms. The story turns out to be more nuanced: children can represent egocentric left-right, egocentric front-back, and non-egocentric front-back relations quite easily. Not only could children in our studies extend the novel words for “left” and “right” beyond their body to talk about objects to their own sides (intrinsic FoR), they could translate the coordinates to other origins (relative FoR). Only non-egocentric left-right meanings proved nearly impossible for 4- and 5-year-olds to learn, even when they were provided with unambiguous input regarding the meanings. These findings provide a picture of how cognitive precursors support the acquisition of various spatial frames of reference in the worlds’ languages.

Finally, if language is the product of successful communication between speakers and listeners, our language acquisition results make predictions about the kinds of languages that appear in the world as well. For example, with respect to object-centered frames of reference, our findings predict that the use of the front and back axis for talking about space will be much more prevalent than the use of left and right across the world’s languages. That is, one might find that some languages lack the projection of left and right body terms to talk about space, but that most languages include terms for projecting the front and back of the body (see [Levinson, 2003](#); [Svorou, 1994](#) for similar suggestions). More fine-grained analyses of the world’s languages will determine whether this prediction bears out. In closing, we present these studies as a starting point for connecting language learning with linguistic diversity: by examining how children acquire spatial words, we can begin to uncover the intricate relationship between linguistic conventions, language acquisition, and cognitive development.

Acknowledgments

Special thanks Susan Carey, Elizabeth Spelke, Jesse Snedeker, Alex McNaughton, Linda Abarbanell, and Pierina Cheung for invaluable discussions; Alex McNaughton, Amanda Price, Leah Bogsted, and Linda Abarbanell for assistance with collecting the data; Amy Meadows for assistance with piloting an earlier version of these experiments; Madeleine Barclay and Pierina Cheung for assistance with manuscript preparation; parents and children for their participation, and the staff of the Discovery Center at the Museum of Science, Boston for supporting our research. Funding sources were DRL Graduate Fellowship to A. Shusterman, NIH-NRSA 1F32HD043532 to P. Li, NIH HD23103 to E. Spelke, NSF REC-0196471 to S. Carey, and DRL-0633955 to E. Spelke and S. Carey.

Appendix A. Word introduction script

Child facing east; 7 probe questions and 2 object-switch questions

Children heard either Basic Neutral Instruction (Exps. 1–5) or Body-centric Instruction (Experiment 6), and then were tested on the probe and object switch questions.

Basic Neutral Instruction (Exps. 1–5):

This way is ZIV. This wall is the ZIV wall. It is on the ZIV side of the room.

Can you tell me which side of the room that wall is on? (*Probe Question 1*)

Remember? This wall is to the ZIV of you. Everything that way is ZIV of you.

Can you point to the ZIV? (*Probe Question 2*)

This way is KERN. This wall is the KERN wall. It is on the KERN side of the room.

Can you tell me which side of the room that wall is on? (*Question 3*)

Remember? This wall is to the KERN of you. Everything that way is KERN of you.

Can you point to the KERN? (*Probe Question 4*)

Can you point to the ZIV? (*Probe Question 5*)

Body-centric Instruction (Experiment 6):

Your body has two sides – a ZIV side and a KERN side. This is your ZIV side and this is your KERN side.

This whole side of your body is your ZIV side. So this is your ZIV arm, because it is on the ZIV side of your body. Look at this hand. This is your ZIV hand because it is on the ZIV side of your body. I'm going to put this bracelet on your ZIV hand, so your ZIV hand has a bracelet.

Which hand did I put the bracelet on—the ZIV hand or the KERN hand? (*Probe Question 1*)

Can you wave your ZIV arm? (*Probe Question 2*)

This whole side of your body is your KERN side (*gesture*). So this is your KERN arm, because it is on the KERN side of your body. Look at this hand. This is your KERN hand, because it is on the KERN side of your body. I do not have a bracelet for your KERN hand, so your KERN hand does **not** have a bracelet.

Which hand does **not** have a bracelet—the ZIV hand or the KERN hand? (*Probe Question 3*)

Can you wave your KERN arm? (*Probe Question 4*)

Can you wave your ZIV arm? (*Probe Question 5*)

Probe and Object-Switch for Children in Basic Neutral and Body-centric (Experiment 1–2, 4–6):

This toy is to the ZIV of you.

This toy is to the KERN of you.

Can you show me the toy on the ZIV side? (*Probe Question 6*)

Can you show me the toy on the KERN side? (*Probe Question 7*)

Can you show me the toy on the KERN side? (*Object switch Question 1*)

Can you show me the toy on the ZIV side? (*Object switch Question 2*)

Probe and Object Switch for Children in Body-Focused Condition (Experiment 3):

This arm is on the ZIV side of you. It is your ZIV arm.

This arm is on the KERN side of you. It is your ZIV KERN arm.

Can you raise your ZIV arm? (*Probe Question 6*)

Can you raise your KERN arm? (*Probe Question 7*)

Can you shake your KERN leg? (*Object switch Question 1*)

Can you shake your ZIV leg? (*Object switch Question 2*)

Appendix B. Script for Experiment 7

Introduction (*child facing east*):

Your body has two sides – a ZIV side and a KERN side. This is your ZIV side and this is your KERN side.

This whole side of your body is your ZIV side. So this is your ZIV arm, because it is on the ZIV side of your body. Look at this hand. This is your ZIV hand because it is on the ZIV side of your body. I'm going to put this bracelet on your ZIV hand, so your ZIV hand has a bracelet.

Which hand did I put the bracelet on—the ZIV hand or the KERN hand? (Question 1)

Turn in a circle while you wave your ZIV arm. (Question 2)

This whole side of your body is your KERN side (*gesture*). So this is your KERN arm, because it is on the KERN side of your body. Look at this hand. This is your KERN hand, because it is on the KERN side of your body. I do not have a bracelet for your KERN hand, so your KERN hand does **not** have a bracelet.

Which hand does **not** have a bracelet—the ZIV hand or the KERN hand? (Question 3)

Turn in a circle while you wave your KERN arm. (Question 4)

Let's see you raise your KERN leg. (Body switch Question 1)

Let's see you pull your ZIV ear. (Body switch Question 2)

Let's see you pull your KERN ear. (Body switch Question 3)

Let's see you raise your ZIV leg. (Body switch Question 4)

Appendix C. Script for Experiment 8

Left-Right Introduction (*child facing east*):

Uniqua has two sides – a ZIV side and a KERN side. This is Uniqua's ZIV side, so this is her ZIV arm. Can you tell me which arm this is? (Question 1)

This toy is on the ZIV side of Uniqua, and that wall is to the ZIV of Uniqua too. Everything on this side is to the ZIV of her.

Can you point to Uniqua's ZIV arm? (Question 2)

This is Uniqua's KERN side, so this is her KERN arm.

Can you tell me which arm this is? (Question 3)

This toy is on the KERN side of Uniqua, and that wall is to the KERN of Uniqua too. Everything on this side is to the KERN of her.

Can you point to Uniqua's KERN arm? (Question 4)

Can you point to Uniqua's ZIV arm? (Question 5)

Can you show me the toy on Uniqua's KERN side? (Question 6)

Can you show me the toy on Uniqua's ZIV side? (Question 7)

Can you point to the toy on Uniqua's ZIV side? (Object switch Question 1)

Can you point to the toy on Uniqua's KERN side? (Object switch Question 2)

Front-Back Introduction: (*child facing east*)

Uniqua has two sides – a ZIV side and a KERN side. This is Uniqua's ZIV side, so this is the ZIV side of her head. Can you tell me which side of Uniqua's head this is? (Question 1)

This toy is on the ZIV side of Uniqua, and that wall is to the ZIV of Uniqua too. Everything on this side is to the ZIV of her.

Can you point to the ZIV side of Uniqua's head? (Question 2)

This is Uniqua's KERN side, so this is the KERN side of his head.

Can you tell me which side of Uniqua's head this is? (Question 3)

This toy is on the KERN side of Uniqua, and that wall is to the KERN of Uniqua too. Everything on this side is to the KERN of her.

Can you point to the KERN side of Uniqua's head? (Question 4)

Can you point to the ZIV side of Uniqua's head? (Question 5)

Can you show me the toy on Uniqua's KERN side? (Question 6)

Can you show me the toy on Uniqua's ZIV side? (Question 7)

Can you point to the toy on Uniqua's ZIV side? (Object switch Question 1)

Can you point to the toy on Uniqua's KERN side? (Object switch Question 2)

References

- Abarbanell, L., & Li, P. (2009). Spatial frames of reference and perspective taking in Tzeltal Maya. In J. Chandler, M. Franchini, S. Lord, & G.-M. Rheiner (Eds.), *Proceedings of the 33rd annual Boston University conference on language development* (Vol. 1, pp. 49–60). Somerville, MA: Cascadia Press.
- Abarbanell, L., Montana, R., & Li, P. (2011). Revisiting plasticity in human spatial cognition: Cross-linguistic comparisons. *Spatial Information Theory, Lecture Notes in Computer Science Series*, 6899, 245–263.
- Acredolo, L. P. (1977). Developmental changes in the ability to coordinate perspectives of a large-scale space. *Developmental Psychology*, 13(1), 1–8.
- Acredolo, L. P. (1978). Development of spatial orientation in infancy. *Developmental Psychology*, 14(3), 224–234.
- Acredolo, L. P. (1979). Laboratory versus home: The effect of environment on the 9-month-old infant's choice of spatial reference system. *Developmental Psychology*, 15(6), 666–667.
- Benton, A. (1959). *Right-left discrimination and finger localization*. New York, NY: Hoeber-Harper.
- Bloom, P., & Keil, F. (2001). Thinking through language. *Mind and Language*, 16(4), 351–367.
- Bloom, P., Peterson, M. A., Nadel, L., & Garrett, M. F. (Eds.). (1996). *Language and space*. Cambridge, MA: MIT Press.
- Boroditsky, L. (2003). Linguistic relativity. In L. Nadel (Ed.), *Encyclopedia of cognitive science* (pp. 917–922). London, UK: Macmillan.
- Bowerman, M., & Choi, S. (2003). Space under construction: Language-specific spatial categorization in first language acquisition. In D. Gentner & S. Goldin-Meadow (Eds.), *Language in mind: Advances in the study of language and cognition* (pp. 387–428). Cambridge, MA: MIT Press.
- Brockmole, J. R., & Wang, R. F. (2005). Spatial processing of environmental representations. In L. Itti, G. Rees, & J. Tsotsos (Eds.), *Neurobiology of attention* (pp. 146–152). San Diego, CA: Elsevier.
- Brown, P., & Levinson, S. C. (1993). *Linguistic and nonlinguistic coding of spatial arrays: Explorations in Mayan cognition* (No. 24). Cognitive Anthropology Research Group, Max Planck Institute for Psycholinguistics working paper.
- Brown, P., & Levinson, S. C. (2000). Frames of spatial reference and their acquisition in Tenejapan Tzeltal. In L. P. Nucci, G. B. Saxe, & E. Turiel (Eds.), *Culture, thought, and development* (pp. 167–197). Mahwah, New Jersey: Lawrence Erlbaum Associates.
- Burgess, N. (2006). Spatial memory: How egocentric and allocentric combine. *Trends in Cognitive Sciences*, 10(12), 551–557.
- Burgess, N., & O'Keefe, J. (2003). Neural representations in human spatial memory. *Trends in Cognitive Science*, 7(12), 517–519.
- Carey, S., & Bartlett, E. (1978). Acquiring a single new word. *Papers and Reports on Child Language Development*, 15, 17–29.
- Christie, S., & Gentner, D. (2012). Language and cognition in development. In M. M. Spivey, K. McRae, & M. Joannisse (Eds.), *The Cambridge handbook of psycholinguistics* (pp. 653–673). Cambridge, UK: Cambridge University Press.
- Colby, C. L. (1998). Action-oriented spatial reference frames in cortex. *Neuron*, 20(1), 15–24.
- Corballis, M. C., & Beale, I. L. (1976). *The psychology of left and right*. Hillsdale, NJ: Erlbaum.
- Dasen, P. R., & Mishra, R. C. (2010). *Development of geocentric spatial language and cognition*. Cambridge: Cambridge University Press.
- de León, L. (1994). Exploration in the acquisition of geocentric location by Tzotzil children. *Linguistics*, 32(4–5), 857–884.
- de León, L. (1995). *The development of geocentric location in young speakers of Guugu Yimithirr* (No. 33). Cognitive Anthropology Research Group at the Max Plank Institute for Psycholinguistics working paper, Nijmegen, The Netherlands.
- de León, L. (2001). Finding the richest path: Language and cognition in the acquisition of verticality in Tzotzil (Mayan). In M. Bowerman & S. C. Levinson (Eds.), *Language acquisition and conceptual development* (pp. 544–565). Cambridge, UK: Cambridge University Press.
- Dehaene, S. (2009). *Reading in the brain: The science and evolution of a human invention*. New York, NY: Penguin Viking.
- Dehaene, S., Izard, V., Pica, P., & Spelke, E. S. (2006). Core knowledge of geometry in an Amazonian indigene group. *Science*, 311(5759), 381–384.
- Dehaene, S., Nakamura, K., Jobert, A., Kuroki, C., Ogawa, S., & Cohen, L. (2010). Why do children make mirror errors in reading? Neural correlates of mirror invariance in the visual word form area. *Neuroimage*, 49(2), 1837–1848.
- Dessalegn, B., & Landau, B. (2008). More than meets the eye: The role of language in binding visual properties. *Psychological Science*, 19(2), 189–195.
- Elkind, D. (1961). Children's conception of right and left: Piaget replication study IV. *Journal of Genetic Psychology*, 99(2), 269–276.
- Emmorey, K., Klima, E., & Hickok, G. (1998). Mental rotation within linguistic and non-linguistic domains in users of American Sign Language. *Cognition*, 68(3), 221–246.
- Gentner, D. (2007). Spatial cognition in apes and humans. *Trends in Cognitive Science*, 11(5), 192–194.
- Gentner, D. (2003). Why we're so smart. In D. Gentner & S. Goldin-Meadow (Eds.), *Language in mind* (pp. 195–235). NY: Springer.
- Gleitman, L. R., & Papafragou, A. (2013). Relations between language and thought. In D. Reisberg (Ed.), *Handbook of cognitive psychology*. New York, NY: Oxford University Press.
- Greenspan, S. B. (1975). Effectiveness of therapy for children's reversal confusions. *Intervention in School and Clinic*, 11(2), 169–178.
- Gregory, E., Landau, B., & McCloskey, M. (2011). Representation of object orientation in children: Evidence from mirror-image confusions. *Visual Cognition*, 19(8), 1035–1062.
- Hafting, T., Fyhn, M., Molden, S., Moser, M. B., & Moser, E. I. (2005). Microstructure of a spatial map in the entorhinal cortex. *Nature*, 436(7052), 801–806.
- Hale, S. (1990). A global developmental trend in cognitive processing speed. *Child Development*, 61(3), 653–663.
- Harris, L. J. (1972). Discrimination of left and right, and development of the logic of relations. *Merrill-Palmer Quarterly of Behavior and Development*, 18(4), 307–320.
- Haun, D. B. M., & Rapold, C. J. (2009). Variation in memory for body movements across cultures. *Current Biology*, 19(23), R1068–R1069.
- Haun, D. B. M., Rapold, C. J., Call, J., Janzen, G., & Levinson, S. C. (2006). Cognitive cladistics and cultural override in Hominid spatial cognition. *Proceedings of the National Academy of Sciences of the United States of America*, 103(46), 17568–17573.

- Haun, D. B. M., Rapold, C. J., Janzen, G., & Levinson, S. C. (2011). Plasticity of human spatial memory: Spatial language and cognition covary across cultures. *Cognition*, *119*(1), 70–80.
- Hermer, L., & Spelke, E. (1996). Modularity and development: The case of spatial reorientation. *Cognition*, *61*(3), 195–232.
- Hermer-Vazquez, L., Moffet, A., & Munkholm, P. (2001). Language, space, and the development of cognitive flexibility in humans: The case of two spatial memory tasks. *Cognition*, *79*(3), 263–299.
- Hespos, S. J., & Spelke, E. S. (2004). Conceptual precursors to language. *Nature*, *430*(6998), 453–456.
- Hickmann, M., & Robert, S. (Eds.). (2006). *Space in languages: Linguistic systems and cognitive categories*. Amsterdam, The Netherlands: John Benjamin Publishing.
- Huttenlocher, J., & Presson, C. C. (1973). Mental rotation and the perspective problem. *Cognitive Psychology*, *4*(2), 277–299.
- Huttenlocher, J., & Presson, C. C. (1979). The coding and transformation of spatial information. *Cognitive Psychology*, *11*(3), 375–394.
- Huttenlocher, J., & Vasilyeva, M. (2003). How toddlers represent enclosed spaces. *Cognitive Science*, *27*(5), 749–766.
- Irwin, R. J., & Newland, J. K. (1977). Children's knowledge of left and right: Research note. *Journal of Child Psychology and Psychiatry*, *18*(3), 271–277.
- Janzen, G., Haun, D. B. M., & Levinson, S. C. (2012). Tracking down abstract linguistic meaning: Neural correlates of spatial frame of reference ambiguities in language. *PLoS One*, *7*(2), e30657.
- Jeffrey, W. E. (1958). Variables in early discrimination learning: I. Motor responses in the training of a left-right discrimination. *Child Development*, *29*(2), 269–275.
- Johnston, J. R., & Slobin, D. I. (1979). The development of locative expressions in English, Italian, Serbo-Croatian, and Turkish. *Journal of Child Language*, *6*(3), 529–545.
- Johnston, J. R. (1988). Children's verbal representation of spatial location. In J. Stiles-Davis, M. Kritchevsky, & U. Bellugi (Eds.), *Spatial cognition: Brain bases and development* (pp. 195–205). Hillsdale, NJ: Lawrence Erlbaum Associates.
- Kail, R., Pellegrino, J., & Carter, P. (1980). Developmental changes in mental rotation. *Journal of Experimental Child Psychology*, *29*(1), 102–116.
- Kant, I. (1768). on dem ersten Grunde des Unterschieds der Gegenden im Raume [On the first ground of the distinction of regions in space (1991)]. In J. van Cleve & R. E. Frederick (Eds.), *The philosophy of right and left: Incongruent counterparts and the nature of space* (pp. 27–33). Dordrecht: Kluwer.
- Knierim, J. J., Kudrimoti, H. S., & McNaughton, B. L. (1995). Place cells, head direction cells, and the learning of landmark stability. *Journal of Neuroscience*, *15*(3), 1648–1659.
- Kuczaj, S. A., & Maratsos, M. P. (1975). The acquisition of front, back and side. *Child Development*, *46*(1), 202–210.
- Landau, B., Dessalegn, B., & Goldberg, A. M. (2010). Language and space: Momentary interactions. In P. Chilton & V. Evans (Eds.), *Language, cognition and space: The state of the art and new directions* (pp. 51–78). London, UK: Equinox Publishing.
- Landau, B., & Stecker, D. (1990). Objects and places: Geometric and syntactic representations in early lexical learning. *Cognitive Development*, *5*(3), 287–312.
- Lasky, R. E., Romano, N., & Wenters, J. (1980). Spatial localization in children after changes in position. *Journal of Experimental Child Psychology*, *29*(2), 225–248.
- Lee, S. A., & Spelke, E. S. (2010). A modular geometric mechanism for reorientation in children. *Cognitive Psychology*, *61*(2), 152–176.
- Levine, S. C., & Carey, S. (1982). Up front: The acquisition of a concept and a word. *Journal of Child Language*, *9*(3), 645–657.
- Levinson, S. C. (2003). *Space in language and cognition: Explorations in cognitive diversity*. Cambridge, UK: Cambridge University Press.
- Levinson, S. C. (1996). Frames of reference and Molyneux's question: Cross-linguistic evidence. In P. Bloom, M. A. Peterson, L. Nadel, & M. F. Garrett (Eds.), *Language and space* (pp. 109–169). Cambridge, MA: MIT Press.
- Levinson, S. C. (2001). Covariation between spatial language and cognition. In M. Bowerman & S. C. Levinson (Eds.), *Language acquisition and conceptual development* (pp. 566–588). Cambridge University Press.
- Levinson, S. C., Kita, S., Haun, D., & Rasch, B. (2002). Returning the tables: Language affects spatial reasoning. *Cognition*, *84*(2), 155–188.
- Li, P., Abarbanell, L., Gleitman, L. R., & Papafragou, A. (2011). Spatial reasoning in Tzeltal Mayan. *Cognition*, *120*(1), 33–53.
- Li, P., & Gleitman, L. R. (2002). Turning the tables: Language and spatial reasoning. *Cognition*, *83*(3), 265–294.
- Majid, A., Bowerman, M., Kita, S., Haun, D., & Levinson, S. (2004). Can language restructure cognition? The case for space. *Trends in Cognitive Science*, *8*(3), 108–114.
- Martin, A. J., & Sera, M. D. (2006). The acquisition of spatial constructions in ASL and English. *Journal of Deaf Studies and Deaf Education*, *11*(4), 391–402.
- Nardini, M., Atkinson, J., & Burgess, N. (2008). Children reorient using the left/right sense of coloured landmarks at 18–24 months. *Cognition*, *106*(1), 519–527.
- Nardini, M., Burgess, N., Breckenridge, N., & Atkinson, J. (2006). Differential developmental trajectories for egocentric, environmental and intrinsic frames of reference in spatial memory. *Cognition*, *101*(1), 153–172.
- Nardini, M., Thomas, R. L., Knowland, V. C. P., Braddick, O. J., & Atkinson, J. (2009). A viewpoint-independent process for spatial reorientation. *Cognition*, *112*(2), 241–248.
- Newcombe, N., & Huttenlocher, J. (1992). Children's early ability to solve perspective-taking problems. *Developmental Psychology*, *28*(4), 635–643.
- Newcombe, N., & Huttenlocher, J. (2000). *Making space: The development of spatial representation and reasoning*. Cambridge, MA: MIT Press.
- O'Keefe, J., & Nadel, L. (1978). *The hippocampus as a cognitive map*. Oxford, UK: Clarendon Press.
- Pederson, E., Danziger, E., Wilkins, D., Levinson, S., Kita, S., & Senft, G. (1998). Semantic typology and spatial conceptualization. *Language*, *74*(3), 557–589.
- Piaget, J. (1928). *Judgment and reasoning in the child*. London, UK: Routledge & Kegan Paul.
- Piaget, J., & Inhelder, B. (1948/1967). *The child's conception of space* (F. J. Langdon, & J. L. Lunzer, Trans.). New York, NY: W.W. Norton & Company.
- Piaget, J., & Inhelder, B. (1971). *Mental imagery in the child*. New York, NY: Routledge & Kegan Paul.

- Pinker, S. (2007). Fifty thousand innate concepts and other radical theories of language and thought. In *The stuff of thought: Language as a window into human nature* (pp. 89–152). New York, NY: Viking.
- Presson, C. C. (1980). Spatial egocentrism and the effect of an alternate frame of reference. *Journal of Experimental Child Psychology*, 29(3), 391–402.
- Pyers, J., Shusterman, A., Senghas, A., Spelke, E. A., & Emmorey, K. (2010). Evidence from users of an emerging sign language reveals that language supports spatial cognition. *Proceedings of the National Academy of Sciences*, 107(27), 12116–12120.
- Restle, F. (1957). Discrimination of cues in mazes: A resolution of the “place-vs.-response” question. *Psychological Review*, 64(4), 217–228.
- Rigal, R. (1994). Right-left orientation: Development of correct use of right and left terms. *Perceptual and Motor Skills*, 79(3), 1259–1278.
- Rigal, R. (1996). Right-left orientation, mental rotation, and perspective-taking: When can children imagine what people see from their own viewpoint? *Perceptual and Motor Skills*, 83(3), 831–843.
- Schober, M. F. (2009). Spatial dialogue between partners with mismatched abilities. In K. R. Coventry, T. Tenbrink, & J. A. Bateman (Eds.), *Spatial language and dialogue* (pp. 23–39). Oxford, UK: Oxford University Press.
- Shusterman, A., & Li, P. (2016). A framework for work on frames of reference. In D. Barner, & A. Baron (Eds.), *Core knowledge & conceptual change* (pp. 188–202). Oxford, UK: Oxford University Press.
- Shusterman, A., Lee, S. A., & Spelke, E. S. (2008). Young children’s spontaneous use of geometry in maps. *Developmental Science*, 11(2), F1–F7.
- Shusterman, A., Lee, S. A., & Spelke, E. S. (2011). Cognitive effects of language on human navigation. *Cognition*, 120(2), 186–201.
- Shusterman, A., & Spelke, E. (2005). Language and the development of spatial reasoning. In P. Carruthers, S. Laurence, & S. Stich (Eds.), *The innate mind: Structure and contents* (pp. 89–106). Oxford, UK: Oxford University Press.
- Simons, D. J., & Wang, R. F. (1998). Perceiving real-world viewpoint changes. *Psychological Science*, 9(4), 315–320.
- Svorou, S. (1994). *The grammar of space*. Philadelphia, PA: John Benjamins Publishing Company.
- Twyman, A., Friedman, A., & Spetch, M. L. (2007). Penetrating the geometric module: Catalyzing children’s use of landmarks. *Developmental Psychology*, 43(6), 1523–1530.
- Vosniadou, S., & Brewer, W. F. (1992). Mental models of the earth: A study of conceptual change in childhood. *Cognitive Psychology*, 24(4), 535–585.
- Wang, R. F., & Spelke, E. S. (2002). Human spatial representation: Insights from animals. *Trends in Cognitive Sciences*, 6(9), 376–382.
- Whorf, B. L. (1956). *Language, thought and reality: Selected writings of Benjamin Lee Whorf*. Cambridge, MA: MIT Press.
- Willis, S. L., & Schaie, K. W. (1988). Gender differences in spatial ability in old age: Longitudinal and intervention findings. *Sex Roles*, 18(3), 189–203.
- Wolff, P. M., & Holmes, K. J. (2011). Linguistic relativity. *Wiley Interdisciplinary Reviews: Cognitive Science*, 2(3), 253–265.