

12-2016

# A Bifunctional Nanocomposites Based Electrochemical Biosensor for In-field Detection of Pathogenic Bacteria in Food

Meng Xu

*University of Arkansas, Fayetteville*

Follow this and additional works at: <http://scholarworks.uark.edu/etd>

 Part of the [Biological Engineering Commons](#), [Food Microbiology Commons](#), and the [Nanoscience and Nanotechnology Commons](#)

---

## Recommended Citation

Xu, Meng, "A Bifunctional Nanocomposites Based Electrochemical Biosensor for In-field Detection of Pathogenic Bacteria in Food" (2016). *Theses and Dissertations*. 1777.  
<http://scholarworks.uark.edu/etd/1777>

This Dissertation is brought to you for free and open access by ScholarWorks@UARK. It has been accepted for inclusion in Theses and Dissertations by an authorized administrator of ScholarWorks@UARK. For more information, please contact [scholar@uark.edu](mailto:scholar@uark.edu), [ccmiddle@uark.edu](mailto:ccmiddle@uark.edu).

A Bifunctional Nanocomposites Based Electrochemical Biosensor for In-field Detection of  
Pathogenic Bacteria in Food

A dissertation submitted in partial fulfilment  
of the requirements for the degree of  
Doctor of Philosophy in Biological Engineering

by

Meng Xu  
South China University of Technology  
Bachelor of Engineering in Biological Engineering, 2008  
Illinois Institute of Technology  
Master of Science in Food Safety and Technology, 2013

December, 2016  
University of Arkansas

This dissertation is approved for recommendation to the Graduate Council.

---

Dr. Yanbin Li  
Dissertation Director

---

Dr. Jin-Woo Kim  
Committee Member

---

Dr. David W. Paul  
Committee Member

---

Dr. Young-Min Kwon  
Committee Member

---

Dr. Jun Zhu  
Committee Member

## Abstract

This research focused on the application of electrochemical biosensors for the rapid detection of pathogenic bacteria, *Escherichia coli* O157:H7 and *Salmonella* Typhimurium, in foods. The possible presence of pathogenic bacteria in foods has always been a great threat to the wellbeing of people and the revenue of food companies. Therefore, the demand for rapid and sensitive methods to detect foodborne pathogens is growing. In this research, an impedimetric immunosensor was first developed for the rapid detection of *E. coli* O157:H7 and *S. Typhimurium* in foods. It was based on the techniques of immunomagnetic separation, enzyme labelling, and electrochemical impedance spectroscopy (EIS). This impedimetric immunosensor was capable of specifically detecting *E. coli* O157:H7 and *S. Typhimurium* within the range of  $10^2$  to  $10^6$  colony forming unit (cfu)/ml in the pure culture. The limits of detection (LODs) of *E. coli* O157:H7 in ground beef and *S. Typhimurium* in chicken carcass rinse water were  $2.05 \times 10^3$  cfu/g and  $1.04 \times 10^3$  cfu/ml, respectively. The second electrochemical biosensor was designed for rapid detection of *E. coli* O157:H7. This biosensor integrated magnetic GOx-polydopamine (PDA) based polymeric nanocomposites (PMNCs) which served dual functions as both the carrier and the label, and Prussian blue (PB) modified SP-IDMEs for measurement. The core-shell Abs/GOx<sub>ext</sub>/gold nanoparticles (AuNPs)/magnetic beads (MBs)-GOx@PDA PMNCs acted efficiently to get a high load of enzyme onto the surface of bacterial cells. A filtration step separated the free PMNCs from the bonded ones and reduce the background noise to achieve better sensitivity. The constructed biosensor had been proved to be able to detect *E. coli* O157:H7 with the LOD of 52 cfu/ml in the pure culture. The third electrochemical aptasensor was developed to detect *S. Typhimurium* based on the concept of the bifunctional nanocomposites. The ssDNA aptamers were used as the biorecognition element. The achieved

LOD in the pure culture was 96 cfu/ml. The biosensors developed in this research exhibited good specificity, reproducibility, and easy-to-operate, and are expected to find broad applications in the detection, especially in-field detection, of foodborne pathogens.

**Key words:** Electrochemical biosensors, Multilayer Bifunctional Nanocomposites, Screen-printed Interdigitated Microelectrode, Rapid Detection, Foodborne Pathogens

## **Acknowledgements**

I would like to sincerely thank my advisor, Dr. Yanbin Li, for his encouragement and support during my entire graduate program. The lesson he has taught me throughout my graduate study was great input to improve myself. He pushed me to become a better researcher with his informative and constructive advices. I also want to thank him for he inspired me with his life experience and wisdom. His passion and dedication for research will be a life-long example for me.

I also want to express my gratitude to all my committee members, Dr. Jim-Woo Kim, Dr. Dr. Young-Min Kwon, Dr. David Paul, and Dr. Jun Zhu. I feel honored to have them in my dissertation committee, and deeply appreciate the suggestions and help I have been given from them upon my research.

I thank the great research group I am in for their enormous support: Dr. Ronghui Wang, without her knowledge and advice on all the research issues, I would have a much more difficult time during my research; Lisa Kelso, for her help on the training of microbial tests and taking the SEM pictures as well as for taking care of the basic lab issues; Zach Callaway, for the discussion we have on the research topics, for his help on the revision of manuscripts, and for his wonderful friendship; and Lizhou Xu, who is a visiting scholar from Zhejiang University, China, for his input to my research project. I also want to thank the rest of the members in our group whose friendship will always be with me.

I want to thank the Department of Biological and Agricultural Engineering and Department of Poultry Science for the support they gave me for my graduate study. I would also like to thank the Center of Excellence for Poultry Science and staffs who work there for offering the infrastructure and all the technical support for the proceeding of my graduate study.

Finally and most importantly, I want to thank my parents from the deepest of my heart for all they have done for me. Their love, encouragement, and commitment to me haven't diminished a tiny bit even they are far from my side. I would have never achieved this much without their unending support. I feel so lucky to have such amazing parents and they deserve all the credit beyond any word.

## Table of Contents

<b>Chapter 1 Introduction</b> .....	1
1.1 References.....	4
<b>Chapter 2 Objectives</b> .....	6
<b>Chapter 3 Literature Review</b> .....	8
3.1 Foodborne pathogens and illnesses.....	8
3.1.1 <i>Escherichia coli</i> O157:H7.....	9
3.1.2 <i>Salmonella</i> Typhimurium .....	10
3.2 Conventional Methods for the detection of <i>E. coli</i> O157:H7 and <i>S. Typhimurium</i> .....	11
3.3 Biosensors for the detection of foodborne pathogens.....	14
3.4 Electrochemical biosensors for the detection of <i>E. coli</i> O157:H7 and <i>S. Typhimurium</i> .....	17
3.4.1 Label-dependent electrochemical biosensors .....	27
3.4.2 Commercially available biosensors for the detection of <i>E. coli</i> O157:H7 .....	30
3.5 Recent trends in the development of electrochemical biosensors for <i>E. coli</i> O157:H7 and <i>S.</i> Typhimurium .....	36
3.5.1 Applications of nanotechnology in electrochemical biosensors for improvements in sensing performance .....	37
3.5.2 lab-on-a-chip techniques in the miniaturization of electrochemical biosensors for the detection of <i>E. coli</i> O157:H7 and <i>S. Typhimurium</i> .....	41
3.5.3 Techniques to fabricate low-cost electrochemical biosensors .....	43
3.6 Conclusions.....	44
3.7 References.....	46

<b>Chapter 4 Rapid detection of <i>Escherichia coli</i> O157:H7 and <i>Salmonella</i> Typhimurium in foods using an electrochemical immunosensor based on screen-printed interdigitated microelectrodes and immunomagnetic separation</b>	<b>54</b>
4.1 Abstract	54
4.2 Introduction	55
4.3 Material and methods	58
4.3.1 Biochemical materials	58
4.3.2 Apparatus	59
4.3.3 Culture preparation and media plating methods	60
4.3.4 Food samples preparation and inoculation	61
4.3.5 Preparation of immune-functionalized magnetic beads	62
4.3.6 Preparation of Ab-GOx conjugates	62
4.3.7 Electrochemical impedance analysis for the detection of bacteria	62
4.3.8 Statistical analysis	64
4.4 Results and discussion	64
4.4.1 Equivalent circuit model for the interpretation of the electrochemical measurement of the developed immunosensor	64
4.4.2 Electrochemical analysis for the detection of the pathogenic bacteria	67
4.4.3 The immunosensor developed for the detection of <i>E. coli</i> O157:H7 and <i>S. Typhimurium</i> in the pure culture	69
4.4.4 Specificity of the developed impedimetric immunosensor for the detection of <i>E. coli</i> O157:H7 and <i>S. Typhimurium</i>	73



4.4.5 Detection of <i>E. coli</i> O157:H7 in ground beef and <i>S. Typhimurium</i> in chicken carcass rinse water .....	75
4.5 Conclusions.....	77
4.6 References.....	77
<b>Chapter 5 An Electrochemical Biosensor for Rapid Detection of <i>E. coli</i> O157:H7 with Highly Efficient Bifunctional Glucose Oxidase-polydopamine Nanocomposites and Prussian Blue Modified Screen-printed Interdigitated Electrode.....</b>	<b>81</b>
5.1 Abstract.....	81
5.2 Introduction.....	82
5.3 Experimental.....	85
5.3.1 Material and apparatus.....	85
5.3.2 Methods for culture preparation and media plating enumeration.....	87
5.3.3 Food sample preparation and inoculation.....	88
5.3.4 Preparation of bifunctional PMNCs.....	88
5.3.5 Preparation of Prussian blue modified SP-IDME.....	89
5.3.6 Construction of the electrochemical biosensor for the detection of <i>E. coli</i> O157:H7 .....	91
5.4 Results and discussion .....	92
5.4.1 Characterization of the PB-modified SP-IDME .....	92
5.4.2 Characterization of the synthesized Abs/GO <sub>x</sub> <sub>ext</sub> /AuNPs/MBs-GO <sub>x</sub> @PDA PMNCs .....	96
5.4.3 The constructed electrochemical biosensor for the detection of <i>E. coli</i> O157:H7 in the pure culture and the specificity of the biosensor.....	98

5.4.4 The validation of the constructed biosensor for the detection of <i>E. coli</i> O157:H7 in ground beef using a handheld electrochemical detector .....	101
5.5 Conclusions.....	102
5.6 References.....	103
<b>Chapter 6 An electrochemical aptasensor for rapid detection of <i>Salmonella</i> Typhimurium based on the bifunctional magnetic nanocomposites .....</b>	<b>107</b>
6.1 Abstract.....	107
6.2 Introduction.....	107
6.3 Experimental.....	112
6.3.1 Materials and apparatus .....	112
6.3.2 Methods for culture preparation and media plating enumeration .....	113
6.3.3 Preparation of bifunctional PMNCs.....	113
6.3.4 Construction of the electrochemical biosensor for the detection of <i>S. Typhimurium</i> .....	116
6.4 Results and discussion .....	117
6.4.1 Characteristics of the developed electrochemical aptasensor for the detection of <i>S. Typhimurium</i> .....	117
6.4.2 Amperometric aptasensor for the detection of <i>S. Typhimurium</i> by the handheld electrochemical aptasensor .....	118
6.4.3 The specificity of the developed electrochemical aptasensor for the detection of <i>S. Typhimurium</i> .....	121
6.5 Conclusions.....	121
6.6 References.....	122

<b>Chapter 7 Conclusions.....</b>	<b>125</b>
<b>Chapter 8 Recommendations for Future Research.....</b>	<b>130</b>

## List of Tables

<b>Table 3.1.</b> Characteristics of common conventional and some alternative methods .....	14
<b>Table 3.2.</b> Electrochemical biosensors for the detection of <i>E. coli</i> O157:H7 and <i>S. Typhimurium</i> .....	24
<b>Table 3.3.</b> The desired properties of an ideal biosensor for foodborne pathogens detection.....	37
<b>Table 4.1.</b> One example of the fitted values of components in the equivalent circuit simulated for the developed immunosensor in the detection of <i>E. coli</i> O157:H7 and <i>S. Typhimurium</i> .....	66
<b>Table 4.2.</b> Magnitude changes of impedance when different volumes of Ab-GOx conjugates were used to label $10^4$ cfu/ml of both bacteria.....	70
<b>Table 5.1.</b> Capture efficiency of the synthesized Abs/GO <sub>x</sub> <sub>ext</sub> /MBs-GOx@PDA PMNCs for <i>E.</i> <i>coli</i> O157:H7.....	96
<b>Table 6.1.</b> The current response at $E_{peak}$ for different analytes .....	118

## List of Figures

**Figure 3.1.** The schematic frame of a typical biosensor .....14

**Figure 3.2.** (a) Approximate number of publications using biosensor methods for the detection of *E. coli* O157:H7. (b) Approximate number of publications using electrochemical biosensors for the detection of *E. coli* O157:H7 on yearly order. Source is EBSCOhost research databases .....16

**Figure 3.3.** (a) The schematic mechanism of an amperometric biosensor. The labels (commonly enzymes) facilitate the electron transfer between the electrochemical active pairs in the solution and the electrode. (b) The schematic mechanism of a ISFETs potentiometric biosensor. The labels change the concentration of specific ions ( $H^+$ ,  $K^+$ , etc.). A current flowing through a channel under the gate insulator is regulated by the gate potential. The selected ions accumulate on the gate insulator, causing potential different and changing the current flow in the channel. (c) The schematic mechanism of an impedimetric biosensor. The impedance is increased because the electron transfer was blocked due to the attachment of bacterial cells on the surface of the electrode .....18

**Figure 3.4.** An amperometric biosensor based on screen-printed carbon electrode (SPCE) which was immobilized with ferrocenedicarboxylic acid (FeDC) (mediator) coated gold nanoparticles (AuNPs) and antibodies. After the capture of *E. coli* O157:H7, a horseradish peroxidase (HRP) conjugated second antibody was employed to label the bacterial cells and catalyze hydrogen peroxide. The apparatus setup was shown in the bottom panel. The electrochemical system was built on a disposable testing strip.....27

**Figure 3.5.** (a) A label-free impedimetric biosensor for the detection of *E. coli* O157:H7. The bioreceptors were absorbed to the surface of a SP-IDME by a permanent magnet. Upon the capture of the bacterial cells, the pathway for the electron transfer at the electrode surface was

blocked, and thus the impedance was increased. (b) The equivalent circuit of the developed electrochemical impedance biosensor was shown. It is important for the data analysis in EIS to obtain electrical parameters like charge transfer resistance ( $R_{ct}$ ) .....30

**Figure 4.1.** SEM image (a) of single bacterial cell bound with multiple magnetic beads (*E. coli* O157:H7) and TEM images (b) of only magnetic beads ( $\times 100k$  amplification) .....58

**Figure 4.2.** Configuration of the screen-printed interdigitated microelectrode .....60

**Figure 4.3.** Illustration of the mechanism and construction of the immunosensor .....64

**Figure 4.4.** (a) The Bode plot of the impedance measurement and the fitted curve based on the equivalent circuit. Curves **BLACK** and **BLUE** are the spectra of the impedance magnitude before and after the enzymatic reaction, respectively. Curves **RED** and **GREEN** are the spectra of the phase angle before and after the enzymatic reaction, respectively. The **PURPLE** and **ORANGE** dot curves are fitted curves for curves **BLACK** and **RED** based on the equivalent circuit model. (b) The equivalent circuit that can represent the electrochemical system of the immunosensor .....67

**Figure 4.5.** Capture efficiency of two bacteria using MBs-Abs conjugates .....69

**Figure 4.6.** The calibration curves of the impedance magnitude change versus the concentration of bacteria for the detection of (a) *E. coli* O157:H7 and (b) *S. Typhimurium*. The impedance magnitude change for the negative controls was  $12.07 \pm 2.59$  k $\Omega$ . The limit of detection was determined by the equation based on signal/noise ratio of three, Mean of NCs + 3  $\times$  Standard deviation of NCs, which is 19.84 k $\Omega$ .....71

**Figure 4.7.** The specificity of the immunosensor for the detection of *E. coli* O157:H7 and *S. Typhimurium* when four non-target bacteria were tested at the same concentration of  $10^5$  cfu/ml. The black line represents the LOD of the impedance magnitude change which is 19.84 k $\Omega$ .....74

<b>Figure 4.8.</b> The calibration curves of the impedance magnitude changes versus the concentrations of (a) <i>E. coli</i> O157:H7 in ground beef and (b) <i>S. Typhimurium</i> in whole chicken carcass rinse water. The limit of detection was determined by the equation based on signal/noise ratio of three, Mean of NCs + 3 × Standard deviation of NCs, for both pathogens .....	75
<b>Figure 5.1.</b> (A) Overall structure of the magnetic beads from Ocean NanoTech, and (B) TEM images of the magnetic beads at different sizes .....	86
<b>Figure 5.2.</b> The schematic illustration of the Abs/GO <sub>x<sub>ext</sub></sub> /AuNPs/MBs-GO <sub>x</sub> @PDA PMNCs synthesis .....	88
<b>Figure 5.3.</b> The construction of the electrochemical biosensor for the detection of <i>E. coli</i> O157:H7 .....	90
<b>Figure 5.4.</b> The characteristics of PB-modified SP-IDME by using electrochemical measurement. (a) Cyclic voltammetry of PB modification. (b) CVs of different concentration of H <sub>2</sub> O <sub>2</sub> when measured by PB-modified SP-IDME. (c) and (d) Amperometric measurement ( <i>i-t</i> ) at -0.75 V and the calibration curve when different concentration of H <sub>2</sub> O <sub>2</sub> were tested.....	93 & 94
<b>Figure 5.5.</b> Enzymatic activity of the synthesized PMNCs. (a) Cyclic voltammetry at different time of enzymatic reaction. (b) Redox peaks at different time points of the enzymatic reaction .	97
<b>Figure 5.6.</b> Amperometric detection of <i>E. coli</i> O157:H7 in pure culture samples. The potential applied was -0.4 V .....	99
<b>Figure 5.7.</b> Specificity of the constructed electrochemical biosensor for the detection of <i>E. coli</i> O157:H7 .....	100
<b>Figure 5.8.</b> The detection of <i>E. coli</i> O157:H7 in ground beef using a handheld electrochemical detector.....	101

<b>Figure 6.1.</b> The schematic illustration of the aptamers/ $\text{GO}_{\text{xext}}$ /AuNPs/MBs- $\text{GO}_{\text{x}}$ @PDA PMNCs synthesis .....	114
<b>Figure 6.2.</b> The construction of the electrochemical biosensor for the detection of <i>S. Typhimurium</i> .....	115
<b>Figure 6.3.</b> The characteristics of the developed electrochemical aptasensor under different circumstances .....	117
<b>Figure 6.4.</b> The calibration curve of using the handheld electrochemical detector for amperometric measure of different concentration of <i>S. Typhimurium</i> .....	119
<b>Figure 6.5.</b> The specificity of the developed electrochemical aptasensor for the detection of <i>S. Typhimurium</i> .....	120



**List of Publications:**

**Chapter 3:** Xu, M., R. Wang, and Y. Li. 2017. Electrochemical biosensors for rapid detection of *Escherichia coli* O157:H7. *Talanta* 162: 511-522. DOI: 10.1016/j.talanta.2016.10.050.

**Chapter 4:** Xu, M., R. Wang, and Y. Li. 2016. Rapid Detection of *Escherichia coli* O157:H7 and *Salmonella* Typhimurium in Foods Using an Electrochemical Immunosensor Based on Screen-printed Interdigitated Microelectrode and Immunomagnetic Separation. *Talanta* 148: 200-208. DOI: 10.1016/j.talanta.2015.10.082.

**Chapter 5:** Xu, M., R. Wang, and Y. Li. 2016. An electrochemical biosensor for rapid detection of *E. coli* O157:H7 with highly efficient bifunctional glucose oxidase-polydopamine nanocomposites and Prussian blue modified screen-printed interdigitated electrode. *Analyst* 141: 5441-5449. DOI: 10.1039/C6AN00873A.

## **Chapter 1. Introduction**

Over many decades, foodborne illnesses caused by pathogenic bacteria have always been a serious threat to the health of people and to the economy of nations. The Centers for Disease Control and Prevention (CDC) has estimated that roughly 48 million people get sick, 128,000 are hospitalized, and 3,000 are dead every year in the United States (CDC, 2011) due to foodborne illness. A report by Scharff (2012) estimated that the annual cost of foodborne illness in the United States is \$77.7 billion which was calculated based on an advanced model that includes aspects of medical costs, illness-related mortality, and a more inclusive pain, suffering, and functional disability measurement. Just during the past several months in 2016, there have been six cases of multistate foodborne outbreaks related to *E. coli* O157:H7, *Salmonella*, and *Listeria monocytogenes* that caused 83 people getting sick, 35 of them were hospitalized, and two were dead (CDC, 2016). In the four of these six cases, the food companies which produced the contaminated food were required to recall their products. It can be seen all these cases have caused great damages on the wellbeing of people as well as the revenue of food industry. Therefore, both of the consumers and the food manufacturers always have high demand on highly accurate and advanced methods to detect these pathogenic bacteria.

There are many types of methods developed for the detection of pathogenic bacteria so far. Conventional methods for the detection and identification of microorganisms are generally based on the physiological and morphological features of the bacterial cell or colonies. These methods, such as culturing and colony counting, polymerase chain reaction (PCR) and enzyme-linked immunosorbent assay (ELISA), although are still considered as the “golden standard” for the detection of many bacteria and the most common ways applied in the food inspection currently due to their good sensitivity, selectivity and reliability, have disadvantages including time-

consuming and labor-intensive. Most of these methods require long and tedious pre-enrichment procedures in order to achieve very low limit of detection. These methods are mostly centralized in large microbiological laboratories due to the requirements of using complex heavy instrumentation and highly trained technicians (Ivnitski *et al.*, 2000).

In recent years, biosensors have been intensively studied because of their desirable qualities like rapidness, low cost, and easy operation. The definition of a biosensor is an analytical device that contains a biologically derived recognition molecule such as antibodies, aptamers, phages, single-stranded DNA, enzymes, lectins, or tissue, and a transducing physiochemical element to convert a biochemical event to a measurable signal, which can be optical, electrochemical, thermal, piezoelectric, magnetic, or micromechanical (Lazcka *et al.*, 2007; Sharma & Mutharasan, 2013). Electrochemical biosensors, one branch in the biosensor category for rapid detection, present advantages like good sensitivity, miniaturization potential, and mass production, and have proven to be very promising in the applications for foodborne pathogens (Palchetti & Mascini, 2008). There are three common electrochemical methods: voltammetry, amperometry, and electrochemical impedance spectroscopy. Generally, they are based on the measurement of different electric parameters to which the changes occurred due to the interaction at the sensor-sample interface. Generally, the strategies these methods have employed are either (1) indirect detection that a sandwich-like structure comprising of the target recognition element, the target bacterial cell, and the biochemical label (commonly enzyme) is formed, or (2) direct detection that the target bacterial cells are directly adsorbed to the surface of the biosensor (Fu *et al.*, 2005). Both strategies yield detectable changes as electric signals at the interface of the electrode and the media. Compared to their optical counterparts, electrochemical methods allow to conduct the detection in turbid samples, and also they have great potential to be

miniaturized, cost-effective, and portable. These qualities show that the electrochemical methods are advantageous for *in situ* monitoring with very short detection time.

Even though these electrochemical biosensors present promising features for the detection of pathogenic bacteria, there are still many aspects should be explored in order to improve the performance of these sensors. Major drawback of the electrochemical biosensors is that the limit of detection of most sensors in publications or on the market still cannot reach to the infectious dose of major foodborne pathogens. The cause of this drawback is probably due to the dilemma between the LODs and the detection time. Comparing across the entire electrochemical biosensor category, the ones that use labelling reagents such as MBs, enzymes, or nanoparticles usually achieve lower LODs because the labelling reagents can effectively amplify the signal, but the labelling procedures also require longer detection time. On the other hand, the biosensors that use the label-free strategy can finish the detection in much shorter time. However, these label-free methods usually depend on the electrochemical changes caused by the direct attachment of bacterial cells on the electrode surface. Therefore, they show relatively higher LODs because their lack of additional amplification (Chemburu *et al.*, 2005; Lin, *et al.*, 2008; Monzo *et al.*, 2015; Settingington & Alocilia, 2012; Shabani *et al.*, 2008; Varshney & Li, 2007; Zelada-Guillen *et al.*, 2010).

In this research, three electrochemical biosensors were developed based on different strategies for the rapid detection of foodborne pathogens such as *E. coli* O157:H7 and *S. Typhimurium* which are the common model targets. The first biosensor was based on electrochemical impedance spectroscopy using a sandwich-like structure comprising of immunomagnetic beads, target bacterial cells, and Ab-conjugated GOx. The catalysis of glucose caused by the GOx labelled on the target bacteria reduced the impedance of the solution. It

avoided the complicated immobilization process and used bare SP-IDMEs for the measurement, and entire detection process was simple and easy-to-handle. The second biosensor was an amperometric biosensor based on synthesized bifunctional magnetic polydopamine polymeric nanocomposites. The synthesized PMNCs serve as both the immunomagnetic carrier and the enzymatic labelling which allowed to optimally utilize the limited binding sites on the bacterial cells in order to achieve more efficient amplification in the detection of the target bacteria. The biosensors developed in this research are capable of being adapted to detect other pathogenic bacteria. The third biosensor was the extension of the concept of using bifunctional PMNCs for the detection of *S. Typhimurium*. The biorecognition element in this biosensor was changed to aptamers which are ssDNA that chemically selected *in vitro* and can specifically bind to the target analyte. The current response was based on the attraction of magnetic PMNCs-cell conjugates to the surface of electrode. The detection procedure was very simple and showed short detection time. Both the second and the third biosensors used a handheld electrochemical detector for the amperometric measurement, which proved the portability of the developed biosensors and could be suitable for in-field applications.

## 1.1 References

CDC (Centers for Disease Control and Prevention). 2011. *CDC estimates of foodborne illness in the United States*, <http://www.cdc.gov/foodborneburden/2011-foodborne-estimates.html>. Accessed on June 2016.

CDC (Centers for Disease Control and Prevention). 2016. *List of selected multistate foodborne outbreak investigations*, <http://www.cdc.gov/foodsafety/outbreaks/multistate-outbreaks/outbreaks-list.html>. Accessed on June 2016.

Chemburu, S., E. Wilkins, and I. Abdel-Hamid. 2005. Detection of pathogenic bacteria in food samples using highly-dispersed carbon particles. *Biosens. Bioelectron.* 21(3): 491-499.

Fu, Z., S. Rogelj, and T. L. Kieft. 2005. Rapid detection of *Escherichia coli* O157:H7 by immunomagnetic separation and real-time PCR. *Int. J. Food Microbiol.* 99(1): 47-57.

- Lazcka, O., F. J. D. Campo, and F. X. Munoz. 2007. Pathogen detection: A perspective of traditional methods and biosensors. *Biosens. Bioelectron.* 22: 1205-1217.
- Lin, Y.-H., S.-H. Chen, Y.-C. Chuang, Y.-C. Lu, T. Y. Shen, C. A. Chang, and C.-S. Lin. 2008. Disposable amperometric immunosensing strips fabricated by Au nanoparticles-modified screen-printed carbon electrodes for the detection of foodborne pathogen *Escherichia coli* O157:H7. *Biosens. Bioelectron.* 23: 1832-1837.
- Monzo, J., I. Insua, F. Fernandez-Trillo, and P. Rodriguez. 2015. Fundamentals, achievements and challenges in the electrochemical sensing of pathogens. *Analyst* 140: 7116-7128.
- Ivnitski, D., I. Abdel-Hamid, P. Atanasov, E. Wilkins, and S. Stricker. 2000. Application of electrochemical biosensors for detection of food pathogenic bacteria. *Electroanal.* 12: 317-325.
- Palchetti, I., and M. Mascini. 2008. Electroanalytical biosensors and their potential for food pathogen and toxin detection. *Anal. Bioanal. Chem.* 391: 455-471.
- Scharff, R. L. 2012. Economic burden from health losses due to foodborne illness in the United States. *J. Food Prot.* 75(1): 123-131.
- Settingington, E. B., and E. C. Alocilja. 2012. Electrochemical biosensor for rapid and sensitive detection of magnetically extracted bacterial pathogens. *Biosens.* 2(1): 15-31.
- Shabani, A., M. Zourob, B. Allain, C. A. Marquette, M. F. Lawrence, and R. Mandeville. 2008. Bacteriophage-modified microarrays for the direct impedimetric detection of bacteria. *Anal. Chem.* 80(24): 9475-9482.
- Sharma, H., and R. Mutharasan. 2013. Review of biosensors for foodborne pathogens and toxins. *Sens. Actu. B* 183: 535-549.
- Varshney, M., and Y. Li. 2007. Interdigitated array microelectrode based impedance biosensor coupled with magnetic nanoparticle-antibody conjugates for detection of *Escherichia coli* O157:H7 in food samples. *Biosens. Bioelectron.* 22: 2408-2414.
- Zelada-Guillen, G. A., S. V. Bhosale, J. Riu, and F. X. Rius. 2010. Real-time potentiometric detection of bacteria in complex samples. *Anal. Chem.* 82: 9254-9260.

## Chapter 2. Objectives

The overall goal of this research is to develop electrochemical biosensors for rapid detection of foodborne pathogens. *E. coli* O157:H7 and *S. Typhimurium* are chosen to be the model targets. The purpose of this research essentially is to use the screen-printed interdigitated electrodes and to improve the performance of the electrochemical biosensors to achieve lower limit of detection, shorter detection time, and more suitable for in-field detection of foodborne pathogens.

The specific objectives of this research are as follows:

1. To develop an electrochemical biosensor based on electrochemical impedance spectroscopy using screen-printed interdigitated microelectrodes for the detection of *E. coli* O157:H7 and *S. Typhimurium*.

The sub-objectives of this part of the research were:

- a. To construct an impedimetric biosensor based on the use of immunomagnetic separation and glucose oxidase labelling with the bare SP-IDMEs for the measurement.
  - b. To use the developed impedimetric biosensor to detection *E. coli* O157:H7 and *S. Typhimurium* in the pure culture, and also to validate the detection of two target pathogens in respective food samples.
2. To develop an amperometric biosensor based on the use of bifunctional magnetic GOx-PDA PMNCs and PB-modified SP-IDMEs for the detection of *E. coli* O157:H7.

The sub-objectives of this part of the research were:

- a. To synthesize the Abs/GOx<sub>ext</sub>/AuNPs/MBs-GOx@PDA PMNCs based on the self-polymerization of commercial dopamine chloride and the biochemical synthesis of AuNPs.

- b. To construct an amperometric biosensor using the synthesized PMNCs which served as both the carrier and the signal amplifier for the detection of *E. coli* O157:H7.
  - c. To apply a handheld electrochemical detector to replace the desktop instruments to demonstrate the feasibility of using the developed method for in-field detection of *E. coli* O157:H7.
3. To expand the concept of using bifunctional magnetic PMNCs for detection of *S.*

Typhimurium with aptamer-based electrochemical biosensor.

The sub-objectives of this part of the research were:

- a. Adapt the concept of magnetic AuNPs/MBs-GOx@PDA PMNCs to be functionalized by anti-*Salmonella* aptamers.
- b. To construct an electrochemical biosensor based on synthesized aptamers/GO<sub>x</sub><sub>ext</sub>/AuNPs/MBs-GOx@PDA PMNCs and redox-glucose probe.



## Chapter 3. Literature Review

### 3.1 Foodborne pathogens and illnesses

Foodborne illnesses caused by pathogenic bacteria have always been a serious threat to the health of people and to the economics of nations. The Centers for Disease Control and Prevention (CDC) has estimated that roughly 48 million people get sick, 128,000 are hospitalized, and 3,000 are dead every year in the United States due to foodborne illness (Scallan *et al.*, 2011). Among all the cases of foodborne illnesses, about 9.4 million cases (20%) are caused by 31 types of known pathogens, including norovirus, *Salmonella*, *Clostridium*, *Campylobacter spp.*, *Staphylococcus*, *E. coli*, etc. There are also 38.4 million cases (80%) are caused by a broad spectrum of unknown agents (Scallan *et al.*, 2011). Based on a report by Scharff (2012), if considering the aspects of medical costs, illness-related mortality, and a monetized quality-adjusted life year estimates according to a more inclusive pain, suffering, and functional disability measure, the cost-of-illness due to these foodborne illnesses could be as high as \$77.7 billion per year.

Many surveillance systems have been established to provide laboratory confirmation for the emerging infections of foodborne pathogens. These surveillance systems relying on data collected from state and local health agencies can play an important role in food safety and foodborne illness prevention. Foodborne Disease Active Surveillance Network (FoodNet), for instance, monitors foodborne illness caused by seven bacteria and two parasites in 10 states. It actively communicates with clinical laboratories all over the country to identify new cases. Once the cases are identified, the system collects information about these cases, uploads them into the electronic database, and reports to the government agencies such as CDC. However, as important as it can be, these surveillance systems can only take actions after the illness has occurred and

the damage from the foodborne pathogens has already been done. Therefore, the prevention methods to cut the source of the infections and to stop the outbreaks from even happening are of extreme value.

### **3.1.1 *Escherichia coli* O157:H7**

*E. coli* O157:H7 is an enterohemorrhagic serotype of the bacterium *Escherichia coli*, and has been considered as one of the most virulent strains among all foodborne pathogens. As one of the most studied bacteria, *E. coli* O157:H7 was first identified in two outbreaks associated with gastrointestinal illness in Oregon and Michigan in 1982 (Riley *et al.*, 1983). The pathogen mainly spreads through the route of fecal-oral transmission and only a small dose of the bacteria (10 to 100 cells) can cause diseases. Therefore, a tiny amount of feces with the bacteria inside may induce the infection. It usually happens when contaminated foods or unclean water were consumed. The foods with high risk of carrying *E. coli* O157:H7 include unpasteurized milk and milk products, undercooked beef and ground beef, unclean leafy green contacted with the animal feces, and contaminated water. The infection by *E. coli* O157:H7 can cause vomiting, severe acute hemorrhagic diarrhea, and abdominal cramps. The patients may only show little or even no fever. But it can also cause a very severe complication called Hemolytic Uremic Syndrome (HUS), especially in children under the age of five and the elders who have vulnerable immune system. The HUS can lead to kidney failure, and possibly the death of the patients.

*E. coli* O157:H7 infections can have a great impact on the public health and the economy. In the United States, there are estimated over 63,000 cases of *E. coli* O157:H7 infection occurred each year. About 2,100 of those cases involve hospitalization and up to 20 deaths would occur (Scallan *et al.*, 2011; Scharff, 2012). The illness not only will cost money on the medical care and follow-ups for the patients, it will also lead to the additional loss on the labor force.

Especially due to the increasing consumption of minimally processed products, such as fruits, vegetables, and ready-to-eat (RTE) products, multistate foodborne outbreaks related to this pathogen in recent years have caused serious concerns on the inspection and monitoring to ensure the safety of food products and reduce the occurrence of foodborne illness (CDC, 2016). It was estimated the total cost per case of *E. coli* O157:H7 infections is about \$9,600, and therefore the total cost of all cases would be over 600 million dollars per year (Scharff, 2012). Moreover, the recalls usually associated with the bacterial outbreaks can bring tremendous damage on the food industry. Just in May 2014, a multistate outbreak linked to ground beef possibly contaminated with *E. coli* O157:H7 was traced to Wolverine Packing Company, and 1.8 million pounds of ground beef products were recalled (CDC, 2014). The top three largest ground beef recalls in the U.S. history include (1) Hudson Foods Company recalled 25 million pounds of ground beef in 1997; (2) Topps Meat Company announced a recall of 21.7 million pounds of frozen hamburger patties in 2007; and (3) ConAgra Foods made a recall covering 19.7 million pounds of ground beef in 2002. All these big recalls along with other events caused huge economic and reputational loss for those food companies.

### **3.1.2 *Salmonella* Typhimurium**

*Salmonella* is a genus of gram-negative bacteria of the Enterobacteriaceae family, and can be further split into two species, *S. enterica* and *S. bongori*. *Salmonella* are rod-shape, facultative anaerobes, non-sporulating, predominately motile enterobacteria. *S. enterica* subspecies, which are mostly found in all warm-blood animals and in the environment, can be further divided into 6 subspecies based on their phenotypic profiles. CDC estimates there are about 1.1 million cases of *Salmonella* infections and around 380 deaths occurred due to the contaminated food by non-typhoidal *Salmonella* each year in the US, and it has the highest percentage of hospitalization

among all pathogens (CDC, 2011). Young children (especially under age of 5), elders, and people with compromised immune systems are susceptible to severe *Salmonella* infection (Scallan *et al.*, 2011).

There are over 2500 serotypes of *Salmonella*, *S. Enteritidis* and *S. Typhimurium* are the two most common causes for human infections in the U.S. *S. Typhimurium* in human does not commonly cause fatal disease, and symptoms usually include diarrhea, abdominal cramps, vomiting and nausea, and can last up to last days. However, if immune-impaired people like infants and elders do not receive appropriate antibiotic treatment, the disease can become invasive into the blood stream, spreading to other body sites, and eventually can lead to death. Most recent events of foodborne outbreaks related to *S. Typhimurium* are: (1) A multistate outbreak of human *S. Typhimurium* infection associated with live poultry in backyard flocks in which 356 people got sick and 62 were hospitalized (CDC, 2013(a)), and (2) A multistate outbreak of *S. Typhimurium* infection associated with ground beef in which 22 cases of illnesses occurred and 7 people were hospitalized (CDC, 2013(b)).

### **3.2 Conventional methods for the detection of *E. coli* O157:H7 and *S. Typhimurium***

Even though there have been many legislations, regulations, and methodical programs like good manufacturing practices (GMP) and hazard analysis and critical control point (HACCP) which can greatly reduce the occurrence of foodborne pathogens in food, the methods for sensitive, reliable, and rapid detection of these pathogens are still critical to identify and prevent the problems from pathogenic bacteria. Currently, conventional cultural and molecule based methods for the detection and enumeration of foodborne pathogens are still the most commonly practiced techniques in the food safety area.

The culture-based methods rely on the multiplication of all viable bacterial cells on a nutrient rich medium that supports the growth of the organisms to form colonies that can be enumerated. In recent years, the culture-based methods have been modified for the different applications with the development of automatic enumeration system (Fung, 2006; Lazcka *et al.*, 2007; Radu *et al.*, 2000). The testing procedures for food samples can generally be divided into three stages: (1) sample preparation and bacteria isolation; (2) a series of enrichments on selective and non-selective growth media; and (3) detection, enumeration, and identification of the target pathogens. The process may take up to five days to obtain a presumptive positive isolate (Bell *et al.*, 2016). Therefore, even the newer automated systems which can allow multiple samples to be simultaneously tested, the confirmation of the target pathogens still requires at least 24 h.

On the other hand, molecule, especially polymerase chain reaction (PCR)- based methods show high levels of specificity and sensitivity because this type of methods is based on the detection of nucleic acid sequences of target bacteria, and the specifically designed short synthetic oligonucleotides can solely hybridize to these target sequences that are complementary to each other (Deisingh & Thompson, 2004). It was reported that PCR assay could be much more sensitive in the detection of *Salmonella* than culture or ELISA-based methods (Kumar *et al.*, 2008). Considering PCR-based methods detect the microorganisms by amplifying the target DNA sequence itself rather than the signals, it is less prone to generating false-positive results (Velusamy *et al.*, 2009). Furthermore, the amplification time of the DNA from the bacterial cells can be much shorter, which leads to a much more rapid procedure to detect the bacteria than conventional culture-based methods (Newton & Graham, 1997; Hu *et al.*, 1999; Lazcka *et al.*, 2007; Logan *et al.*, 2009). However, from the perspective of the food industry, using PCR based

methods for routine detection of foodborne pathogens can be less attractive because these tests are expensive and complicated, requiring skilled operators to carry out the tests.

Some of the protocols using culture or PCR based methods are standardized and validated by many national and international organizations as guidelines in public health laboratories for detection and enumeration of *E. coli* O157:H7 and *S. Typhimurium*. (FDA, 2013; ISO, 2016). These conventional methods are applied for the detection of foodborne pathogens all over the world due to their sensitivity to target microorganisms, efficiency, reproducibility and suitability to a wide range of food matrices, and they are considered as more reliable options to confirm the obtained results of the presence of the pathogens. However, despite the advantages and wide acceptance of these conventional methods, there are several drawbacks such as requiring certain instruments (incubators, spectrophotometers, *etc.*), consuming large amounts of media which also leads to the generation of large amounts of biological waste, time-consuming, suffering from the interference of complex food matrices, and requiring trained technicians to carefully prepare samples, correctly carry out the test procedures, and interpret the obtained results, which make them less satisfying to prevent infections of foodborne pathogens. There are also other detection methods which are less common, such as ATP bioluminescence (Hunter & Lim, 2010), flow cytometry (Betts & Blackburn, 2009), and solid-phase cytometry (D' Haese & Nelis, 2002). Recent development of rapid detection methods have focused on the improvements on specificity, reliability, feasibility in different environment, rapid technique, miniaturization, and low-cost (Yeni *et al.*, 2014). The characteristics of the conventional methods for the detection of *E. coli* O157:H7 and *S. Typhimurium* are listed in Table 3.1.

Table 3.1. Characteristics of common conventional and some alternative methods (Mandal *et al.*, 2011; Park *et al.*, 2014)

Methods	LODs (cfu/ml or g)	Detection time	Specificity
Culture plating	1	5 to 7 d	Good
ELISA	10 to 100	6 h to 2 d	Good
Single/multiplex PCR	1	4 to 24 h	Excellent
Real-time PCR	1	< 25 min	Excellent
Bioluminescence	10 <sup>4</sup>	30 min	No
Flow cytometry	10 <sup>2</sup> to 10 <sup>3</sup>	30 min	good

### 3.3 Biosensors for the detection of foodborne pathogens

The acknowledged world's first biosensor was fabricated by Clark and Lyons (1962) for the detection of glucose using immobilization of glucose oxidase on the electrode and the electrochemical detection of hydrogen peroxide generated in the reduction-oxidation of glucose. Since then, incredible innovations have been integrated into the development of biosensors using

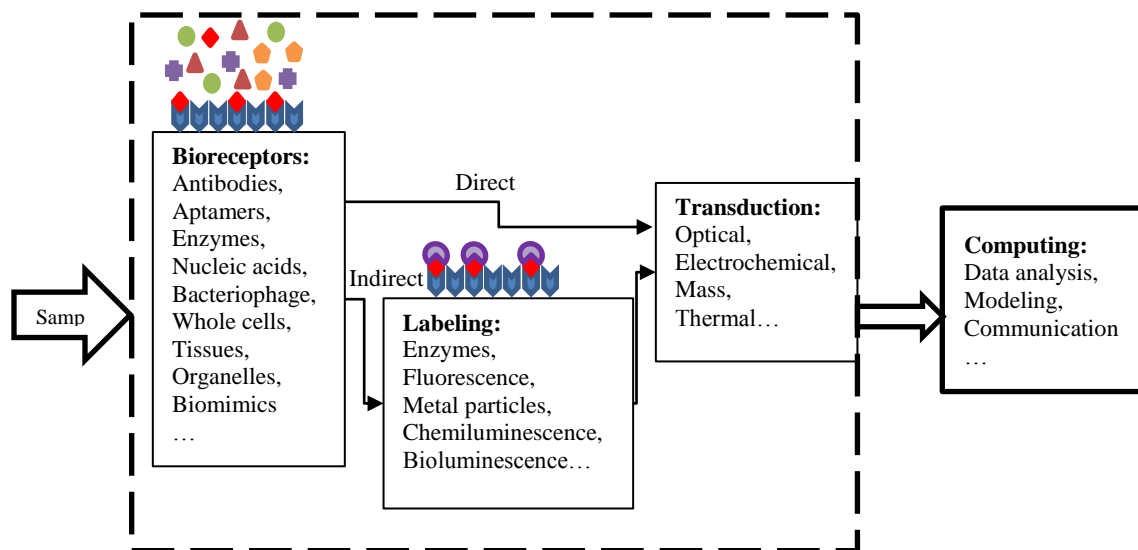

Figure 3.1. The schematic frame of a typical biosensor.

novel approaches to improve their sensing performance. The term “biosensor” refers to an analytical device which is comprised of a biological receptor that can specifically recognize and capture the target analyte, a physical or chemical transducer that convert the biological and/or chemical event into a quantifiable and analyzable signal (Law *et al.*, 2015; Turner, 2013; Velusamy *et al.*, 2009; Vigneshvar *et al.*, 2016; Zhao *et al.*, 2014) (Fig. 3.1). As shown in Fig. 3.1, the biological receptors used in a biosensor can be antibodies (Abs), aptamers, enzymes, ssDNA/RNA probes, bacteriophages, and more. Furthermore, based on the transduction mechanism, biosensors can be classified into optical (including light adsorption/reflection, surface plasmon resonance (SPR), fluorescence, luminescence, and optical fiber), mass or mass-sensitive (such as quartz crystal microbalance (QCM), surface acoustic wave, magnetoelastic, and cantilever), electrochemical (including amperometric, potentiometric, impedimetric, and conductometric), calorimetric, and others. Electrochemical biosensors rely on the attachment of labels (most enzymes) or the interaction of bioreceptors and bacterial cells, which can alter the electrical parameters like current, potential, or impedance at the surface of electrodes. Optical biosensors are based on the optical properties of the samples or the biological labels that are affected by the interaction between the analyte and the biological recognition element. Piezoelectric biosensors are mass-sensitive detectors based on a quartz-crystal resonator oscillating at a fundamental, surface-geometry-dependent frequency. It can establish a quantitative relationship between the mass changes on the crystal surface and the resonant frequency of the crystal. Based on a literature search under the key words of “biosensors” and “*Escherichia coli* O157:H7” on the EBSCOhost research databases, the number of recent publications (from 2000 to 2015) using different transducers in the development of biosensors for the detection of *E. coli* O157:H7 are shown in Fig. 3.2(a). Optical and electrochemical



biosensors are still the transduction techniques studied the most for the detection of foodborne pathogens.

Among all the biosensor-based methods that have been established over the past fifteen years,

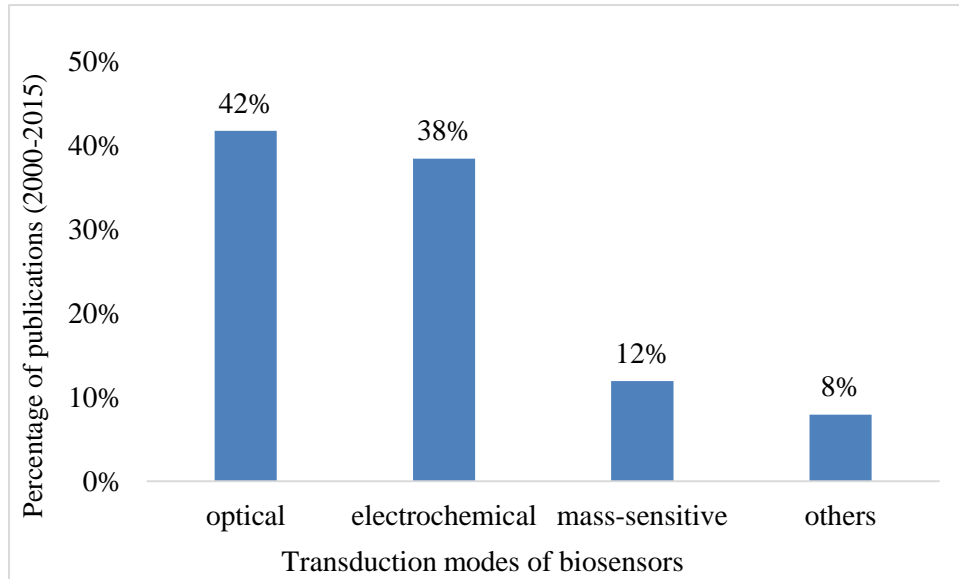

(a)

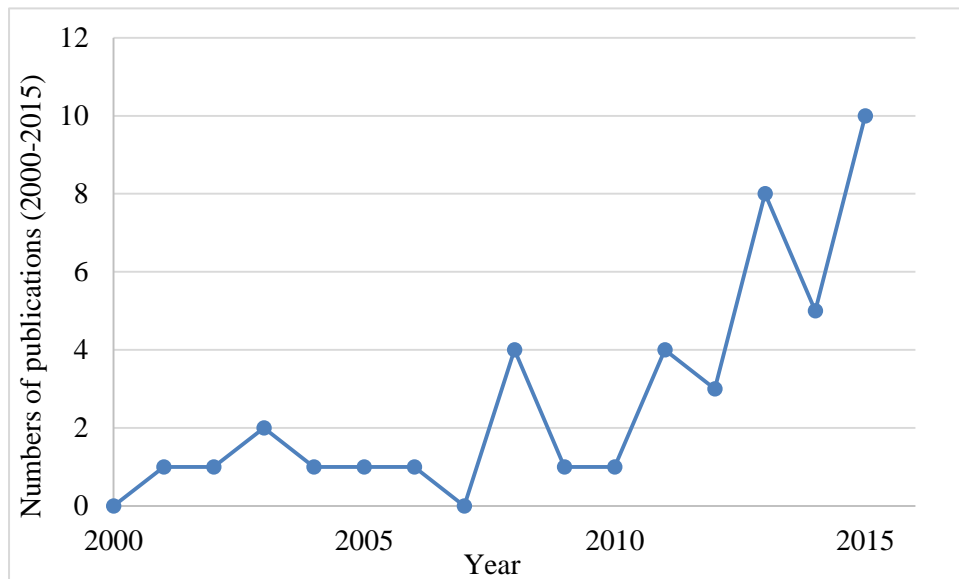

(b)

Figure 3.2. (a) Approximate number of publications using biosensor methods for the detection of *E. coli* O157:H7. (b) Approximate number of publications using electrochemical biosensors for the detection of *E. coli* O157:H7 on yearly order. Source is EBSCOhost research databases.

electrochemical biosensors are regarded as one of the most promising biosensors to detect foodborne pathogens and grow rapidly (Fig. 3.2(b)). Electrochemical biosensors can be broadly classified into label-dependent and label-free techniques according to their detection strategies. Label-dependent methods apply labels (such as enzymes, conductive polymers, metal particles, and more) to specifically tag the target analyte, whereas the label-free techniques are based on the attachment of bacterial cells onto the electrode surface to induce measurable changes in electrical parameters (Sang *et al.*, 2016). Based on the electrical parameters being measured, electrochemical biosensors can be further divided into sub-categories of amperometric, potentiometric, conductometric, and impedimetric.

There have been many comprehensive review articles published aiming to illustrate the latest states on biosensors for the detection of foodborne pathogen (Ahmed *et al.*, 2014; Arora *et al.*, 2013; Palchetti & Mascini, 2008; Sharma & Mutharasan, 2013; Velusamy *et al.*, 2009), electrochemical biosensors for the detection of *Salmonella* (Melo *et al.*, 2016), virus detection (Grabowska *et al.*, 2014) and toxins (Reverté *et al.*, 2016). A summary is designated to collect recent publications (from 2000 to 2015) of electrochemical biosensors used to specifically detect *E. coli* O157:H7 and *S. Typhimurium* as the model pathogenic bacteria, and divides these papers based on the sensing strategies and measured electrical parameters. The discussions include sensing configurations, sensing performance, strength and weakness of the methods, and the future trends. This review is hoped to illustrate a broad and comprehensive understanding of electrochemical biosensors for the detection of foodborne pathogens.

### **3.4 Electrochemical biosensors for the detection of *E. coli* O157:H7 and *S. Typhimurium***

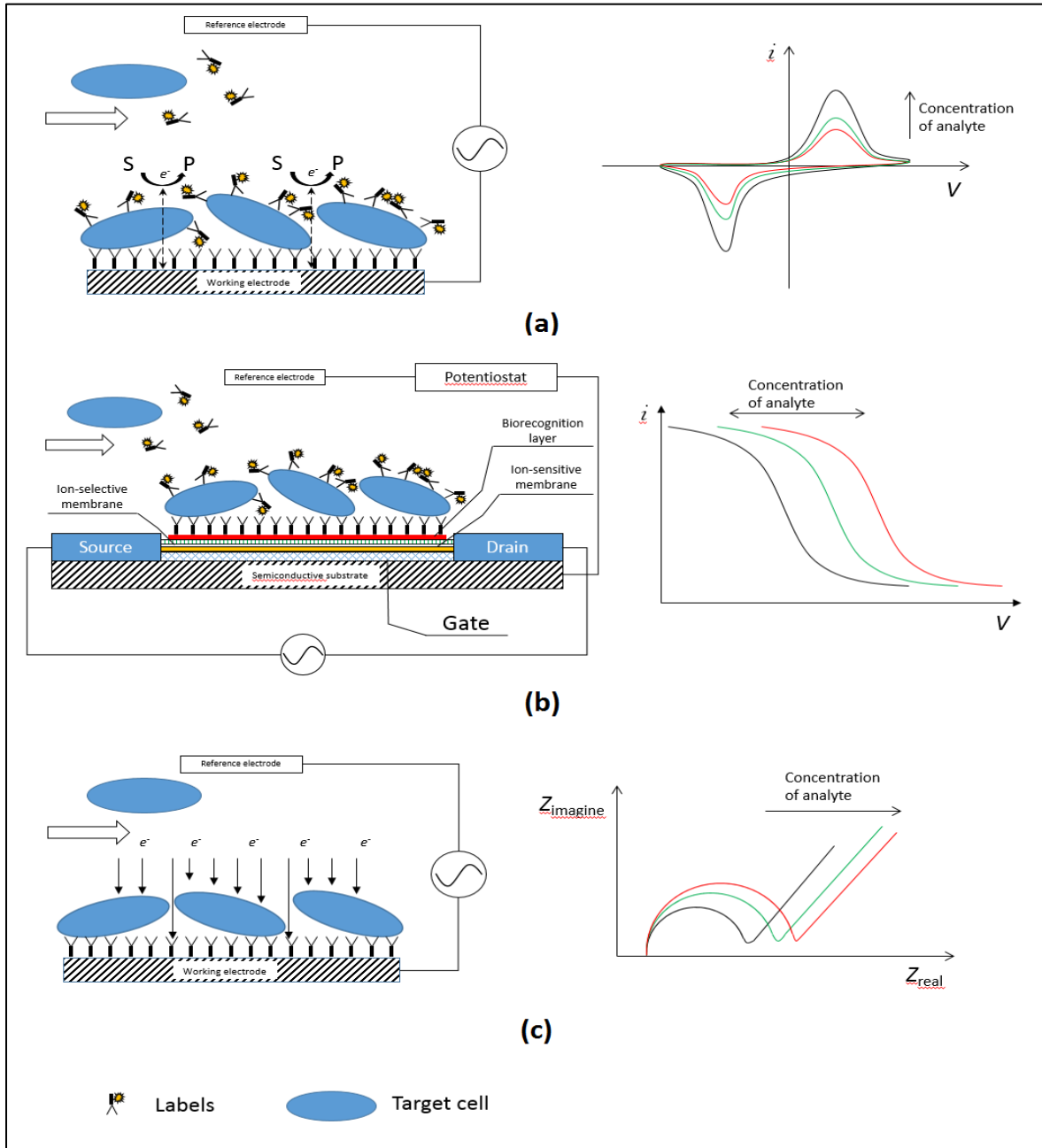

Figure 3.3. (a) The schematic mechanism of an amperometric biosensor. The labels (commonly enzymes) facilitate the electron transfer between the electrochemical active pairs in the solution and the electrode. (b) The schematic mechanism of a ISFETs potentiometric biosensor. The labels change the concentration of specific ions ( $H^+$ ,  $K^+$ , etc.). A current flowing through a channel under the gate insulator is regulated by the gate potential. The selected ions accumulate on the gate insulator, causing potential different and changing the current flow in the channel. (c) The schematic mechanism of an impedimetric biosensor. The impedance is increased because the electron transfer was blocked due to the attachment of bacterial cells on the surface of the electrode.

Electrochemical biosensors are intensively studied and well developed for the detection of foodborne pathogens. Some advantages of electrochemical biosensors over others include comparable sensitivity, fast response, possibility to operate in turbid solution, and possibility to be miniaturized. Furthermore, due the current state-of-the-art techniques used in the fabrication of electronics, the electrochemical biosensors can be integrated into one simple, automated, and low cost device (Law *et al.*, 2015; Palchetti & Mascini, 2008; Sharma & Mutharasan, 2013; Velusamy *et al.*, 2009; Wang & Salazar, 2016). On the other hand, to apply electrochemical biosensors to the detection of foodborne pathogens, there are still some drawbacks need to be overcome. Difficulties comes from complex food samples are the most concerned. The bacteria are highly unlikely distributed in/on foods in the pattern of uniformity. Therefore, it makes the direct use of electrochemical biosensors for the detection of pathogenic bacteria very hard without appropriate sample collections and preparations. Moreover, the complexity of food matrices can vary based on the content (proteins, fat, carbohydrates, chemicals, etc.), the formality (solid, liquid, gel, or other types), and the viscosity (Mandal *et al.*, 2011) which can greatly affect the performance of biosensors. The specificity of the electrochemical biosensors is also concerned, especially to the bacteria with no health risks but can interfere with the specific recognition by the bioreceptors in the sensors. Therefore, recent research in the development of electrochemical biosensors for the detection of foodborne pathogens have focused on the improvement of aspects such as novel bioreceptors, better design of electrodes, and nanomaterials for effective electron transduction. Based on the mechanism and the electric parameters being monitored, electrochemical biosensors can be further divided into amperometric/voltammetric, potentiometric, and impedimetric/conductometric biosensors.

*Amperometric/voltammetric* biosensors monitor the changes in current or potential that caused by the oxidation or reduction of the electrochemically active analyte in the electrochemical system. The Cottrell equation can be used to express the relation between the electric current and the concentration of the analyte:

$$i = nFAC_o[D/(\pi t)]^{1/2}, \quad (3.1)$$

where  $i$  is the current being monitored,  $n$  is the number of electrons being transferred in the redox reaction,  $F$  is the Faraday constant (96,485 C/mol),  $A$  is the area of electrode,  $C_o$  is the initial concentration of the reducible analyte,  $D$  is the diffusion coefficient of the reducible analyte in the media,  $t$  is the time elapsed since the potential is applied. The term “amperometry” refers to the current is measured when the potential is fixed at a constant value, and the term “voltammetry” refers to the current is measured when the applied potential is changed under controlled variations (Grieshaber *et al.*, 2008). This type of electrochemical biosensors is commonly fabricated on the basis of an enzyme system (Fig. 3.3(a)). The electrochemically inactive substrates in the solution are catalyzed by the enzyme into electrochemically active products that can have the electron transfer at the surface of the working electrode, or the electrons are transferred from the enzyme to the electrode through direct contact or reversible oxidizing reagents (mediators) (Grieshaber *et al.*, 2008; Palchetti & Mascini, 2008). The performance of amperometric/voltammetric biosensors are mainly restricted by the interferences of other electrochemical active compounds that have similar redox potentials to the analyte of interest. Due to the use of enzyme, this type of biosensors is also limited by the saturation kinetics of enzymes, the denaturation in the process, and the stability of the applied enzyme.

*Potentiometric* biosensors operate using a high voltmeter to measure the electrical potential difference or electromotive force between the working and reference electrodes. The

electrochemical process is non-faradic with no, or negligible, net current flow in the electrochemical cell, and the potential difference is generated due to the accumulation of charge density at the surface of a working electrode. A potentiometric biosensor is commonly comprised of an ion perm-selective outlayer and a bioactive material (enzymes). The measurement is based on the Nernst equation which describes a logarithmic relationship of the concentration response to the potential:

$$E = E_0 + [RT/(nF)] \ln a, \quad (3.2)$$

where  $E$  is the potential for the measurement,  $E_0$  is the standard potential when  $a = 1$  mol/l,  $R$  is the gas constant, 8.314 J/(mol K),  $T$  is the absolute temperature in K,  $n$  is the number of electrons transferred in the electrode reaction,  $F$  is the Faraday constant, and  $a$  is the relative reactivity of the interested ion based on the concentration at the anode and the cathode (Bard & Faulkner, 2001). Potentiometric biosensors are the least common type of electrochemical biosensors in the field of foodborne pathogen detection (Palchetti & Mascini, 2008; Velusamy *et al.*, 2009), but there are still some configurations have been proven to be feasible. Ion-selective field effect transistors (ISFETs) and light-addressable potentiometric sensors (LAPSs) are the two major types of potentiometric biosensors that have been studied. ISFETs response to specific ions ( $H^+$ ,  $K^+$ ,  $Cl^-$ , etc.) by applying an electric field to create regions of excess charge in a semiconductor substrate and using an ion-selective membrane to cover the gate insulator to allow the ion of interest to pass (Bergveld, 2003). Studies on ISFET-based biosensors for the detection of pathogens have indicated poor limits of detection (LODs) and device stability due to the incompatibility between most biomolecular immobilization protocols and ISFET fabrication technology (Lazcka *et al.*, 2007; Sharma & Mutharasan, 2013). On the other hand, development on the LAPSs has proved this type of potentiometric biosensors are feasible for the detection of

foodborne pathogens (Ercole *et al.*, 2002). LAPS is based on the application of transient illumination using an intensity-modulated light source like light-emitting diodes (LEDs) to induce a transient photocurrent to an insulated n- or p- doped semiconductor thin film which is in contact with an electrolyte (Fig. 3.3(b)). The magnitude of the induced photocurrent depends on the potential applied to the semiconductor plate. There is a commercial available LAPS device, the Threshold® Immunoassay System for the detection of *E. coli* O157:H7 in food samples (Tu *et al.*, 2000).

*Impedimetric/conductometric* biosensors are probably one of the earliest types of physiochemical methods developed for the rapid detection of bacteria. This type of biosensors measures the conductivity of the solution or medium, or analyzes the electron transfer at the surface of electrodes which can be expressed into impedance response. Nowadays, an advanced technique known as electrochemical impedance spectroscopy (EIS) is very commonly used by impedimetric biosensors. The technique applies a sinusoidal potential with very small amplitude to the electrochemical system and measure the resulting current over a range of varying excitation frequency. The obtained data can be fitted into an equivalent circuit to generate valuable electrochemical parameters, including charge transfer resistance, double layer capacitance, bulk solution resistance, and inductive reactance for interpretation. The fundamental relationship in EIS can be expressed as following equation:

$$Z = R + jX = R + j(X_L - X_C), \quad (3.3)$$

where  $Z$  is the complex impedance which is the sum of the real and imaginary impedance components,  $R$  is the resistance,  $X$  is the reactance,  $X_L$  is the inductive reactance which is normally negligible in a biological system,  $X_C$  is the capacitive reactance which equals to  $1/(2\pi fC)$  where  $f$  is the frequency and  $C$  is the capacitance. As shown in Fig. 3.3(c), the working principle

of impedimetric/conductometric biosensors is based on either the immobilization of bioreceptors on the surface of the working electrode and directly measure the impedance change caused by the capture of bacteria, or the application of labels (enzymes or conductive materials) or the microbial metabolism to produce ions in the media which increase the conductance or capacitance thereby decreasing the impedance of the media (Ivnitski *et al.*, 2000). Recent years, a vast of studies have been done on the impedimetric biosensors using the direct detection strategy because the labels are no longer necessary in this setup. Thus, the detection time is greatly shorten, the detection process becomes simpler and less washing steps are involved. The limitations of impedimetric biosensors are on the complicated immobilization procedures which can greatly affect the reproducibility and regenerability of the fabricated sensors, and the LODs using EIS for pathogen detection are still not low enough (Lazcka *et al.*, 2007).



Table 3.2. Electrochemical biosensors for the detection of *E. coli* O157:H7 and *S. Typhimurium*.

Mode of transducers	pathogen	Immobilization on electrodes	Labelling	LODs (cfu/ml)	Assay time	Ref.
Amperometric /voltammetric	<i>E. coli</i> O157:H7	MBs + magnetized graphite electrode	Alkaline phosphatase	$1.5 \times 10^3$ in apple juice	80 min	Gehring & Tu, 2005
	<i>E. coli</i> O157:H7	SPCE/FeDC-AuNPs/Abs	HRP	$5 \times 10^3$ in milk	30 min	Lin <i>et al.</i> , 2008
	<i>E. coli</i> O157:H7	Au electrode/SAM of AUT/AuNPs/CHIT-MWNTs-SiO <sub>2</sub> /THI/Abs	Label-free	250	~ 30 min	Li <i>et al.</i> , 2012
	<i>E. coli</i> O157:H7, <i>Salmonella</i> , and <i>Campylobacter</i>	SPE/MWCNT-PAH/Abs	Respective Abs conjugated with CdS, CuS, or PbS nanocrystals	800, 400, and 400 in milk	> 1 h	Viswanathan <i>et al.</i> , 2012
	<i>E. coli</i> O157:H7	Bare SPCE	MBs-1 <sup>st</sup> Ab +AuNPs-2 <sup>nd</sup> Ab	148 in buffer, 457 in minced beef, and 309 in tap water	> 1 h	Hassan <i>et al.</i> , 2015
	<i>S. Typhimurium</i>	MBs + magneto-GCE	HRP-2 <sup>nd</sup> Ab	$5 \times 10^3$ in buffer, $7.5 \times 10^3$ in milk	50 min	Liébana <i>et al.</i> , 2009
	<i>S. Typhimurium</i>	MBs + SPCE with a permanent magnet beneath	AuNPs-2 <sup>nd</sup> Ab	143 cfu/ml in buffer	1.5 h	Afonso <i>et al.</i> , 2013
	<i>S. Typhimurium</i>	Au electrode/ssDNA	Alkaline phosphatase-streptavidin-2 <sup>nd</sup> Abs	6 in milk	1.5 h	Zhu <i>et al.</i> , 2014

Table 3.2. Electrochemical biosensors for the detection of *E. coli* O157:H7 and *S. Typhimurium* (Cont.).

Mode of transducers	pathogen	Immobilization on electrodes	Labelling	LODs (cfu/ml)	Assay time	Ref.
Impedimetric/ conductometric	<i>E. coli</i> O157:H7	Au electrode/SAM of neutravidin/biotin-Abs	Label-free	10 in PBS	~ 1 h	Maalouf <i>et al.</i> , 2007
	<i>E. coli</i> O157:H7	Bare IDME, MBs-Abs-cell attracted by a magnet	Label-free	$7.4 \times 10^3$ in buffer, $8.0 \times 10^3$ in ground beef	35 min	Varshney & Li, 2007(a)
	<i>E. coli</i> O157:H7	quartz crystal Au electrode/protein A/Abs	Label-free	$10^3$ in buffer	10 min	Li <i>et al.</i> , 2008
	<i>E. coli</i> K12	Quartz substrate/graphene/Abs	Label-free	10 in buffer	30 min	Huang <i>et al.</i> , 2011
	<i>E. coli</i> O157:H7	Working electrode/alumina nanoporous membrane/HA/Abs	Label-free	10 in buffer, 84 in whole milk	Not stated	Joung <i>et al.</i> , 2013
	<i>E. coli</i> O157:H7	Au disk electrode/SAM of MHDA/Abs	Label-free	2 in buffer	45 min	Santos <i>et al.</i> , 2013
	<i>E. coli</i> O157:H7	rGOP/AuNPs/Abs	Label-free	$1.5 \times 10^2$ in buffer	30 min	Wang <i>et al.</i> , 2013
	<i>E. coli</i> O157:H7	SPCE/graphene/AuNPs/Abs	Label-free	$1.5 \times 10^3$ in buffer	Not stated	Wang <i>et al.</i> , 2014
	<i>E. coli</i> O157:H7	ITO electrode/epoxysilane/Abs	Label-free	1 in buffer	45 min	Santos <i>et al.</i> , 2015
	<i>S. Typhimurium</i>	Au electrode/SAM of MUAM/thiol-Abs	Label-free	$10^5$ in buffer	1 h	Mantzila <i>et al.</i> , 2008
<i>S. Typhimurium</i>	Au electrode/polytyramine/Abs	Label-free	10 in buffer	3 h	Pournaras <i>et al.</i> , 2008	

Table 3.2. Electrochemical biosensors for the detection of *E. coli* O157:H7 and *S. Typhimurium* (Cont.).

Mode of transducers	pathogen	Immobilization on electrodes	Labelling	LODs (cfu/ml)	Assay time	Ref.
	<i>S. Typhimurium</i>	GCE/Chi-MWCNTs-PAMAM/AuNPs/Abs	Label-free	$5 \times 10^2$ in buffer	1 h	Dong <i>et al.</i> , 2013
	<i>S. Typhimurium</i>	GO/AuNPs/aptamers	Label-free	3 cfu/ml in PBS	1.5 h	Ma <i>et al.</i> , 2014
Potentiometric	<i>E. coli</i> surrogate CECT 675	GCE/SWCNT/aptamers	Label-free	6 in milk, 26 in apple juice	Real-time	Zelada-Guillen <i>et al.</i> , 2010
Capacitive	<i>E. coli</i> O157:H7	Quartz crystal Au electrodes/SAM of MPA/Abs	Label-free	$10^2$ in buffer, $10^3$ in food samples	1 h	Li <i>et al.</i> , 2011
	<i>S. Typhimurium</i>	GCE/ethylene diamine/SAM of AuNPs/Abs	Label-free	$10^2$ in buffer	40 min	Yang <i>et al.</i> , 2009

More information regarding the published articles using electrochemical biosensors for the detection of *E. coli* O157:H7 and *S. Typhimurium* are discussed with details in the following sections. The papers are divided based on the detection strategies used to fabricate the biosensors, namely the label-dependent and the label-free techniques, and are also listed in Table 3.2.

### 3.4.1 Label-dependent electrochemical biosensors

To design an electrochemical biosensor, there are generally two detection strategies, label-dependent and label-free techniques, to convert the biological recognition event into electrical

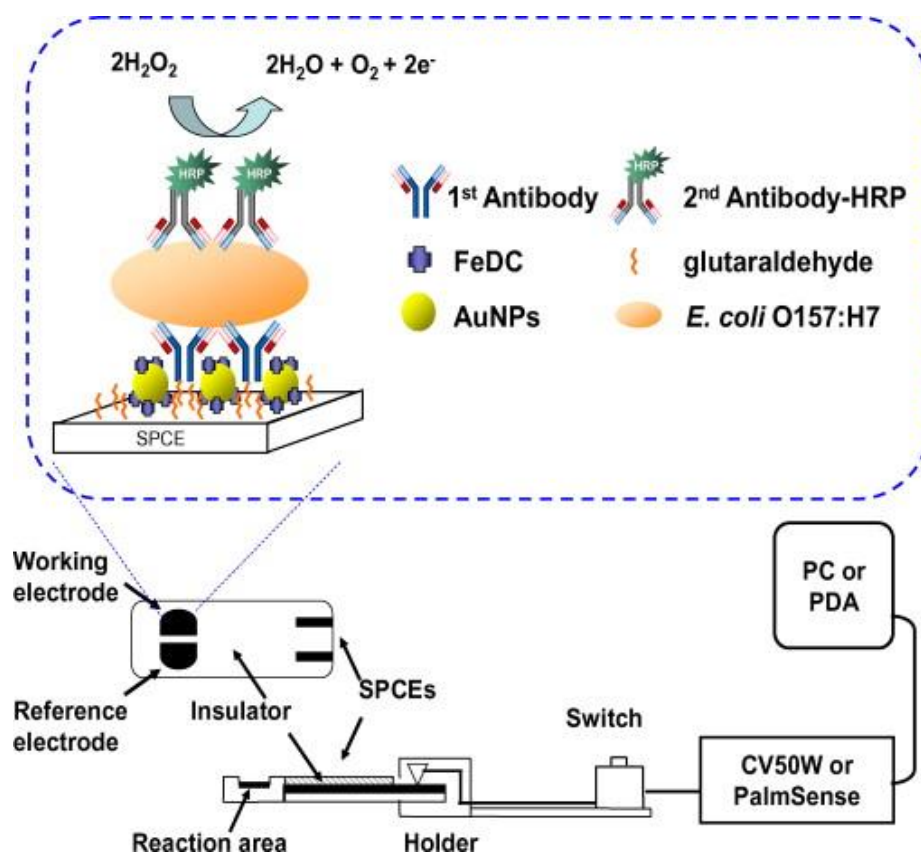

Figure 3.4. An amperometric biosensor based on screen-printed carbon electrode (SPCE) which was immobilized with ferrocenedicarboxylic acid (FeDC) (mediator) coated gold nanoparticles (AuNPs) and antibodies. After the capture of *E. coli* O157:H7, a horseradish peroxidase (HRP) conjugated second antibody was employed to label the bacterial cells and catalyze hydrogen peroxide. The apparatus setup was shown in the bottom panel. The electrochemical system was built on a disposable testing strip (Lin *et al.*, 2008). Reprinted with the permission from the publisher Elsevier.

signals. The label-dependent electrochemical biosensors employed an indirect detection which is usually based on the labels of biological or physiochemical molecules such as enzymes, metallic nanoparticles, conductive polymers, and others on the target bacterial cells to induce the electrical changes for measurement (Fig. 3.4). There was a voltammetric method using enzyme-linked immunomagnetic electrochemistry that sandwiched the target bacteria, *E. coli* O157:H7, between the immunomagnetic beads (IMBs) and the enzyme-conjugated antibodies (Gehring & Tu, 2005). The captured bacteria were adsorbed onto a magnetized graphite electrode in a multiwell plate, and the LOD was achieved at  $3.3 \times 10^3$  cfu/ml in Tris-saline and  $1.5 \times 10^3$  cfu/ml in spiked buffered apple juice. A similar disposable electrochemical immunosensor was also developed to detect *S. Typhimurium* (Afonso *et al.*, 2013). This sensor was fabricated based on MBs conjugated with anti-*Salmonella* Abs and AuNPs-label. The formed MBs-Abs-*S. Typhimurium*-Abs-AuNPs complexes were adsorbed to the surface of SPCEs with a permanent magnet beneath, and measured using differential pulse voltammetry (DPV). The electrochemical immunosensor achieved LOD of 143 cfu/ml within 1.5 h. Another amperometric biosensor was fabricated based on an indirect ELISA with double antibodies and a disposable AuNPs-modified SPCE (Lin *et al.*, 2008). The electrons were transferred from the H<sub>2</sub>O<sub>2</sub> substrate to HRP, then through FeDC-AuNPs to the SPCE. The FeDC-AuNPs immobilized on the SPCEs had significantly improved the sensitivity of the fabricated biosensor, and the LODs for the detection of *E. coli* O157:H7 were achieved at  $6 \times 10^2$  cfu/ml in PBS and  $5 \times 10^3$  cfu/ml in milk. Because the biological recognition events in this type of electrochemical biosensor are converted to electric signals through the labels, different labels can be employed to achieve simultaneous detection of multiple bacteria. Viswanathan and others (2012) reported an electrochemical immunosensor to simultaneously detect three pathogens, *E. coli* O157:H7, *Salmonella*, and

*Campylobacter*. They fabricated the biosensor based on the immobilization of a mixture of anti-*E. coli*, anti-*Salmonella*, and anti-*Campylobacter* Abs functionalized multiwall carbon nanotube-polyallylamine (MWCNT-PAH) onto the surface of screen-printed electrodes (SPEs). After the target bacteria were captured, specific nanocrystals conjugated respective Abs (Ab-*E. coli*-CdS, Ab-*Salmonella*-CuS, and Ab-*Campylobacter*-PbS) were used to label the three bacteria and released different metal ions for the electrochemical measurement. The constructed immunosensor showed LODs of three selected bacteria at  $0.8 \times 10^3$  cfu/ml,  $0.4 \times 10^3$  cfu/ml, and  $0.4 \times 10^3$  cfu/ml, respectively. Metallic nanoparticles are also used as powerful labels for the fabrication of electrochemical biosensors. A most recent amperometric biosensor was developed for the detection of *E. coli* O157:H7 in minced beef and water using electrocatalytic gold nanoparticle tags (Hassan *et al.*, 2015). The way for fabricating this biosensor was to use a magnetosandwich assay between the Ab-conjugated magnetic beads, the target heat-killed *E. coli* O157:H7, and second Ab-conjugated AuNPs. The AuNP tags catalyzed hydrogen evolution reaction which was used for quantitation of the target bacteria. The LODs of 148, 457, and 309 cfu/ml were achieved in buffer, minced beef, and tap water samples, respectively, within approximately 1 h.

The advantage of using label-dependent strategy is that the labels usually provide effective amplification of the electrical signals because the labels can offer an efficient and specific electron transfer pathway with a high electron transfer rate. Therefore, this strategy can yield lower LODs and improve the specificity of the electrochemical biosensors. Moreover, the conversion of the biological recognition events in these biosensors depends on the labels. The formation of the target-label interaction can happen anywhere, in the solution or on the electrode surface, which allows to improve the efficiency of capturing target bacteria in the complex food

matrices by using distinguish carriers such as magnetic beads to directly separate the bacterial cells. On the other hand, the disadvantages of this type of electrochemical biosensors also come from the labelling procedures which prolong the detection time as well as add more complexity in the operation.

### 3.4.2 Label-free electrochemical biosensors

The second type of strategy employed by the electrochemical biosensors is the label-free direct detection of the target bacteria based on the immobilization of bioreceptors on the surface of the electrodes (Fig. 3.5). It is reported the membranes of natural bacteria cells (with a thickness of 5 to 10 nm) showed a capacitance of 0.5 to 1.3  $\mu\text{F}/\text{cm}^2$  and a resistance of  $10^2$  to  $10^5$   $\Omega \text{ cm}^2$  (Wang *et al.*, 2012). Therefore, the attachment of the bacterial cells can directly induce the change in the electrical parameters. Maalouf *et al.* (2007) developed an electrochemical

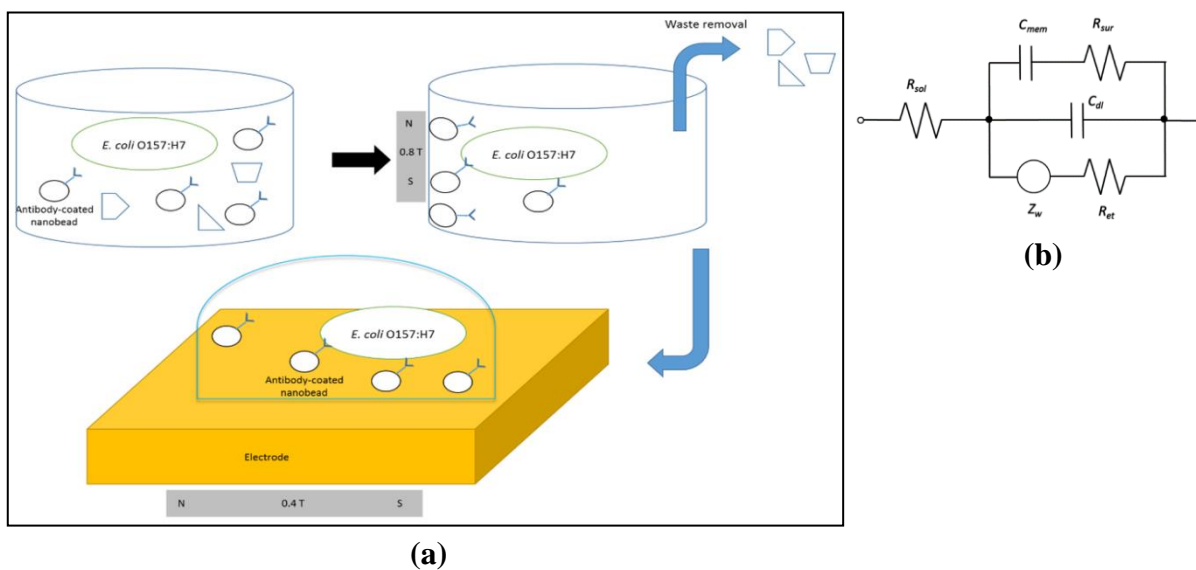

Figure 3.5. (a) A label-free impedimetric biosensor for the detection of *E. coli* O157:H7. The bioreceptors were absorbed to the surface of a SP-IDME by a permanent magnet. Upon the capture of the bacterial cells, the pathway for the electron transfer at the electrode surface was blocked, and thus the impedance was increased. (b) The equivalent circuit of the developed electrochemical impedance biosensor was shown. It is important for the data analysis in EIS to obtain electrical parameters like charge transfer resistance ( $R_{ct}$ ) (Wang *et al.*, 2015).

impedance biosensor for the detection of *E. coli* based on a mixed self-assembled monolayer of thiol-neutravidin on the gold electrode. It achieved the LODs of 10 cfu/ml for the whole bacterial cell and  $10^3$  cfu/ml for the lysed *E. coli*, which were much lower comparing to  $10^7$  cfu/ml when using SPR method with the same electrode modification and antibodies. Interdigitated array microelectrodes (IDAM) were also used to develop impedance biosensor for the detection of *E. coli* O157:H7 in ground beef (Varshney & Li, 2007(a)). The Abs-conjugated magnetic nanoparticles were used in this method to separate the target bacteria from the food matrix, and attracted and concentrated the bacteria with a magnet to the active layer of the IDAM. The LODs of this biosensor for the detection of *E. coli* O157:H7 were  $7.4 \times 10^4$  cfu/ml and  $8.0 \times 10^5$  cfu/ml in pure culture and in ground beef, respectively, with the detection time of 35 min. A quartz crystal Au electrode-based impedimetric immunosensor was developed for the detection of *E. coli* O157:H7 (Li *et al.*, 2008). This immunosensor used a simple facile modification of the quartz crystal Au electrodes with protein A, followed by the functionalization using anti-*E. coli* Abs. The relatively large surface of the quartz crystal Au electrodes used in this study allowed more bacterial cells captured thus increased the impedance change. This label-free immunosensor showed the LOD for *E. coli* O157:H7 at  $10^3$  cfu/ml and with the detection time of less than 10 min. Another potentiometric biosensor was studied for the detection of *E. coli* CECT 675 as a surrogate for the pathogenic *E. coli* O157:H7 in a direct and simple label-free manner (Zelada-Guillen *et al.*, 2010). This biosensor used aptamers covalently immobilized on the single-walled carbon nanotubes (SWCNTs) which were deposited on the glassy carbon electrode (GCE). After a filtration pre-treatment step to separate the target bacteria from the interfering food matrix, this method could detect as low as 6 cfu/ml in milk or 26 cfu/ml in apple juice.



The immobilization strategy has been identified as the most important procedure for label-free biosensors. Many kinds of the novel materials or techniques have been studied to improve the sensitivity, stability, regenerability, and reproducibility of biosensors employing label-free strategy. A capacitive immunosensor was developed based on the label-free strategy for the detection of *E. coli* O157:H7 (Li *et al.*, 2011). This immunosensor was fabricated using SAMs of 3-mercaptopropionic acid (MPA) to immobilize the anti-*E. coli* Abs onto a quartz crystal Au electrode. The change in capacitance from the attachment of the bacteria was measured and analyzed using EIS. The constructed capacitive immunosensor could discriminate *E. coli* O157:H7 as low as  $10^2$  cfu/ml in PBS,  $10^3$  cfu/ml,  $10^3$  cfu/ml, and  $10^4$  cfu/ml in milk, spinach, and ground beef, respectively. An amperometric immunosensor based on the formation of an ordered, oriented, compact, and stable SAM of alkanethiol 11-amino-1-undecanethiol hydrochloride (AUT) was developed for the detection of *E. coli* O157:H7 (Li *et al.*, 2012). The monolayer of AUT with rich amine functional groups allowed attachment of massive AuNPs. Then the active surface of the gold electrode with AUT/AuNPs was further enhanced by multilayer films comprised of chitosan-multiwalled carbon nanotubes-SiO<sub>2</sub>/thionine (CHIT-MWCNTs-SiO<sub>2</sub>@THI) nanocomposites and AuNPs. The layer-by-layer assembly not only improved the stability of the immobilization on the electrode surface, but also increased the sensitivity of the biosensor due to the rich quantity of THI mediator immobilized on the electrode. This label-free amperometric immunosensor was able to detect heat killed *E. coli* O157:H7 as low as 250 cfu/ml within less than 45 min. This MWCNTs-based method was also used to fabricate a label-free impedance immunosensor to detect *S. Typhimurium* (Dong *et al.*, 2013). In this study, the surface of GCEs was modified with AuNPs and poly(amidoamine)-MWCNTs-chitosan (AuNPs/PAMAM-MWCNTs-Chi/GCE) for the immobilization of anti-

*Salmonella* Abs. The LOD of the impedance immunosensor was  $5.0 \times 10^2$  cfu/ml in the pure cultural samples with the detection time of 1 h. The graphene, owing to its unique structure of single-atom-thick planar sheet of carbon atoms, has extraordinary electrical properties and was used to develop a label-free immunosensor to detect *E. coli* (Huang *et al.*, 2011). The graphene film used to fabricate the conductometric biosensor was grown on the quartz substrate by chemical vapor deposition and functionalized with anti-*E. coli* Abs. The change in conductance was distinguishable from the blank samples after exposure to the target bacteria at 10 cfu/ml for 30 min. Another impedimetric aptasensor was developed based on the modification of graphene oxide (GO) and AuNPs on the surface of GCEs with thiolated aptamers immobilized on AuNPs (Ma *et al.*, 2014). This aptasensor was highly specific to detect *S. Typhimurium*, and benefitting from the high electron transfer properties of GO and AuNPs it achieved LOD at 3 cfu/ml in pure cultural samples within about 1.5 h.

Recent years, label-free impedimetric biosensors for the detection of *E. coli* O157:H7 have been intensively studied. A nanoporous membrane was applied to construct an impedimetric immunosensor for the label-free detection of *E. coli* O157:H7 in milk (Joung *et al.*, 2013). This method modified an alumina nanoporous membrane by using hyaluronic acid (HA) to reduce the non-specific binding and allow the successful immobilization of Abs on the nanoporous membrane. The ionic impedance of the electrolytes flowing through the membrane was monitored by EIS and increased due to the blockage from bacteria attachment on the nanoporous membrane. The LOD was found to be 10 cfu/ml in buffer and approximately 84 cfu/ml in whole milk. There was a highly sensitive impedimetric biosensor developed for the detection of *E. coli* O157:H7 (dos Santos *et al.*, 2013). To fabricate this biosensor, the gold electrode surface was first immobilized with SAM of 16-mercaptohexadecanoic acid (MHDA), and then the free end

of MHDA was chemically attached with carboxyl groups to allow further functionalization by Abs. The density of the Abs attached on the surface of electrodes was estimated to be  $476 \pm 16$  ng/cm<sup>2</sup>. The LOD of this biosensor was achieved at 2 cfu/ml. Another label-free impedimetric immunosensor was developed for the detection of *E. coli* O157:H7 based on a free-standing reduced graphene oxide paper (rGOP) which was surface modified with AuNPs for further functionalization with Abs (Wang *et al.*, 2013). After incubation with the target bacteria for 30 min, the impedance was positively related to the increase of the concentration of the bacteria, and the LODs of this immunosensor was  $1.5 \times 10^2$  cfu/ml in redox buffer, and  $1.5 \times 10^3$  cfu/ml and  $1.5 \times 10^4$  cfu/ml in spiked pre-treated cucumber and ground beef rinsing solutions, respectively. The graphene modified SPEs which have more effectiveness on the electron transfer and increased active area were used to construct a disposable impedimetric biosensor to determine the presence of *E. coli* O157:H7 (Wang *et al.*, 2014). The biosensor was fabricated using electrochemically reduced graphene oxide to form the graphene film on the surface of the SPEs, and followed by electrochemical deposition of AuNPs for further simple and efficient physical adsorption of Abs. The change in charge transfer resistance was positively related to the concentration of the target bacteria, and the LOD of this developed impedimetric biosensor was  $1.5 \times 10^3$  cfu/ml with the detection time of 30 min. The most recent development of an indium tin oxide (ITO) based label-free impedimetric biosensor claimed to be able to detect *E. coli* O157:H7 at a very low LOD of 1 cfu/ml (dos Santos *et al.*, 2015). The biosensor was fabricated based on a robust surface functionalization using silane monolayers on the ITO substrate and followed by Abs immobilization. The binding efficiency of the Abs was increased by 30% which allowed for more favorable capture of the target bacteria. This method could be a very powerful platform for the detection of foodborne pathogens.

The advantages of using label-free strategy to construct electrochemical biosensors are obvious. The nature of label-free strategy allows the constructed sensors to have a straightforward and simple detection process with relatively less time consumed. The direct detection of the target bacteria also allows the integration of the label-free electrochemical biosensors into one test chip. On the other hand, the disadvantages of label-free strategy for foodborne pathogens detection are apparent as well. First, the elimination of additional labels makes the label-free electrochemical biosensors lack of additional signal amplification. As stated previously, the electric properties of individual cell are at very small values. Therefore, in order to reach a detectable electrochemical signal, it requires either enough number of bacterial cells captured (higher LOD), or to use complicated immobilization methods to enhance the detector's capability of sensing the small signal. Second, the incubation of the target bacteria with the bioreceptor-immobilized electrodes has also restricted the label-free biosensors to reach lower detection limit. When using the label-free biosensors, the target bacteria are captured upon the contact with the bioreceptors on the surface of electrodes. However, it only depends on the mobility of the bacteria because the common operation for incubation process is to put the liquid sample on the active area of the electrode and let it keep stationary without any mixing. Therefore, there is high possibility that some of the bacteria cannot be captured and induce changes to the electrochemical measurement. Last but not least, to fabricate an effective label-free electrochemical biosensor, the immobilization of mediators or conductive or semi-conductive materials onto the surface of electrodes is extremely important. Considering the complex process most of the immobilization methods employed, the cost of making these biosensors is increased and the possibility of mass producing these sensors is reduced. Furthermore, the immobilization procedures involved in the fabrication of the label-free

electrochemical biosensors usually include the rough cleanness steps and the biochemical attachment of compacted functional molecules on the surface of electrodes. The cleanness of the electrodes may include physical abrasion using alumina powder, chemical corrosion using either strong acid such as hydrochloride acid or basic such as sodium hydroxide. All these cleanness procedures could have damaging effect to the surface of the electrodes, especially delicate ones like interdigitated array microelectrodes. And the chemical immobilization steps include covalent or non-covalent binding of functional groups such amine or carboxyl for the further adsorption of Abs, mediators, conductive or semi-conductive materials. Such strong bonds between the functional groups and the electrode provides necessary stability and high efficiency on electron transfer, whereas it usually causes difficulties for the regeneration and reuse of the electrodes. All of above advantages and disadvantages have made the electrochemical biosensors using label-free strategies become very appealing yet demanding for further improvement.

### **3.5 Recent trends in the development of electrochemical biosensors for *E. coli* O157:H7 and *S. Typhimurium***

Significant efforts have been focused on the detection of *E. coli* O157:H7 and *S. Typhimurium* in research because their important role as the sanitary indicator and the zero-tolerance policy regarding its presence in foods (FDA, 2013; USDA-FSIS, 2015). The development of biosensors for whole bacterial cells is challenging due to the much larger size of the analyte than regular biochemical molecules, and also the surface of the bacterial cells are comprised of various epitopes that allow nonspecific interactions with the impurities or the sensor surface. An ideal biosensor should include at least some key properties as follows (Table 3.3). Depending on the site of interests (at home, at clinics, in a lab, at the production line, wastewater site, *etc.*), the configuration can be varied, but the core demanding for the biosensor

should be almost the same (Ahmed *et al.*, 2014). Recent years, with various advanced techniques and materials being applied in the development of biosensors, the detection systems, which offered increased sensitivity and specificity as well as the integration of miniaturized and automated instrumentations, have directed toward the implementation of a portable platform for rapid detection of foodborne pathogens.

Table 3.3. The desired properties of an ideal biosensor for detection of foodborne pathogens.

Properties	Value or quality
Sensitivity	Less than $10^3$ cfu/ml
Specificity	Can identify specific target strain from other serotypes in the same or different species ( <i>e.g.</i> , can distinguish <i>E. coli</i> O157:H7 from other <i>E. coli</i> or <i>Salmonella</i> ).  Minimum background noise (minimum unspecific binding from the food matrices).
Detection time	5-10 min for single test
Size	Portable, compact instrumentation can fit into a suitcase
Consistency	The test can be performed at different conditions at the site of interest, and test results have no significant difference from those done at laboratory.
Stability	The biorecognition elements or biochemical labels should be stable for months under normal condition for easy preservation.
Sample processing	Minimal sample pre-treatment, simple test procedures (better to be label-free).
Operator requirement	No special training needed to use the assay, can be used by individuals at home.

### 3.5.1 Applications of nanotechnology in electrochemical biosensors for improvements of sensing performance

The most convenient biological detection methods are taking advantage of selective recognition between receptor-ligand interactions. The construction of biosensors generally use this same strategy. The nanomaterials can offer much more improvements in sensitivity,

specificity, and speed compared to other biochemical methods based on the microscale materials, because the nanomaterials can possess unique electrical properties, high surface-to-volume ratio, and easily functionalized surfaces.

One serious problem in the fabrication of electrochemical biosensors for detection of *E. coli* O157:H7, *S. Typhimurium*, or other pathogens is to deal with the various interferences in the complex food matrices. Even though there are techniques like filtration or centrifugation being used to isolate the bacteria of interest from the food samples, the most often and efficient isolation method right now is the well-known immunomagnetic separation (IMS). In IMS, magnetic particles are applied as the carriers with corresponding Abs and a magnet is used to separate the captured target bacterial cells from the food matrix prior to detection. The nanoscale magnetic particles are extremely useful due to their high surface-to-volume ratio which facilitates the high capture efficiency of large microbial analyte. The captured analyte can later be subjected to concentration and measurement. There was one study reported the capture of *E. coli* O157:H7 in ground beef using streptavidin-coated immunomagnetic beads (IMBs) (Varshney *et al.*, 2005). The study pointed out that under the optimal parameters the capture efficiency showed at least 94% of *E. coli* O157:H7 in the range of  $1.6 \times 10^1$  to  $7.23 \times 10^7$  cfu/ml captured with an immuno-incubation time of 15 min without any enrichment, and no significant interference from other non-target bacterial species. Similar results were also observed for *Salmonella* detection using IMBs (Brandão *et al.*, 2013).

The recognition elements of biosensors are considered expensive and vulnerable if they are biologically produced. For instance, for antibody or cell based biosensors, the antibodies or the engineered cells are normally produced in tissue culture or animals, which can be costly and also time-consuming to develop them with high specificity. Furthermore, for such biological elements,

they are also fragile to environment and required special preservation such as refrigeration. Therefore, there has been great interest in the development of artificial or synthetic recognition elements to replace those from biological hosts. The molecularly imprinted nanomaterials are one of the most interesting direction in the design of synthetic bioreceptors (Irshad *et al.*, 2013). The imprinting process first involves the arrangement of polymerizable monomers with template-specific binding sites to surround the templates or imprint molecules, and then proceeds to polymerization of monomers with a cross-linker. After the extraction of the templates after polymerization, the result 3-D polymers should have imprinted cavities inside that can selectively bind to the template molecules. A broad categories of imprinted nanomaterials have already been developed, including imprinted nanoparticles (Poma *et al.*, 2013), imprinted nanocomposites (Matsui *et al.*, 2009), and imprinted hybrid materials (Lakshmi *et al.*, 2009). The molecularly imprinting technique is mostly applied to detect chemicals or small molecules, but there have been a few studies targeting whole bacteria cells (Dickert & Hayden, 2002; Findeisen *et al.*, 2012; Tokonami *et al.*, 2013; Yilmaz *et al.*, 2015). The achieved LODs for the target bacteria were in the range of  $10^3$  to  $10^4$  cfu/ml.

The transducer in a biosensor plays a very essential role in the detection process. There have been a broad spectrum of transduction methods employed for the detection of foodborne pathogens over the past decade. Even though new techniques constantly being developed in transducers for better performance of biosensors, the transduction mechanisms can be divided into two categories as stated in section 3.4, the label-dependent and the label-free ones, which have different requirements for the high efficient transducers. Currently, the nanofabrication techniques can shred the size of a sensing probe to the level where the bacterial cells are at, improving the sensitivity and lowering the LOD enormously.



As the label-free methods for the fabrication of electrochemical biosensors, nanomaterials are particularly helpful on the immobilization of bioaffinity agents. The early-stage biosensors usually immobilized enzymes or antibodies through the reaction with cross-linkers such as glutaraldehyde and blocked the free surface by blocking agents such as bovine serum albumin (BSA). This type of immobilization methods commonly result in random distribution of the bioreceptors which utilize only proportion of the active area of electrodes and also caused denaturation of the enzymes or antibodies (Warriner *et al.*, 2014). Nanoparticles have provided means to overcome such problems by allowing high loading capacity with controlled orientation of bioreceptors attachment. The most widely applied example of using nanoparticles to facilitate the bioaffinity reagents immobilization is with gold nanoparticles which can be easily amended by thiol bonds. Relatively simple chemical synthesis of gold nanoparticles on various surfaces makes it suitable for surface immobilization and functionalization to construct biosensors. Moreover, the high conductivity of gold nanoparticles can improve the electron transfer rate to the electrode surface and hence increase the sensitivity of the assay (Majdalawieh *et al.*, 2014).

When the polymers are used to form nanoscale spherical or granular nanoparticles, they exhibit excellent properties such as good biocompatibility and functionality which are very suitable for candidates as carriers to enhance the probe loading. There was a poly (styrene-co-acrylic acid) microspheres with diameter of 338 nm prepared by Pinijsuwan *et al.* (2008). The latex spheres were modified with layer-by-layer assembly of avidin-labeled AuNPs which showed two orders of magnitude increase in the amount of Au atoms delivered per nanocomposite microsphere. This as-synthesized nanocomposite was immobilized on an electrode surface and capture *E. coli* by using *E. coli* specific DNA probes via DNA

hybridization. A single DNA hybridization signal could be translated into hundreds of AuNPs release by using this strategy.

For label-dependent methods, metallic nanoparticles and conductive polymers are emerging as powerful platforms for signal amplification due to their excellent conductivity. One study done by Muhammad-Tahir and Alocilja (2003) used antibody conjugated conductive polyaniline to label the target *E. coli* O157:H7. The construction of the conductometric biosensor was based on a lateral flow system that lead the liquid sample to move from the application pad to conjugation pad and then to the capture pad. On the capture pad, the polyaniline-labeled bacterial cells were captured by primary antibodies immobilized between two electrodes. The amount of labelling polyaniline existed in the solution changed the conductance, and the LOD of this biosensor was achieved at 79 cfu/ml with a detection process of 10 min. As for the detection of *S. Typhimurium*, Freitas *et al.* (2014) reported an electrochemical immunosensor using iron oxide/gold core/shell (Fe@Au) nanomagnetic and CdS nanocrystal labels to amplify the signals. In this study, CdS nanocrystals-Abs conjugates and Fe@Au-Abs conjugates were sequentially mixed with *S. Typhimurium* samples. The resulted complex was measured using square-wave anodic stripping voltammetry (SWASV). This immunosensor could detect as low as 13 cfu/ml of *S. Typhimurium* in pure cultural samples.

### **3.5.2 Lab-on-a-chip techniques in the miniaturization of electrochemical biosensors for the detection of *E. coli* O157:H7 and *S. Typhimurium***

As one of the desired properties, the portability of an electrochemical biosensors is of great importance to realize in-field detection of foodborne pathogens. Even though the definition of a “portable” electrochemical biosensor can vary, an ideal portable device should be a single unit that is possibly operated with one hand, weighted less than one kilogram, battery-supported, and

integrated with its own microprocessor, display screen and control system. Recently, the concept of lab-on-a-chip has been suggested as an appropriate solution to construct portable and real-time electrochemical biosensors for detection of foodborne pathogens (Yoon & Kim, 2012). Lab-on-a-chip refers to a device that combines multiple laboratory functions into one small chip with dimensions at millimeters or centimeters level. This is also known as the microfluidic devices that fabricate a network of channels and wells etched onto glass, silicon, or polymer chips, or utilize the latest 3-D printing technique to directly print out the chips (Au *et al.*, 2015). Such microfluidic devices can precisely control the small volume of fluid samples through pressure or electrokinetic forces and enable the integration of laboratory procedures like mixing, diluting, staining, and detection operated in a manner of automation. Lab-on-a-chip technique brings electrochemical biosensors with advantages such as easy-to-use, miniaturization, small volume of samples consumption, standard and mass production, and automation.

Electrochemical lab-on-a-chip biosensors have been successfully fabricated for detection of *E. coli* O157:H7 and *S. Typhimurium* in different food samples. Varshney *et al.* (2007(b)) developed an electrochemical impedance microfluidic biosensor that the detection chamber was fabricated by integrating an interdigitated array microelectrode into a poly(dimethylsiloxane) (PDMS) microchannel. The detection chamber was 6 mm × 0.5 mm × 0.02 mm that could handle 60 nl of samples. *E. coli* O157:H7 spiked on ground beef was separated and concentrated by using antibody-conjugated magnetic nanoparticles and then injected into the microfluidic flow cell for impedance measurement. This label-free impedance microfluidic biosensor achieved the detection limit of  $1.2 \times 10^3$  cfu/ml in ground beef with the detection time of 35 min. Latest development of microfluidic device integrated with nanoporous membranes demonstrated the simultaneous detection of *E. coli* O157:H7 and *Staphylococcus aureus* from the mixed samples

(Tian *et al.*, 2016). Two separated testing chambers with same sample inject channel but different measurement chambers were fabricated with two layers of polymeric polyethylene glycol (PEG) with nanoporous membranes assembled in between. Then the membranes were functionalized with anti-*E. coli* O157:H7 and anti-*S. aureus* antibodies, respectively. Upon the binding of target pathogens on the corresponding nanoporous membranes, the electrolytes were blocked from passing through some of the nanopores which increased the magnitude of impedance signal. The LODs of this microfluidic nanopore-based impedance biosensor achieved  $10^2$  cfu/ml for both pathogens in the mixed samples.

### **3.5.3 Techniques to fabricate low-cost electrochemical biosensors**

Screen-printing technique is one of the most promising methods to produce flexibly designed, inexpensive, and reproducible electrodes that can find various applications in the fabrication of disposable and portable electrochemical biosensors (Taleat *et al.*, 2014). This technology is based on the layer-by-layer of desired ink deposited onto a solid substrate using a screen or mesh. The most common ink materials are silver and carbon, others like gold and platinum can also be used but with higher cost. Based on the experimental requirements, different ink formulations, the types of inks, the size of the design, the loading of ink materials, and the printing or curing conditions can strongly affect the sensitivity or selectivity and overall analytical performance of the fabricated biosensors (Wang *et al.*, 1998; Fanjul-Bolado *et al.*, 2008). Furthermore, there have been an extensive spectrum of modification methods to immobilize different substances like metals, enzymes, polymers, electrochemical mediators, or complex mixtures onto the SPEs that can offer diverse and suitable properties for the applications.

Immunosensors based on SPEs are especially attractive for point-of-care or on-site monitoring because the SPEs can allow the miniaturization of sensors, low cost, and to be

disposable. There have been several studies developed SPE-based electrochemical immunosensors. Self-assembling technique was used by Escamilla-Gomez *et al.* (2009) to compare two immobilization configurations on the gold SPEs (AuSPEs) for the construction of a label-free electrochemical impedance immunosensor for *E. coli* detection. The first one used homobifunctional cross-linker to immobilize the anti-*E. coli* antibodies, and the other one was based on the thiol-gold interaction to immobilize the thiolated antibodies onto the surface of AuSPEs. The electrochemical impedance spectroscopy was used in the presence of a redox probe. The immunosensor based on the thiolated antibodies achieved much better performance with a LOD of 10 cfu/ml in *E. coli* spiked river and tap water samples and an assay time of 1 h. Another lectin-based label-free impedance immunosensor using AuSPEs was reported for the detection of microorganisms (Gamella *et al.*, 2009). The AuSPEs were successively incubated with biotinylated ConA and *E. coli* in solution. The selective interaction of ConA with the carbohydrate components on the surface of the bacterial cells allowed the formation of AuSPE-ConA-*E. coli* complex which was monitored by EIS. The LOD was achieved at  $5.0 \times 10^3$  cfu/ml with an assay time of 1 h. SPCEs were also popular for the fabrication of disposable electrochemical biosensors to detect *S. Typhimurium* (Afonso *et al.*, 2013; Freitas *et al.*, 2014)

### **3.6 Conclusions**

As the first type of biosensors developed more than fifty years ago, electrochemical biosensors have been proved to be the most promising method to fabricate portable devices for rapid and on-site detection of foodborne pathogens. Based on some of the recent scientific literatures on different types of electrochemical biosensors for the detection of *E. coli* O157:H7 and *S. Typhimurium*, comparing to the conventional methods and other biosensor counterparts, electrochemical biosensors have demonstrated advantages such as less restrictions from the

sample turbidity, possible miniaturization, low cost, possible integration system, and mass production. But there are also limitations of electrochemical biosensors used as detection methods. First, the low LOD is still the primary pursuit in the development of electrochemical biosensors to detect foodborne pathogens in real samples. Common expectation of LODs achieved by these biosensors is less than 100 cfu/ml. As shown in Table 3.2, there are only a few reports achieved close to or less than this criteria. The solution to this problem of sensitivity most likely lies in the development of novel materials, especially nano-scale materials. The nanomaterials can provide more cost-effective signal transduction, efficient support for biorecognition elements, and the possibility of multiplex simultaneous detection of several pathogens.

The specificity of the electrochemical biosensors for detection of foodborne pathogens is another critical issue. To achieve similar specificity to the culture-based methods, electrochemical biosensors still have a long way to go. Currently, the label-dependent electrochemical methods generally showed better specificity than that of label-free ones. Because the label-dependent methods rely on the double specific recognition elements (primary antibodies and second antibody-conjugated labels) to capture and label the target bacterial cells. The label-free methods solely depend on the recognition of primary antibodies so that the interference from non-targets like other bacteria and chemicals is problematic. Therefore, the selection of more specific bioreceptors is one of the aspects that caught more attention. Some innovative biorecognition elements such as aptamers, bacteriophages, and molecularly imprinted polymers are the new trend that can help in developing high affinity, better selectivity, and more stable electrochemical biosensors for foodborne pathogen detection.

Nowadays, electrochemical biosensors for food safety are still penetrating the market very slowly due to the complicated task to design desirable biosensors with characteristics described in Table 3.3. In the near future, foodborne pathogen detection using electrochemical biosensors will be no-doubt to benefit from advanced techniques mentioned in section 3.4. The electrochemical biosensors will become sensitive and selective, and be integrated into micro- or nano-devices that are easy-to-use, low cost, stable, and suitable for detection of various foodborne pathogens. The research presented in this dissertation have provided a new idea of designing an electrochemical biosensor that combines the characteristics of label-based and label-free types to make the developed method closer to the desired device for in-field or on-site detection of foodborne pathogens.

### 3.7 References

- Afonso, A. S., B. Pérez-López, R. C. Faria, L. H. C. Mattoso, M. Hernández-Herrero, A. X. Roig-Sagués, M. M. Costa, and A. Merkoçi. 2013. Electrochemical detection of *Salmonella* using gold nanoparticles. *Biosens. Bioelectron.* 40: 121-126.
- Ahmed, A., J. V. Rushworth, N. A. Hirst, and P. A. Millner. 2014. Biosensors for whole-cell bacterial detection. *Clin. Microbiol. Rev.* 27(3): 631-646.
- Arora, P., A. Sindhu, H. Kaur, N. Dilbaghi, and A. Chaudhury. 2013. An overview of transducers as platform for the rapid detection of foodborne pathogens. *Appl. Microbiol. Biotechnol.* 97: 1829-1840.
- Au, A. K., N. Bhattacharjee, L. F. Horowitz, T. C. Chang, and A. Folch. 2015. 3D-printed microfluidic automation. *Lab Chip* 15: 1934-1941.
- Bard, A. J., and L. R. Faulkner. 2001. *Electrochemical methods: Fundamentals and applications*. 2<sup>nd</sup> ed. Hoboken, NJ: John Wiley & Sons, Inc.
- Bell, R. L., K. G. Jarvis, A. R. Ottesen, M. A. McFarland, and E. W. Brown. 2016. Recent and emergin innovations in *Salmonella* detection: a food and environmental perspective. *Microbial Biotechnol.* 9: 279-292.
- Bergveld, P. 2003. Thirty years of ISFETOLOGY: What happened in the past 30 years and what may happen in the next 30 years. *Sens. Actu. B* 88: 1-20.

- Betts, R., and C. W. Blackburn. 2009. Detecting pathogens in food. *Foodborne pathogens: hazards, risk analysis and control*. 2<sup>nd</sup> ed. 17-65. C. W. Blackburn, C. de W. Blackburn, P. McClure, and P. J. McClure. Oxford, UK: CRC Press.
- Brandão, D., S. Liébana, S. Campoy, P. Cortés, S. Alegret, and M. I. Pividori. 2013. Electrochemical magneto-immunosensing of *Salmonella* based on nano and micro-sized magnetic particles. *J. Phys.: Conf. Series* 421(012020): 1–7.
- CDC, Centers for Disease Control and Prevention. 2011. CDC 2011 estimates: Findings. Available at: <http://www.cdc.gov/foodborneburden/2011-foodborne-estimates.html>. Accessed on June 2016.
- CDC, Centers for Disease Control and Prevention. 2013(a). Multistate Outbreak of Human *Salmonella* Typhimurium Infections Linked to Live Poultry in Backyard Flocks. Available at: <http://www.cdc.gov/salmonella/typhimurium-live-poultry-04-13/index.html>. Accessed on June 2016.
- CDC, Centers for Disease Control and Prevention. 2013(b). Multistate Outbreak of *Salmonella* Typhimurium Infections Linked to Ground Beef. Available at: <http://www.cdc.gov/salmonella/typhimurium-01-13/index.html>. Accessed on June 2016.
- CDC, Centers for Disease Control and Prevention. 2014. Multistate Outbreak of Shiga toxin-producing *Escherichia coli* O157:H7 Infections Linked to Ground Beef. Available at: <http://www.cdc.gov/ecoli/2014/o157h7-05-14/index.html>. Accessed on June 2016.
- CDC, Centers for Disease Control and Prevention. 2016. Reports of selected *E. coli* outbreak investigations. Available at: <http://www.cdc.gov/ecoli/outbreaks.html>. Accessed on June 2016.
- Clark, L. C., and C. Lyons. 1962. Electrode systems for continuous monitoring in cardiovascular surgery. *Ann. N. Y. Acad. Sci.* 102: 29-45.
- Deisingh, A. K., and M. Thompson. 2004. Strategies for the detection of *Escherichia coli* O157:H7 in foods. *J. Appl. Microbiol.* 96: 419-429.
- D’Haese, and E., H. J. Nelis. 2002. Rapid detection of single cell bacteria as a novel approach in food microbiology. *J. AOAC Int.* 85(4): 979-983.
- Dickert, F. L., and O. Hayden. 2002. Bioimprinting of polymers and Sol-gel phase. Selective detection of yeasts with imprinted polymers. *Anal. Chem.* 74: 1302–1306.
- Dong, J., H. Zhao, M. Xu, Q. Ma, and S. Ai. 2013. A label-free electrochemical impedance immunosensor based on AuNPs/PAMAM-MWCNT-Chi nanocomposite modified glassy carbon electrode for detection of *Salmonella* Typhimurium in milk. *Food Chem.* 141: 1980-1986.
- Ercole, C., M. D. Gallo, M. Pantalone, S. Santucci, L. Mosiello, C. Laconi, and A. Lepidi. 2002. A biosensor for *Escherichia coli* based on a potentiometric alternating biosensing (PAB) transducer. *Sens. Actu. B* 83: 48-52.



- Escamillar-Gomez, V., S. Campuzano, M. Pedrero, and J. M. Pingarron. 2009. Gold screen-printed-based impedimetric immunobiosensors for direct and sensitive *Escherichia coli* quantisation. *Biosens. Bioelectron.* 24: 3365-3371.
- Fanjul-Bolado, P., D. Hernandez-Santos, P. J. Lamas-Ardisana, A. Martin-Pernia, and A. Costa-Garcia. 2008. Electrochemical characterization of screen-printed and conventional carbon paste electrodes. *Electrochim. Acta* 53: 3635-3642.
- FDA, Food and Drug Administration. 2013. Chapter 4 Enumeration of *Escherichia coli* and the coliform bacteria. *Bacteriological Analytical Manual (BAM)*. Available at: <http://www.fda.gov/Food/FoodScienceResearch/LaboratoryMethods/ucm2006949.htm>. Accessed on June 2016.
- Findeisen, A., J. Wackerlig, R. Samardzic, J. Pitkanen, O. Anttalainen, F. L. Dickert, and P. A. Lieberzeit. 2012. Artificial receptor layers for detecting chemical and biological agent mimics. *Sens. Actu. B* 170: 196-200.
- Freitas, M., S. Viswanathan, H. P. A. Nouws, M. B. P. P. Oliveira, and C. Delerue-Matos. 2014. Iron oxide/gold core/shell nanomagnetic probes and CdS biolabels for amplified electrochemical immunosensing of *Salmonella* Typhimurium. *Biosens. Bioelectron.* 51: 195-200.
- Fung, D. 2006. Rapid detection of microbial contaminants. 565-594. *Microbiology of fruits and vegetables*. 1<sup>st</sup> ed. G. Sapers, J. Gorny, and A. Youssef, eds. Boca Raton: CRC Press.
- Gamella, M., S. Campuzano, C. Parrado, A. J. Reviejo, and J. M. Pingarron. 2009. Microorganisms recognition and quantification by lectin adsorptive affinity impedance. *Talanta* 78: 1303-1309.
- Gehring, A. G., and S.-I. Tu. 2005. Enzyme-linked immunomagnetic electrochemical detection of live *Escherichia coli* O157:H7 in apple juice. *J. Food Prot.* 68(1): 146-149.
- Grabowska, I., K. Malecka, U. Jarocka, J. Radecki, and H. Radecka. 2014. Electrochemical biosensors for detection of avian influenza virus – current states and future trends. *Acta Biochimica Polonica* 61(3): 471-478.
- Grieshaber, D., R. MacKenzie, J. Vörös, and E. Reimhult. 2008. Electrochemical biosensors- Sensor principles and architectures. *Sens.* 8: 1400-1458.
- Hassan, A.-R. H. A.-A., A. de la Escosura-Muñiz, A. Merkoçi. 2015. Highly sensitive and rapid determination of *Escherichia coli* O157:H7 in minced beef and water using electrocatalytic gold nanoparticle tags. *Biosens. Bioelectron.* 67: 511-515.
- Hu, Y., Q. Zhang, and J. C. Meitzler. 1999. Rapid and sensitive detection of *Escherichia coli* O157:H7 in bovine faeces by a multiplex PCR. *J. Appl. Microbiol.* 87: 867-876.
- Huang, Y., X. Dong, Y. Liu, L.-J. Li, and P. Chen. 2011. Graphene-based biosensors for detection of bacteria and their metabolic activities. *J. Mater. Chem.* 21: 12358-12362.

- Hunter, D. M., and D. V. Lim. 2010. Rapid detection and identification of bacterial pathogens by using an ATP bioluminescence immunoassay. *J. Food Prot.* 73(4): 739-746.
- Irshad, M., N. Iqbal, A. Mujahid, A. Afzal, T. Hussain, A. Sharif, E. Ahmad, and M. M. Athar. Molecularly imprinted nanomaterials for sensor applications. *Nanomater.* 3: 615-637.
- ISO, International Organization for Standardization. 2016. Standards catalog. Available at: [http://www.iso.org/iso/home/store/catalogue\\_ics/catalogue\\_ics\\_browse.htm?ICS1=07&ICS2=100&ICS3=30&published=on](http://www.iso.org/iso/home/store/catalogue_ics/catalogue_ics_browse.htm?ICS1=07&ICS2=100&ICS3=30&published=on). Accessed on June 2016.
- Ivnitski, D., I. Abdel-Hamid, P. Atanasov, E. Wilkins, and S. Stricker. 2000. Application of electrochemical biosensors for detection of food pathogenic bacteria. *Electroanal.* 12: 317-325.
- Joung, C.-K., H.-N. Kim, M.-C. Lim, T.-J. Jeon, H.-Y. Kim, and Y. R. Kim. 2013. A nanoporous membrane-based impedimetric immunosensor for label-free detection of pathogenic bacteria in whole milk. *Biosens. Bioelectron.* 44: 210-215.
- Kumar, R., P. K. Surendran, and N. Thampuran. 2008. Evaluation of culture, ELISA, and PCR assays for the detection of *Salmonella* in seafood. *Lett. Appl. Microbiol.* 46: 221-226.
- Lakshmi, D., A. Bossi, M. J. Whitcombe, I. Chianella, S. A. Fowler, S. Subrahmanyam, E. V. Piletska, and S. A. Piletsky. 2009. Electrochemical sensor for catechol and dopamine based on a catalytic molecularly imprinted polymer-conducting polymer hybrid recognition element. *Anal. Chem.* 81: 3576-3584.
- Law, J. W.-F., N.-S. A. Mutalib, K.-G. Chan, and L.-H. Lee. 2015. Rapid methods for the detection of foodborne bacterial pathogens: Principles, applications, advantages and limitations. *Front. Microbiol.* 5(770): 1-19.
- Lazcka, O., F. J. D. Campo, and F. X. Munoz. 2007. Pathogen detection: A perspective of traditional methods and biosensors. *Biosens. Bioelectron.* 22: 1205-1217.
- Li, D., K. Xu, J. Wang, Z. Ye, Y. Ying, and Y. Li. 2008. Quartz crystal Au electrode-based electrochemical immunosensor for rapid detection of *Escherichia coli* O157:H7. *Trans. ASABE* 51(5): 1847-1852.
- Li, D., Y. Feng, L. Zhou, Z. Ye, J. Wang, Y. Ying, C. Ruan, R. Wang, and Y. Li. 2011. Label-free capacitive immunosensor based on quartz crystal Au electrode for rapid and sensitive detection of *Escherichia coli* O157:H7. *Anal. Chim. Acta* 687: 89-96.
- Li, Y., P. Cheng, J. Gong, L. Fang, J. Deng, W. Liang, and J. Zheng. 2012. Amperometric immunosensor for the detection of *Escherichia coli* O157:H7 in food specimens. *Anal. Biochem.* 421: 227-233.
- Liébana, S., A. Lermo, S. Campoy, M. P. Cortés, S. Alegret, and M. I. Pividori. 2009. Rapid detection of *Salmonella* in milk by electrochemical magneto-immunosensing. *Biosens. Bioelectron.* 25: 510-513.

- Lin, Y.-H., S.-H. Chen, Y.-C. Chuang, Y.-C. Lu, T. Y. Shen, C. A. Chang, and C.-S. Lin. 2008. Disposable amperometric immunosensing strips fabricated by Au nanoparticles-modified screen-printed carbon electrodes for the detection of foodborne pathogen *Escherichia coli* O157:H7. *Biosens. Bioelectron.* 23: 1832-1837.
- Logan, J., K. Edwards, and N. Saunders. 2009. *Real-time PCR: Current technology and applications*. London, UK: Caister Academic Press.
- Ma, X., Y. Jiang, F. Jia, Y. Yu, J. Chen, and Z. Wang. 2014. An aptamer-based electrochemical biosensor for the detection of *Salmonella*. *J. Microbiol. Methods* 98: 94-98.
- Maalouf, R., C. Fournier-Wirth, J. Coste, H. Chebib, Y. Saikali, O. Vittori, A. Errachid, J.-P. Cloarec, C. Martelet, and N. Jaffrezic-Renault. 2007. Label-free detection of bacteria by electrochemical impedance spectroscopy: comparison to surface plasmon resonance. *Anal. Chem.* 79: 4879-4886.
- Majdalawieh, A., M. C. Kanan, O. El-Kadri, and S. M. Kanan. Recent advances in gold and silver nanoparticles: synthesis and applications. *J. Nanosci. Nanotechnol.* 14: 4757-4780.
- Mandal, P. K., A. K. Biswas, K. Choi, and U. K. Pal. 2011. Methods for rapid detection of foodborne pathogens: An overview. *Am. J. Food Technol.* 6(2): 87-102.
- Mantzila, A. G., V. Malpa, and M. I. Prodromidis. 2008. Development of a faradic impedimetric immunosensor for the detection of *Salmonella* Typhimurium in milk. *Anal. Chem.* 80: 1169-1175.
- Matsui, J., M. Takayose, K. Akamatsu, H. Nawafune, K. Tamaki, and N. Suigimoto. 2009. Molecularly imprinted nanocomposites for highly sensitive SPR detection of a non-aqueous atrazine sample. *Analyst* 134: 80-86.
- Melo, A. M. A., D. L. Alexandre, R. F. Furtado, M. F. Borges, E. A. T. Figueiredo, A. Biswas, H. N. Cheng, and C. R. Alves. 2016. Electrochemical immunosensors for *Salmonella* detection in food. *Appl. Microbiol. Biotechnol.* 100: 5301-5312.
- Muhammad-Tahir, Z., and E. C. Alocilja. 2003. A conductometric biosensor for biosecurity. *Biosens. Bioelectron.* 18: 813-819.
- Newton, C. R., and A. Graham. 1997. *PCR*. 2<sup>nd</sup> ed. Oxford, UK: Bios Scientific Publishers.
- Palchetti, I., and M. Mascini. 2008. Electroanalytical biosensors and their potential for food pathogen and toxin detection. *Anal. Bioanal. Chem.* 391: 455-471.
- Park, S. H., M. Aydin, A. Khatiwara, M. C. Dolan, D. F. Gilmore, J. L. Bouldin, S. Ahn, and S. C. Ricke. 2014. Current and emerging technologies for rapid detection and characterization of *Salmonella* in poultry and poultry products. *Food Microbiol.* 38: 250-262.

- Pinijsuwan, S., P. Rijiravanich, M. Somasundrum, and S. Werasak. 2008. Sub-femtomolar electrochemical detection of DNA hybridization based on latex/gold nanoparticle-assisted signal amplification. *Anal. Chem.* 80: 6779-6784.
- Poma, A., A. Guerreiro, M. J. Whitcombe, E. V. Piletska, A. P. F. Turner, and S. A. Piletsky. 2013. Solid-phase synthesis of molecularly imprinted polymeric nanoparticles (MIP NPs) with a reusable template-“Plastic antibodies”. *Adv. Funct. Mater.* 23: 2821-2827.
- Pournaras, A. V., T. Koraki, and M. I. Prodromidis. 2008. Development of an impedimetric immunosensor based on electropolymerized polytyramine films for the direct detection of *Salmonella* Typhimurium in pure cultures of type strains and inoculated real samples. *Anal. Chim. Acta* 624: 301-307.
- Radu, S., G. Rusul, O. W. Ling, E. Purwati, M. Mustakim, and S. Lihan. 2000. Rapid isolation and detection of *Escherichia coli* O157:H7 by use of Rainbow Agar O157 and PCR Assay. *South East Asian J. Tropical Med. Public Health.* 31: 77-79.
- Reverté, L., B. Prieto-Simón, and M. Campàs. 2016. New advances in electrochemical biosensors for the detection of toxins: Nanomaterials, magnetic beads and microfluidics systems. A review. *Analytic Chimica Acta* 908: 8-21.
- Riley, L. W., R. S. Remis, S. D. Helgerson, H. B. McGee, J. G. Wells, and B. R. Davis. 1983. Hemorrhagic colitis associated with a rare *Escherichia coli* serotype. *N. Engl. J. Med.* 308: 681-685.
- Santos, M. B. dos, J. P. Aguil, B. Prieto-Simon, C. Sporer, V. Teixeira, and J. Samitier. 2013. Highly sensitive detection of pathogen *Escherichia coli* O157:H7 by electrochemical impedance spectroscopy. *Biosens. Bioelectron.* 45: 174-180.
- Santos, M. B. dos, S. Azevedo, J. P. Aguil, B. Prieto-Simon, C. Sporer, E. Torrents, A. Juarez, T. Teixeira, and J. Samitier. 2015. Label-free ITO-based immunosensor for the detection of very low concentrations of pathogenic bacteria. *Bioelectrochem.*, 101: 146-152.
- Sang, S., Y. Wang, Q. Feng, Y. Wei, J. Ji, and W. Zhang. 2016. Progress of new label-free techniques for biosensors: A review. *Crit. Rev. Biotechnol.* 36(3): 465-481.
- Scallan, E., R. M. Hoekstra, F. J. Angulo, R. V. Tauxe, M.-A. Widdowson, S. L. Roy, J. L. Jones, and P. M. Griffin. 2011. Foodborne illness acquired in the United States- Major Pathogens. *Emerg. Infect. Dis.* 17(1): 7-15.
- Scharff, R. L. 2012. Economic burden from health losses due to foodborne illness in the United States. *J. Food Prot.* 75(1): 123-131.
- Sharma, H., and R. Mutharasan. 2013. Review of biosensors for foodborne pathogens and toxins. *Sens. Actu. B* 183: 535-549.

- Taleat, Z., A. Khoshroo, and M. Mazloum-Ardakani. 2014. Screen-printed electrodes for biosensing: A review. *Microchim. Acta* 181: 865-891.
- Tian, F., J. Lyu, J. Shi, F. Tan, and M. Yang. 2016. A polymeric microfluidic device integrated with nanoporous alumina membranes for simultaneous detection of multiple foodborne pathogens. *Sens. Actu. B* 225: 312-318.
- Tokonami, S., Y. Nakadoi, M. Takahashi, M. Ikemizu, T. Kadoma, K. Saimatsu, L. Q. Dung, H. Shiigi, and T. Nagaoka. 2013. Label-free and selective bacteria detection using a film with transferred bacterial configuration. *Anal. Chem.* 85: 4925–4929.
- Tu, S., J. Uknalis, P. Irwin, and L. Yu. 2000. The use of streptavidin coated magnetic beads for detecting pathogenic bacteria by light addressable potentiometric sensor (LAPS). *J. Rapid Methods Autom. Microbiol.* 8: 95–109.
- Turner, A. P. F. 2013. Biosensors: sense and sensibility. *Chem. Soc. Rev.* 42: 3184-3196.
- USDA-FSIS, United States Department of Agriculture- Food Safety and Inspection Service. 2015. Chapter 5. Detection, isolation and identification of *Escherichia coli* O157:H7 from meat products and carcass and environmental sponges. *USDA-FSIS Microbiology Laboratory Guidebook*. Available at: <http://www.fsis.usda.gov/wps/portal/fsis/topics/science/laboratories-and-procedures/guidebooks-and-methods/microbiology-laboratory-guidebook/microbiology-laboratory-guidebook>. Accessed on June 2016.
- Varshney, M., L. Yang, X. Su, and Y. Li. 2005. Magnetic nanoparticle-antibody conjugates for the separation of *Escherichia coli* O157:H7 in ground beef. *J. Food Prot.* 68(9): 1804-1811.
- Varshney, M., and Y. Li. 2007(a). Interdigitated array microelectrode based impedance biosensor coupled with magnetic nanoparticle-antibody conjugates for detection of *Escherichia coli* O157:H7 in food samples. *Biosens. Bioelectron.* 22: 2408-2414.
- Varshney, M., Y. Li, B. Srinivasan, and S. Tung. 2007(b). A label-free, microfluidics and interdigitated array microelectrode-based impedance biosensor in combination with nanoparticles immunoseparation for detection of *Escherichia coli* O157:H7 in food samples. *Sens. Actu. B* 128: 99-107.
- Velusamy, V., K. Arshak, O. Korostynska, K. Oliwa, and C. Adley. 2009. An overview of foodborne pathogen detection: In the perspective of biosensors. *Biotechnol. Adv.* 28: 232-254.
- Vigneshvar, S. C. C. Sudhakumari, B. Senthilkumaran, and H. Prakash. 2016. Recent advances in biosensor technology for potential applications – An overview. *Front. Bioeng. Biotechnol.* 4(11): 1-9.
- Viswanathan, S., C. Rani, and J. A. Ho. 2012. Electrochemical immunosensor for multiplexed detection of foodborne pathogens using nanocrystal bioconjugates and MWCNT screen-printed electrode. *Talanta* 94: 315-319.

- Wang, J., B. Tian, B. Nascimento, and L. Angnes. 1998. Performance of screen-printed carbon electrodes fabricated from different carbon inks. *Electrochim. Acta* 43: 3459-3465.
- Wang, R., J. Lum, Z. Callaway, J. Lin, W. Bottje, and Y. Li. 2015. A label-free impedance immunosensor using screen-printed interdigitated electrodes and magnetic nanobeads for the detection of *E. coli* O157:H7. *Biosens.* 5: 791-803.
- Wang, Y., and J. K. Salazar. 2016. Culture-independent rapid detection methods for bacterial pathogens and toxins in food matrices. *Comprehensive Rev. Food Sci. Food Safety* 15(1): 183-205.
- Wang, Y., J. Ping, Z. Ye, J. Wu, and Y. Ying. 2013(a). Impedimetric immunosensor based on gold nanoparticles modified graphene paper for label-free detection of *Escherichia coli* O157:H7. *Biosens. Bioelectron.* 49: 492-498.
- Wang, Y., Z. Ye, C. Si, and Y. Ying. 2014. Development of a disposable impedance biosensor and its application for determination of *Escherichia coli* O157:H7. *Trans. ASABE* 57(2): 585-591.
- Wang, Y., Z. Ye, and Y. Ying. 2012. New trends in impedimetric biosensors for the detection of foodborne pathogenic bacteria. *Sens.* 12: 3449-3471.
- Warriner, K., S. M. Reddy, A. Namvar, and S. Neethirajan. 2014. Developments in nanoparticles for use in biosensors to assess food safety and quality. *Trends Food Sci. Technol.* 40(2): 183-199.
- Yang, G.-J., J.-L. Huang, W.-J. Meng, M. Shen, and X.-A. Jiao. 2009. A reusable capacitive immunosensor for detection of *Salmonella* spp. Based on grafted ethylene diamine and self-assembled gold nanoparticle monolayers. *Anal. Chim. Acta* 647: 159-166.
- Yeni, F., Acar, S., Polat, O. G., Soyer, Y., Alpas, H. 2014. Rapid and standardized methods for detection of foodborne pathogens and mycotoxins on fresh produce. *Food Control* 40: 359-367.
- Yilmaz, E., D. Majidi, E. Ozgur, and A. Denizli. 2015. Whole cell imprinting based *Escherichia coli* sensors: A study for SPR and QCM. *Sens. Actu. B* 209: 714-721.
- Yoon, J.-Y., and B. Kim. 2012. Lab-on-a-chip pathogen sensors for food safety. *Sens.* 12: 10713-10741.
- Zelada-Guillen, G. A., S. V. Bhosale, J. Riu, and F. X. Rius. 2010. Real-time potentiometric detection of bacteria in complex samples. *Anal. Chem.* 82: 9254-9260.
- Zhao, X., C.-W. Lin, J. Wang, and D. H. Oh. 2014. Advances in rapid detection methods for foodborne pathogens. *J. Microbiol. Biotechnol.* 24(3): 297-312.
- Zhu, D., Y. Yan, P. Lei, B. Shen, W. Cheng, H. Ju, and S. Ding. 2014. A novel electrochemical sensing strategy for rapid and ultrasensitive detection of *Salmonella* by rolling circle amplification and DNA-AuNPs probe. *Anal. Chim. Acta* 846: 44-50.

## **Chapter 4. Rapid detection of *Escherichia coli* O157:H7 and *Salmonella* Typhimurium in foods using an electrochemical immunosensor based on screen-printed interdigitated microelectrode and immunomagnetic separation**

### **4.1 Abstract**

Foodborne pathogens have continuously been a serious food safety issue and there is a growing demand for a rapid and sensitive method to screen the pathogens for on-line or in-field applications. Therefore, an impedimetric immunosensor based on the use of magnetic beads (MBs) for separation and a screen-printed interdigitated microelectrode (SP-IDME) for measurement was studied for the rapid detection of *Escherichia coli* O157:H7 and *Salmonella* Typhimurium in foods. Streptavidin coated MBs were functionalized with corresponding biotinylated antibodies (Abs) to capture the target bacteria. The glucose oxidase (GOx)-Ab conjugates were employed to label the MBs-Ab-cell complexes. The yielded MBs-Ab-cell-Ab-GOx biomass was mixed with the glucose solution to trigger an enzymatic reaction which produced gluconic acid. This increased the ion strength of the solution, thus decreasing the impedance of the solution measured on the SP-IDME. Our results showed that the immunosensor was capable of specifically detecting *E. coli* O157:H7 and *S. Typhimurium* within the range of  $10^2$  to  $10^6$  cfu/ml in the pure culture samples. *E. coli* O157:H7 in ground beef and *S. Typhimurium* in chicken rinse water were also examined. The limits of detection (LODs) for the two bacteria in foods were  $2.05 \times 10^3$  cfu/g and  $1.04 \times 10^3$  cfu/ml, respectively. This immunosensor required only a bare electrode to measure the impedance changes, and no surficial modification on the electrode was needed. It was low-cost, reproducible, easy-to-operate, and easy-to-preserve. All these merits demonstrated this immunosensor has great potential for the rapid and on-site detection of pathogenic bacteria in foods.

## 4.2 Introduction

Over decades, the illnesses caused by foodborne pathogenic bacteria have had an enormous impact on public health and the economy (Scharff, 2012). In the United States, the Centers for Disease Control and Prevention (CDC) (2014) has estimated that 31 types of known foodborne pathogens cause around 9.4 million illnesses, 56,000 hospitalizations and 1,300 deaths annually. Among these 31 well-known pathogens, *E. coli* O157 and *Salmonella* are two major types that have been studied the most as models to understand the bacterial behavior. Latest outbreaks of *E. coli* O157:H7 in ground beef and *S. Typhimurium* in poultry have caused serious impact on the health of the public and the economy of food companies (CDC, 2013; CDC, 2014). As the presence of foodborne pathogens is a major concern for the food industry, the detection of these pathogens has become utmost important. Conventional methods such as culturing and colony counting, polymerase chain reaction (PCR) and enzyme-linked immunosorbent assay (ELISA) are still the most common methods applied in the field of pathogen detection (Lazcka *et al.*, 2007). In despite of their good selectivity and reliability, these conventional methods have disadvantages. For instance, the culturing and colony counting method is usually time-consuming and laborious due to multiple steps of enrichment and growth of the bacteria (Yang & Bashir, 2008). ELISA in 96-well microtiter plates is restricted by its relatively high LODs (normally  $10^3$  to  $10^5$  cfu/ml). In order to achieve low LODs, the ELISA method requires certain enrichment procedures that take 16 to 24 h, and is considered a long and labor-intensive analysis (de Boer & Beumer, 1999; Roda *et al.*, 2012). PCR-based methods, considered as rapid detection methods, can achieve detection results from 30 min to a few hours. However, the development of PCR-based rapid methods is still hindered by the requirement of enrichment, high cost, and the need for trained technicians (Lazcka *et al.*, 2007).



The impedimetric biosensing technique, one branch of electrochemical methods, has proven to be very promising in the development of rapid methods for the detection of foodborne pathogens, especially for on-site detection. This technique applies a sinusoidal electrical signal with very low voltage in a set range of frequencies on an electrochemical cell (Barsoukov & Macdonald, 2005). The capture of bacterial cells onto the surface of the electrodes or fluctuations of ion strength in medium induced by the addition of chemical constituents would change the conductance and the capacitance of the medium thereby changing its impedance (Ivnitski *et al.*, 2000). The predominant strategy for an impedimetric biosensor is the immobilization of bioreceptors (e.g., antibodies) onto the surface of the electrode. This strategy bypasses the labeling procedure that is normally required by other electrochemical biosensors, and greatly shortens the detection time. The charge transfer resistance increases when target bacteria are directly bound to the surface of the electrode (Mantzila & Maipa, 2008; Radke & Alocilja, 2005; Yang *et al.*, 2004). However, despite the advantages brought by its label-free nature, the major drawbacks of impedimetric biosensors using the immobilization strategy include: (1) the immobilization procedures are complicated and time-consuming, (2) the consistency of the fabricated biosensors is greatly affected by the surface condition of the electrode and the unspecific absorption of compounds in biological samples, and (3) it is very difficult to reproduce and regenerate the electrode (Santos *et al.*, 2009). All of these disadvantages have restricted the development and application of impedimetric biosensors using the immobilization strategy in the field of food safety and inspection. Therefore, an immobilization-free detection method that can sensitively detect the pathogenic bacteria in foods would be very promising for the application of biosensing in the food industry.

In this study, an immobilization-free electrochemical impedance immunosensor was developed for the detection of pathogenic bacteria, *E. coli* O157:H7 and *S. Typhimurium*, in foods. The SP-IDME for measurement in this immunosensor was only used for the detection of *E. coli* O157:H7 (Li *et al.*, 2015) and avian influenza (Fu *et al.*, 2014) previously in our lab. However, the first study was done using self-assembled monolayers (SAMs) of 3-dithiobis-(sulfosuccinimidylpropionate) (DTSP) to modify the surface of the SP-IDME, whereas the latter one targeted viruses using bare SP-IDME for measurement. Considering to the low-cost and reusability showed with the bare SP-IDME, the applications of this electrode in the detection of pathogenic bacteria are worth to explore. GOx, due to its high turnover number, high specificity, and good stability (pH 2 to 8), has been chosen as the labeling enzyme (Wilson & Turner, 1992). For the fabrication of the immunosensor, the magnetic beads (MBs) (130 nm) coated with streptavidin were first functionalized with the appropriate biotinylated Abs. *E. coli* O157:H7 or *S. Typhimurium* was then captured by the MBs-Ab conjugates. Once the target bacteria were captured, corresponding Ab-GOx conjugates were used to label the bacteria by forming MBs-Ab-cell-Ab-GOx sandwich biomass. The final biomass was transferred to the glucose solution with low ion strength. Through the enzymatic reaction, the ion strength of the aqueous samples increased whereas the impedance of the samples decreased. The impedance spectra were obtained using electrochemical impedance spectroscopy. The immunosensor was able to detect the target bacteria at  $10^2$  cfu/ml and differentiate them from non-target bacteria in the pure cultural samples. This study demonstrated that the proposed method using a bare SP-IDME could achieve similar sensitivity to those methods using immobilization strategies. Furthermore, this method is easy-to-operate and the electrode can be regenerated multiple times for long-term use. It is very suitable for the demand of on-site detection of pathogenic bacteria in foods.

### 4.3 Materials and methods

#### 4.3.1 Biochemical materials

Stock phosphate buffered saline (PBS, 0.1 M, pH 7.4), glucose, glucose oxidase, and bovine serum albumin (BSA) were bought from Sigma-Aldrich (St. Louis, MI). Stock PBS solution was diluted at a ratio of 1:10 to prepare 1× PBS (10 mM, pH 7.4), and used throughout all tests. 1% BSA solution (wt/vol) was prepared in PBS as a blocking buffer. The ultrapure deionized water (18.2 MΩ·cm) was obtained from Millipore (Milli-Q, Bedford, MA). 10 mM glucose solution was made by dissolving glucose into deionized water. Streptavidin-coated magnetic beads (MBs) with a diameter of 130 nm were manufactured by Kisker Biotech GmbH&Co. KG (Steinfurt, Germany). Based on the information provided by the company, the MBs were prepared by precipitation of iron oxide (Fe<sub>3</sub>O<sub>4</sub>) in the presence of dextran, and contained 10 mg/ml solid content (Fe) with  $2.9 \times 10^{11}$  particles/mg. The surface of MBs was covalently (carbodiimide method) modified with 1.5 μg/mg particles (approximately 60-70 molecules streptavidin per particle). SEM and TEM images were taken to confirm the size of MBs, and multiple binding of

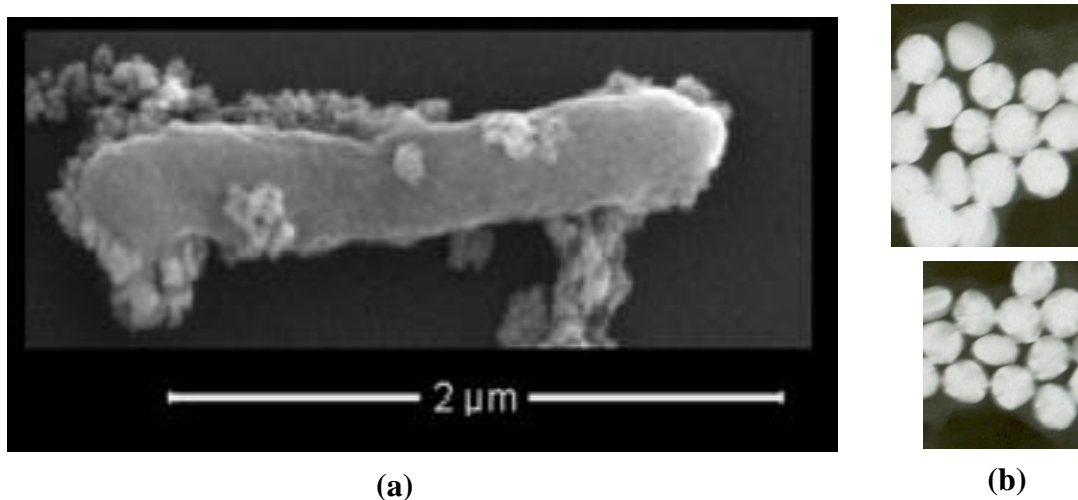

Figure 4.1. SEM image (a) of single bacterial cell bound with multiple magnetic beads (*E. coli* O157:H7) and TEM images (b) of only magnetic beads ( $\times 100k$  amplification).

MBs to bacterial cells (Fig. 4.1).

Biotinylated rabbit anti-*E. coli* O+K antibodies (4.0-5.0 mg/ml) were purchased from Biodesign International (Saco, ME). Monoclonal anti-*S. Typhimurium* antibodies (4.0-5.0 mg/ml) were purchased from Meridian Life Science Inc. (Memphis, TN). The anti-*S. Typhimurium* antibodies were biotinylated based on the protocol reported by Kanayeva *et al.* (2012) using sulfo-NHS-biotin, and excessive biotin was removed with a Slide-A-Lyzer dialysis kit from Pierce Protein Research Product (10K MWCO, Rockford, IL). 1:5 dilutions of both antibodies (0.8-1.0 mg/ml) were prepared with PBS and stored at 4 °C for further use, and storage time was no more than one month.

Stock bacterial cultures of *E. coli* O157:H7 (ATCC 43888), *E. coli* K12 (ATCC 29425), *S. Typhimurium* (ATCC 14028), *Listeria monocytogenes* (ATCC 43251), and *Staphylococcus aureus* (ATCC 27660) were obtained from American Type Culture Collection (ATCC, Manassas, VA). The stock cultures were stored at -80 °C, and revived slowly at room temperature when needed.

#### **4.3.2 Apparatus**

The impedance analysis was conducted with a bench-top IM-6 Impedance Analyzer manufactured by BAS-ZAHNER (West Lafayette, IN) with the software IM-6/THALES. For all impedance measurements, a sinusoidal AC module with amplitude of 5 mV was applied across the IDME, and the magnitude and the phase angle of the impedance were measured in the frequency range from 10 Hz to 1 MHz. The SP-IDME was designed by our group and fabricated by Aibit Tech. (Jiangyin, China). The configuration of the SP-IDME and the electric connection are shown in Fig. 4.2.

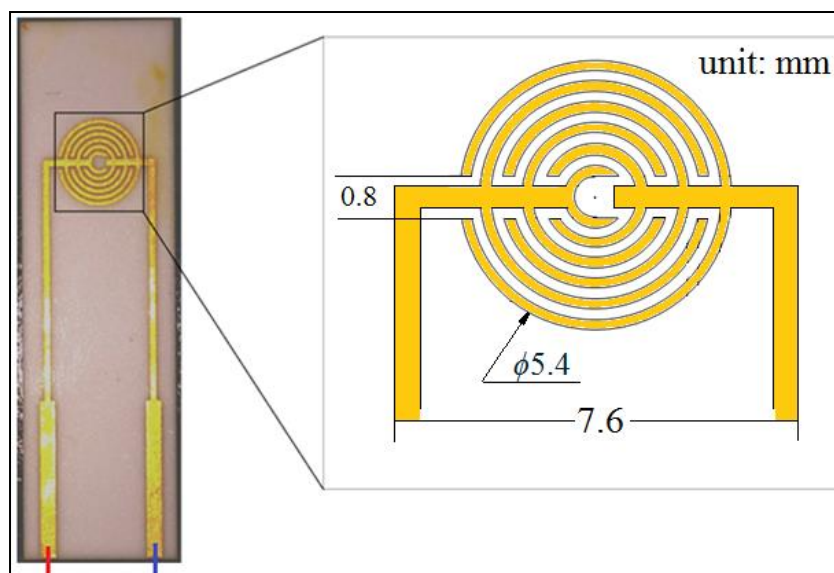

Figure 4.2. Configuration of the screen-printed interdigitated microelectrode.

The bare electrode is constructed with six pairs of gold fingers arranged in a pattern of interdigitated concentric circle. The gold fingers are 200  $\mu\text{m}$  in width with 200  $\mu\text{m}$  spacing between each two fingers. The area of the gold fingers is about 12.38  $\text{mm}^2$ , and the ratio of the area of the gold fingers to the whole circular electrode is about 0.54:1. The magnetic separator with a magnetic strength of approximately 1.0 Tesla (T) was purchased from R&D Systems Inc. (Minneapolis, MN).

#### 4.3.3 Culture preparation and media plating methods

For preparing the test culture, the stock cultures were grown in brain heart infusion (BHI) broth (Remel Microbiology Products, Lenexa, KS) at 37  $^{\circ}\text{C}$  for 18-20 h. A series of 10-fold dilutions of each bacterial culture were made with PBS. To determine the viable cell numbers of *E. coli* O157:H7 and *S. Typhimurium*, 100  $\mu\text{l}$  of each dilution were spread plated onto the surface of either non-selective Trypsin Soy Agar (TSA), or respective selective Sorbitol MacConkey (SMAC) and Xylose-Lysine-Tergitol 4 (XLT4) agars when testing the food samples. After incubating the plates at 37  $^{\circ}\text{C}$  for 18 to 24 h, the number of bacterial colonies formed was

counted and the concentrations of viable bacteria cells were determined in the terms of colony forming units per milliliter (cfu/ml). All the sample cultures were prepared on the day of tests.

#### **4.3.4 Food sample preparation and inoculation**

The detection of *E. coli* O157:H7 in ground beef and *S. Typhimurium* in chicken carcass rinse water were examined. Both food products were freshly purchased from a local grocery store, and transported to the lab within 15 min. For the detection of *E. coli* O157:H7, 25 g of ground beef was weighted and transferred into a filtering stomacher bag. Then one ml of the bacteria dilution with controlled concentration (PBS as negative control (NC)) was inoculated into the ground beef, and incubated at 37 °C for one hour. After that, 225 ml of sterile PBS solution was added to the stomacher bag, and mixed using a stomacher machine (Stomacher 400, Seward, UK) at 200 rpm for two min. 10 ml of ground beef rinse water was transferred into new tubes for further tests. For the detection of *S. Typhimurium*, the poultry products were prepared using the method suggested by the U.S. Department of Agriculture Food Safety and Inspection Service (USDA, 1998). Briefly, the whole chicken carcass (about 4.5 kg) was aseptically transferred into a large stomacher bag. 400 ml of 0.1% buffered peptone water (BPW) was poured into the stomacher bag. Then the chicken carcass was washed using a repeated rocking motion to invert the bird for one min. Two samples containing 30 ml of the rinse water were collected from one bird to be used for the detection of *S. Typhimurium* at one concentration point. One sample was inoculated with controlled concentration of *S. Typhimurium* as the test subject, and the other one was inoculated with PBS as the NC. The plate counting method was used right after liquid food samples were ready to determine the concentration of the bacteria in ground beef or chicken carcass rinse water. All liquid samples right after preparation were

directly used in the electrochemical impedance analysis for the detection of *E. coli* O157:H7 and *S. Typhimurium*.

#### **4.3.5 Preparation of immuno-functionalized magnetic beads**

The streptavidin-coated MBs were functionalized first by being bound with respective biotinylated Abs through streptavidin-biotin coupling. Specifically, 10  $\mu$ l of MBs were suspended into 200  $\mu$ l of PBS in 1.5 ml protein low binding tubes (SARSTEDT AG & Co., Germany) and magnetically separated with the magnetic separator for three min. The supernatant was removed with a pipette carefully (magnetic separation procedures were the same below unless specifically mentioned). After dispersed into 190  $\mu$ l of PBS, 10  $\mu$ l of biotin-Ab were added and rotated at 15 rpm and room temperature (RT) for 45 min. After the rotation finished, the yielded samples were magnetically separated and re-dispersed into 200  $\mu$ l of 5% BSA. The mixture was rotated for 45 min, and then magnetically separated. After washing with 200  $\mu$ l of PBS and being magnetically separated again, the MBs were ready for bacteria capture. The MBs-Ab conjugates were prepared right before use.

#### **4.3.6 Preparation of Ab-GOx conjugates**

The GOx was conjugated with Abs using a Glucose Oxidase Conjugation Kit obtained from Abcam (Cambridge, MA). The detailed protocol for GOx conjugation was given in the manufacture manual (Abcam, 2013). The obtained Ab-GOx conjugates were stored at 4°C when not in use. The same protocol was applied to the corresponding Ab for the detection of *E. coli* O157:H7 and *S. Typhimurium*.

#### **4.3.7 Electrochemical impedance analysis for detection of *E. coli* O157:H7**

The complete scheme for the EIS is shown in Fig. 4.3. The MBs were magnetically separated after blocking, and 200  $\mu$ l of the samples (pure culture, ground beef rinse water, or chicken

carcass rinse water) containing target bacteria at different concentrations (PBS as NC) were mixed well with the MBs-Abs conjugates. The mixture was rotated with a rotator at a speed of 15 rpm at RT for 45 min. The bacterial cells were captured by the MBs through the antibody-antigen binding mechanism. After the capture, the MBs-Abs-cell complexes were washed with PBS twice and magnetically separated. Then MBs-Abs-cell complexes were re-suspended in 190  $\mu\text{l}$  of PBS. After that, 10  $\mu\text{l}$  of corresponding Ab-GOx conjugates were mixed into the samples on a rotator at a speed of 15 rpm at RT for 30 min. In this step, “sandwich” complexes with the configuration of MBs-Abs-cell-Ab-GOx were formed. After the “sandwich” complexes were magnetically separated, three steps of washing were performed to remove the extra ions that possibly existed in the sample. In the first washing step, the sample complexes were re-suspended into 400  $\mu\text{l}$  of deionized water, and then magnetically separated. In the second washing step, the sample complexes were suspended into 400  $\mu\text{l}$  of deionized water again, and then transferred to new low binding tubes before being magnetically separated. In the last washing step, the sample complexes were mixed with 100  $\mu\text{l}$  of deionized water, and then magnetically separated. After washing, the sample complexes were quickly suspended into 100  $\mu\text{l}$  of 10 mM glucose solution, and 50  $\mu\text{l}$  of the solution were immediately placed on the electrode for measurement. The impedance spectra of the samples were recorded. The reaction time was set to 30 min based on the optimization to ensure the enzymatic reaction was enzyme-limited. After 30 min reaction in air, the impedance spectra of 50  $\mu\text{l}$  of the samples were recorded again. The impedance changes were calculated using the value at 1.062 kHz of the frequency.



The specificity of the SP-IDME-based immunosensor was investigated by testing other non-target bacteria, such as *E. coli* K12, *L. monocytogenes*, and *S. aureus*. The concentration of the target and the non-target bacteria tested was at  $10^5$  cfu/ml level.

#### 4.3.8 Statistical analysis

The means  $\pm$  standard deviations of quadruplicates were calculated using Excel 2010 software (Microsoft, Redmond, WA). The statistical differences were determined with single-factor analysis of variance (one-way ANOVA) using Excel 2010 software. The significance level was set at a P value of  $<0.05$ .

### 4.4 Results and discussion

#### 4.4.1 Equivalent circuit model for the interpretation of the electrochemical measurement of the developed immunosensor

Fig. 4.4 (a) shows one example of the experimental data and fitted curve of the magnitude and phase angle of the impedance measurement using the developed immunosensor to detect the

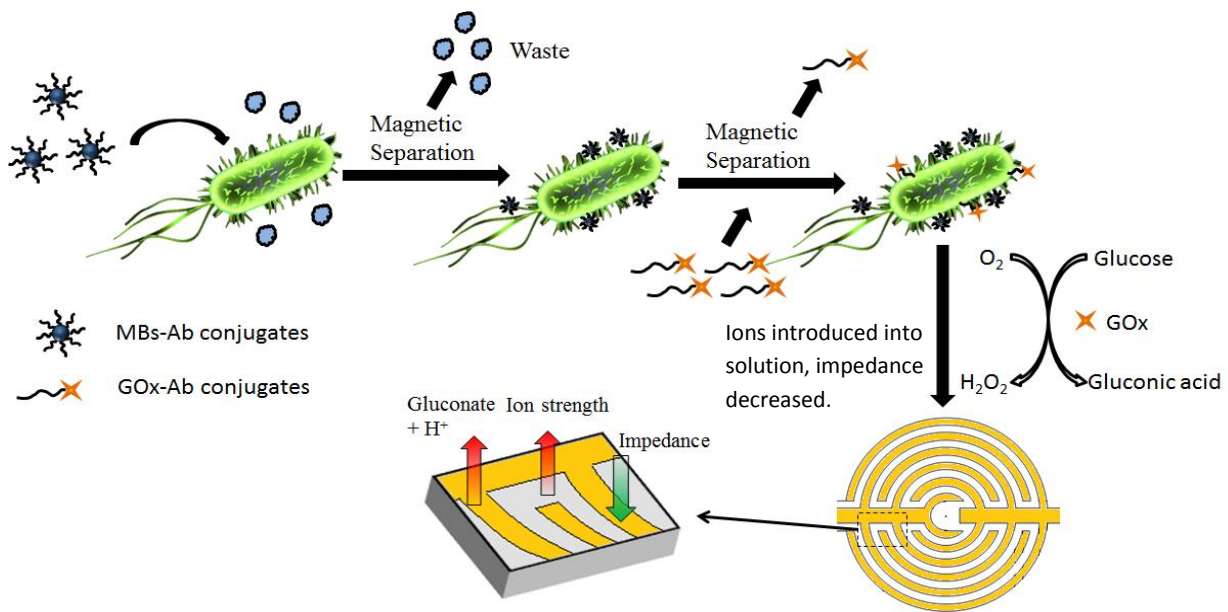

Figure 4.3. Illustration of the mechanism and construction of the immunosensor.

bacteria at  $10^5$  cfu/ml. The model fitting was performed using a complex nonlinear least-squares algorithm. The mean errors of the magnitude and phase angle of the impedance measurement were 0.2% and  $0.2^\circ$ , respectively. The largest errors of the magnitude and phase angle of the impedance measurement were 3.0% and  $3.6^\circ$ , respectively. Fig. 4.4 (b) shows the equivalent circuit generated by IM-6/THALES software, which represents the electrochemical system established in the immunosensor. From the figure,  $Z_w$  represents the interfacial diffusion impedance, also known as the Warburg impedance,  $C_{dl}$  represents the double layer capacitance generated by the ionic molecules in the sample overlaid near the surface of the electrode,  $C_{die}$  is the dielectric capacitance that is determined by the composition of the electrode, and  $R_s$  is the bulk solution resistance that is determined by the ion strength of the medium and accounts for the current transfer across the bulk solution. Based on the definition of electrical impedance ( $Z$ ), vector  $\vec{Z}$  can be represented with the equation

$$\vec{Z} = \frac{V_0 \sin 2\pi ft}{I_0 \sin(2\pi ft + \varphi)}, \quad (4.1)$$

where  $V_0$  and  $I_0$  are the maximum magnitudes of the voltage and current signals that sinusoidal signal  $\vec{V}$  and  $\vec{I}$  can generate,  $f$  is the frequency,  $t$  is the time, and  $\varphi$  is the phase shift between the vectors  $\vec{V}$  and  $\vec{I}$ . The overall impedance magnitude of the electrochemical system is

$$Z_{sys} = \sqrt{R^2 + (X_L - X_C)^2}, \quad (4.2)$$

where  $Z_{sys}$  is the impedance of the entire system,  $R$  is the resistance contains only a real impedance component,  $X_L$  is the inductive reactance (usually close to zero in a biological system) which contains only an imaginary impedance component, and  $X_C$  is the capacitive reactance which also contains only an imaginary impedance component (Barsoukov &

Macdonald, 2005). The fitted values of the components in the equivalent circuit based on the example of Fig. 4.4 (a) are listed in Table 4.1.

Table 4.1. One example of the fitted values of components in the equivalent circuit simulated for the developed immunosensor in the detection of *E. coli* O157:H7 and *S. Typhimurium*.

Reaction time	Parameters of the equivalent circuit #				
	$R_{ct}$ ( $\Omega$ )	$Z_w$ (DW)	$C_{die}$ (F)	$R_s$ (k $\Omega$ )	$C_{dl}$ (pF)
T=0 min	3.567±0.068 <sup>a *</sup>	10.00±0.00 <sup>a</sup>	24.53±0.07 <sup>a</sup>	357.9±14.33 <sup>a</sup>	56.32±0.07 <sup>a</sup>
T=30 min	3.571±0.045 <sup>a</sup>	10.04±0.00 <sup>a</sup>	24.94±0.04 <sup>a</sup>	275.7±9.77 <sup>b</sup>	56.62±0.08 <sup>a</sup>

# The values are mean  $\pm$  standard deviation based on the EI spectra.

\* Different letters in the same column indicate significant difference ( $P < 0.01$ ).

Comparing the values of these parameters before and after the enzymatic reaction, the only parameter that showed significant change was  $R_s$ .  $R_s$  related to the ion strength in the media, which meant the concentration of the gluconic acid was the factor with the greatest influence on the impedance magnitude of the entire electrochemical system. In this system, the amount of the gluconic acid being produced during the 30-min enzymatic reaction was determined by the amount of bacterial cells being captured and the average amount of GOx bound to each bacterial cell. Therefore, the impedance changes of the system could be used to indicate the concentration of bacterial cells that exist in the sample.

#### 4.4.2 Electrochemical analysis for the detection of the pathogenic bacteria

The Nyquist plot commonly used for the analysis of impedance is suitable to study redox probes with high conductivity and to analyze the impedance changes, but the analysis is not

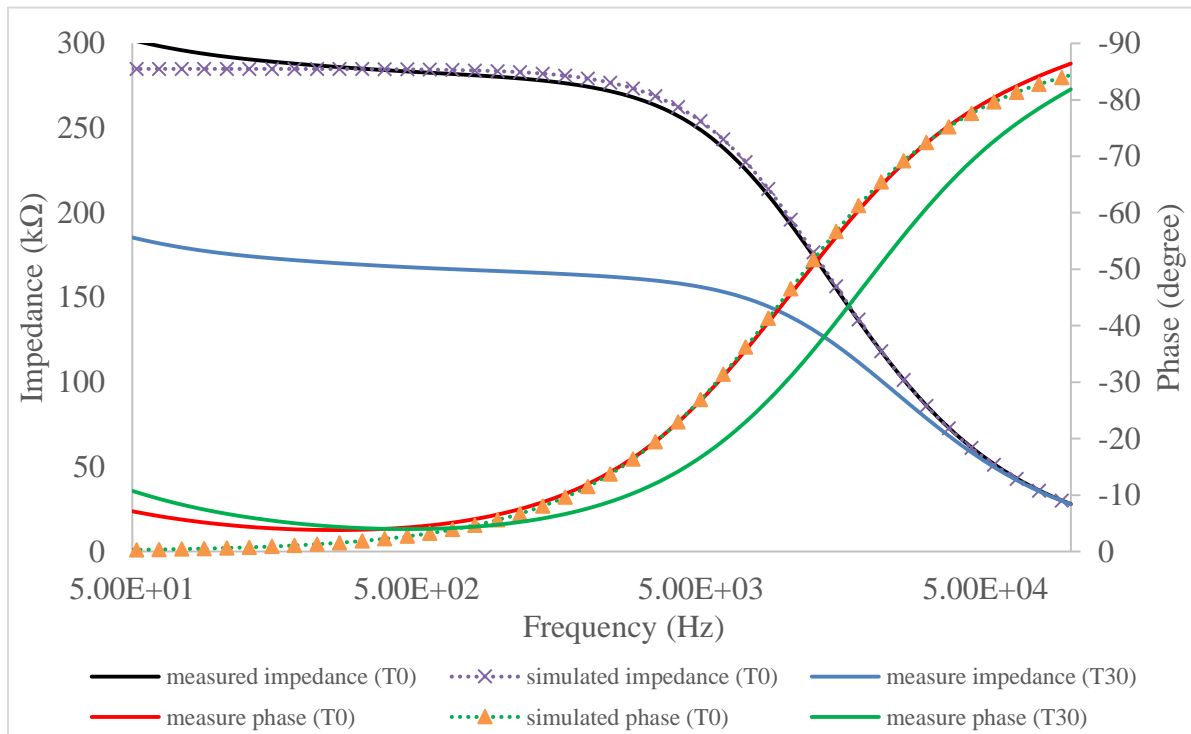

(a)

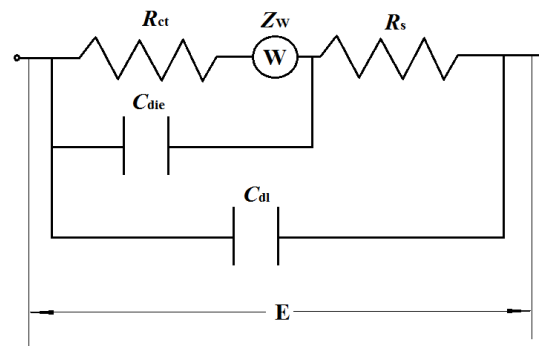

(b)

Figure 4.4. (a) The Bode plot of the impedance measurement and the fitted curve based on the equivalent circuit. Curves **BLACK** and **BLUE** are the spectra of the impedance magnitude before and after the enzymatic reaction, respectively. Curves **RED** and **GREEN** are the spectra of the phase angle before and after the enzymatic reaction, respectively. The **PURPLE** and **ORANGE** dot curves are fitted curves for curves **BLACK** and **RED** based on the equivalent circuit model. (b) The equivalent circuit that can represent the electrochemical system of the immunosensor.

directly related to the frequency (Ruan *et al.*, 2002). The Bode plot is more suitable to study the direct relationship between the impedance and the frequency (Gawad *et al.*, 2004; Varshney & Li, 2007), thus works better in this study. Fig. 4.4 (a) represents one example of electrochemical impedance spectra obtained for the detection of two foodborne pathogens. Comparing the spectra of the magnitude and phase angle of the impedance measurement before and after the enzymatic reaction, the magnitude of the impedance showed a significant decrease but the phase angle had no significant change ( $P < 0.01$ ). The electric components usually exhibit a distinctive phase angle shift. The resistors exhibit a phase shift of  $0^\circ$ , the capacitors exhibit a phase shift of  $90^\circ$ , and the Warburg impedance exhibits a phase shift of  $45^\circ$ . From the figure, there is no significant change on the phase angle of the impedance spectra, indicating there was no additional capacitance or Warburg impedance generated in the electrochemical system of the immunosensor before and after the enzymatic reaction. This was confirmed with the results from the equivalent circuit. From the spectra, in the frequency range of 100 kHz to 1400 Hz, the magnitude of the impedance increased sharply while the phase angle decreased sharply from  $90^\circ$ , indicating the dielectric capacitance at the surface of the electrode was the main factor affecting the current transfer. In the range of 1400 Hz to 70 Hz, the magnitude of the impedance mostly remained constant and the phase angle stayed close to  $0^\circ$ . In this range, the major factor affecting the current transfer was the bulk solution resistance. In the low frequency range of 70 Hz to 10 Hz, the magnitude and phase angle of the impedance increased slightly which was caused by the double layer capacitance that formed on the surface of the electrode. A similar pattern was also described in the work of Fu *et al.* (2014) for the detection of avian influenza virus using EIS with the same SP-IDME. At around 1.062 kHz, the change of the magnitude of the impedance reached the highest and the phase angle was close to zero. This shows that at this frequency value no obvious

capacitance or Warburg impedance was involved in the electrochemical system and the impedance change of the whole system was mainly due to the change of the bulk solution resistance which proportionally related to the change of the concentration of the bacteria. Therefore, the frequency of 1.062 kHz was determined to be the readout point for the impedance signals in further EIS tests.

#### 4.4.3 The immunosensor developed for the detection of *E. coli* O157:H7 and *S. Typhimurium*

##### Typhimurium in the pure culture

The capture efficiency using MBs-Abs conjugates (Fig. 4.5) and labeling efficiency of Ab-GOx conjugates were studied first (Table 4.2). In the concentration range of  $10^2$  and  $10^5$  cfu/ml, over 90% of bacterial cells were captured by MBs-Abs conjugates for both bacteria. When using different volume of Ab-GOx conjugates to label MBs-Abs-cell complexes at bacterial concentration of  $10^4$  cfu/ml, the magnitude changes of impedance at 1.062 kHz showed no

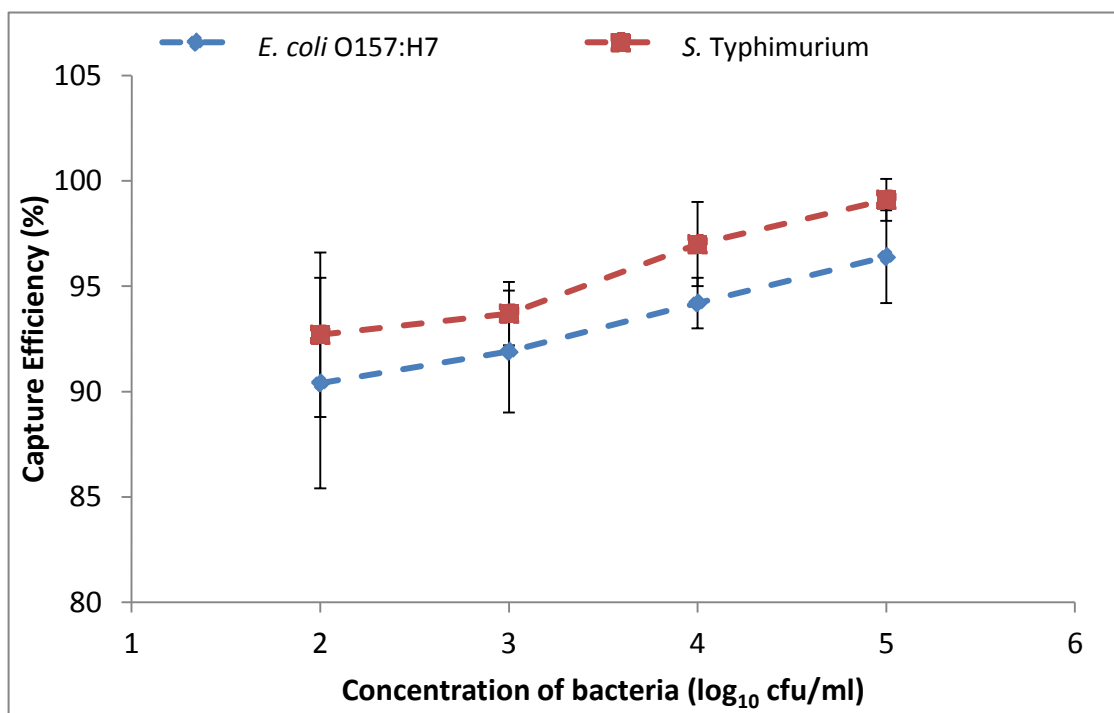

Figure 4.5. Capture efficiency of two bacteria using MBs-Abs conjugates.

significant difference when 7  $\mu\text{l}$  or more of Ab-GOx conjugates were used for *E. coli* O157:H7, and 5  $\mu\text{l}$  for *S. Typhimurium*. The electrochemical impedance magnitude changes at 1.062 kHz caused by enzymatic reaction using a range of different concentrations of two foodborne pathogens, *E. coli* O157:H7 and *S. Typhimurium*, in pure culture are shown in Fig. 4.6.

Table 4.2. Magnitude changes of impedance when different volumes of Ab-GOx conjugates were used to label  $10^4$  cfu/ml of both bacteria

Volume of Ab-GOx conjugates ( $\mu\text{l}$ )	Magnitude changes of impedance ( $\text{k}\Omega$ )	
	<i>E. coli</i> O157:H7	<i>S. Typhimurium</i>
2	$22.82 \pm 4.37^a$	$23.79 \pm 2.49^a$
5	$33.57 \pm 0.88^b$	$32.74 \pm 1.86^{a,b}$
7	$40.99 \pm 2.12^c$	$36.09 \pm 4.47^b$
10	$41.02 \pm 2.77^c$	$37.12 \pm 6.24^b$
15	$42.63 \pm 2.25^c$	$37.32 \pm 5.22^b$

The relationships of the impedance changes and the concentrations of two foodborne pathogens were well fitted into a simple linear regression in certain range. For *E. coli* O157:H7, the detection range was from  $2.76 \times 10^2$  cfu/ml to  $2.19 \times 10^6$  cfu/ml, while for *S. Typhimurium*, the detection range was from  $3.40 \times 10^2$  cfu/ml to  $3.72 \times 10^6$  cfu/ml. At lower concentration than  $10^2$  cfu/ml, the impedance changes of the bacterial samples were close to that of the NCs. The impedance change of the NCs was  $12.07 \pm 2.59$   $\text{k}\Omega$ , which was most likely caused by several reasons including experimental errors, the addition of the MBs-Abs-cell-Ab-GOx biomass in the final glucose solution, or the natural degradation of glucose in air. The limit of detection (LOD) for the immunosensor was determined to be 19.84  $\text{k}\Omega$ , which was obtained by, based on the

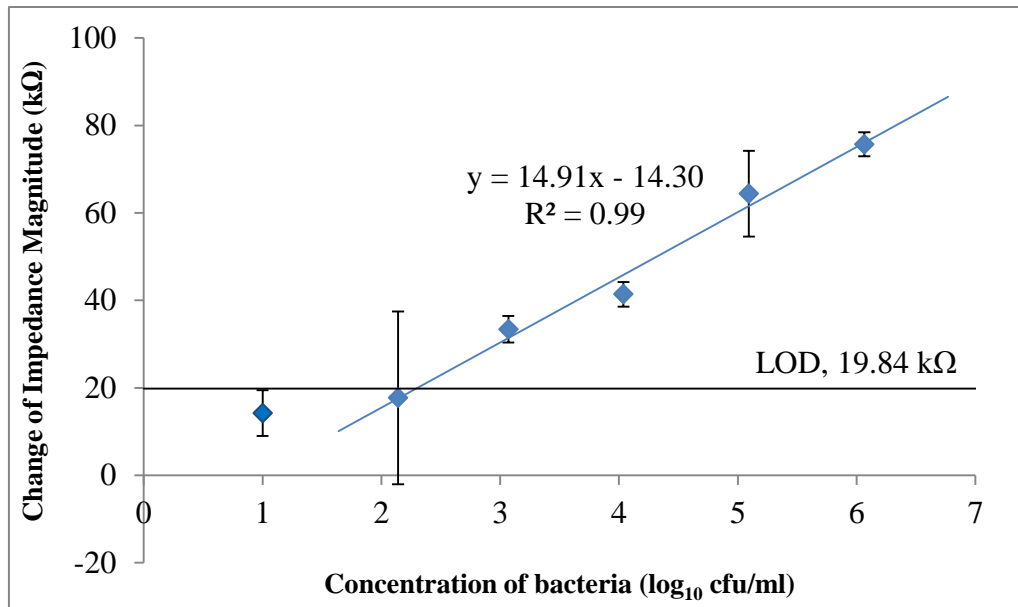

(a)

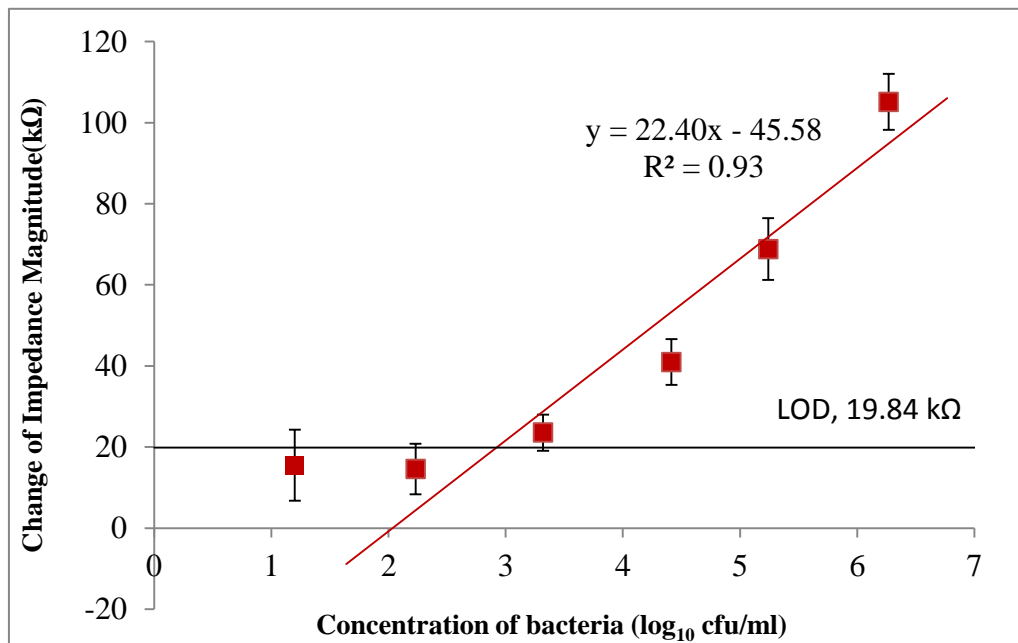

(b)

Figure 4.6. The calibration curves of the impedance magnitude changes versus the concentrations of bacteria for the detection of (a) *E. coli* O157:H7 and (b) *S. Typhimurium*. The impedance magnitude change for the negative controls was  $12.07 \pm 2.59$  kΩ. The limit of detection was determined by the equation based on signal/noise ratio of three, Mean of NCs + 3 × Standard deviation of NCs, which is 19.84 kΩ.



signal/noise ratio of three, adding the mean of NCs to its standard deviation multiplied by three. Based on the calibration curves, the LODs for *E. coli* O157:H7 and *S. Typhimurium* in the pure culture were found to be  $3.90 \times 10^2$  cfu/ml and  $1.66 \times 10^3$  cfu/ml, respectively. These LODs are close to most of those using a label-free EIS method with the immobilization of antibodies on the surface of the electrodes reported in previous research (Table 3.2).

The differences in the LODs could be caused by many factors including the differences in the sample preparation, test protocol, data interpretation, and the structure and configuration of the immunosensors. Even though some of the reports from previous publications achieved lower LODs than ours, our immunosensor showed several advantages compared to them. First, the SP-IDME used in the experiments had a higher signal/noise ratio and could achieve a steady-state more rapidly than the conventional system with three single-plate electrodes used in other research. The series of parallel gold fingers in the SP-IDME was able to establish the cathodic and anodic cycle very efficiently and suffered a very low ohmic decrease compared to normal electrodes in three or four electrode systems (Min & Baeumner, 2003), making SP-IDME very suitable for rapid detection methods. Second, the immunosensor fabricated in this study required only a bare electrode for the measurement which made it very easy to clean, preserve, and reuse. All the immunosensors using immobilization methods require strict surface cleaning of the electrodes and complicated immobilization protocols. The surface conditions (smoothness, integrity, etc.) have a serious influence on the result of the immobilization and the impedance measurement. Moreover, the immobilization procedures have to physically or chemically attach the Abs or other materials to the surface of the electrodes and may damage the electrodes if cleaned after use. Therefore, the regeneration of the electrodes is extremely difficult, and the reproducibility of the electrodes with the same immobilization patterns is questionable. Finally,

the high efficiency of the MBs-Abs conjugates in this study for capturing bacterial cells were promising for dealing with large volume of samples in food inspection. Immobilization methods can only capture bacterial cells if these cells are close to the surface of the electrode, which determines that the capture efficiency in these immunosensors is possibly low and only small volume of samples can be tested. However, the MBs-Abs conjugates used in this study could bind to the bacterial cells from all directions in the solution but had very little effect on the impedance changes of the samples, which made it possible to combine several small volume samples into a large one therefore, be able to detect low concentration of bacteria. Furthermore, the high efficiency of the enzymatic reaction of GOx could greatly amplify the signal when a low concentration of bacteria existed. However, one limitation of our immunosensor is that the scale of the electrode fingers is relatively large, which has weakened the effectiveness of the enzymatic reaction. The screen-printing technique is very promising on producing low cost, delicate and durable electrodes. However, at the time that the SP-IDME used in this study was designed, the smallest scale of the gold fingers that the SP-IDME could reach was 200  $\mu\text{m}$ . Considering the signal/noise ratio of the IDME will increase while the width of the electrode fingers decreased (Varshney & Li, 2007), the SP-IDME used in our sensor would be less sensitive compared to those non-screen-printed IDME with more narrow fingers. The development of the screen-printing technique has been advancing very fast, so the sensitivity of this SP-IDME can be much improved in the future.

#### **4.4.4 Specificity of the developed impedimetric immunosensor for the detection of *E. coli* O157:H7 and *S. Typhimurium***

As shown in Fig. 4.7, when *E. coli* O157:H7 and other non-target bacteria at  $10^5$  cfu/ml were tested, only *E. coli* O157:H7 showed an impedance change of 51.94  $\text{k}\Omega$  that was higher than the

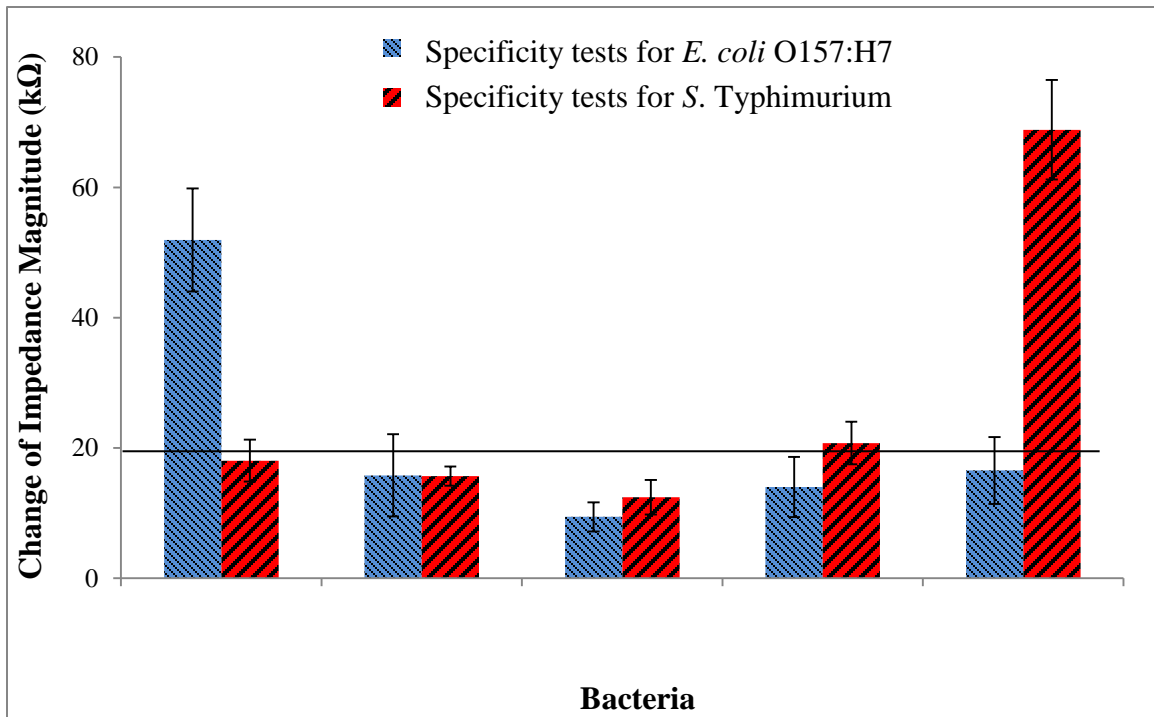
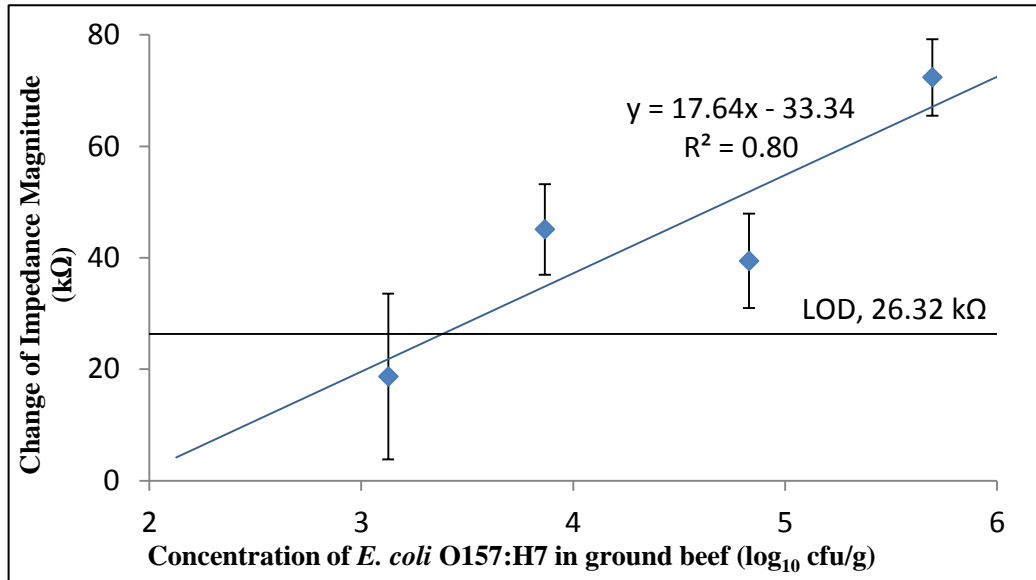

Figure 4.7. The specificity of the immunosensor for the detection of *E. coli* O157:H7 and *S. Typhimurium* when four non-target bacteria were tested at the same concentration of  $10^5$  cfu/ml. The black line represents the LOD of the impedance magnitude change which is 19.84 kΩ.

LOD of 19.84 kΩ. Other non-target bacteria yielded changes of the impedance value that were lower or close to the LOD. This indicated that the method was specific to detect *E. coli* O157:H7. The similar indication was also obtained for *S. Typhimurium* shown in Fig. 4.7. The change of the impedance value was 68.83 kΩ that was much larger than the LOD, suggesting the developed immunosensor had high specificity for the detection of *S. Typhimurium*. The specificity of the proposed method in this study depended on the antibodies used. The monoclonal anti-*Salmonella* antibody used in this study can recognize the lipopolysaccharides of *S. Typhimurium* (Group B). Based on the information provided by the company, this antibody does not recognize following: *S. paratyphi* A, *S. choleraesuis*, *S. Newport*, *S. enteritidis*, *S. anatum* and *S. selandia*. It is possible that this antibody can recognize other *S. spp.* in Group B.

#### 4.4.5 Detection of *E. coli* O157:H7 in ground beef and *S. Typhimurium* in chicken rinse water



(a)

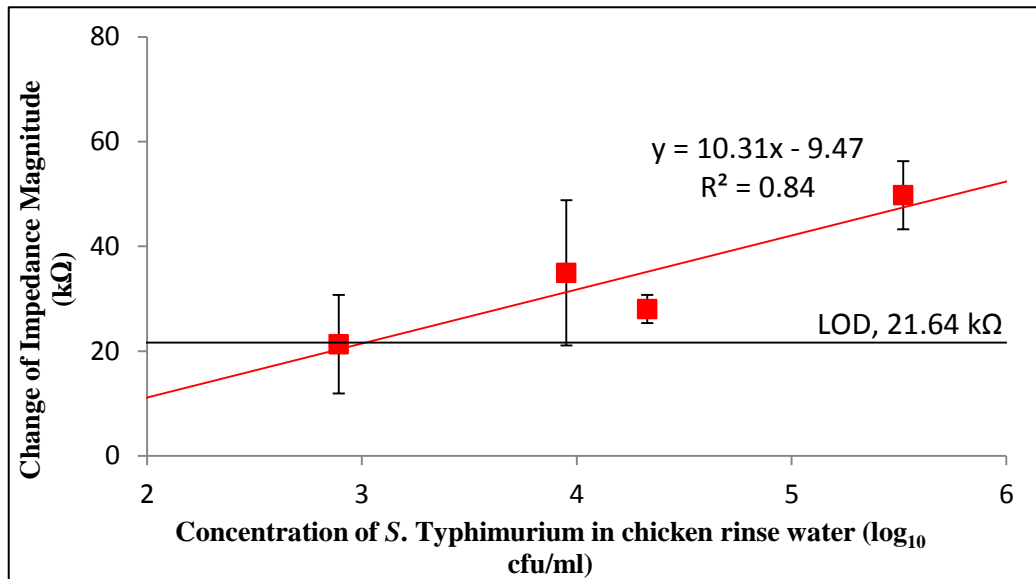

(b)

Figure 4.8. The calibration curves of the impedance magnitude changes versus the concentrations of (a) *E. coli* O157:H7 in ground beef and (b) *S. Typhimurium* in whole chicken carcass rinse water. The limit of detection was determined by the equation based on signal/noise ratio of three, Mean of NCs + 3 × Standard deviation of NCs, for both pathogens.

To verify the rapid detection method using the designed immunosensor coupled with the bare SP-IDME and magnetic separation, *E. coli* O157:H7 in ground beef and *S. Typhimurium* in chicken rinse water were individually examined, and the results are shown in Fig. 4.8. For *E. coli* O157:H7 (Fig. 4.8 (a)), the impedance change of the NCs was  $22.88 \pm 1.15$  k $\Omega$ , which determined the LOD of the impedance change was 26.32 k $\Omega$  based on the same method in section 4.4.3. Therefore, the LOD of the concentration of *E. coli* O157:H7 was  $10^{3.38}$  cfu/g ( $2.41 \times 10^3$  cfu/g) based on the calibration curve. If the dilution from ground beef to meat rinse water (10-time diluted) was taken into consideration, the LOD obtained from ground beef was at the similar order of magnitude to that of the pure bacterial culture. For *S. Typhimurium* (Fig. 4.8 (b)), the impedance change of the NCs was  $12.21 \pm 3.14$  k $\Omega$ . Therefore, the LODs of the impedance change and the concentration of *S. Typhimurium* were 21.64 k $\Omega$  and  $10^{3.02}$  cfu/ml ( $1.04 \times 10^3$  cfu/ml), respectively. The results showed that for the food samples,  $R^2$  values of both calibration curves were lower and the LODs of the impedance changes for the NCs were higher than the results obtained from the pure culture samples. This could be due to the facts that (1) the complicated food matrices might contain nutrient chemicals (fat, proteins, etc.) that could cause unspecific absorption onto the MBs which led to the disturbance of the enzymatic reaction later, (2) the developed impedance biosensor was under ultra-low ion solution, which made it very sensitive to any interference; and (3) the developed immunosensor was not at the optimized condition when treating food samples. But  $R^2$  in this study is acceptable comparing to ones reported by other similar sensors (Kanayeva *et al.*, 2012; Shabani *et al.*, 2013). If a filtration step was added after the food sample preparation to remove interfering matters, the impedance changes of the NCs could be reduced to yield lower LODs for the detection of these two pathogens. Furthermore, the optimization of the configuration of the immunosensor could be

conducted to get better and more stable performance when dealing with food samples. Finally, the high capture efficiency and capacity of the MBs-Abs conjugates can benefit for the further development of an automated microfluidic system that allows multiple samples of bacteria to be subsequently introduced into one sample so that the LODs of the concentration of the bacteria can become lower.

#### **4.5 Conclusions**

In this study, an immunosensor based on the bare SP-IDME coupling with 130 nm MBs and GOx labeling was developed for the rapid, low cost, and specific detection of two major foodborne pathogens, *E. coli* O157:H7 and *S. Typhimurium* in foods. The approach using MBs-Abs conjugates had achieved high capture efficiencies, and the electrochemical impedance analysis had revealed a simple linear relationship between the impedance changes and the concentrations of bacteria in a broad range from  $10^2$  to  $10^6$  cfu/ml for both pathogens. Based on the validation of this immunosensor for the detection of *E. coli* O157:H7 in ground beef and *S. Typhimurium* in chicken carcass rinse water, it demonstrated that the sensor could detect both bacteria at  $10^3$  cfu/g or cfu/ml without any enrichment process. On summary, even the developed immunosensor showed higher LODs for both pathogens comparing to other label-free immobilization-based impedimetric biosensors reported previously, the advantages of this immunosensor, such as removal of the complicated immobilization procedures, easy to regenerate, stable, easy handling, and low cost, had made it feasible to satisfy the requirement for the development of on-site detection of foodborne pathogens.

#### **4.6 References**

Abcam. 2013. Glucose Oxidase Conjugation Kit Protocol. Available at: <http://www.abcam.com/glucose-oxidase-conjugation-kit-ab102887.html>. Accessed on May 2014.

- Barsoukov, E., and J. R. Macdonald. 2005. *Impedance spectroscopy: Theory, experiment, and applications*, 2<sup>nd</sup> ed. Hoboken, NJ, US: John Wiley & Sons Ltd.
- Boer, E. de, and R. R. Beumer. 1999. Methodology for detection and typing of foodborne microorganisms. *J. Food Microbiol.* 50: 119-130.
- CDC (Centers for Disease Control and Prevention). 2011. CDC estimates of foodborne illness in the United States. Available at: <http://www.cdc.gov/foodborneburden/2011-foodborne-estimates.html>. Accessed on May 2014.
- CDC (Centers for Disease Control and Prevention). 2013. Multistate outbreak of Shiga toxin-producing *Escherichia coli* O157:H7 infections linked to ground beef. Available at: <http://www.cdc.gov/ecoli/2014/O157H7-05-14/index.html>. Accessed on May 2014.
- CDC (Centers for Disease Control and Prevention). 2014. Multistate outbreak of human *Salmonella* Typhimurium infections linked to live poultry in backyard flocks. Available at: <http://www.cdc.gov/salmonella/typhimurium-live-poultry-04-13/index.html>. Accessed on May 2014.
- Dong, J., H. Zhao, M. Xu, Q. Ma, and S. Ai. 2013. A label-free electrochemical impedance immunosensor based on AuNPs/PAMAM-MWCNT-Chi nanocomposite modified glassy carbon electrode for detection of *Salmonella* Typhimurium in milk. *Food Chem.* 141: 1980-1986.
- Fu, Y., Z. Callaway, J. Lum, R. Wang, J. Lin, and Y. Li. 2014. Exploiting enzyme catalysis in ultra-low ion strength media for impedance biosensing of avian influenza virus using a bare interdigitated electrode. *Anal. Chem.* 86: 1965-1971.
- Gawad, S., K. Xheung, U. Seger, A. Bertsch, and P. Renaud. 2004. Dielectric spectroscopy in micromachined flow cytometer: theoretical and practical considerations. *Lab Chip* 4: 241-251.
- Geng, P., X. Zhang, W. Meng, Q. Wang, W. Zhang, L. Jin, Z. Feng, and Z. Wu. 2008. Self-assembled monolayers-based immunosensor for detection of *Escherichia coli* using electrochemical impedance spectroscopy. *Electrochim. Acta* 53: 4663-4668.
- Ivnitski, D., I. Abdel-Hamid, P. Atanasov, E. Wilkins, and S. Stricker. 2000. Application of electrochemical biosensors for detection of food pathogenic bacteria. *Electroanal.* 12: 317-325.
- Kanayeva, D. A., R. Wang, D. Rhoads, G. F. Erf, M. K. Slavik, S. Tung, and Y. Li. 2012. Efficient separation and sensitive detection of *Listeria monocytogenes* using an impedance immunosensor based on magnetic nanoparticles, microfluidics and interdigitated microelectrode. *J. Food Prot.* 75: 1951-1959.
- Lazcka, O., F. J. D. Campo, and F. X. Munoz. 2007. Pathogen detection: A perspective of traditional methods and biosensors. *Biosens. Bioelectron.* 22: 1205-1217.

- Li, Z., Y. Fu, W. Fang, and Y. Li. 2015. Electrochemical impedance immunosensor based on self-assembled monolayers for rapid detection of *Escherichia coli* O157:H7 with signal amplification using lectin. *Sens.* 15: 19212-19224.
- Maalouf, R., C. Fournier-Wirth, J. Coste, H. Chebib, Y. Saikali, O. Vittori, A. Errachid, J.-P. Cloarec, C. Martelet, and N. Jaffrezic-Renault. 2007. Label-free detection of bacteria by electrochemical impedance spectroscopy: comparison to surface plasmon resonance. *Anal. Chem.* 79: 4879-4886.
- Mantzila, A. G., V. Malpa, and M. I. Prodromlids. 2008. Development of a faradic impedimetric immunosensor for the detection of *Salmonella* Typhimurium in milk. *Anal. Chem.* 80: 1169-1175.
- Nguyen, P.-D., T. B. Tran, D. T. X. Nguyen, and J. Min. 2014. Magnetic silica nanotube-assisted impedimetric immunosensor for the separation and label-free detection of *Salmonella* Typhimurium. *Sens. Actu. B: Chem.* 197: 314-320.
- Radke, S. M., and E. C. Alocilja. A high density microelectrode array biosensor for detection of *E. coli* O157:H7. *Biosens. Bioelectron.* 20: 1662-1667.
- Roda, A., M. Mirasoli, B. Roda, F. Bonvicini, C. Colliva, and P. Reschiglian. Recent developments in rapid multiplexed bioanalytical methods for foodborne pathogenic bacteria detection. *Microchim. Acta* 178: 7-28.
- Santos, M. B. dos, J. P. Aguil, B. Prieto-Simon, C. Sporer, V. Teixeira, and J. Samitier. 2013. Highly sensitive detection of pathogen *Escherichia coli* O157:H7 by electrochemical impedance spectroscopy. *Biosens. Bioelectron.* 45: 174-180.
- Santos, M. B. dos, S. Azevedo, J. P. Aguil, B. Prieto-Simon, C. Sporer, E. Torrents, A. Juarez, T. Teixeira, and J. Samitier. 2015. Label-free ITO-based immunosensor for the detection of very low concentrations of pathogenic bacteria. *Bioelectrochem.* 101: 146-152.
- Shabani, A., C. A. Marquette, R. Mandeville, and M. F. Lawrence. 2013. Magnetically-assisted impedimetric detection of bacteria using phage-modified carbon microarrays. *Talanta* 116: 1047-1053.
- Scharff, R. L. 2012. Economic burden from health losses due to foodborne illness in the United States. *J. Food Prot.* 75(1): 123-131.
- USDA (U. S. Department of Agriculture). 1998. Food Safety and Inspection Service, *Salmonella analysis: collecting raw meat and poultry product samples*. Washington, DC.
- Wilson, R., and A. P. F. Turner. Glucose oxidase: an ideal enzyme. *Biosens. Bioelectron.* 7: 165-185.
- Yang, L., and R. Bashir. 2008. Electrical/electrochemical impedance for rapid detection of foodborne pathogenic bacteria. *Biotechnol. Adv.* 26: 135-150.



Yang, L., Y. Li, and G. F. Erf. 2004. Interdigitated array microelectrode-based electrochemical impedance immunosensor for detection of *Escherichia coli* O157:H7. *Anal. Chem.* 76: 1107-1113.

Ruan, C., L. Yang, and Y. Li. 2002. Immunobiosensor chips for detection of *Escherichia coli* O157:H7 using electrochemical impedance spectroscopy. *Anal. Chem.* 74: 4814-4820.

Varshney, M., and Y. Li. 2007. Interdigitated array microelectrode based impedance biosensor coupled with magnetic nanoparticle-antibody conjugates for detection of *Escherichia coli* O157:H7 in food samples. *Biosens. Bioelectron.* 22: 2408-2414.

## **Chapter 5. An Electrochemical Biosensor for Rapid Detection of *E. coli* O157:H7 with Highly Efficient Bifunctional Glucose Oxidase-polydopamine Nanocomposites and Prussian Blue Modified Screen-printed Interdigitated Electrode**

### **5.1 Abstract**

The presence of pathogenic bacteria in foods has always been a great threat to the wellbeing of people and the revenue of food manufactures. Therefore, the demand for advanced detection methods that can sensitively and rapidly detect these pathogens has been of great importance. This study reports an electrochemical biosensor for rapid detection of *E. coli* O157:H7 with the integration of bifunctional glucose oxidase (GOx)-polydopamine (PDA) based polymeric nanocomposites (PMNCs) and Prussian blue (PB) modified screen-printed interdigitated microelectrodes (SP-IDMEs). The core-shell magnetic beads (MBs)-GOx@PDA PMNCs were first synthesized by the self-polymerization of dopamine (DA). Gold nanoparticles (AuNPs) were dispersed on the surface of PMNCs through biochemical synthesis to achieve further high efficient adsorption of antibodies (Abs) and GOx. The final product of the Abs/GOx<sub>ext</sub>/AuNPs/MBs-GOx@PDA PMNCs served as the carrier to separate target bacteria from food matrices as well as the amplifier for electrochemical measurement. The unbound PMNCs were separated by a filtration step and transferred into glucose solution to allow the enzymatic reaction to occur. The change of the current response was measured with an electrochemical detector using PB-modified SP-IDMEs. The constructed biosensor has been proven to be able to detect *E. coli* O157:H7 with the detection limit of 10<sup>2</sup> cfu/ml. The bifunctional PMNCs contain a high load of enzyme and can optimally utilize the binding sites on bacterial cells, which efficiently amplify the signals for measurement. The biosensor in this study

exhibited good specificity, reproducibility, and stability and is expected to have a great impact on applications in the detection of foodborne pathogens.

## 5.2 Introduction

*Escherichia coli* O157:H7 is the most common Shiga toxin-producing strain of *E. coli* in North America and can cause illness with a very low dose (10 to 100 cells). Symptoms include severe stomach cramps, bloody diarrhea, vomiting, or even life-threatening haemolytic uremic syndrome (HUS) (CDC (a), 2015; Griffin & Tauxe, 1991; Padola, 2014). Over many decades, every outbreak related to the presence of *E. coli* O157:H7 in food products has been a serious event that caused severe problems related to human health as well as brand damage and economic loss to food manufacturers (Hoffmann & Anekwe, 2013). Most recent cases of multistate outbreaks related to *E. coli* O157:H7 include one case associated with alfalfa sprouts had caused nine illnesses and two hospitalizations, and the company, Jack & the Green Sprouts, Inc., had to recall all of their alfalfa and alfalfa onion sprout products (CDC, 2016). Another case involving contaminated Costco rotisserie chicken salad had caused nineteen illnesses, five hospitalizations, and two cases of HUS (CDC (b), 2015). Taylor Farms Pacific, Inc. provided the celery and onion diced blend which was suspected to be the contamination source for Costco, and had to voluntarily recall all of their products using these two ingredients. Therefore, the development of detection methods for the purpose of monitoring or screening this pathogenic bacterium in foods to prevent the catastrophic foodborne illnesses have become vitally important and caught much attention by researchers working in the area related to food safety.

There have been numerous detection methods developed over the past several decades that can detect foodborne pathogens efficiently and effectively (Dwivedi & Laykus, 2011; Fu *et al.*, 2005; Yoshitomi *et al.*, 2012). Electrochemical biosensors, one branch that belongs to the biosensor

category for rapid detection, present advantages like good sensitivity, miniaturization potential, and mass production (Palchetti & Mascini, 2008), and have proven to be very promising in the biosensor field. There are three common electrochemical methods: voltammetry, amperometry, and electrochemical impedance spectroscopy. Even though they are based on the measurement for changes in different parameters, the strategies these methods employ have certain similarities (Bard & Faulkner, 2001; Monzo *et al.*, 2015). These electrochemical methods employ either (1) indirect detection forming a sandwich-like structure comprising of the target recognition element that binds to the biosensor surface and capture the target, the target bacterial cell, and the biochemical label (commonly enzyme) that triggers the reaction of the analyst in the media, or (2) direct detection by absorbing the target bacterial cells to the surface of the biosensor (Fu *et al.*, 2005). Both methods yield detectable changes as electric signals at the interface of the electrode and the media. With the recent advancements in nanomaterials, such as nanoporous films (Joung *et al.*, 2013; Tan *et al.*, 2011), nanochains (Li *et al.*, 2013), and nanotubes (Maurer *et al.*, 2012), and also microfluidics (Tan *et al.*, 2011; Varshney *et al.*, 2007(a)) and screen-printed electrodes (Li *et al.*, 2015; Xu *et al.*, 2016), the electrochemical biosensors have become more sensitive, smaller, and cheaper.

Despite all the advantages of using electrochemical biosensors for the detection of pathogenic bacteria, there are still limitations that require novel ideas to improve the performance of these sensors. Just as the two strategies mentioned previously, the indirect methods require the binding of two ligands successively to the target bacteria so the detection time is prolonged, whereas when dealing with the direct methods, although they have shorter detection time due to the label-free nature, they show relatively higher limit of detection (LOD) because their lack of additional amplification (Chemburu *et al.*, 2005; Lin *et al.*, 2008; Monzo *et*

*al.*, 2015; Settingington & Alocilja, 2012; Shabani *et al.*, 2008; Varshney & Li, 2007 (b); Zelada-Guillen *et al.*, 2010). Moreover, no matter when using a sandwich-like mechanism which applies two ligands competing with each other for the limited binding sites and space on the surface of the bacterial cell, or using the direct absorption of bacterial cells with spacial dimensions onto a plain surface of the electrode, it is apparent that neither of these two strategies can use the binding sites on the cell surface to the maximum potential. If there is an element that processes both functions of target recognition and electrochemical amplification, it can not only reduce the detection time, but also utilize the limited binding sites of the bacteria reaching the optimal condition to improve the LOD.

The construction of such an element for serving dual functions as the carrier and the signal amplifier requires a good supporting matrix that can integrate individual components without losing their bioactivities as well as having high process ability that can efficiently be modified with abundant biomolecules or nanoparticles. Since introduced by Messersmith's group (2007), the mussel-inspired polydopamine has gained much attention because its excellent properties. It is well-established that, at low concentration, initial pH values of 8 or above, and room temperature, PDA can be deposited onto various substrates as a controlled thin layer of film (Ball *et al.*, 2012; Ho & Ding, 2014; Liu *et al.*, 2013; Wei *et al.*, 2010). The rich reactive groups like catechol moieties and amines in the PDA backbone allow PDA to bind strongly to metal ions as well as synthetic entities, like nanoparticles, polymers, or other biomolecules (Dreyer *et al.*, 2013; Gu *et al.*, 2014; Ho & Ding, 2014; Liu *et al.*, 2013; Wei *et al.*, 2010). All of these great qualities allow PDA to be widely applied in the fabrication of nanocomposites.

Therefore, in this study, we report a novel electrochemical biosensor for the detection of *E. coli* O157:H7 based on the synthesized bifunctional polydopamine-polymeric nanocomposites

that are comprised of both antibodies and glucose oxidase. For the fabrication of the electrochemical biosensor, MBs were first bound to GOx through streptavidin-biotin reaction. After that, a thin layer of PDA film was synthesized on the MBs-GOx conjugates through controlled self-polymerization of DA under alkaline condition. The good biocompatibility of PDA allowed the GOx inside to still maintain the enzymatic activity to catalyse glucose to produce H<sub>2</sub>O<sub>2</sub> which could further reduce HAuCl<sub>4</sub> to generate AuNPs that attached to the surface of the MBs-GOx@PDA PMNCs. With successive adsorption of Abs and additional GOx, the final product of Abs/GO<sub>x<sub>ext</sub></sub>/AuNPs/MBs-GOx@PDA PMNCs was used to capture the target bacterial cells. By using the filtration technique, the free PMNCs were filtered out and concentrated in the glucose solution for measurement. The developed biosensor was also validated to detect *E. coli* O157:H7 in ground beef by using a handheld electrochemical detector. In this study, the bifunctional PMNCs have presented some valuable qualities like short detection time due to combining the target capturing and labelling steps, effective amplification because the PMNCs contain abundant enzyme, and efficient conversion of the biological recognition to the electrochemical signal because every possible binding site on the bacteria has active enzyme attached. This new concept has opened a new direction to construct rapid, sensitive and high efficient electrochemical biosensors.

## **5.3 Experimental**

### **5.3.1 Materials and apparatus**

Phosphate buffered saline 1 (PBS1, 0.1 M, pH 7.4), dopamine (DA), gold (III) chloride hydrate, potassium ferricyanide (III), glucose, and glucose oxidase (128200 U/g solid) were bought from Sigma-Aldrich (St. Louis, MI). Ferric chloride hexahydrate was purchased from MP Biomedicals, LLC. (Solon, OH). PBS2 (10 mM, pH 7.4) solution was prepared by diluting PBS1

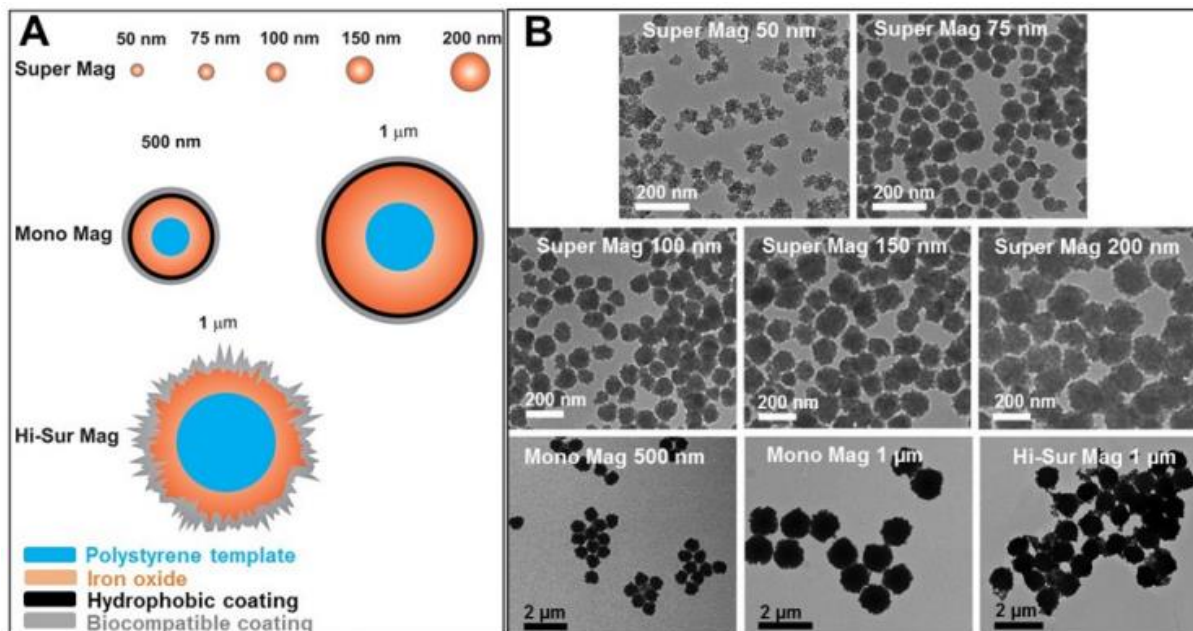

Figure 5.1. (A) Overall structure of the magnetic beads from Ocean NanoTech, and (B) TEM images of the magnetic beads at different sizes.

at a ratio of 1:10, and used throughout all tests. The ultrapure deionized water (18.2 MΩ·cm) was obtained from Milli-Q (EMD Millipore, Billerica, MA). The GOx was biotinylated based on the protocol reported by Kanayeva *et al.* using sulfo-NHS-biotin (Kanayeva *et al.*, 2012), and excessive biotin was removed with a Slide-A-Lyzer dialysis kit from Pierce Protein Research Product (10K MWCO, Rockford, IL). Streptavidin-coated magnetic beads with a diameter of 150 nm were manufactured by Ocean NanoTech, LLC. (San Diego, CA). Based on the information provided by the company, the superparamagnetic MBs contain 1 mg/ml solid content (Fe) with  $2.7 \times 10^{11}$  particles/mg. The surface of MBs was covalently modified by streptavidin with binding capacity for biotin-BSA or biotin-IgG of over 50 μg per mg or per ml. The overall structure and TEM images of the MBs were also provided by the company (Fig. 5.1).

The electrochemical analysis was conducted with a CHI750B electrochemical workstation manufactured by CH Instruments (Bee Cave, TX). A BDI handheld electrochemical detector

(BioDetection Instruments Inc., Fayetteville, AR) was used for amperometric measurement to test the food sample. The bare SP-IDME, which was designed by our group and customized by DropSens (Llanera, Spain), was constructed with six pairs of interdigitated concentric circles of gold fingers. The width of the gold fingers and the spacing between each two fingers are both 200  $\mu\text{m}$ . The active area of the gold fingers is about 12.38  $\text{mm}^2$  (Fig. 4.2). The MS0206 magnetic separator with a magnetic strength of approximately 1.0 Tesla (T) was purchased from Aibit LLC. (Jiangyin, China).

Rabbit anti-*E. coli* O+K polyclonal antibodies (4.0-5.0 mg/ml) were purchased from Meridian Life Science Inc. (Memphis, TN). 1:5 dilutions of the antibodies (0.8-1.0 mg/ml) were prepared with PBS and stored at 4 °C for further use, and storage time was no more than one month. Stock bacterial cultures of *E. coli* O157:H7 (ATCC 43888), *E. coli* K12 (ATCC 29425), and *S. Typhimurium* (ATCC 14028) were obtained from American Type Culture Collection (ATCC, Manassas, VA). The stock cultures were stored at -80 °C, and revived gently at room temperature when needed.

### **5.3.2 Methods for culture preparation and media plating enumeration**

The test cultures were prepared by growing the stock cultures in brain heart infusion (BHI) broth (Remel Microbiology Products, Lenexa, KS) at 37 °C for 18-20 h. A series of 1:10 dilutions for each bacterial culture were made with PBS2. To determine the viable cell numbers of tested bacteria, 100  $\mu\text{l}$  of each dilution were plated onto the surface of either non-selective Trypsin Soy Agar (TSA) when doing pure laboratory culture, or selective Sorbitol MacConkey (SMAC) agars when testing the food sample. The number of bacterial colonies formed on the media after incubation at 37 °C for 18 to 24 h was counted to determine the concentration of



viable bacteria cells in the terms of colony forming units per milliliter (cfu/ml). All the cultures were prepared on the test days.

### 5.3.3 Food Sample Preparation and Inoculation

The detection of *E. coli* O157:H7 in ground beef (freshly purchased from a local grocery store and transported to the lab within 15 min) was examined. 25 g of ground beef was weighted and transferred into a filtering stomacher bag. After that, 225 ml of sterile PBS solution was added to the stomacher bag, and mixed using a stomacher machine (Stomacher 400, Seward, UK) at 200 rpm for two min. Nine ml of ground beef rinse water was transferred into new tubes. Then one ml of the bacteria dilution (PBS as negative control, NC) was used to spike the ground beef rinse water to achieve desired concentration. The plate counting method was used to determine the concentration of the bacteria in ground beef rinse water. All liquid samples right after preparation were directly used in the electrochemical analysis for the detection of *E. coli* O157:H7.

### 5.3.4 Preparation of bifunctional PMNCs

The schematic description of the preparation of the PMNCs is shown in Fig. 5.2. First, 20  $\mu$ l of streptavidin-coated MBs were washed with 200  $\mu$ l of PBS2 to remove the preservative content in 1.5 ml protein low binding tubes (SARSTEDT AG & Co., Germany) and magnetically separated with the magnetic separator for three min. The supernatant was removed with a pipette

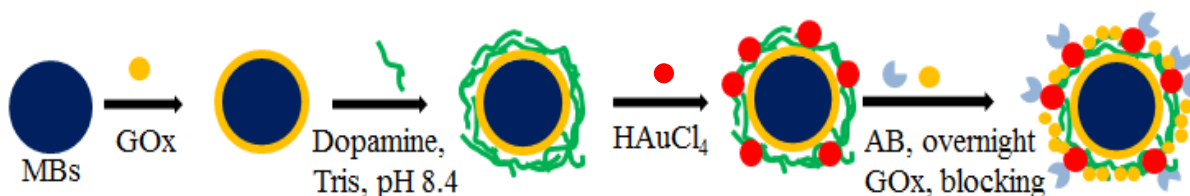

Figure 5.2. The schematic illustration of the Abs/GOx<sub>ext</sub>/AuNPs/MBs-GOx@PDA PMNCs synthesis.

carefully (magnetic separation procedures were the same below unless specifically mentioned). Second, the remains were mixed into 180  $\mu\text{l}$  of PBS2 and 20  $\mu\text{l}$  of biotin-GOx (excessive) and rotated at 15 rpm and room temperature (RT) for one hour. After the rotation finished, the yielded mixture was magnetically separated and re-dispersed into 400  $\mu\text{l}$  of 0.5 mg/ml DA (final concentration) in Tris buffer (pH 8.4, 10 mM). The mixture was rotated for another one hour to allow self-polymerization, yielding a suspension of the MBs-GOx@PDA biocomposites. After magnetic separation, the remaining biocomposites were rinsed with PBS2 three times and ultrasonically redispersed into 400  $\mu\text{l}$  of PBS2. Third, the synthesis of AuNPs was based on similar method used by Fu *et al.* (2010). Briefly, 0.20 mM HAuCl<sub>4</sub> (in PBS2, pH 7.4) and 5 mg/ml of glucose (both final concentration) were successively mixed into the yielded suspension for 5 h at 4 °C to allow biochemical synthesis of AuNPs on the surface of the MBs-GOx@PDA biocomposites. The dispersion of AuNPs on the surface of MBs-GOx@PDA PMNCs could help with adsorbing Abs and GOx more efficiently (Fu *et al.*, 2010). Finally, the synthesized AuNPs/MBs-GOx@PDA biocomposites were suspended into the solution containing excessive anti-*E. coli* polyclonal Abs overnight at 4 °C. After magnetic separation, the Abs/AuNPs/MBs-GOx@PDA PMNCs were mixed with 5 mg/ml GOx for 1 h at room temperature to block the unspecific attachment and to allow additional load of enzyme on the PMNCs. The prepared Abs/GOx<sub>ext</sub>/AuNPs/MBs-GOx@PDA PMNCs were stored at 4 °C when not in use.

### **5.3.5 Preparation of Prussian blue modified SP-IDME**

The bare SP-IDME was first thoroughly cleaned based on the reported protocol (Zhang *et al.*, 2007). The surface of the SP-IDME was carefully polished in alumina slurry with 0.02~0.05  $\mu\text{m}$  particles. After rinsing with Milli-Q water thoroughly, the electrodes were ultrasonically treated

for 2 min to remove residual alumina particles. After that, the electrodes were rinsed with Milli-Q water again and dried in the oven at 80 °C for 1 h.

The electrochemical deposition of the Prussian blue on the surface of the SP-IDME was performed by using cyclic voltammetry (CV) based on the procedure described by Lin *et al.* (2015) with minor changes. First, the bare SP-IDME was voltammetrically pre-treated from -1.7 V to 1.7 V for 1 cycle. Second, 50  $\mu$ l of aqueous solution containing 50 mM of FeCl<sub>3</sub>, K<sub>4</sub>Fe(CN)<sub>6</sub>, 0.1 M KCl, and 0.01 M HCl (all final concentration) were dropped to cover the entire active surface of the SP-IDME. The deposition of the PB was accomplished by applying -0.5 V to 0.5 V at a rate of 0.05 V/s for 2 cycles. The excessive solution was carefully washed off by Milli-Q water and the electrode was dried with nitrogen gas. Finally, 50  $\mu$ l of aqueous solution containing 0.1 M KCl and 0.01 M HCl was dropped onto the surface of the SP-IDME.

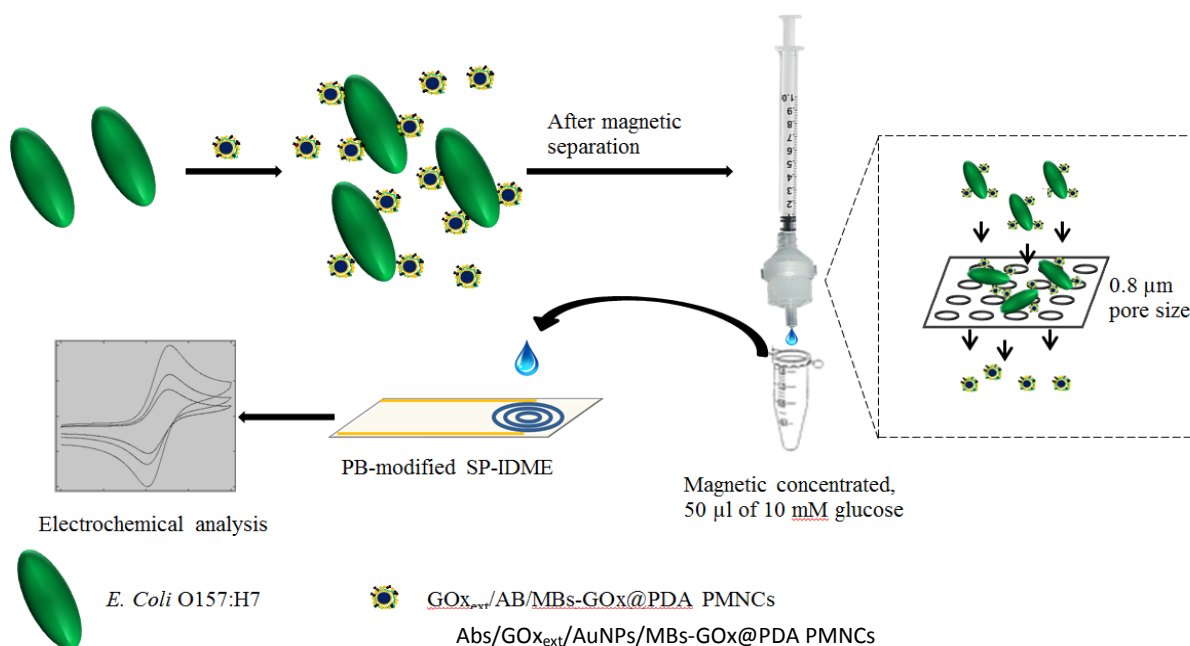

Figure 5.3. The construction of the electrochemical biosensor for the detection of *E. coli* O157:H7.

The electrode was electrochemically cycled from -0.5 V to 0.5 V at a rate of 0.1 V/s for 15 cycles until a stable CV curve was obtained. When not in use, the modified SP-IDMEs were kept in the desiccator at room temperature.

### **5.3.6 Construction of the electrochemical biosensor for the detection of *E. coli* O157:H7**

As illustrated in Fig. 5.3, the construction and mechanism of the electrochemical biosensor are described as follows. First, after blocking with GOx, the Abs/GOx<sub>ext</sub>/AuNPs/MBs-GOx@PDA PMNCs were thoroughly washed with PBS2 three times and ultrasonically dispersed in PBS2 each time. The final Abs/GOx<sub>ext</sub>/AuNPs/MBs-GOx@PDA PMNCs were mixed with 200 µl of *E. coli* O157:H7 dilutions with controlled concentration for 45 min at room temperature to allow the capture of the target bacteria. Third, the PMNCs-cell conjugates were magnetically separated, washed with PBS2 three times, and suspended in 200 µl of PBS2. Then, the suspension was filtrated through a filter paper (EMD Millipore) with pore size of 0.8 µm using a syringe (BD Syringes, Franklin Lakes, NJ) and a filtration holder (EMD Millipore) into a new tube (1.5 ml). 600 µl of PBS2 were used to wash the free PMNCs thoroughly off the filter paper. Finally, the solution containing filtered-out free PMNCs was magnetically separated for 5 min. Then 50 µl of 10 mM glucose solution (in PBS2) were added to allow enzymatic reaction for 5 min. All 50 µl of sample were dropped onto the PB-modified SP-IDME for electrochemical analysis. Both CV and amperometric detection were used to characterize and detect different concentration of target bacteria.

The specificity of the constructed biosensor was investigated by testing other non-target bacteria, such as *E. coli* K12 and *S. Typhimurium*. The concentration of the target and the non-target bacteria tested was 10<sup>4</sup> cfu/ml. The BDI handheld electrochemical detector was used to

validate the concept for the detection of target bacteria at concentration range of  $10^1$  to  $10^5$  cfu/ml in ground beef.

The statistical analysis of data, such as the mean, the standard deviation, and linear regression relationship, was performed using Excel 2010 software (Microsoft, Redmond, WA) with at least three replications for experiments.

## 5.4 Results and Discussion

### 5.4.1 Characterization of the PB-modified SP-IDME

Since the concept of glucose biosensors was first introduced in 1962 (Clark & Lyons, 1962), there have been numerous electrochemical methods developed to monitor the concentration of glucose in the solution (Jia *et al.*, 2010; Karyakin *et al.*, 1995; Rahman *et al.*, 2010; Yoo & Lee, 2010). Currently, most commercial glucose biosensors do not operate very differently from the concept of the second-generation glucose biosensors which use soluble or immobilized mediators to help with the charge transfer between the enzyme and the electrode (Yoo & Lee, 2010). Prussian blue, a mixture of ferric and ferrous cyanide, is one of the most common mediators. The mechanism of using the PB to detect glucose is based on the following reactions (GOx as the catalytic enzyme) (Galant *et al.*, 2015; Ji *et al.*, 2010).

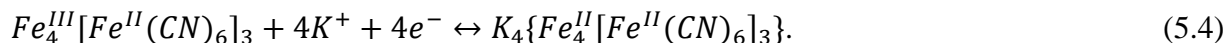
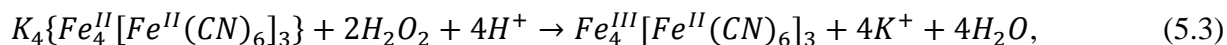
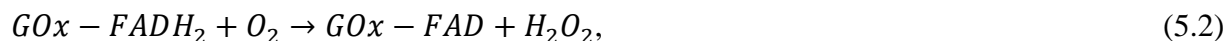
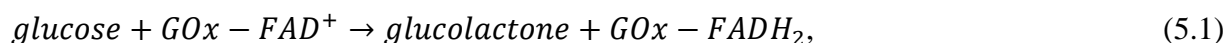

Even nowadays, PB mediated electrochemical biosensors are still under intensive study to construct sensitive, cheap, and reproducible electrodes or strips to monitor the concentration of glucose in different media.

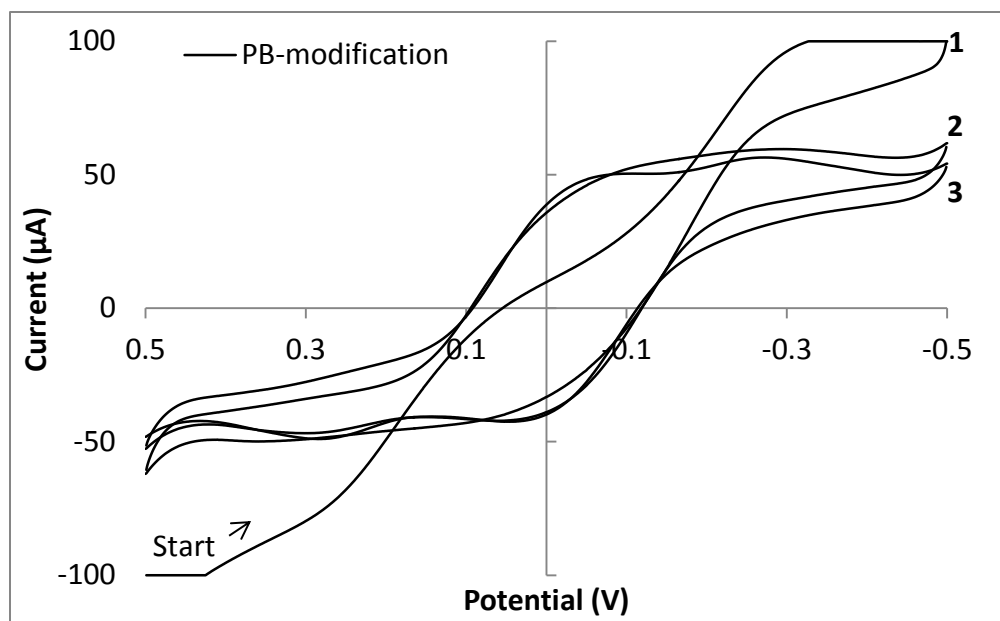

(a)

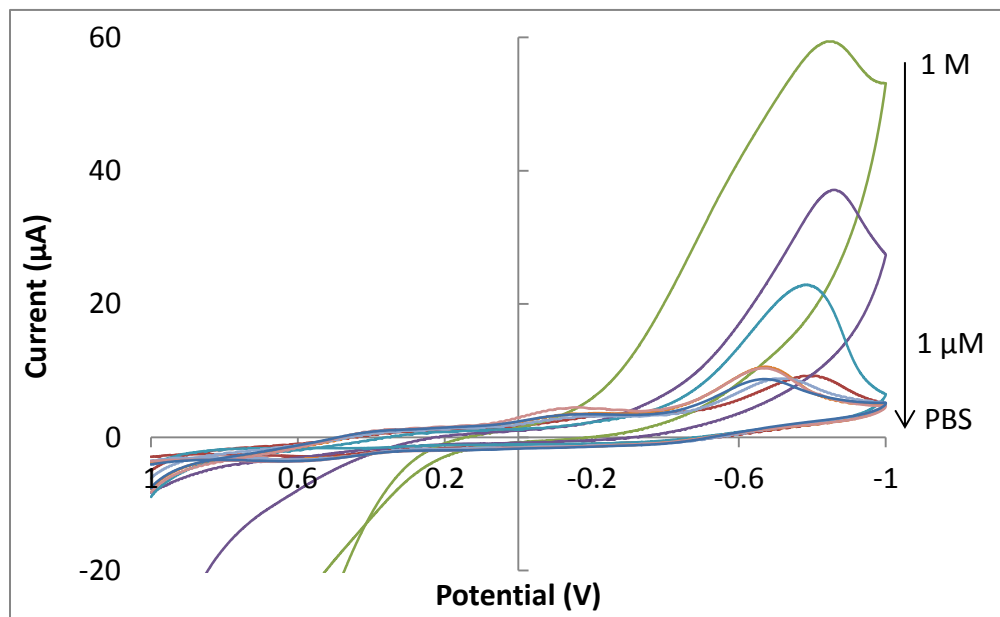

(b)

Figure 5.4. The characteristics of PB-modified SP-IDME by using electrochemical measurement. (a) Cyclic voltammetry of PB modification. (b) CVs of different concentration of  $\text{H}_2\text{O}_2$  when measured by PB-modified SP-IDME. (c) and (d) Amperometric measurement ( $i-t$ ) at  $-0.75$  V and the calibration curve when different concentration of  $\text{H}_2\text{O}_2$  were tested.

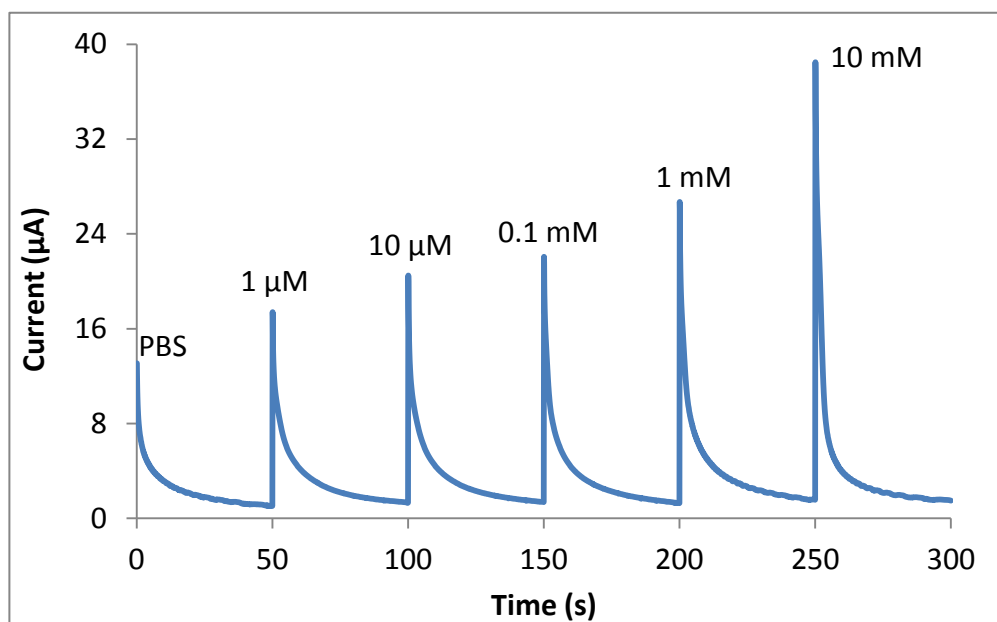

(c)

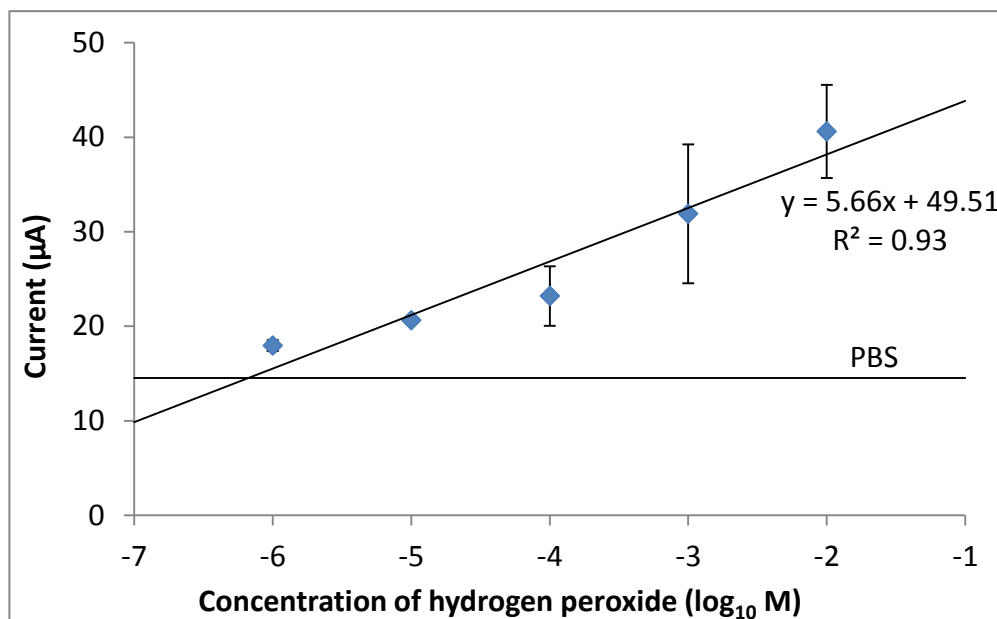

(d)

Figure 5.4 (Cont'd). The characteristics of PB-modified SP-IDME by using electrochemical measurement. (a) Cyclic voltammetry of PB modification. (b) CVs of different concentration of H<sub>2</sub>O<sub>2</sub> when measured by PB-modified SP-IDME. (c) and (d) Amperometric measurement (*i-t*) at -0.75 V and the calibration curve when different concentration of H<sub>2</sub>O<sub>2</sub> were tested.

Therefore, PB was used as the mediator to modify the SP-IDME for the purpose of constructing a cheap and easily reproducible measurement method to monitor the enzymatic reaction of glucose in this study. In order to evaluate the performance of the constructed biosensor, the characteristics of PB-modified SP-IDME must be clarified first (Figure 5.4). During the electrodeposition of PB onto the surface of SP-IDME (Fig. 5.4 (a)), the CV curve of cycle 1 was different from those of cycles 2 and 3, indicating the formation of PB film onto the electrode. The CV curves of cycle 2 and 3 show almost the same shape, indicating that no significant change of PB film deposited onto the electrode surface after cycle 2 which was determined to be used as the duration of PB electrodeposition for the following electrode modification. Fig. 5.4 (b) to (d) show the performance of the PB-modified SP-IDME when used for the electrochemical measurement of H<sub>2</sub>O<sub>2</sub> at different concentration. When there was H<sub>2</sub>O<sub>2</sub> present in the solution, one redox peak was shown at -0.8 V, and higher concentration of H<sub>2</sub>O<sub>2</sub> caused higher current response (Fig. 5.4 (b)). The presence of 1 M and 0.1 M H<sub>2</sub>O<sub>2</sub> gave an exceedingly large current response, and also damaged the PB film on the electrode surface based on the visual observation. Moreover, due to the electric connection of the SP-IDME, the working electrode and the reference electrode were connected to the same PB film, and the redox reaction of ferric ferrocyanide occurred simultaneously but individually on the two electrodes, doubling the redox potential reading (-0.75 V in Fig. 5.4 (b) comparing to -0.36 V vs. NHE). When the amperometric measurement at -0.75 V was used to detect different concentrations of H<sub>2</sub>O<sub>2</sub> (Fig. 5.4 (c)), the current decreased as time increased, and the highest current response occurred at the beginning of the measurement. Considering the sample stayed on the electrode surface during the measurement and no stirring was used to mix the sample, it appeared that the electrochemical reaction between the PB and H<sub>2</sub>O<sub>2</sub> at the interface of the electrode and the media was diffusion



limited. The PB-modified SP-IDME showed a linear relationship between the current peaks and the log concentration of H<sub>2</sub>O<sub>2</sub> in the range of 1 μM to 10 mM (Fig. 5.4 (d)), which could satisfy the requirement for the following tests.

#### 5.4.2 Characterization of the synthesized Abs/GO<sub>x</sub><sub>ext</sub>/AuNPs/MBs-GO<sub>x</sub>@PDA PMNCs

The synthesized Abs/GO<sub>x</sub><sub>ext</sub>/AuNPs/MBs-GO<sub>x</sub>@PDA PMNCs in this study had two responsibilities: (1) Recognition of the target bacteria, which requires the PMNCs to have the acceptable capability to isolate and concentrate the target bacteria from the sample media. (2) Conversion of the biological recognition to the electrochemical signal through the enzymatic reaction. The PMNCs which contained a large amount of GO<sub>x</sub> were expected to have high catalytic activity to induce significant concentration change of glucose which could efficiently amplify the electrochemical signal. Therefore, tests to exam the binding affinity between the synthesized PMNCs and the target bacterial cells to obtain the electrochemical characteristics of the PMNCs were conducted at first.

Table 5.1. Capture efficiency of the synthesized Abs/GO<sub>x</sub><sub>ext</sub>/MBs-GO<sub>x</sub>@PDA PMNCs for *E. coli* O157:H7

#	Volume of PMNCs (μl)	Volume of sample (μl)	Captured bacteria (cfu/ml)	Bacteria in waste (cfu/ml)	Capture efficiency (%)
1			2×10 <sup>1</sup>	1×10 <sup>1</sup>	66.7
2			0.80±0.20×10 <sup>2</sup>	0.05±0.05×10 <sup>2</sup>	94.1
3	20	200	1.04±0.02×10 <sup>3</sup>	0.12±0.00×10 <sup>3</sup>	89.6
4			1.01±0.06×10 <sup>4</sup>	0.12±0.00×10 <sup>4</sup>	89.4
5			0.90±0.04×10 <sup>5</sup>	0.11±0.01×10 <sup>5</sup>	89.1

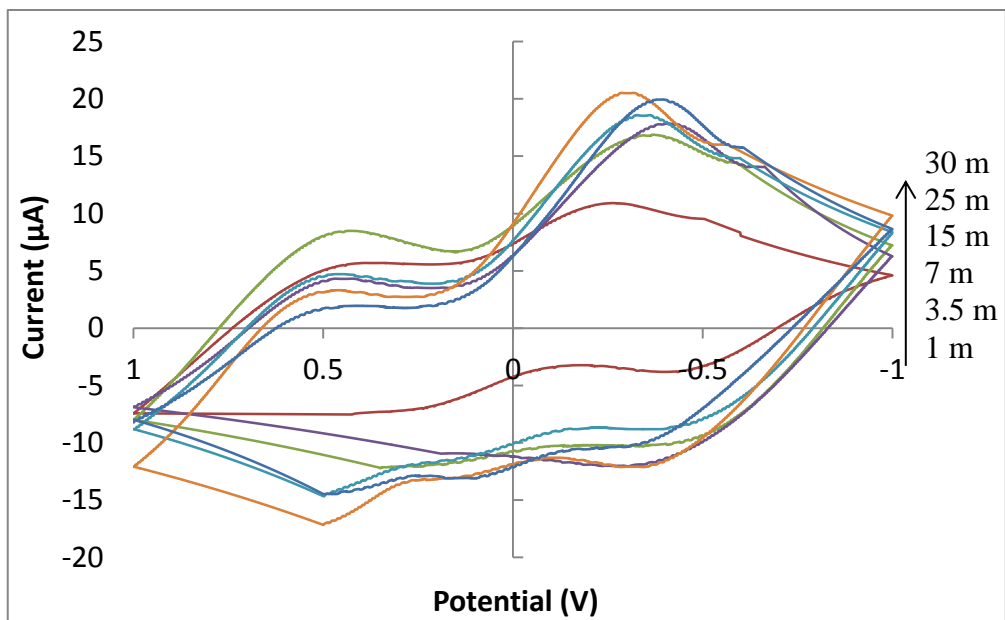

(a)

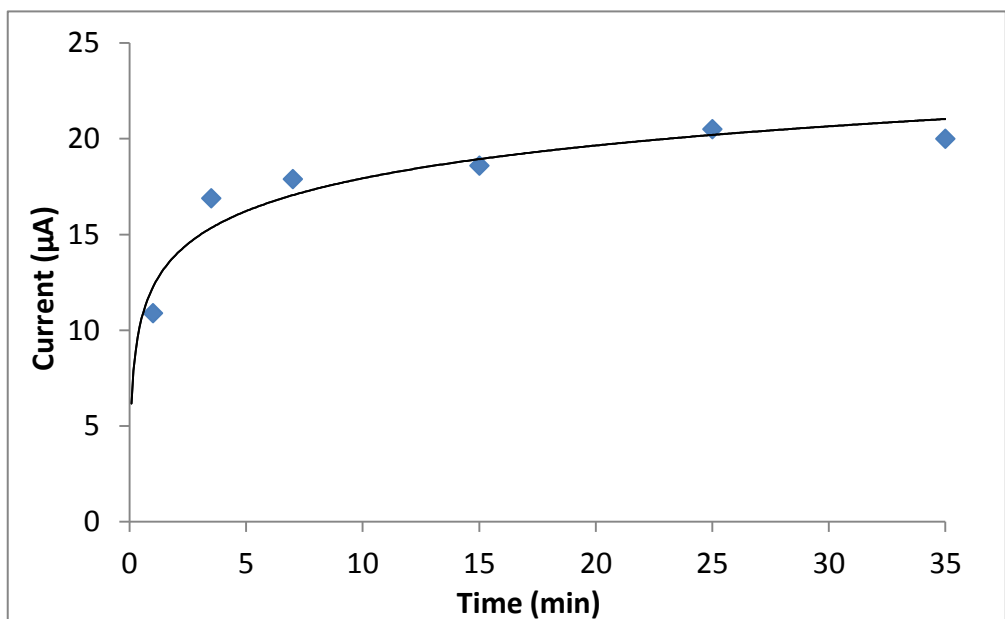

(b)

Figure 5.5. Enzymatic activity of the synthesized PMNCs. (a) Cyclic voltammetry at different time of enzymatic reaction. (b) Redox peaks at different time points of the enzymatic reaction.

The capture efficiency of using the synthesized PMNCs for *E. coli* O157:H7 at different concentrations was shown in Table 5.1. From the results, the PMNCs were able to capture approximately 89% or more of the target bacteria cells in the range of  $10^2$  to  $10^5$  cfu/ml. The rest, about 10% of the bacterial cells, was lost during the operation. The significant lower capture efficiency of PMNCs at  $10^1$  cfu/ml was probably due to that the total number of bacterial cells in the sample being too small (maybe only one or two). The loss of an individual cell in a small size group of cells was weighted much more than that in a large group of cells. Considering there was expected loss of bacterial cells due to procedures like magnetic separation or pipetting, the capture efficiency of the PMNCs was acceptable, and the volume of PMNCs used in the test was followed throughout the entire study.

To verify the enzymatic activity of the synthesized PMNCs, 20  $\mu$ l of the Abs/ $\text{GO}_{\text{xext}}$ /AuNPs/MBs- $\text{GO}_{\text{x}}$ @PDA PMNCs were mixed with 10 mM glucose solution and measured by CV at different time points during the glucose catalysis (Figure 5.5). From Figure 5.5 (a), there was a clear redox peak at about -0.4 V and the current response at this redox peak potential increased when the reaction time was longer. The current responses at the redox peak were plotted against the enzymatic reaction time (Figure 5.5 (b)), showing that the enzyme activity reached the maximum rate at 5 min. This was used as the reaction time in the further test for the detection of *E. coli* O157:H7.

#### **5.4.3 The constructed electrochemical biosensor for the detection of *E. coli* O157:H7 in the pure culture and the specificity of the biosensor**

The amperometric detection (at -0.4 V) of *E. coli* O157:H7 at different concentrations in the pure culture samples is shown in Fig. 5.6. From the figure, the current response is well-fitted into a simple linear regression against the concentration of *E. coli* O157:H7 within the range of  $10^1$  to

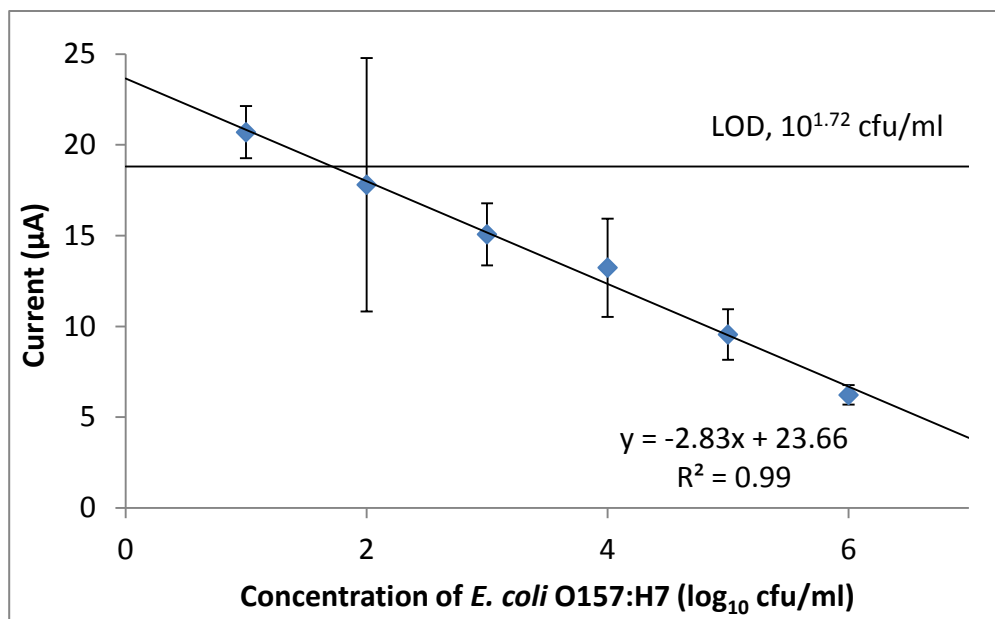

Figure 5.6. Amperometric detection of *E. coli* O157:H7 in pure culture samples. The potential applied was -0.4 V.

$10^6$  cfu/ml ( $R^2 = 0.99$ ). The obtained linear relationship between the current and the concentration of the bacteria has a negative slope, proving that more bacterial cells in the sample could retain more PMNCs at the filtration step and leave less PMNCs in the final glucose solution for the electrochemical measurement. The current response of negative control (NC) was  $25.83 \pm 2.34 \mu\text{A}$ . From the calibration curve, the limit of detection (LOD) of the constructed amperometric biosensor was  $10^{1.72}$  cfu/ml (or 52 cfu/ml), which was determined by using the mean of the NC minus its standard deviation multiplied by three ( $S/N = 3$ ). The large deviation shown at  $10^2$  cfu/ml was probably due to the small number of the bacterial cells presented in the sample (approximately 20 cfu). At this concentration of the bacteria, a variation of several cells made a significant influence on the final results, where it too weak to make a significant difference at lower concentration ( $10^1$  cfu/ml, or 1 cfu per sample) and not strong enough to reveal the differences at higher concentrations (more than  $10^3$  cfu/ml).

The LOD of the constructed amperometric biosensor was competitive to that of other electrochemical methods done by previously publications (Section 3.2.4). When comparing detection time, LODs, and strategies, our biosensor possesses several merits such as it had short detection time that is comparable to the electrochemical impedance sensors using label-free strategy but yielded the LOD that is similar to those obtained by the electrochemical sensors using labeling to amplify the signals. The detection procedure in this study was simple, only requiring the capture of the bacteria and a filtration step, which is beneficial if this biosensor is applied to on-site or in-field detection of the target bacterial.

The specificity of the constructed biosensor for the detection of *E. coli* O157:H7 is shown in Fig. 5.7. At  $10^4$  cfu/ml, the current response of the target bacteria had a difference of  $12.60 \mu\text{A}$  to that of the NC ( $25.83 \mu\text{A}$ ) which was significantly higher than that of *E. coli* K12 ( $3.77 \mu\text{A}$ ) and *S. Typhimurium* ( $3.02 \mu\text{A}$ ). Moreover, neither the current responses of *E. coli* K12 nor *S.*

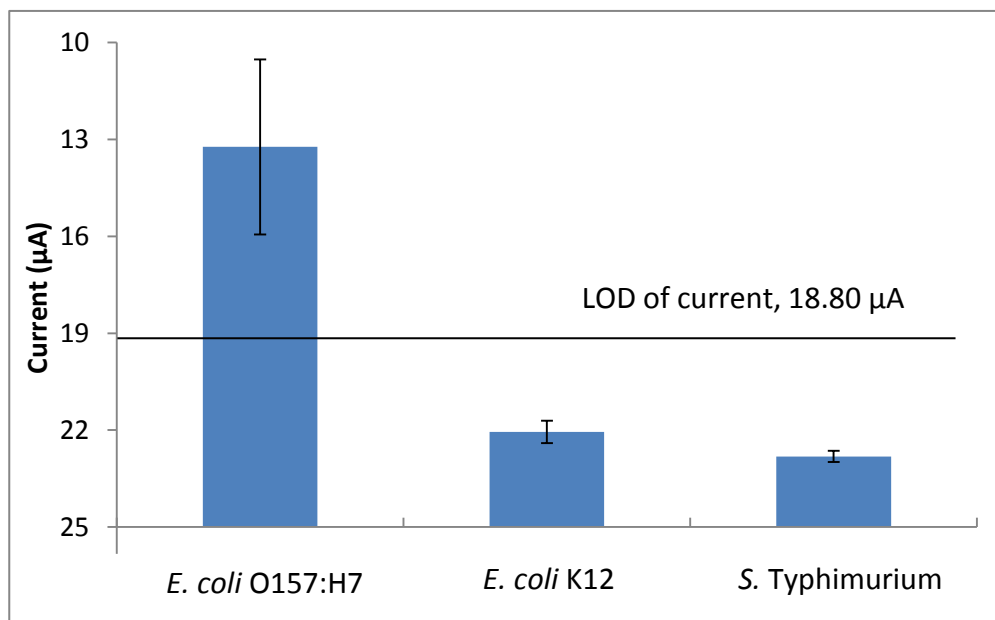

Figure 5.7. Specificity of the constructed electrochemical biosensor for the detection of *E. coli* O157:H7.

Typhimurium passed the LOD of current, which was 18.80  $\mu\text{A}$ . All of the above results suggest that the constructed biosensor was very specific for the detection of *E. coli* O157:H7. The specificity of the developed method was primarily determined by the polyclonal anti-*E. coli* antibody used. Based on the information of this antibody provided by the company, it reacts with many *E. coli* serotypes containing “O” and ‘K’ antigens. The specificity of this method can be improved by using more specific antibodies if such demand is required.

#### 5.4.4 The validation of the constructed biosensor for the detection of *E. coli* O157:H7 in ground beef by using a handheld electrochemical detector

The validation for the detection of *E. coli* O157:H7 in ground beef using the established method and a handheld electrochemical detector to replace the benchtop electrochemical workstation was also conducted (Fig. 5.8). The current response of the NC was  $20.64 \pm 0.93 \mu\text{A}$ , which determined the LOD of *E. coli* O157:H7 in ground beef was  $10^{2.28} \text{ cfu/g}$  ( $1.90 \times 10^2 \text{ cfu/g}$ )

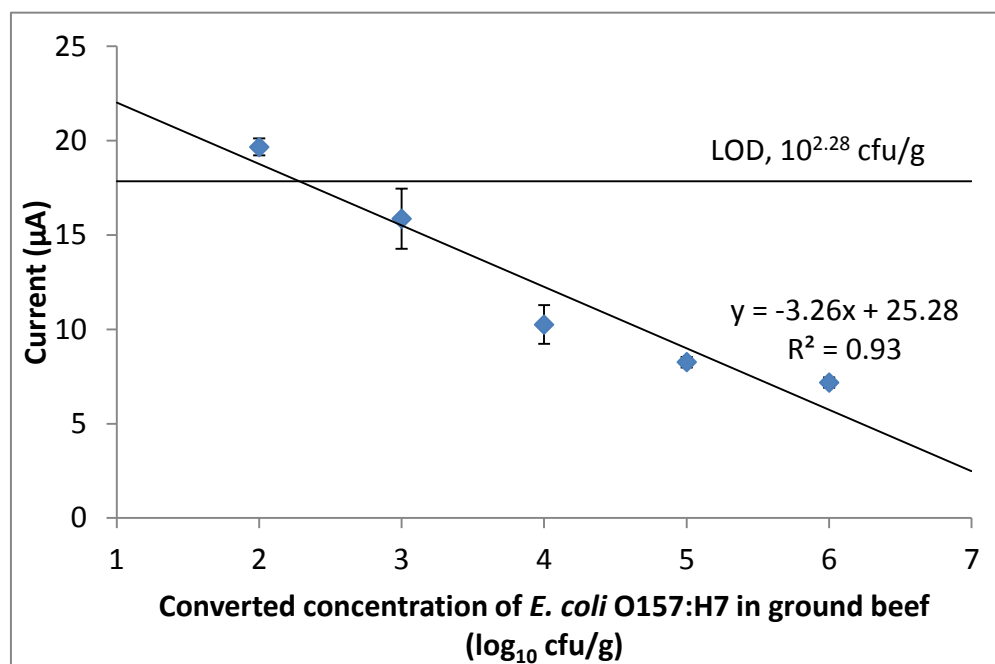

Figure 5.8. The detection of *E. coli* O157:H7 in ground beef using a handheld electrochemical detector.

using similar calculations as in Section 5.4.3. This LOD is generally consistent with the result obtained from the pure culture if the ratio of the ground beef to the liquid sample (1:10 w/v) was taken into consideration. Comparing the current responses of different concentrations of *E. coli* O157:H7, the results from the food samples were slightly lower than those from the pure culture samples. The reason for this is probably that the complex food matrix contains various ingredients (fat, proteins, etc.) which could obstruct the free PMNCs from being separated from the supernatant, or absorbed onto the free PMNCs and hindered them from passing through the filtration. However, considering the final LOD of *E. coli* O157:H7 in ground beef was comparable to that in pure culture and the filtration step also helped in retaining food residues which could reduce the noise, the results using the proposed electrochemical method are acceptable.

## 5.5 Conclusions

In this study, we synthesized bifunctional Abs/GO<sub>x</sub><sub>exl</sub>/AuNPs/MBs-GO<sub>x</sub>@PDA PMNCs, and fabricated an electrochemical biosensor coupled with PB-modified SP-IDME for the rapid and sensitive detection of *E. coli* O157:H7 in pure culture and in food. The developed biosensor showed a broad detection range from 10<sup>2</sup> to 10<sup>6</sup> cfu/ml in the pure culture within 1 h. The validation of the developed approach to detect the target bacteria in ground beef demonstrated that it could detect as low as 190 cfu/g without a pre-enrichment procedure, and the possibility of using a handheld device to achieve the electrochemical measurement which demonstrates the benefit for on-site or in-field applications by using the proposed method. To conclude, the developed electrochemical biosensor possesses short detection time similar to that of sensors using label-free strategy but also with efficient amplification to achieve low LOD which is comparable to others using various labelling strategies. The advantages of using the bifunctional

PMNCs in this study exhibited a new direction to construct electrochemical biosensors for sensitive and rapid detection of foodborne pathogens.

## 5.6 References

Ball, V., D. del Frari, V. Toniazzo, and D. Ruch. 2012. Kinetics of polydopamine film deposition as a function of pH and dopamine concentration: insights in the polydopamine deposition mechanism. *J. Colloid Inter. Sci.* 386: 366-372.

Bard, A. J., and L. R. Faulkner. 2001. *Electrochemical methods: Fundamentals and applications*. 2<sup>nd</sup> ed. Hoboken, NJ: John Wiley & Sons, Inc.

CDC (Centers for Disease Control and Prevention). 2015(a). *E. coli (Escherichia coli)*. Available at: <http://www.cdc.gov/ecoli/general/index.html#what-are-shiga-toxin>. Accessed on March 2016.

CDC (Centers for Disease Control and Prevention). 2015(b). Multistate outbreak of Shiga toxin-producing *Escherichia coli* O157 infections linked to alfalfa sprouts produced by Jack & the Green Sprouts. Available at: <http://www.cdc.gov/ecoli/2016/o157-02-16/index.html>. Accessed on March 2016.

CDC (Centers for Disease Control and Prevention). 2016. Multistate outbreak of Shiga toxin-producing *Escherichia coli* O157 infections linked to Costco rotisserie chicken salad. Available at: <http://www.cdc.gov/ecoli/2015/o157h7-11-15/index.html>. Accessed on March 2016.

Chemburu, S., E. Wilkins, and I. Abdel-Hamid. 2005. Detection of pathogenic bacteria in food samples using highly-dispersed carbon particles. *Biosens. Bioelectron.* 21: 491-499.

Clark, L. C., and C. Lyons. 1962. Electrode systems for continuous monitoring in cardiovascular surgery. *Ann. N. Y. Acad. Sci.* 102: 29-45.

Dreyer, D. R., D. J. Miller, B. D. Freeman, D. R. Paul, and C. W. Bielawski. 2013. Perspectives on poly(dopamine). *Chem. Sci.* 4: 3796-3802.

Dwivedi, H. P., and L.-A. Jaykus. 2011. Detection of pathogens in foods: the current state-of-the-art and future directions. *Crit. Rev. Microbiol.* 37: 40-63.

Fu, Z., S. Rogelj, and T. L. Kieft. 2005. Rapid detection of *Escherichia coli* O157:H7 by immunomagnetic separation and real time PCR. *J. Food Microbiol.* 99: 47-57.

Fu, Y., P. Li, L. Bu, T. Wang, Q. Xie, X. Xu, L. Lei, C. Zou, and S. Yao. 2010. Chemical/biochemical preparation of new polymeric bionanocomposites with enzyme labels immobilized at high load and activity for high-performance electrochemical immunoassay. *J. Phys. Chem. C* 114: 1472-1480.

Galant, A. L., R. C. Kaufman, and J. D. Wilson. 2015. Glucose: detection and analysis. *Food Chem.* 188: 149-160.



- Griffin, P. M., and R. V. Tauxe. 1991. The epidemiology of infections caused by *Escherichia coli* O157:H7, other enterohemorrhagic *E. coli*, and the associated haemolytic uremic syndrome. *Epidemiol. Rev.* 13: 60-98.
- Gu, X., Y. Zhang, H. Sun, X. Song, C. Fu, and P. Dong. 2014. Mussel-inspired polydopamine coated iron oxide nanoparticles for biomedical application. *J. Nanomater.* 2015: 1-12.
- Ho, C.-C., and S.-J. Ding. 2014. Structure, properties and applications of mussel-inspired polydopamine. *J. Biomed. Nanotechnol.* 10: 3063-3084.
- Hoffmann, S., and T. D. Anekwe. 2013. Making sense of recent cost-of-foodborne-illness estimates. *EIB-118*, USDA (U.S. Department of Agriculture), Economic Research Service.
- Ji, X., J. Ren, R. Ni, and X. Liu. 2010. A stable and controllable Prussian blue layer electrodeposited on self-assembled monolayers for constructing highly sensitive glucose biosensor. *Analyst* 135: 2092-2098.
- Jia, W.-Z., K. Wang, and X.-H. Xia. 2010. Elimination of electrochemical interferences in glucose biosensors. *Trends Anal. Chem.* 29(4): 306-318.
- Joung, C.-K., H.-N. Kim, M.-C. Lim, T.-J. Jeon, H.-Y. Kim, and Y. R. Kim. 2013. A nanoporous membrane-based impedimetric immunosensor for label-free detection of pathogenic bacteria in whole milk. *Biosens. Bioelectron.* 44: 210-215.
- Kanayeva, D. A., R. Wang, D. Rhoads, G. F. Erf, M. K. Slavik, S. Tung, and Y. Li. 2012. Efficient separation and sensitive detection of *Listeria monocytogenes* using an impedance immunosensor based on magnetic nanoparticles, microfluidics and interdigitated microelectrode. *J. Food Prot.* 75: 1951-1959.
- Karyakin, A. A., O. V. Gitelmacher, and E. E. Karyakina. 1995. Prussian blue-based first generation biosensor. A sensitive amperometric electrode for glucose. *Anal. Chem.* 67(14): 2419-2423.
- Lee, H., S. M. Dellatore, W. M. Miller, and P. B. Messersmith. 2007. Mussel-inspired surface chemistry for multifunctional coating. *Sci.* 318: 426-430.
- Li, Y., J. Deng, L. Fang, K. Yu, H. Huang, L. Jiang, W. Liang, and J. Zheng. 2015. A novel electrochemical DNA biosensor based on HRP-mimicking hemin/G-quadruplex wrapped GOx nanocomposites as tag for detection of *Escherichia coli* O157:H7. *Biosens. Bioelectron.* 63: 1-6.
- Li, Y., L. Fang, P. Cheng, J. Deng, L. Jiang, H. Huang, and J. Zheng. An electrochemical immunosensor for sensitive detection of *Escherichia coli* O157:H7 using C<sub>60</sub> based biocompatible platform and enzyme functionalized Pt nanochains tracing tag. *Biosens. Bioelectron.* 49: 485-491.

- Li, Z., Y. Fu, W. Fang, and Y. Li. 2015. Electrochemical impedance immunosensor based on self-assembled monolayers for rapid detection of *Escherichia coli* O157:H7 with signal amplification using lectin. *Sens.* 15: 19212-19224.
- Lin, Y.-H., S.-H. Chen, Y.-C. Chuang, Y.-C. Lu, T. Y. Shen, C. A. Chang, and C.-S. Lin. 2008. Disposable amperometric immunosensing strips fabricated by Au nanoparticles-modified screen-printed carbon electrodes for the detection of foodborne pathogen *Escherichia coli* O157:H7. *Biosens. Bioelectron.* 23: 1832-1837.
- Lin, Y., L. Hu, L. Yin, and L. Guo. 2015. Electrochemical glucose biosensor with improved performance based on the use of glucose oxidase and Prussian blue incorporated into a thin film of self-polymerized dopamine. *Sens. Actu. B* 210: 513-518.
- Liu, X., J. Cao, H. Li, J. Li, Q. Jin, K. Ren, and J. Ji. 2013. Mussel-inspired polydopamine: a biocompatible and ultrastable coating for nanoparticles in vivo. *ACS Nano* 7(10): 9384-9395.
- Maurer, E. I., K. K. Comfort, S. M. Hussain, J. J. Schlager, and S. M. Mukhopadhyay. 2012. Novel platform development using an assembly of carbon nanotube, nanogold and immobilized RNA capture element towards rapid, selective sensing of bacteria. *Sens.* 21: 8135-8144.
- Monzo, J., I. Insua, F. Fernandez-Trillo, and P. Rodriguez. 2015. Fundamentals, achievements and challenges in the electrochemical sensing of pathogens. *Analyst* 140: 7116-7128.
- Padola, N. L. Advances in detection methods for Shiga toxin-producing *Escherichia coli* (STEC). *Front. Microbiol.* 5: 277-.
- Palchetti, I., and M. Mascini. 2008. Electroanalytical biosensors and their potential for food pathogen and toxin detection. *Anal. Bioanal. Chem.* 391: 455-471.
- Rahman, M. M., A. J. S. Ahammad, J.-H. Jin, S. J. Ahn, and J.-J. Lee. 2010. A comprehensive review of glucose biosensors based on nanostructured metal-oxides. *Sens.* 10: 4855-4886.
- Settingington, E. B., and E. C. Alocilja. 2012. Electrochemical biosensor for rapid and sensitive detection of magnetically extracted bacterial pathogens. *Biosens.* 2(1): 15-31.
- Shabani, A., M. Zourob, B. Allain, C. A. Marquette, M. F. Lawrence, and R. Mandeville. Bacteriophage-modified microarrays for the direct impedimetric detection of bacteria. *Anal. Chem.* 80(24): 9475-9482.
- Tan, F., P. H. M. Leung, Z.-B. Liu, Y. Zhang, L. Xiao, W. Ye, X. Zhang, L. Yi, and M. Yang. 2011. A PDMS microfluidic impedance immunosensor for *E. coli* O157:H7 and *Staphylococcus aureus* detection via antibody-immobilized nanoporous membrane. *Sens. Actu. B* 159: 328-335.
- Varshney, M., and Y. Li. 2007(a). Interdigitated array microelectrode based impedance biosensor coupled with magnetic nanoparticle-antibody conjugates for detection of *Escherichia coli* O157:H7 in food samples. *Biosens. Bioelectron.* 22: 2408-2414.

Varshney, M., Y. Li, B. Srinivasan, and S. Tung. 2007(b). A label-free, microfluidics and interdigitated array microelectrode-based impedance biosensor in combination with nanoparticles immunoseparation for detection of *Escherichia coli* O157:H7 in food samples. *Sens. Actu. B* 128: 99-107.

Wang, Y., J. Ping, Z. Ye, J. Wu, and Y. Ying. 2013. Impedimetric immunosensor based on gold nanoparticles modified graphene paper for label-free detection of *Escherichia coli* O157:H7. *Biosens. Bioelectron.* 49: 492-498.

Wei, Q., F. Zhang, J. Li, B. Li, and C. Zhao. 2010. Oxidant-induced dopamine polymerization for multifunctional coating. *Polym. Chem.* 1: 1430-1433.

Xu, M., R. Wang, and Y. Li. 2016. Rapid Detection of *Escherichia coli* O157:H7 and *Salmonella* Typhimurium in Foods Using an Electrochemical Immunosensor Based on Screen-printed Interdigitated Microelectrode and Immunomagnetic Separation. *Talanta* 148: 200-208.

Yoo, E.-H., and S.-Y. Lee. 2010. Glucose biosensors: an overview of use in clinical practice. *Sens.* 10(5): 4558-4576.

Yoshitomi, K. J., K. C. Jinneman, R. Zapata, S. D. Weagant, and W. M. Fedio. Detection and isolation of low levels of *E. coli* O157:H7 in cilantro by real-time PCR, immunomagnetic separation, and cultural methods with and without an acid treatment. *J. Food. Sci.* 77(8): 481-489.

Zhang, J., S. Song, L. Wang, D. Pan, and C. Fan. 2007. A gold nanoparticle-based chronocoulometric DNA sensor for amplified detection of DNA. *Nat. Protoc.* 2(11): 2888-2897.

Zelada-Guillen, G. A., S. V. Bhosale, J. Riu, and F. X. Rius. 2010. Real-time potentiometric detection of bacteria in complex samples. *Anal. Chem.* 82: 9254-9260.

## **Chapter 6. An electrochemical aptasensor for rapid detection of *Salmonella* Typhimurium based on the bifunctional magnetic nanocomposites**

### **6.1 Abstract**

*Salmonella* has been estimated to be the top one pathogenic bacteria that accounts for the most foodborne illnesses in the US. A novel electrochemical aptasensor was developed in this study for rapid detection of *S. Typhimurium* based on the magnetic bifunctional polydopamine (PDA) polymeric nanocomposites (PMNCs). The core-shell magnetic beads (MBs)-GOx@PDA PMNCs were first synthesized as the primary vehicle to support the further functionalization and to isolate and concentrate the target bacteria. Gold nanoparticles (AuNPs) were biochemically synthesized on the surface of PMNCs for better efficiency to absorb anti-*Salmonella* aptamers. The 3, 3'-Dithiodipropionic acid di(N-hydroxysuccinimide ester (DTSP) was used to cross-link the AuNPs and the aptamers. The final product of the aptamers/GOx<sub>ext</sub>/AuNPs/MBs-GOx@PDA PMNCs could carry the target bacteria and be magnetically attracted to the surface of the screen-printed interdigitated electrode (SP-IDME) for measurement. The redox probe containing glucose could recognize the current changes caused by the attachment of *S. Typhimurium* cells. The electrochemical aptasensor in this study exhibited short detection time, good specificity, reproducibility, and stability for detection of *S. Typhimurium*. It is expected to find more applications for in-field detection of foods.

### **6.2 Introduction**

*Salmonella* is a genus of gram-negative bacteria of the Enterobacteriaceae family, and there are over 2500 serotypes of *Salmonella*. *S. Enteritidis* and *S. Typhimurium* are the two most common causes for human infections in the US. *S. Typhimurium* in human does not commonly cause fatal disease, and symptoms usually include diarrhea, abdominal cramps, vomiting and

nausea, and can last up to last days. However, if immune-impaired people like infants (especially under age of 5) and elders do not receive appropriate antibiotic treatment, the disease can become invasive into the blood stream, spreading to other body sites, and eventually can lead to death (Scallan *et al.*, 2011). CDC estimates there are about 1.1 million cases of *Salmonella* infections and around 380 deaths occurred due to the contaminated food by non-typhoidal *Salmonella* each year in the US, and it has the highest percentage of hospitalization among all pathogens (CDC, 2011). Most recent events of foodborne outbreaks related to *S. Typhimurium* are: (1) A multistate outbreak of human *S. Typhimurium* infection associated with live poultry in backyard flocks in which 356 people got sick and 62 were hospitalized (CDC, 2013(a)), and (2) A multistate outbreak of *S. Typhimurium* infection associated with ground beef in which 22 cases of illnesses occurred and 7 people were hospitalized (CDC, 2013(b)).

Even though there have been many legislations, regulations, and methodical programs established to reduce the occurrence of foodborne pathogens in food, the methods for sensitive, rapid, and reliable detection of these pathogens are still critical. Currently, cultural, immunological (ELISA) and molecule (PCR) based conventional methods for the identification and enumeration of foodborne pathogens are still the most commonly practiced techniques in the food safety area (Lazcka *et al.*, 2007). The culture-based methods may take up to five days to obtain a presumptive positive isolate because of time-consuming procedures like pre-enrichment, media growth, identifications (Bell *et al.*, 2016). Therefore, even with the latest automated systems which allow multiple samples to be simultaneously tested, the confirmation of the target pathogens may require at least 24 h. ELISA-based methods, based on the specific interaction between antigens and antibodies, have major drawbacks such as complicated washing steps and insufficient sensitivity (Zhu *et al.*, 2014). Molecule, especially polymerase chain reaction (PCR),

based methods show high level of specificity and sensitivity because this type of methods is based on the detection of nucleic acid sequences of target bacteria, and the specifically designed short synthetic oligonucleotides can solely hybridize to these target sequences that are complementary to each other (Levin, 2009). However, from the perspective of the food industry, PCR based methods are less attractive for routine detection of foodborne pathogens because these tests are expensive and complicated, requiring skilled workers to carry out the tests in a laboratory. In order to achieve rapid and sensitive detection of *S. Typhimurium*, biosensor-based methods have been studied intensively as the alternatives to replace the conventional methods, because these biosensors show great advantages of easy-to-use, short response time, low cost, and possibility of miniaturization (Afonso *et al.*, 2013; Liébana *et al.*, 2009).

To date, most of biosensors are still based on natural biorecognition elements such as antibodies because their excellent binding affinity and selectivity for antigens and the techniques to produce these antibodies are sophisticated and reliable (Chen *et al.*, 2016; Palaniappan *et al.*, 2013; Pressman & Grossberg, 1970). However, limitations have been observed for biosensors based on natural biorecognition elements. First, these components exhibit the binding affinity to the target analyte due to their complicated functional groups which are fragile but required to be sterically intact. The denaturation/deactivation of these natural biomolecules can occur when exposing to common working environment, which will affect their performance and shelf-life (Zhou *et al.*, 2010). Moreover, the techniques used to produce these biorecognition elements are resource and time consuming, which results in high cost to fabricate biosensors based on approaches using these biomolecules (Steinmeyer & McCormick, 2008). Therefore, there have been increasing attention to other alternative synthetic biorecognition elements in the development of biosensors.

Aptamers, defined as single-stranded nucleic acid ligands (DNA or RNA), are termed as “chemical antibodies” in many scenarios due to their comparable binding affinity and specificity for the target analyte to that of antibody/antigen interaction (Dong *et al.*, 2014; Ferreira *et al.*, 2006). There are several advantages to use aptamers over antibodies for the fabrication of biosensors. First, the technique used to obtain these oligonucleotide ligands is called systematic evolution of ligands by exponential enrichment (SELEX), which involves a series of consecutive cycles of *in vitro* chemical selection from a random nucleic acid library (Tuerk & Gold, 1990). This technique eliminates the necessity of using *in vivo* immunization of animals which is used to produce antibodies. Therefore, aptamers are easy and cheap to reproduce by chemical synthesis once the sequence of the aptamers is obtained from SELEX. Moreover, aptamers are reversible to its original conformational structure for temperature insulating, and thus are stable for long-term storage and less subject to denaturation in harsh environment (Chen *et al.*, 2016). However, as advantageous as it can be, aptamers integrated into their own aptamer-based methods for whole-cell detection of foodborne pathogens are still under-developed and have much potential to be explored (Amaya-González *et al.*, 2013).

Electrochemical biosensors, as a type of biosensors using electrical transduction mechanism, show highest expectations than other biosensor counterparts for the construction of miniature, low-cost, easy-to-use devices that can be applied for in-field detection of foodborne pathogens (Lazcka *et al.*, 2007; Melo *et al.*, 2016; Palchetti & Mascini, 2008). The common detection strategies used to fabricate electrochemical biosensors are label-based and label-free methods. These two strategies both present their own advantages such as label-based methods usually have better specificity and labels (enzymes, metallic nanoparticles, or conductive polymers) can offer effective signal amplification, whereas label-free methods have more simple procedures, less

detection time, and integration of whole device into single test strip. However, despite all these advantages, electrochemical biosensors also have some drawbacks that limit their applications in the area of food safety. Label-based electrochemical biosensors have successive steps for capturing and labelling the target bacteria, which require multiple washing procedures and long time. The label-free methods usually show higher background noise, more limitation when dealing with food samples, and probably higher LODs than label-based ones (Table 3.2). Therefore, more advanced electrochemical biosensors are demanded for the detection of foodborne pathogens.

As presented in our previous work (Xu *et al.*, 2016), the bifunctional magnetic polymeric nanocomposites (PMNCs) showed advantageous characteristics in the development of an electrochemical biosensor for the detection of *E. coli* O157:H7. In this study, we extended the application of this concept for the detection of *S. Typhimurium* using ssDNA aptamers as the biorecognition element and screen-printed interdigitated microelectrode (SP-IDME) with a permanent magnet underneath for amperometric measurement. The gold nanoparticle (AuNPs)/magnetic beads (MBs)-glucose oxidase (GOx)@polydopamine (PDA) nanocomposites were synthesized using the same procedures as described in the previous work. Then 3,3'-Dithiodipropionic acid di(N-hydroxysuccinimide ester) (DTSP) was used to add carboxyl group on the AuNPs for further functionalization. The amine-aptamers were used to bind with the DTSP/AuNPs/MBs-GOx@PDA PMNCs, and later to capture *S. Typhimurium*. After the target bacteria were captured and isolated, a redox solution containing glucose was used as the probe for measurement. The magnetic PMNCs were attracted to the surface of SP-IDME due to the magnet beneath the electrode. The attachment of the target bacteria blocked the charge transfer between the redox pair, the glucose/glucose oxidase, and the electrode, therefore decreased the



current responses. The developed electrochemical biosensor still processed good qualities like less detection time, less restriction to be used in complex solutions, and effective amplification. This study proved that the bifunctional PMNCs can be a powerful platform to fabricate rapid and sensitive electrochemical biosensors for the detection of foodborne pathogens.

## **6.3 Experimental**

### **6.3.1 Materials and apparatus**

Phosphate buffered saline 1 (PBS1, 0.1 M, pH 7.4), dopamine (DA), DTSP, gold (III) chloride hydrate, potassium ferrocyanide (II), potassium ferricyanide (III), glucose, and glucose oxidase (128, 200 U/g solid) were bought from Sigma-Aldrich (St. Louis, MI). PBS2 (10 mM, pH 7.4) solution was prepared by diluting PBS1 at a ratio of 1:10, and used throughout all tests. The ultrapure deionized water (18.2 M $\Omega$ ·cm) was obtained from Milli-Q (EMD Millipore, Billerica, MA). The GOx was biotinylated based on the protocol reported by Kanayeva *et al.* (2012) using sulfo-NHS-biotin, and excessive biotin was removed with a Slide-A-Lyzer dialysis kit from Pierce Protein Research Product (10K MWCO, Rockford, IL). Streptavidin-coated magnetic beads with a diameter of 150 nm were manufactured by Ocean NanoTech, LLC (San Diego, CA). Based on the information provided by the company, the superparamagnetic MBs contain 1 mg/ml solid content (Fe) with  $2.7 \times 10^{11}$  particles/mg. The surface of MBs was covalently modified by streptavidin with binding capacity for biotin-BSA or biotin-IgG of over 50  $\mu$ g per mg or per ml.

The electrochemical analysis was conducted with a CHI750B electrochemical workstation manufactured by CH Instruments (Bee Cave, TX). A BDI handheld electrochemical detector (BioDetection Instruments Inc., Fayetteville, AR) was used for amperometric measurement. The bare SP-IDME, which was designed by our group and customized by DropSens (Llanera, Spain),

was described in Chapter 4. The width of the gold fingers and the spacing between each two fingers are both 200  $\mu\text{m}$ . The active area of the gold fingers is about 12.38  $\text{mm}^2$  (Fig. 4.2). The MS0206 magnetic separator with a magnetic strength of approximately 1.0 Tesla (T) was purchased from Aibit LLC (Jiangyin, China).

The amine aptamer nucleotide sequence for *S. Typhimurium* was synthesized by Integrated DNA Technologies Inc (IDT, Coralville, IA). The ssDNA sequence of the aptamer was 5'-NH<sub>2</sub>-C<sub>6</sub>-CAG TCC AGG ACA GAT TCG CGA GCC CAC TCC AAA CAC GAC CAA CTC ACG CTC TAT CAA CAT CGC TAT CCA CGT GGA TTT CAT TCA GCG ATT-3', which was selected using systematic evolution of ligands by exponential enrichment (SELEX) methods in our lab. 100 nmol of aptamer was dissolved in 100  $\mu\text{l}$  of PBS2 (1 mM) and stored at 4 °C for further use. Stock bacterial cultures of *S. Typhimurium* (ATCC 14028) and *E. coli* O157:H7 (ATCC 43888) were obtained from American Type Culture Collection (ATCC, Manassas, VA). The stock cultures were stored at -80 °C, and revived gently at room temperature when needed.

### **6.3.2 Methods for culture preparation and media plating enumeration**

The test cultures of *S. Typhimurium* were prepared by growing the stock cultures in brain heart infusion (BHI) broth (Remel Microbiology Products, Lenexa, KS) at 37 °C for 16-18 h. A series of 1:10 dilutions for each bacterial culture were made with PBS2. To determine the viable cell numbers of tested bacteria, 100  $\mu\text{l}$  of each dilution were plated onto the surface of either non-selective Trypsin Soy Agar (TSA) or selective Xylose-Lysine-Tergitol 4 (XLT4) agars. The number of bacterial colonies formed on the media after incubation at 37 °C for 18 to 24 h was counted to determine the concentration of viable bacteria cells in the terms of colony forming units per milliliter (cfu/ml). All the cultures were prepared on the test days.

### **6.3.3 Preparation of bifunctional PMNCs**

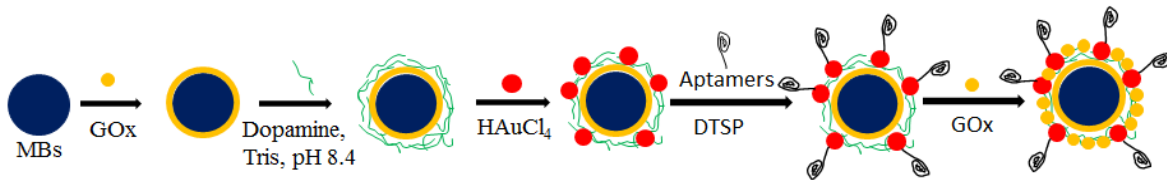

Figure 6.1. The schematic illustration of the aptamers/ $\text{GOx}_{\text{ext}}$ /AuNPs/MBs-GOx@PDA PMNCs synthesis.

The procedure to synthesize the magnetic PMNCs was similar to what described in section 5.3.4. The schematic description of the preparation of the PMNCs is shown in Fig. 6.1. First, 50  $\mu\text{l}$  of streptavidin-coated MBs were washed with 200  $\mu\text{l}$  of PBS2 to remove the preservative content in 1.5 ml protein low binding tubes (SARSTEDT AG & Co., Germany) and magnetically separated with the magnetic separator for 3 min. The supernatant was removed with a pipette carefully (magnetic separation procedures were the same below unless specifically mentioned). Second, the remains were mixed into 150  $\mu\text{l}$  of PBS2 and 50  $\mu\text{l}$  of biotin-GOx (excessive) and rotated at 15 rpm and room temperature (RT) for 1 h. After the rotation finished, the yielded mixture was magnetically separated and re-dispersed into 400  $\mu\text{l}$  of 0.5 mg/ml DA (final concentration) in Tris buffer (pH 8.4, 10 mM). The mixture was rotated for another 1 h to allow self-polymerization, yielding a suspension of the MBs-GOx@PDA biocomposites. After magnetic separation, the remaining biocomposites were rinsed with PBS2 three times and ultrasonically re-dispersed into 400  $\mu\text{l}$  of PBS2. Third, the synthesis of AuNPs was based on similar method used by Fu *et al.* (2010). Briefly, 0.20 mM  $\text{HAuCl}_4$  (in PBS2, pH 7.4) and 5 mg/ml of glucose (both final concentration) were successively mixed into the yielded suspension for 5 h at RT to allow biochemical synthesis of AuNPs on the surface of the MBs-GOx@PDA biocomposites. The dispersion of AuNPs on the surface of MBs-GOx@PDA PMNCs was intended to facilitate the further modification with aptamers. The AuNPs/MBs-GOx@PDA PMNCs were magnetically separated and mixed with 10 mM DTSP (in PBS2) at RT for 5 h.

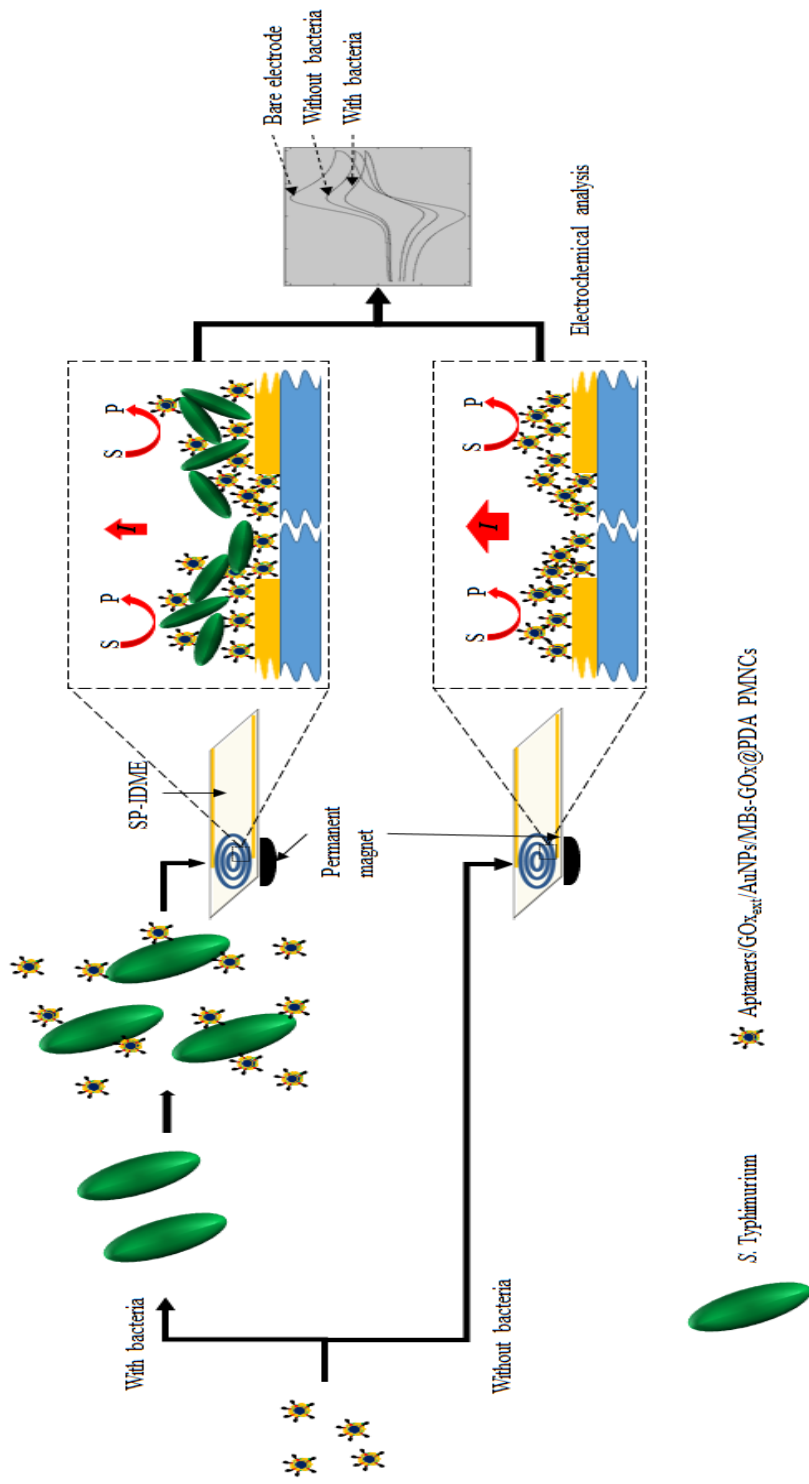

Figure 6.2. The construction of the electrochemical biosensor for the detection of *S. Typhimurium*.

Finally, the synthesized AuNPs/MBs-GOx@PDA biocomposites were suspended into the solution containing excessive anti-*Salmonella* aptamers overnight at 4 °C. After magnetic separation, the aptamers/AuNPs/MBs-GOx@PDA PMNCs were mixed with 5 mg/ml GOx for 1 h at room temperature to block the unspecific attachment and to allow additional load of enzyme on the PMNCs. The prepared aptamers/GO<sub>x</sub><sub>ext</sub>/AuNPs/MBs-GOx@PDA PMNCs were stored at 4 °C when they were not in use.

#### **6.3.4 Construction of the electrochemical aptasensor for the detection of *S. Typhimurium***

As illustrated in Fig. 6.2, the construction and mechanism of the electrochemical biosensor are described as follows. First, after blocking with GOx, the aptamers/GO<sub>x</sub><sub>ext</sub>/AuNPs/MBs-GOx@PDA PMNCs were thoroughly washed with PBS2 three times and ultrasonically dispersed in PBS2 each time. Second, the final aptamers/GO<sub>x</sub><sub>ext</sub>/AuNPs/MBs-GOx@PDA PMNCs were mixed with 200 µl of *S. Typhimurium* dilutions with controlled concentrations for 45 min at RT to capture of the target bacteria. Third, the PMNCs-cell conjugates were magnetically separated, washed with PBS2 three times, and suspended in 50 µl of 10 mM redox solution containing 10 mM glucose. Then, All 50 µl of the suspension were dropped onto the bare SP-IDME for electrochemical analysis. Both cyclic voltammetry (CV) and amperometric detection were used to characterize and detect different concentrations of target bacteria.

The specificity of the constructed biosensor was investigated by testing other non-target bacteria, such as *E. coli* O157:H7 and *E. coli* K12. The concentration of the target and the non-target bacteria tested was 10<sup>5</sup> cfu/ml.

The statistical analysis of data, such as the mean, the standard deviation, and linear regression relationship, was performed using Excel 2010 software (Microsoft, Redmond, WA) with at least three replications for experiments.

## 6.4 Results and discussion

### 6.4.1 Characteristics of the developed electrochemical aptasensor for the detection of *S.*

#### Typhimurium

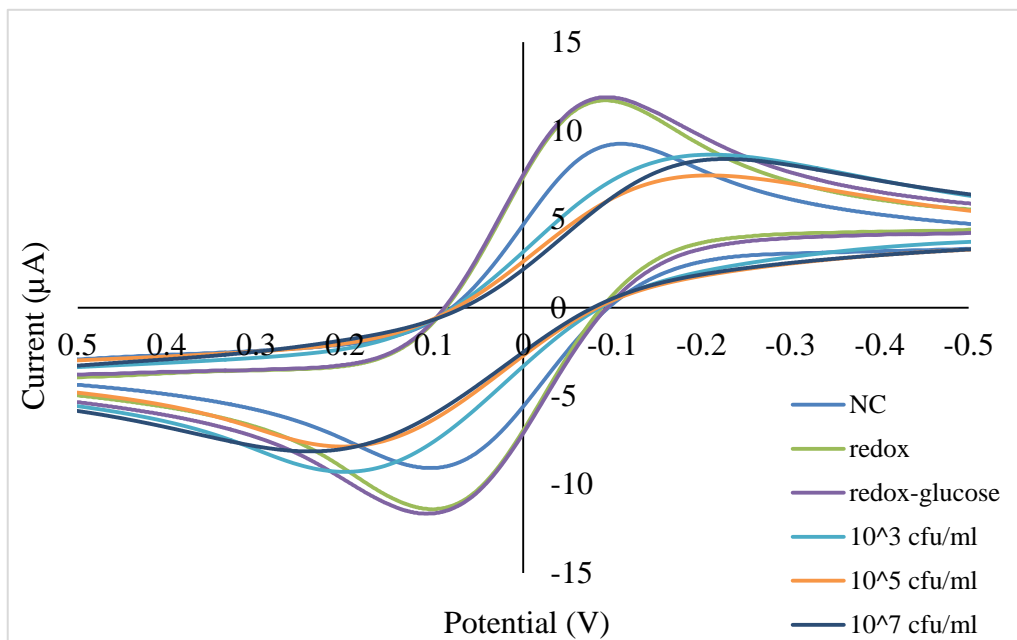

Figure 6.3. The characteristics of the developed electrochemical aptasensor when testing different analytes.

To demonstrate the feasibility of the developed electrochemical aptasensor, CV was used first for different setups from -0.5 V to 0.5 V at scanning rate of 0.5 V/s (Fig. 6.3). From the figure, there was a clear redox peak at  $E_{\text{peak}} = -0.1\text{V}$ . The curves of pure redox solution and the redox solution containing glucose were almost identical, indicating the glucose was not altered without the presence of GOx in this electrochemical system. After absorbing only the magnetic PMNCs (NC), a significant decrease in current response at  $E_{\text{peak}}$  was observed, which was caused by the attachment of PMNCs on the surface of SP-IDME that blocked the redox pair to contact the electrode. At this stage, even though the glucose was still catalyzed by GOx in the PMNCs, the charge transfer facilitated by the enzymatic reaction was much less influential comparing to the blockage of the redox pair. When there were bacterial cells captured by the PMNCs and

attracted to the surface of the electrode, the pathways of charge transfer for redox pair and glucose catalysis were both hindered, which induced a further decrease in the current response comparing to NC. The higher concentration of the target pathogen led to lower current response. The details of current responses for different measured samples at  $E_{\text{peak}} = -0.1\text{V}$  by CHI electrochemical workstation are given in Table 6.1.

#### 6.4.2 Amperometric aptasensor for the detection of *S. Typhimurium* by a handheld electrochemical detector

Table 6.1 The current response at  $E_{\text{peak}}$  for different analytes.

Sample	$E_{\text{peak}}$ (V)	$I$ ( $\mu\text{A}$ )
Redox	-0.1	11.68
Redox-glucose		11.88
NC		9.22
$10^3$ cfu/ml of <i>S. Typhimurium</i>		7.29
$10^5$ cfu/ml of <i>S. Typhimurium</i>		6.17
$10^7$ cfu/ml of <i>S. Typhimurium</i>		6.22

After the developed electrochemical aptasensor was characterized using CV, the amperometric measurement (at  $-0.1\text{ V}$ ) to detect different concentration of *S. Typhimurium* in pure cultural samples was conducted using the BDI handheld electrochemical detector. The results are shown in the Fig. 6.4. The current response by the handheld detector was well fitted into a simple linear relationship with the log concentration of *S. Typhimurium* in the range of  $10^2$  to  $10^6$  cfu/ml ( $R^2 = 0.96$ ). The current response of NC was  $8.38 \pm 0.33 \mu\text{A}$ . Base on the

signal/noise ratio of three ( $S/N = 3$ ), the LOD was determined to be  $10^{1.98}$  cfu/ml (96 cfu/ml).

This is comparable to some of the reported biosensors listed in Table 3.2.

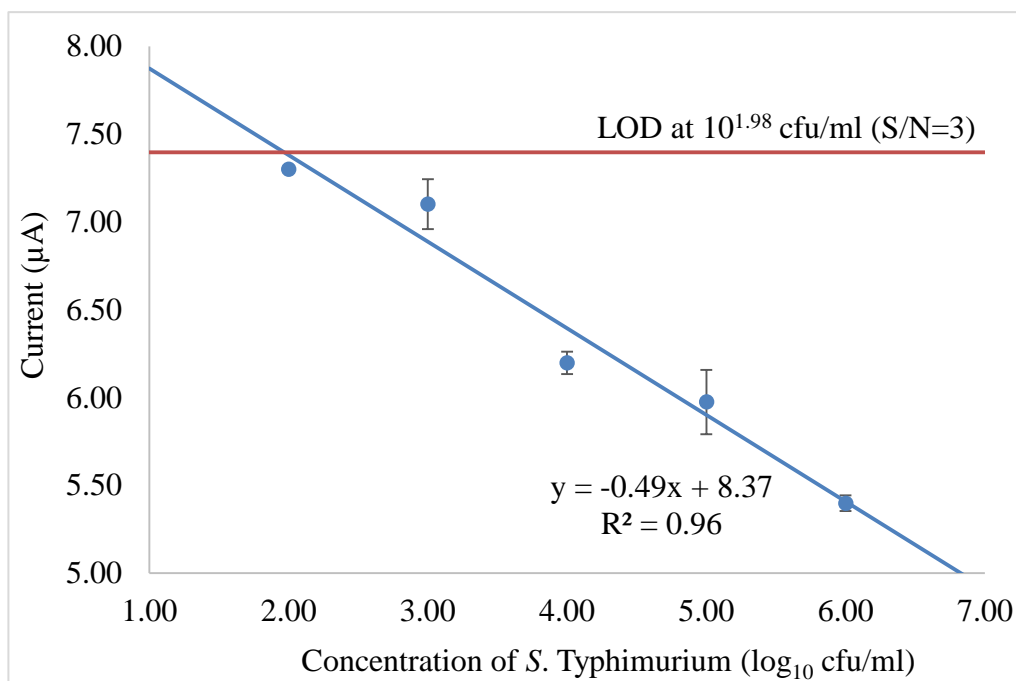

Figure 6.4. The calibration curve of the handheld electrochemical detector for amperometric measurement of different concentrations of *S. Typhimurium*.

The advantages of the developed electrochemical aptasensor comparing to those in Table 3.2 were several. First, the bifunctional magnetic PMNCs serving as both the carrier and amplifier really shortened the detection time and simplified the test procedures. The whole detection process (from the binding of the target pathogen to the signals obtained) was done within 1 h, and the entire detection procedure only involved the binding, three times of washing, and measurement steps, which was very easy to handle. Second, the SP-IDME used was not surface-modified. Therefore, it was easy to preserve the best condition comparing to other electrodes modified with complex chemical/biochemical materials used in most of label-free electrochemical biosensors. This could improve the shelf-life of the developed aptasensor.



Despite of all the merits of the developed electrochemical aptasensor, some improvements could be done for better performance. First, the capture efficiency of this aptamer using magnetic separation was not satisfying. Large portion of the bacterial cells would be lost during the separation process. The reason could be the size of the aptamers was too small comparing that of a bacterial cell, causing that the connection between the aptamers and the bacterial cell was interrupted by the magnetic force. Second, even though to date the SP-IDME used in this study was fabricated at the smallest scale, the size of the gold fingers and the gap between two fingers were still too large comparing to the size of a bacterial cell. When the magnetic PMNCs-bacterial cell conjugates were attracted to the surface of the electrode, some of them were attached to the gap area, which caused them to generate smaller effective signals comparing to those attached to the surface of gold fingers. Finally, the free magnetic PMNCs were not separated from the bonded PMNCs like that had been done in chapter 5. The free PMNCs were also attracted to the

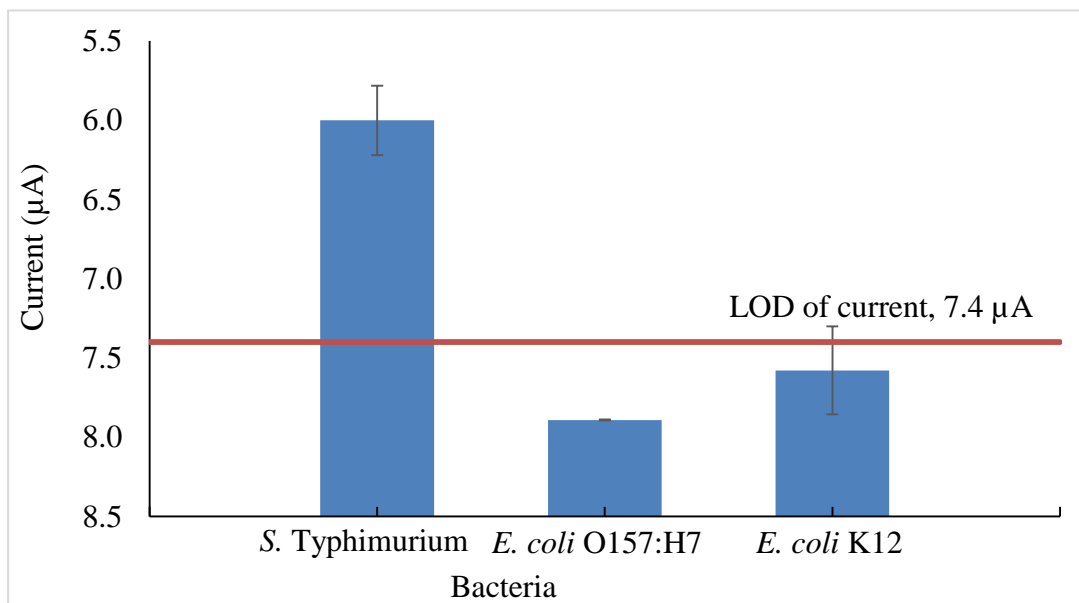

Figure 6.5. The specificity of the developed electrochemical aptasensor for the detection of *S. Typhimurium*.

surface of the electrode, leading to an increase of the background noise in electrochemical measurement. Along with the improvements in the techniques used in this study, the performance of the developed aptasensor would also be improved.

### **6.4.3 The specificity of the developed electrochemical aptasensor for the detection of *S.***

#### **Typhimurium**

To demonstrate the developed electrochemical aptasensor to specifically detect *S.* Typhimurium, non-target bacteria, *E. coli* O157:H7 and *E. coli* K12, were tested at  $10^5$  cfu/ml using the same protocol. The current responses of *S.* Typhimurium and other two non-target bacteria are shown in Fig. 6.5. Comparing to the differences of current response to NC ( $8.38 \pm 0.33 \mu\text{A}$ ), the current response of *S.* Typhimurium ( $6.00 \pm 0.22 \mu\text{A}$ ) was significantly lower than that of the non-target bacteria, *E. coli* O157:H7 ( $7.89 \pm 0.01 \mu\text{A}$ ) and *E. coli* K12 ( $7.58 \pm 0.28 \mu\text{A}$ ). It indicates that the synthesized PMNCs could specifically capture *S.* Typhimurium, thus the results showed a higher degree of hindrance to the electron transfer at the electrode surface whereas the non-target bacteria were not captured and not influential to the electron transfer.

### **6.5 Conclusions**

In this study, an electrochemical aptasensor was developed based on the previous reported bifunctional PMNCs for the detection of *S.* Typhimurium using ssDNA aptamers as the biorecognition element and screen-printed interdigitated microelectrodes (SP-IDME) with a permanent magnet underneath for amperometric measurement. The synthesized aptamers/ $\text{GO}_{\text{ext}}$ /AuNPs/MBs-GOx@PDA PMNCs was demonstrated to be able to generate current responses that were linearly related to the log concentration of *S.* Typhimurium. The LOD of the developed aptasensor was 96 cfu/ml within less than 1 h without any pre-enrichment procedures. The developed electrochemical biosensor still processed good qualities like short

detection time, capable of being used to directly detect the target pathogen in solution, and effective signal amplification by blocking the electron transfer in the reduction-oxidation process of both the redox pair and the glucose. The use of a handheld electrochemical detector demonstrated the possibility of the developed aptasensor for use in the in-field applications. This study proved that the bifunctional PMNCs can be a powerful platform to fabricate rapid and sensitive electrochemical biosensors for the detection of foodborne pathogens.

## 6.6 References

- Afonso, A. S., B. Pérez-López, R. C. Faria, L. H. C. Mattoso, M. Hernández-Herrero, A. X. Roig-Sagués, M. M. Costa, and A. Merkoçi. 2013. Electrochemical detection of *Salmonella* using gold nanoparticles. *Biosens. Bioelectron.* 40: 121-126.
- Amaya-González, S., N. de-los-Santos-Álvarez, A. J. Miranda-Ordieres, and M. J. Lobo-Castañón. 2013. Aptamer-based analysis: a promising alternative for food safety control. *Sens.* 13: 16292-16311.
- Bell, R. L., K. G. Jarvis, A. R. Ottesen, M. A. McFarland, and E. W. Brown. 2016. Recent and emerging innovations in *Salmonella* detection: a food and environmental perspective. *Microbial Biotechnol.* 9: 279-292.
- CDC, Centers for Disease Control and Prevention. 2011. CDC 2011 estimates: Findings. Available at: <http://www.cdc.gov/foodborneburden/2011-foodborne-estimates.html>. Accessed on June 2016.
- CDC, Centers for Disease Control and Prevention. 2013(a). Multistate Outbreak of Human *Salmonella* Typhimurium Infections Linked to Live Poultry in Backyard Flocks. Available at: <http://www.cdc.gov/salmonella/typhimurium-live-poultry-04-13/index.html>. Accessed on June 2016.
- CDC, Centers for Disease Control and Prevention. 2013(b). Multistate Outbreak of *Salmonella* Typhimurium Infections Linked to Ground Beef. Available at: <http://www.cdc.gov/salmonella/typhimurium-01-13/index.html>. Accessed on June 2016.
- Chen, H., J. Huang, A. Palaniappan, Y. Wang, B. Liedberg, M. Platt, and A. L. Y. Tok. 2016. A review on electronic bio-sensing approaches based on non-antibody recognition elements. *Analyst* 141: 2335-2346.
- Dong, Y., Y. Xu, W. Yong, X. Chu, and D. Wang. 2014. Aptamer and its potential applications for food safety. *Crit. Rev. Food Sci. Nut.* 54: 1548-1561.

- Ferreira, C. S., C. S. Matthews, and S. Missailidis. 2006. DNA aptamers that bind to MUC1 tumour marker: design and characterization of MUC1-binding single-stranded DNA aptamers. *Tumour Biol.* 27(6): 289-301.
- Fu, Y., P. Li, L. Bu, T. Wang, Q. Xie, X. Xu, L. Lei, C. Zou, and S. Yao. 2010. Chemical/biochemical preparation of new polymeric bionanocomposites with enzyme labels immobilized at high load and activity for high-performance electrochemical immunoassay. *J. Phys. Chem. C* 114: 1472-1480.
- Kanayeva, D. A., R. Wang, D. Rhoads, G. F. Erf, M. K. Slavik, S. Tung, and Y. Li. 2012. Efficient separation and sensitive detection of *Listeria monocytogenes* using an impedance immunosensor based on magnetic nanoparticles, microfluidics and interdigitated microelectrode. *J. Food Prot.* 75: 1951-1959.
- Lazcka, O., F. J. D. Campo, and F. X. Munoz. 2007. Pathogen detection: A perspective of traditional methods and biosensors. *Biosens. Bioelectron.* 22: 1205-1217.
- Levin, R. E. 2009. The use of molecular methods for detecting and discriminating *Salmonella* associated with foods- A review. *Food Biotechnol.* 23: 313-367.
- Liébana, S., A. Lermo, S. Campoy, M. P. Cortés, S. Alegret, and M. I. Pividori. 2009. Rapid detection of *Salmonella* in milk by electrochemical magneto-immunosensing. *Biosens. Bioelectron.* 25: 510-513.
- Melo, A. M. A., D. L. Alexandre, R. F. Furtado, M. F. Borges, E. A. T. Figueiredo, A. Biswas, H. N. Cheng, and C. R. Alves. 2016. Electrochemical immunosensors for *Salmonella* detection in food. *Appl. Microbiol. Biotechnol.* 100: 5301-5312.
- Palaniappan, A., W. H. Goh, D. W. Fam, G. Rajaseger, C. E. Chan, B. J. Hanson, S. M. Moochhala, S. G. Mhaisalkar, and B. Liedberg. 2013. Label-free electronic detection of bio-toxins using aligned carbon nanotubes. *Biosens. Bioelectron.* 43: 143-147.
- Palchetti, I., and M. Mascini. 2008. Electroanalytical biosensors and their potential for food pathogen and toxin detection. *Anal. Bioanal. Chem.* 391: 455-471.
- Pressman, D., and A. L. Grossberg. 1970. Structural basis of antibody specificity. *Immunologic methods in steroid determination.* 1-14. Peron, F. G., and B. V. Caldwell. Berlin, Germany: Springer.
- Scallan, E., R. M. Hoekstra, F. J. Angulo, R. V. Tauxe, M.-A. Widdowson, S. L. Roy, J. L. Jones, and P. M. Griffin. 2011. Foodborne illness acquired in the United States- Major Pathogens. *Emerg. Infect. Dis.* 17(1): 7-15.
- Steinmeyer, D. E., and E. L. McCormick. 2008. The art of antibody process development. *Drug Discovery Today* 13: 613-618.

Tuerk, C., and L. Gold. 1990. Systematic evolution of ligands by exponential enrichment: RNA ligands to bacteriophage T4 DNA polymerase. *Sci.* 249(4968): 505-510.

Xu, M., R. Wang, and Y. Li. 2016. An electrochemical biosensor for rapid detection of *E. coli* O157:H7 with highly efficient bifunctional glucose oxidase-polydopamine nanocomposites and Prussian blue modified screen-printed interdigitated electrode. *Analyst* DOI: 10.1039/C6AN00873A.

Zhou, J., M. R. Battig, and Y. Wang. 2010. Aptamer-based molecular recognition for biosensor development. *Anal. Bioanal. Chem.* 398(6): 2471-2480.

Zhu, D., Y. yan, P. Lei, B. Shen, W. Cheng, H. Ju, and S. Ding. 2014. A novel electrochemical sensing strategy for rapid and ultrasensitive detection of *Salmonella* by rolling circle amplification and DNA-AuNPs probe. *Anal. Chim. Acta* 846: 44-50.

## Chapter 7. Conclusions

In this dissertation three major parts of research were conducted to develop electrochemical biosensors for the detection of foodborne pathogens. *E. coli* O157:H7 and *S. Typhimurium* were chosen as the model bacteria targets because their significance regarding to the food safety.

The first developed immunosensor was based on a sandwich-like immunoassay and bare screen-printed interdigitated microelectrodes for the detection of *E. coli* O157:H7 and *S. Typhimurium*. In this study, the 130 nm MBs were conjugated with antibodies specifically targeting the bacteria of interest, and had achieved high capture efficiencies. Then the antibody-conjugated GOx was used to label the bacterial cells and converted the antibody-antigen interaction into the electrochemical signal. The electrochemical impedance analysis was used and revealed a simple linear relationship of the impedance changes versus the log concentration of bacteria in a broad range from  $10^2$  to  $10^6$  cfu/ml for both pathogens. The developed impedance immunosensor demonstrated that it can detect both of the target bacteria at  $10^3$  cfu/ml with the detection time of 2 h without any pre-enrichment procedures. This immunosensor gave up the strategy of using complicated immobilization procedures that attach the bioreceptors on the surface of electrodes, reducing the cost to fabricate the biosensor. Moreover, comparing to other label-free immobilization-based impedimetric biosensors reported previously, the advantages of this immunosensor include (1) good reproducibility and regenerability because the electrodes were not modified by any biochemical molecules, (2) the reactions between the MBs-Abs conjugates and the bacterial cells, the bacterial cells and the Ab-GOx conjugates occurred in the solution which allowed more effective binding process regarding time and capture efficiency. Therefore, even though the LOD of this immunosensor was not significantly lower than other label-free impedance sensors, it is more suitable for in-field applications for the detection of

foodborne pathogens. However, this immunosensor still needs to be improved. First, the electrochemical signal for measurement was generated through glucose oxidation, whereas the number of GOx per bacterial cell was not high enough. Not only the Ab-GOx conjugates needed to compete with MBs-Abs conjugates for the binding sites on the cell surface, but also the ratio of GOx to Abs in each labelling conjugates was low (estimated to be 1:1 based on the protocol of the conjugation kit). If more GOx could be attached to a single bacterial cell, the sensitivity of the immunosensor could be significantly improved. Second, the background noise needed to be reduced. In order to achieve lower LODs for the target bacteria, the electrochemical measurement was done in the ultrapure water solution which had very low ion-strength. Therefore, a tiny trace of ion introduced into the solution could alter the impedance value enormously. This problem increased the complexity of the operation with the requirement for multiple washing steps to remove interfering salt in the original solution, as well as reduced the precision of the test results because the unavoidable interfering ions brought by the operation could easily affect the results. It also requires the technicians who handle the test operation to be very skilled and trained if this immunosensor is applied for in-field applications.

Based on the performance of the first impedance immunosensor, the second electrochemical biosensor was designed and fabricated based on a bifunctional polymeric nanocomposites that worked as the vehicle to isolate and concentrate the target *E. coli* O157:H7 as well as the transducer that convert the biological recognition event to electrochemical signals. The synthesized bifunctional Abs/GO<sub>x</sub><sub>ext</sub>/AuNPs/MBs-GOx@PDA PMNCs contained high load of enzyme could effectively make the transduction to yield low LOD for the pathogen of interest when coupled with PB-modified SP-IDME. This immunosensor also exhibited comparable detection time to other label-free biosensors due to the integration of the capture and the

labelling procedures. The developed immunosensor achieved a simple linear relationship to specially detect *E. coli* O157:H7 in a broad detection range from  $10^2$  to  $10^6$  cfu/ml and a low LOD of 52 cfu/ml (taking the sample size of 200  $\mu$ l into consideration, it means the sensor can detect as low as 10 cfu in a sample) in the pure culture with the detection time of 1 h. Moreover, the validation of using this bifunctional PMNCs-based method with a handheld amperometric detector to detect the target pathogen in food sample proved the feasibility of applying this method for in-field applications. The advantages of the developed immunosensor are (1) the biorecognition element (antibody) and the transduction element (GOx) were combined into the PMNCs, allowing for the attachment of multiple GOx on every antibody-antigen binding site, which is very efficient for the electrochemical transduction; (2) the operating procedures are almost as simple as the label-free biosensors. The integration of the biorecognition and the transduction events significantly shortened the detection process; and (3) the SP-IDME was modified with PB film through a simple electrochemical deposition which ensured the reproducibility and repeatability of the electrodes. This is very suitable for a design of disposable screen-printed electrodes to construct a portable biosensing device.

After the development of the second electrochemical biosensor for the detection of *E. coli* O157:H7, the concept of bifunctional PMNCs for effective cell isolation and signal amplification was extended to design and fabricate the third electrochemical aptasensor for the detection of *S. Typhimurium*. The core component of GOx<sub>ext</sub>/AuNPs/MBs-GOx@PDA in the PMNCs was maintained but the biorecognition element was changed to aptamers which are “chemical antibodies” selected by *in vitro* SELEX. The electrochemical measurement was based on the adsorption of bacterial cell-PMNC conjugates by a permanent magnet beneath the active area of the electrode. The attachment of bacterial cells would hinder the electron transfer from both the



redox pair and the glucose oxidation at the electrode surface, which yielded an effective amplification for the electrochemical measurement. The developed electrochemical aptasensor using a handheld electrochemical detector showed a simple linear relationship between the current and the log concentration of *S. Typhimurium* in the range of  $10^2$  to  $10^6$  cfu/ml with LOD of  $10^2$  cfu/ml in the pure culture, and the detection time was less than 1 h. This developed aptasensor showed comparable sensitivity to the second biosensor for *E. coli* O157:H7 and other electrochemical biosensors listed in Table 3.2, proving the feasibility of using the bifunctional magnetic PMNCs to develop biosensors for different pathogens. This aptasensor exhibited advantages such as simple and straight-forward detection steps, minimum washing involved, rapid, and suitable for in-field applications with a handheld electrochemical detector. There were also some drawbacks which limited the performance of the developed electrochemical aptasensor. First, the free PMNCs were not separated from the bonded PMNCs as that was done in the second biosensor. This resulted in higher background noise produced by these free PMNCs. Second, even though to date the SP-IDME used in this research is in its smallest scale that the screen-printing technique can reach in electrode fabrication, the width and interval of gold fingers in the active area are still too large. This resulted in that part of the bacterial cell-PMNC conjugates was attached to the ceramic substance of the electrode and did not produce influential signals.

The biosensors developed in this research have shown promising concepts of electrochemical methods for the detection of foodborne pathogens. If comparing all three developed biosensors in this research, it can be seen that the concept of the bifunctional magnetic PMNCs has greatly improved the performance of the biosensor with more rapid process and lower LOD for the detection of target pathogens. The concept can also be easily adapted to detect other pathogens if

other antibodies/aptamers with corresponding specificity are available. By coupling with inexpensive, mass-producible bare or PB-modified SP-IDMEs, the developed electrochemical biosensors have great potential for in-field applications.

## Chapter 8. Recommendation for future research

Further development of the biosensors can be proceeded based on the following aspects to improve the performance:

1) For the bifunctional PMNCs, the shelf life over a span of several months should be tested to determine whether the PMNCs are feasible and practical to be used for in-field applications;

2) For the bifunctional PMNCs based electrochemical biosensor, replacing the filtration procedure with other separation methods such as magnetophoresis, especially if integrated with microfluidic channel, could very likely increase the sensitivity of the biosensor, reduce the detection time, and become totally automated;

3) For the bifunctional PMNCs based electrochemical biosensor, the layer-by-layer assembled PMNCs may be able to extend with additional layers of GOx and AuNPs. The optimization of PMNCs on the size of the core MBs and the number of layers can be conducted to see if smaller MBs with more layers of GOx could improve the sensitivity of the biosensor;

4) The binding capacity of the bifunctional PMNCs or MBs on single bacterial cell could be determined. Techniques such as immunofluorescence can be used to estimate the number of antigens on the surface of bacterial cells. The information regarding the binding sites on bacterial cells can help on the optimization of developed electrochemical biosensors;

5) For the bifunctional PMNCs based electrochemical biosensor, it would be informative to expand the bacteria of interest to various foodborne pathogens by using different specific antibodies. Furthermore, the application of the handheld electrochemical detector should also expand to detect the target pathogens in different food samples.