



2017-08-01

# Analysis of Differential Equations Applications from the Coordination Class Perspective

Omar Antonio Naranjo Mayorga  
*Brigham Young University*

Follow this and additional works at: <https://scholarsarchive.byu.edu/etd>

---

## BYU ScholarsArchive Citation

Naranjo Mayorga, Omar Antonio, "Analysis of Differential Equations Applications from the Coordination Class Perspective" (2017).  
*All Theses and Dissertations*. 6502.  
<https://scholarsarchive.byu.edu/etd/6502>

This Thesis is brought to you for free and open access by BYU ScholarsArchive. It has been accepted for inclusion in All Theses and Dissertations by an authorized administrator of BYU ScholarsArchive. For more information, please contact [scholarsarchive@byu.edu](mailto:scholarsarchive@byu.edu), [ellen\\_amatangelo@byu.edu](mailto:ellen_amatangelo@byu.edu).

Analysis of Differential Equations Applications  
from the Coordination Class Perspective

Omar Antonio Naranjo Mayorga

A thesis submitted to the faculty of  
Brigham Young University  
in partial fulfillment of the requirements for the degree of  
Master of Arts

Steven R. Jones, Chair  
Blake E. Peterson  
Steven R. Williams

Department of Mathematics Education  
Brigham Young University

Copyright © 2017 Omar Antonio Naranjo Mayorga

All Rights Reserved

## ABSTRACT

### Analysis of Differential Equations Applications from the Coordination Class Perspective

Omar Antonio Naranjo Mayorga  
Department of Mathematics Education, BYU  
Master of Arts

In recent years there has been an increasing interest in mathematics teaching and learning at undergraduate level. However, many fields are little explored; differential equations being one of these topics. In this study I use the theoretical framework of Coordination Classes to analyze how undergraduate mechanical engineering students apply their knowledge in the context of system dynamics and what resources and strategies they used; in this subject, students model dynamics systems based on Ordinary Differential Equations (ODEs). I applied three tasks in different contexts (Mechanical, Electrical and Fluid Systems) in order to identify what information was relevant for the students, *readout strategies*; what inferences students made with the relevant information, *causal nets*; and what strategies students used to apply their knowledge in those contexts, *concept projections*. I found that the core problem at projecting their knowledge relied on the causal nets, coinciding with diSessa and Wagner's conjecture (2005). I also identified and characterized three strategies or concept projections students used in solving the tasks: Diagram-based approach, Component-based approach and Equation-based approach.

Keywords: Coordination Class, Differential Equations, Transfer of Learning, Concept Projections

## ACKNOWLEDGMENTS

I would like to express my gratitude to all the people who have helped me through this wonderful adventure of writing my master's thesis. I would like to thank my advisor, Dr. Steven Jones for his immense patience, support and effective advice. I also express my appreciation towards the members of my committee, Dr. Blake Peterson and Dr. Steve Williams for their feedback. I would also like to thank my parents, my daughters and the rest of my family and all the members of the BYU's Mathematics Education Department for their support and motivation. I would like to make special mention to Dr. Cheryl Garn for her advice and support. Lastly, I would like to thank my wife Carolina; her wonderful attitude and support have been a lighthouse in this journey and have uplifted my spirit every time.

## TABLE OF CONTENTS

ABSTRACT .....	ii
ACKNOWLEDGMENTS .....	iii
TABLE OF CONTENTS .....	iv
LIST OF FIGURES .....	vii
LIST OF TABLES .....	ix
CHAPTER 1: RATIONALE .....	1
CHAPTER 2: LITERATURE REVIEW .....	8
Student Understanding of Differential Equations .....	8
Connections between Science/Engineering and Mathematics .....	10
CHAPTER 3: THEORETICAL FRAMEWORK .....	13
Coordination Classes .....	13
Readout Strategies and Causal Nets .....	15
Transfer, Span, and Concept Projection .....	16
Differential Equations and Coordination Classes .....	20
CHAPTER 4: METHODS .....	22
Participants .....	22
Instruments .....	23
Selection of Participants .....	25
Description and Solution of Task 1 .....	26

Description and Solution of Task 2 .....	30
Description and Solution of Task 3.....	33
Potential Readouts and Causal Nets .....	35
Interviews .....	41
Data Analysis.....	42
Stage One.....	43
Stage Two .....	44
Stage Three.....	45
Pilot Study .....	45
CHAPTER 5: RESULTS .....	48
Analysis of Students’ Answers to the Survey .....	48
Analysis of Students’ Written Work for Task 1 .....	51
Task 1 - Zane .....	51
Task 1 – Rebecca.....	58
Task 1 – Harry .....	63
Task 1 - Josh.....	66
Task 1 - Kira.....	70
Summary of the Strategies.....	74
Analysis of Students’ Written Work for Task 2 .....	75
Task 2 – Zane .....	75

Task 2 – Rebecca.....	78
Task 2 – Harry .....	81
Task 2 – Josh .....	83
Task 2 – Kira .....	85
Analysis of Students’ Written Work for Task 3 .....	88
Task 3 – Zane .....	88
Task 3 – Rebecca.....	91
Task 3 – Harry .....	94
Task 3 – Josh .....	96
Task 3 – Kira .....	98
Summary of Results .....	100
CHAPTER 6: DISCUSSION .....	102
Implications for the Coordination Class Theory .....	102
Students’ Learning on Mathematical Concepts .....	104
Students’ Strategies as Concept Projections.....	105
Learning Differential Equations .....	107
Understanding of Students’ Thinking of Differential Equations.....	108
Implications for Transfer of Learning Processes.....	109
Conclusion .....	109
REFERENCES .....	111

## LIST OF FIGURES

<i>Figure 1.</i> Connection between physics, mathematics and system dynamics. ....	11
<i>Figure 2.</i> “Bird”and “Force”concepts. ....	13
<i>Figure 3.</i> Preliminary survey.....	24
<i>Figure 4.</i> Task 1. ....	27
<i>Figure 5.</i> Free body diagram of the pendulum.....	27
<i>Figure 6.</i> Task 2. ....	30
<i>Figure 7.</i> Task 3. ....	33
<i>Figure 8.</i> Mechanical system for the pilot study.....	47
<i>Figure 9.</i> Analysis of a student’s work in a pilot study.....	47
<i>Figure 10.</i> Zane’s initial excerpts from his work on Task 1. ....	52
<i>Figure 11.</i> Zane’s Free Body Diagram of the Pendulum. ....	53
<i>Figure 12.</i> Zane’s ODE. ....	54
<i>Figure 13.</i> Zane’s final expression. ....	54
<i>Figure 14.</i> Zane’s flow of reasoning for task 1. ....	57
<i>Figure 15.</i> Rebecca’s identification of Newton’s Second Law for Task 1. ....	59
<i>Figure 16.</i> Rebecca’s partial ODE. ....	60
<i>Figure 17.</i> Rebecca’s component-based analysis of the system. ....	60
<i>Figure 18.</i> Rebecca’s final ODE. ....	61
<i>Figure 19.</i> Rebecca’s flow of reasoning for task 1.....	62
<i>Figure 20.</i> Harry’s misinterpretation of the pendulum inertia. ....	64
<i>Figure 21.</i> Harry’s partial setting up of the ODE.....	64
<i>Figure 22.</i> Harry’s final ODE. ....	64
<i>Figure 23.</i> Harry’s flow of reasoning for task 1.....	66
<i>Figure 24.</i> Josh first attempt to make sense of the system’s behavior. ....	67
<i>Figure 25.</i> Josh’s preliminar expressions.....	67
<i>Figure 26.</i> Josh’s final expression.....	68
<i>Figure 27.</i> Excerpt from Josh’s discussion about ODE solution techniques. ....	69
<i>Figure 28.</i> Josh’s flow of reasoning for task 1.....	70
<i>Figure 29.</i> Kira’s FBD. ....	71
<i>Figure 30.</i> Kira’s reasoning about the components of the system from the equations. ....	72
<i>Figure 31.</i> Kira’s final ODE.....	73
<i>Figure 32.</i> Kira’s flow of reasoning for task 1.....	73
<i>Figure 33.</i> Zane’s drafts for Task 2.....	77
<i>Figure 34.</i> Zane’s flow of reasoning for task 2.....	77
<i>Figure 35.</i> Rebecca’s initial work on Task 2.....	78
<i>Figure 36.</i> Rebecca’s diagram of the circuit. ....	79
<i>Figure 37.</i> Rebecca’s final expression. ....	79
<i>Figure 38.</i> Rebecca’s flow of reasoning for task 2.....	81
<i>Figure 39.</i> Harry’s evidence of KCL use.....	82
<i>Figure 40.</i> Harry’s final expression (ODE).....	82
<i>Figure 41.</i> Harry’s flow of reasoning for task 2.....	83
<i>Figure 42.</i> Josh’s final expression.....	84
<i>Figure 43.</i> Josh’s flow of reasoning for task 2.....	85



<i>Figure 44.</i> Kira’s component-based approach results.....	86
<i>Figure 45.</i> Kira’s flow of reasoning for task 2.....	87
<i>Figure 46.</i> Zane’s analogies between systems.....	88
<i>Figure 47.</i> Zane’s guiding (Bernoulli) equation.....	88
<i>Figure 48.</i> Exclusion of compressibility term from Zane’s equation.....	88
<i>Figure 49.</i> Zane’s preliminary equation to obtain the ODE.....	89
<i>Figure 50.</i> Zane’s ODE for Task 3.....	90
<i>Figure 51.</i> Zane’s flow of reasoning for task 3.....	91
<i>Figure 52.</i> Rebecca’s preliminary equation excluding the 4th term.....	92
<i>Figure 53.</i> Rebecca’s final ODE for task 3.....	92
<i>Figure 54.</i> Rebecca’s flow of reasoning for task 3.....	93
<i>Figure 55.</i> Harry’s final ODE for task 3.....	95
<i>Figure 56.</i> Harry’s flow of reasoning for task 3.....	95
<i>Figure 57.</i> Josh’s flow of reasoning for task 3.....	97
<i>Figure 58.</i> Kira’s final ODE for task 3 and $q_{out}$ interpretation.....	98
<i>Figure 59.</i> Kira’s flow of reasoning for task 3.....	99

## LIST OF TABLES

<i>Table 1</i> .....	29
<i>Table 2</i> .....	35
<i>Table 3</i> .....	36
<i>Table 4</i> .....	38
<i>Table 5</i> .....	38
<i>Table 6</i> .....	40
<i>Table 7</i> .....	41
<i>Table 8</i> .....	50
<i>Table 9</i> .....	101
<i>Table 10</i> .....	101

## CHAPTER 1: RATIONALE

In this study, I intend to explore how students apply the concepts learned in ordinary differential equations (ODE) courses in the context of an advanced engineering subject, “System Dynamics”. In this chapter, I provide the justifications for carrying out this study as well as its importance for both the mathematics education and engineering education communities.

First, I wish to speak of two separate, but related issues within mathematics education. On one hand, there has been a growing need for professionals in degrees related to Science, Technology, Engineering and Mathematics (STEM) to help in improving and maintaining the economic competitiveness of the U.S. with respect to technological and scientific capabilities (Matthews, 2007; Hall et al, 2011; NMS, 2014; Peters and Kortecamp, 2010). In fact, any country interested in keeping its industrial, scientific and economic pace has a commitment to promote the STEM structure that supports it. From the different fronts from which the STEM role can be strengthened, one is through focusing efforts on improving STEM instruction at all academic levels (PCAST, 2012).

On the other hand, the educational problems faced by high school and college level students present various challenges for mathematics education researchers. Matthews (2007) emphasized the importance of making the necessary arrangements so that the parties involved (schools, universities, and governmental institutions, among others) pay special attention to the decline of students choosing STEM related programs at university level (Chen and Soldner, 2013; NMS, 2014). Furthermore, Martinez and Sriraman (2015) also pointed at a fact that many of those who are currently doing STEM degrees face several challenges along the process and choose to leave. One of their findings involves the quality of mathematics instruction at

undergraduate and graduate level and how it might be one of the causes of STEM students' attrition.

In this way, on one hand there are STEM students' attrition and the necessity of recruiting more students to study STEM related degrees for the reasons aforementioned. On the other hand, for years, there have been concerns about the teaching and learning process at university level. One of the reasons for this concern implies the need for preparing future engineers and scientists for today's world's challenges. Hence, research has turned its attention to this issue in recent decades.

Several studies have addressed issues related to teaching and learning mathematics at the University level (Artigue, 1999; Peters and Kortecamp, 2010; Bergsten, 2007; Wainwright and Flick, 2007). As the number of students attending universities increased, it was necessary to pay attention to educational issues at this level of mathematics. Studies at this level include: The conceptualization of calculus topics and the conciliation between what is taught at high school and what students should "know" when starting college level mathematics (Pilgrim, 2014; Artigue, 1999); Notions and conceptions of limits (Shipman, 2012; Güçler, 2012), derivatives (Hashemi, et al, 2015; Orton, 1983), definite integrals (Jones, 2015a) , integrals of other kinds (Jones, 2015b), proof (Powers et al, 2010), differential equations (Soon et al, 2011; Rasmussen, 2001), and linear algebra (Celik, 2015). The amount of specific studies about mathematics at this level is evidence that there are significant issues that demand the attention of the mathematics education researchers, along with science and engineering education researchers.

Of the undergraduate mathematics education foci, one emerging branch is concerned with connections between mathematics and other STEM disciplines, such as science and engineering. Furthermore, the European Society for Engineering Education (SEFI, 2013) issued a framework

for mathematics curricula in engineering education with the intention of making a contribution to the improvement and development of higher engineering education. Out of the several recommendations presented, the SEFI Mathematics group quoted Willcox and Bounova (2004):

One of the major findings of this study was that the engineering faculty is unaware of the details of mathematics class curricula – they do not know specifically where and how mathematical concepts are taught. Likewise, for many concepts, mathematics faculty do not have a clear understanding of precisely how their downstream “customers” will use the skills they teach (Willcox and Bounova, 2004, p. 9)

This statement evidences a possible cause for the challenges that undergraduate engineering students face at using their mathematics knowledge when they deal with engineering-related tasks. As a consequence, this situation might generate a disconnect between mathematics and applied sciences. Eventually, the effects will likely be evidenced in the professional practice. This problem then, requires a concomitant effort from both engineering education and mathematics education researchers if we are to deal with this issue more efficiently. Booth (2008) addressed this issue of teaching and learning mathematics for an engineering context, thinking about a future “knowledge society” which he defines as the new societal paradigm that focuses its educational trend towards the necessities of our evolving society; that is, the paradigm has moved from a humanistic, then industrial to a now modern view that emphasizes creativity, resourcefulness, problem-solving skills among others. He presented the results of three studies that shed some light as to how mathematics are used and what the quality of their learning outcomes is, thinking about their future encounters with math-related science/engineering/technology subjects. As part of the conclusions, Booth presented the implications for the processes of teaching that provided the basis of students’ future skills and

how mathematics could be integrated in other aspects of their practice as students but also as future professionals. In summary, “knowledge capability” and preparation for working in the knowledge society comprise Booth’s conclusions. This implies that instruction should be aimed at preparing engineers to be able to use their skills in an ever-evolving society in part by taking their mathematical knowledge in their everyday contexts.

The problem of strengthening the connection between mathematics and applied sciences can be seen from several points of view. Thus, it is important to illustrate a brief account of what has been done in this respect in order to provide a proper reasoning of the objective of the present study. Dray and Manogue (2004) pointed at the necessity of bridging the gap between mathematics and physical sciences at college level, they referred to the importance of a correct interpretation (and reconcile) symbolization to facilitate physics concepts understanding involving mathematical principles. Horwitz and Ebrahimpour (2002) reported on a two-year project including science and engineering projects in calculus (differential and integral) courses in which two calculus classes worked on a project-basis framework with the intention of achieving a stronger connection of the mathematical concepts and some contexts (engineering) in which these could be applied. Though not necessarily successful, the project was focused on making the connections more apparent. On the other hand, Pennell, et al., (2009) reported on a program that intended to reinforce the connection between the concepts of differential equations and the engineering practice. From among these lines of research, I will focus on how differential equations concepts are applied in novel contexts by undergraduate students, specifically, at the analysis of the application of differential equations concepts in engineering settings.

There is a strong notion of how mathematics and physics-related –or engineering- subjects are interconnected, especially when it comes to interpreting notations or the way

physical ideas and concepts are mixed with the mathematics concepts. For example, the mechanics of materials engineering course (Hibbeler, 1997) has a high load of calculus concepts such as derivatives, rates of change, and integrals. There are also concepts from geometry and algebra, fluid mechanics (Fox, 2011), heat transfer (Incropera, 2007), thermodynamics (Çengel, 2002) and system dynamics (Palm, 2005). In this way, mathematics becomes an essential element that enhances the understanding but it is not the only component needed to perform tasks in physics or advanced engineering/science topics. However, when a student cannot clearly understand certain critical mathematical concepts, he/she may find extreme difficulties going any further with engineering or science task involving mathematical concepts. This problem can also be given the other way around, that is, the lack of understanding of physical concepts may prevent the possibility to model real life situations using mathematical tools. Eventually this might become an issue for the prospective professional who needs to make use of as many tools as possible to be able to solve everyday problems at work.

Taking into account the last paragraph, one might argue about the specific kind of knowledge that a professional – practicing – engineer should consider in his or her everyday practice. Ellis et al., (2004) made a survey among 96 engineers who responded to a varied set of questions regarding the (mathematical) conceptual understanding required of them at work, focused on calculus knowledge. In particular, 66% of the interviewees asserted that they were required to possess a conceptual understanding of differential equations. These results are remarkable for this study in particular, since there is emphasis on what concepts engineers require in their practice.

With this in mind, I have noticed the importance of the instruction provided in differential equations courses and the influence it might exert on later settings where students are required to

use concepts learned from this subject. While there have been several studies that analyze how students learn ODEs (Rasmussen, 2001; Arslan, 2009), what aspects influence this learning (Raychaudhuri, 2013), and alternative strategies to help them have a better understanding (Budinski, 2011; Rasmussen and Kwon, 2007; Savoye, 2009; Kwon, 2002), not much has been studied as for what happens afterwards; namely, how students apply or use the ODEs concepts in further stages of their instructions to become professionals. As it has been mentioned before, differential equations concepts are often used in certain settings of professional engineers and scientists so it is of great interest to dig into the complexities involving students transfer of learning from a mathematics education research perspective.

The aforementioned studies provide a general perception of the concerns of researchers in understanding the challenges involving the use of ODEs for future professionals. However, within this intersection between mathematics and engineering education there are still gaps that need exploring. Thus, this master's thesis is intended to answer the following research question: What knowledge resources and strategies do students use while setting up ODEs in these engineering contexts?

Having personally graduated as a mechanical engineer, from my point of view I consider that being able to apply ODEs to engineering is a matter of great importance. I expect to find valuable information regarding the students' process of thinking in transferring their knowledge. As such, this study can contribute to both the mathematics and engineering education community.

With the purpose of providing answers to the research questions, the aim of this thesis entails choosing a specific engineering subject extensively connected with ODEs and analyzing the way that undergraduate engineering students apply those concepts to the novel context. This



novel context is System Dynamics, a subject that mechanical engineering undergraduates have to take usually a year or less before they graduate, so its relevance is evident as for assessing the preparation of the future professional engineering graduate.

## CHAPTER 2: LITERATURE REVIEW

### **Student Understanding of Differential Equations**

In this section, I review the undergraduate education research literature pertaining to the topic of differential equations. In particular, Rasmussen et al., (e.g., 2001, 2000), has conducted several important studies about students' understandings and difficulties regarding ODEs. The objective for those studies was to explore the variety of ways by which elements, like content, instruction and technology, can foster student learning. At the same time introducing a framework within which researchers could be based to study the understanding, conceptualizing and application of ODEs concepts.

Rasmussen's (2001) framework presents two major themes: 1) functions-as-solutions dilemma and 2) Students' intuitions and images. These themes are presented as a way to interpret students' thinking. On the one hand, the first theme is divided into three subcategories: 1a) Interpreting solutions 1b) Interpreting equilibrium solutions and 1c) Focusing on quantities. These subsets can be interchangeably present at the moment a student is interpreting a system represented by a differential equation; that is, what seems relevant to the student in order to show his/her understanding. On the other hand, the second theme is also divided in three subtopics of understanding: 2a) Equilibrium solutions, 2b) Numerical approximations and 2c) Stability.

The way students focused on the differential equations to interpret their solutions gave Rasmussen the resources to build his framework. In this way, his study might serve as a useful foundation to help understand how students in the present study might interpret the solution to the proposed exercises. However, there are two topics that might not be covered at this point: 1) Most of Rasmussen's framework is based on first-order differential equations with only few mentions to second-order differential equations. In this respect, the present study might shed

some light as for alternative ways of students' interpretations. On the other hand, 2) Rasmussen's framework did not include how the context of the situation presented might influence the interpretation of the solution of the differential equation, which plays a fundamental role in the present study.

Also, Hubbard (1994) listed several characteristics of an ODE that imply its understanding: 1) Understanding that the solution of a differential equation involves a function and not a number; in fact, many possible solutions (functions) depending on the conditions. 2) Present a description of how the solutions behave.

A differential equation describes the evolution of a system. Mental pictures of a differential equation allow guesses about the system's behavior. Also, there is a need to recognize the elements and how these affect the behavior of the system. For example, consider the non-homogenous, second-order differential equation:

$$\text{i.e.: } x'' + 0.1x' + \sin x = \cos t$$

A discussion about this system might include the recognition of it being a damped, non-linear pendulum, forced system. It could also include an explanation of what happens to the systems as the parameters change. For example, will forcing kick the bob over? What about the friction? Is friction large enough to eventually make it stop?

Hubbard emphasizes on the necessity that the student communicates his/her findings or conjectures in terms of statements and not merely in terms of formulas or numbers. For example, how they describe the behavior of the system and what elements of the equation they use to support their reasoning.

These are elements that facilitate a proper description of what the differential equation represents given a certain context. However, it is also necessary to take into account the requirements of the

System Dynamics course in order to complement the analysis of a system. Palm (2005) states that the objective of a system dynamics course entails the mathematical modeling and analysis of devices and processes so that we understand its time-dependent behavior. In other words, it is expected to predict the performance of a system as a function of time.

### **Connections between Science/Engineering and Mathematics**

In this section, I address in more detail the literature regarding the connection between science/engineering and mathematics. For example, Redish (2005) described mathematics as an essential component for physics problem solving. Indeed, Redish discussed the issue of what students thought they were doing while solving physics problem situations and how they applied or used mathematical concepts in contrast with what instructors expected them to be doing. For instance, when blending mathematics and physics, equations were interpreted in different ways which caused discrepancies in many cases in the end results. Thus, it may be that this idea can be extrapolated to other contexts, such as ODEs and its applications, revealing similar disparities.

It is possible to illustrate this matter with the following example. The equations shown below describe a typical example of an ordinary differential equation. However, while equation (1) might be the usual representation of the differential equation in a mathematics context, it is possible to find representations like the one presented in equation (2) in settings such as engineering classes. Though it might be considered a simple issue, its implications have been described by Dray and Manogue in reference to ambiguous interpretations of mathematics and physics on the concept of functions and their use in physics as quantities (2004), and the way mathematicians, on one hand, and scientists and engineers, on the other, interpret vector calculus (2003). This issue suggests that the lack of understanding might prevent an appropriate application of the concepts taken from the mathematics practice, differential equations in

particular, or it might happen the other way around. That is, when applying physics or science concepts to set up mathematical models that will ultimately serve as tools to understand the behavior of dynamics systems involving differential equations. This leads to the question of how one's mathematical background affect this transfer process as an undergraduate student explores engineering contexts involving the use of ODEs? What aspects (elements of previous knowledge) are relevant when he/she transfers such concepts in that novel (engineering) situation?

$$ay'' + by' + cy = 0 \quad (1)$$

$$m\ddot{x} + b\dot{x} + kx = 0 \quad (2)$$

Figure 1 shows a diagram that represents in brief the concepts that a student has to take into account in order to perform system dynamics tasks. There is a wide variety of concepts from the mathematics branch, calculus in particular, and these are mixed with knowledge from physics and introductory engineering courses. This flow diagram displays the correlation between ODEs and system dynamics and evidences the close connection between these two topics subject of the present study.

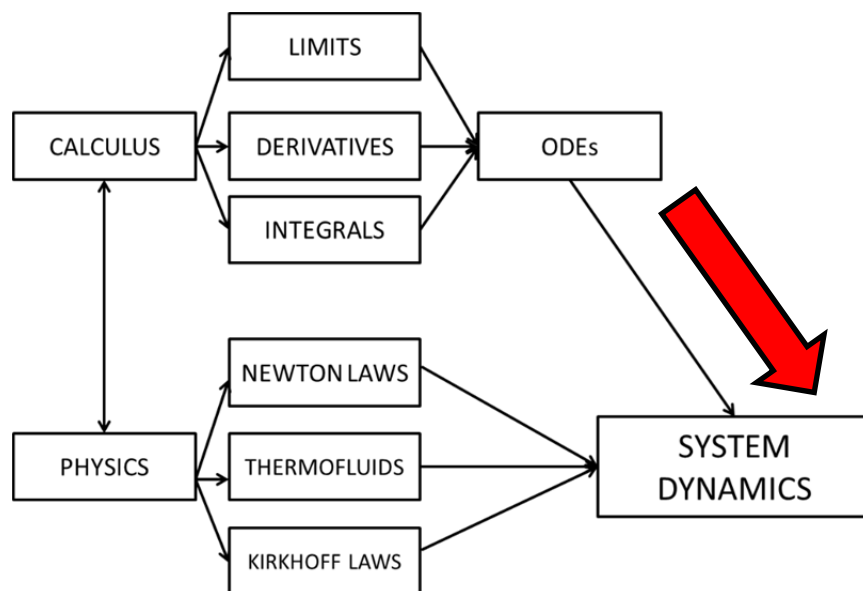

Figure 1. Connection between physics, mathematics and system dynamics.

In summary, Rasmussen and Hubbard have studied students' understanding of ODEs concepts. The former established a framework to understand and categorize students' thinking focused on the different ways students interpret differential equations; the latter argues on the necessity to establish aspects by which it is possible to evaluate whether a student actually understands the concepts implied in a differential equation. Redish on the other hand, addressed the use of mathematics in science/physics. In this study, I intend to explore students' application of differential equations concepts to model engineering systems. The applications of ODEs involve two parts: The first entails modeling a system by obtaining an expression (ODE) and the second part dealing with the understanding and process of finding the solutions of differential equations. Since the second part has been more heavily addressed, in this study I focus on the first part of the application process.

This first part of the process; that is, modelling of systems using differential equations, is a topic that seems to have been little explored in the literature of mathematics and engineering education. In this study I intend to delve into the process by which a student has to set up the differential equation that describes a system in different contexts. I expect to obtain relevant information that sheds light on this branch of mathematics that connects with engineering since we currently do not have much knowledge in this respect. In brief, the modelling process can be divided into three steps according to Blanchard (1998), (1) Establishing the rules or laws that describe the relationships between the quantities to be analyzed. (2) Defining the variables and parameters to be used in the model. (3) Using those relationships between quantities to obtain the desired equation(s), an ODE in this case. This study attempts to contribute to the existing literature by analyzing how students set up ODEs as they follow these steps.

## CHAPTER 3: THEORETICAL FRAMEWORK

### Coordination Classes

In this section, I present the construct of “coordination classes,” which is the theoretical lens I used to develop my study’s methods and my data analysis. I delve into its components and its relevant uses in studies that involve, or are based on, the transfer of learning perspective. I now refer to the origins of this theory. There have been a considerable number of studies related to the study of how concepts are developed in an individual; or conceptual change (Carey, 1988; Fodor, 1975; diSessa & Sherin, 1998). Given its wide scope, diSessa and Sherin broke down their theory by making an effort to define the concept of “concept” itself.

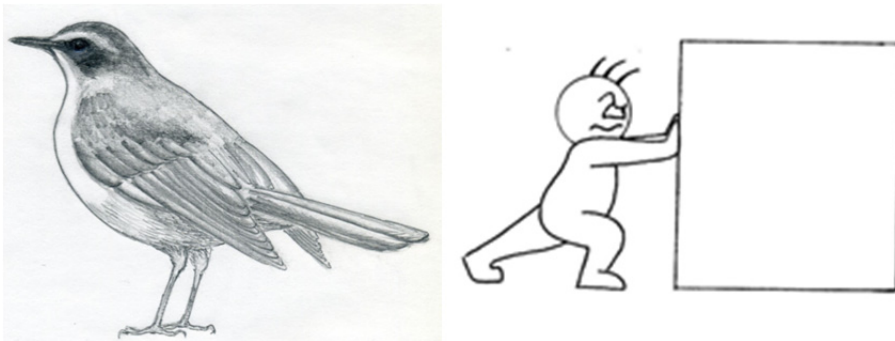

Figure 2. “Bird” and “Force” concepts.

Here I explain how diSessa and Sherin (1998) discriminate “concepts” into different types. First, Figure 2, are images of a bird on the left and a man pushing a box on the right. In the first case, for the concept of a “bird,” in general, we have a common agreement for what counts as being a “bird,” as well as a possible list of features corresponding to a living thing known as “bird”. The reader might think of features such as: feathers, biped, hatching, and wings. This kind of “concept” is one that might easily evolve in a person’s mind and, this concept [they claim] corresponds to classifying membership into that concept category. In other words, the *purpose* of

the concept is to define membership *into* that concept. The evolution of that concept happens as the individual adds [or rejects] characteristics that make an entity “a bird”.

The picture showing the man pushing the box might be interpreted as one in which there is a force involved – generated by the man – acting on the box being moved. This specific type of concept involves a more than a membership classification. In other words, the “force” concept is not necessarily just concerned with whether something belongs to the “force” concept, but is more concerned with obtaining information *about* the force. The force is not directly visible by an observer, unlike the bird that is directly visible, but must be inferred through related observation, such as the acceleration of the object. The concept of “force” can be classified in the type of concepts defined by diSessa and Sherin (1998) as *coordination class*. In this case, “force” does not necessarily have a given visual prototype like there might be one for the concept of “bird,” which helps distinguish whether an object is a bird or not. The purpose of the “force concept” is to determine *information* about the force, such as its direction and magnitude, rather than to identify whether a thing is or is not a “force.” This concept may consist of a collection of certain types (classes) of features and elemental pieces of knowledge that when properly coordinated comprise a coordination class concept. In this example, the concept of force is composed of other basic elements, which we use to get the desired information. From our knowledge of Newton’s laws we usually define force as the product of mass and acceleration,  $F = ma$ . Therefore, this concept coordinates three foundational concepts: (1) the *mass* of the box, which is the measure of inertia or opposition of that body to be moved; (2) *multiplication* which accounts for a successive summation of a given quantity; and (3) *acceleration* which is the rate of change of velocity with respect to time. By identifying those sub-elements that make up a force (mass and acceleration) we are spotting the fact that we need to measure a mass and a change of



velocity of a body in order to “find” the force acting on it, that is, how much force is being exerted on that body.

### **Readout Strategies and Causal Nets**

A coordination class has a main function. It can be understood as a particular way in which people read information from the world, especially when it comes to abstract concepts in sciences, and use that information to infer about that abstract concept. There are two basic functions that together imply a coordination class: *readout strategies* and *causal nets*. These two elements entail the core of a coordination class. *Readout strategies* pertain to one’s ability to take information directly from the observable world and interpret, or “read,” that information in a useful way. In the case of the concept of force, a person can directly observe the size and heaviness of an object, as well as its motion and changing speed, but they are also required to use their abilities to “read” that information in order to interpret them as a mass and an acceleration. One must know how to “read” the relevant information from the real world in order to mentally use that information to deduce properties about the unseen force acting on the object. However, this person might not know how to coordinate these concepts so that a force might be recognized. For instance, they might not have the knowledge resource that relates mass and acceleration to force through Newton’s  $F = ma$  law.

Thus, the second component to a coordination class, after the readout strategies, is the idea of a “*causal net*,” wherein knowledge elements are linked together in a way to help the individual obtain the desired properties of the concept in the form of inferences that are not necessarily ostensible in the situation under study. In the force example, the element  $F = ma$  can allow the student to take the information about mass and acceleration, obtained from their readout strategies, and use them to obtain the desired information about force. Other examples of causal

net elements might be that the direction of acceleration is the same as the direction of the force, or that multiple forces acting simultaneously only produce acceleration in a single direction determined by the sum of the forces. There may even need to be causal net elements that help the student know that size and heaviness of an object both feed into determining “mass,” which is then subsequently used in the  $F = ma$  causal net element to infer about force. In this last example, we can see that sometimes causal net elements may feed into further causal net elements, creating a true “web,” or “net” (as the name is meant to imply), of knowledge pieces.

To further illustrate the ideas of readout strategies and causal nets, I give another example described by diSessa and Sherin (1998) drawing from a more familiar context. Imagine a person that is purchasing a flight ticket to travel somewhere. If that person wants to know how long it takes for the plane to arrive at the destination, it is necessary to coordinate certain pieces of information that are printed on the ticket. A readout strategy may consist of the recognition of the departure and arrival times as important and relevant aspects to help him/her know the duration of the flight. However, the cognitive operation required to actually know how many hours the flight takes entails a further operation, invoking the causal net. In this example, the traveler knows that it is necessary to obtain the difference between the departure and arrival times to produce the flight duration. Also, the traveler should have knowledge about time zones which feed into their ability to correct calculate flight duration that passes through time zones. The person has to make a set of inferences from the readouts in order to convert that information into new information, the one that is required. That set of inferences is the *causal net*.

### **Transfer, Span, and Concept Projection**

At the beginning of this section I mentioned that the coordination class theory is related to the process of transfer of learning. I now briefly define transfer of learning and its relation with

coordination class and then I discuss the elements that entail a coordination class. By the end of the section, I extend the relation between transfer and coordination class.

Transfer of learning “entails the use (or reuse) of previous knowledge acquired in one situation (or class of situations) in a ‘new’ situation (or class of situations)” (diSessa & Wagner 2005, p. 122). Several studies have taken different approaches to transfer in an effort to show evidence of this phenomenon. However, given the fact that there are different types of transfer approaches, it is important to adopt a specific transfer lens that may be consistent with one’s guiding theory on knowledge. diSessa and Wagner (2005) have outlined a particular view of transfer that is compatible with the coordination class paradigm. Thus, naturally, it is this orientation toward transfer that I adopt for my study, and I describe this particular view in this section.

In order to describe this transfer lens, there are more components of the coordination class theory to bring up and discuss. I use the concept of force once more to illustrate these additional constructs. First, suppose a student sees a spring compressed between a person’s two hands. It is possible that the student can conclude in this situation that there are enough elements to infer that the spring is exerting a force against the person’s hands. This is because he/she reads the relevant elements that entail the concept of force. That is, there is a mass, it is being moved by the spring and the student recognizes the physical law behind this “force” known as Hooke’s law. However, this same student might not recognize that if a body is submerged in a tank filled with water, this water is exerting a force that pushes this body toward the surface. In this way, the range of applicability of the concept is limited to one’s ability to recognize the existence of the concept in certain contexts. This range of “applicability” of the concept is known as *span* and it is developed as the learner accumulates experience and knowledge.

As the individual accumulates that experience and knowledge, all of these combine with the development of skills like intuition, creativity and resourcefulness, they eventually expand their span to include additional contexts. The way in which the coordination class theory evidences the expansion of the span is known as *alignment*. This means that the individual is able to recognize that the coordination class (the concept) works in the same way as it works in the previous situations that they experienced in the past. It is worth noting the fact that the theory of coordination class is also based on the Piagetian conception of knowledge construction (constructivism) since the individual scaffolds his/her knowledge upon previously acquired concepts.

There is an important aspect to coordination classes that explains the process of span expansion and further alignment. diSessa (2004), and diSessa and Wagner (2005), describe the collection of strategies and knowledge elements used by the individual to implement the concept (coordination class) in particular contexts as a *concept projection*. If we think of the student who is able to recognize a force in the spring-mass system but cannot do so in the context of the body submerged in water, then it is possible to analyze and keep track of all the decisions, strategies, inferences and knowledge elements that this student might employ in one context versus another context. For example, the strategies and knowledge pieces used to reason about force in the spring context would consist of their *concept projection of force in the spring context*, and the potential strategies and knowledge pieces used to reason about force in the submerged object context would consist of their *concept projection of force in the fluid context*.

To further illustrate the construct of “concept projection,” I give here an example within mathematics. To begin, consider the concept of the roots of a quadratic function, which is likely a coordination class concept because it deals with obtaining information in addition to the simple

categorization of something as a “root” or not. In general, students may be introduced to this topic by first being given a function in the factored form, such as:

$$f(x) = (x + 2)(x - 1)$$

In this case, the student “reads” each set of parentheses as a factor. They then use a causal net element to recognize that any factor has to be equal to zero to make  $f(x) = 0$ . Then they further employ a causal net element to produce a solution after setting each factor to zero. Consequently the roots or solutions of the equation  $(x+2)(x-1) = 0$  are  $x = -2$  and  $x = 1$ . The concept of “root” is put to work by these readouts and the causal net, which scaffold the strategy of setting each factor equal to zero. Thus, taken together, these readouts, causal net elements, and strategies form the *concept projection of roots in the factored context*. That combination of knowledge and strategies led him/her to project the root concept and work on this task.

Now suppose the student sees another quadratic function, one that is not given in the factored form but in the standard form:

$$f(x) = x^2 - 2x + 5$$

The student might first read the expression as a trinomial (whether they imagine that word or not), and then use a causal net element that associates trinomials with factoring. They might try to factor the trinomial and notice that it is not possible to use integers to change the expression to its factored form. After this realization, the student may switch strategy. They may invoke a separate causal net element that associates trinomials with the quadratic formula. This leads to the distinct strategy of using the quadratic formula to find the roots through the solutions to the equation  $x^2 - 2x + 5 = 0$ . This separate set of readouts, causal net elements, and strategies makes up the *concept projection of roots in the trinomial context*. That is, in this case, the concept is projected by using this other strategy, the quadratic formula.

However, there might be cases when a student faces other types of equations of the form:

$$2x + \frac{1}{x} - 3 = 0$$

For the more expert eye, this exercise poses little problem because an expert has been able to use (or project) the concept in multiple situations and each context presents different characteristics that he/she manages to deal with without problems. This expert may use readouts and causal net elements that use the strategy that transforms this equation into a quadratic form for which either factoring or the quadratic formula can be used. A novice on the other hand, may lack the strategies or the tools to carry out the process of finding the solution(s) to this last equation, or they simply do not “see” how the concept can be applicable in this case. In other words there might be no projection in this case for a novice.

Concept projection can be thought of as the way coordination class theory views the transfer of learning. I have previously defined transfer as the application of previous knowledge in novel situations. From this perspective, it is then valid to use coordination classes and concept projections in an attempt to understand the transfer of learning when it comes to analyzing several science concepts such as force, mathematical and physical quantities, or certain theories and laws.

### **Differential Equations and Coordination Classes**

I have made a description of coordination class theory and its relevance for the analysis of concept learning in sciences and mathematics. In this study I intend to analyze how students apply their knowledge of differential equations in the context of system dynamics from this perspective. One of the objectives in the system dynamics class for undergraduate mechanical engineers consists of the modeling of mechanical, electrical and fluid systems. This implies that

students are asked to determine the quantity to be studied and to obtain an expression (an ODE) that relates that quantity with its derivatives. In other words, they have to design a model that allows them to predict the system's behavior with respect to time. In general, for this kind of systems, the expression to be obtained is an Ordinary Differential Equation (ODE).

As described earlier, according to Blanchard et al (1998), the process of modeling consists of three steps. The first step entails establishing the rules or laws that describe the relationships between the quantities to be analyzed. The next step consists of defining the variables and parameters to be used in the model. The third step is using those relationships between quantities to obtain the desired equation(s), an ODE in this case.

The way that we can obtain information from a system is then given by the proper modeling of it. Thus, coordination classes offer a suitable approach to analyzing the readout strategies, causal nets, and possible concept projections evidenced by a student attempting to work with differential equations in these engineering contexts. This is feasible especially because the setting I investigate involves students who are taking a system dynamics course and all of them have had the opportunity to take a differential equations course.

Most of the equations obtained by the students when modeling different types of systems (mechanical, electrical and fluid, or a combination of these) follow the pattern of ordinary first or second order differential equations. These can be homogenous or non-homogenous and linear or non-linear. This engineering course excludes the use of partial differential equations because all of the systems to study are time-dependent only. In this way, students are likely to set up equations of the form. I describe this form, and how it relates to the contexts under investigation in this study, in the following chapter.

$$ay'' + by' + cy = f(t)$$

## CHAPTER 4: METHODS

The arguments presented at the beginning of this study called for the necessity of continuing with research focused on finding elements that contribute to the strengthening of the teaching and learning process of mathematics in STEM contexts. As for this study, I emphasize that the connection between mathematics and science and/or engineering is a matter that requires attention from mathematics and engineering education as part of the potential solutions to improve the learning and teaching of mathematics and engineering at undergraduate level, promote STEM programs, deter students from detrition, among others.

In this study I intend to answer the questions posed in the introduction regarding how students apply ODEs to engineering contexts involving system dynamics from a coordination class perspective. This perspective influenced the design of the instruments of data collection, organization and analysis. These are described in the following paragraphs.

### **Participants**

The study included the participation of five undergraduate mechanical engineering students. The participants were taking the system dynamics class offered by the mechanical engineering department at the time of recruitment. These students had all already taken a differential equations course, as it is a prerequisite for the system dynamics class.

In general, students at this stage are about to graduate and the topics they study during the system dynamics course are likely to become part of the professional practice for some of them. At this point of the program, the students have already taken the usual calculus series and also the series of fundamentals of physics, as well as the first two courses of applied mechanics, statics and dynamics, (see Figure 1 in the introduction). This helps to make sure that students have enough background for the tasks to be applied during the sessions. For this manuscript, the five



students have been given the pseudonyms, Zane, Kira, Harry, Rebecca and Josh. All of them were senior mechanical engineering undergraduates from a large university in the United States and were taking the system dynamics class during the time of the interviews and volunteered to take part of the study. They were chosen from among a group of 60 students based on their responses to an initial survey, which I now describe. In the next section, I describe the procedure for which I chose the participants in the study.

### **Instruments**

In this section I describe the instruments I used to collect the information. Then, I explain the process to choose the participants in the study and the tasks I assigned them during the sessions I interviewed them. When describing the tasks assigned to the students I also show how the tasks are solved and the aspects I took into account to be used during the data analysis stage of the study.

The initial survey contained a set of questions regarding the student's interpretation of the elements comprising ODEs, as well as a section where they expressed their willingness to participate in the study. I coordinated the administration of the survey with the professor in charge of the System Dynamics class one month before the end of the semester.

The survey contained a set of six questions that asked the students to express what they knew and how much they knew and understood about ordinary differential equations (ODEs). The questions were focused on each of the elements of the ODE, including how they interpreted the second derivative of  $y$  ( $y''$ ), the first derivative of  $y$  ( $y'$ ), the function  $y$ , what the constants  $a$ ,  $b$  and  $c$  represent, and finally, what zero represents in the equation (see Figure 1). The reason behind choosing this specific differential equation is because that model is typical in System Dynamics settings. Thus, students will be reporting their knowledge about a differential equation

with which they should be acquainted at this stage of the study and, at the same time, one that is closely related to the exercises that the interviewees dealt with eventually.

Please answer the following questions with the best of your knowledge.

Answer the questions below using as many details as possible. You might also want to refer to previous settings in which you have used these mathematical expressions as well as other representations, different from the one presented in this survey, feel free to describe them thoroughly.

Taking into account the equation below:

$$ay'' + by' + cy = 0$$

<p>1) What kind of equation is it? Why?</p> <p>1a) What order is it? Why?</p> <p>1b) What type (linear/non-linear)? Why?</p> <p>1c) How do you know if it is homogenous or non-homogeneous? What does it mean?</p>	<p>2) a) What does <math>y''</math> mean?</p> <p>b) What does it represent?</p>
<p>3) a) What does <math>y'</math> mean?</p> <p>b) What does it represent?</p>	<p>4) a) What does <math>y</math> mean?</p> <p>b) What does it represent?</p>
<p>5) a) What do a, b and c mean?</p> <p>b) What do these letters represent?</p>	<p>6) What does zero represent?</p> <p>What happens if there is another value instead of zero?</p>

Please, indicate whether you are willing to take part in a research study about ODEs. Yes \_\_\_\_\_ No \_\_\_\_\_

Figure 3. Preliminary survey.

I expected to recruit the five participants in the following way. I wanted two of them to be students who would potentially show a high performance in solving the tasks, two of them to be at a “medium” level, and one more student who might have difficulties with the subject. With that in mind, I could have the possibility to find evidence for both advantages of certain strategies and possible difficulties associated with the students’ concept projections of ODEs in the system dynamics contexts.

## Selection of Participants

Two of the participants were chosen on the basis of the clarity and accurate explanation of the questions from the survey. These two students were able to give more details when answering question 1, for example. Both explained the whys beyond correctly identifying it as a second order linear homogeneous differential equation. These two students also provided clear understanding of the meaning of each of the elements of the ODE along with examples of applications in which these elements are used. In question 1 they explained that it is a second order differential equation because the highest derivative in the expression is a second derivative, that homogeneity implies that the ODE equals to zero which means that it has no forced input. In contrast, one of the students considered to have challenges with the concepts, only explained that it was a second order differential equation involving “two derivatives”. In question 5, they identified the constants as parameters that affect the system when they take different values. Also, from question 6, they showed understanding that when the equation is not equal to zero, there is an external element, in the form of a function that affects the system, also known as forced response.

The other three participants had a fair understanding of what the differential equation was. They demonstrated reasonable understanding from part (a) of each question, but for part (b) they either lacked information about the representation of each element, or their response was actually irrelevant to the question. In the case of the student who I predicted to have a poor performance, the answers were short, inaccurate and/or irrelevant. This participant barely identified the elements of the ODE and showed little depth in the responses. For example, in question 6, this participant was limited in her response: “*no input of force [if it equals to a value other than zero] turns it into a step or forced response*”. In this case, this student immediately correlates the

equation with a system of forces not showing evidence that these quantities could be of different nature, a limited applicability of the concept. We can compare it with the response of a high-performing student who replied: “*There is no forcing function of input... [if it equals to a value other than zero] the ODE has a forced response in addition to the free response*”.

As I analyzed the surveys, I selected ten students, divided in two groups, who satisfied the profiles described in the previous paragraph. One main group and the second acted as a backup. I contacted the participants through email and by phone and invited them to participate in two 45-minute sessions approximately. One student from the main group did not reply so I picked the replacement from the back-up group. For the interviews, I used three tasks that were similar to exercises they had seen and done in their system dynamics class. In order to have various contexts to work with, I chose a mechanical system task, an electrical system task, and a fluid system task. The students were asked to set up a differential equation that modeled each of the systems. In order to provide the reader with a baseline of what each task involved, in the following subsections I describe each of the three tasks the students were given, as well as a complete “expert-view” solution of them.

### **Description and Solution of Task 1**

Figure 4 shows the first task given to the students in the interviews, which can be considered a fairly routine, though non-trivial, task for the students in this class. Here I give a conceptual analysis of this task. The pendulum’s swing will be affected by the elements connected to it. Furthermore, since it is a pendulum, those elements will make it rotate about the center of rotation shown between  $L_1$  and  $L_2$ . This fact implies that the ODE will be generated from the summation of moments in the system, where a moment is the product of force times the distance from the center of rotation. A Free Body Diagram can be a useful tool to describe the

effect of each element in the system's behavior. In Figure 5, the pendulum is influenced by three different forces produced by the elements in the system: the force caused by Spring 1 ( $k_1$ ) on top, and force exerted by the Spring 2 ( $k_2$ ) and the damper ( $F_c$ ).

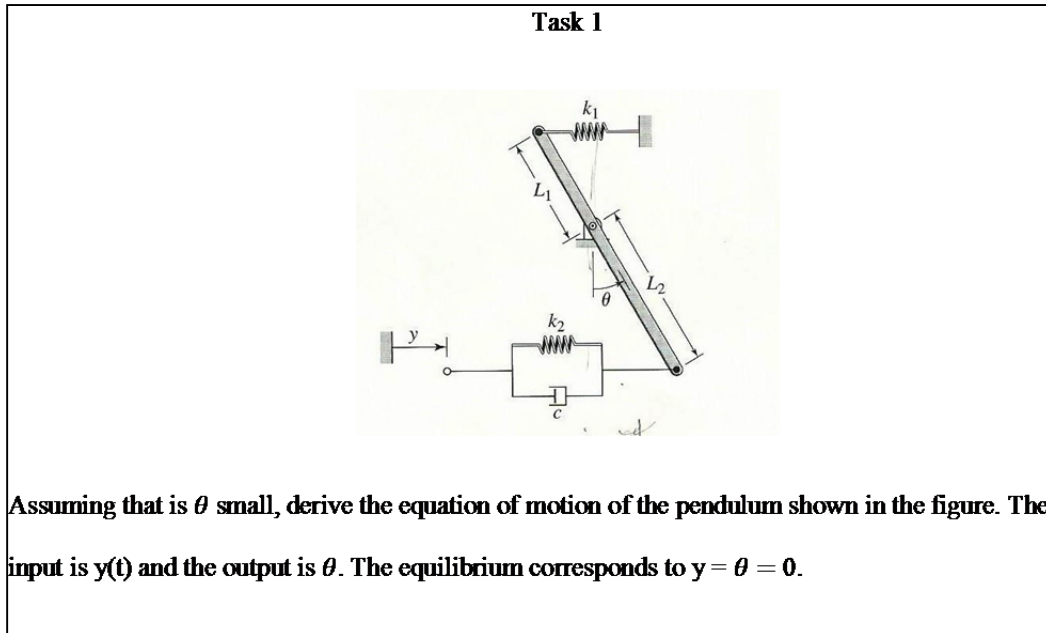

Figure 4. Task 1. (Taken from Palm, 2005, p. 244).

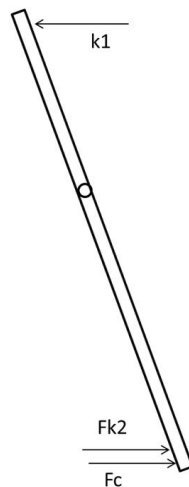

Figure 5. Free body diagram of the pendulum.

The FBD can help one visualize the concept of summation of forces in a system yielding a resulting product of mass and acceleration. For this task, it is the product of the inertia and the angular acceleration, because there is a lever or pendulum rotates by the action of the elements connected to it. Hence, taking into account the inference made from the FBD and also making use of the Second Law of Newton ( $F = m \cdot a$ ) we can infer the following equation representing the governing principle in this task:

$$\sum M = I\ddot{\theta} \quad (1)$$

In this equation,  $M$  stands for the moments contributing to swing the pendulum,  $I$  is the moment of inertia, and  $\ddot{\theta}$  is the angular acceleration. In general, it is expected that students are able to easily transfer the notion of  $\sum F = ma$ , which entails systems where the mass shows a linear (straight line) displacement, to this particular situation where the resulting motion is rotational. In this case,  $I$  is analogous to  $m$  and  $a$  is analogous to  $\ddot{\theta}$ . Also, in this case, one might start to recognize that this system is configured by a second order differential equation since  $\ddot{\theta}$  is the second derivative of the variable  $\theta$ . This implies a mathematical aspect that could help the student in the process of modelling the system's behavior.

With equation (1) in mind, now we need to identify how all the components (or elements) affect the pendulum's motion so that we obtain the requested expression. This system has three elements that will ultimately influence that motion: (1)  $k_1$ , the spring on top of the picture, (2)  $k_2$ , the spring shown at the bottom, and (3)  $c$ , the damper which makes up a parallel couple with  $k_2$ . In this case, we might notice that the presence of a damper in the system implies a first derivative of motion (i.e.  $\dot{\theta}$ ) as well as the springs are related to the variable  $\theta$ . This is another relevant mathematical aspect to take into account for the students to apply.

There are two important factors to notice at this point, before we move on to set up the differential equation. The first detail deals with the fact that, for this task,  $\theta$  is assumed to be small. This fact implies that we can also assume that  $\sin \theta = \theta$ , which will be useful for further stages of solving the task. The second factor implies the effect that the input  $y(t)$  poses on the system. Besides being the cause of the motion, it is necessary to note how it affects  $k_2$  and  $c$ 's behavior in the system. These two aspects are also related to the mathematical implications of the tasks given that the former entails an understanding of the behavior of small angles related to the trigonometric functions. On the other hand, the input function  $y(t)$  can lead the student to assume that he/she is dealing with a forced system, implying a non-homogenous ODE. All these implications are reflected in the equations shown in Table 1:

*Table 1*

*Identification of components in the system and their effect on the system.*

Component	Force	Moment
Spring $k_1$	$k_1 L_1 \theta$	$k_1 L_1^2 \theta$
Spring $k_2$	$k_2 (L_2 \theta - y)$	$k_2 L_2^2 \theta - k_2 L_2 y$
Damper $c$	$c(\dot{\theta} L_2 - \dot{y})$	$c L_2^2 \dot{\theta} - c L_2 \dot{y}$

By taking into account the Second Law of Newton, the equation resulting from the action of the components indicated above, and based on (1), is shown below:

$$k_1 L_1^2 \theta + k_2 L_2^2 \theta - k_2 L_2 y + c L_2^2 \dot{\theta} - c L_2 \dot{y} = I \ddot{\theta} \quad (2)$$

Following a standard ODE setting up, equation (2) can be rearranged as follows in order to give a precise image of the ODE as recognized in the contexts of ODEs:

$$I\ddot{\theta} + cL_2^2\dot{\theta} + (k_1L_1^2 + k_2L_2^2)\theta = k_2L_2y + cL_2\dot{y} \quad (3)$$

This expression contains the variable  $\theta$  and its derivatives, the coefficients are all constant and the right side of the equation shows the input function. This final expression for Task 1 is a non-homogenous linear second order differential equation.

### Description and Solution of Task 2

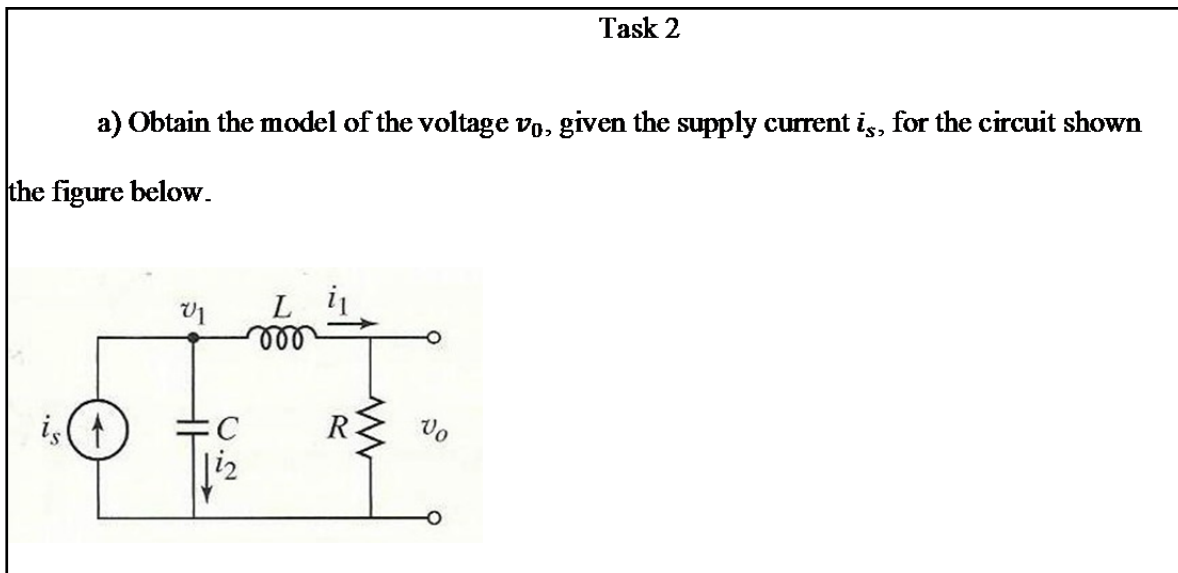

Figure 6. Task 2. (Taken from Palm, 2005, p. 372).

I now turn my attention to the second task given to the students in their interview (*Figure 6*), involving electrical systems the students were required to work with in the systems dynamics class. I note that this particular task was the most difficult, and was used in order to see how students might work with a rather challenging context. In this task, similar to Task 1, we might notice that the voltage  $v_o$  is affected by the influence of three elements: the capacitor (C), the inductance (L) and the resistor (R). The current  $i_s$  “flows” through the circuit and it does because of the potential difference known as voltage. This voltage changes (decreases) as the current passes through each of the elements of the circuit. It decreases until it reaches a value of 0. This



fact indicates that the measure of the voltage will be different depending on where the measure is taken.

On the other hand, from the Kirchhoff's Law of Current (KCL) we know that, at a given node<sup>1</sup> the current going to the node is equal to the current flowing out of it. The following equation indicates how the KCL works for this circuit. Given the node located at the point where  $v_1$  is, we have:

$$i_s = i_1 + i_2 \quad (4)$$

Also, from Ohm's law, we know can define  $v_0$  as follows:

$$v_0 = Ri_1 \text{ or } i_1 = \frac{v_0}{R} \quad (5)$$

We need to analyze and define the effect of the other two elements involved in the circuit. In equation (5) we have already described the effect of the resistance on the system. Now we describe the influence of the capacitor (C) on the system:

$$v_1 = \frac{1}{C} \int i_2 dt \quad (6)$$

From equations (4) and (5) we can rearrange equation (6) as follows:

$$v_1 = \frac{1}{C} \int (i_s - i_1) dt = \frac{1}{C} \int \left( i_s - \frac{v_0}{R} \right) dt \quad (7)$$

This is a significant aspect to take into account, mathematically speaking, given that this term is part of the final expression. A student should be able to recognize that although this term involves the variable to model,  $v_0$ , it is necessary to derive it so that we eventually obtain the ODE we are look for.

---

<sup>1</sup> A node is a point on the circuit where two or more elements meet.

The following is a key step in the solution of the task. It involves the analysis and description of the effect of the inductance (L) in the circuit, but also, it involves the other two elements analyzed and thus, it allows obtaining the ODE.

The effect of the inductance only, is given by the difference of voltage ( $v_1 - v_0$ ). In other words, we have:

$$v_1 - v_0 = L \frac{di_1}{dt} \quad (8)$$

Now, we are going to rearrange equation (8) as follows:

$$v_1 = \frac{1}{C} \int \left( i_s - \frac{v_0}{R} \right) dt \quad \text{and,}$$

$$i_1 = \frac{v_0}{R} \quad \text{then,} \quad \frac{di_1}{dt} = \frac{1}{R} \frac{dv_0}{dt}$$

So we have:

$$\frac{1}{C} \int \left( i_s - \frac{v_0}{R} \right) dt - v_0 = \frac{L}{R} \frac{dv_0}{dt}$$

At this point, we have identified three terms containing  $v_0$ . However, in order to obtain an expression of the form:  $a \frac{d^2x}{dt^2} + b \frac{dx}{dt} + cx = 0$  or  $f(y)$ , as mentioned earlier, we must derive on both sides of the equation, thus:

$$\frac{1}{C} \left( i_s - \frac{v_0}{R} \right) - \frac{dv_0}{dt} = \frac{L}{R} \frac{d^2v_0}{dt^2}$$

or

$$\frac{L}{R} \frac{d^2v_0}{dt^2} + \frac{dv_0}{dt} + \frac{v_0}{CR} = \frac{i_s}{C}$$

Finally, multiplying by CR, we have:

$$LC \frac{d^2 v_0}{dt^2} + RC \frac{dv_0}{dt} + v_0 = Ri_s$$

Similar to Task 1, we have obtained a linear second order differential equation with constant coefficients. There is an input function,  $i_s$ , acting as the input function so this is a non-homogenous ODE.

### Description and Solution of Task 3.

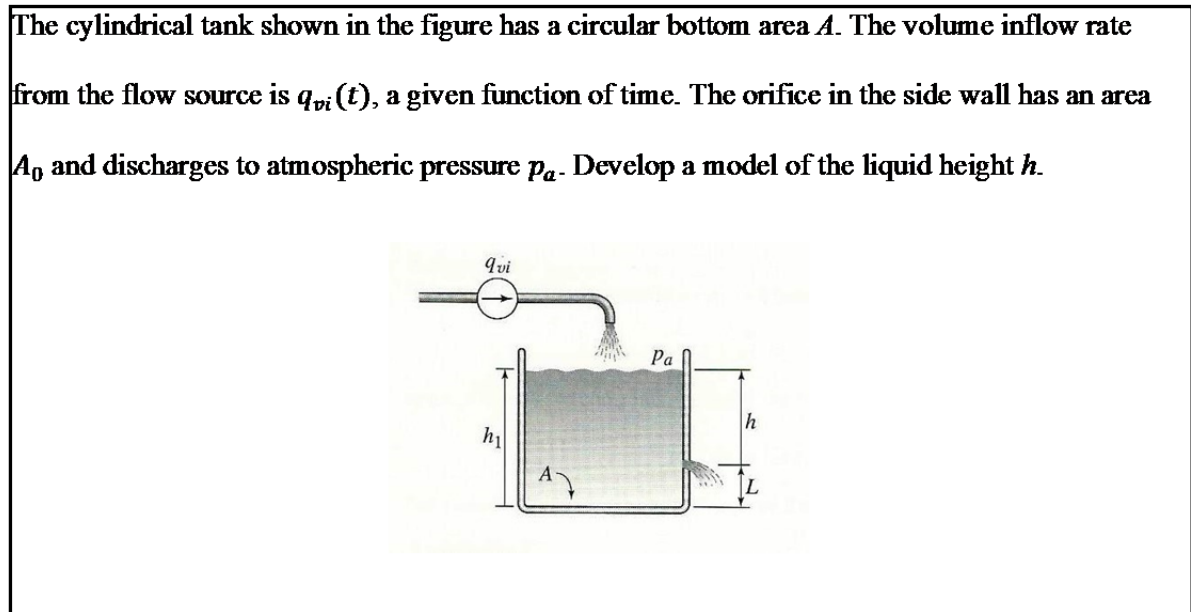

Figure 7. Task 3. (Taken from Palm, 2005, p. 397-398)

I now discuss the third, and final, task given to the students during their interviews. I note that this task, which involves a fluid context, was the easiest and was given to see how students might work with a fairly uncomplicated context. This task requires the analysis of the section of the tank that encompasses the height  $h$ , which is the magnitude of interest. In this way, the volume of the tank in this section is given by the expression:  $V = Ah$ . This volume  $V$  will vary depending on the input and output flow ( $q_{vi}$  and the orifice at  $L$ , respectively). The variation of the volume (or rate of change) is given by the expression  $\frac{dV}{dt}$ , or the derivative of  $V$ , thus we have:

$$\frac{dV}{dt} = A \frac{dh}{dt}$$

This first aspect of the task entails the recognition of related rates of change, an important topic in calculus. On the other hand, by determining the rate of change of the volume, we came up with a derivative of the variable we are analyzing.

We can adapt Bernoulli's equation to this tank situation. The Bernoulli's principle considers the conservation of energy in fluid systems. In brief, the rate of change of the volume of volume flowrate is equal to the difference of the input and output flowrate:

$$\frac{dV}{dt} = A \frac{dh}{dt} = q_{vi} - q_{vout} \quad (9)$$

From equation (9) we know we are close to obtain the model for h. The only term to define is  $q_{vout}$  which relates the volume flowrate at the orifice at L.

$$q_{vout} = C_d A_0 \sqrt{2gh} \quad (10)$$

Where  $C_d$  is the discharge coefficient for the orifice,  $A_0$  is the area of the orifice and g is the gravity constant.

Now equation (9) can be rewritten as follows:

$$A \frac{dh}{dt} = q_{vi} - C_d A_0 \sqrt{2gh} \quad (11)$$

In this case we have obtained a non-linear first-order differential equation given that the variable h is raised to the  $\frac{1}{2}$  power. At this point, students are not required to know the processes to solve this kind of equations; however, they are expected to understand and recognize the elements that make up this type of ODE.

## Potential Readouts and Causal Nets

Now that I have presented an expert's version of how the tasks could be solved, I provide a list of likely readout strategies and causal net elements needed to solve each of the tasks. I conceptualized of this list before performing the analysis, in order to have specific items to look for during analysis, though, of course, I left open the possibility of detecting additional readouts and causal net elements as well. In Table 2. I present the potential readouts strategies and causal net elements of each task, one at a time. I give the symbols likely to be associated with the readout or causal net element, the interpretation or association for each, and the code I use for ease in referring to these readouts and causal net elements in the results section. This list of readouts and causal nets for each of the tasks was contrasted with the work done by the students and analyzed matches as well as missing aspects in their work compared with the expert's solved tasks.

*Table 2.*

List of potential readouts for task 1.

Task element	Possible readout	Code
$y$	Input function that makes the system (pendulum) to experience motion (Useful to obtain the expression to model the system behavior).	T1RO01
$k_2$	Spring 2 constant (To calculate the force and eventually, the moment caused by spring 2)	T1RO02
$c$	Damping constant (To calculate the force, and eventually, moment caused by the damper)	T1RO03
$L_2$	Distance from the point of rotation of the lever (pendulum) (To calculate the moment caused by the elements attached to that end)	T1RO04
$\theta$	Amplitude of the pendulum caused by the elements of the system. This is the variable that represents the output $\theta(t)$	T1RO05

$L_1$	Distance from the point of rotation of the lever (pendulum) (To calculate the moment caused by the elements attached to that end)	T1RO06
$k_1$	Spring 1 constant (To calculate the force and eventually, the moment caused by spring 1)	T1RO07
Small $\theta$	Indication that the amplitude of rotation is so small that one can infer $\sin \theta = \theta$	T1RO08
Input $y(t)$	Input function that makes the system (pendulum) to experience motion (Useful to obtain the expression to model the system behavior)	T1RO09
Output $\theta(t)$	Function of interest. The ODE to obtain represents the behavior of the motion of the pendulum	T1RO10
Equilibrium $y = \theta = 0$	When $y = 0$ , $\theta = 0$ too.	T1RO11
Pendulum (bar/lever)	Indicates that the system has a second derivative of $\theta$ and includes the moment of inertia " $I$ "	T1RO12

Following is a list of potential causal nets that a student might come up with as he/she solved Task 1. These were also contrasted and compared with the work done by the students and identify potential gaps and difficulties.

Table 3.

List of potential causal nets for Task 1.

Elements identified from the readouts	Possible causal net element	Code
$y / \dot{y}$ (highlighted)	This variable represents the input function (or magnitude) that affects the system and ultimately has an effect on $\theta$ . It only acts on the subsystem ( $k_2, c$ ) $k_2 L_2^2 \theta - k_2 L_2 y$ $c L_2^2 \dot{\theta} - c L_2 \dot{y}$	T1CN01
$k_2$	Spring 2 constant is used to calculate the force and eventually moment caused by that spring. $k_2 L_2^2 \theta - k_2 L_2 y$	T1CN02
$c$	Damping constant is used to calculate the force and	T1CN03

	<p>eventual moment caused by the damper</p> $cL_2^2\dot{\theta} - cL_2\dot{y}$ <p>It also indicates the existence of a first derivative</p>	
$L_2$	Distance from the point of rotation of the lever (pendulum), it is part of the calculation of the moments generated by the damper and spring 2	T1CN04
$L_1$	Distance from the point of rotation of the lever (pendulum), it is part of the calculation of the moment generated by the spring 1	T1CN05
$k_1$	Spring 1 constant is used to calculate the force and eventually moment caused by that spring.	T1CN06
$\theta$	It indicates that the system rotates, hence the ODE is composed by a number of expressions implying moments. There is a sum of moments	T1CN07
Small $\theta$	Indication that the amplitude of rotation is so small that one can infer $\sin \theta = \theta$	T1CN08
Input $y(t)$	Input function that makes the system (pendulum) to experience motion (Useful to obtain the expression to model the system behavior)	T1CN09
Output $\theta(t)$	Function of interest. The ODE to obtain represents the behavior of the motion of the pendulum	T1CN10
Equilibrium $y = \theta = 0$	When $y = 0$ , $\theta = 0$ too.	T1CN11
Pendulum (bar/lever)	Indicates that the system has a second derivative of $\theta$ and yields the expression $I\ddot{\theta}$	T1CN12
The existence of many elements	Indicates that their effect on the rotation of the pendulum will be given by the summation of moments equal to the product of the moment of inertia times $\ddot{\theta}$ . Integrates all the components in the ODE	T1CN13

Table 4. and Table 5. show the potential readout strategies and causal nets for Task 2. These were used with the same purposes as those for Task 1.

Table 4.

List of potential readout strategies for Task 2.

Task element	Possible readout	Code
$i_s$	Supply current, acts as the input element or function. It will be part of the ODE	T2RO01
$i_1$	Current going through and affected by L and R. It is seen after the node at $v_1$ .	T2RO02
$i_2$	Current going through and affected by C. It is seen after the node at $v_1$	T2RO03
$v_0$	Difference of potential. It is the quantity to be analyzed. The ODE obtained is given in terms of this dependent variable and its derivatives	T2RO04
$v_1$	Difference of potential. Voltage at node $v_1$ . Influenced by the effect of the capacitor C	T2RO05
C	Capacitor. It is an element that affects the behavior of the voltage $v_1$ and current $i_2$	T2RO06
R	Resistor. It is an element that affects the behavior of the voltage $v_0$ and current $i_1$	T2RO07
L	Inductance. It is an element that affects the difference of potential ( $v_1 - v_0$ ) and $i_2$	T2RO08

Table 5.

List of potential causal nets for Task 2.

Elements identified from the readouts	Possible causal net element	Code
$i_s$	Supply current, acts as the input element. It will be part of the ODE. Possible use of Kirchhoff Current's Law ( $i_s = i_1 + i_2$ )	T2CN01
$i_1$	Current going through and affected by L and R. It is seen after the node at $v_1$ . Possible use of Kirchhoff Current's Law ( $i_s = i_1 + i_2$ )	T2CN02



	Also, $v_0 = Ri_1$	
$i_2$	Current going through and affected by C. It is seen after the node at $v_1$ . Possible use of Kirchoff Current's Law $(i_s = i_1 + i_2)$ $v_1 = \frac{1}{C} \int i_2 dt$	T2CN03
$v_0$	Several inferences may come from this element. These are accounted for in the solution of the task from the expert's perspective. $v_0 = Ri_1$	T2CN04
$v_1$	Difference of potential. Voltage at node $v_1$ . Influenced by the effect of the capacitor C $v_1 = \frac{1}{C} \int i_2 dt$	T2CN05
C	Capacitor. It is an element that affects the behavior of the voltage $v_1$ and current $i_2$ $v_1 = \frac{1}{C} \int i_2 dt$	T2CN06
R	Resistor. It is an element that affects the behavior of the voltage $v_0$ and current $i_1$ $v_0 = Ri_1$	T2CN07
L	Inductance affecting the difference of potential and current $i_2$ $v_1 - v_0 = L \frac{di_1}{dt}$	T2CN08

Finally, in the same way as I did with the other two tasks, I present Table 6. and Table 7 that correspond to the possible readout strategies and causal nets for task 3. This task, in contrast with the first two tasks, contained elements that did not need to be used as part of the set of readouts or

inferences necessary to obtain the ODE. Specifically, the terms  $L$ ,  $h_1$  and  $p_a$  could be set aside without affecting the solution process of this task.

*Table 6.*

List of potential readout strategies for Task 3.

<b>Task element</b>	<b>Possible readout</b>	<b>Code</b>
$q_{vi}$	This is the flowrate of the liquid entering the tank (students were asked to assume water)	T3RO01
$p_a$	Atmospheric pressure exerted on the water surface, not essential for the analysis	T3RO02
$h_1$	Height of the tank, not essential for the analysis	T3RO03
$h$	Quantity to be analyzed. The ODE to obtain is given in terms of this dependent variable and its derivatives	T3RO04
$A$	Area of the tank. Useful to calculate the volume of the tank and its rate of change	T3RO05
$L$	Height at which the orifice in the tank is located, not essential for the analysis	T3RO06
Orifice at $L$	Useful to calculate the flowrate out of the tank	T3RO07
Tank	Part of the system to be analyzed in which the variation of the $h$ occurs	T3RO08

Table 7.

List of potential causal nets for Task 3.

Elements identified from the readouts	Possible causal net element	Code
$q_{vi}$	This flowrate is making the height of the tank increase. It is related to the Bernoulli's equation $\frac{dV}{dt} = A \frac{dh}{dt} = q_{vi} - q_{vout}$	T3CN01
$p_a$	It is an indicator of the surrounding conditions of the problem. Not relevant for the purposes of the task	T3CN02
$h_1$	Height of the tank. This parameter is not relevant to the solution of the task	T3CN03
$h$	Quantity to be analyzed. The final ODE will be given in terms of this dependent variable and its derivatives. It seems that the ODE will not contain second order terms	T3CN04
A	Area of the tank. Useful to obtain the volume of the tank. $V = Ah$	T3CN05
L	This parameter is used only as a reference. From this distance, water level changes, characterized as $\frac{dh}{dt}$	T3CN06
Orifice at L	This parameter is related to the flowrate coming out of the tank $q_{vout} = C_d A_0 \sqrt{2gh}$	T3CN07
Tank	Element of the system where the variation of the quantity "h" occurs. It can be used as a control volume	T3CN08

### Interviews

For the interviews, I scheduled two sessions with each student. In the first session I started by talking about their responses to the survey and explained how the sessions would be conducted. I informed them that the first session would take about 45 minutes in which they would solve Task 1. I made sure that they had recently studied the topic of mechanical systems in

their system dynamics class in order to facilitate their thinking process. The sessions were video recorded and students were asked to write and speak any idea that came to their minds as they were solving the task. I also kept records of their work on the papers provided during the task.

About three weeks later I scheduled the second session. This time students were asked to solve Tasks 2 and 3. Since this interview focused only the two tasks, each student took less than 40 minutes overall to solve or at least work on the two exercises the best they could. All sessions were individual and the students relied on their knowledge only. That is, they did not count on the help of any textbook, sheet of formulas or any other external help. This is a very important aspect to mention since some of them alluded to this fact and how it would facilitate the work. These aspects were taken into account as I present the results of the students' work.

### **Data Analysis**

The analysis of the students' work consisted on analyzing two sources, the video recordings of the interviews and students' written work. The main analytic tool was the written work, and the videos were used if clarification was needed for a student explanation or an element of their written work.

I first reviewed each video in order to get an overall sense of how each student worked with each task. This state enabled me to sketch their overall solution path. It was useful to begin to perceive possible readouts and the causal nets for the students. After the first review of the videos, most of the work was focused on the students' written work. I performed the analysis in three stages, where the first stage consisted of two simultaneous parts. I now proceed to describe how each stage of the analysis was completed.

## Stage One

The first stage consisted, first, of locating the readouts students used during the solution of the task. I identified those elements that students considered as relevant to use in order to obtain the ODE. The lists I provided of possible readout strategies in the previous section was helpful to anticipate the kinds of things that might make up readouts for these students. Any readout element that matched one in my list in the previous section was labelled as such. However, I also recorded readouts that were not in my anticipated list. To identify a readout, any time a student referred to a symbol or a part of the prompt and made an interpretation of it, I identified that as an instance of a readout strategy. I recorded what the nature of that readout strategy was, in terms of what they interpreted that symbol, part of the diagram, or wording of the task to mean. In the same way, the second stage consisted of identifying the inferences made by the students using the readouts with which they could eventually obtain an expression that represented an ODE model of the system. Most of the work I did in these two parts of the first stage consisted on identifying the readouts and causal nets, as the students worked on the tasks. I identified students' readouts when they considered a certain element as relevant for his/her analysis. For example, in task 1, one of the elements was labelled as " $k_1$ ". This was the spring located at the top of the picture (see Figure 4). The student could state that this element somehow influenced the system and was part of the ODE, or that this spring produced a force acting on the pendulum or any similar statement; this is an indication that the student "sees" this piece of information as relevant to set up the ODE of the system. In this case, that is considered a readout. Most of the readouts were listed in the tables shown earlier, so if a readout matched one in the table then it was labelled with the assigned code for convenience.

On the other hand, a further step consisted of analyzing how the student used those readouts. Continuing with the example of the spring 1 from task 1 ( $k_1$ ), a possible causal net implied the recognition of this element yielding a moment<sup>2</sup>. In this case, the student infers that the force of the spring produces a moment defined by the product of the force and the distance from the center of rotation, for this task specifically it is defined as  $k_1 L_1^2 \theta$ . Thus, if a student showed evidence in his/her written work of this expression, then it was evidence of an activation of the causal net for that corresponding readout, spring 1. Similarly as with the readouts, I listed potential causal nets for the tasks and if the causal net matched one in the table, it was labelled accordingly. As mentioned earlier, in addition to the list of potential readouts and causal net elements, I left open the possibility of detecting others that were used by the students as they worked on the tasks. These elements were recorded and were listed on a different table, as shown in the results section.

## **Stage Two**

In the theoretical background chapter I defined concept projections as the set of knowledge and strategies used by an individual in a context in which a concept is applicable. In this stage, I made use of the knowledge (readouts and causal nets) and attempted to infer the strategies used by the students from the set of readouts and causal nets that helped them solve the task. In other words, I operationalized these strategies so that I could find evidence of concept projections. As I described concept projections in the theory chapter, I used the example of quadratic equations to show the different representations in which these are presented. We defined concept projection of roots in the factored context, or in the trinomial context. Each concept projection involved a set of identifiable strategies and knowledge. In the same way, I

---

<sup>2</sup> A moment is defined as the product of a force times a distance from the center in rotational systems

attempted to categorize the different strategies students used to approach the tasks. Sometimes they used diagrams, or relied on the information from a specific equation or on the effects of the components of the system in its behavior. I spotted at those sets of strategies and knowledge and categorized them accordingly.

### **Stage Three**

In this stage, I examined each strategy to determine whether it was productive for the student in producing a solution to the task or not. This was done by observing (1) if the strategy helped them achieve any kind solution at all, (2) whether the solution was correct, and (3) whether the students had to revise their thinking or approach because of “dead ends.” In doing so, I was able to observe which readouts and causal net elements allowed some students to progress further than others. I was also able to observe difficulties students had during their solution process, and could conjecture as to the possible readouts and causal net elements that factored into the difficulty.

### **Pilot Study**

Before carrying out this study, I interviewed Patrick, an undergraduate mechanical engineering student. He volunteered for a pilot study in order to determine the possibility to use the coordination class theory as presented in this document. Patrick was asked to solve a mass-damper-spring system. Based on the theory, I identified the readouts and the causal nets although I did not extend the analysis to hypothesize about concept projections. I briefly describe how I identified the readouts and the causal nets in this pilot study.

In this task the student, Patrick, was asked to derive the equations of motion for the two masses labelled as  $m_1$  and  $m_2$  as shown in Figure 8. In Figure 9, there are four parts that comprised the analysis of readouts and causal nets. Section 1 indicates that this student was

attempting to make some inferences based on the information he saw as relevant (the readouts). He was trying to remember different formulas learned in the past and that could have something to do with the principle governing this system, Newton's Second Law. The first two equations in this section show that he recognized the effect of the spring in the system  $F=k(x)$ , also, he recognized the governing principle by writing the equation  $F=ma$ .

This last equation guided part of his reasoning in section 4 where he extended the expression in an attempt to include all the elements of the system. Section 2 in Figure 9 evidences Patrick's recognition of the two masses as being relevant to obtain the equation of motion; that is, these two drawings are readouts that, later on, are used to activate causal nets in sections 3 and 4 to obtain the ODE for one of the masses. Even though the expressions in sections 3 and 4 are not entirely correct, still we might find evidence of Patrick's attempts to use causal nets.

As I mentioned earlier, this pilot study helped me refine the process of identification of readouts and causal nets. I could notice how a student recognized the relevant information and not relying on the expert's view only. Similarly, a student might come up with varied inferences from what he/she "sees" from the task as well as the eventual selection of strategies; this pilot study also served this purpose. I used this experience to analyze students' work since it helped me to be aware of the different ways in which students might interpret the tasks and the elements in them. This pilot study also served as a reference to validate the possibility of applying the concepts of the coordination class theory in this kind of contexts.



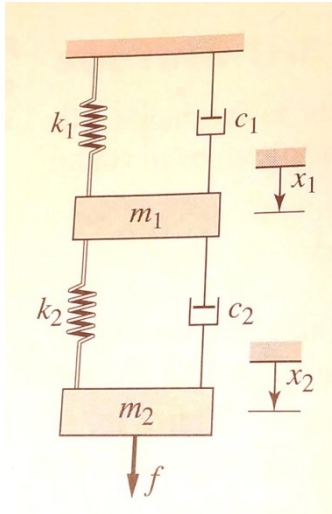

Figure 8. Mechanical system for the pilot study.

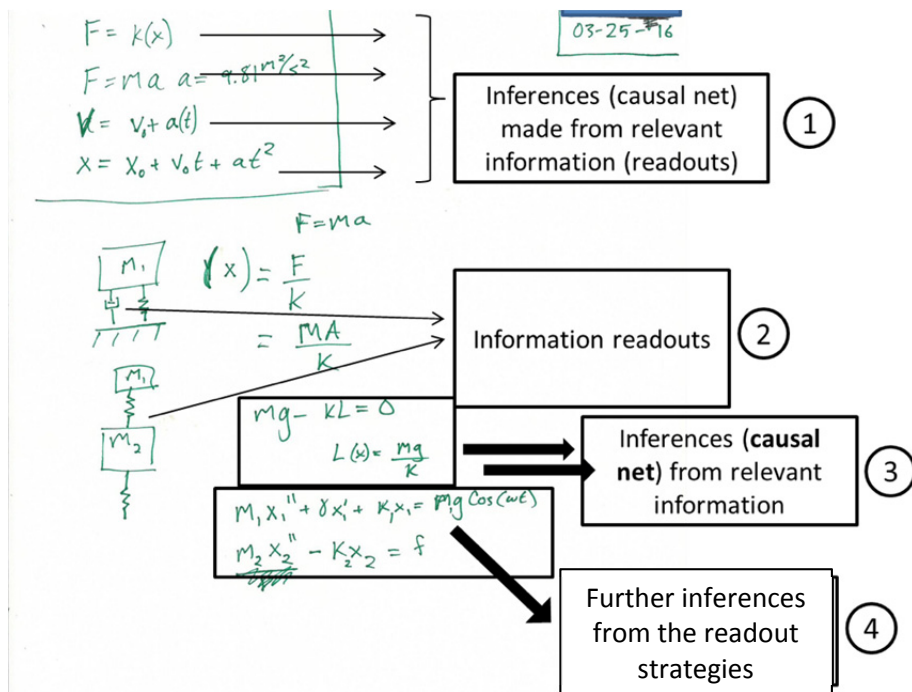

Figure 9. Analysis of a student's work in a pilot study.

## CHAPTER 5: RESULTS

In this results section, I start making an account of students' answers to the survey's questions in order to highlight their mathematical knowledge regarding ODEs. Then, I describe the tasks one at a time, starting with the first task for each student, then the second task and finally the third task. I describe how the five different students attempted to work out a completed differential equation and the processes they took to do that. Based on the stages described in the data analysis section, I describe the readouts I identified, then the corresponding causal nets. I also propose three overall solution strategies that emerged from the data by which the students were able to progress toward setting up the ODE. These strategies, together with the readouts and causal net elements that make them up, are considered to be concept projections of ODEs into these contexts.

Finally, I discuss other aspects from the students' written work, including decisions, strategies and the use of other elements that hindered their processes to obtain the requested ODE. Each student's description will follow this pattern and though I make attempts to make the account in the order described in this paragraph, in many passages I made mentions to all the stages because of the decisions made by the students as they solved the tasks.

### **Analysis of Students' Answers to the Survey**

Table 8 shows the relevant pieces of information given by the students on the survey. Some items were included from the initial conversation held in the first session of the interviews. In that segment I attempted to complement the information they provided in the survey. For question (1) related to what students understood for an ODE, the most common reference focused on recognizing a second order equation because of the existence of a second derivative of  $y$ , another common features were linearity and homogeneity although there were no explanations

related to these. Zane, Rebecca and Josh made mention of the fact that an ODE relates a variable and its derivatives while Harry and Kira did not go further with their explanations, especially Kira who had limited responses to all the questions in general.

With respect to questions (2) and (3) all of them related to the first and second derivatives, and all but Kira related these to the contexts with which they are more familiar with, mechanical systems, for this reason, they related these to velocity and acceleration. Question (4) related to the dependent variable; in this question three of the students thought of it in terms of position, matching what was mentioned about the previous questions (2) and (3) given the influence of the mechanical systems.

In question (5) students related the constants with “coefficients” of the function and the derivatives. Zane was the only one who indicated that these constants were related to the parameters of the system, trying to provide a better interpretation of these elements. Three of them, including Zane were more specific by relating these coefficients to the mass-spring-damper system, thus moving away from the mathematical background and showing more influence from the engineering and/or physical one. On the other hand, there was a general agreement as for what they understood for question (6), which was related to the difference between the ODE being equal to zero or any other value. There was consensus in indicating the when the ODE was not equal to zero, there was an external function acting on the system and made it a forced system. In this case there was no mention to any application or relation to an application from physics or engineering except by Kira who briefly explained that it could be a “step” function, a kind of function that is often used in the system dynamics course.

Table 8.

Students' survey answers

	Zane	Rebecca	Harry	Josh	Kira
(1) ODE	2 <sup>nd</sup> order  Homogenous  Linear  2nd derivative  Model that determines behavior of a given variable	Linear  Homogenous  2 <sup>nd</sup> order  Derivative with respect to one variable  Relation of variable with its derivatives	2 <sup>nd</sup> order  Homogenous  Relates to motion  Linear  First derivative of variable	2 <sup>nd</sup> order  Homogenous  Linear  Relation of variable with its derivatives	2 <sup>nd</sup> order  Variable and its derivatives
(2) $y''$	2 <sup>nd</sup> derivative Derivative of $y'$ acceleration	2 <sup>nd</sup> derivative of $y$ Acceleration	2 <sup>nd</sup> derivative acceleration	2 <sup>nd</sup> derivative Acceleration Slope of $y'$	2 <sup>nd</sup> derivative of $y$
(3) $y'$	1 <sup>st</sup> derivative of $y$ with respect to independent var.  Velocity	1 <sup>st</sup> derivative of $y$ with respect to independent var.  Speed	1 <sup>st</sup> derivative of $y$ with respect to independent var.  Velocity	1 <sup>st</sup> derivative of $y$ with respect to independent var.  Velocity  Slope of $y$	1 <sup>st</sup> derivative of $y$ with respect to independent var.
(4) $y$	Output function Position Response to input	A function that satisfies the ODE Position	Variable in function of time	Function Position	Changing variable
(5) Constants	Coefficients related to the characteristic eq.	Constants Relationship between function and its	Coefficients MBK system	Coefficients Linearity of the function	Mention of MBK

	System parameters MBK system	derivatives			
(6) Zero // Not zero	No forcing function or input  Non zero: Forced response + free response	External function applied to the system	Zero: Free response  Non zero: forced + free response Input to the system	No other forces involved  “Heterogeneous”	Zero: No input  Non-zero: step or forced response

### Analysis of Students’ Written Work for Task 1

#### Task 1 - Zane

At the beginning Zane recognized that the system in task 1 was governed by the principle contained in the Newton’s Second Law understanding that the summation of the forces was equal to the product of mass and acceleration, which in this case was the product of the moment of inertia and the angular acceleration. Zane recognized that the pendulum was subject to the forces exerted by the two springs and the damper and the ODE would contain this parameter,  $I$ ; in other words:  $\sum M = I\ddot{\theta}$ . This reasoning coincides with T1RO12, T1CN12 and T1CN13. From this moment on, he attempted to explore the possibilities to obtain the mathematical model of the system. Also, he considered relevant, and used in further steps, the direction of rotation of the pendulum. Zane used it to determine the sign of each term of the final ODE.

Figure 10 shows the first excerpts made by Zane. In these, there is evidence of his ability to recognize the pieces of information that he would require in order to set up the ODE. The pieces circled in the figure show those elements considered the readouts of his work and coincide with those predicted from the expert’s point of view.

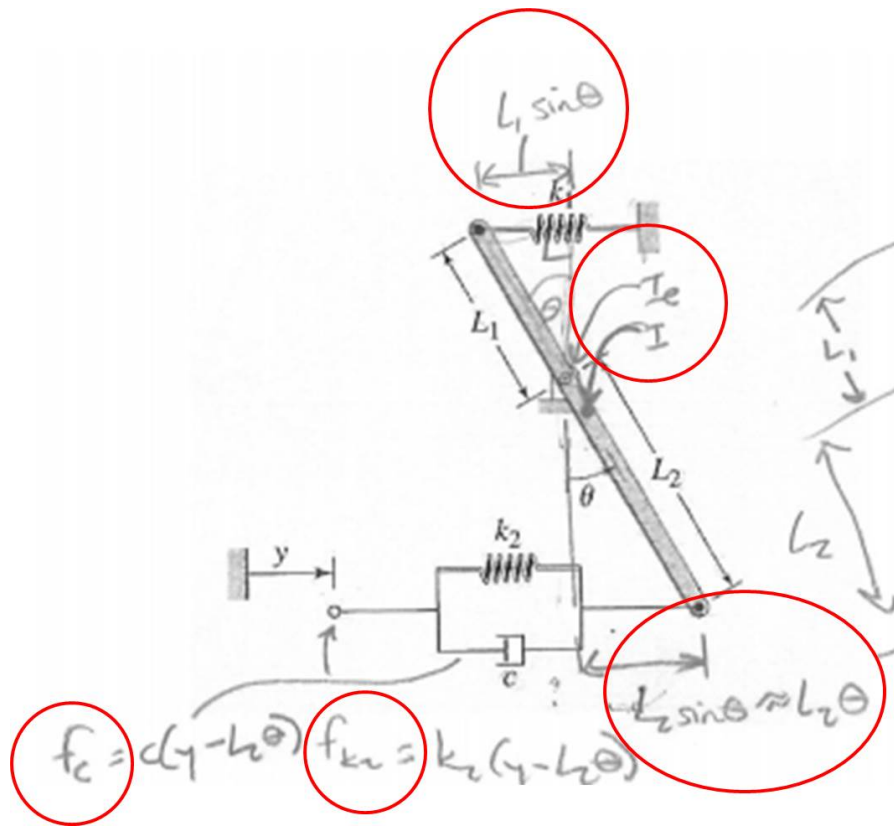

Figure 10. Zane’s initial excerpts from his work on Task 1.

Zane’s reasonings included the following: 1) The circles highlighting  $L_1 \sin \theta$  and  $L_2 \sin \theta$  are made equal to  $L_1 \theta$  and  $L_2 \theta$  from the fact that the problem statement indicates that this system is to be analyzed for “small  $\theta$ s”. This is evidence of both a readout and a causal net coded as T1RO08 and T1CN08 respectively. Also, he indicated that the mass of the pendulum was an aspect to take into account which, when rotated, was considered “ $P$ ” or “ $I_e$ ”, corresponding to T1RO12 and T1CN12. Finally, the expressions “ $f_c$ ” and “ $f_{k2}$ ” indicate the identification  $k_2$ ,  $c$ ,  $L_2$ ,  $L_1$  and  $k_1$  as part of the final ODE (T1RO02 to T1RO04, T1RO06, T1RO07), and inference of the effect these elements in the ODE (T1CN02 to T1CN06). Although there is no expression involving the first spring labelled as  $k_1$ , this was also included in the next stage of Zane’s work as suggested by the following lines: “So this force right here will be equal to  $k_1 L_1 \sin \theta$ , which is approximately  $k_1 L_1 \theta$  based off of the assumption that we make that it’s a small angle”.

Figure 10 shows the main focus of Zane's work. This section was the portion of work where he devoted more time and in which he made most of his reasoning. He used a Free Body Diagram (FBD) of the pendulum that includes all the elements affecting its rotating motion. From this FBD Zane obtained all the expressions necessary to set up the ODE for this system. The circled on the left of the figure indicates the first Zane's attempt to make sense of the task and also, the one from which the drawing on the right of the figure was taken which allowed setting up the final expression.

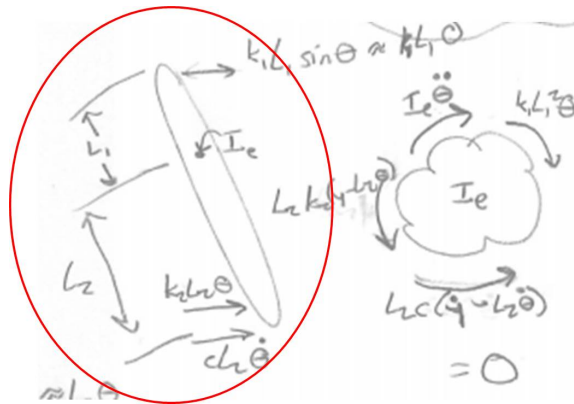

Figure 11. Zane's Free Body Diagram of the Pendulum.

As mentioned, from the FBD Zane obtained the ODE requested by the task.

$$I_e \ddot{\theta} + k_1 L_1^2 \theta - L_2 k_2 (y - L_2 \dot{\theta}) - L_2 k_2 (y - L_2 \theta) = 0$$

Figure 12 shows an equation that evidences that Zane took into account the remaining readouts and causal nets from the expected ones. Although this one is incomplete, his last expression, shown in Figure 12, is a correct ODE including all the elements. When compared with the tables of readouts and causal nets, Zane used all of them in his reasoning to obtain his ODE.

$$I_e \ddot{\theta} + k_1 l_1^2 \theta - L_2 c (\dot{\gamma} - l_2 \dot{\theta}) - L_2 k_2 (\gamma - l_2 \theta) = 0$$

Figure 12. Zane's ODE.

When using all the readouts and making the inferences linked to those readouts, Zane followed closely to what is described in the conceptual analysis of this task in the Methods section. This does not mean that in order to finish the task successfully, students must use this specific path. In contrast, there might be different ways to arrive to the same solution. In this case, and taking into account the third stage of the analysis, the relevant aspect that allowed Zane to use his readouts and facilitated the use of causal nets was his major use of the FBD. In this way, when referring to the set of knowledge and strategies that enable the application of the concept involved; that is, the relation between the quantity to be analyzed and its derivatives, the projection of the concept was facilitated by the FBD. After I make an account of the Zane's work I refer to this aspect in more detail.

$$I_e \ddot{\theta} + L_2^2 c \dot{\theta} + (L_2^2 k_2 + k_1 l_1^2) \theta = L_2 c \dot{\gamma} + L_2 k_2 \gamma$$

Output Input

Figure 13. Zane's final expression.

Finally, in this case, Zane did not seem to use strategies that hindered the process to obtain the ODE. His work was straightforward and very close to that of the conceptual analysis given in the methods section. The figure below shows an approximate flow of Zane's reasoning



in this task. The labels in rectangular shape correspond to readouts (RO) and causal nets (CN) correspondingly, the dashed arrows represent the approaches used by the students that activated inferences or readouts. These approaches are described in more detail as they are presented in the results of students' work. In this section I introduce the approach used by Zane. Finally, the dashed hexagon represents whether the student was successful, unsuccessful or partially successful in obtaining the ODE for a given task.

Figure 14 shows the set of readouts, inferences and strategies used by Zane as he solved task 1. He initially saw the relevance of the small angle (T1RO08) and the pendulum's inertia (T1RO12). Afterwards, the dashed line indicates the "Diagram approach" which, I argue, might be the concept projection of the concept of the ODE for this specific context. This approach, which will be explained in the next paragraph, helped Zane to activate the readouts and causal nets (the set of boxes below the diagram arrow) that led him to obtain the ODE for this task successfully. This figure is described in more detail below.

**Diagram strategy.** As shown in the description of Zane's development of Task 1, he used a Free Body Diagram as a tool to understand the behavior of the system as a whole but at the same time, it enabled him to identify the effect that each component posed on the system. The FDB (Diagram) facilitated his thinking process in these two ways.

In general, we might think of the diagram strategy as a general-to-specific approach that helps the student focus on the overall system initially. Then, within that system, the student can attend to individual elements without losing sight of the system as a whole. The diagram approach resonates with certain methods used in engineering to describe a given system, such as free-body diagrams, schematics or control volumes. Thus, as is seen in the following sections, students could apply this approach to any of the three tasks.

As described in the theoretical framework, we can consider this to be a projection of the *concept of differential equation in the context of diagrams*. This context enables the student to use the readouts and causal nets to obtain the properties or characterize the quantity involved.

**Summary of Zane's flow of reasoning for Task 1.** Each student's task has been described using figures similar to Figure 14. The rectangular shapes indicate either a readout (RO) or a causal net (CN). Each readout and causal net was coded for each task (T1, T2 and T3); also, each readout and causal net has been numbered as indicated in tables 2 to 7. In this manner, T1RO08 indicates the readout number 8 from Task 1 related to the identification of the small angle theta in this task. It is also important to note that if the rectangle, or any other shape, has a white font, then it means that it was properly activated and used in the task. On the other hand, when a rectangle is gray, it means that that specific readout or causal net was not activated, identified or improperly used; some of these readouts or causal nets were essential to complete the task, others were not relevant.

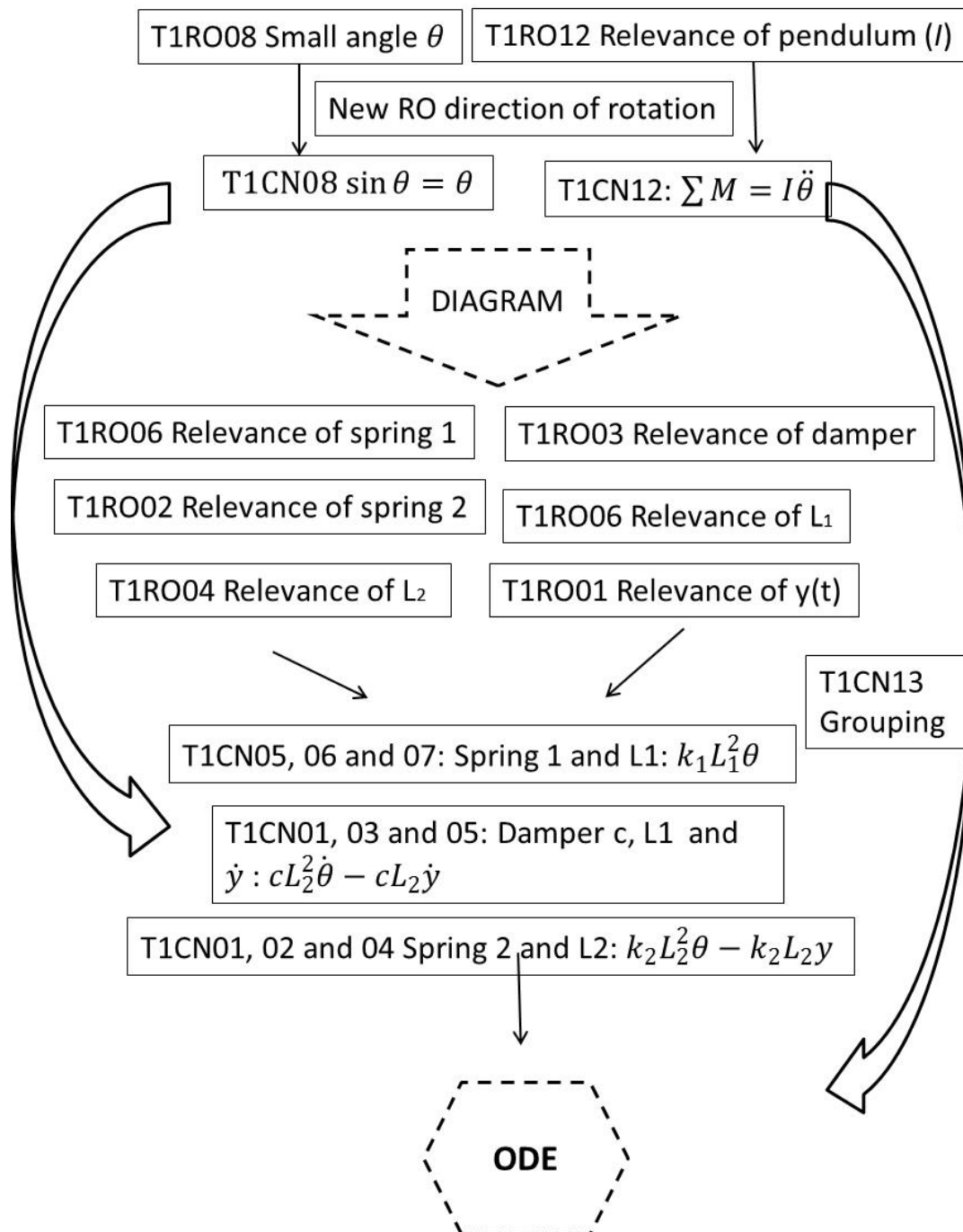

Figure 14. Zane's flow of reasoning for task 1.

On the other hand, the dashed arrows indicate the strategy used by the student to help him/her go further with the exercise. Also, at the bottom of each figure there is a dashed hexagon

that shows whether the student finished the task successfully, meaning that he/she found the right ODE for the task or not.

In this case, Zane started by recognizing the importance of the small angle  $\theta$  (T1RO08 and T1CN08) and the relevance of the pendulum (T1RO12 and T1CN12). Later on he used the Diagram strategy which activated both the necessary readouts and causal nets that eventually led him to obtain the ODE. The long and short arrows are used as an aid to indicate connection between readouts and causal nets. Zane showed an adequate performance along all the process to obtain the ODE. He came up with right causal nets and the strategy he chose (Diagram approach) served his purposes well.

### **Task 1 – Rebecca**

The first thoughts that Rebecca shared on this task were similar to those by Zane. She identified the relevance of the small angle  $\theta$ , T1RO08, and its implications, T1CN08. Next, she wrote expressions in the picture indicating the recognition of the effect of the elements ( $k_1$ ,  $k_2$ , and  $c$ ) as forces causing the pendulum to rotate corresponding to T1RO02, T1RO03 and T1RO07.

In her following work, Rebecca started to think about the governing principle influencing the system, the Newton's Second Law. In this way, she recognized that the pendulum was affected by the components, she recognized previously and from this reasoning she started to develop the main part of her work to obtain the ODE, T1RO12. She struggled for a moment but eventually came up with the following expression (T1CN12):

Handwritten equations on a white background:

- $\Sigma F = ma$  (crossed out with a diagonal line)
- $\Sigma F^* = 0$  (crossed out with a diagonal line)
- $\Sigma \tau = I\ddot{\theta}$
- $\Sigma \tau - I\ddot{\theta} = 0$

Figure 15. Rebecca's identification of Newton's Second Law for Task 1.

When asked about the meaning of the expression at the bottom in Figure 15, this is what she replied:

*Interviewer: What does that mean? That "I" and that "θ"?*

*Rebecca: The "I" is the inertia of the object and theta is the angular displacement, so  $\ddot{\theta}$  means that it's the second derivative with respect to time, meaning it's the angular acceleration*

The next thoughts implied the identification of the effect of each component on the pendulum. Rebecca proceeded to focus on each of the components of the system in order to finish the task. The expression below (Figure 16) indicates a partial solution of the task, she was able to come up with it by relying on the effect of each component. Figure 16 evidences readout strategies T1RO02, T1RO03 and T1RO07 that correspond to the recognition of the relevance of the two springs and the damper, as well as the distances L1 and L2 correspondingly. This figure also shows evidence of the use of causal nets that yield the moments produced by each component. In this case, the terms indicate a partial expression that is completely reported in the final answer.

$$F_{k_1} L_1 + F_{k_2} L_2 + F_c L_2 + I \ddot{\theta} = 0$$

Figure 16. Rebecca's partial ODE.

After obtaining this partial equation, Rebecca went back to analyzing each of the components in more detail. Figure 17 shows how she obtained analyzed each component identifying readouts and making the corresponding inferences. Expressions  $F_{k_1}$ ,  $F_{k_2}$  and  $F_c$  were obtained when the causal nets from the readouts  $\theta$ ,  $L_1$ ,  $L_2$ ,  $k_1$ ,  $k_2$ ,  $c$ ,  $y$  and  $\dot{y}$  were activated. In terms of the codes assigned, she activated the following causal nets TICN01 to 07 , and 09-10.

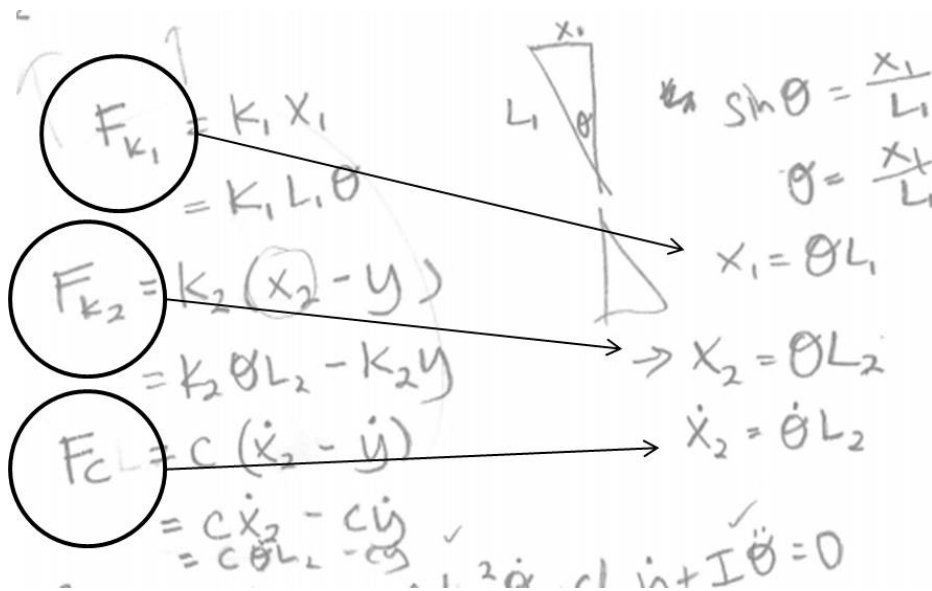

Figure 17. Rebecca's component-based analysis of the system.

Rebecca's analysis was carried out using a different approach than that used by Zane (FBD, or Diagram approach); instead, she focused on the components of the system to eventually put together all the pieces and set the equation. This approach is explained after Rebecca's account is completed. Rebecca was then able to finish this task successfully as shown in the figure below:

$$I\ddot{\theta} + \underbrace{CL_2^2}_{\dot{\theta}} + \underbrace{K_1L_1^2}_{\theta} + \underbrace{K_2L_2^2}_{\theta} = \underbrace{CL_2}_{\dot{y}} + \underbrace{k_2L_2}_{y}$$

Figure 18. Rebecca's final ODE.

The analysis of Rebecca's readouts and causal nets showed coincidence in most of the ones predicted by the conceptual analysis presented in the methods section. In both cases, Zane and Rebecca, there was no need to use T1RO11 and T1CN11 regarding the recognition of  $y = 0$  and  $\theta = 0$  because these elements from the initial conditions are more useful when it comes to solve the differential equation rather than at this stage when the student has to set up the expression.

The analysis of Rebecca's strategies used in conjunction with the set of readouts and causal nets, evidenced a strong rely on the components effect on the system. In contrast with Zane's strategy, who used an FBD, Rebecca did not need to turn to this type of tool. The way that she was able to arrive to a solution of the task focused mainly on the individual effect of the elements and thus the projection was possible. This approach is explained in more detail in the next paragraph after the description of Rebecca's flow of reasoning in the task.

**Summary of Rebecca's flow of reasoning for Task 1.** Figure 19 shows how Rebecca approached this task. First, she identified the relevance of the small  $\theta$  and the inertia of the pendulum. Next, she used the component-based strategy to analyze each component of the system (the effect of the springs and the damper along with the function  $y(t)$ ). She worked on the readouts and the corresponding causal nets activated by the concept projection from the component-based approach that led her to obtain the ODE successfully.

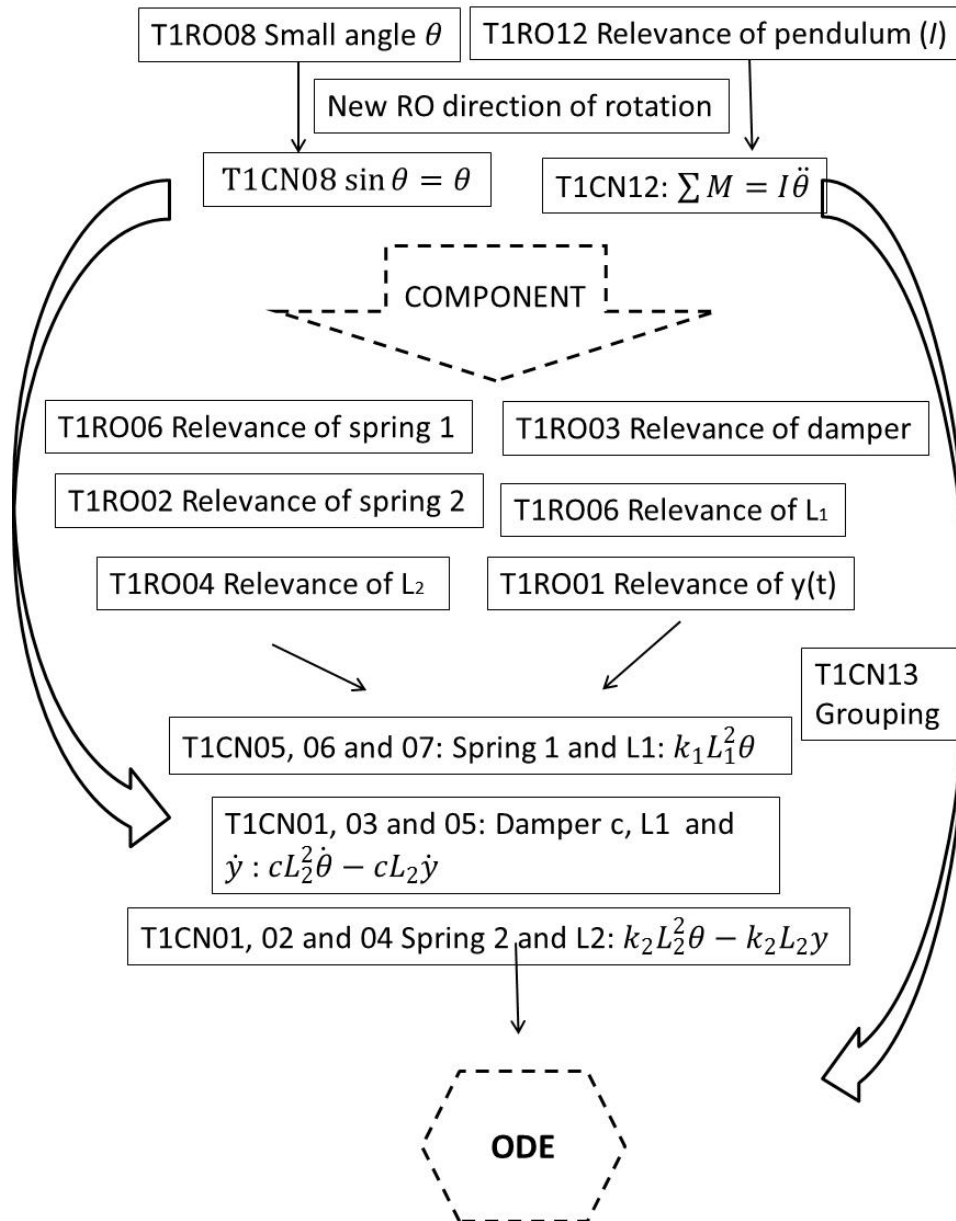

Figure 19. Rebecca's flow of reasoning for task 1.

**Description of the Component strategy.** This strategy consists on the identification and focus on the components of a system that are ultimately part of the modeling expression. For example, Rebecca's solution of the task presented a detailed description of the effect of each of the components of the system affecting the behavior of  $\theta$ . She identified the effect of the two springs as well as the damper in the system, and then determined how to put these elements



together into a coherent whole. There was no evidence of her using any diagram in order to understand the system's behavior and ultimately to obtain the ODE representing that behavior. Thus, the difference between the component and diagram approaches is the guiding framework of attention. Whereas the diagram approach places initial attention on the whole system, the component approach places initial attention on individual pieces of the system and on how those individual pieces relate to other information in the causal net that could be useful for producing an ODE. In summary, the diagram approach is general-to-specific, while the component approach is specific-to-general. It can also be considered as the *concept projection of the differential equation in the context of the components of the system*.

This strategy was supported by an initial step in which Rebecca identified the governing principle in the system (Newton's Second Law). This action was an important activating strategy; however, the main actions to obtain the final ODE, in the case of Rebecca, focused on the component-based strategy.

### **Task 1 – Harry**

Harry's first thoughts on the task involved the fact that the pendulum had a mass even though the task's statement did not mention that:

Harry: *the rod is not massless so... you need to draw a kind of reaction for the inertia of the rod (pendulum) because, as you know, like, something the weights ... is going to react [inaudible] the pendulum is going to react to gravity or something"*

Then, Harry wrote the term "mI" right next to the pendulum, and then the term " $m\ddot{\theta}$ ". This shows recognition of the role of the pendulum (T1RO12); however, the corresponding causal net (T1CN12) was not activated. This was a first indication of a potential unsuccessful setting up of the equation. See Figure 20.

$$mT \Rightarrow m\ddot{\theta}$$

Figure 20. Harry's misinterpretation of the pendulum's inertia.

After this initial analysis, Harry also indicated the importance of the small angle (T1RO08) and used it afterwards in the expressions dealing with  $\theta$  (T1CN08). His main reasoning was focused on the components of the system, in this way he obtained a partial expression, as shown in Figure 21, and led him to report his final ODE as seen on Figure 22.

$$L_2 \dot{\theta} c + L_2 \theta k_2 + L_1 \theta k_1 + (m \ddot{\theta}) = y(t)$$

Figure 21. Harry's partial setting up of the ODE.

Nowhere in Figure 21 Harry shows evidence of inferring the effect of the forces from the springs and the damper on the system, which at the same time should be observed in the component analysis. Thus, even though he identified all the readouts for the successful completion of this task, Harry did not make the right inferences that led to the proper representation of the system's ODE.

$$m \ddot{\theta} + L_2 \dot{\theta} c + (L_2 k_2 + L_1 k_1) \theta = y(t)$$

Figure 22. Harry's final ODE.

On the other hand, despite the fact that Harry recognizes the relevance of the input  $y(t)$  (T1RO09), he did not activate the causal nets necessary to imply this effect in the system (T1CN09). Hence, Harry's work was partially successful in the completion of this task.

**Summary of Harry's flow of reasoning for Task 1.** Regarding the strategies he activated for this task, Harry was mostly focused on a component-based analysis which was insufficient to help him coordinate the inferences to indicate a proper effect of the components of the system. His work on this task was limited to the excerpts shown in this account as well as those in which he reasoned about the small angle and some minor notes on the effects of the components. In this case, those notes did not lead him to express the moments caused by the springs and damper properly. Figure 23 represents an approximation of his reasoning during this task; those figures in grey shade represent inability to activate them. The one labelled with T1CN12 implied that he could not completely infer the fact that there was a rotating system. On the other hand, the rest of the gray rectangles are related to his difficulty to integrate the elements of the ODE properly to obtain the right expression. Among these we find T1CN13 Grouping which implied his inability to put all the elements together in the proper way to obtain a valid ODE for this system.

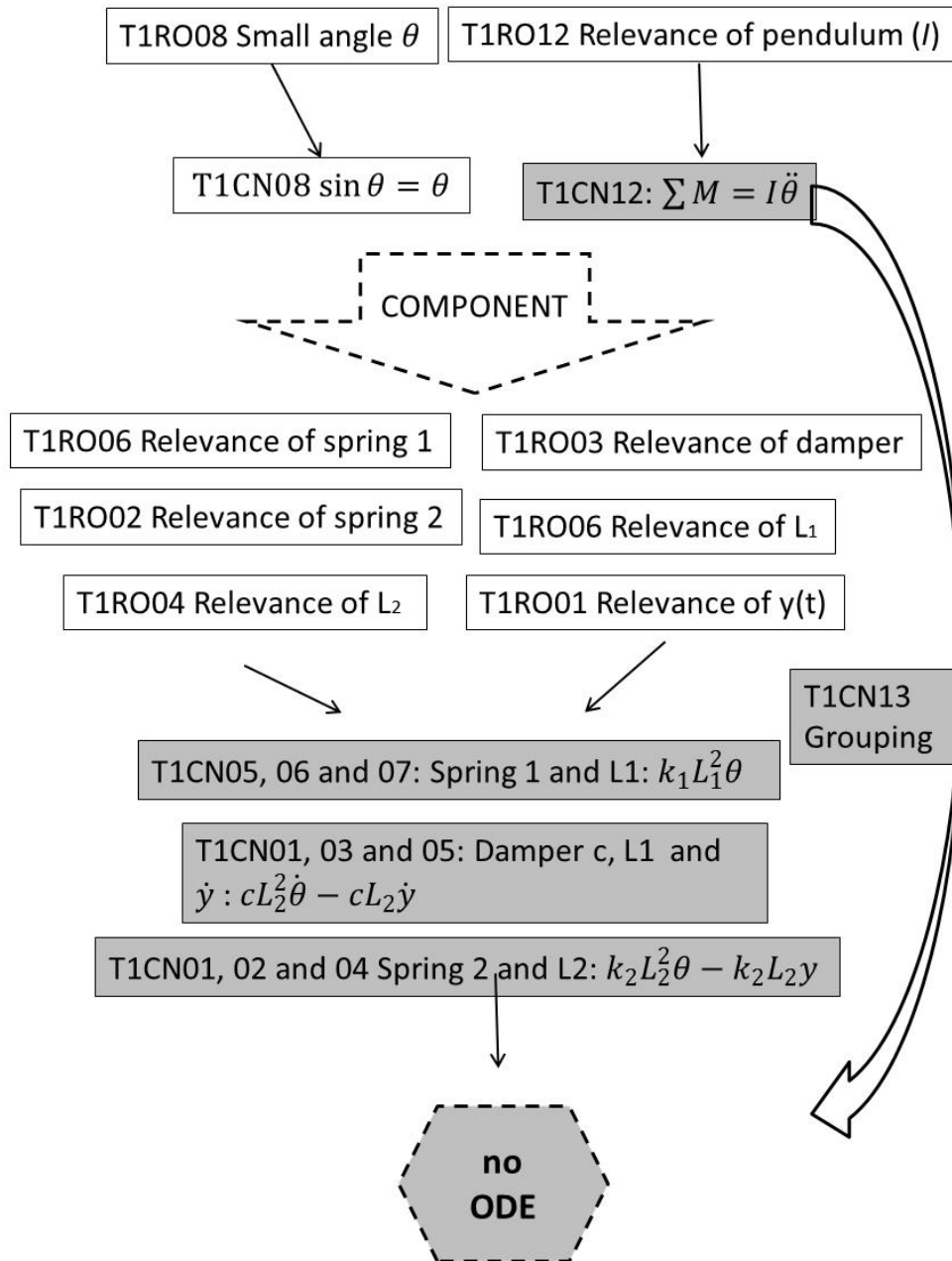

Figure 23. Harry's flow of reasoning for task 1.

### Task 1 - Josh

In his initial reasoning, Josh did as the other students had done. Given that the statement of the task indicated at its beginning that they were dealing with a small angle, this was the first recognition and eventual inference of the task thus implying T1RO08 and T1CN08. On the other hand, Josh drew a different version of the system, as shown in Figure 24. This diagram could be

interpreted as an attempt to draw an FBD but soon Josh abandoned the idea and continued working with another strategy.

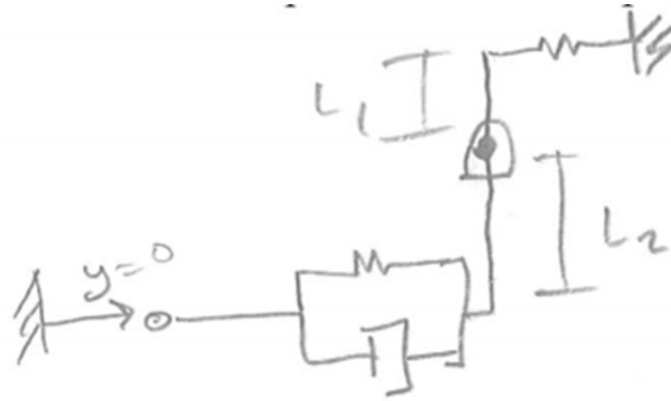

Figure 24. Josh first attempt to make sense of the system's behavior.

In his further efforts to set up the equation Josh was trying to find ways to relate the angle  $\theta$  with the input function  $y(t)$ . As he stated: "I'm trying to see how  $y$  is related to  $\theta$ ". He stated that the system had three different components that allowed him to obtain three different equations of motion because those three parts of components meant three degrees of freedom. Figure 25 shows the expressions he obtained with this analysis, one similar to the component-based analysis observed in Rebecca and Harry's work.

$$\begin{aligned}
 & \textcircled{1} \quad k_2 L_2 \theta + c L_2 \dot{\theta} = 0 \quad \downarrow \\
 & \textcircled{2} \quad I \ddot{\theta} = 0 \\
 & \textcircled{3} \quad K_1 x \\
 & \quad \quad K_1 L_1 \theta = 0
 \end{aligned}$$

Figure 25. Josh's preliminar expressions.

This strategy allowed him to identify the readouts required to go further with the process of obtaining the ODE. In this case, those related to the components of the system:  $k_1$ ,  $k_2$ ,  $c$ ,  $L_1$ ,  $L_2$ ,  $\theta$  and  $I$  (T1RO02 to T1RO07 and T1RO09, 10 and 12). The difficulties arose at the moment of activating the inferences for the components' action and also the influence of the input function on the system: T1CN01 to T1CN07 and T1CN09, 10 and 12. His last expression for the ODE evidences the lack of the proper inferences that could have led him to the right expression for the ODE. See Figure 26.

$$I \ddot{\theta} + c L_2 \dot{\theta} + (k_2 L_2 + k_1 L_1) \theta = y(t)$$

Figure 26. Josh's final expression.

As mentioned earlier, it seems like Josh used a modified component-based strategy; however this projection was not helpful in leading him to infer the effects of the input function on the system or the proper expression for the effects of the components on the system. On the other hand, during the preliminary conversation in which I assessed again Josh's knowledge of the basic notions of differential equations, Josh seemed acquainted with the techniques to solve differential equations, as seen on Figure 27, but this knowledge was not useful at this stage. This aspect is considered in more detail in the discussion section.

**Summary of Josh's flow of reasoning for Task 1.** Figure 28 shows Josh's flow of reasoning. His case was similar to that of Harry's. This meant that after an initial identification of the relevance the small angle and the use of the pendulum inertia, he started using a strategy to go further with the solution of the task. He used the Component approach, although he also made use of the Diagram approach. In T1CN12 he could not define the moments properly which was linked to the subsequent errors in the setting up of the effect of the components of the system; on

the other hand, in T1CN13 he could not group the elements in the right way. As a consequence his expression was not correct.

$$\mathcal{L}\{\ddot{x}\} = s^2 X(s)$$

$$s^2 X(s) + s X(s) + X(s) = 1$$

$$X(s)(s^2 + s + 1) = 1$$

$$\mathcal{L}^{-1}\{X(s) = \frac{1}{s^2 + s + 1}\}$$

$$x(t) = \underline{\hspace{10em}}$$

$$\ddot{x} + \dot{x} + x = 1$$

$$\ddot{x} = \ddot{x}$$

$$x = x_1$$

$$\dot{x} = x_2, \quad \dot{x}_1 = \dot{x}$$

$$\ddot{x} = \dot{x}_2, \quad \dot{x}_2 = \ddot{x}$$

$$x_1 =$$

$$x_2 =$$

} ODE 45

Figure 27. Excerpt from Josh's discussion about ODE solution techniques.

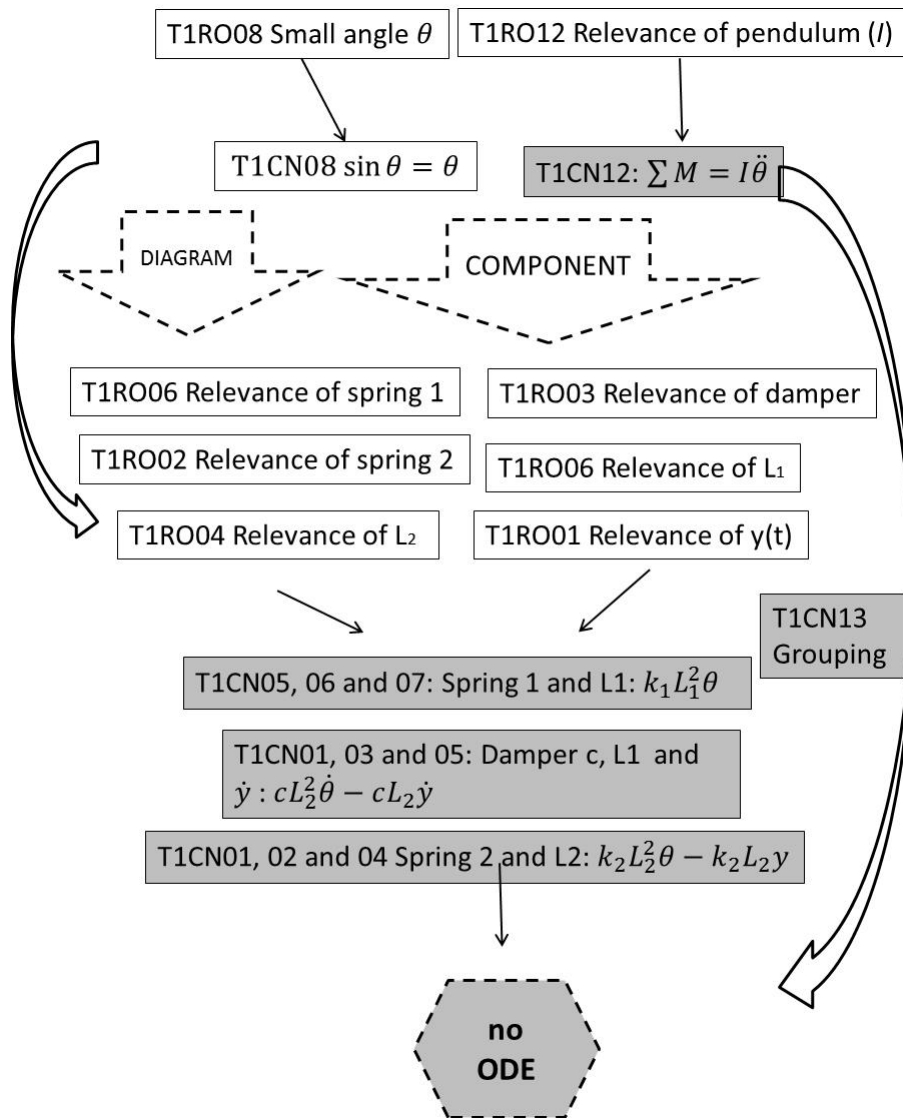

Figure 28. Josh’s flow of reasoning for task 1.

### Task 1 - Kira

Kira’s initial thoughts focused on making comparison of translational systems with this rotational one. She asserts the following:

Kira: “We’ve talked about equivalent inertias a lot and solving in terms of theta. So this theta in this problem is gonna be your “x””

Also, Kira related that equivalent inertia to the second derivative of theta, T1RO12 and T1CN12 as well as implicitly assumed T1RO08 and T1CN08, related to a small “theta”.



In a next step she stated: “actually, there is picture we always draw...”. implying the use of an FBD where she gets most of the readouts for this task. Figure 29 shows her work up to that point.

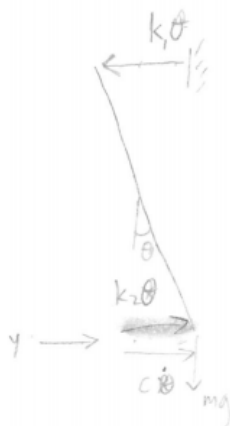

Figure 29. Kira’s FBD.

Figure 29 shows evidence of the identification of T1RO02 to T1RO07 as well as T1RO12, corresponding to the pendulum’s motion. It seems like at this point she has not found a way to include the function  $y(t)$  T1RO1, it was only by the end of her work that she includes it but not figuring out what role  $y(t)$  played in the ODE, T1CN01.

Kira also tried to figure out the effect of each component on the system, although she did it by recalling the equations corresponding to each component. At the same time she recognized that the governing principle, Newton’s Second Law would help her imply the final ODE. Figure shows this portion of her reasoning.

$$F = ma = m\dot{x}' = m\ddot{\theta}$$

$$F = cV = c\dot{x} = c\dot{\theta}$$

$$F = kx = k\theta$$

Figure 30. Kira's reasoning about the components of the system from the equations.

Figure 30 shows evidence of a complete recognition of the readouts corresponding to the components of the system (the two springs and the damper). However, there is still an incomplete deployment of the necessary inferences to conclude the task; that is, the effects of each of the components of the system as well as the function  $y(t)$  (T1CN02 to T1CN07, and T1CN12). In fact, Kira states the following at this point: *"I've got bits and pieces of it. It's the putting it together that's a little bit tricky..."*. This coincides with the findings at this point where she identifies the elements that contribute to obtaining the ODE but she fails to articulate them altogether to yield the required ODE. Furthermore, this seems to be another approach in an attempt to obtain the ODE; Kira tried to rely on the equations that govern the effects of the components on the system and use them to as a strategy to infer the equation of motion. This equation-based approach is explained right after Kira's work is analyzed.

Later on, Kira drew a diagram of the system in an attempt to depict the effects of each component, an FBD similar to the one drawn by Zane. Eventually, Kira came up with the expression shown in the picture below. In this ODE we might evidence that there is a term  $(mgL\theta)$  that is not seen in any other of the student's final ODE. Also, Kira's ODE shows  $y(t)$  but does not present how it affects the dependent variable.

$$I_e \ddot{\theta} + c\dot{\theta} + (k_2 - k_1)\theta + mgl\theta = \gamma(t)$$

Figure 31. Kira's final ODE.

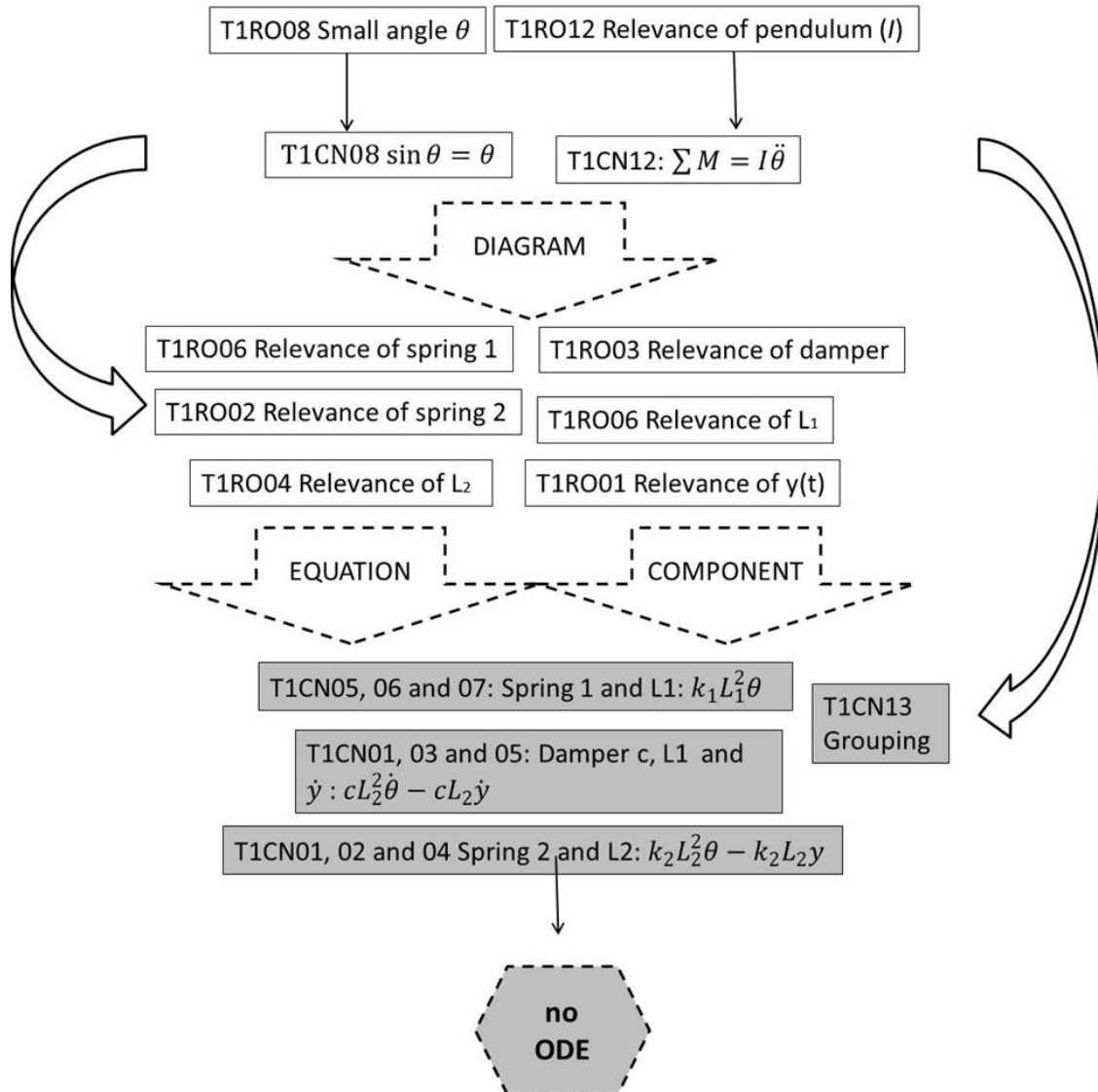

Figure 32. Kira's flow of reasoning for task 1.

**Summary of Kira's flow of reasoning for Task 1.** Kira identified, just like the other students, the relevance of the angle and the role of the pendulum's inertia. She used the Diagram strategy to help her notice the relevance and role of the elements of the system. She then

proceeded to use Equation and Component strategy to make an attempt to put together all the elements (T1CN13) of the ODE. However, similar to Josh and Harry, Kira got stuck on the impossibility to understand the role of the input function (T1CN01) and could not provide an accurate expression at the end even though she had noticed its relevance (T1RO01).

**Equation strategy.** This strategy seems to rely on the fact that there is a main equation representing the governing principle acting on the system. From that equation the student centers all his/her efforts to obtain the ODE by manipulating the equation or making substitutions into the equation. For example, as we see in the electrical context, the student might start his work recognizing the KCL and base all his/her reasoning on the equation  $i_s = i_1 + i_2$ . A student using this approach begins with this equation and attempts to identify how each part of the equation fits with the context in order to transform the base equation, through substitutions and other manipulations, into an ODE. In this case, we might consider this, the concept projection of the differential equation in the context of the equation.

In general, students used this strategy as an ancillary tool when solving Task 1. In the next two tasks we might notice that this strategy played a stronger role beyond that of only identifying the governing principle of the system.

### **Summary of the Strategies**

So far I identified three sets of strategies used by the students in order to assist them to solve the tasks: (1) Diagram strategy, (2) Component strategy and (3) Equation strategy. The diagram-based strategy involves the use of any diagram or depiction of the system in a simpler representation. This approach includes the identification of any element in the system that affects

the system behavior. In the following analysis of the tasks I describe other examples of Diagrams depending on the context; Free Body Diagrams are one of these examples.

The second strategy, the Component-based strategy, entails focusing on each of the system's components; infer its effects on the system and then figure out the integration of those components in the whole. As discussed earlier, the diagram approach is general-to-specific, while the component approach is specific-to-general.

The equation-based approach relies on an equation that governs the system's behavior and, by making substitutions and manipulations, converts the equation into an ODE. This approach was very useful for students when solving task 3, the fluid system, as we may see in the corresponding analysis.

### **Analysis of Students' Written Work for Task 2**

#### **Task 2 – Zane**

As task 2 was presented, Zane initially departed from the stated objective of producing an ODE that models the situation, and instead thought of the Laplace transform method. The Laplace method takes the domain and changes to be “ $s$ ”, a complex variable, instead of time ( $t$ ). The Laplace method is meant to facilitate the solution of this type of exercises, but at the same time, it avoids the issue of creating an ODE altogether. Thus, using the Laplace method steered Zane away from the initial goal of the task. Its complexities became a problem not only for him but for other students who decided to use this strategy to solve the task. On the other hand, the exercise taken from a textbook (Palm, 2005), was designed in such a way that students do not need to turn to the Laplace strategy to obtain the ODE.

After attempting the Laplace transform method, Zane then returned to the task of producing an ODE by writing an outline of the potential effects of the components of the circuit

in the system. In Figure 33 it can be seen that Zane recognized the relevance of all the elements of the system; that is: the currents ( $i_s$ ,  $i_1$ ,  $i_2$ ), the components: the capacitor ( $C$ ), the resistance ( $R$ ) and the inductance ( $L$ ); and the voltages ( $v_I$  and  $v_o$ ) (T2RO01 to T1RO08). With respect to the causal nets for this task, Zane could only activate those corresponding to the currents  $i_s$ ,  $i_1$  and  $i_2$  (T2CN01 to 03) as evidenced in the same picture.

Before finishing all his work for this task, Zane referred to the three expressions at the bottom of Figure 33:

*“so we could combine these relationships just the same way I am doing here [pointing at Laplace equation] in terms of Kirchhoff’s Current Law. It’s just that, since they’re time derivatives in voltage and current it’s a little bit harder to manipulate and integrate things”.*

What Zane expresses at this point indicates his lack of knowledge to finish his task successfully. He was not able to articulate strategies to allow him to coordinate the elements of which he already had information from. This is a situation in which it is possible to argue that he lacks the possibility to operate a concept projection. His first attempt entailed the tools provided by the Laplace method, eventually he tried to use the component-based strategy but he was not able to articulate the causal nets T1CN04 to T1CN08.

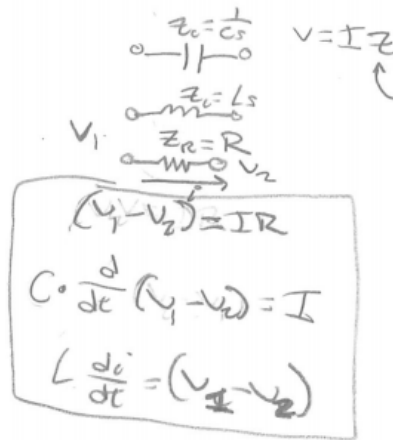

Figure 33. Zane's drafts for Task 2.

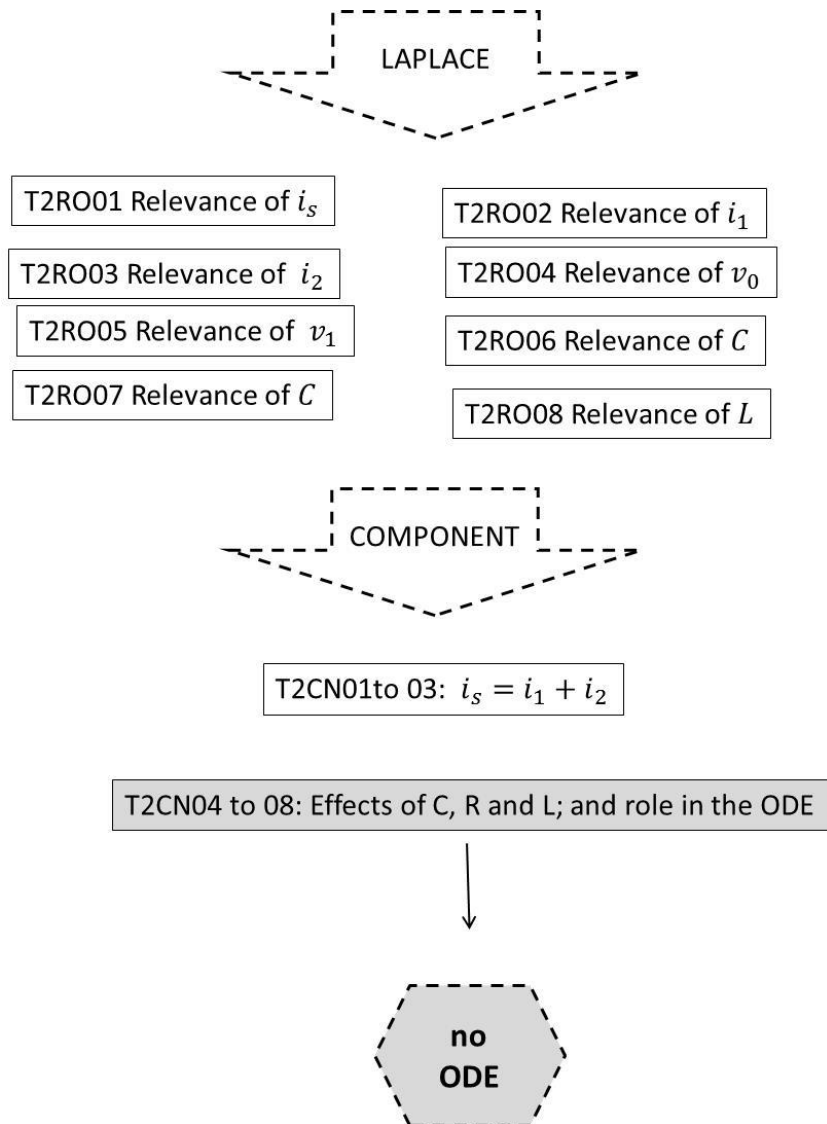
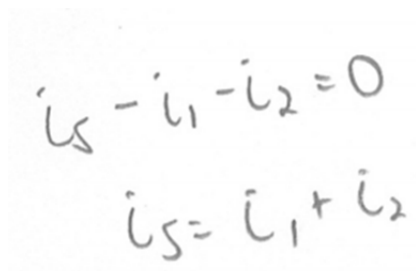

Figure 34. Zane's flow of reasoning for task 2.

**Summary of Zane’s flow of reasoning for Task 2.** Zane started this task by trying to use the Laplace method but given that he did not have any aid, like a textbook or a sheet of formulas to help him go further, he discarded this option. During that process though, he noticed the relevance of the elements of the system and thus he proceeded to use the Component strategy that allowed him to infer that the system was governed by the Kirchhoff’s Current Law, writing the equation shown in T2CN01 to 03 in the figure. However, he had problems to infer the specific role of the elements (T2CN04 to 08) not obtaining the desired ODE this time.

### **Task 2 – Rebecca**

Obtaining the model of the voltage  $v_0$  was a particular challenge for the participating students. Rebecca was probably the student whose final ODE showed the closest resemblance to the actual solution of the task. Rebecca initially recognized that the circuit was ruled by the Kirchhoff Current Law. From this law the individual may focus on the nodes of the circuit and infer that the current entering the node equals the current leaving the node. This indicates T2RO1 to 03 and T2CN01 to 03 correspondingly. See figure below.



The image shows two handwritten equations in black ink on a light background. The first equation is  $i_5 - i_1 - i_2 = 0$  and the second equation is  $i_5 = i_1 + i_2$ . The equations are written in a slightly slanted, cursive style.

*Figure 35.* Rebecca’s initial work on Task 2.



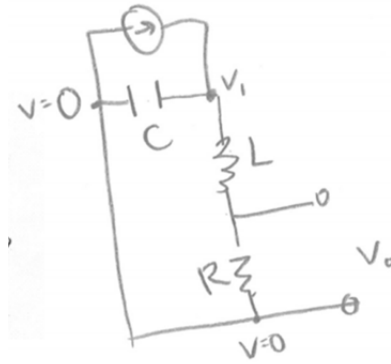

Figure 36. Rebecca's diagram of the circuit.

After writing this initial equation, Rebecca changed the strategy and started to focus on the components of the circuit. She did this in an attempt to integrate the results of both strategies to be able to obtain a new expression for  $v_0$ . She showed some understanding of the effect that each component exerted on the system; nevertheless, as it was not enough for her to go further, she tried drawing a sketch of the circuit as shown in Figure 36.

This rearrangement of the circuit allowed Rebecca to see a different perspective of the system as a whole and, at the same time, focus on the effect of the components, just as described previously, relevance of all the elements in the system: currents, voltages, capacitor, inductance and resistance (T1RO01 to T1RO08) as well as the equation taken from KCL: T1CN01 to 03. In fact, she tried to articulate what she had found as she used each strategy but her efforts were fruitless beyond that point. The figure below shows her last final answer for Task 2.

$$i_s = \int \frac{v_1}{C} dt + L \left( \frac{dv_1}{dt} - \frac{dv_0}{dt} \right)$$

$$-\frac{i_s}{L} + \frac{1}{L} \int \frac{v_1}{C} dt - \frac{dv_1}{dt} = \frac{dv_0}{dt}$$

Figure 37. Rebecca's final expression.

In Rebecca's case, we might notice her intention to obtain an expression where  $v_0$  is the dependent variable, as well as relating it with its derivatives; however, she lacked the elements (knowledge) to coordinate her ideas in a way that she could get to the right answer.

**Summary of Rebecca's flow of reasoning for Task 2.** Rebecca decided to start working on the Task using the Diagram strategy and then, almost immediately, the Component strategy. At doing this she activated the readouts for all the elements of the system. When these relevant elements were identified, she then proceeded to use the Equation strategy in an attempt to obtain the ODE. From the equation she could infer some of the effects of the elements but in an incomplete way (T2CN04 to 08); in this manner, although she was the one who got closer to a proper ODE for the system, she could not obtain that final expression. Specifically, for all the students, the role of the inductance (T2CN08) played a significant role to obtain the final expression but none of them could accurately infer it from the Task.

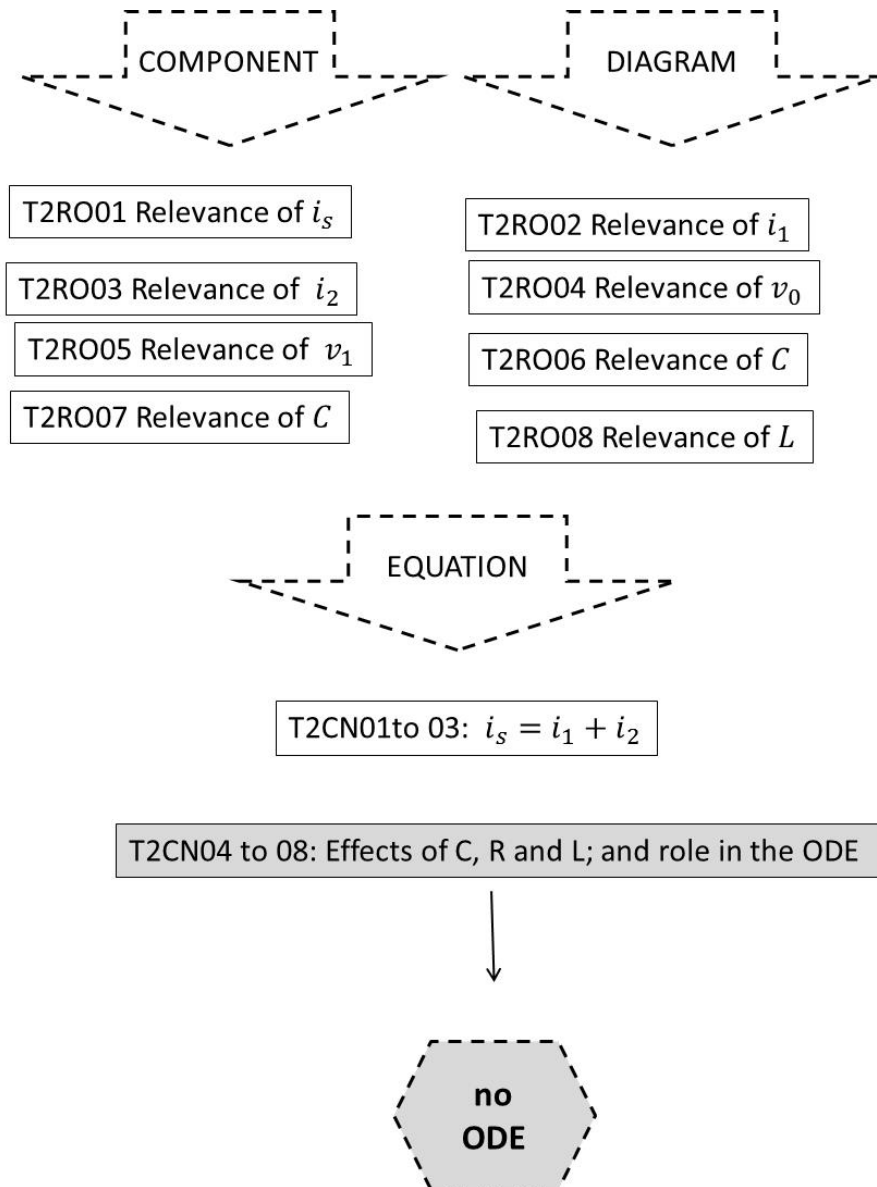

Figure 38. Rebecca's flow of reasoning for task 2.

### Task 2 – Harry

Similar to the other students, Harry chose to rely on the Laplace method to try to make sense of the task and solve the exercise. During the time he spent attempting to find the expression for the ODE, he did not use any other strategy. After identifying the governing law in the system, KCL, he stated this first equation implying the recognition of T2CN01 to 03 and their corresponding causal nets. Figure 39 shows the evidence for this statement.

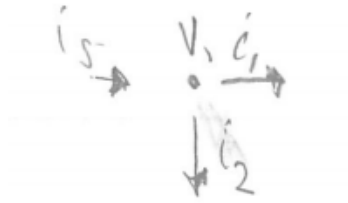

Figure 39. Harry's evidence of KCL use.

As mentioned earlier, Harry did not rely on any other strategy except by Laplace method so he tried to make several inferences that came up to be useless to obtain a valid expression. In fact, not much can be said about Harry's work up to this point given that his excerpts did not evidence usable elements to imply the proper use of the causal nets expected for this task (T2CN01 to T1CN08). Furthermore, his last expression lacked the basic elements expected from an ODE for this case; that is, there is no dependent variable or its derivatives as shown in Figure 40.

$$i_s = \frac{V_1 - i_3 R}{Z_L} + \frac{V_1}{Z_C}$$

output

Figure 40. Harry's final expression (ODE).

**Summary of Harry's flow of reasoning for Task 2.** Harry attempted to use the Equation strategy from which he identified some elements of relevance. However, although he had identified the governing principle, he did not go much further so he decided to turn to the Laplace method in an effort to obtain the final expression. At this moment, it seems like he lost track of the process; he could not infer what the role of each element was, and consequently failed to

obtain the ODE since this strategy did not allowed him to make the proper inferences or even identify the relevant information (T2RO04 to 07 and T2CN04 to 08).

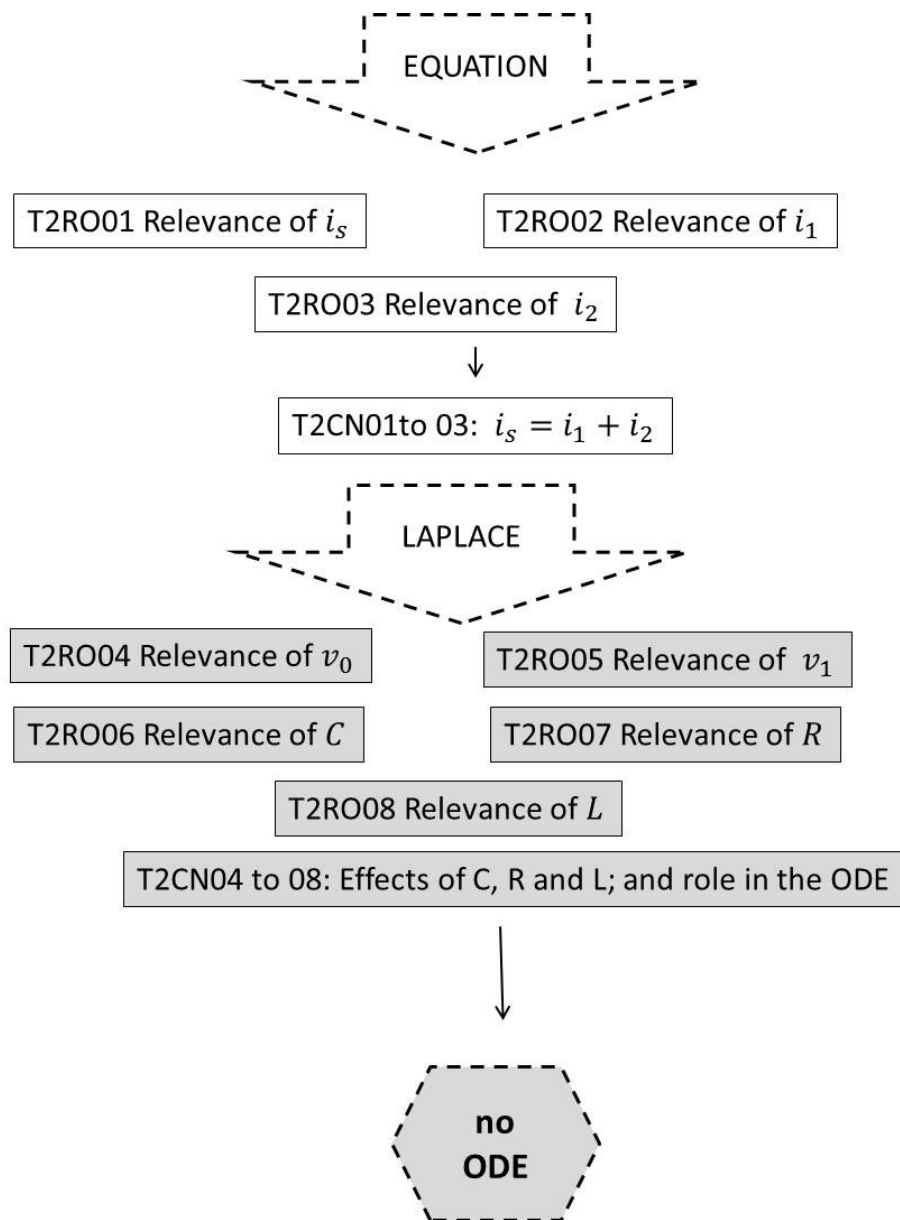

Figure 41. Harry's flow of reasoning for task 2.

### Task 2 – Josh

Similar to Harry, Josh relied on the Laplace method only. At this initial stage, Josh stated that the system was governed by the Kirchoff's Current Law (KCL). His first attempt to model

the system was using the Laplace method. It is worth reminding the reader that the textbook from which the tasks were taken assumes that the student is able to model the system without using the Laplace method. It means that they are expected to use the relations of the quantity to be analyzed with its corresponding derivatives. In Josh's case, it is hard to even validate the use of the readouts expected for this task since he was not successful in the process of obtaining the expression. Furthermore, he provided an incomplete equation in the Laplace domain and also, the quantity and the relation with the terms in it was represented in terms of an algebraic equation instead of a differential equation. It is of course understandable that Josh was trying to work in another domain but his only response when he was asked about how he could interpret the equation he proposed was: "*you'd have to convert it back for it to make physical sense...*".

In summary, none of the expected readouts and causal nets were used by Josh in this task. On the other hand, his only strategy was that of Laplace method which was of no profit for him this time; none of the strategies found in this study was used. His final expression is of algebraic composition without any relation between the quantity to analyze and the other parameters as shown in Figure 42.

$$V_0 = Ls \left( Ls V_1 + \frac{V_1}{Ls} - I(s) \right)$$

Figure 42. Josh's final expression.

**Summary of Josh's flow of reasoning for Task 2.** Josh's reasoning was very similar to that used by Harry. Again, he used the Equation strategy but soon tried to use the Laplace method which hindered all the possibilities to go further with the task. He did not see the relevance of the elements (T2RO04 to 07) and consequently could not infer the role of these elements in the system (T2CN04 to 07).

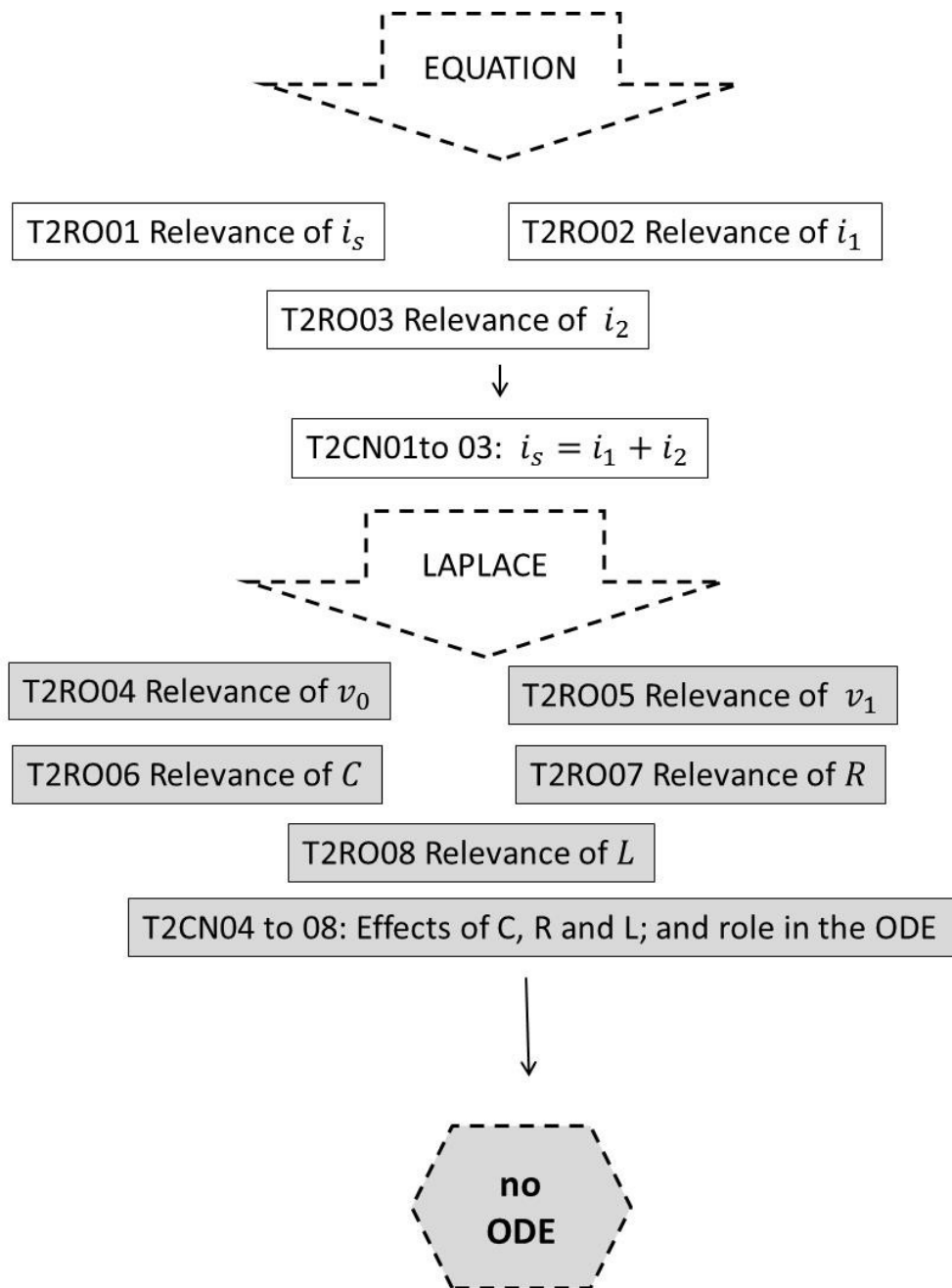

Figure 43. Josh's flow of reasoning for task 2.

### Task 2 – Kira

Kira's work on this task involved the use of two strategies. In her first attempt she tried to analyze the effect of each element of the circuit using the component-based approach (Figure 44). In this case, Kira identified the relevance of each element of the system, matching those

presented in the readouts table from the conceptual analysis (T2RO01 to 08). On the other hand, she recognized that KCL was useful in this task and related the currents as expected.

$$\begin{aligned}
 v_0 &= i_1 R & i_1 &= \frac{v_0}{R} \\
 v_1 &= \frac{di_2}{dt} C & i_2 &= \int \frac{v_1}{C} \\
 (v_1 - v_0) &= i_1 L
 \end{aligned}$$

Figure 44. Kira's component-based approach results.

Kira's work in this task was limited as the other interviewees, except by Rebecca. Despite the fact that she recognized the elements influencing the system's behavior she failed to activate the causal nets, T2CN04 to T2CN08, that would lead her to obtain the ODE for this task. The only exception was the recognition and use of the equation relating the currents which meant an initial reasoning to complete the task but was not enough.

**Summary of Kira's flow of reasoning for Task 2.** Kira decided to analyze each of the components of the system (Component strategy). This helped her to see the relevance of the elements of the system; furthermore she relied on the equation (Equation strategy) related to the governing principle (T2CN01 to 03). However, this was not enough to help her make the inferences to obtain the ODE. Although she recognized several aspects of each element, she could not make complete inferences that would have led her to provide accurate information (As seen on Figure 44).



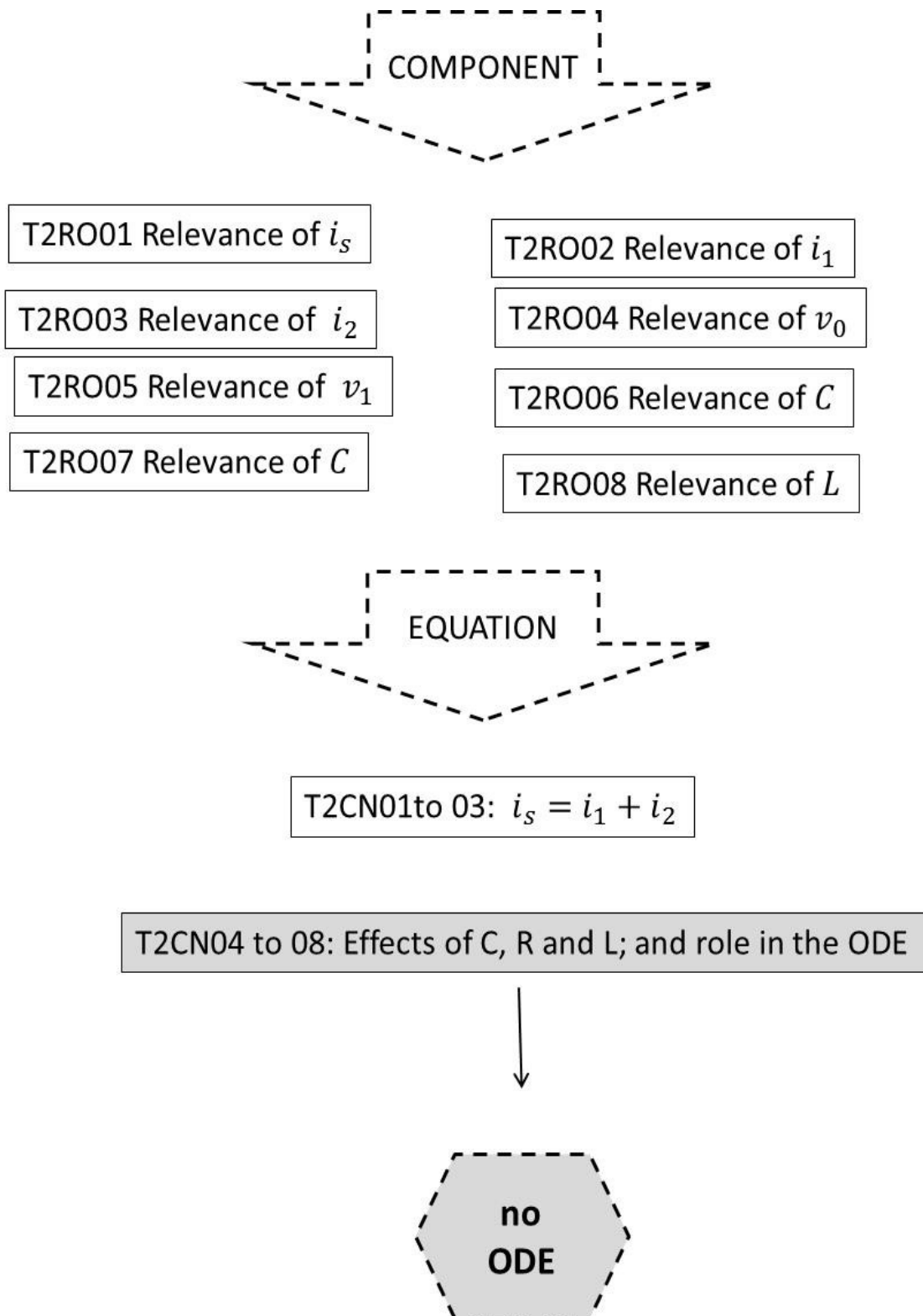

Figure 45. Kira's flow of reasoning for task 2.

### Analysis of Students' Written Work for Task 3

#### Task 3 – Zane

Zane's first comment regarding the task is that although harder than the others, it was possible to model it in a similar way to the electrical and mechanical systems in terms of derivatives of time and explained the analogies between systems, as shown in Figure 46

$$P \cong V$$
$$q_{in} \cong I$$

Figure 46. Zane's analogies between systems.

Later on, Zane mentioned that, in general, these kinds of systems were governed by the Bernoulli principle, which was represented by the equation he wrote next. See figure below.

$$q_{in} - q_{out} = \rho \dot{V} + \dot{p} V$$

Figure 47. Zane's guiding (Bernoulli) equation.

This equation was Zane's guiding tool along the solution of the task, which he successfully finished. His main strategy in this case is what I suggested at the beginning of this section, equation-based strategy.

$$\rho \dot{V} + \frac{\rho \dot{V}}{K} = \dot{p}$$

Figure 48. Exclusion of compressibility term from Zane's equation.

One important aspect that is noticeable for all the students is that the fourth term of the equation was properly discarded. Even though this readout and consequent causal net were not included in the list of expected elements for this task, all of the students were able to make the necessary inferences to exclude it from the equation. This element,  $\rho V$  implied a compressible fluid, as shown in the figure below.

The rest of Zane's reasoning consisted on following the elements of the equation and infer what each of these represented to obtain his final expression. He needed to rewrite the three remaining elements of his initial expression to complete the assignment, as seen on Figure 49.



The image shows a handwritten equation in black ink on a white background. The equation is  $q_{in} - q_{out} = \rho \dot{V}$ . The variables are written in a cursive, handwritten style. The 'in' and 'out' subscripts are clearly visible. The rho symbol is written as a simple 'p' with a dot above it. The V has a dot above it, indicating a derivative with respect to time.

Figure 49. Zane's preliminary equation to obtain the ODE.

He could easily determine and infer the role of the flowrate coming into the tank, (T3RO01 and T3CN01). On the other hand,  $q_{out}$  required a more sophisticated knowledge that Zane did not have at that moment although he recognized that this flow came out from an orifice at "L", (T3RO07 and T3CN07). Let us remember that students did not count on any textbook or formula sheet to help them in the process, so it is valid to affirm that both the readout and its corresponding causal net are properly inferred. Finally, by recognizing that the height ( $h$ ), the area of the tank's surface ( $A$ ), height  $L$  and the tank itself (readouts T3RO04, 05, 06 and 08) Zane inferred the expression for the last term of the equation:  $\rho A \dot{h}$  (T3CN04, 05, 06 and 08). The coordination of all these elements, both the readouts and causal nets, was possible through the equation-based strategy. Figure 50 shows Zane's final expression.

$$\rho A \frac{dh}{dt} + k_1 \sqrt{\rho g h} = q_{vi}(t)$$

Figure 50. Zane's ODE for Task 3.

One last aspect to mention from Zane's work is the fact that he was the only one to mention the relevance of  $p_a$  in the task. This evokes the use of T3RO02 and T3CN02. Zane explained the meaning of  $p_a$  in the system and the reason why it could be discarded, explaining that one can assume that the height is so small compared to the changes in atmospheric pressure that this parameter does not make any difference in the discharge flowrate.

**Summary of Zane's flow of reasoning for Task 3.** At the beginning Zane identified the readouts from the Task's statement. He explained what each element meant and the role it played in the system. Next, Zane recognized that the fluid system was governed by the Bernoulli's principle and in this way, he wrote the equation of conservation of mass corresponding to this type of systems based on the aforementioned principle. Although Figure 51 shows a gray rectangle, corresponding to the role of  $h_1$ , it is not relevant to solve the task. The Equation strategy led Zane to use a term related to the compressibility of the fluid which was properly discarded from the expression. The Equation strategy allowed Zane, and as we shall see with the other students, to make the proper inferences to obtain a valid expression for the ODE of this system.

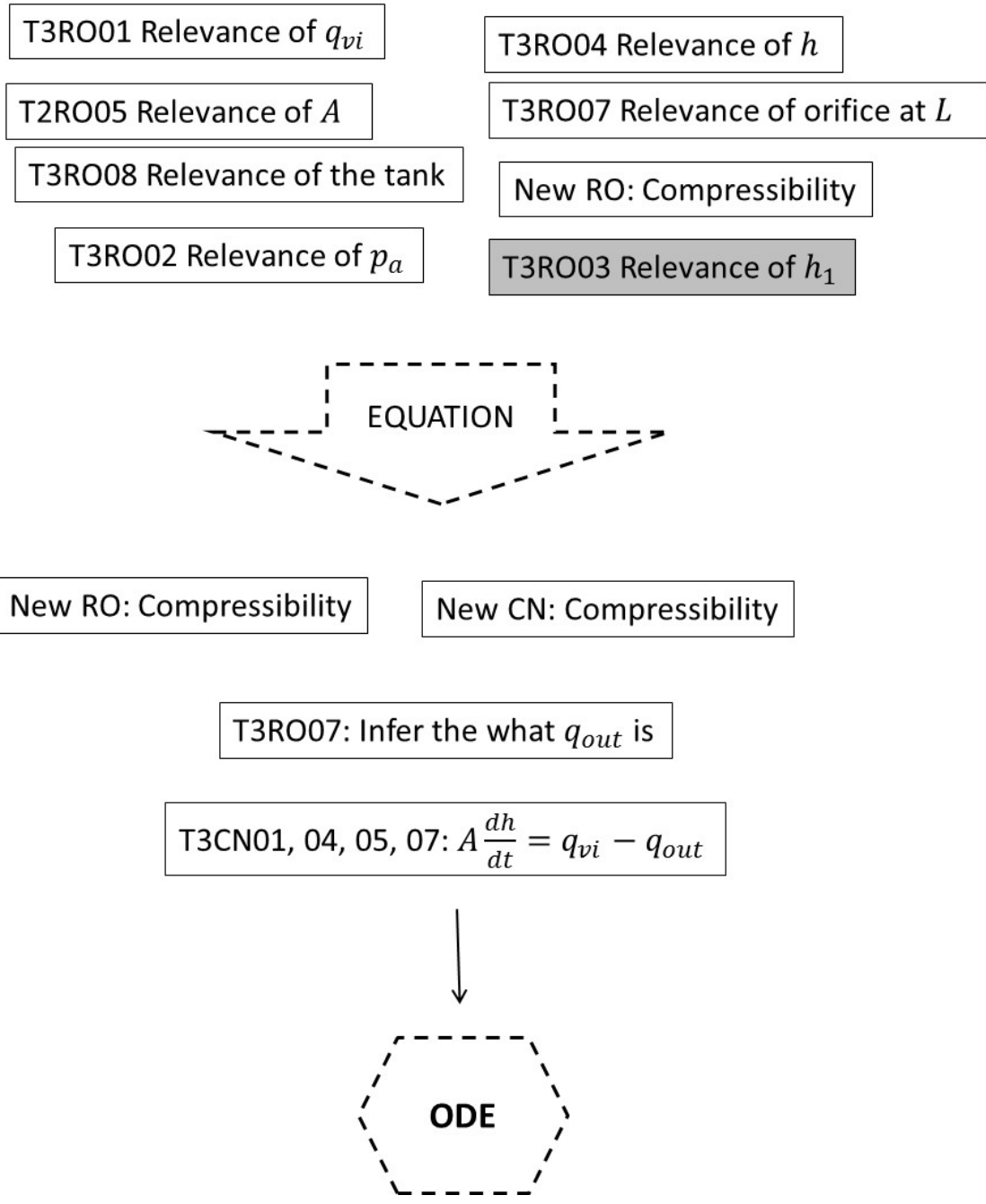

Figure 51. Zane's flow of reasoning for task 3.

**Task 3 – Rebecca**

Rebecca's reasoning followed a very similar pattern to that followed by Zane. She initially stated that this task was guided by the Bernoulli's principle and thus, she wrote the formula out of memory. In the same way, she identified and discarded the term including the variation of

pressure since she implied that the task assumed an incompressible liquid. This can be evidenced in the picture below.

$P_a$ . Develop a model of the liquid height  $h$ .

$$q_{mi} - q_{mo} = \rho \dot{V} + \frac{\rho_0 V_0}{B} \dot{P}$$

Figure 52. Rebecca’s preliminary equation excluding the 4th term.

Again, in the same way as Zane did, she identified the necessary and relevant elements in the task, readouts T3RO03 to 06 and 08; and T3CN03 to 06 and 08, by which she made the corresponding inferences to obtain the final expression. All her work was guided by the equation-based strategy.

$$\rho A v_i - k_r \sqrt{\rho g h - P_a} \operatorname{sgn}(P_g h - P_a) = \rho A \dot{h}$$

Figure 53. Rebecca’s final ODE for task 3.

It is important to emphasize again that the term involving  $q_{out}$  showed some minor differences from the solution given in the analysis section. This fact however did not hinder the student’s ability to come to the solution.

**Summary of Rebecca’s flow of reasoning for Task 3.** This flow of reasoning is very similar to that of Zane. There was only a slight difference regarding the way Rebecca described

the expression for  $q_{out}$  ; in both cases, should the students have the usual aids they had obtained the exact expression. Other than that, the Equation strategy served very well to Rebecca.

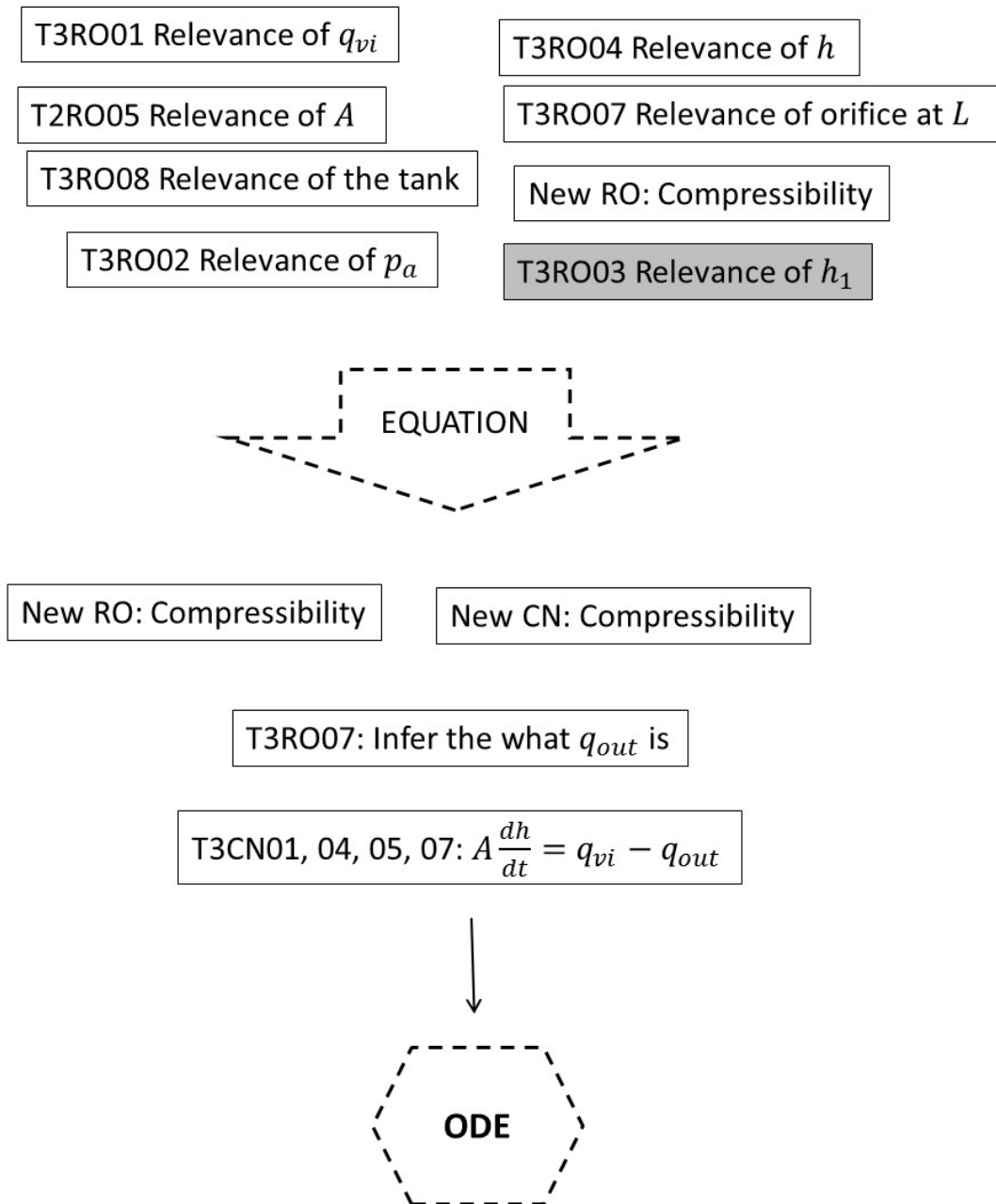

Figure 54. Rebecca's flow of reasoning for task 3.

### Task 3 – Harry

In order to avoid repetition in the account, it is sufficient to mention that Harry attempted to follow the same reasoning evidenced by Rebecca and Zane. However, I focus on two important aspects of his work.

The first differentiating feature in Harry's work deals with the fact that he used more than one strategy (Equation-based) to solve the task. As part of his initial analysis, Harry used the tank as a control volume. A control volume is a closed region used in thermofluids to determine what elements produce a change in its volume/mass. In this way, this approach coincides with the FBD strategy used in the mechanical task, thus it can be considered a diagram-based strategy to help project the concept to analyze. Due to the use of the control volume Harry used T3RO08 and T3CN08 to help him make sense of the variation of volume in the tank.

There was a second factor in Harry's work that differed from Zane and Rebecca's. He did not discard the compressibility term from his final answer. Even though he was informed that the task assumed water (an incompressible fluid), he replied:

*Interviewer:* Let's assume it's water...

*Harry:* OK, so assuming it's water, I don't know what that would be again, I will just take that "beta" all the way to my final answer..."

In this way, Harry decided to keep this term and the figure below, Figure 55, shows his final answer. He identified and operated all the readouts and causal nets expected for this task except by T3RO02 and T3CN02, which anyway, are not fundamental to come to the final answer. However, this additional readout, the recognition of the compressibility factor in the equation, was not properly inferred, in other words, the causal net was not properly applied so he could have obtained the right final answer.



$$q_{vi}(t) - k\sqrt{p} = \rho A \dot{h} + \frac{\rho_0 v_0}{\beta} \rho g h$$

Figure 55. Harry's final ODE for task 3.

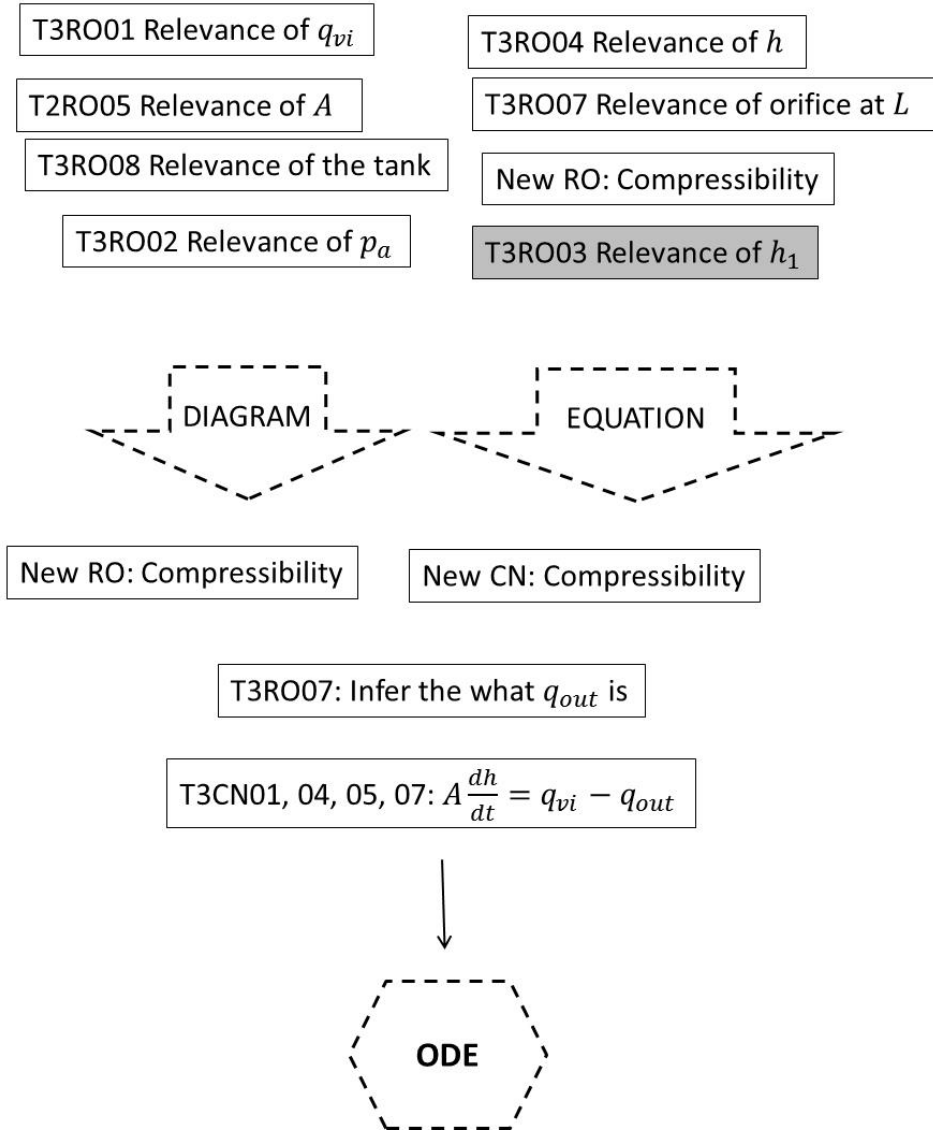

Figure 56. Harry's flow of reasoning for task 3.

**Summary of Harry's flow of reasoning for Task 3.** The only difference between Harry's flow of reasoning and the previous students implied that besides using the Equation

strategy, he also used the Diagram strategy. This strategy helped Harry see how the water level ( $h$ ) changed; he could also identify the corresponding relevant elements and inferences to obtain the ODE. In this task, the element that demanded more effort was the expression for  $q_{\text{out}}$  but eventually each student arrived to a valid expression.

### **Task 3 – Josh**

**Summary of Josh’s reasoning for Task 3.** The aspect that differentiated Josh’s work from the others’ was the term  $q_{\text{out}}$ . Josh was the only student who did not make any reasoning to obtain an expression for this element. On the other hand, Josh, as Harry, used a control volume to analyze the change of volume; that is, how  $h$  changed in the tank. This corresponds to T3RO08 and T3CN08.

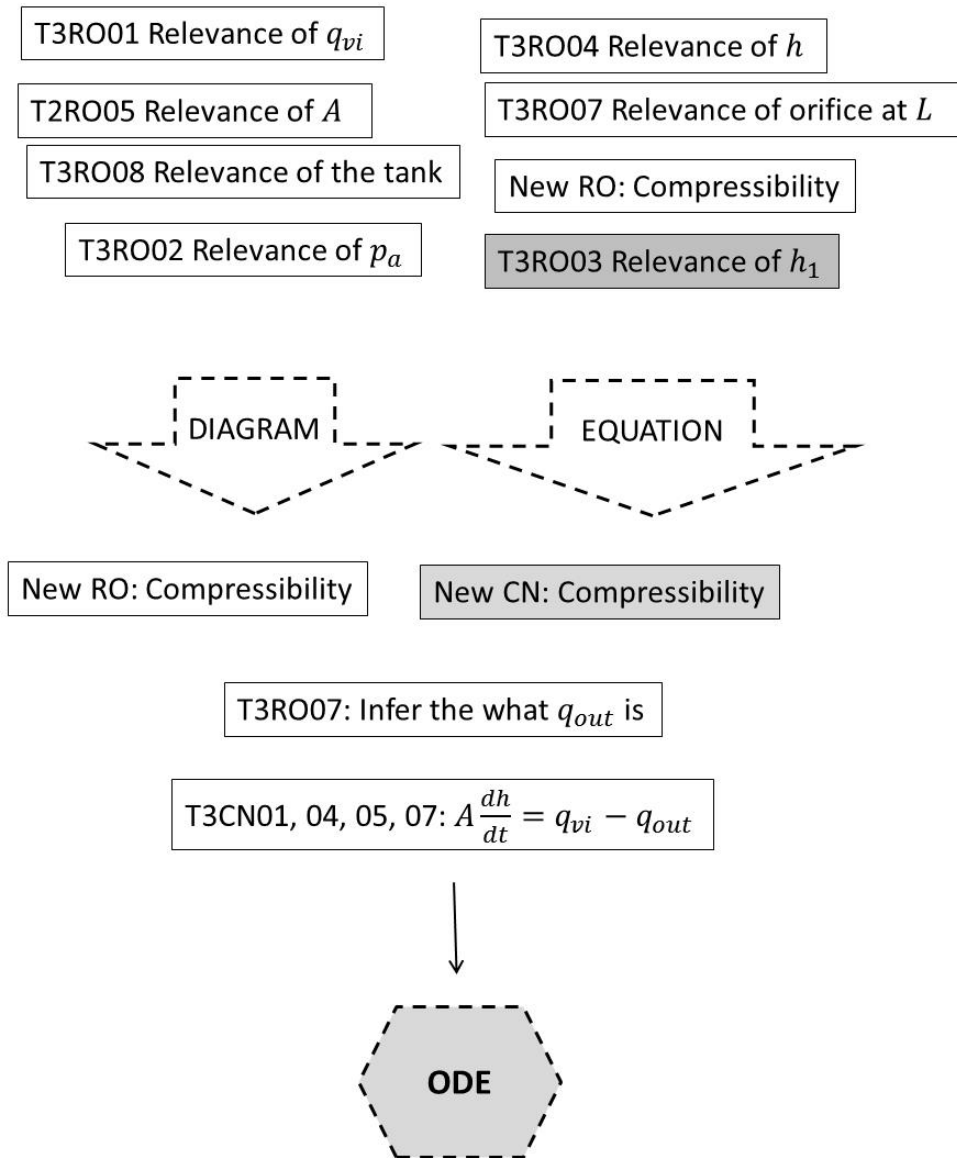

Figure 57. Josh's flow of reasoning for task 3.

With the exception of T3RO07 and T3CN07, those related to the discharge flowrate, Josh used all the readouts and causal nets as expected, including the compressibility set of relevant information and inference. In the same way as Harry, Josh used both, the equation-based and the diagram-based approach.

### Task 3 – Kira

Kira followed an identical reasoning to that of the other interviewees. That is, she used an equation-based approach, she recognized and discarded the compressibility factor properly and came up with a final equation. However, she showed some confusion trying to operate a causal net for the discharge flowrate,  $q_{out}$  (T3RO07). That is, she showed no evidence of using some reasoning that would lead her to obtain an expression for this flowrate (T3CN07), instead she combined it with the atmospheric pressure term, as shown in Figure 58.

The figure shows three handwritten equations. The first is  $q_{out} = Pa$ . The second is  $q_{vi} - Pa = \rho A h$ . The third is a boxed equation  $\dot{h} = \frac{q_{vi} - Pa}{\rho A}$ .

Figure 58. Kira’s final ODE for task 3 and  $q_{out}$  interpretation.

Even though she had “seen” or perceived that there was a certain relationship between these two quantities, she did not have enough information to infer how to obtain an expression for  $q_{out}$ . However, at this point, it is not expected that students know these kinds of relationships by heart. In fact, in the regular activities during class, even in evaluating activities they are provided with a list of relevant equations to help them focus on the important aspects of modeling systems, in this case, derive the necessary relations to obtain the ODE that characterizes the system.

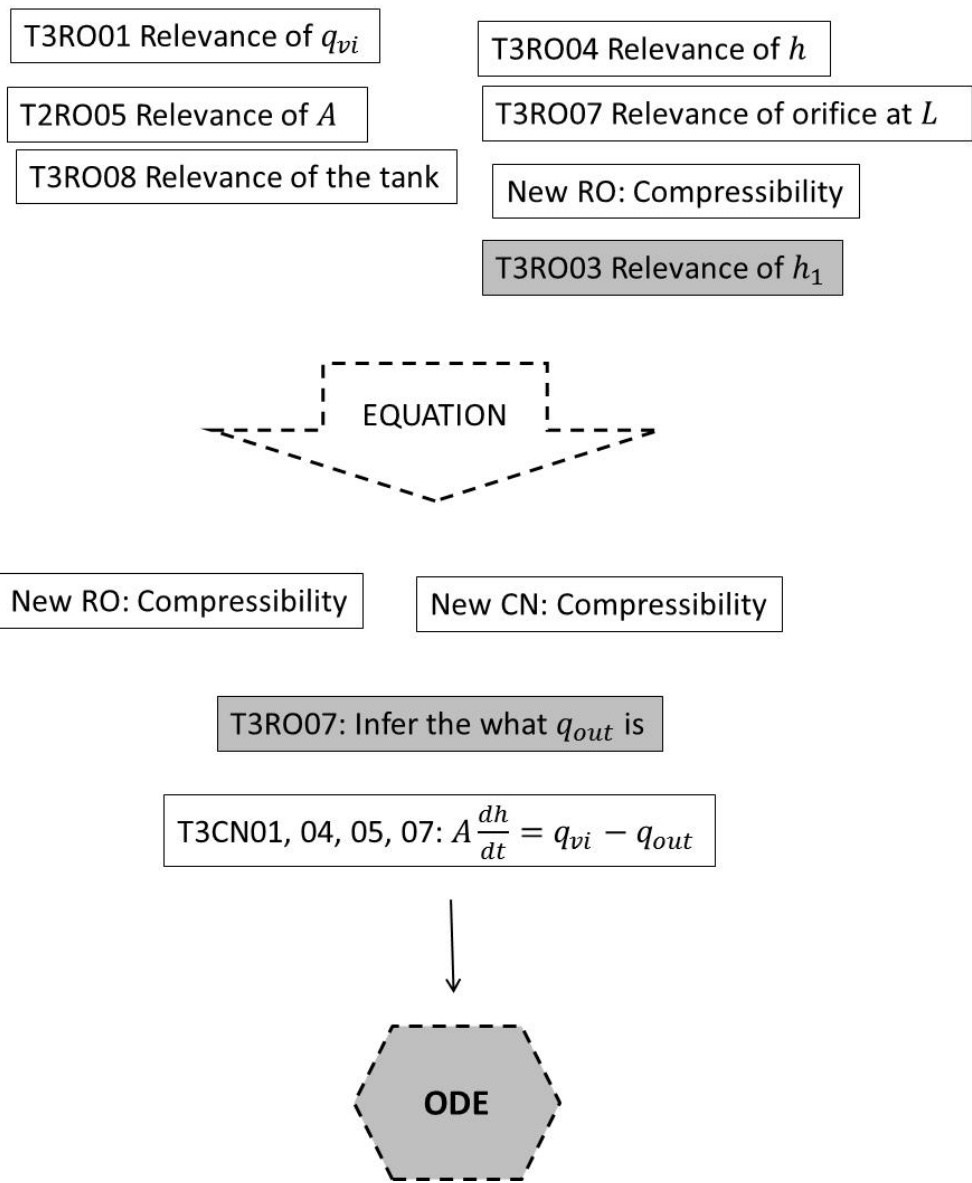

Figure 59. Kira’s flow of reasoning for task 3.

**Summary of Kira’s flow of reasoning for Task 3.** As mentioned earlier, students followed a very similar flow of reasoning for Task 3. Kira identified the relevant elements of the system and in the process she came up with the Equation strategy which helped her make the inferences for each of the elements to the system. She had some difficulties when describing  $q_{out}$ ; for this reason, although she obtained a valid ODE, it is considered not completely accurate, which explains the gray hexagon for the ODE.

## Summary of Results

The tables below summarize the strategies used by the students in each task, and how close or successful they were at solving the tasks.

Table 10 presents what strategy(ies), of the three defined in the Results section, each student used in each task. Kira was the student who tried more strategies along the solution of the tasks compared to Zane who seemed focused on less approaches but showed better results if we look at Table 9.. Zane successfully obtained the ODEs for tasks 1 and 3, the mechanical and fluid system respectively. In terms of success rate, Rebecca showed the best results; as Zane she obtained correct ODEs for tasks 1 and 3, and she partially succeeded in task 2. Harry and Josh showed similar results, both completed task 3 and showed partial progress with task 1. On the other hand, Kira could only show good performance in task 3. In fact, this task was the only one in which all students successfully obtained an ODE, taking into account the limitations they had during the interviews.

As stated in the description of the tasks in the Methods section, task 2 was meant to be a challenging context for the students. Given that they are mechanical engineering undergraduates, they mention this fact during the interviews, that they are not very familiar with these kinds of contexts; however, this exercise was informative as for the analysis of the challenges they faced when they had to apply similar principles in a novel context, which is the essence of transfer of learning.

Going back to *Table 10*, Kira's results show limitations in her abilities to solve the tasks but at the same time, showed efforts to use as many resources as possible to make sense of the system's behavior and attempts to set up the ODEs; this is evidenced along the analysis of the result of her tasks. Harry and Josh on the other hand, had little effectiveness not only in the

setting up of the ODEs as evidenced in the failure to operate many of their causal nets but also in their ability to project different strategies that could have enabled them to show more progress with the tasks.

Zane and Rebecca seemed comfortable with the tasks in general, except with task 2; In those cases, their confidence in the strategies they used to solve the tasks allowed them to project the concept contained in  $ay'' + by' + cy = o \text{ or } f(t)$ .

*Table 9.*

*Summary of strategies used per student per task.*

	<b>Zane Task #</b>	<b>Rebecca Task #</b>	<b>Harry Task #</b>	<b>Josh Task #</b>	<b>Kira Task #</b>
<b>Diagram</b>	<b>1,2</b>	<b>2</b>	<b>3</b>	<b>1,3</b>	<b>1,2,3</b>
<b>Component</b>	<b>2</b>	<b>1,2</b>	<b>1</b>	<b>1,2</b>	<b>1,2</b>
<b>Equation</b>	<b>3</b>	<b>2,3</b>	<b>2,3</b>	<b>2,3</b>	<b>1,2,3</b>

*Table 10.*

*Summary of success in solving the tasks*

	<b>Zane</b>	<b>Rebecca</b>	<b>Harry</b>	<b>Josh</b>	<b>Kira</b>
<b>Task 1</b>	<b>S</b>	<b>S</b>	<b>PS</b>	<b>PS</b>	<b>U</b>
<b>Task 2</b>	<b>U</b>	<b>PS</b>	<b>U</b>	<b>U</b>	<b>U</b>
<b>Task 3</b>	<b>S</b>	<b>S</b>	<b>S</b>	<b>S</b>	<b>S</b>

## CHAPTER 6: DISCUSSION

In this section I discuss the results of this study and compare them with the literature related to studies on differential equations and the concepts of coordination class. I also discuss about the extent to which students relied on mathematical concepts throughout the solution of the tasks. Then, I examine in more detail the implications of the use of the strategies students used along the tasks. I discuss the implications of this study with aspects of instruction in differential equations and system dynamics classes. In addition, I consider the implications of this study with respect to the transfer of learning perspective. Finally I discuss the limitations and implications of this study for future research in mathematics education and engineering education.

### **Implications for the Coordination Class Theory**

diSessa and Sherin (1998) estimated that it is the causal nets and not the set of readout strategies, the core problem in learning physics concepts. In this study I have been able to demonstrate that diSessa and Sherin's conjecture is true; students in general were able to identify the elements of information of the systems, even from task 2 despite its difficulty. On the other hand, the attempts to project the concept based on the strategies identified as I analyzed students' work seemed to be effective in some cases (Zane and Rebecca), but insufficient in others (Kira). Besides, Harry and Josh not only were not as fluent in these strategies when compared to their classmates; but also, the ones they used could not enable them to complete the tasks. It seems apparent that the concept projection might not be accurate unless the student completely understands the implications (inferences) of the elements that he/she uses to eventually obtain the information he/she wants to obtain from a certain quantity.

Coordination class theory describes intrinsic difficulties that students face when reading information from the world. In this study, I intended to provide students different contexts to



challenge students' understanding of the principles underlying each of the systems they had to analyze. Given that the participants were all mechanical engineering students, I assumed that they would probably have better performance in tasks 1 and 3, mechanical and fluid respectively; the electrical system would pose more difficulties for them. Taking this into account, I recall the concept of *span* which relates to the applicability of a concept in different situations. Except by Rebecca, all the participants were unable to articulate the concepts of ordinary differential equations in task 2. The fact that they were unfamiliar with how the elements interacted in this system hindered the possibility to see the differential equation that described that system's behavior. diSessa and Wagner (2005) argue that by partitioning the structure of the coordination class - readouts and causal nets among others – might simplify instruction interventions. This implies that for learning and teaching matters, coordination class theory might shed light regarding how to help students widen their *span*; that is, the applicability of a concept. In this specific case determined for this study: modeling dynamic systems through ordinary differential equations.

Within the theory of Coordination Classes diSessa and Wagner (2005) state that *coordination clusters* are defined as: “coordination classes that mutually influence each other's development”. The evolution of a coordination class is inherently linked to new understanding of the concepts defining it. For example, a better understanding of the concept of force, imply new meanings for mass and acceleration. This study included coordination clusters undoubtedly contributes to the empirical work that has been developed in the previous years, for example Wagner (2006) with the concepts of “expected value”, “sample” and “distribution” in his study on the law of large numbers; or Thaden-Koch (2003) with the study on coordinating velocity.

## Students' Leaning on Mathematical Concepts

This study evidenced the complexity of analyzing this kind of tasks that involve concepts from several disciplines (e.g. engineering, physics and mathematics). Our interest is mainly focused on the mathematical aspects of the tasks, although sometimes the concepts are tightly intertwined.

The description of the solution of the tasks from the expert's point of view refers to mathematical aspects from the tasks. In this paragraph I discuss how students leaned on these aspects as they worked on the tasks. In Task 1, all of them properly recognized the relevance of the small angle which allowed them to use simpler terms. The appearance of the variable  $\theta$  and its derivatives came up implicitly as the students inferred the role of each of the components of the system. There were only brief mentions from Zane and Harry to the fact that the pendulum mass implies the existence of a second derivative of  $\theta$ , which then supposed the fact that the solution of the task implied a second order differential equation. On the other hand, every student rearranged their final expression to resemble the form of the ODE they were shown in previous occasions because that form is potentially helpful in further stages of modeling this kind of systems

In the case of Task 2 there is little to be mentioned with respect of the mathematical influence to obtain the ODE for this system due to the lack of familiarity of students with this kind of contexts. As shown in the Results section, all of them were unsuccessful at arriving to a valid ODE representation of this system. The only student who was close to finish this task, Rebecca, did not have the chance to think of potential tools that would help her go further with the task. Mathematically speaking, she was close to get an expression that would eventually need derivation and further rearrangements of the terms; however, she failed to recognize the

relevance of the node found after the inductor (L) and made the inferences that would have led her to that point. On the other hand, those students who turned to use the Laplace method (a mathematical tool) found themselves stuck in it and gave up on that strategy; which lead us to conclude that, for this Task, there was no evidence that the mathematical tools would make an impact in the solution of the Task.

In the case of Task 3, the most relevant aspect to note is the fact that all students obtained the expression for  $\frac{dh}{dt}$  by relating it to the change of the volume of the tank, which refers to that second step cited by Blanchard et al., (1998). Also, students rearranged the final expression to make it similar to that of a standard ODE.

In summary, if we think of modelling of dynamic systems as a whole, there are two major stages to consider; the first implies representing a real life situation in an ODE, the second entails solving that ODE. Taking this into account, the mathematical aspects involved in this process are more heavily present at the second stage rather than the first one; however, there is still room for analyzing the implications of mathematics in the first stage and this study evidences that there are potential aspects that might shed light on the modelling process.

### **Students' Strategies as Concept Projections**

Earlier I described three strategies that students used to approach the tasks: Diagram-based, Component-based and Equation-based. In this section I discuss the scope of these strategies as well as their relation with the causal nets and readouts.

On the one hand, I argue that these strategies can be considered concept projections because these entail a set of knowledge and plans in order to apply a certain concept in a given context. In this manner, I found that students used these three strategies in different ways and this use allowed them to solve the tasks. On the other hand, I consider the effect of these strategies as

for whether these facilitated the solution of the problems and also I make mention of what aspects were essential to solve each of the tasks.

The diagram strategy allowed the students to visualize a holistic perspective of the task. As the student has a big picture of the system, it is easier for him/her to identify the elements that are playing a role in how the system behaves. This is a deduction process that allows the student to narrow down the terms of the ODE. This strategy may not always be useful in certain contexts and this is a weakness I identified of it. For example, the electrical system did not allow to use this strategy effectively although, recognizing its effectiveness, some students attempted to use it.

The component-based strategy on the other hand, allowed the students to focus on the individual elements of the system and first focus on their effect in the system to, eventually, include it in the overall analysis. Rebecca chose to use this option in Task 1 and the main part of her work involved focusing on the task taking into account this strategy. It is worth mentioning that students chose to use the strategies unaware of what I currently describe in this study; that is, they had no label or identifying way to choose among the strategies, they only decided as they solved the tasks. This strategy had a drawback at the moment of putting together all the elements that had already been described. In trying to solve Task 2, for example, Rebecca had come to a valid analysis of the components, but she gave up on that strategy because she did not make the right inference on the effect of one of the components. This last thought implies that, although a student might be able to draw different strategies, unless he/she makes the right inferences, he/she will be restrained as to how far he/she can work on a given task. However, in the case of Rebecca, at least she could identify what aspect of the Task made it difficult to handle. Other students used different strategies with similar results.

The equation-based strategy served well in the case of Task 3 although I presume that this Task was easily solved using this strategy because there were a few number of elements in the system. This strategy had the students identify the terms of the equation with their corresponding component in the system. This seems to be a straightforward technique, but as I already mentioned, this would not be the case if there were more elements involved.

Now, it is important to consider Kira's case regarding the use of the strategies. She was the student who showed the lower results as she solved the tasks but at the same time, I argue that it was because she was resourceful as for the use of those strategies that she could show some progress with the tasks. On the other hand, this case confirms what I stated in the last paragraph where I argue that no matter how many strategies are used, unless the right causal nets are properly deployed, there will be stages of the process in which the student will just get stuck.

In contrast, I also consider it is worth mentioning Rebecca's performance at solving Task 2. Contrary to what happened to Kira in all the Tasks (where she had no productive results), it was the use of different strategies that allowed her to show some progress. In this case, this evidence might prove my conjecture of the usefulness of the strategies. In Rebecca's case, the combination of strategies allowed to "see" that there was a key aspect in one of the elements of the system (the inductor) that would lead her to continue with the solution of the task. Unfortunately for her she could not go any further with the task due to the lack of inferences.

### **Learning Differential Equations**

In the Literature review chapter I cited Blanchard et al. (1998) discussing about the steps of the process of modeling with differential equations. Steps one involved establishing the rules or laws that described the quantities to analyze; in step two the student defines the variables and parameters to use in the model and the third step focuses on using those relationships between

quantities to obtain the equation. When compared with the coordination class theory, it is possible to compare steps 2 with the identification of the readout strategies and steps 1 and 3 with the operation of the causal nets. Given that Blanchard et al., and other textbooks follow a similar pattern to approach the modeling process, this study might shed light on methodologies adopted by authors concerning the teaching of differential equations and thus emphasize on strengthening students' skills in these steps.

The strategies used by the participants informed about the different ways in which a student might approach a task involving the modeling of the differential equation of a system. These could be assumed as concept projections of the modeling in different instances. These concept projections facilitated to some extent the implementation of the ordinary differential equation concept in different contexts. This study has helped identify and define the characteristics of these projections. This idea could imply effects on the way that modeling is taught in differential equations courses as well as engineering courses dealing with this process. It is possible that further studies refine the definition, limitations and scope of these strategies and thus help students in understanding and carry out modeling of systems more efficiently.

### **Understanding of Students' Thinking of Differential Equations**

I have also referred to Rasmussen's framework to interpret students' understanding and thinking of differential equations. Although most of the theory he proposed is not applicable within the scope of this study, I consider that it is important to make mention to a specific section of his study with respect to part of the students' results. In his framework, Rasmussen two themes involving the difficulties that students usually show when reporting understanding (or the lack of it) of differential equations. One of these themes is called: *the function-as-solution dilemma theme*. In this theme, Rasmussen reports that students fail to interpret the solution of a differential

equation in terms of a function; they are used to finding the solution of an equation resulting in a “number” instead of a family of functions. As the results for two of the students in task 2 involved expressions closely related to an algebraic equation than a differential equation, in this study I have shown evidence that these issues remain in students’ thinking.

### **Implications for Transfer of Learning Processes**

I have also mentioned that coordination class theory, as argued by diSessa and Wagner (2005) has a structure whose elements can inform the possibility of transfer. Concept projections and span involve enough elements to consider this theory as a valid precursor to study transfer of learning processes. A basic conception of transfer allows a yes/no possibility of transferred knowledge from one situation to another. In contrast, different perspectives of transfer of learning beg the possibility to study this phenomenon from a transitional and evolving point of view. In this study I argue that the lack of span in the context of task 2 (electrical system) could be considered as an argument in favor to analyze transfer of learning in more detail. There were though certain aspects, like the proper use of the readout strategies; that could evidence a partial accomplishment of transfer in this context considering the failure in the operation of the causal nets as stage in which the completion of the transfer process was not completed. Still, it would be necessary to use the proper transfer of learning perspective to provide further details of the process. Indeed, the Transfer-In-Pieces perspective (Wagner, 2006) is founded on the coordination class theory and could provide a suitable framework in this case.

### **Conclusion**

The research questions of this study focused on the way students applied their knowledge in the modeling of system dynamics as well as obtaining information about the resources and strategies they used while solving tasks. The figures showing the flow of students’ reasonings in

the tasks provided a possible structure of how they approached the tasks and also highlighted the difficulties they faced at completing the tasks. On the other hand, the identification of those strategies, the concept projections in the context of: Diagrams, Components and Equations, offered a suitable framework upon which future studies can have some reference. Along the Results section I showed evidence of each of these elements and provided useful information concerning possibilities to analyze aspects of transfer of learning at undergraduate level.



## REFERENCES

- Artigue, M. (1999). The Teaching and Learning of Mathematics at University Level. *Notices of The American Mathematical Society*, 46(11), 1377-1385.
- Arslan, S. (2010). Traditional instruction of differential equations and conceptual learning. *Teaching Mathematics and Its Applications*, 29(2), 94-107.
- Bergsten, C. (2007). Investigating quality of undergraduate mathematics lectures. *Mathematics Education Research Journal*, 19(3), 48-72.
- Booth, S. (2008). Learning and teaching engineering mathematics for the knowledge society. *European Journal of Engineering Education*, 33, 381-389.
- Budinski, N. & Takaci, D. (2010). Introduction of the Notion of Differential Equations by Modeling Based Teaching. *International Journal for Technology in Mathematics Education*, 18, 107-111.
- Buteler, L., Coleoni, E., & Perea, M. (2014). Aprendiendo empuje durante la resolución de problemas: un análisis desde la Teoría de Clases de Coordinación. *Ensciencias*, 32(3).  
<https://doi.org/10.5565/rev/ensciencias.1309>
- Çengel, Y. & Boles, M. (2002). *Thermodynamics*. Boston: McGraw-Hill.
- Chen, X. & Soldner, M. (2013). *STEM Attrition: College Students' Paths Into and Out of STEM Fields Statistical Analysis Report* (pp. 1-10). Washington, D.C.: National Center for Education Statistics. Retrieved from <http://nces.ed.gov/pubs2014/2014001rev.pdf>
- Christine, M. (2007). CRS Report for Congress Science, Engineering and Mathematics Education: Status and Issues (pp. 1-6). Washington, D.C.: Congressional Research Service.

- Czocher, J., Tague, J., & Baker, G. (2013). Where does the calculus go? An investigation of how calculus ideas are used in later coursework. *International Journal of Mathematical Education in Science and Technology*, 44, 673-684.
- diSessa, A. A. (1993). Toward an epistemology of physics. *Cognition and instruction*, 10(2-3), 105-225..
- diSessa, A. A. & Wagner, J. F. (2005). What coordination has to say about transfer. In J. P. Mestre (Ed.), *Transfer of learning from a modern multidisciplinary perspective* (pp. 121-154). Greenwich, CT: Information Age Publishing.
- Dray, T. & Manogue, C. (2003). Using Differentials to Bridge the Vector Calculus Gap. *The College Mathematics Journal*, 34, 283.
- Ellis, M., Williams, B., Sadid, H., Bosworth, K. W., & Stout, L. (2004). Math usage by practicing engineers: What does it mean to curriculum planners?. p 9, 1.
- Güçler, B. (2012). Examining the discourse on the limit concept in a beginning-level calculus classroom. *Educational Studies In Mathematics*, 82, 439-453.
- Fox, R., Pritchard, P., McDonald, A., & Fox, R. (2011). *Fox and McDonald's introduction to fluid mechanics*. Hoboken, NJ: John Wiley & Sons.
- Hall, C., Dickerson, J., Batts, D., Kauffmann, P., & Bosse, M. (2011). Are We Missing Opportunities to Encourage Interest in STEM Fields? *Journal of Technology Education*, 23(1), 32-46.
- Hashemi, N., Salleh Abu, M., & Kashefi, H. (2015). Designing learning strategy to Improve Undergraduate Students' Problem Solving in Derivatives and integrals: A Conceptual

Framework. *Eurasia Journal of Mathematics, Science and Technology Education*, 11, 227-238.

Hibbeler, R. (1997). *Mechanics of materials*. Upper Saddle River, N.J.: Prentice Hall.

Horwitz, A. & Ebrahimpour, A. (2002). Engineering Applications in Differential and Integral Calculus. *International Journal of Engineering Education*, 18, 78-88.

Hu, D. & Rebello, N. (2013). Understanding student use of differentials in physics integration problems. *Physical Review Special Topics - Physics Education Research*, 9. doi: 10.1103/physrevstper.9.020108

Incropera, F. (2007). *Introduction to heat transfer*. Hoboken, NJ: Wiley.

Jones, S. (2015). The prevalence of area-under-a-curve and anti-derivative conceptions over Riemann sum-based conceptions in students' explanations of definite integrals. *International Journal of Mathematical Education in Science and Technology*, 46, 721-736.

Jones, S. R. (2015). Areas, anti-derivatives, and adding up pieces: Integrals in pure mathematics and applied contexts. *The Journal of Mathematical Behavior*, 38, 9-28

Martinez Ortiz, A. & Sriraman, V. (2015). Exploring Faculty Insights into Why Undergraduate College Students Leave STEM Fields of Study—A Three-Part Organizational Self-Study. *American Journal of Engineering Education*, 6, 43.

Orton, A. (1983). Students' understanding of differentiation. *Educational Studies in Mathematics*, 14(3), 235-250. doi: 10.1007/bf00410540

Palm, W. (2005). *System Dynamics*. Boston: McGraw-Hill Higher Education.

- Pennell, S., Avitabile, P., & White, J. (2009). An Engineering-Oriented Approach to the Introductory Differential Equations Course. *PRIMUS*, 19(1), 88-99.
- Peters, M. & Kortecamp, K. (2010). Rethinking Undergraduate Mathematics Education: The importance of classroom climate and self-efficacy on mathematics achievement. *Current Issues in Education*, 13(4). Retrieved from <http://cie.asu.edu/>
- Pilgrim, M. (2014). Addressing the Standards for Mathematical Practice in a Calculus Class. *Mathematics Teacher*, 108(1), 52-57. Retrieved from <http://www.jstor.org/stable/10.5951/mathteacher.108.1.0052> doi:1
- Powers, R., Craviotto, C., & Grassl, R. (2010). Impact of proof validation on proof writing in abstract algebra. *International Journal Of Mathematical Education In Science And Technology*, 41(4), 501-514.
- President's Council of Advisors on Science and Technology,. (2012). *Report to the President Engage to Excel: Producing One Million Additional College Graduates with Degrees in Science, Technology, Engineering, and Mathematics* (p. i to x). Washington D.C.: Executive Office of the President of the United States. Retrieved from [https://www.whitehouse.gov/sites/default/files/microsites/ostp/pcast-engage-to-excel-final\\_2-25-12.pdf](https://www.whitehouse.gov/sites/default/files/microsites/ostp/pcast-engage-to-excel-final_2-25-12.pdf)
- Rasmussen, C. (2001). New directions in differential equations. *The Journal of Mathematical Behavior*, 20(1), 55-87.
- Raychaudhuri, D. (2013). A framework to categorize students as learners based on their cognitive practices while learning differential equations and related concepts. *International Journal of Mathematical Education in Science and Technology*, 44(8), 1239-1256.

- Redish, E. (2005). Problem Solving and the Use of Math in Physics Courses. In *World View on Physics Education*. International Physics Education Conference. Delhi.
- Shipman, B. (2012). A Comparative Study of Definitions on Limit and Continuity of Functions. *PRIMUS*, 22(8), 609-633.
- Soon, W., Lioe, L., & McInnes, B. (2011). Understanding the difficulties faced by engineering undergraduates in learning mathematical modelling. *International Journal Of Mathematical Education In Science And Technology*, 42(8), 1023-1039.
- SEFI Société Européenne pour la Formation des Ingénieurs,. (2016). *A Framework for Mathematics Curricula in Engineering Education* (pp. 61-65). Brussels: European Society for Engineering Education (SEFI). Retrieved from <http://sefi.htw-aalen.de/Curriculum/Competency%20based%20curriculum%20incl%20ads.pdf>
- STEM Education Statistics. (2016). National Math and Science Initiative. Retrieved from <https://www.nmsi.org/AboutNMSI/TheSTEMCrisis/STEMEducationStatistics.aspx>
- Wagner, J. (2006). Transfer in Pieces. *Cognition And Instruction*, 24(1), 1-71.
- Wainwright, C., Morrell, P., Flick, L., & Schepige, A. (2004). Observation of Reform Teaching in Undergraduate Level Mathematics and Science Courses. *School Science and Mathematics*, 104(7), 322-335.
- Willcox, K. & Bounova, G. (2004). Mathematics in Engineering: Identifying, Enhancing and Linking the Implicit Mathematics Curriculum. In *American Society for Engineering Education Annual Conference and Exposition*. American Society for Engineering Education. Salt Lake City, Utah.