



2011-04-12

An Analysis of Analytical Methods to Produce a Varying Angular Output from a Constant Angular Input Using Gearsets

Isaac R. Jones

Brigham Young University - Provo

Follow this and additional works at: <https://scholarsarchive.byu.edu/etd>

 Part of the [Mechanical Engineering Commons](#)

BYU ScholarsArchive Citation

Jones, Isaac R., "An Analysis of Analytical Methods to Produce a Varying Angular Output from a Constant Angular Input Using Gearsets" (2011). *All Theses and Dissertations*. 2621.

<https://scholarsarchive.byu.edu/etd/2621>

This Thesis is brought to you for free and open access by BYU ScholarsArchive. It has been accepted for inclusion in All Theses and Dissertations by an authorized administrator of BYU ScholarsArchive. For more information, please contact scholarsarchive@byu.edu, ellen_amatangelo@byu.edu.

Development of a Positively Engaged Piecewise Continuous Transmission
Using Non-Circular Gearsets

Isaac Reo Jones

A thesis submitted to the faculty of
Brigham Young University
in partial fulfillment of the requirements for the degree of
Master of Science

Robert H. Todd, Chair
Carl D. Sorenson
Kenneth W. Chase

Department of Mechanical Engineering
Brigham Young University

June 2011

Copyright © 2011 Isaac Reo Jones

All Rights Reserved

ABSTRACT

Development of a Positively Engaged Piecewise Continuous Transmission Using Non-Circular Gearsets

Isaac Reo Jones
Department of Mechanical Engineering
Master of Science

Research in developing a Positively Engaged Continuously Variable Transmission (PECVT) has been underway at Brigham Young University for some time. The inherent problems associated with embodiments of this type of transmission, namely the Non-Integer Tooth Problem (NITP), have been identified. This research is focused on the development of a Positively Engaged Piecewise Continuous Transmission (PEPCT), which is a subset of the PECVT.

This document describes the hypothesis and analysis of using non-circular gearsets to overcome the NITP. This proposed solution enables a varying angular output from a constant angular input. In this research two analytical methods were evaluated based on their theory, mathematics and simulated results. Haupt's concept is shown to have discrepancies between the theorized and mathematical results which produce a gearset that has velocity spikes in its output. The second method, proposed by Danieli, describes the behavior on an infinitesimal level and the theorized results match up with the mathematical result.

As a result of the analysis, Danieli's method is declared to produce a varying output from a constant input. The method requires only the definition of an input function that defines the shape of the pitch line similar to the pitch circle for circular gears. Using this function an infinitesimal approach is used to describe the interaction of consecutive contact points on the tooth profiles. This interaction takes into consideration adapted principles that are derived from the Fundamental Law of Gearing and the Law of Conjugate Action. With these principles defined it is possible to design gearsets that are capable of producing a varying angular output from a constant angular input.

With the validation of the second method, and the principles defined by which it is governed, the proposed gearset is achievable allowing a PEPCT to be conceived. The proposed transmission utilizes the non-circular gearset to accelerate a secondary shaft to the next desired ratio while maintaining constant engagement. This concept is then analyzed and recommendations are made for the development of a Positively Engaged Continuously Variable Transmission.

Keywords: continuously variable transmission, gear, non-circular, gearset

ACKNOWLEDGMENTS

I would like to thank Vernier Moon Technologies and their managing partners for the opportunity to work on such a technical project. Their support, motivation and insight have enabled this work to be possible.

I am grateful to Brigham Young University for providing me with the education, instruction and facilities with which I was able to perform this research. I would like to thank the faculty and staff that have helped me throughout my years of study at this university. Their instruction, mentoring and example will prove priceless in the years to come.

I express appreciation to Dr. Robert Todd whose vision in the project has been paramount. He has provided me with the guidance, encouragement and fortitude that I needed to conduct the research on such a challenging project. He has been there to motivate me when I fail and compliment me when I succeed.

I would like to thank my fellow researchers Levi Haupt and Shaun Jeffs that have helped me conduct this research. Their encouragement, insight and hard work have brought a higher quality to my performance and abilities.

I would like to also thank my family for their support and strength. They have always been there for me throughout my life to help me succeed. I owe a lot of what I have accomplished to their guidance and instruction throughout my life.

In the end I thank my Heavenly Father and Savior Jesus Christ for the gifts, abilities and determination that they have given me and helped me develop.

TABLE OF CONTENTS

LIST OF TABLES	vii
LIST OF FIGURES	ix
1 Introduction.....	1
1.1 Research Objective	4
1.2 Research Approach.....	4
2 PECVT Research	7
2.1 Continuously Variable Transmissions	7
2.1.1 PECVT Definition and Non-Integer Tooth Problem	9
2.1.2 Classification of Possible PECVT Embodiments	11
2.2 Fundamentals of Gear Design.....	13
2.2.1 Involutometry.....	15
2.3 Non-Circular Gear Design	18
3 Non-Circular Gearsets With Variable Center Distance.....	21
3.1 Theory.....	21
3.1.1 Duplication of Results.....	25
3.2 Simulation Analysis.....	28
3.3 Haupt Method Conclusions	31
4 Non-Circular Gearsets With Constant Center Distance.....	35
4.1 Theory.....	35
4.2 Simulation Analysis.....	38
4.3 Design of Gears Using Danieli’s Method.....	43
4.4 Danieli Method Conclusions	45
5 PEPCT Embodiments.....	47

5.1	Embodiment Concept	47
5.2	Non-Circular Gearset Design.....	50
5.3	Pitch Line Modification	52
5.4	Embodiment Limitations	53
6	Conclusions	55
	References.....	58
	Appendix A – Duplication of Pitch Lines for Danieli’s Method.....	61
	Appendix B – Pitch Line Derivation for PEPCT Embodiment.....	62

LIST OF TABLES

Table 1: First order trend line for initial, final and Hybrid profiles.....	27
Table 2: Pressure angle comparison of a Hybrid tooth profile.	30
Table 3: Gearset layout for PEPCT embodiment.	49

LIST OF FIGURES

Figure 2-1: Typical belt drive CVT.	8
Figure 2-2: Manifestation of the Non-Integer Tooth Problem (NITP).	10
Figure 2-3: Fundamental Law of Gearing showing the pitch circles.....	13
Figure 2-4: Visual depiction of the Law of Conjugate Action.	15
Figure 2-5: Fundamental Triangle used in involute profile generation.	16
Figure 3-1: Involute gears and profiles for different gear sizes.....	22
Figure 3-2 Line of Action concept with the Fundamental Triangle	23
Figure 3-3: Involute profiles of different sizes aligned at the pitch circle.....	24
Figure 3-4: Velocity of the contact point as it travels along the Line of Action.	25
Figure 3-5: Initial profile comparison between Haupt and Buckingham.	26
Figure 3-6: Plot of the paths of contact of the initial, final and Hybrid profile.....	27
Figure 3-7: Constraint diagram for pressure angle comparison method.....	28
Figure 3-8: Pressure angle comparison at the point of contact.....	29
Figure 3-9: Pressure angle difference between the triangle Φ and the profile Φ	31
Figure 4-1: Overview concept of Danieli's Method with a moving pitch point	36
Figure 4-2: Pictorial description of the method proposed by Danieli.....	37
Figure 4-3: Difference in calculated values between Danieli and Buckingham methods.....	39
Figure 4-4: Anti-rotating slotted link mechanism for pitch line creation	40
Figure 4-5: Teeth profiles produced during duplication of Danieli's method.....	40
Figure 4-6: Graphical pressure angle measurement method.....	41
Figure 4-7: Pressure angle deviation on a Non-Circular Gear.....	42
Figure 5-1: PEPCT embodiment using Non-Circular Gearsets.....	48
Figure 5-2: Speed ratio output for a piecewise continuous transmission.	50

Figure 5-3: Non-circular gear diagram for PECVT embodiment.....	51
Figure 5-4: Non-circular gear diagram for PEPCT embodiment.....	52
Figure 5-5: Transition region for a non-circular gearset.....	53

1 INTRODUCTION

The current energy crisis has motivated research in different areas to make energy consuming machinery more efficient as well as eco-friendly. Hybrid and alternative fuel vehicle production has increased significantly over the last few years utilizing methods such as regenerative braking, dynamic battery recharging and other efficiency methods. These new advances have been focused on increasing efficiency while maintaining or enhancing vehicle performance.

Some research has focused on increasing the efficiency of the engine-transmission system as a whole. In standard and automatic transmissions the engine speed, measured in revolutions per minute (RPM), is used to vary the output and gears of different sizes are interchanged to increase efficiency by narrowing the speed range that the engine has to function in. As the engine modulates its speed during shifting, it deviates from its optimal speed for fuel efficiency and/or maximum torque. This deviation from the optimal speed causes more fuel to be consumed than is necessary had the engine been allowed to stay at its optimal speed. Another source of inefficiency is the decoupling of the engine from the transmission during shifting. This decoupling of the engine from the transmission causes efficiency and power loss due to the clutch absorbing energy during the time lapse required to make the shift. These inefficiencies are caused by the limits of current transmission technology. In order to avoid these inefficiencies, new concepts in transmission design would need to be developed.

Currently a substantial amount of research is being conducted in the area of transmissions that can eliminate or reduce these inefficiencies. This is evident by the influx of CVTs (Continuously Variable Transmissions) into the market. The concept of a CVT allows the engine to stay within its optimal RPM range for fuel efficiency or power while the transmission is used to vary the output speed of the vehicle. The concept of a CVT enables the overall engine-transmission system to be more efficient. Many different CVT designs have been developed to accomplish this concept. Two current examples are the Subaru Transmission, which uses a metal chain CVT design, and Nissan's Push belt CVT, design where a metal belt is used to transfer power from one shaft to another. Both of these transmissions have increased the efficiency and power transfer capability of current transmissions but have done so at some cost. Their performance is limited because they rely on friction to transfer torque as opposed to gears as in manual or automatic transmissions. Using friction limits their capabilities to lower-torque applications. The use of friction also introduces more wear components that need to be serviced and replaced. Despite having introduced some negative outcomes, the potential for the concept of a CVT is very promising.

Research has been conducted to come up with transmission embodiments that have all of the positive implications of CVTs without any of the drawbacks. Anderson [01] researched various patented designs of CVTs that use positively engaged members as opposed to friction to transfer power. He defined a PECVT (Positively Engaged Continuously Variable Transmission) family of designs which is a sub-category of CVT designs. The concept of a PECVT is very similar to the concept of CVTs but has the added feature of not having friction components (which limit the amount of torque transfer) as well as being the source of wear. The concept of a PECVT couples the input power source and the output in a positive engagement manner, as is

found when teeth contact on a gearset in a discrete ratio manual transmission. In the PECVT concept, solid members are used in the transmission to transfer torque from the engine to the output providing the high-torque capabilities without wear components. This would improve the efficiency of the overall system by having the engine operate at its optimal speed for efficiency. While the engine is at this optimal speed the PECVT varies the speed of the vehicle without disengaging the transmission from the engine. Using this approach, the engine would be able to operate at its maximum torque capability or fuel efficiency and the transmission would produce a varying output for maximum acceleration or maximum efficiency.

To date no functional PECVT embodiment is in production. Various patent applications have been filed with a myriad of designs for PECVTs, but none have produced a viable embodiment. This is because each design has had some manifestation of what Anderson [01] has termed the Non-Integer Tooth Problem (NITP). Overcoming this inherent problem is the key for an embodiment to be produced. The PECVT designs were also studied by Dalling [09], who enumerated functional principles that need to be met in order for a functional embodiment to exist. Haupt [11] has taken these functional principles and proposed a gearset of varying radii that could be the basis of a solution. This gearset would be designed to accept a constant speed input and produce a varying speed output.

Haupt's work [11] led to research on the topic of gearsets that produce a varying output from a constant input. Haupt and Danieli [10] are among those that have proposed analytical methods that produce a varying output from a constant input. These analytical methods also claim to maintain the correct meshing behavior of the engaged gear teeth. Also, these methods use gearsets to produce a varying output from a constant input. This variation from input to

output creates a ratio change between the gears. It is the feasibility of creating this ratio change that is the topic of this current research.

1.1 Research Objective

The objective of this research is to analyze the proposed methods of Haupt and Danieli that produce a ratio change using a varying output from a constant input while maintaining proper meshing of the gear teeth. These gearsets would enable a functional PECVT transmission to be produced. The secondary objective is to identify the changes to the fundamental laws of gearing that are required for a varying output from a constant input gearset to be produced.

1.2 Research Approach

In order to analyze the proposed methods of varying output gearsets a systematic approach has been developed. This approach ensures that the proposed methods are evaluated correctly and that the research objectives are met. The approach will follow the ensuing organization.

Chapter 2 covers the concept of CVTs and more specifically the concepts of PECVTs. This includes a review of the inherent problems that need to be overcome for a viable PECVT embodiment to be produced as well as the types of possible embodiments as proposed by Dalling [09].

This chapter also explains the fundamentals of gear design and how involute gears maintain these fundamentals. This is done to establish a base knowledge and background of gears and the fundamentals of their design. With the proper base knowledge covered, the area of non-circular gears is then introduced. The different types of non-circular or varying input to

output ratio gears and their methods of production are briefly discussed. Two analytical methods of producing gears were selected. The selected methods are introduced in this chapter and are the work of Haupt [11] and Danieli [10].

Chapter 3 describes the theory of non-circular gear design with a variable center distance and analyzes the work of B. Levi Haupt and his concept to design and produce non-circular gears. This chapter evaluates the proposed concept and compares its behavior to the theory of non-circular gear design.

Chapter 4 describes the theory of non-circular gear design with a constant center distance and analyzes the work of Guido A. Danieli and his method to design and produce non-circular gears. This chapter evaluates the proposed method and compares its behavior to the theory of non-circular gear design.

Chapter 5 describes an embodiment design that utilizes non-circular gears to transition between fixed gearsets. The design of these ratios and non-circular gearsets are discussed as well as the limitations of their utility.

Chapter 6 restates the conclusions from all chapters and makes recommendations for future research.

2 PECVT RESEARCH

To accomplish the task of developing a PECVT Haupt [11] has proposed that a gearset composed of gears with changing radii would be the basis of a solution that would enable a viable PECVT embodiment to be produced. This gearset concept falls in the category commonly known as non-circular gears and would produce a non-uniform rotary motion output from a constant input. To investigate this possibility we will first review the research that led up to this solution concept proposal by Haupt. This will mainly be done by reviewing the research conducted by Anderson [01] and Dalling [09] on CVT and PECVT designs. Next, we will cover the fundamentals of gear design and how they are applied to involute gears to form a base understanding of gear design. Next, we will cover previous research in the area of non-circular gears and their recent developments. With this background concerning non-circular gears, we will cover the implications and possibilities of their design and how it differs from standard gear design. Last, we will briefly review two types of non-circular gearsets that claim to produce a non-uniform output from a constant input. In this review we will become familiar with the theory, mathematics and implications of each method.

2.1 Continuously Variable Transmissions

The concept of a Continuously Variable Transmission (CVT) is to provide a continuous change in the output while receiving a constant input. The most common CVT design is the belt-drive CVT shown in Figure 2-1. The change of ratio is accomplished by changing the ratio of the

diameters of the primary and secondary drive. This allows for a relatively constant input and a varying output of a Continuously Variable Transmission.

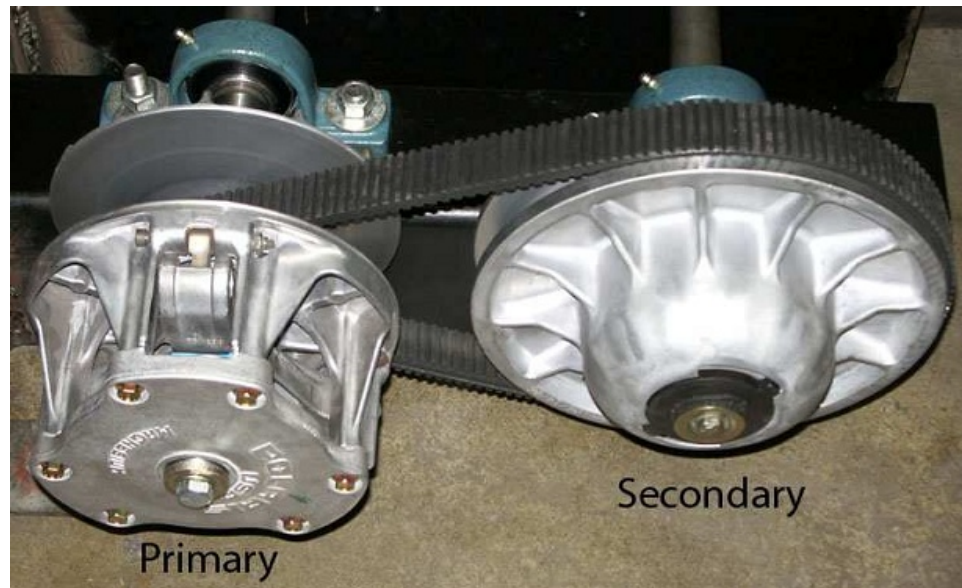

Figure 2-1: Typical belt drive CVT.

This CVT concept has many advantages. Using a CVT allows the engine to stay at its optimal RPM for fuel efficiency and/or torque while the CVT varies the output speed to what is desired. In the traditional concept of a Manual and Automatic Transmission, the engine speed is modulated in order to vary the output speed and different sized gearsets are interchanged to improve efficiency.

Many different designs have emerged trying to take advantage of the CVT concept. Nissan has developed a Push belt CVT [17] design which uses a metal push belt that runs on friction plates to transfer power from one shaft to another. Similar to the Nissan CVT design, Subaru [22] has developed a metal chain CVT design which uses a metal chain in place of the metal belt. Both of these transmissions have increased the efficiency and power transfer

capability of current transmissions, but have done so at some cost. Their performance is limited because they rely on friction to transfer torque at varying ratios as opposed to gearsets of various ratios as in manual or automatic transmissions. Because friction is involved, their capabilities are limited to lower-torque applications. The use of friction also introduces more wear components that need to be serviced. Despite having introduced some negative outcomes, the potential with CVTs are very promising especially if a means whereby the benefits can be maintained and their negative outcomes eliminated. One proposed method of harnessing all of the positive characteristics of a CVT while eliminating the negative characteristics of friction is the concept of a Positively Engaged Continuously Variable Transmission (PECVT).

2.1.1 PECVT Definition and Non-Integer Tooth Problem

A Positively Engaged Continuously Variable Transmission (PECVT) is a sub-category of Continuously Variable Transmissions that was defined by Anderson [01]. In this work, Anderson analyzed different CVT embodiments noting their strengths and weaknesses and also identified the new sub-category of PECVT's with its inherent problems.

Positive engagement describes a class of CVTs that couple the input power source and the output in a positive manner, as occurs in a simple gear pair found in a positively engaged, discrete ratio transmission. PECVTs are an overlap area or hybrid between a Continuously Variable Transmission and Positive Engagement Transmissions. A PECVT is required to have positive engagement of the members during the changing of gear ratios. This positive engagement allows for high torque transfer capabilities which overcome the limitations of standard friction dependent belt driven CVTs.

Within the PECVT sub-class there are inherent problems that need to be overcome in order for an embodiment to be feasible. The major obstacle classified by Anderson is the Non-

Integer Tooth Problem (NITP). This problem is manifest when the effective diameter of integer based members such as gears or chains is increased. These integer based members have a specific spacing between each segment around their circumference such as is found in gear teeth. As the diameter is increased, the segment length, or spacing between teeth, must remain the same which causes an overlap or partial segment that does not function properly until the next full segment or integer is attained. This concept is shown in Figure 2-2 [09] with a chain and sprocket setup. As the sprocket changes size from (a) to (b) a partial tooth is developed. This is because the circumference has not yet reached the next integer segment and the chain has a constant segment length. Since the chain does not change size, engagement is prohibited by the incompatible segment lengths.

The Non-Integer tooth problem in one form or another is manifest on every known PECVT design. This problem comes in various forms from orbiting planet gears that are on extending arms, to a chain sliding along increasing diameter cones. Each is a manifestation of the inherent problem in using engaged members with varying diameters. In order for this PECVT embodiment to be viable, the inherent Non-Integer Tooth Problem needs to be overcome.

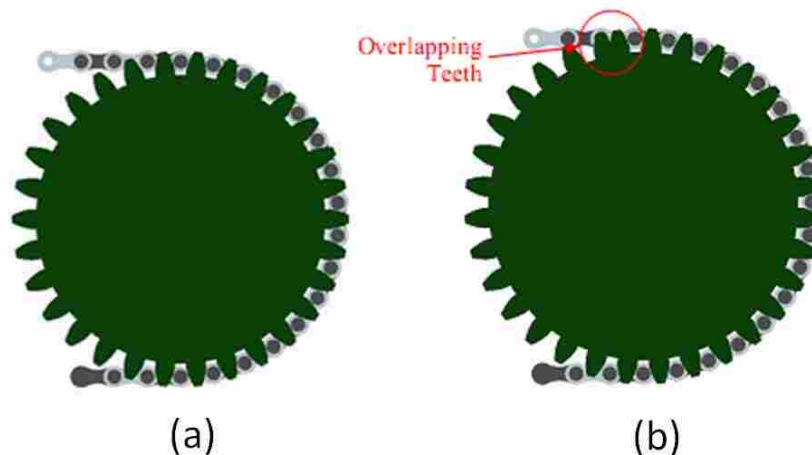

Figure 2-2: Manifestation of the Non-Integer Tooth Problem (NITP).

2.1.2 Classification of Possible PECVT Embodiments

The primary work of Dalling [09] has been to categorize where a solution to the NITP might lie. Since the design space is seemingly small inside a very large realm of possibilities it was necessary to categorize and classify the design space. Dalling also identified functional principles that he deems necessary for an embodiment to exist.

Dalling [09] accomplished this using a methodology called TRIZ. TRIZ is a problem solving methodology utilized to solve scientific and engineering problems. This methodology was developed by Genrich Altshuller in Russia around 1946. It was derived from Altshuller's analysis of over 40,000 patents in which he discovered important problem solving principles. These principles were used by Dalling to generate and select concepts that could conceivably overcome the NITP and produce a viable solution for a PECVT.

In his work Dalling defined two classes of possibilities that might overcome the NITP: the problem correction class and the problem elimination class. The problem correction class utilizes a variety of different mechanisms to adjust the orientation of the gear teeth to overcome the non-integer tooth problem. These devices range from one-way clutches to a myriad of other devices.

The problem elimination class uses various methods such as tooth conforming and feedback to eliminate the non-integer tooth problem. For these different classes Dalling developed governing principles that would need to be satisfied to assure the functionality and feasibility of all PECVT embodiments. The following are the governing principles defined by Dalling:

- 1) The Matching Pitch Principle: The reorientation of the driving or driven gear (whichever possesses the characteristics of a continuously variable diameter gear) must occur so that its

circular pitch is equal to or an integer factor of the circular pitch of the gear or member with which it is engaged. This is called the matching pitch principle.

2) Continuous Engagement Device: If the ideal PECVT embodiment belongs to the problem correction class, a device needs to be devised and implemented in such a way that a constant output is not being traded for positive, continuous engagement when a correction is applied to satisfy the matching pitch principle.

3) More Robust, Less Complex: If an ideal PECVT embodiment belongs to the problem elimination class, the devices and methods used to eliminate the problem and ensure proper meshing need to be less complex and more robust for high torque applications in the tooth conforming family.

4) Feedback Device: A device that gathers more intelligence from the transmission's parameters in order to vary and, more importantly, control the RPM ratio would be another alternative for a promising embodiment in the feedback family of the problem elimination class.

With these governing principles defined and enumerated, possible embodiments can now be explored. Haupt [11] has taken these governing principles and proposed that a gear of changing radius could be made to overcome the NITP. This gear would mesh with an involute gear, receive a constant input and produce a varying output which Haupt describes as the conceptual solution to a viable PECVT embodiment.

Using this gearset as a possible solution allows various configurations that can be explored and may lead to a feasible embodiment. Some of these configurations include utilizing the gearset to transition between existing gearsets or utilizing the gearset in a planetary or differential combination. There are various other conceptual embodiments that can be conceived

with the addition of a solution that overcomes the Non-Integer Tooth Problem. To understand the development of such a gearset, the fundamentals of gear design will now be reviewed.

2.2 Fundamentals of Gear Design

Our study of the fundamentals of gear design will be based on Involutometry which is the study of involute gears or gears with involute shaped gear teeth. We will use involute gears to show how these fundamentals are applied. Involute gears are the industry standard gear teeth profile and are almost exclusively used because of their unique properties. Involute shaped gear teeth transfer constant motion from one gear to another in a gearset.

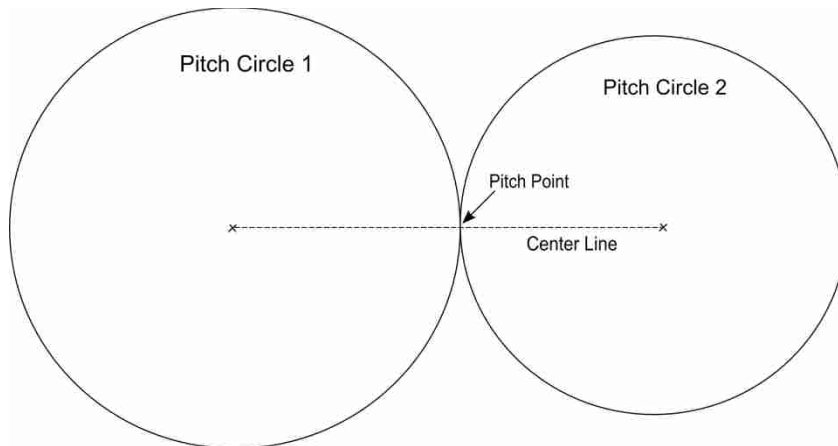

Figure 2-3: Fundamental Law of Gearing showing the pitch circles.

These gears can be thought of as two circles, called pitch circles that have a common center line, fixed center distances, touch at one point, roll without sliding and transmit motion from one circle to the other as shown in Figure 2-3. This figure also demonstrates the concept of the Fundamental Law of gearing, where the pitch circles are tangent to each other and at the pitch circle roll without sliding. Pitch circles of different sizes can run against a single pitch

circle. When this occurs, a different speed or angular velocity ratio between the two pitch circles is produced. These pitch circles satisfy the Fundamental Law of Gearing.

Fundamental Law of Gearing: *The angular velocity ratio between gears of a gearset must remain constant throughout the mesh. [18]*

Another important aspect of the pitch circles is that they are conjugates of each other. This means that when two surfaces mesh, or are in contact each other, the normals at the point of contact are always collinear. If they were not collinear, another point would be in contact. Shapes are conjugate when the surfaces of the shapes contact the same consecutive points on each surface. The pitch circles of gears satisfy this requirement. They contact at a point along the centerline between the gears. This point is called the pitch point. The normals to the pitch circles at the pitch point are directed along the centerlines between the gears, satisfying the definition of conjugate shapes.

The profiles of the gear teeth also need to be conjugates of each other. As the gears rotate, the tooth profiles contact each other and transmit rotary motion from one tooth to the other. There are an infinite number of teeth profiles that can be used to transfer this motion. However, the behavior of each different type of profiles is governed by the Law of Conjugate Action [03].

Law of Conjugate Gear-tooth Action: *To transmit uniform rotary motion from one shaft to another by means of gear teeth, the normals to the profiles of these teeth at all points of contact must pass through a fixed point in the common center line of the two shafts.[03]*

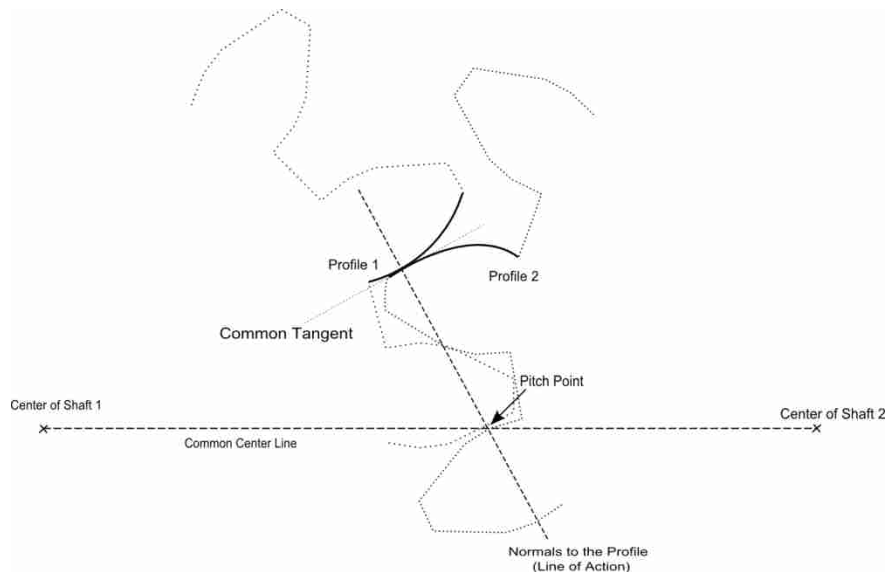

Figure 2-4: Visual depiction of the Law of Conjugate Action.

The Fundamental Law of Gearing ensures that the angular velocity ratio is constant between the gears as they rotate and the Law of Conjugate Action ensures that the tooth profiles mesh in a way that uniform rotary motion is transmitted. This interaction, shown in Figure 2-4, requires the profiles of mating teeth to touch at one spot and for the velocities of the profiles at those points to be equal in magnitude along the direction normal to the surface. This physical behavior is present and requires that the point in contact with the opposing point on each tooth form, must move at the same velocity. The line formed by the normals to the profiles when they are in contact, is termed the Line of Action.

2.2.1 Involutometry

The next step in the review is to show how involute profiles satisfy the Fundamental Law of Gearing and the Law of Conjugate Action. This is accomplished by having fixed pitch circles and by the constraints of the Fundamental Triangle. The Fundamental Triangle is used to generate the involute curve described by Buckingham [03] as “the curve that is described by the

end of a line that is unwound from the circumference of a circle.” The circle from which the line is unwound is termed the base circle and the line is r_c , shown in Figure 2-5.

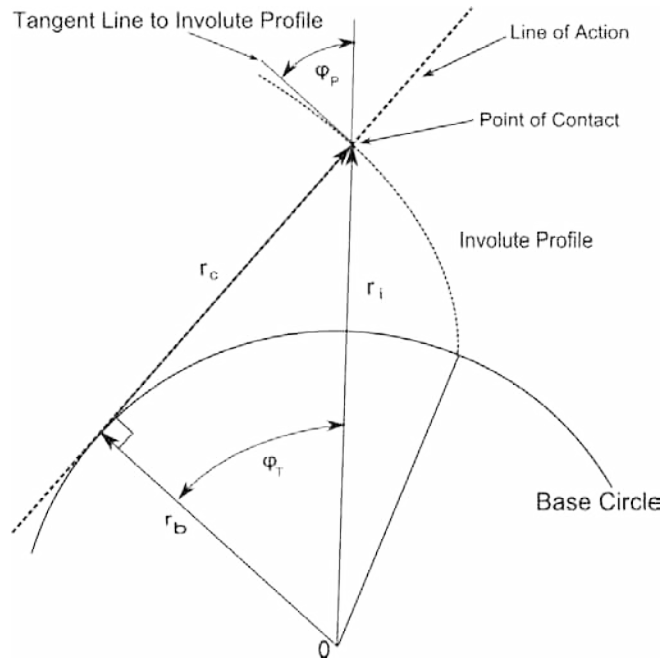

Figure 2-5: Fundamental Triangle used in involute profile generation.

As the line r_c is unwound from the circle, the geometry of the Fundamental Triangle is created. The triangle is formed by the lines r_c , r_b , r_i in Figure 2-5. This triangle is such that r_c is always normal to the involute profile as the curve is generated. This unique property of involutes fulfills the Law of Conjugate Action by having the normal to the profile (r_c) always in line with the Line of Action as in Figure 2-4. The actual derivation of the Fundamental Triangle will not be shown, but its fulfillment of the Law of Conjugate action will be discussed. The line r_c is normal to the profile at the point of contact, as shown in the figure. The point of contact is defined as the instantaneous location where one gear tooth profile contacts another gear tooth profile. This line, r_c , is collinear with the line of action and, if extended, would go through the

Pitch Point, which will be shown later. The pressure angle at the profile (ϕ_P), shown at the top of Figure 2-5, is defined as the angle between the tangent to the involute profile and the extension of r_i past the point of contact. Involutés have the unique property such that ϕ_P is also the angle between r_b and r_i and is called the pressure angle of the Fundamental Triangle (ϕ_T). This is constrained by geometry, since r_c is normal to the involute profile and tangent to the base circle. The line r_b is also normal to the base circle by definition. The involute profile spans in both directions and is limited so it does not interfere with the mating gear. The outermost radius is referred to the addendum and the innermost radius is referred to the dedendum.

The unique properties of involutes satisfy the Fundamental Law of Gearing and the Law of Conjugate Action. The Fundamental Law of Gearing is satisfied because involutes have constant pitch circles. The geometry of the Fundamental Triangle, which is a unique property to involutes, fulfills the Law of Conjugate Action because the normal to the profile, r_c , is along the Line of Action, as shown in Figure 2-4 and Figure 2-5. This ensures that the tangent to the profile, r_c , will always be perpendicular to the Line of Action. Since involute gear teeth are used on both sides of the gearset and the profiles are normal to the Line of Action they are conjugate profiles.

In the creation of gears there are a few free choices that need to be determined. These free choices are the pressure angle at the pitch point and the diametral pitch. For involutes, the pressure angle relative to the gear center changes at each point along the profile. However, this pressure angle, relative to the inertial frame, aligns with the slope of the pressure line that is used to create the involute profile. The angle of this pressure when the point of contact is at the pitch circle is used as a reference to specify the portion of the involute shape that is used for the gear

tooth profile. The pressure angle determines the shape of the tooth and can be varied for non-standard application.

The other parameter to be chosen is the diametral, pitch which defines the width of the tooth and spacing between teeth. The shape of the tooth is mostly independent of the spacing and width of the teeth and is a function of the pressure angle at the pitch circle. The spacing is important in making sure that there is overlapping contact between teeth. Otherwise there will not be a smooth transfer of rotary motion between teeth.

The free choice parameters of the pressure angle at the pitch point and the diametral pitch are free choices for gear design and are varied for stress and other various other design considerations.

With a base understanding of how the fundamentals of gear design are satisfied for involute teeth in receiving a constant input and producing a constant ratio output, the design of non-circular gear teeth will be presented.

2.3 Non-Circular Gear Design

Non-circular gears are gears which do not have a constant pitch radius. The design of these gears has developed over many years [16]. Initially, the use of non-circular gears started with eccentric gears. Eccentric gears were essentially circular gears with an offset center of rotation which produced a sinusoidal output. Many of the initial studies performed on eccentric gears assumed that the eccentricity did not affect the meshing process [15]. Later studies acknowledged the influence of the eccentricity on the meshing process [24]. The study of eccentric gears led to the study of other shapes including elliptical, sinusoidal, logarithmic spiral, and reciprocal functions [08]. These shapes were utilized to get different behavior and

performance out of the gearset. Later the efforts expanded to other shapes and functions that were numerically or analytically determined.

Initially, the generation of non-circular gears was accomplished by mechanical means, using a master non-circular gear and a master-rack. The idea behind this mechanical method is the same concept used for manufacturing constant radius gears, where rack and shaper cutters are utilized. However, the generation of the master-gear or master rack for circular gears is a much more difficult process.

In 1996 a mathematical model for manufacturing non-circular gears with rack cutters was developed by Chang and Tsay [05]. Chang and Tsay [06] also proposed a method to determine the complete mathematical model of tooth profiles for non-circular gears. This method was based on an equation of motion and the use of the inverse mechanism relationship. Bair [02] also proposed a computerized method that would generate elliptical tooth profiles by means of a shaper cutter.

Recent advances have come up with other means by which non-circular gears may be generated without the use of a rack or shaper cutter. In 2000, Danieli [10] proposed an analytical method for producing two non-circular gears with a fixed center distance. This is done by determining the profile of a non-circular gear using the integration of a differential equation that describes the behavior between consecutive points that make contact on the tooth profiles. Haupt [11] in 2008 proposed a concept of a gearset that uses a non-circular gear to mesh with an involute gear. This concept employs a variable center distance to produce the changing gear ratio.

These two methods provide unique ways of producing possible gearsets that can be investigated to determine their benefits to the development of a Positively Engaged Continuously

Variable Transmission. The next two chapters focus on the analysis of these two gearsets. The work of Danieli [10] will be used to create a traditional non-circular gearset, which will be subsequently analyzed to determine its possible employment in a PECVT. The concept design of Haupt will be further developed and applied to a full gear to determine its possible employment as a viable non-circular gearset. In this analysis of these two gearsets, the limitation and possibilities of the use of non-circular gearsets in a PECVT is also discussed.

3 NON-CIRCULAR GEARSETS WITH VARIABLE CENTER DISTANCE

Non-circular gearsets with a variable center distance are not very common. In fact, Haupt [11] is the first to introduce this concept. This concept uses a non-circular gear on one side and a traditional involute gear on the other. This implies both limitations and possibilities. The limitations are the fact that you have to account for a moving center distance. The possibilities are that you can utilize this gear and have it mesh with involute gears.

3.1 Theory

The concept developed by Haupt employs the fact that involute gears of different sizes mesh together in ways that still satisfy the fundamentals of gear design. In Figure 3-1, the involute gear on the right will mesh properly with any of the involute gears on the left. This is possible because the tooth profiles are unique to each gear size. This property is exploited in the work by Haupt. Haupt proposes that a profile, called the Hybrid Tooth Profile [11], can be made that transitions between the different involute shapes as it goes from one gear size to another. As the gear transitions in size it meshes and remains conjugate like an involute gear of a particular size. As it transitions in size the resulting profile is no longer involute and is termed by Haupt to be a hybrid profile. The proposed hybrid profile, as it goes through its mesh with the output gear on the right, shown in Figure 3-1, would transition from the inner small gear profile to the large outermost profile. This causes a change in gear ratio as the relative size of the input and output gears have changed. During this process the center distance of the hybrid gear has also moved

away from the center of the regular involute gear. The Hybrid profile can be thought of as a profile made from a series of infinitesimal changes in gear sizes.

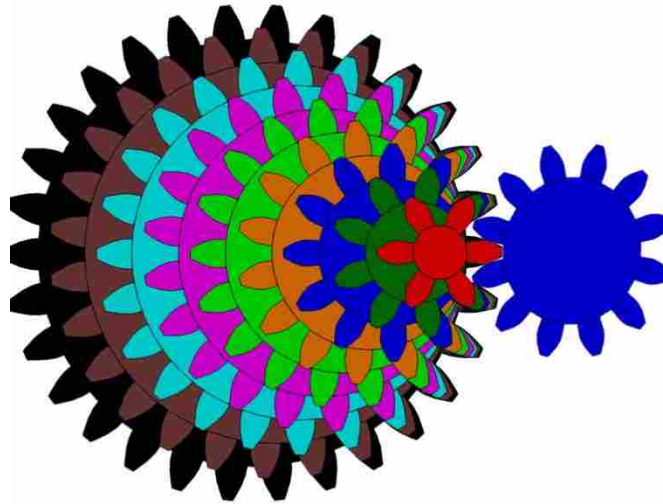

Figure 3-1: Involute gears and profiles for different gear sizes.

This is accomplished by what Haupt has termed the Line of Action model shown in Figure 3-2. The Line of Action model controls the position and velocity of the point of contact as it goes along the line of action. This is performed by using the Fundamental Triangle from Figure 2-5 and orienting it so that r_c is collinear with the Line of Action shown in Figure 3-2. In this view it can be seen that as the point of contact goes from point A to B as the gear rotates clockwise. The point of contact also travels along the profiles of the respective gears. In standard gears, assuming a constant angular input, the point of contact travels along the line of action at a constant rate.

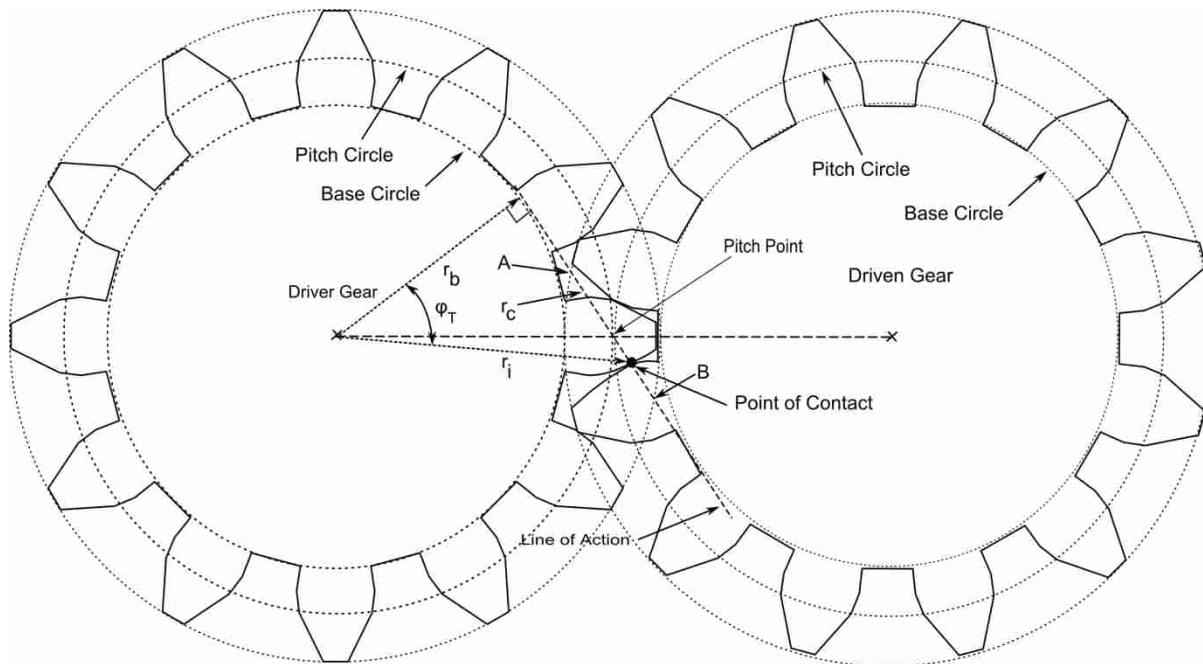

Figure 3-2 Line of Action concept with the Fundamental Triangle

The idea of the transitioning profile stems from the fact that different involute gear sizes can mesh appropriately with each other according to the Law of Conjugate Action [03]. This is possible as long as the pressure angle and the diametral pitch, tooth spacing parameter, of the two gears are the same. Even with these parameters being the same, the tooth shape still varies with diameter as shown in Figure 3-3. The inner shapes correspond to smaller pitch circles and the outer shapes correspond to larger pitch circles. Each of these profiles at the correct diameter is conjugate with all other involute profiles. As shown in the figure, each involute profile has a shape that is unique to a particular size of base and pitch circle. The theory behind the transitioning profile is that it will act like a certain size at one instant and then transition through an infinite amount of other tooth sizes until it arrives at the desired size. Or in other words, the Hybrid profile as termed by Haupt is made up of a series of infinitesimal changes in size of

conjugate profiles, whose composite is also a conjugate profile. This change in the pitch circle size produces the ratio change necessary for a feasible PECVT.

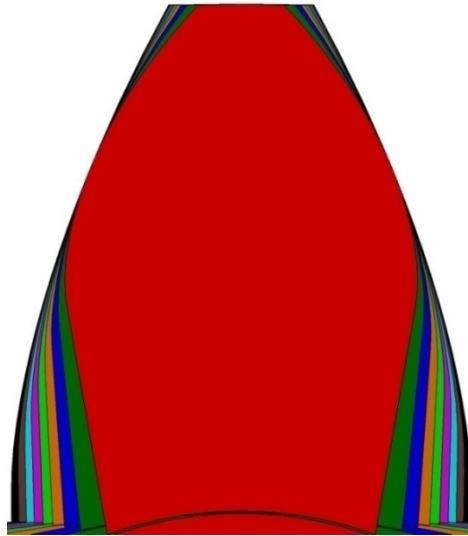

Figure 3-3: Involute profiles of different sizes aligned at the pitch circle.

The required profile transitioning is described by the second main idea, which is to control the velocity of the contact point as it travels along the line of action. In standard gears the point of contact travels along the line of action at a constant rate. This can be thought of as a string that is wrapped around two circles. The points on the string all have to move at the same velocity. The same is true with the points along the line of action. The contact point that is shown in Figure 3-4 moves along the line of action at a constant velocity. The model that Haupt devised describes the position of the point as it accelerates the point along the line of action. When this happens, the center distance translates out in order to adjust for the accelerating point and changes the gear ratio. This change in gear ratio deviates from the Fundamental Law of Gearing in that the ratio is changing, although, at each instant it is operating at a specific ratio and a specific tooth size.

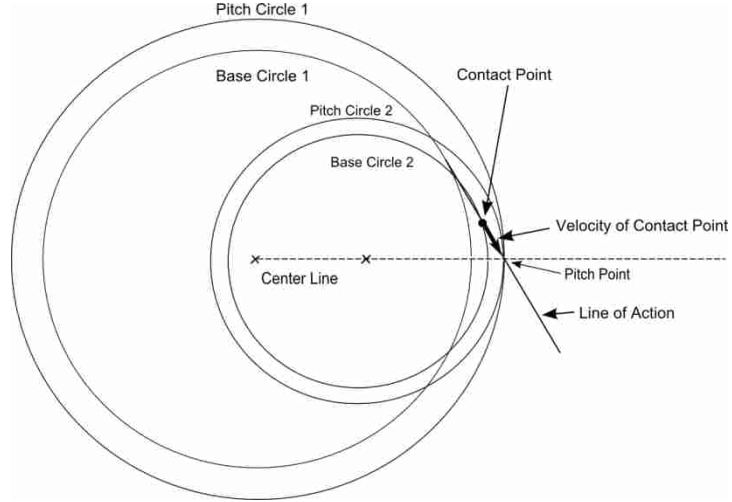

Figure 3-4: Velocity of the contact point as it travels along the Line of Action.

3.1.1 Duplication of Results

To determine the validity of the derivation and the areas of concern that were noted above we will now use the derived method to duplicate Haupt's results. Haupt's work is well documented and his programming code to generate the Hybrid profile is found in [11]. Our focus in this section will be to ensure that the position and the slope satisfy conjugate action and that the proposed output is produced.

To validate the shape of the teeth we will generate involute gear profiles and compare them with the accepted involute equations found in [04]. As shown in Figure 3-5 Buckingham and Haupt's Line of Action model produced the same result with negligible difference. This shows that Haupt's method accurately produces involute teeth profiles and that the results obtained agree with the results obtained using Buckingham's equations. The results for both the initial and final profiles were obtained, but, only the initial profile comparison are shown here.

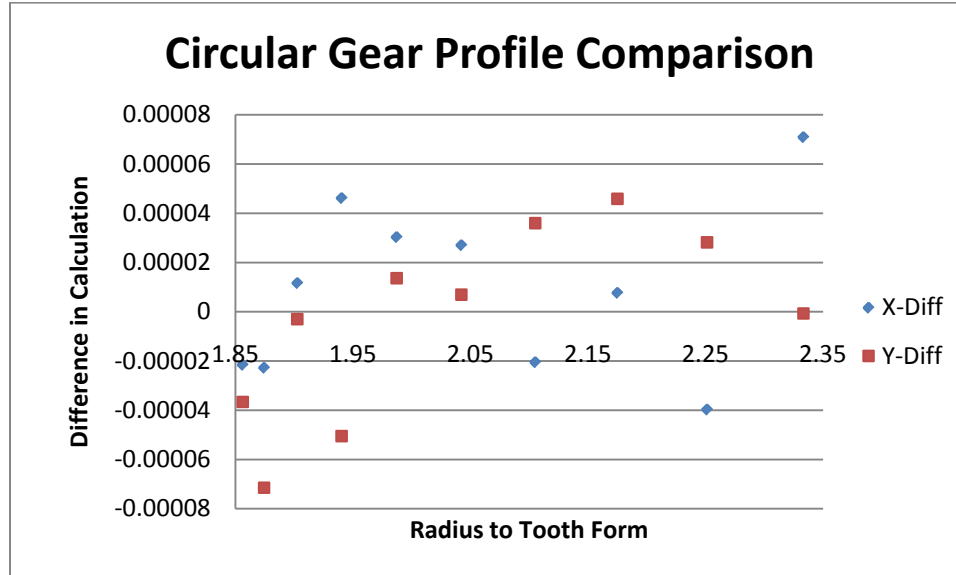

Figure 3-5: Initial profile comparison between Haupt and Buckingham.

With the profiles produced by Haupt’s method shown to be generated correctly we will now focus on the transition between the profiles, principally we need to ensure that conjugate action is present. As you recall from above, conjugate action needs to be maintained so that we get a smooth transition of angular velocity. Haupt validated his own method using the path of contact which we will duplicate and analyze.

Path of Contact: *When conjugate gear-tooth profiles act together, the point of contact between them will travel along a definite path. (AMOG pg2)*

The path of contact yields a curve that shows the contact positions of the different points as the tooth goes through its mesh. For involutes, this is a straight line that is collinear with the line of action. The process of generating the path of contact for involute teeth is given by Buckingham [03] and only the results will be shown here.

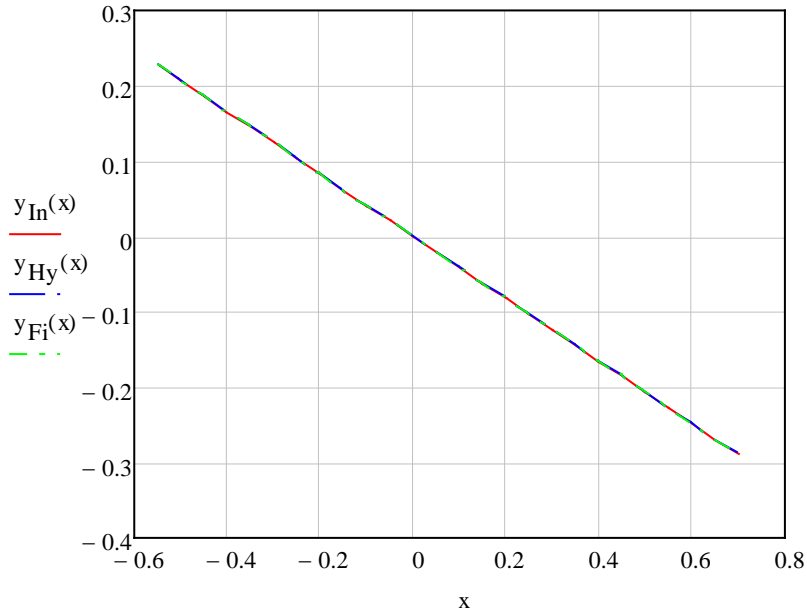

Figure 3-6: Plot of the paths of contact of the initial, final and Hybrid profile.

The path of contact shown in Figure 3-6 was generated for the initial and final involute profiles as well as the hybrid profile. A trend line was fit to the results using a first order polynomial, resulting in the slopes matching out to four significant figures, which matches the results obtained by Haupt. This shows that the hybrid profile, according to this test, has the correct slope at the different points.

Table 1: First order trend line for initial, final and Hybrid profiles.

Path of Contact	1st Order Polynomial
Initial Involute Profile	$y = -0.4141x + 0$
Hybrid Involute Profile	$y = -0.4141x + 0$
Final Involute Profile	$y = -0.4141x + 0$

In the generation of the path of contact, it is noted that the pressure angle used is ϕ_T , which is measured between r_i and r_b shown in Figure 3-7. However, the angle that needs to be checked is ϕ_P , which is also shown in Figure 3-7. For involute profiles, this angle is the same value, so either one may be used. For the hybrid profile it has not been shown that they are indeed the same value. The fact that these two angles are the same is a unique property of involutes and since the hybrid is not a true involute, it is not guaranteed that this property holds.

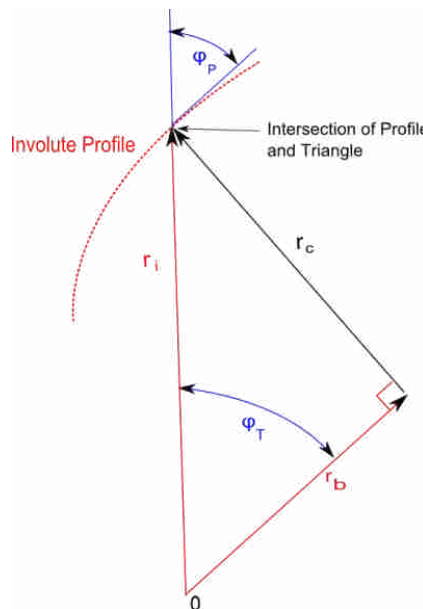

Figure 3-7: Constraint diagram for pressure angle comparison method.

3.2 Simulation Analysis

To investigate this possible source of error, ϕ_P must be measured and compared with the pressure angle used in the path of contact, which is ϕ_T . The reason for this is that the path of contact requires that the profiles are conjugate profiles, profiles that have conjugate action. If ϕ_P

and φ_T are not shown to be the same value, then the profile is not conjugate with involute profiles.

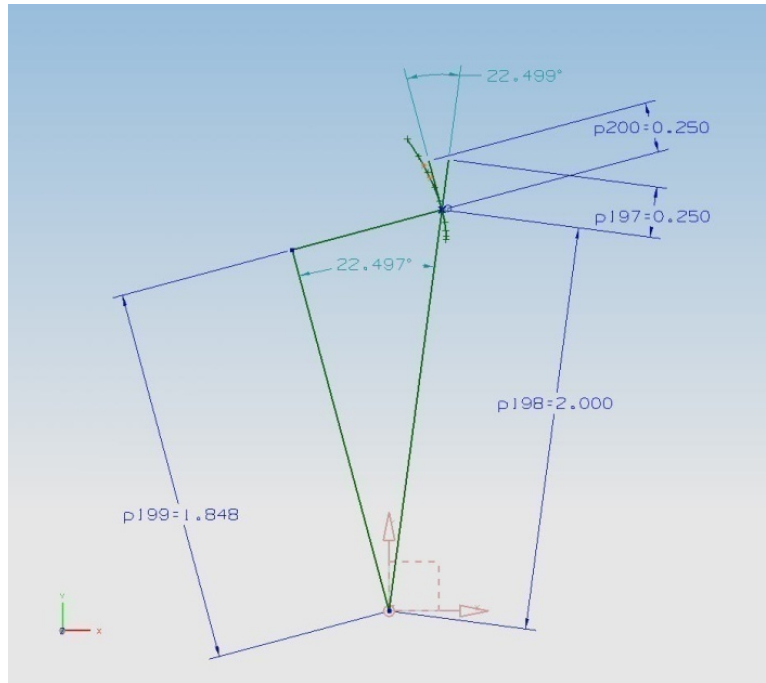

Figure 3-8: Pressure angle comparison at the point of contact.

The process devised to investigate this apparent error is to generate a hybrid profile and compare the angles by measuring them using a CAD system. The angles must satisfy the imposed constraints that were made by specifying the lengths of r_i and r_b , shown in Figure 3-7 and constraining the Fundamental Triangle to intersect on the profile. The lines r_b and r_c were constrained to be perpendicular, which makes the diagram fully constrained. The pressure angle (φ_T) was then measured and compared with the computed output (φ_C). The pressure angle at the profile φ_P was measure by constraining the extension of r_i and the tangent line to be coincident with the contact point and tangent to the profile shown in Figure 3-8. This was done for various

points along the profile and the measured pressure angles of φ_T and φ_P were compared to the computed value φ_C and are shown in Table 2.

To show the change in the pressure angle, the difference between φ_C and φ_T was also calculated and shown as $\Delta \varphi_{CT}$. The difference between φ_C and φ_P was also calculated and is shown as $\Delta \varphi_{CP}$.

Table 2: Pressure angle comparison of a Hybrid tooth profile.

φ_C	φ_T	φ_P	$\Delta \varphi_{CT}$	$\Delta \varphi_{CP}$
35.12746	35.12746	35.12746	3.7E-07	3.697E-07
35.11994	35.11995	35.03153	-3.1E-07	0.0884107
35.0527	35.0527	34.45804	4.82E-07	0.5946585
34.41728	34.41728	29.56943	3.71E-07	4.8478514
33.21047	33.21047	22.4221	-3.9E-07	10.788368
31.79537	31.79537	16.48208	1.33E-07	15.313296

As shown in Table 2, there is no change in $\Delta \varphi_{CT}$, which shows that the Fundamental Triangle has the same behavior as an involute. However, there is a big change in $\Delta \varphi_{CP}$, which is the difference between the computed pressure angle (φ_C) and the pressure angle at the profile (φ_P). This shows that the pressure angle used to construct the Fundamental Triangle is accurate, but that this angle is not the same as the pressure angle at the point of contact. Figure 3-9 shows these results graphically. Initially there is no difference in the pressure angles, but as the span of teeth increases, shown on the x-axis in Figure 3-9, the pressure angle difference grows. Thus, the method starts with the correct behavior but then deviates as the profile is produced. This result invalidates the path of contact test performed by Haupt since the path of contact requires conjugate profiles and the hybrid profile has been shown to not be conjugate.

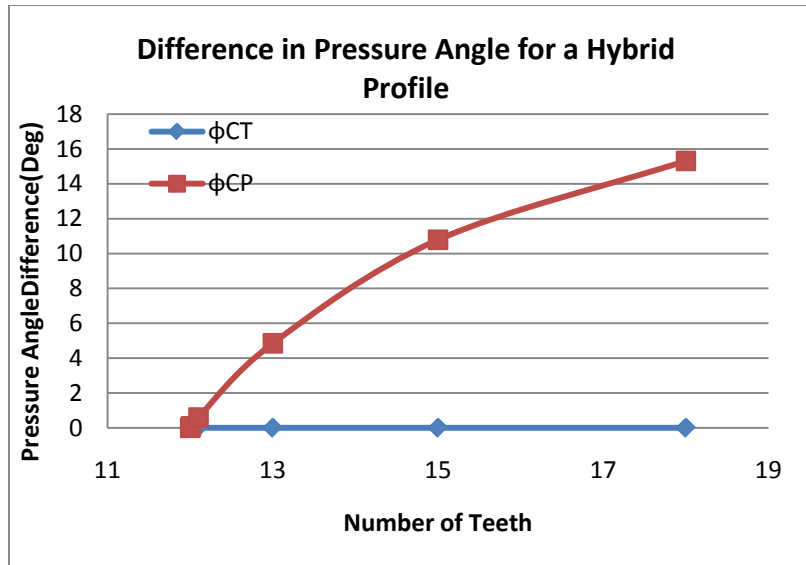

Figure 3-9: Pressure angle difference between the triangle Phi and the profile Phi.

3.3 Haupt Method Conclusions

The method derived by Haupt uses an instantaneous change in involute gears to create a Hybrid gear profile that transitions from one involute size to another. This is driven by accelerating the point of contact along the line of action in a model that Haupt termed the Line of Action model [11]. The theory behind the Line of Action model seems viable and is a logical way of producing a variable gear that meshes with an involute gear. However, some discrepancies in the pressure angle suggest that some behavior is not accounted for, or is inaccurately accounted for.

These discrepancies in the pressure angles can be attributed to a few possible reasons and have the effect of making the hybrid profile a non-conjugate profile. The first possible reason is the missing velocity term in the derivation of the Fundamental Law of Gearing, where the translation of the center distance is not accounted for. Another possible reason is related to

assumptions that the pressure angles on the fundamental triangle are the same for a hybrid gear as for a regular involute gear. The last reason has to do with the effect of a changing radius in mapping the points to Cartesian Coordinates. One, or all of these possible areas could be the reason for the resulting profiles to not be conjugate. More research would have to be done to determine the needed corrections for this method to be viable.

Although the result of Haupt's method proved to be inaccurate, some insight was gained about the principles by which non-circular gear design is governed. These principles and constraints used by Haupt are very similar to the principles and constraints of circular gear design, which are the Fundamental Law of Gearing and the Law of Conjugate Action. In the work of Haupt these principles are enforced at each instant in time. This has the effect of modifying them to allow for the changing gear ratio. These principles to some degree are still kept. The pitch circles must still remain conjugate as is required by the Fundamental Law of Gearing, but they do not have to maintain a constant ratio and must adjust their size according to the desired change in ratio. The profiles need to remain conjugate and the normals need to be collinear according to the Law of Conjugate Action, but the pitch point can travel as the ratio increases. These principles give insight to the possible principles that might be the governing fundamentals for non-circular gear design, but cannot be verified because the method is not yet complete.

Even with these drawbacks, Haupt's method does pose some possible advantages, which include the ability to mesh a changing radius gear with a constant radius gear. This feasibility has not yet been proven and will need to be investigated further. To enable this to occur it is recommended that Haupt's method be further developed using the following steps:

1. Determine whether the pitch circle of a constant radius gear and the pitch line of a changing radius gear can be made to be conjugates of each other.
2. If it is not possible to produce conjugate pitch circles in this manner, Haupt's method may have to be modified to have the concept of the Hybrid Profile applied to both gears as opposed to one.
3. Evaluate the application of the Fundamental Law of Gearing to Haupt's proposed method to account for the velocity of the center of the changing radius gear.
4. Study the transition between the contact points on the tooth profile for a changing radius gear and derive a constraint that can be implemented to ensure that conjugate action is preserved on the teeth profiles.
5. Investigate the Cartesian coordinate generation method to ensure that the intended profile is being generated and is not affected by the changing pitch circle.

4 NON-CIRCULAR GEARSETS WITH CONSTANT CENTER DISTANCE

The design of non-circular gearsets as mentioned has been around for some time. Their methods of design and production have made it complicated to use them in design work. Danieli has come up with an analytical method of producing the gearsets. This allows for the rapid design of the gears to be performed and the parameters changed to satisfy engineering requirements. This chapter will cover the theory behind Danieli's method, its comparison to circular gears and an analysis of the gear, and a simulation of it. This will help identify some limitations and possibilities of non-circular gear design.

4.1 Theory

The method proposed by Guido Danieli uses an infinitesimal approach with both centers of the gears fixed with a moving pressure line as shown in Figure 4-1. In this method, the gear centers are fixed and the pressure line translates, but always maintains the same angle, $-\alpha$, with the horizontal. This is shown in Figure 4-2 as the pressure lines intersect the line between the centers of the gears at C. The point C' is where the pressure line crosses at the next instant in time. The translation of the pressure lines and the effective instantaneous pitch point are governed by a user defined function. This function describes the shape of the pitch lines. These pitch lines are the pitch circles of circular gears. Only one pitch line and a center distance need to be defined to generate both sides of the gear. Everything in the model described by Danieli is

driven by the definition of the pitch line of gear 1. Each pitch line definition is unique and will generate a unique gearset.

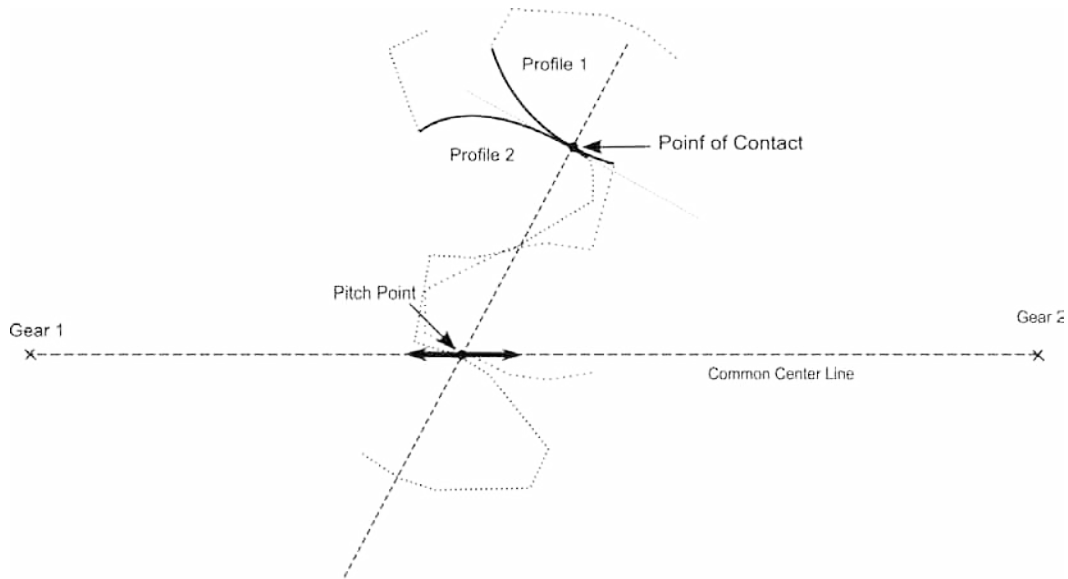

Figure 4-1: Overview concept of Danieli's Method with a moving pitch point

The method proposed by Danieli is very similar to the fundamentals of circular gear design. In his method the pressure angle is maintained to be a constant value, but the pitch point, translates side-to-side. This translation is what causes the change in gear ratio. In circular gears the pressure line is also held as a constant. However, the difference comes in the translation of the pressure lines. This translation of the pressure line causes the gear to instantaneously behave as a gearset of a particular size. This is similar to the theory proposed by Haupt in that the gearset is instantaneously a gearset of a specific size. This is a change to the Fundamental Law of Gearing, where instead of having fixed gear ratios, the ratio changes with the pitch lines and the translation of the pitch point. The translation also affects the interacting tooth profiles which need to be normal to the moving pressure lines.

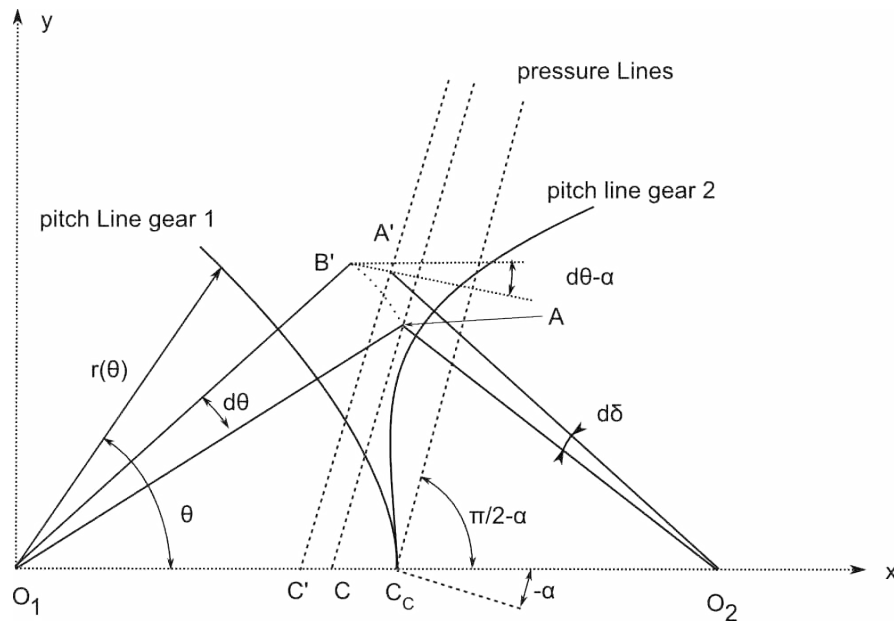

Figure 4-2: Pictorial description of the method proposed by Danieli.

The process of generating the profiles of the gear teeth is based on a differential equation that describes the relationship of the point of contact A, shown in Figure 4-2, and the next point of contact A'. Point A is a generic contact point between teeth as the teeth are rotated by the angle θ . It is located on the pressure line that crosses the Line of Centers at C. The normal to the pressure line is inclined by the angle $-\alpha$ from the horizontal. Point B' is the location of point A following an infinitesimal rotation $d\theta$ and by which A' has become the next contact point. A' is located by the pressure line starting from C' and the line extending from B' that is inclined by $d\theta - \alpha$ from the horizontal. The reason for the inclined line is that in order to have conjugate profiles the slope must always be perpendicular to the pressure line. The point C_c is the pitch point for the current tooth. The angle $d\delta$ is the angle between the point A and the next instantaneous point A' referenced from the center of Gear 2. This interaction between the points

is utilized as constraints to ensure that the generated profiles are conjugate while the pressure line and pitch point move. These constraints allow the Law of Conjugate Action to be fulfilled with the exception of the moving pressure line and pitch point, which are necessary to produce a ratio change between the two gears. This change to the Law of Conjugate Action also allows the gears to not have uniform rotary motion relative to one another.

In summary, Danieli proposes two principles and constraints for non-circular gear design. The first requires that the pitch lines of the two gears in the gearset be conjugates and that the point of intersection is along the line of centers. The second requires conjugate action on the teeth as they go through the mesh. The conjugate action on the teeth is driven by the position of the teeth and the slope to the next point, which is governed by the constraint that the slope has to be perpendicular to the pressure line at each instant.

4.2 Simulation Analysis

With the differential involute equations and the derived equation for a constant radius shown to be mathematically equivalent, a comparison was performed. This comparison serves two purposes. First, it provides another means of validating the mathematics of Danieli's Method and secondly, it ensures that the reproduction of the method is successful, since no supplied data by Danieli is available for comparison. Using the equations derived by Danieli, a circular gear tooth profile was generated and compared to an involute profile using an established method by Buckingham [04].

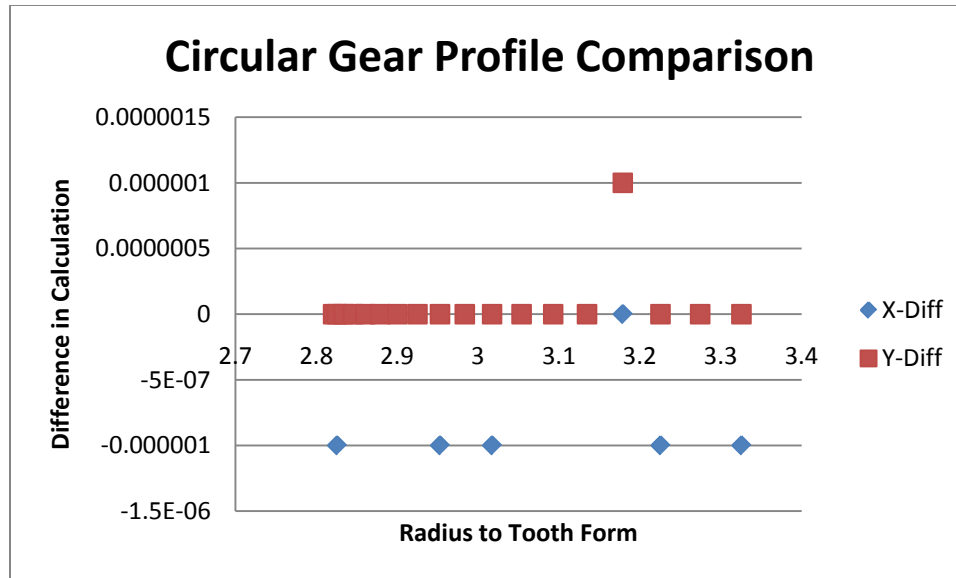

Figure 4-3: Difference in calculated values between Danieli and Buckingham methods.

As shown in Figure 4-3 there is a very small difference in the calculated values of the two methods. The resolution of the input data only had six significant figures and explains the boolean jump of a few of the data points. This comparison shows that both methods can produce involute gears. It also verifies that the method was implemented correctly in the generation of circular gears.

The next task is to generate matching profiles for a non-circular gearset. To accomplish this, we need to first define conjugate pitch circles. In the method outlined by Danieli, the construction of the first pitch line is left to the user. However, he does provide an example profile based on an anti-rotating slotted link mechanism. The geometry of this mechanism, shown in Figure 4-4, was used to define the pitch lines for the gearset shown in Figure 4-5. The results of this figure were generated using the derivation in Appendix A to generate the shapes and the profiles using the process described by Danieli 58[10].

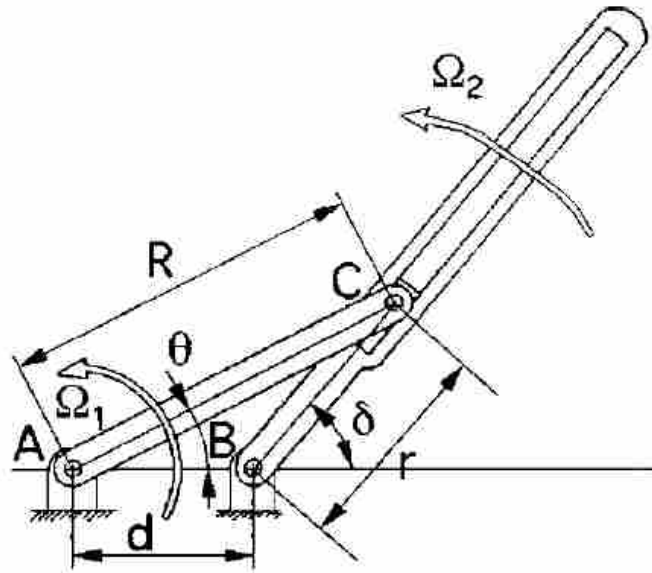

Figure 4-4: Anti-rotating slotted link mechanism for pitch line creation

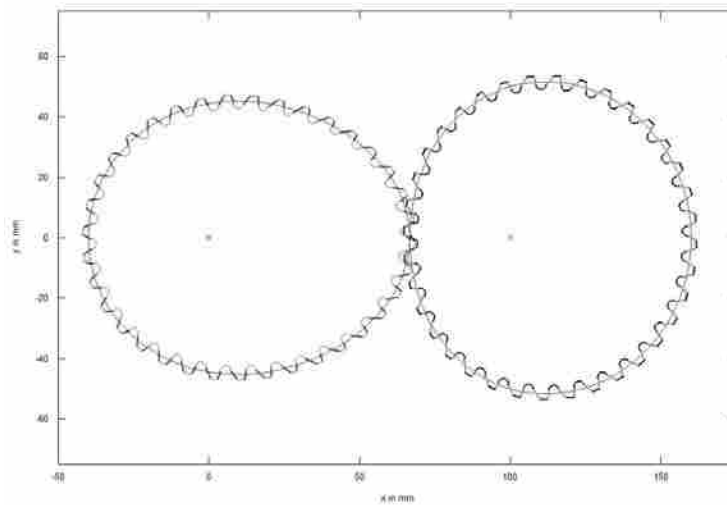

Figure 4-5: Teeth profiles produced during duplication of Danieli's method.

Since no standardized profile exists to compare the profiles for non-circular gears, a graphical approach was used. From the Law of Conjugate Action for circular gears, it is known

that the normals to the profiles must be collinear and angled at the pressure angle. The principles implied by Danieli's method require that the normals to the profile are inclined at the same pressure angle and contact along the line of action as shown in Figure 4-6. Also as previously mentioned, the line of action in the case of non-circular gears, is a curved line. These principles were used to measure and quantify the validity of Danieli's method.

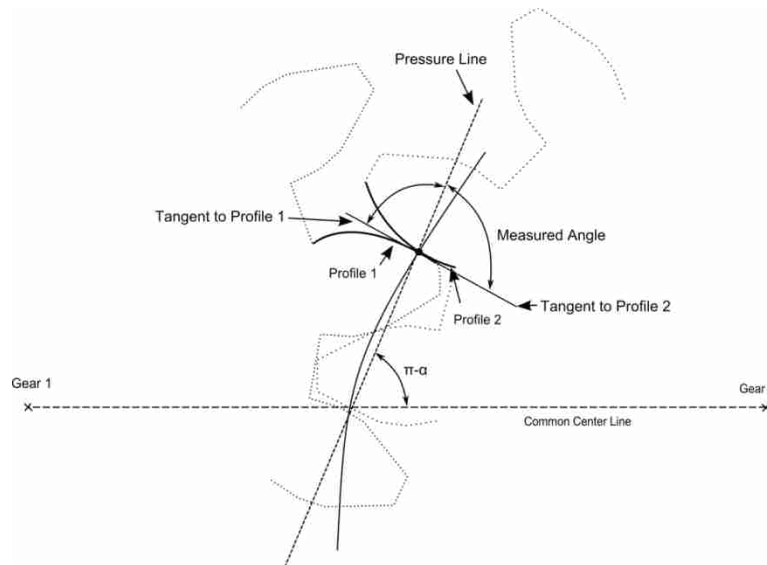

Figure 4-6: Graphical pressure angle measurement method.

This was done by looking at multiple points of contact as the profile goes through its mesh. Each point of contact is the intersection point, shown in Figure 4-6, where both profiles are tangent to each other and coincide with a point along the line of action. At these intersection points, the angles between the tangent lines of each profile and the pressure lines are measured. In order for the profiles to be conjugate the tangents to the profiles must always be perpendicular to the pressure line. These angles were measured and subtracted from the ideal, which would be 90 degrees, and the difference is plotted in Figure 4-7 for multiple points throughout the mesh.

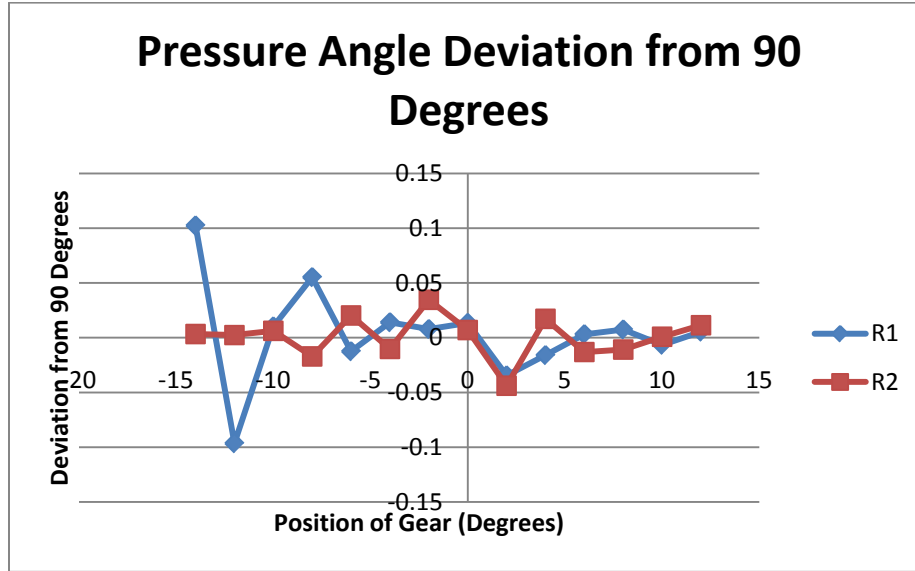

Figure 4-7: Pressure angle deviation on a Non-Circular Gear.

As shown in the figure, the majority of the points are less than 0.05 degrees off of the ideal, with a maximum deviation a little above 0.1 degrees from the ideal. This shows that the profiles are very close to the ideal and the deviation can be attributed to numerical approximation. The deviation that exists is of the same magnitude that was found when the angles on an involute profile were measured. It should be noted that the deviation is slightly larger than the deviation found for an involute profile, which is expected, since the curvature of the profile is also greater. The deviation also increases as the point of contact approaches the base circle, which is the same behavior that was present for involute profiles.

The deviation between Haupt's method and Danieli's method is vastly different. Haupt's method, through the course of the mesh, deviated from the ideal by 15 degrees, where Danieli's max deviation was a little over 0.1 degrees. Another point of note is the pattern of the deviation. Danieli's method has no identifiable pattern besides at the ends, which has been attributed to the

increase of curvature. Haupt's method, Figure 3-9 , has a definite increasing error that shows that the further from the initial point in the mesh, the error is increasing. This pattern shows that some behavior is not accounted for in Haupt's method, where Danieli's method shows no signs of behavior that is not accounted for.

4.3 Design of Gears Using Danieli's Method

The design of non-circular gears using Danieli's method is very similar to the design of circular gears. The parameters of gear design are utilized to specifically design the gearset to have the desired characteristics. There are no standards for non-circular gear design, since each profile is unique and must be matched to a specific profile to form a profile pair. This results in each gear and gearset being unique.

The pitch line is the first thing that needs to be defined for non-circular gears using Danieli's method. This pitch line, as has been mentioned, needs to be continuous and differentiable at every location. It also needs to have the same circumferential length as the mating gear. The desired ratio change and behavior needs to be designed into the pitch line. Concerns such as acceleration and jerk need to be addressed depending on the particular application and are similar to those of cam design.

Once the pitch line is defined, the actual teeth can then be designed. As with circular gears, there are some parameters that are used to define the shape and spacing of the teeth on the gear. These parameters are the pressure angle, circular pitch and number of teeth. The pressure angle for circular gears is a constant and defines the portion of the involute curve that is being used. This has the effect of making the shape of the tooth more steep or shallow just as in circular gears. Non-circular gears have profile pairs and although in this method the same

pressure angle is used it does not necessarily have to be the case. The pressure angle can be unique to each tooth pair that meshes together. The circular pitch and number of teeth are dependent on each other just like in circular gears. Choosing one specifies the other. In non-circular gears you still need an integer number of teeth and length of the pitch line needs to be evenly divisible by the circular pitch. This is necessary to create both sides of the teeth and insure that an integer number of teeth are present.

All three parameters must be chosen to ensure a sufficient contact ratio, or number of teeth that are in contact at a given time, is present. In circular gears the contact ratio is a constant and easily defined. For non-circular gears the contact ratio changes at every point. This is also complicated by the changing addendum and dedendum lengths. Since the pitch line is changing, the addendum and dedendum also vary for each tooth. The lengths of the addendum and dedendum need to be defined so that they properly mesh with the teeth of the other gear, which is the same requirement with circular gears. This is where some limitations of non-circular gears are present. If the transition from one ratio to another is too abrupt it might be difficult to maintain a high enough contact ratio also gouging due to the lengths of the addendum and dedendum will limit the possible ratio jump.

Manufacturing of the gears for initial testing can be done with a CNC mill or with a wire EDM machine. This will produce gears that have the desired shape, but will not have the desired properties on the profiles for wear characteristics and other concerns. This detail requires that a different manufacturing method, such as shaping, be developed and used to create the gears for production use.

4.4 **Danieli Method Conclusions**

The method proposed by Danieli is an analytical method that describes the interaction between consecutive contact points during an infinitesimal rotation of two gear teeth meshing with one another. This is a significant difference from Haupt's method where the interactions between consecutive points are not addressed. Haupt addresses only the points individually. Danieli's description takes into consideration the conjugate behavior of the profiles and the pitch lines. The method employs a user specified input function and its derivative, which are integrated over the mesh of the tooth defined by the line of action. These points are then mapped to a coordinate system that rotates with the gear to produce the gear tooth profiles. After this, the mating profile and mating pitch line are generated using the same initial set of points, creating a pair of mating profiles. The procedure can then be duplicated for all of the teeth on the gear to generate a full gear.

After the profiles were generated, an analysis was done to compare the mathematics and the theory. This was done by simulating the behavior of the profiles as they go through their mesh. At discrete points along the way their behavior was compared to the theoretical behavior by measuring the angles with which the profiles contacted each other to ensure that conjugate action was preserved. The results of this analysis showed that the deviation was slightly larger than the deviation of involute gears, but was of the same order of magnitude. This increase in the error is attributed to the increase in curvature of the profiles which is more difficult to approximate. With these results it is shown that Danieli's method is capable of producing a varying output from a constant input and has the required principles of conjugate pitch lines and conjugate profiles for non-circular gear design.

These principles, proposed by Danieli, are very similar to those of circular gear design. Danieli's use of conjugate pitch lines is similar to the Fundamental Law of gearing, where the pitch circles are conjugate. The only difference being that the pitch lines have varying radii, which is required to produce a non-uniform output. This is also an area of difference from Haupt's method where discrete points and pitch circles were constrained to have conjugate pitch circles, but the area between these points was not constrained to have conjugate pitch circles.

Danieli's derivation of the interaction of the contact point is similar to the Law of Conjugate Action. He specifically addresses the profiles being conjugate and also the interaction from one point to the next over an infinitesimal rotation. This method of describing the points ensures that the profiles are conjugate with each other. Haupt does not specifically ensure that the profiles are conjugate with each other, but instead uses the path of contact (which has been nullified) to show that they have the correct pressure angle and thus, conjugates of each other. Danieli's method also produced a pitch line in the case of non-circular gears that is a curved line as compared to a straight line for involute gears. However, this curved line still allows the pressure angle at the contact point to be a constant value.

These principles of circular gear design are modified just enough to give the necessary freedom for a non-circular gear to be produced. With the method proposed by Danieli being validated we now have an understanding of the principles that govern non-circular gear design and a pathway to creating a Positively Engaged Piecewise Continuous Transmission (PEPCT).

5 PEPCT EMBODIMENTS

Thus far through this thesis, we have shown the work that has been done to develop a Positively Engaged Continuously Variable Transmission. We have also shown the inherent problems with transmissions of this type, namely the Non-Integer Tooth Problem, and have introduced the idea that a non-circular gear could be utilized to overcome the inherent problem. Two types of non-circular gears were analyzed on their functionality. The concept proposed by Haupt consisted of a non-circular gear meshing with a circular gear. This concept was shown to be incomplete and would need further development to determine if it is indeed a viable option. The second type of non-circular gears that were analyzed consisted of fixed center distances and a differential approach to define tooth profiles. This method was shown to produce non-circular gears that meshed properly and were thus able to transmit rotary motion from one gearset to another with a varying ratio. With the behavior of this gear verified, the next step is to show it in a gear train embodiment. This chapter shows how a gearset could be designed and used in an embodiment that overcomes the Non-Integer Tooth Problem and produces a changing ratio output from a constant input.

5.1 Embodiment Concept

The embodiment is termed a Positively Engaged Piecewise Continuous Transmission due to its piecewise continuous nature. The embodiment can continuously transition between ratios

but must come to rest at specific ratios. The concept is diagrammed in Figure 5-1 and consists of an input step-down gear, non-circular gearsets and three drive shafts with multiple gearsets. The operation of this transmission is that the non-circular gearset will accelerate the output until the next ratio can be engaged. This is accomplished by three shafts where shaft 2 is a duplicate of shaft 1 and is used as the transition shaft for the changing of ratios as diagrammed in Figure 5-1. The first ratio goes through the step-down gear to shaft 1, then through the first gearset and out the output shaft. When a transition to the next ratio is desired, the non-circular gearset is engaged and the first ratio gearset on shaft 1 is disengaged. The torque path then follows the path labeled as the “transition path” which goes from the step-down, through the non-circular gearset and into the corresponding ratio of gears from shaft 2 to the output. As the input turns, shaft 2 is

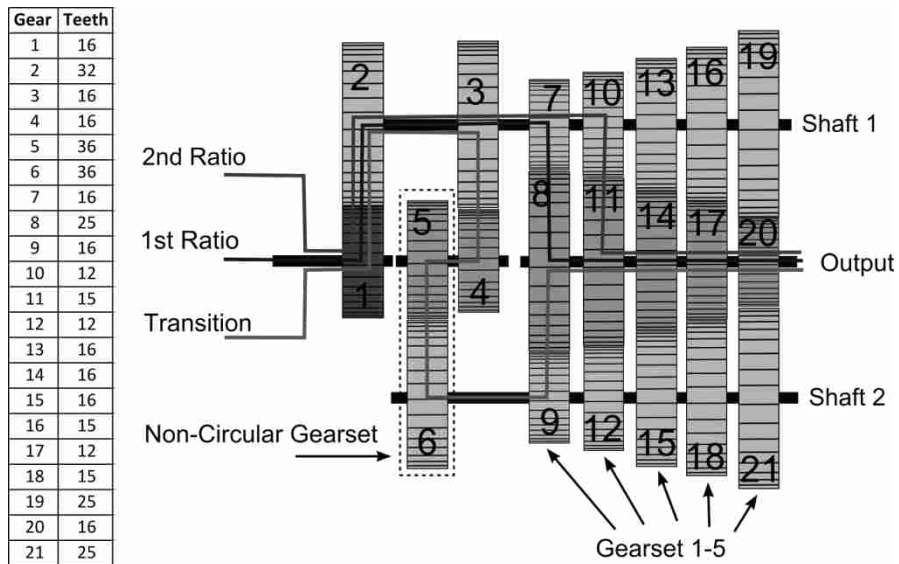

Figure 5-1: PEPCT embodiment using Non-Circular Gearsets.

accelerated to the second ratio on shaft 1. At this point the transition has ended and the torque path would shift to the path labeled 2nd ratio, bypassing the non-circular gearset and going

through the second gear on shaft 1 and out through the output shaft. This pattern would then be repeated when the shift to the next ratio is desired. Down-shifting occurs by the same mechanism, only in reverse.

The ratios of the gearsets in the transmission are designed to utilize the non-circular gears to transition from one ratio to the next. Since the non-circular gears have a fixed shape, and because no mechanism is employed to vary the length of their affect, the transition between ratios has to have a fixed rotation span. This narrows the design space for the gearsets as the gears must obey the relationships between their diameters, teeth number, diametral pitch and radii. These parameters for the embodiment in Figure 5-1 are shown in Table 3. The center distance between the shafts must be constant and is the sum of the radii of shaft 1 and the output shaft. Shaft 1 and shaft 2 are identical in their gearsets and the Diametral Pitch is constant over a particular gearset but varies between sets and requires customized gears. The train value of the gearset is shown and varies by the ratio of the non-circular gears which is a ratio of 1.25:1.

Table 3: Gearset layout for PEPCT embodiment.

		Gear Set				
		1	2	3	4	5
Diametral Pitch		3.417	2.25	2.667	2.25	3.417
Shaft 1	Teeth	16	12	16	15	25
	Radius (in)	2.341	2.667	3	3.333	3.659
Output	Teeth	25	15	16	12	16
	Radius (in)	3.659	3.333	3	2.667	2.341
Shaft 2	Teeth	16	12	16	15	25
	Radius (in)	2.341	2.667	3	3.333	3.659
Center Distance (in)		6	6	6	6	6
Train Value		1.563	1.25	1	0.8	0.64

With the gearsets defined the output rpm can be defined as a ratio of the input and the piecewise function for the overall speed. This concept is diagrammed in Figure 5-2. Given a

constant input, the various shown speeds are attainable. The dotted line in Figure 5-2 between the specific ratios represents a conceptual path supplied by the non-circular transition gears. It should be noted that other speeds are attainable, but the input from the engine would have to be varied in order to accomplish those speeds.

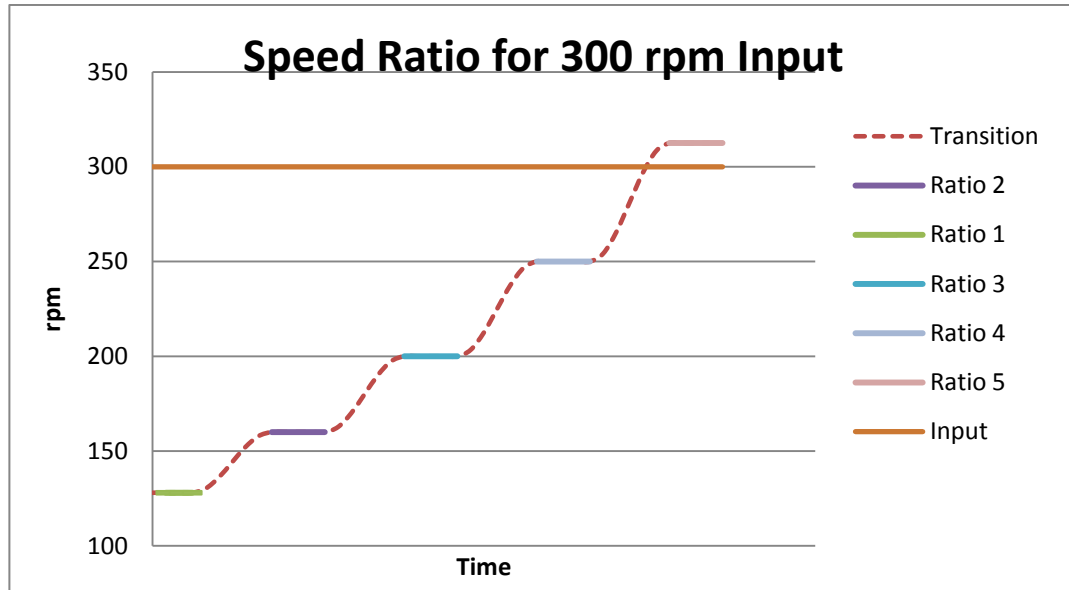

Figure 5-2: Speed ratio output for a piecewise continuous transmission.

5.2 Non-Circular Gearset Design

The transition between the gearsets is made possible by employing a non-circular gearset. The non-circular gearset consists of two gears. The pitch line for Gear 1 is described by a simple sinusoidal equation defined by Equation (5-1). The pitch lines have the same form mentioned in the work done by Danieli [10]. These pitch lines are specifically designed to span the ratio of 1.25:1, which is the ratio between the operating gearsets of the transmission. The ratio of these gears is described by the major and minor diameters at the initial and mid rotation positions respectively. These gears transition from the minor diameter to the major diameter during each

rotation. During this transition is important to look at the kinematic behavior of the gears. With the profiles defined the angular velocity, acceleration and jerk can be calculated and are shown in Figure 5-3. These functions are continuous and sinusoidal since the velocity profile is sinusoidal. Their magnitudes are quite reasonable but are highly dependent on the input angular speed.

$$R_1 = 2.99535 - .167 \cos(\theta) \quad (5-1)$$

The pitch line definition for Gear 1 follows the constraints given by Danieli that the function R_1 must be continually differentiable and that $dR_1/d\theta$ is also known. The pitch line for Gear 2 is defined by subtracting the pitch line of Gear 1 from the center spacing Δr . The full derivation of this process is shown in Appendix B.

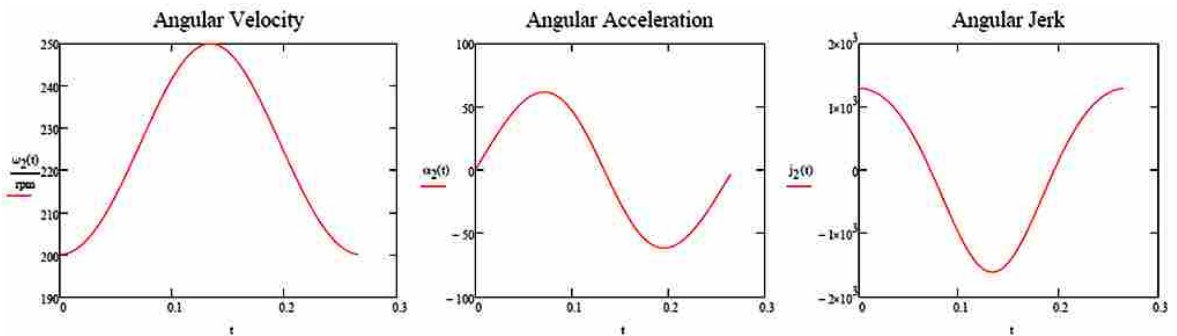

Figure 5-3: Angular Velocity, Acceleration and Jerk for the non-circular gearset.

With the pitch lines defined for both the gears, Danieli’s method is then used to define the tooth profiles that are required to match the varying diameter of the pitch lines. The resulting pitch lines and tooth profiles are shown in Figure 5-4: Non-circular gear diagram for PECVT embodiment. Figure 5-4. The gears are shown with 36 teeth and a pressure angle of 26 degrees.

The tooth count and pressure angle have been arbitrarily chosen at this stage and are parameters that would be determined after a stress analysis has been performed on the resulting gearset.

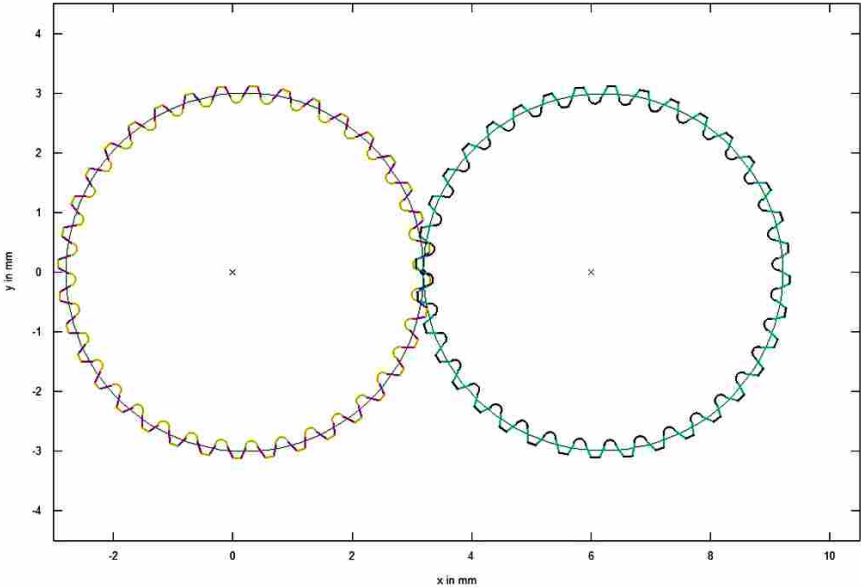

Figure 5-4: Non-circular gear diagram for PECVT embodiment.

5.3 Pitch Line Modification

So far, we have only considered a position and velocity analysis of the non-circular gearsets using a sinusoidal input. Since Danieli’s method has the ability to generate profiles from any continuous function, the behavior of the gear can be manipulated by modifying the pitch lines. One such modification that could be investigated is adjusting the curve used in generating the non-circular gear to allow a smoother transition between engaging gearsets. This modified curve is similar to the design of cams where piecewise continuous functions can be defined to produce prescribed behavior and avoid excessive vibrations and other dynamic issues. This concept is diagrammed in Figure 5-5.

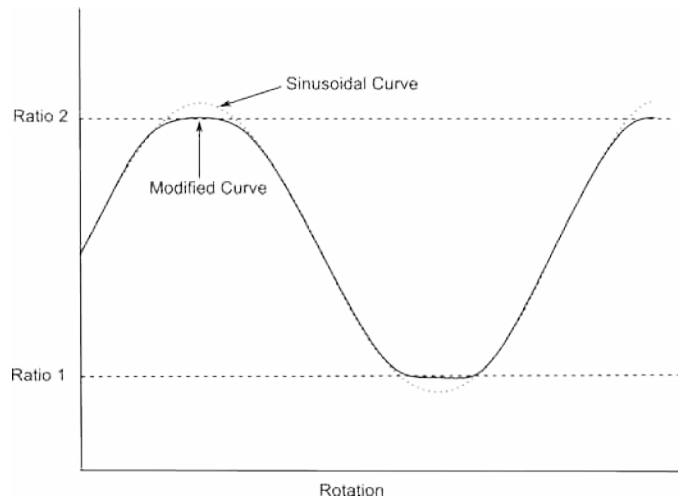

Figure 5-5: Transition region for a non-circular gearset.

The pitch line mentioned is a modified curve designed to have flattened caps, when compared to a sinusoidal curve, to enable the transition to be more seamless and minimize the dynamic problems due to engaging gears. The dynamics of non-circular gear design are similar to cam profile design. Cam profiles generate motion through two cams acting against each other or a cam and a follower of some type. In their design, acceleration and jerk must be finite in order to eliminate significant vibration and wear. Non-circular gears can be thought of as two cams acting on each other with teeth to transfer rotary motion. Thus, the dynamics of their operation would be similar and the same strategies could be employed to design their desired functions.

5.4 Embodiment Limitations

The embodiment presented in this thesis has been shown to overcome the Non-Integer Tooth Problem, but it has done so at some expense. The use of the non-circular gearset makes the transition from one gearset to the next gearset in half of a revolution of the non-circular

gearset. This limits the transmission to small speed ranges because of the dynamics of a rapid acceleration. Since the transition happens over a short time a high acceleration is required to move the mass of the other shaft and gears, and jerk becomes an issue. The torque through the system would also spike causing unwanted vibration and stresses. The accelerations and torque spikes can be mitigated by varying the input speed that is supplied to the transmission. This would allow the shift to be smoother as the transition occurs, but would still be limited by the speed at which the transition would occur.

Another limitation is the ability to actuate the rapid shifting that would need to occur. Since the non-circular gearset and the operating gearsets are switched quickly, high speed actuators would be needed to enable this to happen.

For these reasons the transmission embodiment presented is limited to low speed applications, which have limited utility. An embodiment design that has a broader dynamic range and the ability to transition between ratios that are very closely spaced would be desirable and should be the focus of future research. This future research should investigate utilizing mechanisms such as differentials, planetary gear trains combined with non-circular gears to allow the transition between ratios to be smoother with less acceleration and torque spike problems. The practical embodiment of a Positively Engaged Piecewise Continuous Transmission for high speed applications depends on the ability to overcome these limitations.

6 CONCLUSIONS

The development of a Positively Engaged Continuously Variable Transmission (PECVT) has been underway at Brigham Young University for some time. Throughout this research effort, many advances have been made to facilitate the feasibility of developing such a transmission. This thesis has summarized the research efforts to date and has described a method to develop a Positively Engage Piecewise Continuous Transmission (PEPCT).

Danieli and Haupt's concepts were selected for this thesis as two different analytical approaches to generate possible gearsets that would produce a varying output from a constant input. Haupt's method uses a ring and pinion setup with a changing center distance, where the ring has a standard involute profile. However, evaluation of Haupt's concept shows that it is incomplete and the pressure angle deviates from its proposed value causing velocity disturbances in the output. Haupt's concept would need to be completed before it could be used as a viable method to produce non-circular gears.

The concept proposed by Danieli uses a fixed center distance and the definition of a single pitch line as the driving function for his method. His method is based on describing the relationship between consecutive points on an infinitesimal level and then integrating them over the mesh of the gear to produce the desired gearset. This method is very concise and directly addresses the constraints of conjugate action and the deviation from the Fundamental Law of Gearing. Danieli's method agrees in both theory and practice, and according to simulated results, has conjugate action between gear teeth.

Utilizing the method developed by Danieli an embodiment of a Positively Engaged Piecewise Continuously Variable Transmission (PEPCT) was conceived. This was accomplished by generating gearsets that produce a varying output from a constant input. These gearsets are capable of producing a ratio change between gears in constant mesh with one another that enables the possible solution of a PEPCT, proposed by Haupt, to be realized. With this approach, the mentioned embodiment was able to overcome the Non-Integer Tooth problem by utilizing non-circular gearsets to transition between fixed operating gearsets. This transition is constrained to be a fixed ratio change by the definition of the non-circular gears and since no device was employed to vary the length of the transition. The fixed transition significantly narrows the design space for the stepping gearsets and is limited to a small ratio span. The non-circular gearset was defined by a simple sinusoidal function and the ratio span determined by the initial and mid-rotation ratios. This is because the cyclic operation of the gearset requires the initial and final ratios to be the same.

However, this proposed concept embodiment has some limitations. Since the ratio change happens over only half of a revolution of the input shaft, the applications of this particular embodiment are limited to low speed applications. This is also compounded by the rapid shifting that must occur and the ability of the actuator to accomplish this in a short time frame.

This embodiment has lead to understanding in the area of Positively Engaged Continuously Variable Transmissions (PECVT). In order for a high speed application to be realized, the speed at which the transition needs to occur would have to be augmented so that the torque and acceleration could be manageable and not cause excessive stress and vibration. Different configurations, or concepts, would need to be developed in order for this to occur. Some of these configurations might include utilizing the non-circular gearset to transition

between existing gearsets or utilizing the non-circular gearset in a planetary or differential combination. The addition of a planetary or differential combination into the system layout allows for various other possible conceptual embodiments that overcome the Non-Integer Tooth Problem and may lead to a viable PECVT.

It is recommended that these and other embodiments be investigated now that the feasibility of at least one conceptual embodiment that utilizes non-circular gears has been validated analytically. It is also recommended that the approach derived by Danieli be utilized to analyze the behavior of non-circular gears and perform engineering analysis in the areas of impact loading, stress, fatigue and other considerations pertinent to the design of gearsets that would be important in an embodiment of a Positively Engaged Continuously Variable or Piecewise Continuously Variable Transmission.

REFERENCES

- [01] Anderson, B. S. “An Investigation of a Positive Engagement Continuously Variable Transmission”. Department of Mechanical Engineering, Brigham young University. Provo: Brigham Young University, 2007.
- [02] Bair, B.W. “Computer Aided Design of Elliptical Gears”, *ASME Journal of Mechanical Design*. 124 (2002) 787–793.
- [03] Buckingham, E. Analytical Mechanics of Gears. New York : McGraw Hill, 1949.
- [04] Buckingham, E. ; Buckingham, E. K. Revised Manual of Gear Design. New York : Industrial Press, 1981. 0831131160.
- [05] Chang, S. L., et al, “Mathematical Model and Undercutting Analysis of Elliptical Gears Generated by Rack Cutters”, *Mechanism and Machine Theory* 31 (1996) 879-890.
- [06] Chang, S. L. et al,” Computerized Tooth Profile Generation and Undercut Analysis of Noncircular Gears Manufactured with Shaper Cutters”, *Journal of Mechanical Design*, ASME Transactions 120 (1998) 92–99.
- [07] Choupani, N., Babaei, A., ‘Velocity and Acceleration Simulation of a Vehicle with a Continuously Variable Power Split Transmission” *World Academy of Science, Engineering and Technology* 55 (2009) 399-404.
- [08] Cunningham, F. W., and Cunningham, D. S., "Rediscovering the Noncircular Gear," *Machine Design*, Nov. 1, 1973, pp. 79-86.
- [09] Dalling, R. R. *An Investigation of a Positive Engagement Continuously Variable Transmission*. Department of Mechanical Engineering, Brigham young University. Provo: Brigham Young University, 2008.
- [10] Danieli, G. A. “Analytical Description of Meshing of Constant Pressure Angle Teeth Profiles on a Variable Radius Gear and its Applications”, *Journal of Mechanical Design*, 122 (2000) 123-129.

- [11] Haupt, B. L. A Conceptual Design and Analysis of a Positively Engaged Continuously Variable Transmission. Department of Mechanical Engineering, Brigham young University. Provo : Brigham Young University, 2008.
- [12] Kapelevich, A., “Direct Design of Asymmetric Gears: Approach and Application” *JSME International Conference on Motion and Power Transmissions GDS-17(2009)*
- [13] Komori, N., et al; “A New Gears Profile Having Zero Relative Curvature at Many Contact Points (LogiX Tooth Profile)” *Journal of Mechanical Design* 112 (1990) 430-436.
- [14] Litvin, F.L., et al. “Design and Investigation of Gear Drives with Non-Circular Gears Applied for Speed Variation and Generation of Functions” *Computational Methods Applied Mechanical Engineering* 197 (2008) 3783-3802.
- [15] Mitome, L., Ishida. K., “Eccentric Gearing”, “Proceedings of the Mechanisms Conference and International Symposium Gearing and Transmissions” Vol 1 ASME publications. San Francisco, CA. October 8-12, 1972, p.57.
- [16] Mundo, D. “Geometric Design of a Planetary Gear Train with Non-Circular Gears” *Mechanism and Machine Theory* 41 (2006) 456-472.
- [17] Nissan. [Online] [Cited: December 15, 2009.] <http://www.nissan-global.com/EN/TECHNOLOGY/INTRODUCTION/DETAILS/CVT/>
- [18] Norton, R. L. Design of Machinery 4th Edition. New York : McGraw Hill, 2008. 9780073121581.
- [19] Ottaviano; Ceccarelli et al. “Numerical and Experimental Analysis of Non-Circular Gears and Cam-Follower System as Function Generators”. *Mechanism and Machine Theory* 43 (2008) 996-1008.
- [20] Pahl, G., et al. Engineering Design a Systematic Approach 3rd Edition. London : Springer, 2007. 9781846283185.
- [21] Riaza, H; Nebot, S. “Study of the Base Curve and Formation of Singular Points on the Tooth Profile of Noncircular Gears” *Journal of Mechanical Design* 129 (2007) 538-545.
- [22] Subaru. [Online] [Cited: December 15, 2009] http://www.drive.subaru.com/Sum09/Sum09_whatmakes.htm
- [23] Tong, S., Yang, D., “Generation of Identical Noncircular Pitch Curves” *Journal of Mechanical Design* 120 (1998) 337-341.

- [24] Zhang, W. J., Guo, L. S., “Kinematic Analysis of a Rice Transplanting Mechanism with Eccentric Planetary Gear Trains”, *Mechanism and Machine Theory* 36 (2001) 1175-1188.

APPENDIX A – DUPLICATION OF PITCH LINES FOR DANIELI'S METHOD

Input Parameters

$\lambda := .5$	Ratio from Slotted Link
$\Delta r := 100$	Center Distance
$T_n := 1$	Period of Rotation
$t := 0, .01 \dots T_p$	Time of one rotation

Method Derivation

$\omega_1 := 2 \frac{\pi}{T_p}$	Angular Velocity of Gear 1
$\theta_1(t) := \frac{2 \cdot \pi}{T_p} \cdot t$	Angle of Gear 1
$\tau(t) := \frac{1 - \lambda \cdot \cos(\theta_1(t))}{1 + \lambda^2 - 2 \cdot \lambda \cdot \cos(\theta_1(t))}$	Transmission Ratio
$R_1(t) := \frac{\tau(t) \cdot \Delta r}{(1 + \tau(t))}$	Radius of Gear 1
$R_2(t) := \Delta r - R_1(t)$	Radius of Gear 2
$\omega_2(t) := \omega_1 \cdot \tau(t)$	Angular Velocity of Gear 2
$\delta_2(t) := \pi + \int_0^t \omega_2(t) dt$	Angle of Gear 2

X and Y Coordinates

$R_{1,x}(t) := R_1(t) \cdot \cos(\theta_1(t))$	X - Coordinate of Gear 1	$R_{2,x}(t) := -R_2(t) \cdot \cos(\delta_2(t))$	X - Coordinate of Gear 2
$R_{1,y}(t) := R_1(t) \cdot \sin(\theta_1(t))$	Y - Coordinate of Gear 1	$R_{2,y}(t) := -R_2(t) \cdot \sin(\delta_2(t))$	Y - Coordinate of Gear 2
$C_{1,x} := 0$ $C_{1,y} := 0$	Center of Gear 1	$C_{2,x} := \Delta r$ $C_{2,y} := 0$	Center of Gear 2

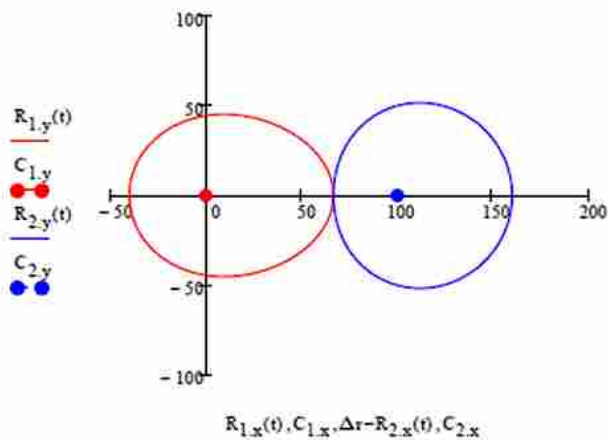

APPENDIX B – PITCH LINE DERIVATION FOR PEPCT EMBODIMENT

Input Parameters

$r := 2.99535 \text{ in}$	Base Radius	$T_p := .267528 \text{ s}$	Period of Rotation
$\lambda := .167 \text{ in}$	Eccentricity	$t := 0 \text{ s} \dots .001 \text{ s} \dots T_p$	Time of one rotation
$\Delta r := 6 \text{ in}$	Center Distance		

Method Derivation

$\omega_1 := 2 \frac{\pi}{T_p}$	Angular Velocity of Gear 1	$\omega_1 = 224.276 \text{ rpm}$
$\theta_1(t) := \frac{2\pi}{T_p} t$	Angle of Gear 1	$\theta_1 \left(\frac{T_p}{2} \right) = 180 \text{ deg}$
$R_1(t) := r - \lambda \cos(\theta_1(t))$	Radius of Gear 1	$R_1 \left(\frac{T_p}{2} \right) = 3.162 \text{ in}$
$R_2(t) := \Delta r - R_1(t)$	Radius of Gear 2	$R_2 \left(\frac{T_p}{2} \right) = 2.838 \text{ in}$
$\tau(t) := \frac{R_1(t)}{R_2(t)}$	Transmission Ratio	$\tau \left(\frac{T_p}{2} \right) = 1.114$
$\omega_2(t) := \omega_1 \tau(t)$	Angular Velocity of Gear 2	$\omega_2 \left(\frac{T_p}{2} \right) = 249.938 \text{ rpm}$
$\delta_2(t) := \pi + \int_0^t \omega_2(t) dt$	Angle of Gear 2	$\delta_2 \left(\frac{T_p}{2} \right) = 359.999 \text{ deg}$

X and Y Coordinates

$R_{1,x}(t) := R_1(t) \cdot \cos(\theta_1(t))$	X - Coordinate of Gear 1	$R_{2,x}(t) := -R_2(t) \cdot \cos(\delta_2(t))$	X - Coordinate of Gear 2
$R_{1,y}(t) := R_1(t) \cdot \sin(\theta_1(t))$	Y - Coordinate of Gear 1	$R_{2,y}(t) := -R_2(t) \cdot \sin(\delta_2(t))$	Y - Coordinate of Gear 2
$C_{1,x} := 0 \quad C_{1,y} := 0$	Center of Gear 1	$C_{2,x} := \Delta r \quad C_{2,y} := 0$	Center of Gear 2

